

**This electronic collection of documents is provided
for the convenience of the user
and is Not a Certified Document –**

**The documents contained herein were originally issued
and sealed by the individuals whose names and license
numbers appear on each page, on the dates appearing
with their signature on that page.**

**This file or an individual page
shall not be considered a certified document.**

TIP PROJECT: R-2915B

CONTRACT: C203593

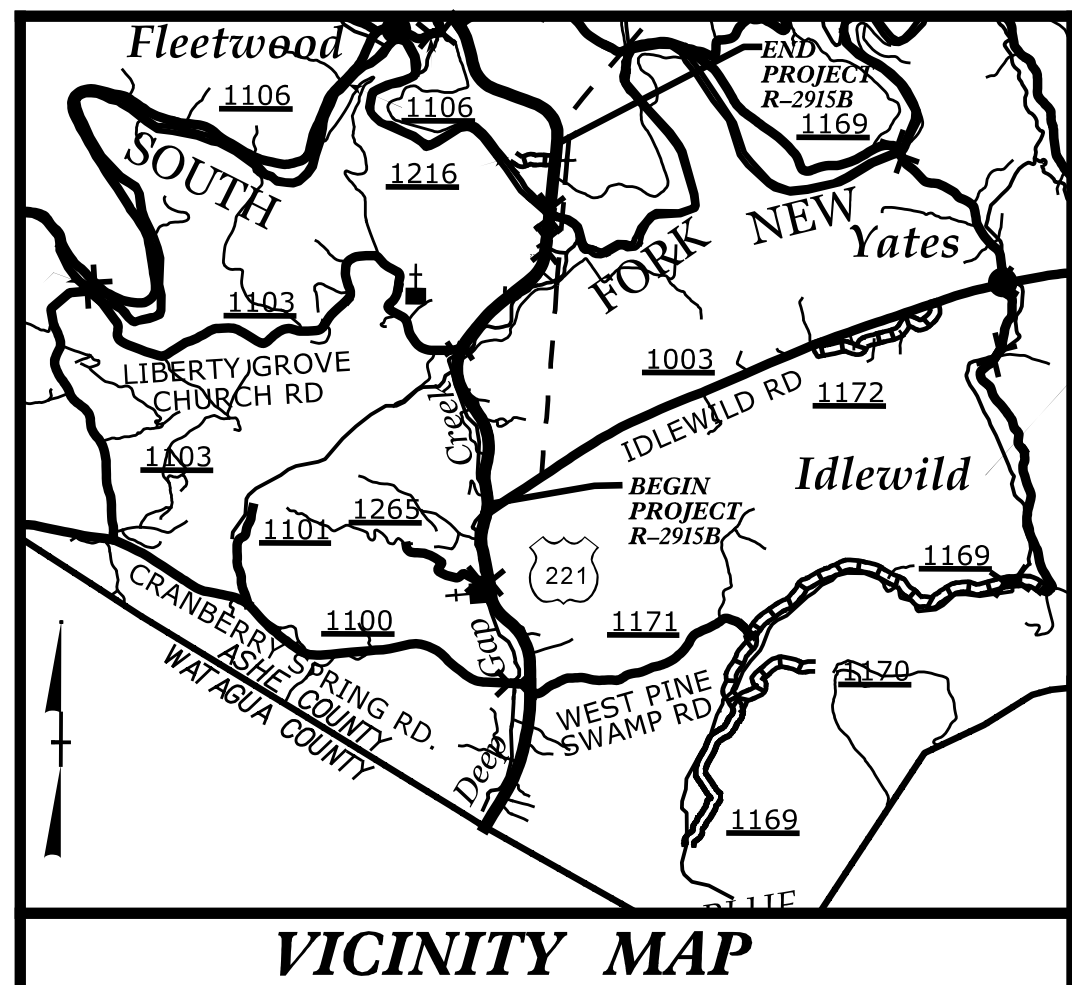

**STATE OF NORTH CAROLINA
DEPARTMENT OF TRANSPORTATION**

**SIGNING PLAN
ASHE COUNTY**

LOCATION: US 221 FROM SR 1003 (IDLEWILD RD) TO NORTH OF SOUTH FORK NEW RIVER

TIP NO. R-2915B	SHEET NO. SIGN-1
APPROVED: <i>Joseph Kopaskie</i> <small>9C0EAEF8A84FA...</small>	
DATE: 5/27/2015	

NAD 83 / CORS

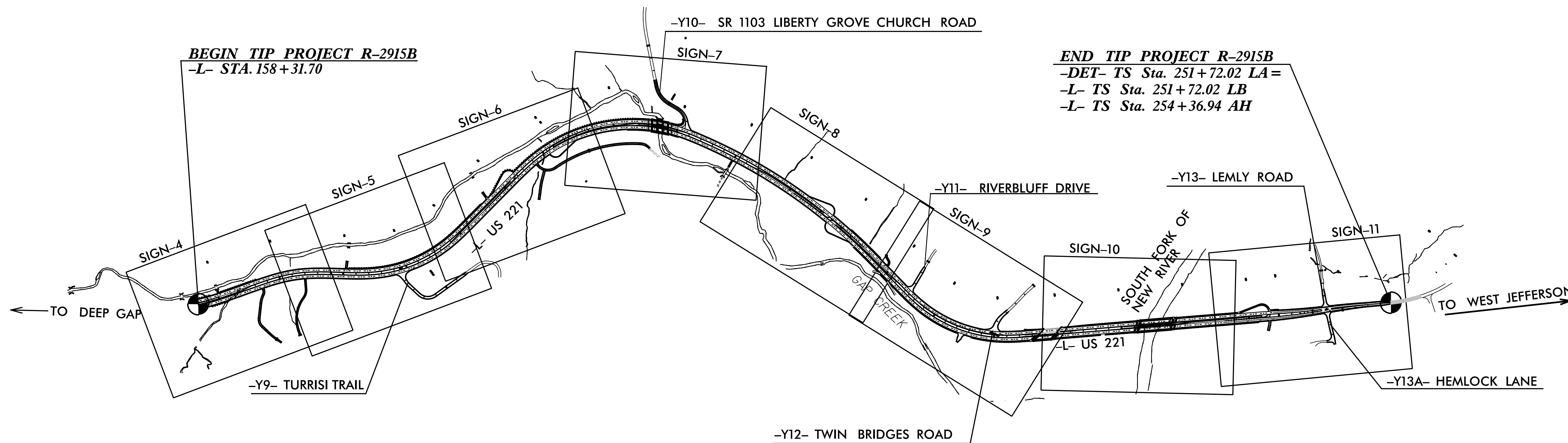

SEPI
ENGINEERING &
CONSTRUCTION

1025 Wade Avenue
Raleigh, NC 27605
Tel: 919-789-9977
Fax: 919-789-9591
License: C-2197

PLAN PREPARED BY: SEPI ENGINEERING & CONSTRUCTION	
<u>JOSEPH B. KOPASKIE, PE</u>	SIGNING & DELINEATION PROJECT ENGINEER
<u>RICHARD DRAYTON</u>	SIGNING & DELINEATION PROJECT DESIGN ENGINEER

NCDOT CONTACTS:	
<u>KELVIN L. JORDAN</u>	SIGNING & DELINEATION REGIONAL ENGINEER
<u>DERRICK H. BEARD</u>	SIGNING & DELINEATION PROJECT DESIGN ENGINEER

INDEX	
SHEET NO.	DESCRIPTION
SIGN-1-1A	TITLE SHEET, NOTES, QUANTITIES AND SPECIFICATIONS
SIGN-2 & 2A	E & F
SIGN-3	SIGN DESIGN
SIGN-4-11	R-2915B EXISTING & PROPOSED SIGN DETAIL SHEETS

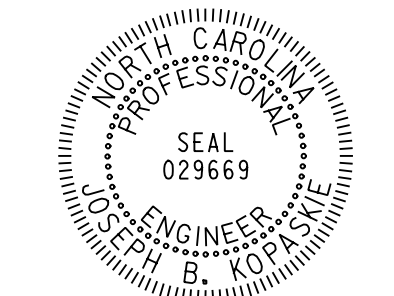
TIP NO.	SHEET NO.
R - 2915B	SIGN - 1A
Approved by: <u>Joseph Kopasnik</u> <small>—S000EA9F8A64FA—</small>	
DATE: 5/27/2015	
SEAL	
	

ROADWAY STANDARD DRAWING

THE FOLLOWING ROADWAY STANDARDS AS APPEAR IN "ROADWAY STANDARD DRAWINGS" - PROJECT SERVICES UNIT - N.C. DEPARTMENT OF TRANSPORTATION - RALEIGH, N.C., DATED JANUARY 2012 ARE APPLICABLE TO THIS PROJECT AND BY REFERENCE HEREBY ARE CONSIDERED A PART OF THESE PLANS:

STD. NO.	TITLE
904.10	ORIENTATION OF GROUND MOUNTED SIGNS
904.50	MOUNTING OF TYPE 'D', 'E' AND 'F' SIGNS ON 'U' CHANNEL POSTS

PROJECT NOTES

1. DISPOSAL OF SIGN SYSTEM, U-CHANNEL
2. SIGN ERECTION, RELOCATE SIGN TYPE E
3. DISPOSAL OF SUPPORT, U-CHANNEL

SUMMARY OF QUANTITIES

ITEM NO.		ITEM DESCRIPTION	QUANTITY	UNIT
DESC. NO.	SECT. NO.			
4072000000	903	SUPPORTS, 3 LB STEEL U-CHANNEL	1392	L.F.
4096000000	904	SIGN ERECTION, TYPE D	2	EA.
4102000000	904	SIGN ERECTION, TYPE E	53	EA.
4108000000	904	SIGN ERECTION, TYPE F	12	EA.
4116100000	904	SIGN ERECTION, RELOCATE SIGN TYPE E	2	EA.
4155000000	907	DISPOSAL OF SIGN SYSTEM, U-CHANNEL	17	EA.
4192000000	907	DISPOSAL OF SUPPORT, U-CHANNEL	1	EA.

GENERAL NOTES

- . SIGNS FURNISHED BY STATE
- . ALL TYPE 'D' SIGNS SHALL BE MOUNTED ON TWO U-CHANNEL POSTS UNLESS OTHERWISE INDICATED ON THE PLANS.
- . IF REMOVAL OR RELOCATION OF SIGNS ON PRIVATE STREET (NON-STATE MAINTAINED) IS REQUIRED DUE TO CONSTRUCTION, THE CONTRACTOR SHALL INFORM THE ENGINEER. THE WORK WILL BE COMPLETED BY OTHERS.
- . WHEN NOT STATIONED OR DIMENSIONED ON PLANS, ALL 'E' AND 'F' SIGNS SHALL BE FIELD LOCATED BY THE ENGINEER
- . ALL EXISTING SIGNS ON "U" CHANNEL POST WITHIN THE PROJECT LIMITS SHALL BE REMOVED AND DISPOSED OF UNLESS OTHERWISE NOTED ON PLANS.
- . WHEN EXISTING SIGNS ARE REMOVED AND INSTALLED ON NEW SUPPORTS, THE RE-ERECTION SHALL IMMEDIATELY FOLLOW THE REMOVAL.
- . THE BACKGROUND FOR TYPE E & F SIGNS SHALL BE GRADE C REFLECTIVE SHEETING.
- . SEE ROADWAY PLANS FOR GUARD/GUIDE RAIL DETAILS.

5/13/2015 8:11:12 AM C:\Users\jwiles\Documents\Transportation\TR13.017.00 NCDOT 2012 Traffic LSA\TR13.017.07 (R-2915B Signing & PMP)\Signing\Engseed 6-11-12.dgn

TIP NO. R-2915B	SHEET NO. SIGN-2
APPROVED: <i>Joseph Kopaschie</i> <small>—SCDREAEF80A54FA—</small>	
DATE: 5/27/2015	
SEAL 	

401 QUANTITY REQ'D ..2..

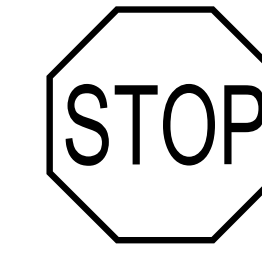

36 X 36
R1-1

ONE "U" POST PER SIGN

407 QUANTITY REQ'D ..5..

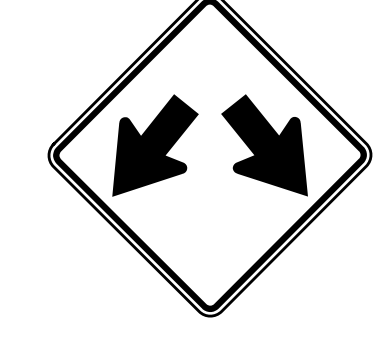

36 X 36
W12-1

ONE "U" POST PER SIGN

413 QUANTITY REQ'D ..1..

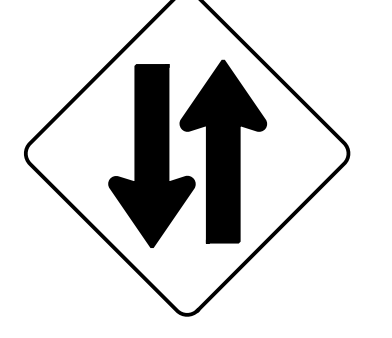

48 X 48
W6-3

TWO "U" POSTS PER SIGN

418 QUANTITY REQ'D ..9..



36 X 36
R5-1

ONE "U" POST PER SIGN

402 QUANTITY REQ'D ..4..

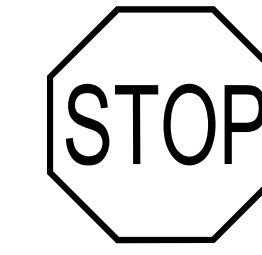

36 X 36
R1-1

TWO "U" POST PER SIGN

408 QUANTITY REQ'D ..5..



54 X 18
R6-1(L)

TWO "U" POSTS PER SIGN

414 QUANTITY REQ'D ..2..



36 X 48
R2-1

TWO "U" POSTS PER SIGN

419 QUANTITY REQ'D ..5..



36 X 24
R5-1A

ONE "U" POST PER SIGN

404 QUANTITY REQ'D ..4..



36 X 12
R6-1(R)

MOUNT ABOVE SIGN 402
IN 4 INSTALLATIONS

409 QUANTITY REQ'D ..1..

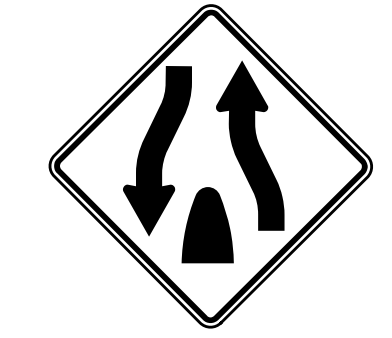

48 X 48
W6-2

TWO "U" POSTS PER SIGN

415 QUANTITY REQ'D ..1..



48 X 48
W6-1

TWO "U" POSTS PER SIGN

420 QUANTITY REQ'D ..2..



48 X 48
W9-1

TWO "U" POSTS PER SIGN

405 QUANTITY REQ'D ..4..



54 X 18
R6-1(R)

TWO "U" POSTS PER SIGN

411 QUANTITY REQ'D ..1..

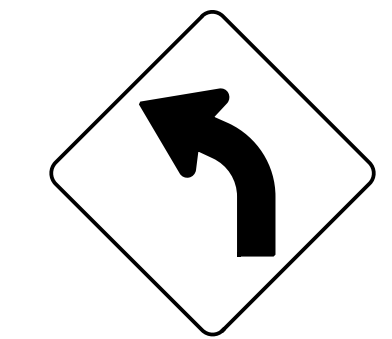

36 X 36
W1-2(L)

ONE "U" POST PER SIGN

416 QUANTITY REQ'D ..1..



42" X 18"
W16-8P

(SEE SIGN-3
FOR SIGN DESIGN)
MOUNT BELOW SIGN 417
IN 1 INSTALLATION

421 QUANTITY REQ'D ..1..

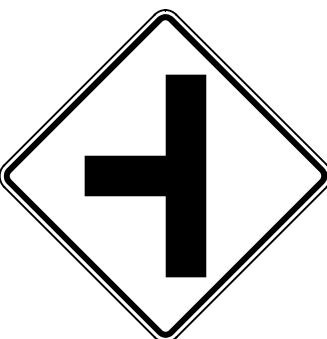

36 X 36
W2-2(L)

TWO "U" POST PER SIGN

406 QUANTITY REQ'D ..1..

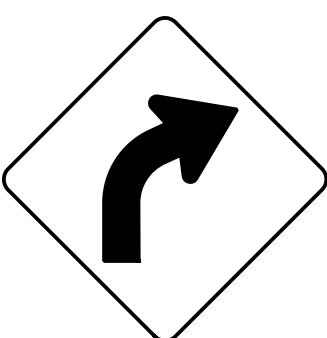

36 X 36
W1-2(R)

ONE "U" POST PER SIGN

412 QUANTITY REQ'D ..2..

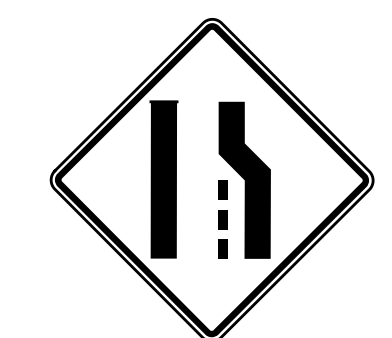

48 X 48
W4-2(R)

TWO "U" POSTS PER SIGN

417 QUANTITY REQ'D ..1..

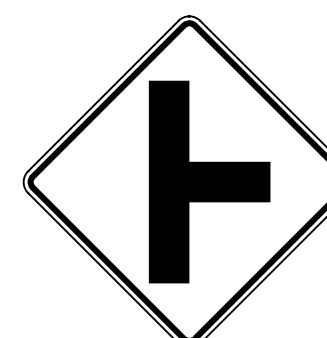

36 X 36
W2-2(R)

TWO "U" POST PER SIGN

422 QUANTITY REQ'D ..1..

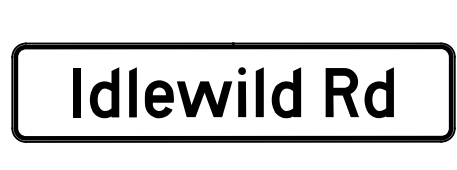

36" X 8"
W16-8P

(SEE SIGN-3
FOR SIGN DESIGN)
MOUNT BELOW SIGN 421
IN 1 INSTALLATION



1025 Wade Avenue
Raleigh, NC 27605
Tel: 919-789-9977
Fax: 919-789-9591
License: C-2197

TYPE "E" SIGNS

TIP NO.	SHEET NO.
R-2915B	SIGN-2A
APPROVED: <i>Joseph Kopaschie</i>	
DATE: 5/27/2015	
SEAL	

501 503 508 511

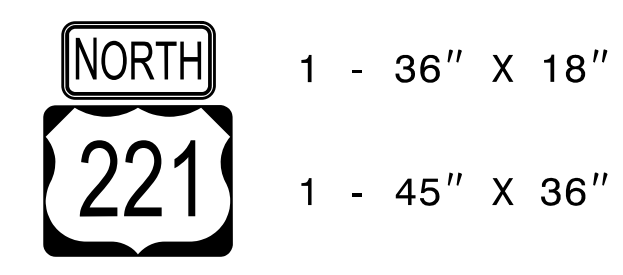

TWO "U" POSTS PER SIGN

502 506 510

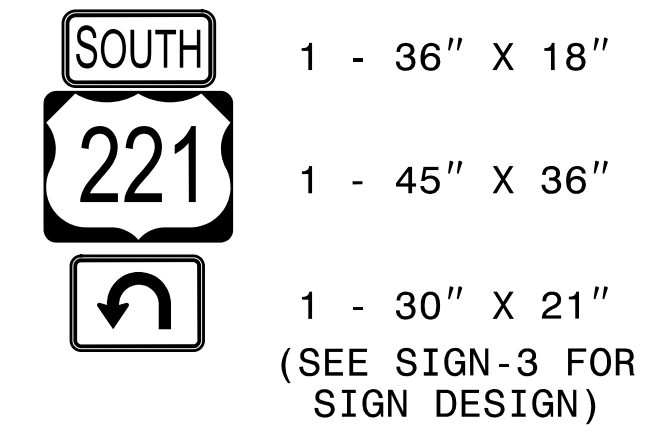

TWO "U" POSTS PER SIGN

504 507 512

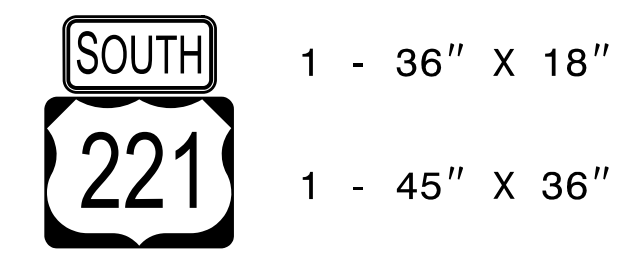

TWO "U" POSTS PER SIGN

505 509

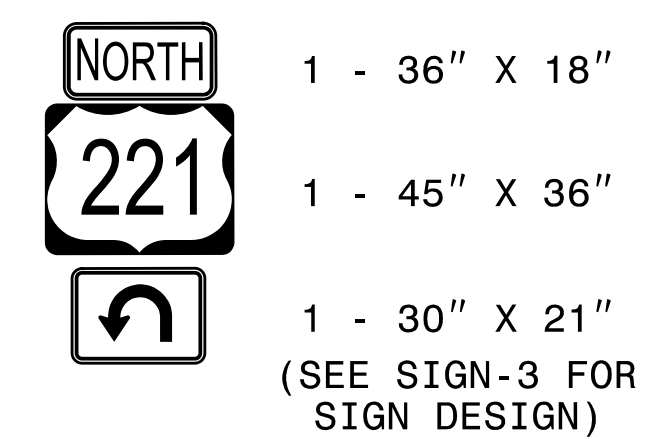

TWO "U" POSTS PER SIGN

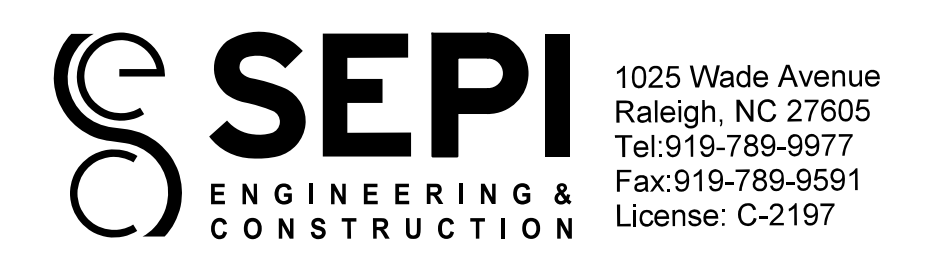

TYPE "F" SIGNS

5/13/2015 6:11:12 AM G:\Transportation\TR13.017.00 NCDOT 2012 Traffic LSA\TR13.017.07 (R-2915B Signing & PMP)\Signing\Engseed 6-11-12.dgn

SIGN NUMBER: 301 & 302
TYPE: D
QUANTITY: 2
SIGN WIDTH: 6'-0"
HEIGHT: 3'-0"
TOTAL AREA: 18.0 Sq.Ft.
BORDER TYPE: FLUSH
RECESS: 0"
WIDTH: 1.5"
RADII: 5"
NO. Z BARS:
LENGTH:

BACKG COLOR: Green
COPY COLOR: White

SYMBOL	X	Y	WID	HT

MAT'L: 0.125" (3.2 mm) ALUMINUM

DESIGN BY: R Drayton
CHECKED BY: J Kopaskie
DATE: Apr 28, 2015
PROJECT ID: R2915-B
DIV: 11

BORDER
R=5"
TH=1.5"

Spacing Factor is 1 unless specified otherwise

LETTER POSITIONS

Letter spacings are to start of next letter

Series/Size	Text Length
D 2000	55.8
D 2000	53.2

FILENAME: Sign Designs
 NORTH CAROLINA D.O.T. SIGN DETAIL

SIGN NUMBER: M5-1
TYPE: M5-1
QUANTITY: 5
SIGN WIDTH: 2'-6"
HEIGHT: 1'-9"
TOTAL AREA: 4.4 Sq.Ft.
BORDER TYPE: FLUSH
RECESS: 0.38"
WIDTH: 0.63"
RADII: 1.13"
NO. Z BARS:
LENGTH:

BACKG COLOR: White
COPY COLOR: Black

SYMBOL	X	Y	WID	HT
U_Turn	8.5	5.2	10.5	13

MAT'L: 0.125" (3.2 mm) ALUMINUM

DESIGN BY: R Drayton
CHECKED BY: J Kopaskie
DATE: Apr 09, 2015
PROJECT ID: R-2915B
DIV: 11

BORDER
R=1.13"
TH=0.63"
IN=0.38"

USE NOTES: 1,2
 1. Legend and border(except those that are colored black) shall be direct applied Grade C sheeting.
 2. Background shall be Grade C reflective sheeting.

MOUNT BELOW SIGN 502 IN 1 INSTALLATION
 MOUNT BELOW SIGN 506 IN 1 INSTALLATION
 MOUNT BELOW SIGN 505 IN 1 INSTALLATION
 MOUNT BELOW SIGN 509 IN 1 INSTALLATION
 MOUNT BELOW SIGN 510 IN 1 INSTALLATION

LETTER POSITIONS

Letter spacings are to start of next letter

Series/Size	Text Length
D 2000	55.8
D 2000	53.2

FILENAME: Sign Designs
 NORTH CAROLINA D.O.T. SIGN DETAIL

SIGN NUMBER: 416
TYPE: W16-8P
QUANTITY: 1
SIGN WIDTH: 3'-6"
HEIGHT: 1'-6"
TOTAL AREA: 5.25 Sq.Ft.
BORDER TYPE: INSET
RECESS: 0.25"
WIDTH: 0.38"
RADII: 1"
NO. Z BARS:
LENGTH:

BACKG COLOR: Yellow
COPY COLOR: Black

SYMBOL	X	Y	WID	HT

MAT'L: 0.080" (2.0 mm) ALUMINUM

DESIGN BY: R Drayton
CHECKED BY: J Kopaskie
DATE: Apr 29, 2015
PROJECT ID: R-2915B
DIV: 11

BORDER
R=1"
TH=0.38"
IN=0.25"

MOUNTED BELOW SIGN #427
IN 1 INSTALLATION

Spacing Factor is 1 unless specified otherwise

LETTER POSITIONS

Letter spacings are to start of next letter

Series/Size	Text Length
D 2000	32.2
D 2000	26.4

FILENAME: To scale Sign Designs
 NORTH CAROLINA D.O.T. SIGN DETAIL

SIGN NUMBER: 422
TYPE: W16-8P
QUANTITY: 1
SIGN WIDTH: 3'-0"
HEIGHT: 0'-8"
TOTAL AREA: 2.0 Sq.Ft.
BORDER TYPE: INSET
RECESS: 0.25"
WIDTH: 0.38"
RADII: 1"
NO. Z BARS:
LENGTH:

BACKG COLOR: Yellow
COPY COLOR: Black

SYMBOL	X	Y	WID	HT

MAT'L: 0.080" (2.0 mm) ALUMINUM

DESIGN BY: R Drayton
CHECKED BY: J Kopaskie
DATE: Apr 29, 2015
PROJECT ID: R-2915B
DIV: 11

BORDER
R=1"
TH=0.38"
IN=0.25"

MOUNTED BELOW SIGN #421
IN 1 INSTALLATION

Spacing Factor is 1 unless specified otherwise

LETTER POSITIONS

Letter spacings are to start of next letter

Series/Size	Text Length
D 2000	28.1

FILENAME: To scale Sign Designs
 NORTH CAROLINA D.O.T. SIGN DETAIL

TIP NO.
R-2915B

SHEET NO.
SIGN-3

APPROVED: Joseph Kopaskie
REGISTERED PROFESSIONAL ENGINEER
 STATE OF NORTH CAROLINA
 LICENSE NO. 029669

DATE: 5/27/2015

SEAL

TIP NO. R-2915B	SHEET NO. SIGN-4
Designed by: APPROVED: <i>Joseph Kopaskie</i> <small>SCDMEAF80A54FA...</small>	
DATE: 5/27/2015	
SEAL	

NAD 83 / CORS

160

165

BEGIN TIP PROJECT R-2915B
-L- CS Sta. 160+01.83 LB.

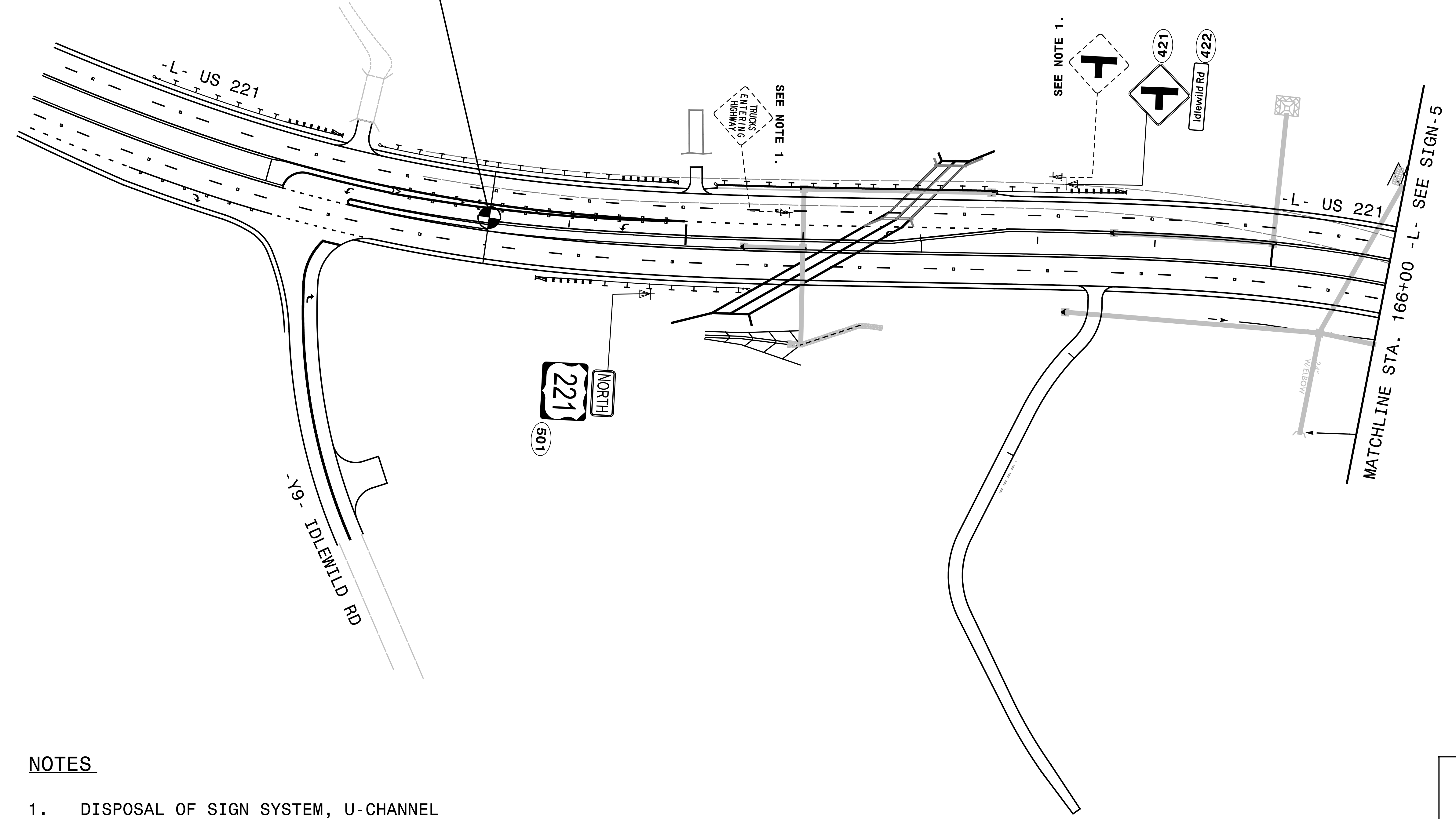

NOTES

- 1. DISPOSAL OF SIGN SYSTEM, U-CHANNEL

1025 Wade Avenue
Raleigh, NC 27605
Tel: 919-789-9977
Fax: 919-789-9591
License: C-2197

EXISTING & PROPOSED
SIGN DETAIL

TIP NO. R-2915B	SHEET NO. SIGN-5
DESIGNED BY: <i>Joseph Kopaskie</i>	
APPROVED: <i>Joseph Kopaskie</i>	
DATE: 5/27/2015	
SEAL	

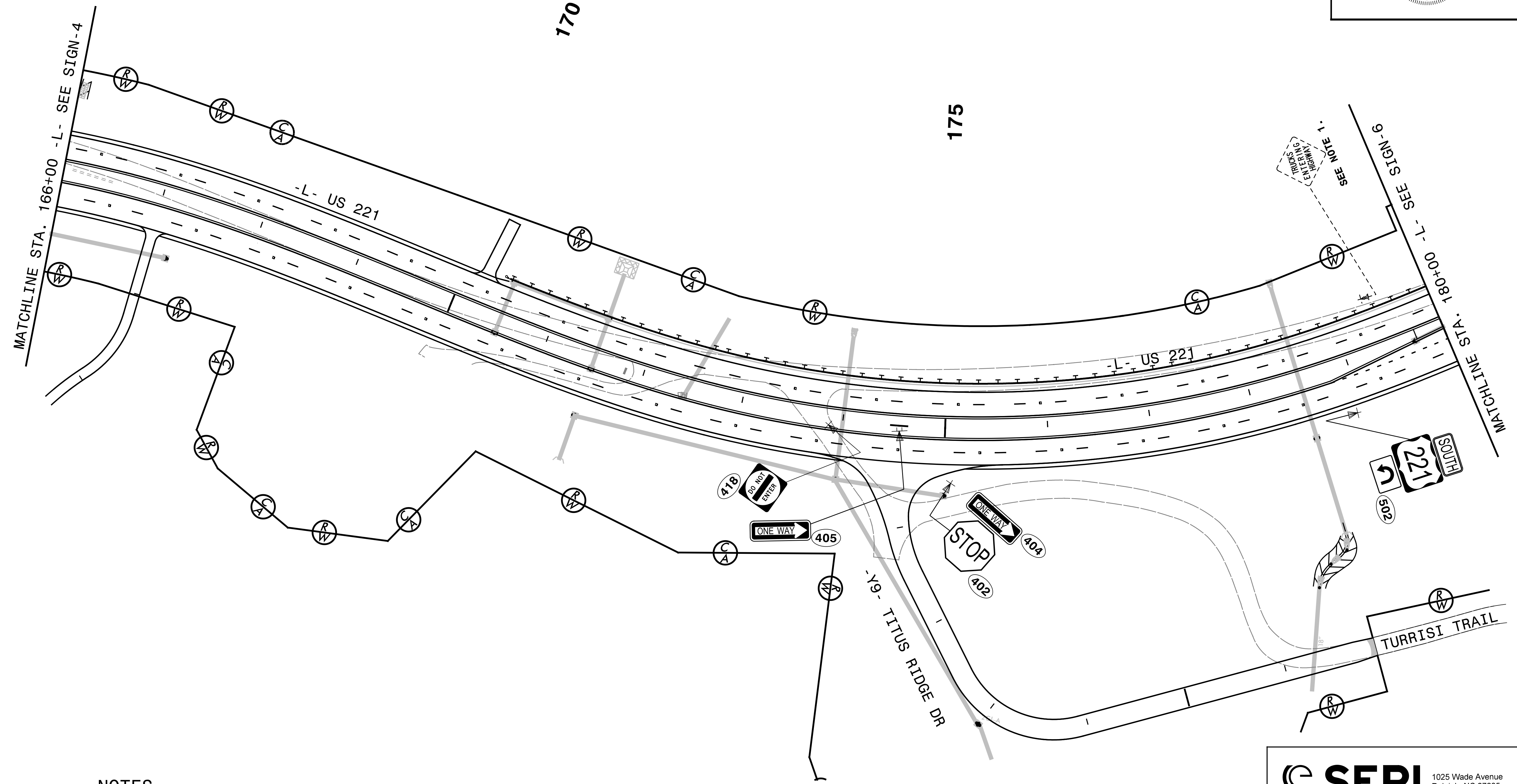
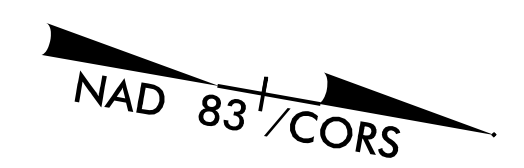

NOTES

1. DISPOSAL OF SIGN SYSTEM, U-CHANNEL

SEPI ENGINEERING & CONSTRUCTION
 1025 Wade Avenue
 Raleigh, NC 27605
 Tel: 919-789-9977
 Fax: 919-789-9591
 License: C-2197

EXISTING & PROPOSED SIGN DETAIL

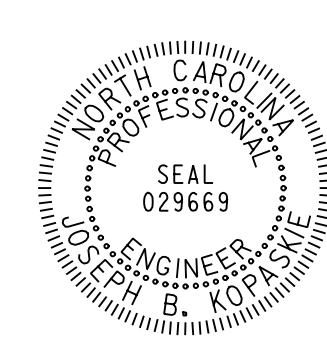
TIP NO. R-2915B	SHEET NO. SIGN-6
Designed by: APPROVED: <i>Joseph Kopaske</i> <small>SCDREAEF80AS4FA...</small>	
DATE: 5/27/2015	
SEAL 	

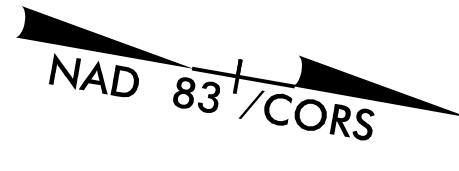

190

185

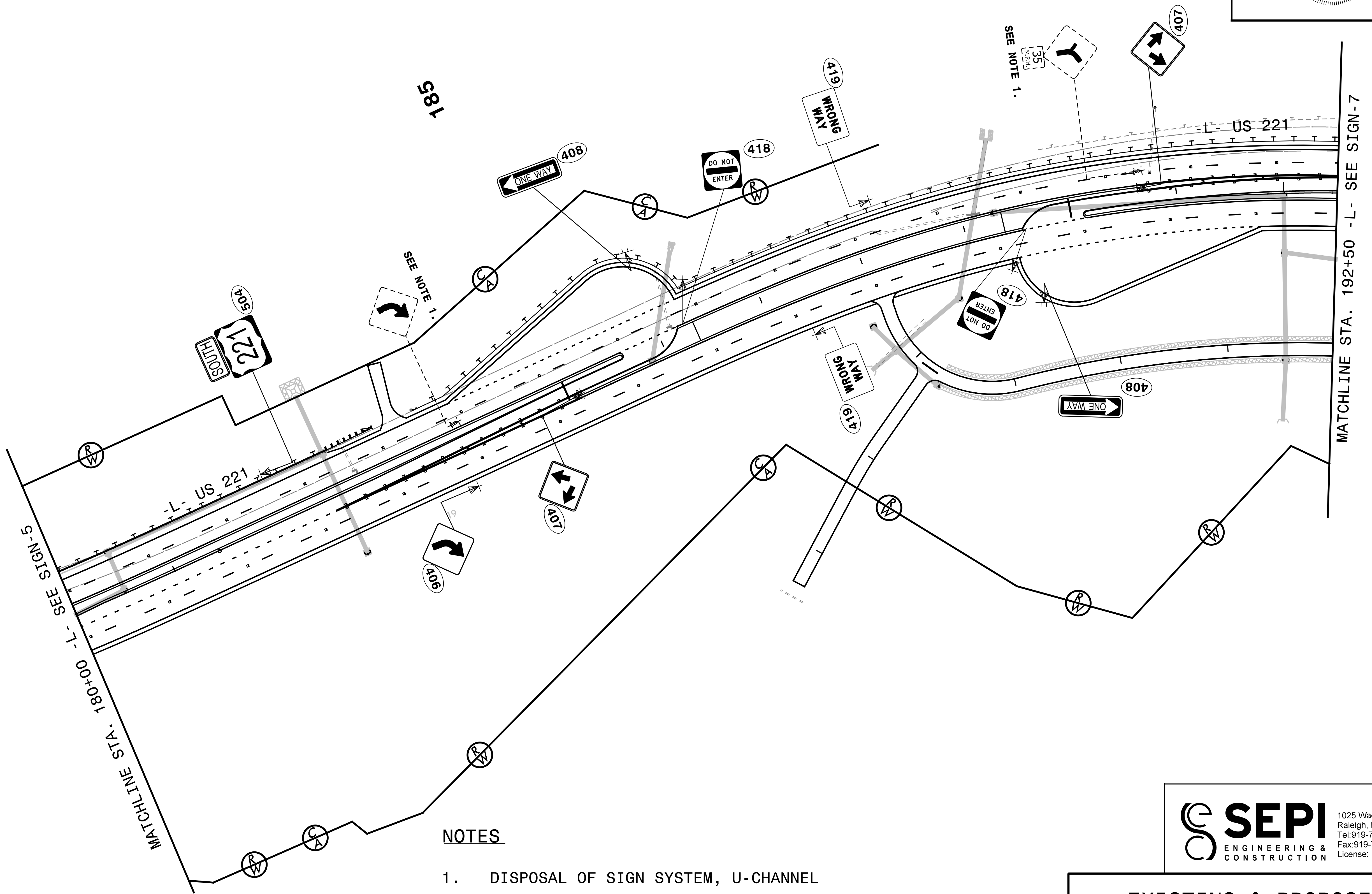

NOTES

1. DISPOSAL OF SIGN SYSTEM, U-CHANNEL

SEPI ENGINEERING & CONSTRUCTION
 1025 Wade Avenue
 Raleigh, NC 27605
 Tel: 919-789-9977
 Fax: 919-789-9591
 License: C-2197

**EXISTING & PROPOSED
SIGN DETAIL**

TIP NO.	SHEET NO.
R-2915B	SIGN-7
APPROVED: <i>Joseph Kopaschke</i> <small>Professional Engineer License No. 029669</small>	
DATE: 5/27/2015	
SEAL	

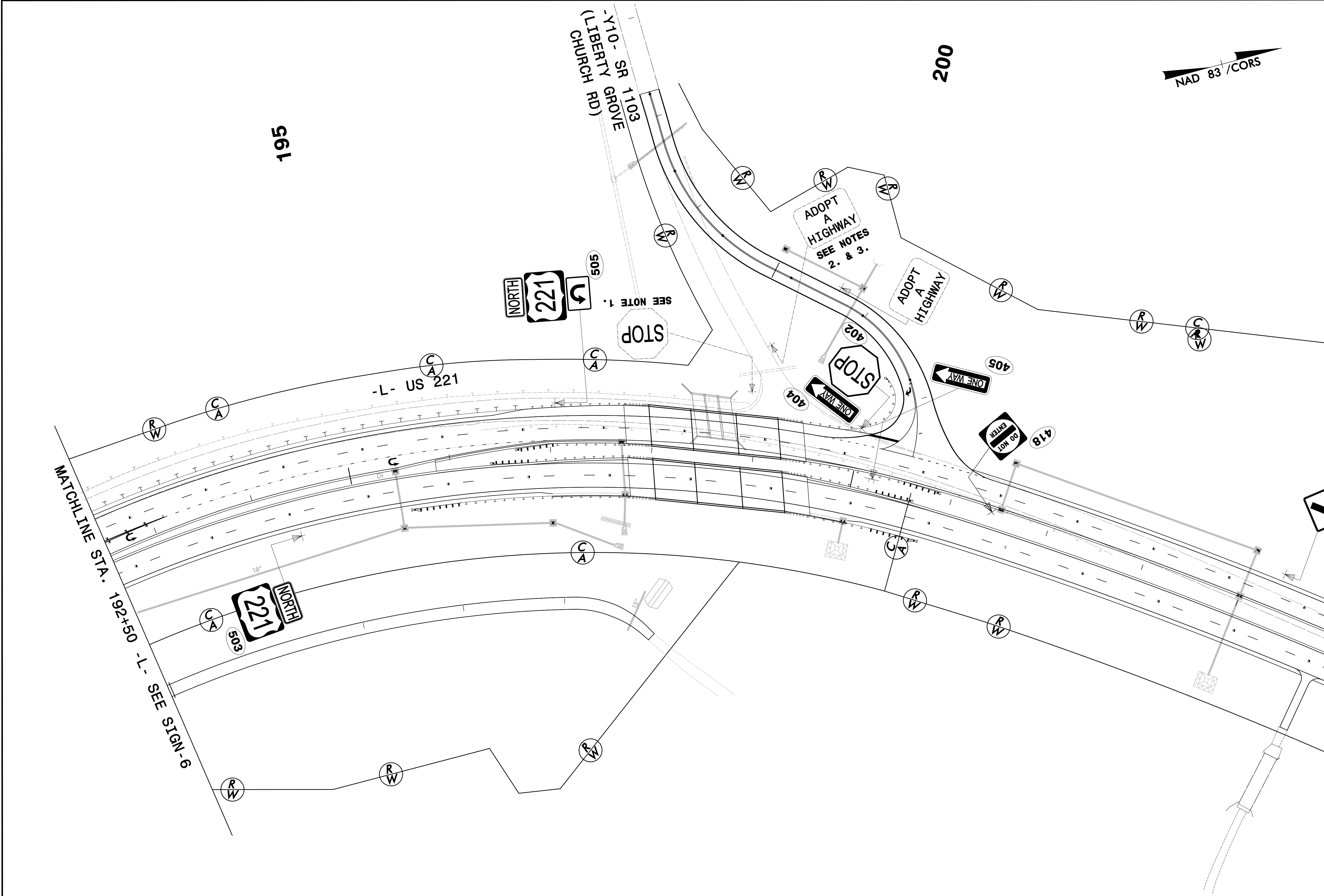

NOTES

1. DISPOSAL OF SIGN SYSTEM, U-CHANNEL
2. SIGN ERECTION, RELOCATE SIGN TYPE E
3. DISPOSAL OF SUPPORT, U-CHANNEL

SEPI
 ENGINEERING & CONSTRUCTION

1025 Wade Avenue
 Raleigh, NC 27605
 Tel: 919-789-9977
 Fax: 919-789-9591
 License: C-2197

**EXISTING & PROPOSED
 SIGN DETAIL**

TIP NO. R-2915B	SHEET NO. SIGN-8
Approved by: <i>Joseph Kopaskie</i> APPROVED: <i>Joseph Kopaskie</i> <small>0CDEAEAF80A54FA...</small>	
DATE: 5/27/2015	
SEAL	

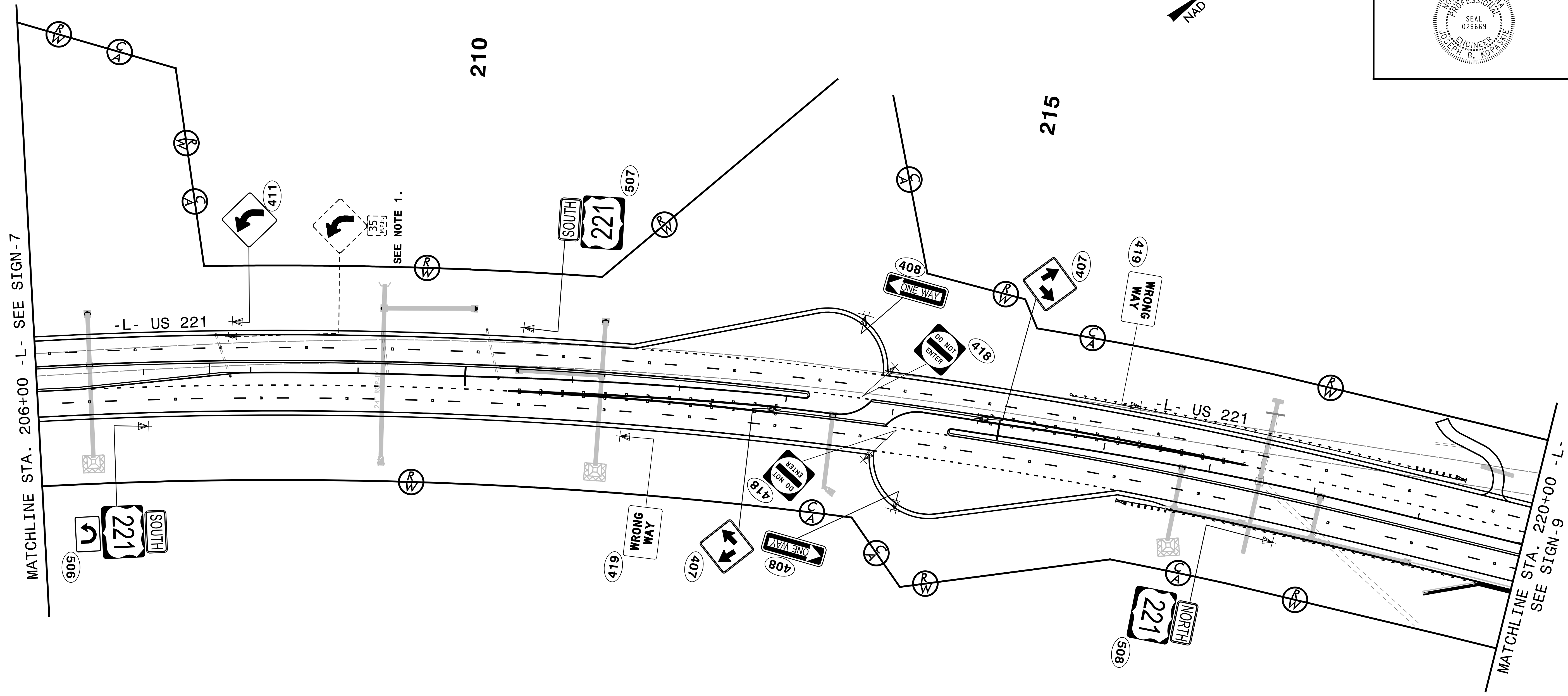
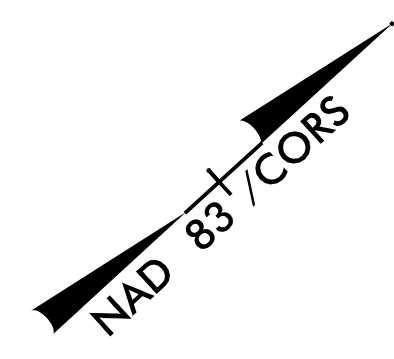

NOTES

1. DISPOSAL OF SIGN SYSTEM, U-CHANNEL

SEPI
 ENGINEERING & CONSTRUCTION
 1025 Wade Avenue
 Raleigh, NC 27605
 Tel: 919-789-9977
 Fax: 919-789-9591
 License: C-2197

EXISTING & PROPOSED SIGN DETAIL

TIP NO. R-2915B	SHEET NO. SIGN-9
Designed by: APPROVED: <i>Joseph Kopaskie</i> <small>SCDMEAF80A54FA...</small>	
DATE: 5/27/2015	
SEAL	

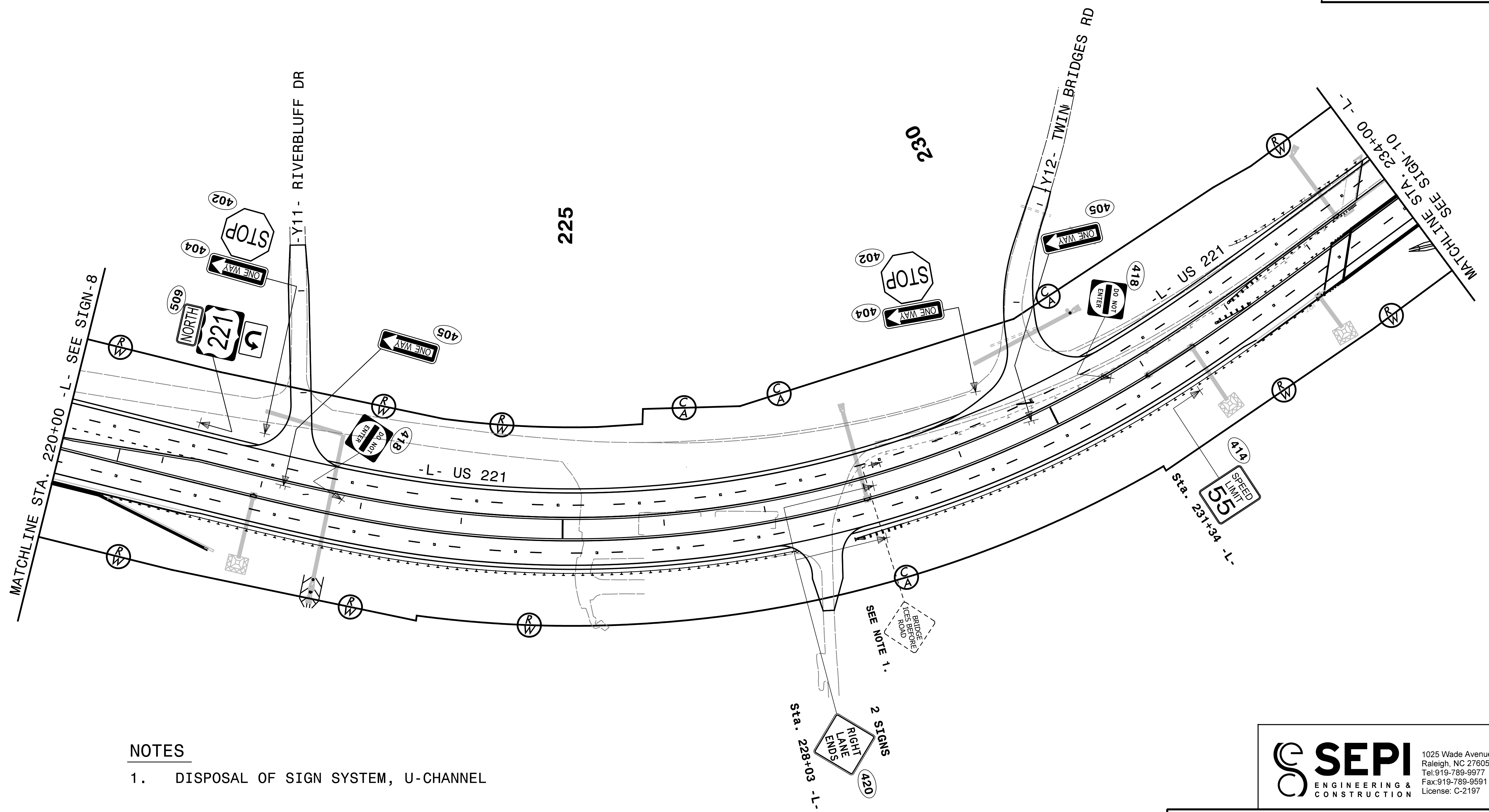
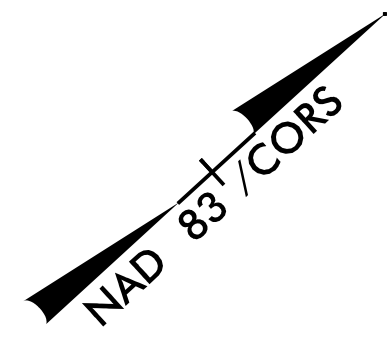

NOTES

- DISPOSAL OF SIGN SYSTEM, U-CHANNEL

SEPI
 ENGINEERING & CONSTRUCTION
 1025 Wade Avenue
 Raleigh, NC 27605
 Tel: 919-789-9977
 Fax: 919-789-9591
 License: C-2197

EXISTING & PROPOSED SIGN DETAIL

TIP NO.	SHEET NO.
R-2915B	SIGN-10
APPROVED: <i>Joseph Kopaskie</i>	DESIGNED BY:
DATE: 5/27/2015	
SEAL	

NAD 83/CORS

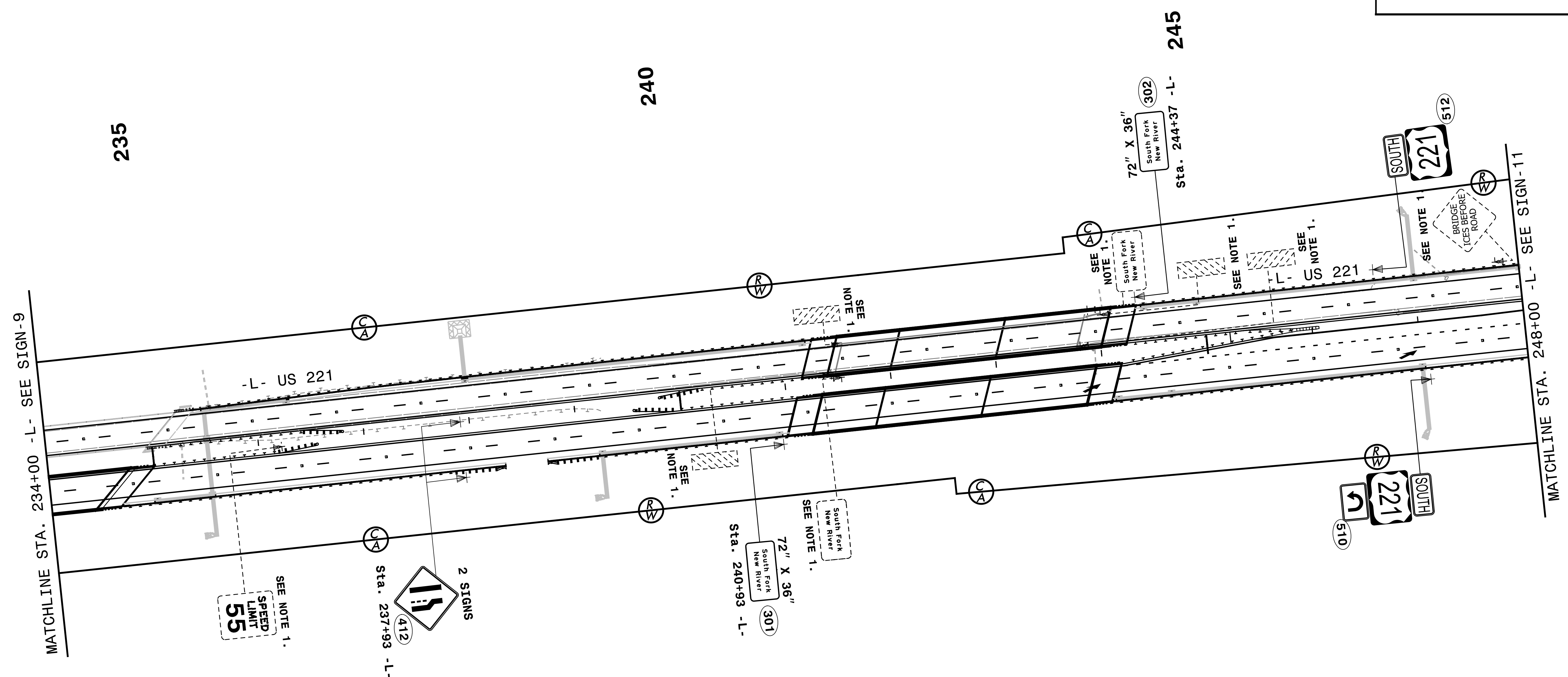

NOTES

- DISPOSAL OF SIGN SYSTEM, U-CHANNEL

SEPI ENGINEERING & CONSTRUCTION
 1025 Wade Avenue
 Raleigh, NC 27605
 Tel: 919-789-9977
 Fax: 919-789-9591
 License: C-2197

**EXISTING & PROPOSED
SIGN DETAIL**

TIP NO. R-2915B	SHEET NO. SIGN-11
APPROVED: <i>Joseph Kojasik</i> <small>REGISTERED PROFESSIONAL ENGINEER LICENSE NO. 029669</small>	
DATE: 5/27/2015	
SEAL	

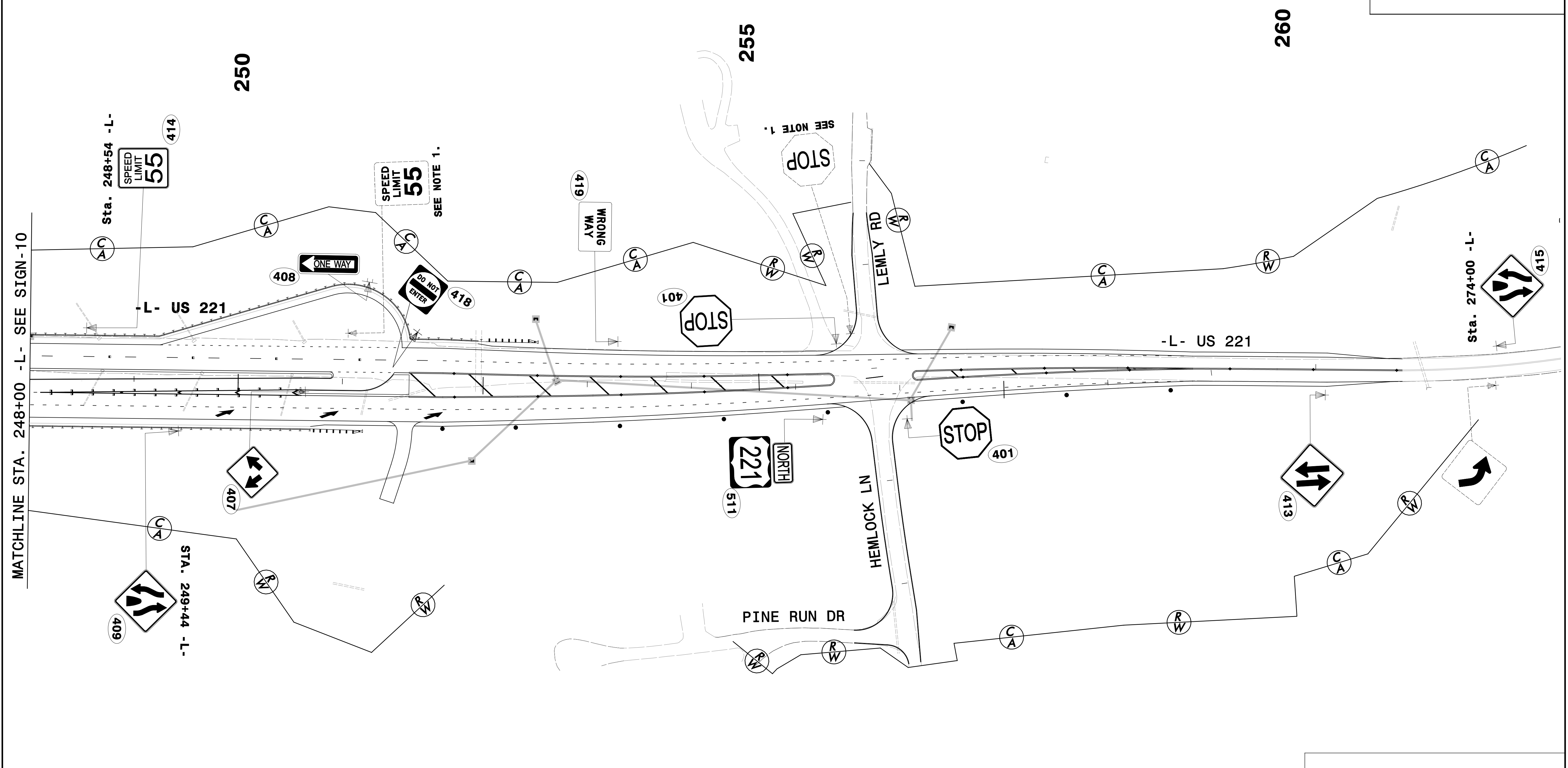
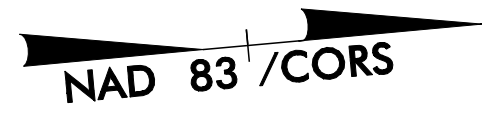

NOTES

1. DISPOSAL OF SIGN SYSTEM, U-CHANNEL
2. SIGN ERECTION, RELOCATE SIGN TYPE E

SEPI
ENGINEERING & CONSTRUCTION

1025 Wade Avenue
Raleigh, NC 27605
Tel: 919-789-9977
Fax: 919-789-9591
License: C-2197

**EXISTING & PROPOSED
SIGN DETAIL**