

PLAN OF WING W1
(END BENT 1, UPPER WING)

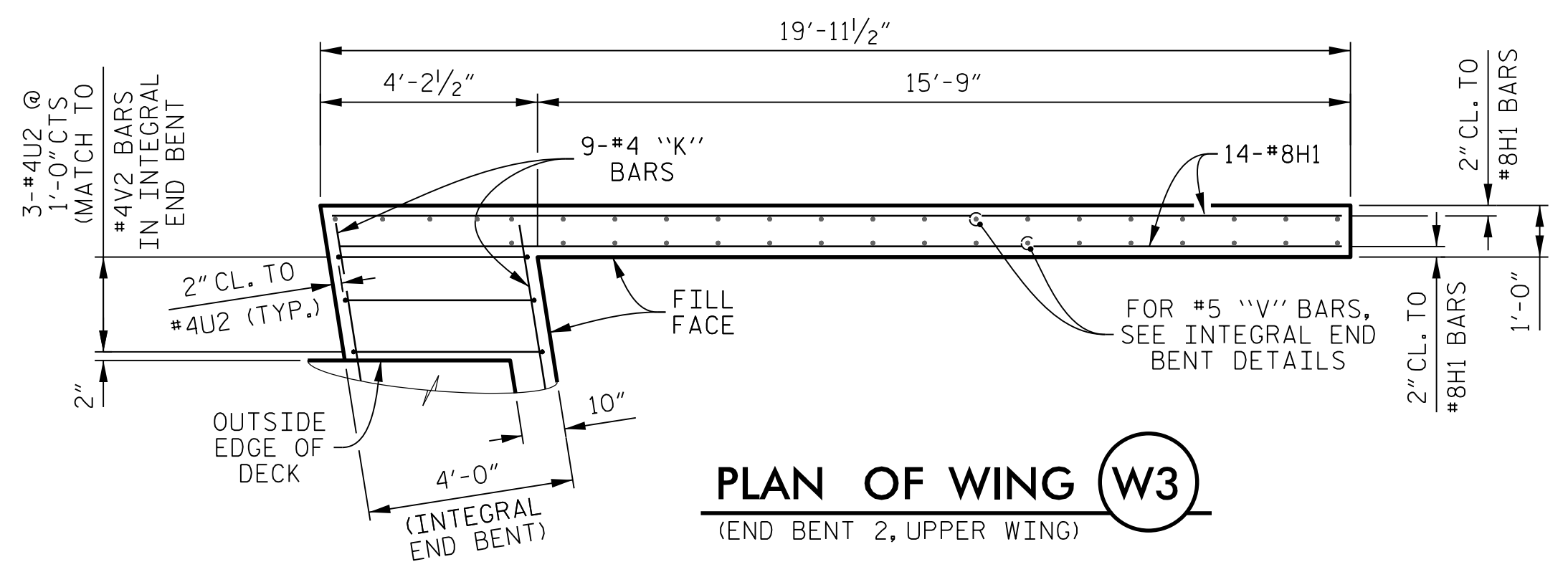

PLAN OF WING W3
(END BENT 2, UPPER WING)

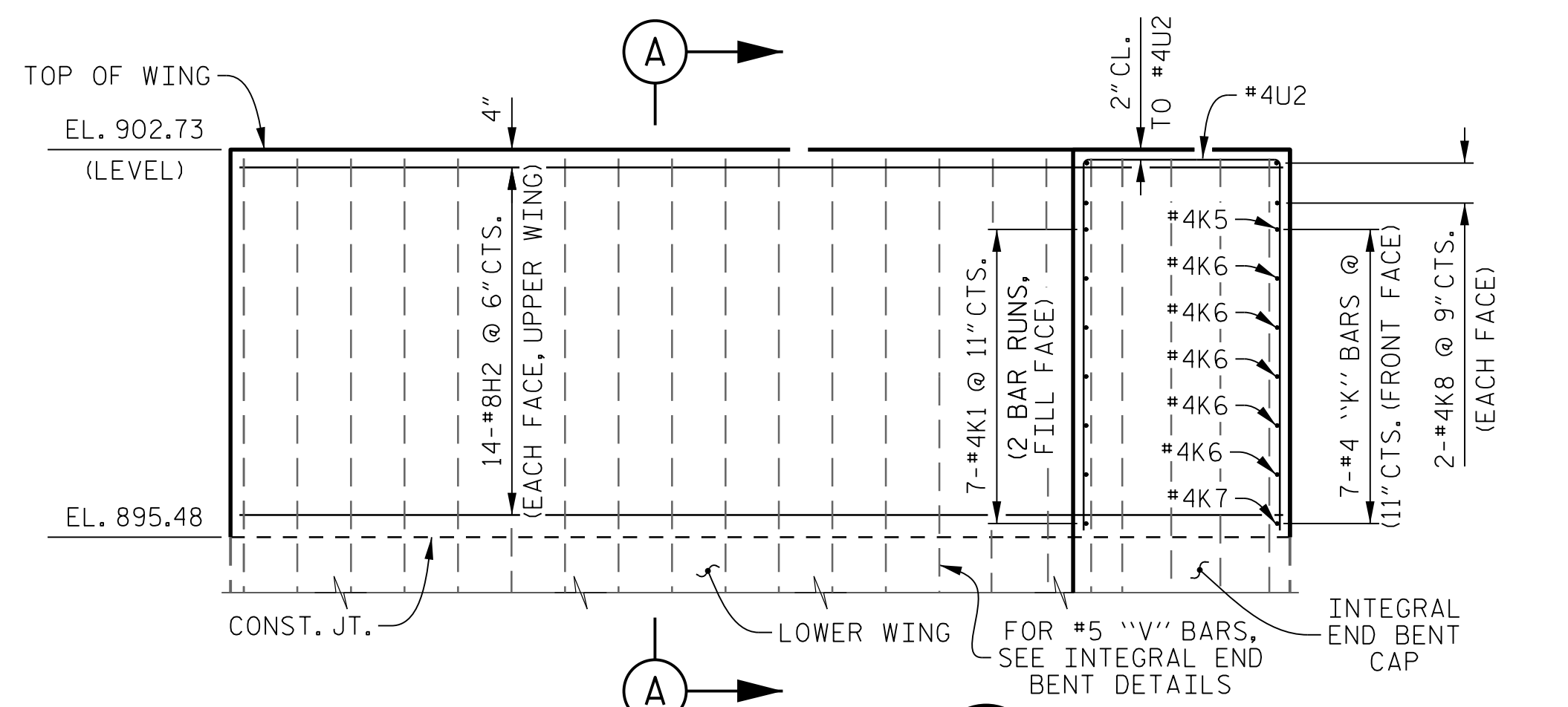

ELEVATION OF WING W1
(END BENT 1, UPPER WING)

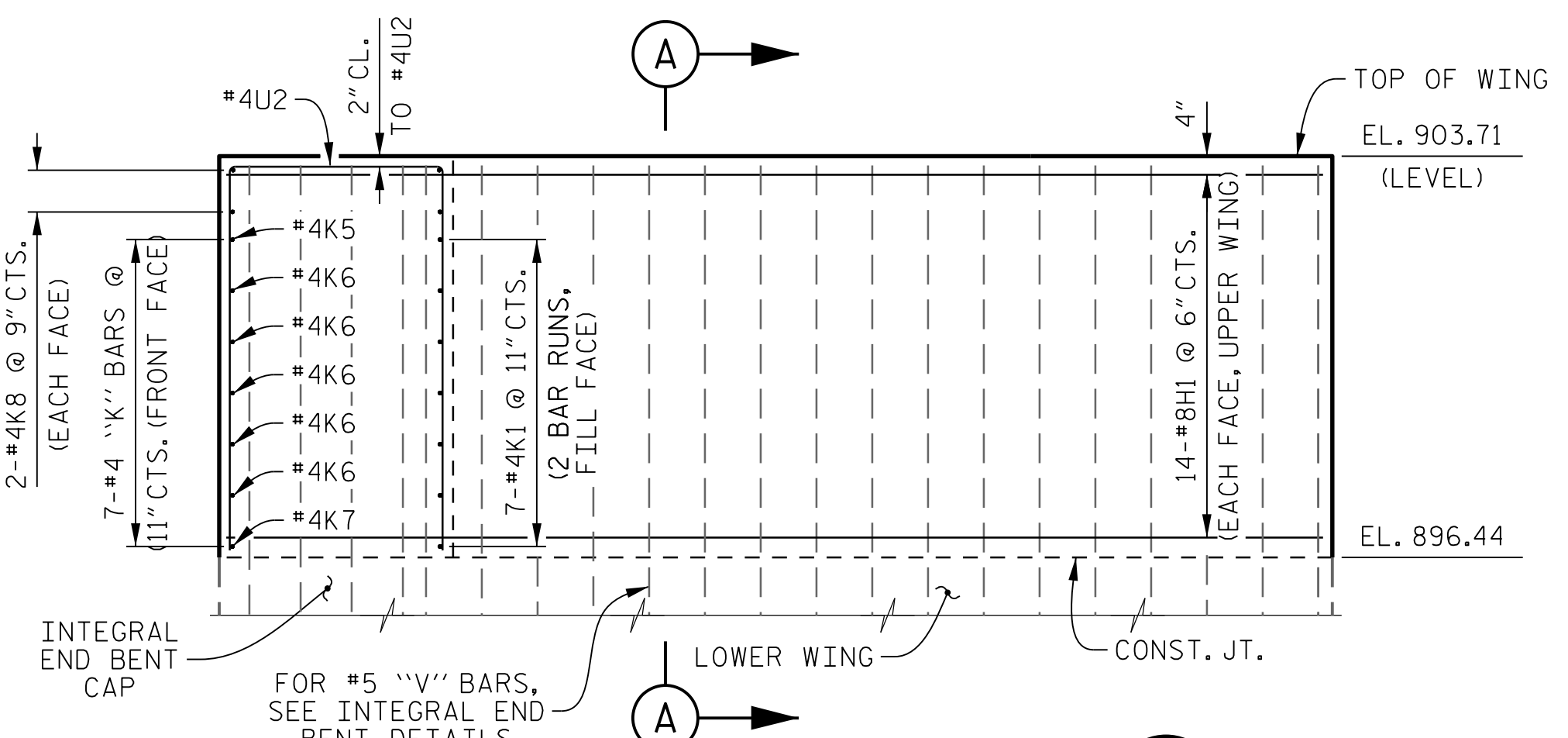

ELEVATION OF WING W3
(END BENT 2, UPPER WING)

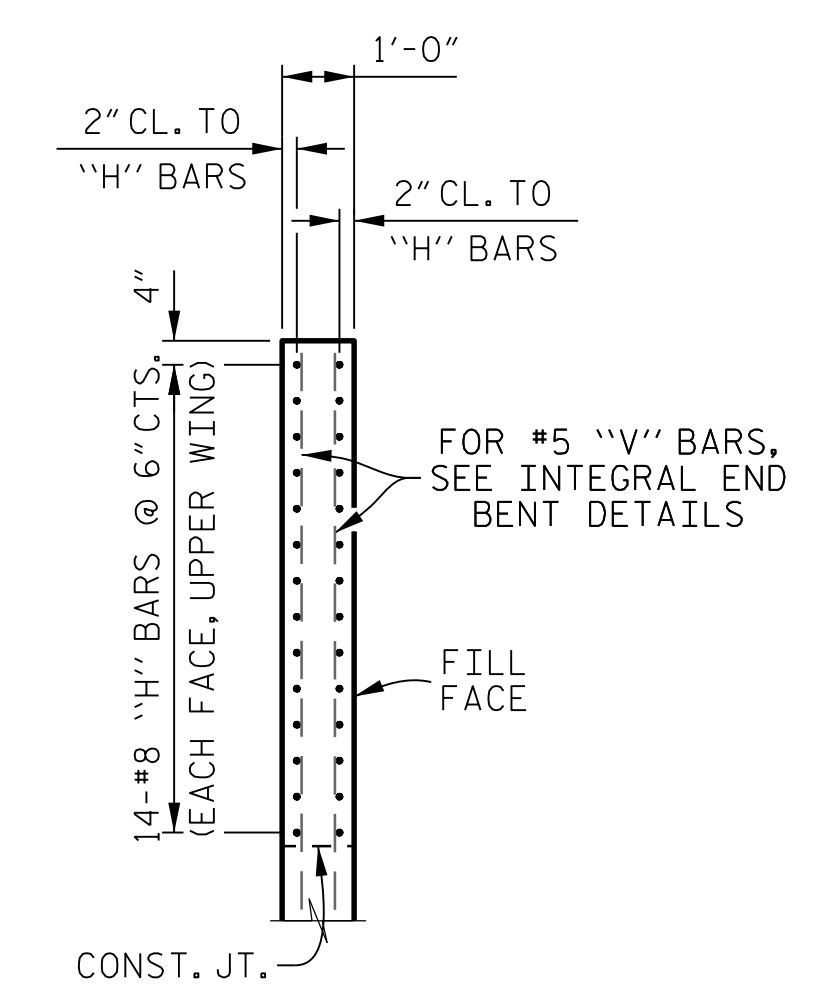

SECTION A-A

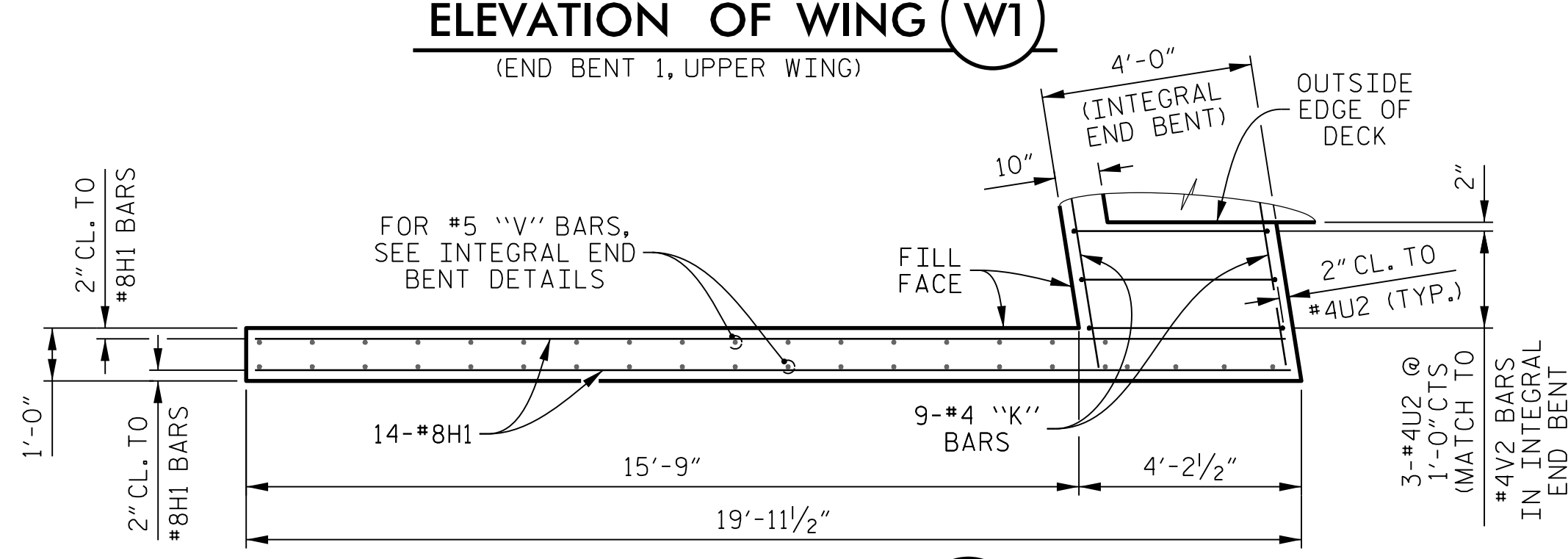

PLAN OF WING W2
(END BENT 1, UPPER WING)

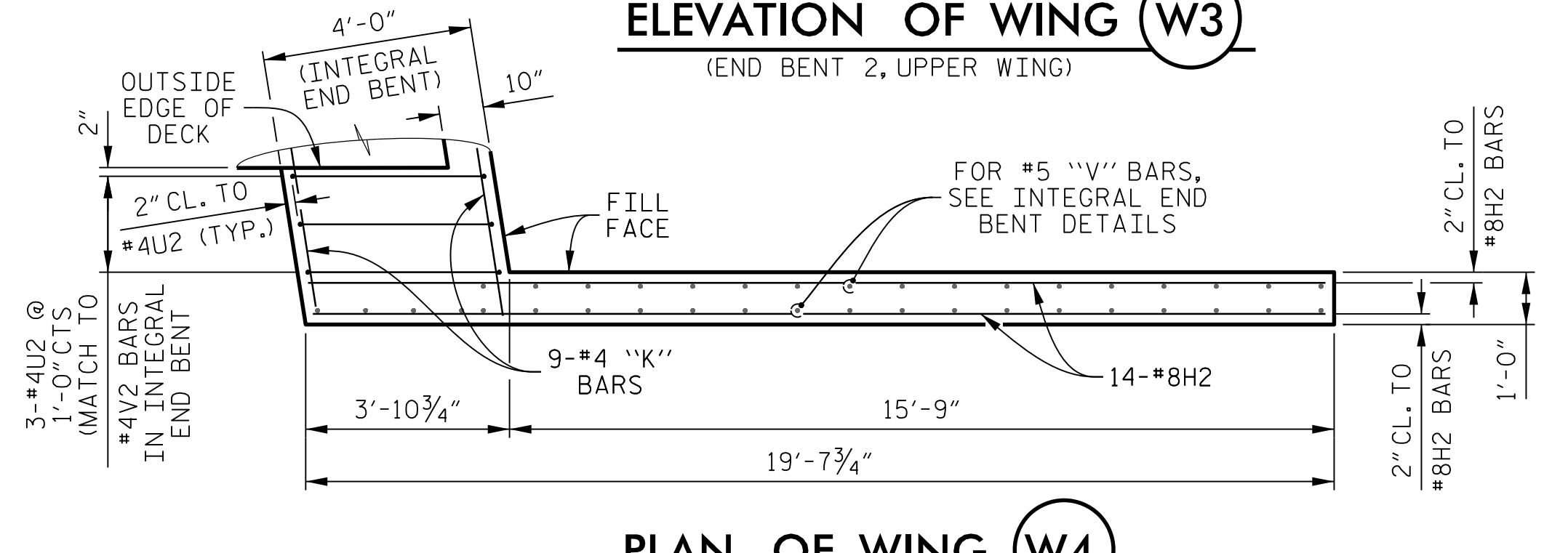

PLAN OF WING W4
(END BENT 2, UPPER WING)

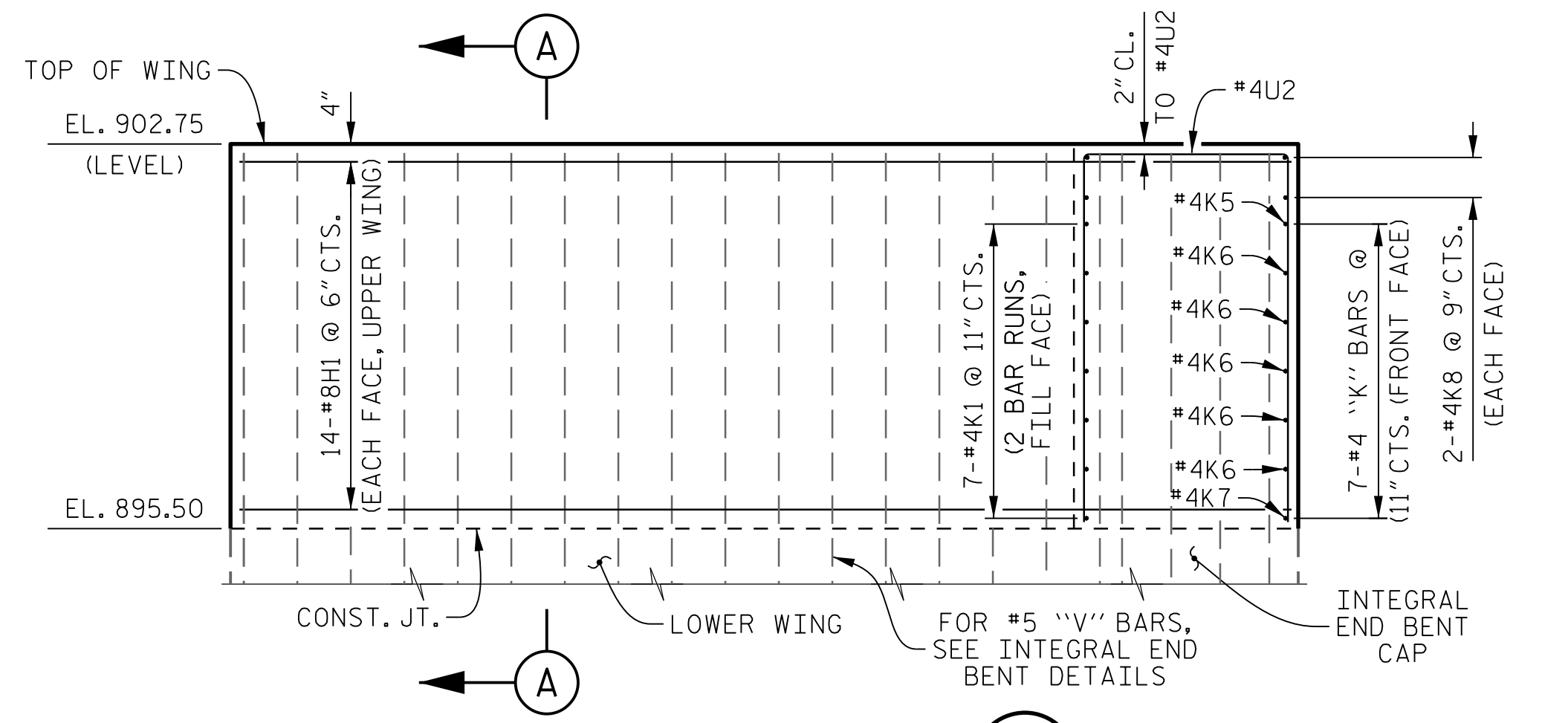

ELEVATION OF WING W2
(END BENT 1, UPPER WING)

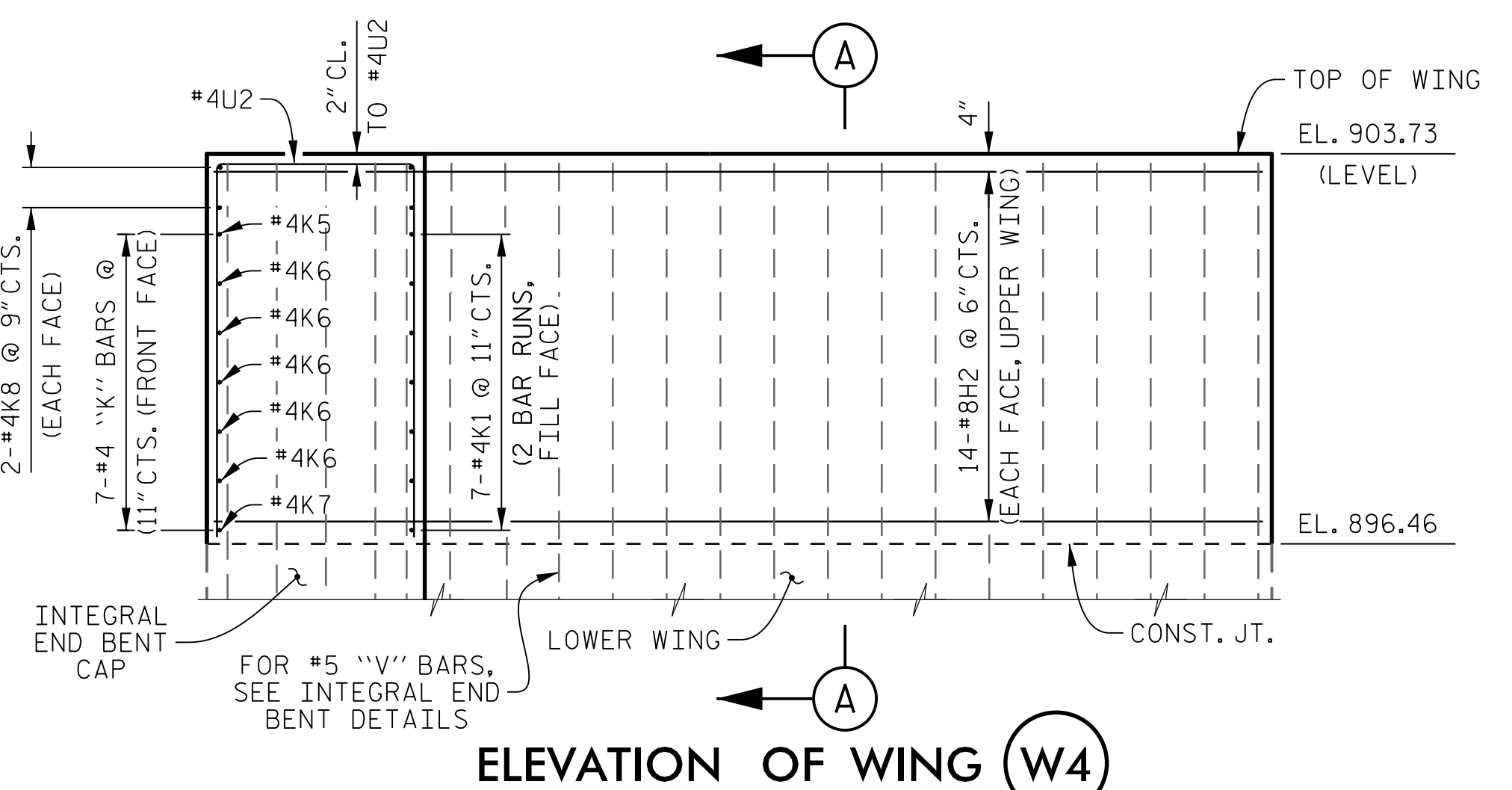

ELEVATION OF WING W4
(END BENT 2, UPPER WING)

PROJECT NO. U-2524BC
 GUILFORD COUNTY
 STATION: 27 + 40.75 -L-
 SHEET 3 OF 3

STATE OF NORTH CAROLINA
 DEPARTMENT OF TRANSPORTATION
 RALEIGH
 SUPERSTRUCTURE
 PLAN OF SPAN
 DETAILS

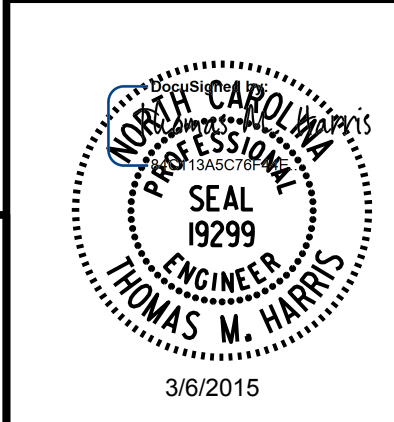

PLANS PREPARED BY:
PARSONS
 5540 CenterView Drive, Suite 217
 Raleigh, NC 27606-3386
 NC LICENSE No. F-0246
 FOR NORTH CAROLINA DEPARTMENT OF TRANSPORTATION

DRAWN BY: K. E. LOFTON DATE: 12-14
 CHECKED BY: T. M. HARRIS DATE: 1-15
 DESIGN ENGINEER: T. M. HARRIS DATE: 2-15

| REVISIONS | | | | | | SHEET No. |
|-----------|-----|-------|-----|-----|-------|--------------|
| No. | BY: | DATE: | No. | BY: | DATE: | TOTAL SHEETS |
| 1 | | | 3 | | | 27 |
| 2 | | | 4 | | | |

FILE: I:\2524BC\1\Drawings\Span\102524BC_SP_03.dgn
 DATE: 3/2015 9:27:00 PM