

T.I.P.: R-2303D

CONTRACT:

**STATE OF NORTH CAROLINA  
DEPARTMENT OF TRANSPORTATION**

**SIGNING PLAN  
SAMPSON COUNTY**

LOCATION: NC 24 FROM SR 1303 (MITCHELL LOOP ROAD)  
TO US 421-701/SR 1296 (SUNSET AVENUE)

TIP NO. R-2303D	SHEET NO. SIGN-1
APPROVED:	
DATE: 4-23-13	
SEAL 	

**ROADWAY STANDARD DRAWING**

THE FOLLOWING ROADWAY STANDARDS AS APPEAR IN "ROADWAY STANDARD DRAWINGS" - PROJECT SERVICES UNIT - N.C. DEPARTMENT OF TRANSPORTATION - RALEIGH, N.C., DATED JANUARY 2012 ARE APPLICABLE TO THIS PROJECT AND BY REFERENCE HEREBY ARE CONSIDERED A PART OF THESE PLANS:

STD. NO.	TITLE
901.10	TYPE 'A' SIGNS
901.20	TYPE 'B' SIGNS
901.50	ARROWS AND SHIELDS
901.70	SIGN STRINGERS AND SUPPORT SPACING
901.80	SIGN MOUNTING DETAILS - FOR TYPE A AND TYPE B SIGNS
903.10	GROUND MOUNTED SIGN SUPPORTS
904.10	ORIENTATION OF GROUND MOUNTED SIGNS
904.50	MOUNTING OF TYPE 'D', 'E' AND 'F' SIGNS ON 'U' CHANNEL POSTS

**PROJECT NOTES**

- 1 DISPOSAL OF SIGN SYSTEM, U-CHANNEL
- 2 RELOCATE SIGN, TYPE D
- 3 DISPOSAL OF SIGN SYSTEM, STEEL BEAM

**GENERAL NOTES**

- . SIGNS FURNISHED BY STATE
- . ALL TYPE 'D' SIGNS SHALL BE MOUNTED ON TWO U-CHANNEL POSTS UNLESS OTHERWISE INDICATED ON THE PLANS.
- . IF REMOVAL OR RELOCATION OF SIGNS ON PRIVATE STREET (NON-STATE MAINTAINED) IS REQUIRED DUE TO CONSTRUCTION, THE CONTRACTOR SHALL INFORM THE ENGINEER. THE WORK WILL BE COMPLETED BY OTHERS.
- . WHEN NOT STATIONED OR DIMENSIONED ON PLANS, ALL 'E' AND 'F' SIGNS SHALL BE FIELD LOCATED BY THE ENGINEER
- . ALL EXISTING SIGNS ON "U" CHANNEL POST WITHIN THE PROJECT LIMITS SHALL BE REMOVED AND DISPOSED OF UNLESS OTHERWISE NOTED ON PLANS.
- . WHEN EXISTING SIGNS ARE REMOVED AND INSTALLED ON NEW SUPPORTS, THE RE-ERECTION SHALL IMMEDIATELY FOLLOW THE REMOVAL.
- . THE BACKGROUND FOR TYPE E & F SIGNS SHALL BE TYPE C REFLECTIVE SHEETING.
- . SEE ROADWAY PLANS FOR GUARD/GUIDE RAIL DETAILS.

**SUMMARY OF QUANTITIES**

ITEM NO.		ITEM DESCRIPTION	QUANTITY	UNIT
DESC. NO.	SECT. NO.			
4048000000	902	REINFORCED CONCRETE SIGN FOUNDATION	12	C. Y.
4054000000	902	PLAIN CONCRETE SIGN FOUNDATION	1	C. Y.
4060000000	903	SUPPORTS, BREAKAWAY STEEL BEAM	8667	LB.
4066000000	903	SUPPORTS, SIMPLE STEEL BEAM	1128	LB.
4072000000	903	SUPPORTS, 3 LB STEEL U-CHANNEL	3562	L. F.
4096000000	904	SIGN ERECTION, TYPE D	9	EA.
4102000000	904	SIGN ERECTION, TYPE E	129	EA.
4108000000	904	SIGN ERECTION, TYPE F	41	EA.
4110000000	904	SIGN ERECTION, TYPE A (GROUND MOUNTED)	13	EA.
4110000000	904	SIGN ERECTION, TYPE B (GROUND MOUNTED)	1	EA.
4116100000	904	SIGN ERECTION, RELOCATE SIGN TYPE D	6	EA.
4152000000	907	DISPOSAL OF SIGN SYSTEM, STEEL BEAM	7	EA.
4155000000	907	DISPOSAL OF SIGN SYSTEM, U-CHANNEL	99	EA.

**INDEX**

SHEET NO.	DESCRIPTION
SIGN-1	TITLE SHEET
SIGN-1A, 1B	SUPPORT INFORMATION
SIGN-2	E SHEETS
SIGN-3	F SHEETS
SIGN-4-4E	SIGN DESIGNS
SIGN-5-19	SIGN DETAIL SHEETS

PLAN PREPARED BY: N.C.D.O.T. SIGNING AND DELINEATION UNIT

**A. ALQUDWAH, P.E.** SIGNING & DELINEATION REGIONAL ENGINEER

**B. RASHID** SIGNING & DELINEATION PROJECT DESIGN ENGINEER

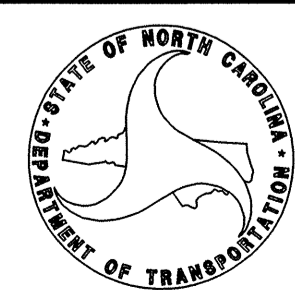

APPROVED: *RWF*  
DATE: 3/8/12

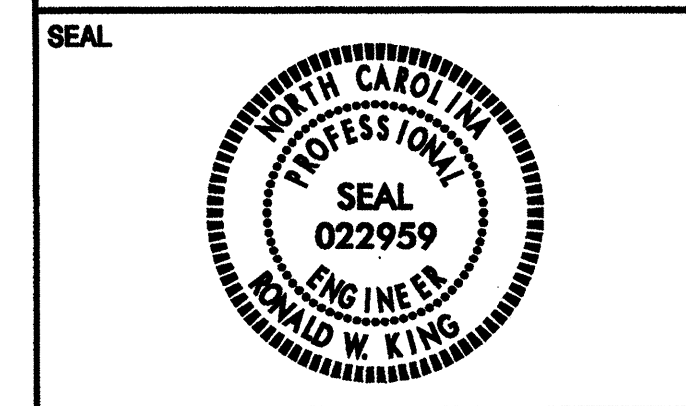

STATE OF NORTH CAROLINA  
DEPT. OF TRANSPORTATION  
DIVISION OF HIGHWAYS  
RALEIGH, N.C.

ENGLISH DETAIL DRAWING FOR  
GROUND MOUNTED SIGN SUPPORTS

SHEET 2 OF 3  
903D10

BEAM SHAPE	SLIP BASE PLATE DATA								KEEPER PLATE DATA								HINGE CONNECTION DATA								BREAK AWAY SUPPORT WEIGHT CONSTANT LBS.	
	BOLT SIZE	A <sub>1</sub>	B <sub>1</sub>	C <sub>1</sub>	D <sub>1</sub>	E <sub>1</sub>	T <sub>1</sub>	R <sub>1</sub>	A <sub>2</sub>	B <sub>2</sub>	C <sub>2</sub>	D <sub>2</sub>	E <sub>2</sub>	R <sub>2</sub>	T <sub>2</sub>	BOLT SIZE	F	G	H	I	J	K	L	R <sub>3</sub>		T <sub>3</sub>
S3X5.7	1/2" DIA. X 3"	7"	4"	1"	3/4"	2 1/2"	1"	3/32"	7"	4"	1"	3/4"	2 1/2"	3/32"	28 GAUGE	1/2" DIA. X 1 1/4"	2 1/4"	3 1/2"	4"	1/2"	1"	1 1/2"	2"	3/32"	3/8"	18
S4X7.7	1/2" DIA. X 3"	8"	4"	1"	3/4"	2 1/2"	1"	3/32"	8"	4"	1"	3/4"	2 1/2"	3/32"	28 GAUGE	1/2" DIA. X 1 1/4"	2 5/8"	3 1/2"	4"	1/2"	1"	1 1/2"	2"	3/32"	3/8"	20
W6X9	1/2" DIA. X 3"	10"	5"	1"	3/4"	3 1/2"	1"	3/32"	10"	5"	1"	3/4"	3 1/2"	3/32"	28 GAUGE	1/2" DIA. X 1 1/4"	4"	3 1/2"	4"	3/4"	1"	1 1/2"	2"	3/32"	3/8"	32
W6X12	5/8" DIA. X 3 3/4"	11"	5"	1 1/4"	7/8"	3 1/4"	1 1/4"	11/32"	11"	5"	1 1/4"	7/8"	3 1/4"	11/32"	28 GAUGE	5/8" DIA. X 2 1/4"	4"	4"	4 1/2"	3/4"	1 1/8"	5/8"	2 1/4"	11/32"	3/8"	39
W6X16	5/8" DIA. X 3 3/4"	12"	6"	1 1/4"	7/8"	4 1/4"	1 1/2"	11/32"	12"	6"	1 1/4"	7/8"	4 1/4"	11/32"	28 GAUGE	5/8" DIA. X 2 1/2"	4"	4"	4 1/2"	3/4"	1 1/8"	5/8"	2 1/4"	11/32"	1/2"	47
W8X18	5/8" DIA. X 4 1/4"	13 1/2"	6 1/2"	1 1/4"	7/8"	4 3/4"	1 1/2"	11/32"	13 1/2"	6 1/2"	1 1/4"	7/8"	4 3/4"	11/32"	28 GAUGE	5/8" DIA. X 2 1/2"	5 1/4"	4"	4 1/2"	1"	1 1/8"	5/8"	2 1/4"	11/32"	1/2"	70
W8X21	3/4" DIA. X 4 1/4"	14"	7"	1 1/2"	1"	5"	1 1/2"	13/32"	14"	7"	1 1/2"	1"	5"	13/32"	28 GAUGE	3/4" DIA. X 2 3/4"	5 1/4"	6"	7"	1"	1 3/4"	3/4"	3 1/2"	13/32"	1/2"	73
W10X22	3/4" DIA. X 4 1/4"	16"	8"	1 1/2"	1"	6"	1 1/2"	13/32"	16"	8"	1 1/2"	1"	6"	13/32"	28 GAUGE	3/4" DIA. X 2 3/4"	5 3/4"	6"	7"	1"	1 3/4"	3/4"	3 1/2"	13/32"	1/2"	119
W10X26	3/4" DIA. X 4 3/4"	16 1/2"	8"	1 1/2"	1"	6"	1 3/4"	13/32"	16 1/2"	8"	1 1/2"	1"	6"	13/32"	28 GAUGE	3/4" DIA. X 2 3/4"	5 3/4"	6"	7"	1"	1 3/4"	3/4"	3 1/2"	13/32"	5/8"	140
W12X26	3/4" DIA. X 4 3/4"	18 1/2"	9"	1 1/2"	1"	7"	1 3/4"	13/32"	18 1/2"	9"	1 1/2"	1"	7"	13/32"	28 GAUGE	3/4" DIA. X 2 3/4"	6 1/2"	6"	7"	1"	1 3/4"	3/4"	3 1/2"	13/32"	5/8"	176
W14X30	1" DIA. X 5"	22"	9"	2"	1 1/2"	6"	2"	17/32"	22"	9"	2"	1 1/2"	6"	17/32"	28 GAUGE	1" DIA. X 3"	6 3/4"	7"	8"	1 1/4"	2"	1"	4"	17/32"	5/8"	205
W16X31	1" DIA. X 5"	24"	9"	2"	1 1/2"	6"	2"	17/32"	24"	9"	2"	1 1/2"	6"	17/32"	28 GAUGE	1" DIA. X 3 1/4"	5 1/2"	7"	8"	1 1/4"	2"	1"	4"	17/32"	3/4"	223
W18X35	1" DIA. X 5"	25"	9"	2"	1 1/2"	6"	2"	17/32"	25"	9"	2"	1 1/2"	6"	17/32"	28 GAUGE	1" DIA. X 3 1/4"	6"	7"	8"	1 1/4"	2"	1"	4"	17/32"	3/4"	243
W18X40	1" DIA. X 5 1/2"	26"	9"	2"	1 1/2"	6"	2 1/4"	17/32"	26"	9"	2"	1 1/2"	6"	17/32"	28 GAUGE	1" DIA. X 3 3/4"	6"	7"	8"	1 1/4"	2"	1"	4"	17/32"	7/8"	278
W21X44	1" DIA. X 5 1/2"	29"	9"	2"	1 1/2"	6"	2 1/2"	17/32"	29"	9"	2"	1 1/2"	6"	17/32"	28 GAUGE	1" DIA. X 3 3/4"	6 1/2"	7"	8"	1 1/4"	2"	1"	4"	17/32"	7/8"	310

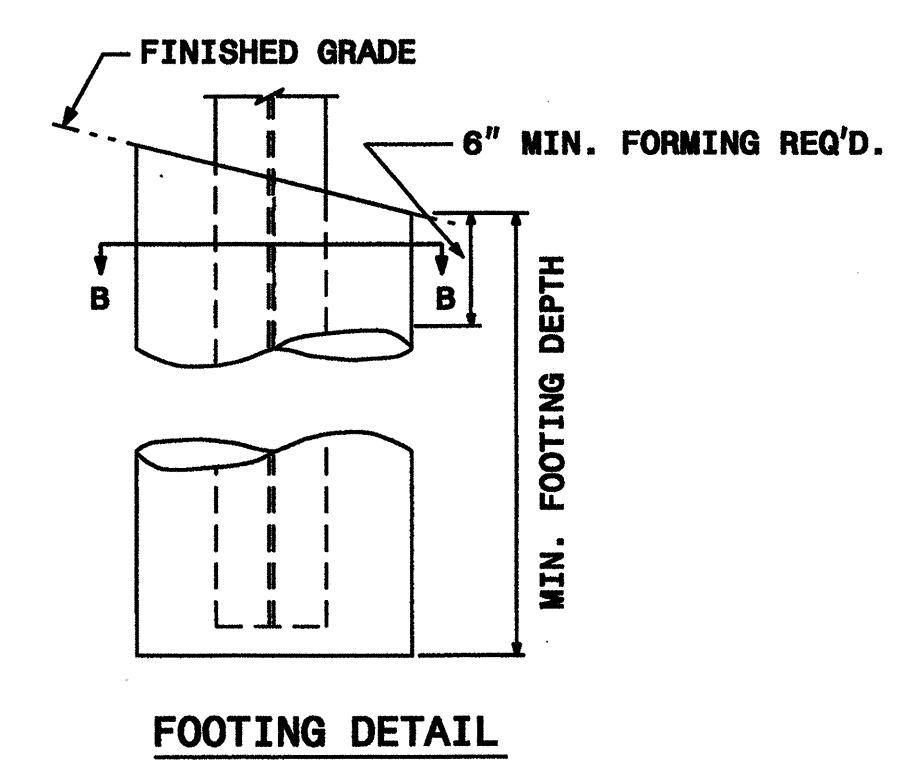
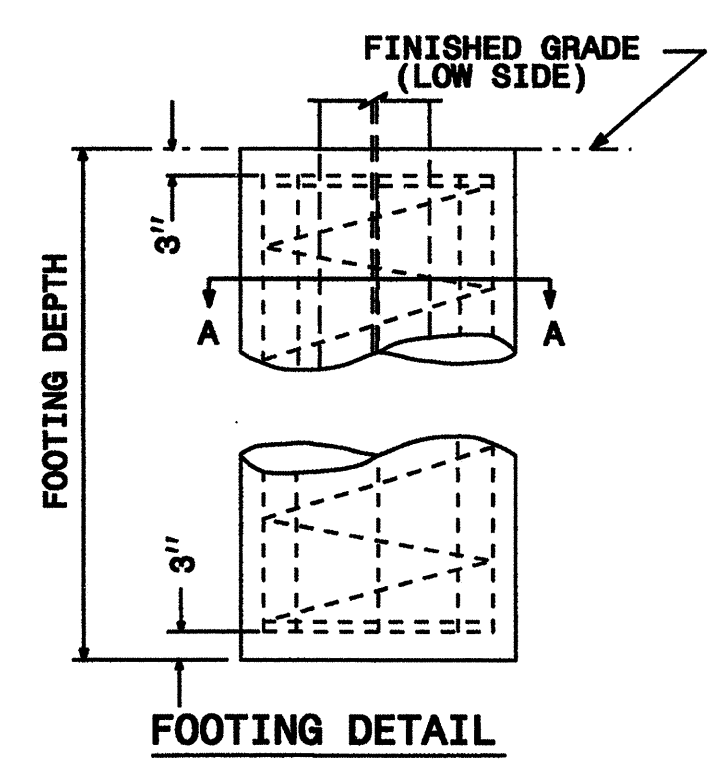
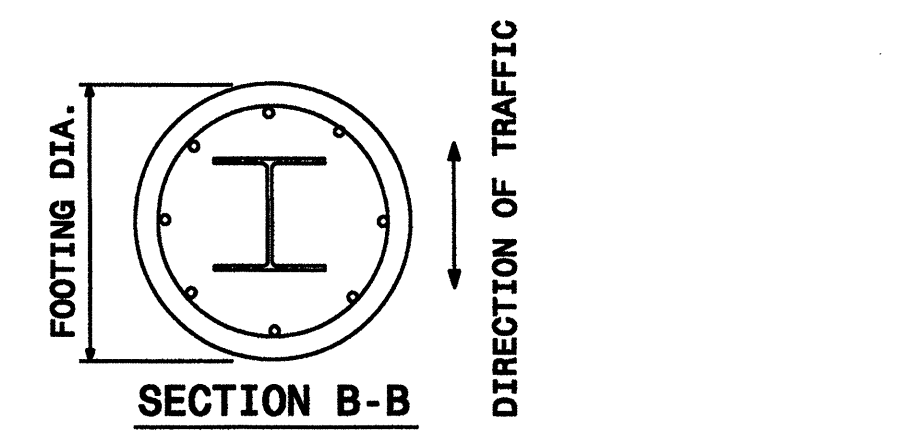
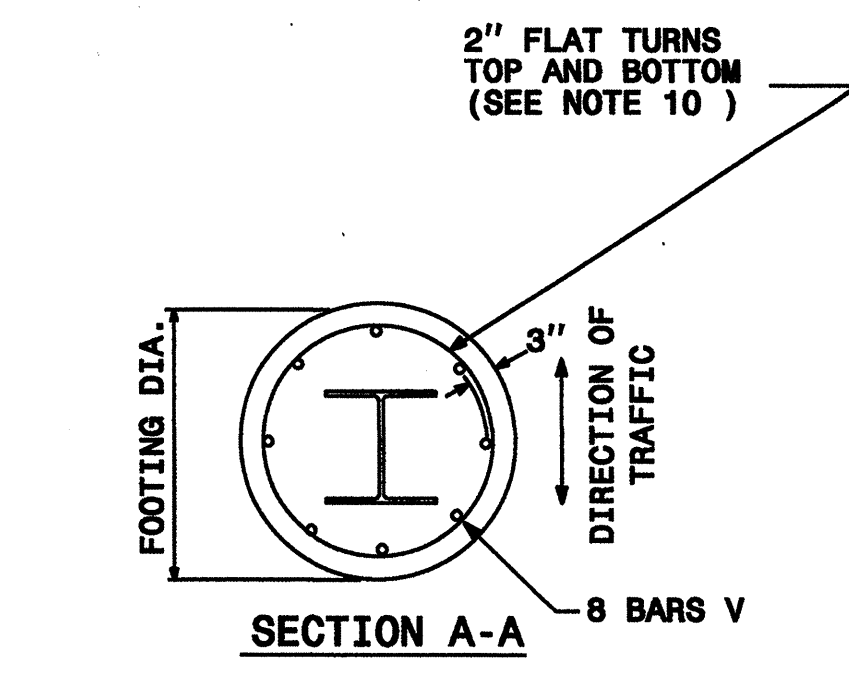

FOOTING DIAMETER	REINFORCEMENT	SPIRAL BAR
1' 6"	8 # 6 BARS	#3 BAR, 6" PITCH
2'	8 # 7 BARS	#3 BAR, 6" PITCH
2' 6"	8 # 9 BARS	#3 BAR, 6" PITCH
3'	8 # 11 BARS	#3 BAR, 6" PITCH
3' 6"	8 # 12 BARS	#3 BAR, 6" PITCH
4'	8 # 14 BARS	#3 BAR, 6" PITCH

\* FOUNDATION DIMENSIONS ARE SHOWN IN PLANS

STATE OF NORTH CAROLINA  
DEPT. OF TRANSPORTATION  
DIVISION OF HIGHWAYS  
RALEIGH, N.C.

ENGLISH DETAIL DRAWING FOR  
GROUND MOUNTED SIGN SUPPORTS

SHEET 2 OF 3  
903D10

08-MAR-2012 11:04:00 ds Group PMP\2012 Standard Drawings\Standard Dwg 8-17-11\Revised\0903D10.sgn\_sht02.dgn support\_t\_revised\_sealed.dgn

APPROVED: *[Signature]*

DATE: 4-23-13

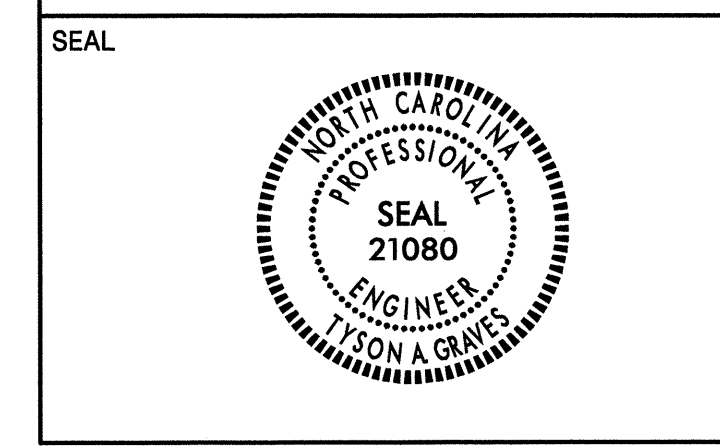

SIGN NO.	SIGN TYPE	SIGN SIZE (in.)			ROADWAY STATION	NO. OF SUP.	BEAM SECTION	SUPPORT TYPE BA or S	ATTACH METHOD	MOUNTING METHOD	HORIZ. CLR. (ft.)	LENGTH (ft)			LEFT SUPPORT (ft)			CENTER SUPPORT (ft)			RIGHT SUPPORT (ft)			FOOTING DIAMETE (ft.)	FOOTING DEPTH (ft.)	B/A SUPPORT WEIGHTS (lbs.)	SIMPLE SUPPORT WEIGHTS (lbs.)	REINF. FTGS. (c.y.)	PLAIN FTGS. (c.y.)	FIELD VERIFIED SEE NOTE 2 (mm/dd/yy)																		
		w	x	h								SNS HT	MTG HT	EMBED MENT	S	L	TOTAL LENGTH	S	L	TOTAL LENGTH	S	L	TOTAL LENGTH																									
101	B	120	X	42	1420+50	2	W6x12	BA	N/A	N/A	10.00	3.50	12.42	4	5.42	10.50	14.50	0.00	0.00	0.00	1.40	17.32	21.32	1.5	4.5	515.23	0.00	0.59	0.00																			
102	A	156	X	138	51+90	2	W8x21	S	N/A	N/A	11.00	11.50	7.00	6	5.17	21.67	27.67	0.00	0.00	0.00	1.54	20.04	26.04	2	6.5	0.00	1127.91	1.51	0.00																			
103	A	192	X	180	50+50	2	W10x26	BA	N/A	N/A	10.00	15.00	7.00	6.5	0.64	22.64	29.14	0.00	0.00	0.00	0.85	22.85	29.35	2.5	7	1808.90	0.00	2.55	0.00																			
104	A	90	X	54	1439+00	2	S4x7.7	BA	N/A	N/A	15.00	4.50	7.00	4	2.15	13.65	17.65	0.00	0.00	0.00	0.50	12.00	16.00	1	4.5	299.71	0.00	0.00	0.26																			
105	A	108	X	60	1441+00	2	W6x12	BA	N/A	N/A	10.00	5.00	11.59	4	1.92	14.67	18.67	0.00	0.00	0.00	-4.59	12.00	16.00	1.5	4.5	501.40	0.00	0.59	0.00																			
106	A	192	X	180	15+50	2	W14x30	BA	N/A	N/A	10.00	15.00	9.96	6.5	1.80	23.16	29.66	0.00	0.00	0.00	-2.96	22.00	28.50	3	7	2229.79	0.00	3.67	0.00																			
107	A	102	X	54	1434+50	2	S4x7.7	BA	N/A	N/A	7.00	4.50	7.50	4	0.50	11.50	15.50	0.00	0.00	0.00	-0.47	11.53	15.53	1	4.5	279.54	0.00	0.00	0.26																			
108	A	108	X	60	1443+50	2	W6x9	BA	N/A	N/A	10.00	5.00	7.51	4	0.51	12.00	16.00	0.00	0.00	0.00	1.19	13.71	17.71	1.5	4.5	366.47	0.00	0.59	0.00																			
901	A	90	X	72	12+80	2	W6x9	BA	N/A	N/A	15.00	5.00	7.00	4	2.06	15.06	19.06	0.00	0.00	0.00	2.80	15.80	19.80	1.5	4.5	412.86	0.00	0.59	0.00																			
902	A	90	X	84	13+80	2	W6x12	BA	N/A	N/A	15.00	7.00	7.00	4.5	1.57	15.57	20.07	0.00	0.00	0.00	2.31	16.31	20.81	1.5	5	575.92	0.00	0.65	0.00																			
903	A	90	X	72	10+50	2	W6x12	BA	N/A	N/A	15.00	5.00	7.00	4	1.86	14.86	18.86	0.00	0.00	0.00	2.96	15.96	19.96	1.5	4.5	551.20	0.00	0.59	0.00																			
904	A	90	X	84	12+00	2	W6x12	BA	N/A	N/A	15.00	7.00	7.00	4.5	1.86	15.86	20.36	0.00	0.00	0.00	2.96	16.96	21.46	1.5	5	587.20	0.00	0.65	0.00																			
201	A	60	X	60	28+00	2	S3x5.7	BA	N/A	N/A	10.00	5.00	7.00	3.5	0.20	12.20	15.70	0.00	0.00	0.00	1.20	13.20	16.70	1	4	220.21	0.00	0.00	0.23																			
202	A	60	X	60	11+00	2	S4x7.7	BA	N/A	N/A	10.00	5.00	7.00	3.5	2.50	14.50	18.00	0.00	0.00	0.00	2.50	14.50	18.00	1	4	317.81	0.00	0.00	0.23																			
																								TOTAL	8666.26	TOTAL	1127.91	TOTAL	11.98	TOTAL	0.99																	
																								USE:	8667	1128	12	1																				

NOTES

- DIMENSION "S" REPRESENTS AN INCREASE (+), OR A DECREASE (-) IN POLE LENGTH, RELATIVE TO THE ELEVATION OF THE EDGE OF PAVEMENT.
- FIELD VERIFICATIONS SHALL BE REQUIRED FOR ALL SUPPORTS, SEE (\*) ARTICLE 903-3. FABRICATORS SHALL BE AISC CERTIFIED IN CATEGORY 1, SEE (\*) ARTICLE 1072-1. (\*) = N.C.D.O.T. STANDARD SPECIFICATIONS FOR ROADS AND STRUCTURES
- PLAN LOCATIONS FOR EXISTING UTILITIES ARE BASED ON THE BEST AVAILABLE INFORMATION AND, THEREFORE MAY NOT BE PRECISELY ACCURATE. THEREFORE, IT IS INCUMBENT UPON THE CONTRACTOR TO DETERMINE THE EXACT LOCATION OF UTILITIES BEFORE BEGINNING WORK IN A LOCATION.

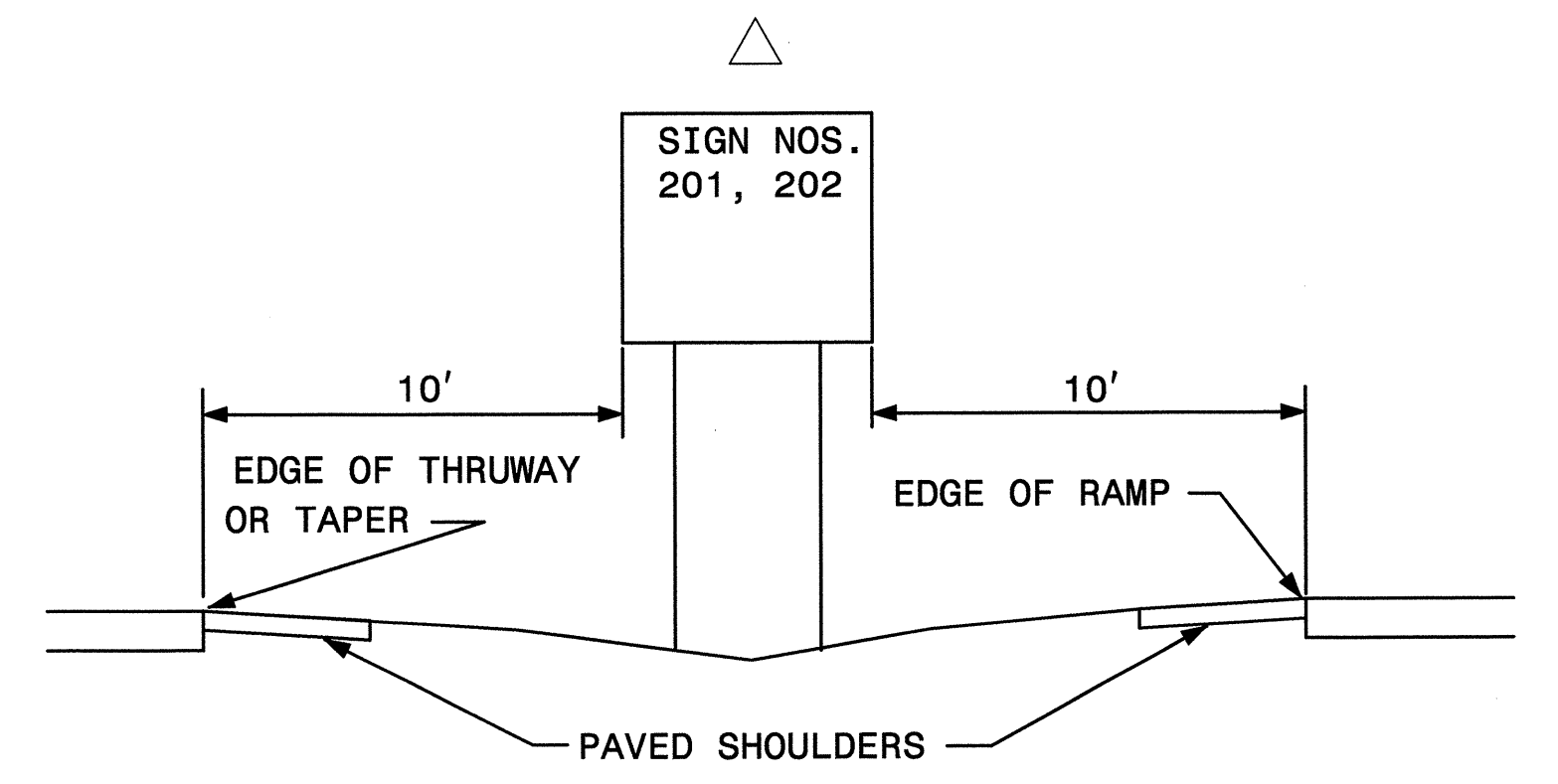
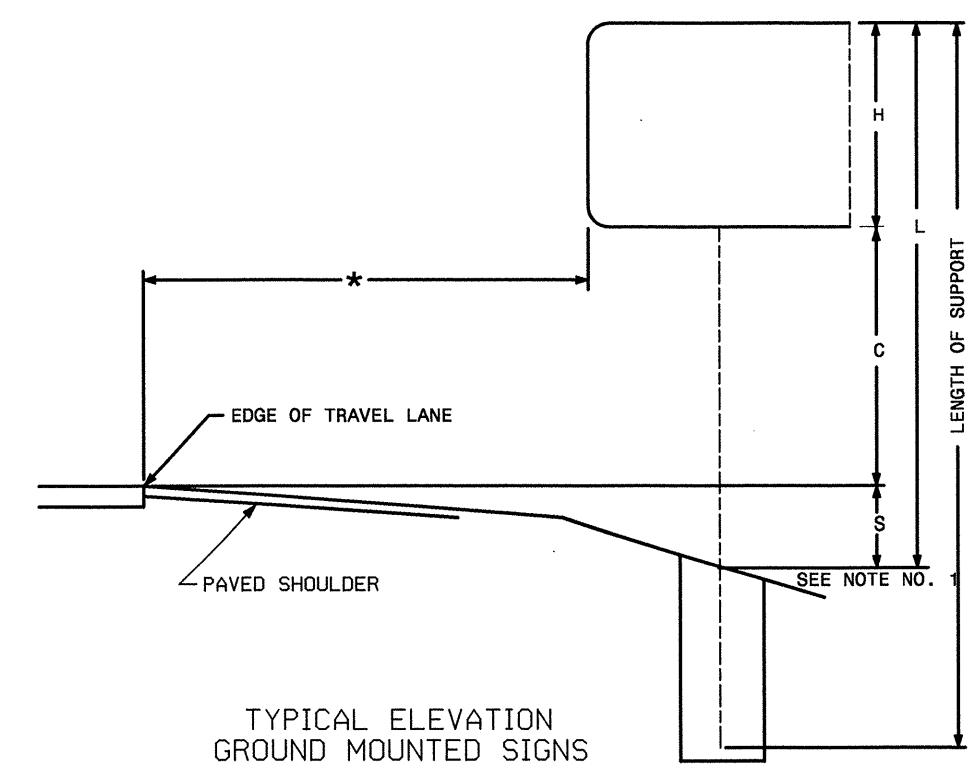

**TYPE "A" AND TYPE "B" GROUND MOUNTED SIGNS**

5/1/2013 P:\Signing\Delination\R-2303D\Signing\2303d-sign-support.t.dgn Florence & Hutchison

APPROVED: *[Signature]*

DATE: 4-23-13

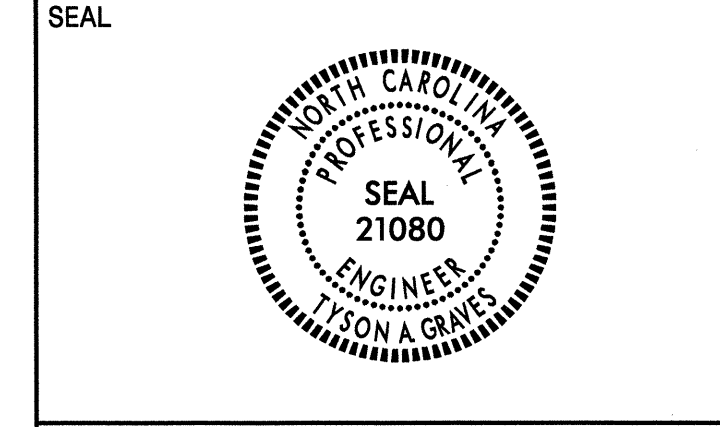

401 QUANTITY REQ'D .17

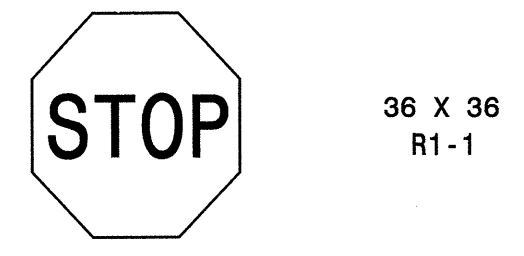

ONE "U" POST PER SIGN  
MOUNT BELOW SIGN 402  
IN 9 INSTALLATIONS

402 QUANTITY REQ'D .9



TWO "U" POSTS PER SIGN

403 QUANTITY REQ'D .8

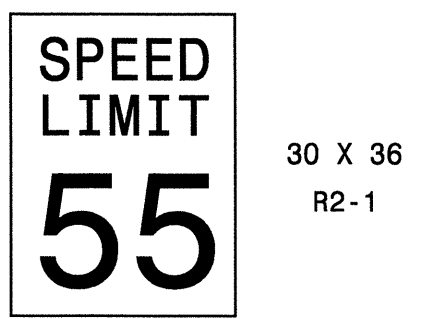

ONE "U" POST PER SIGN

404 QUANTITY REQ'D .10

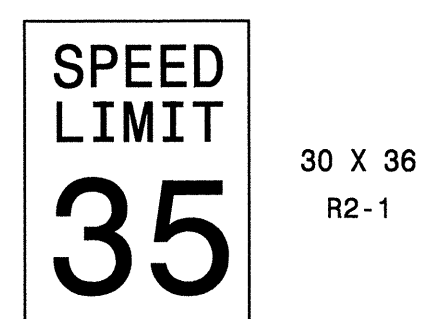

ONE "U" POST PER SIGN

405 QUANTITY REQ'D .6

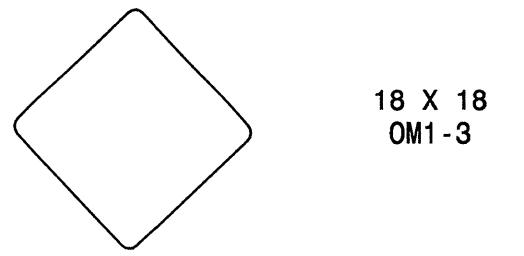

ONE "U" POST PER SIGN  
(RED COLOR)

406 QUANTITY REQ'D .2

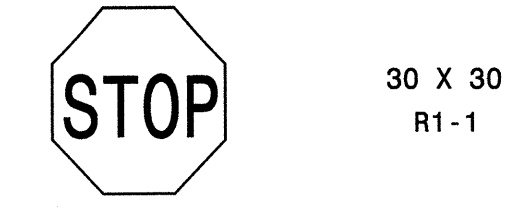

ONE "U" POST PER SIGN

407 QUANTITY REQ'D .7



TWO "U" POSTS PER SIGN

408 QUANTITY REQ'D .1

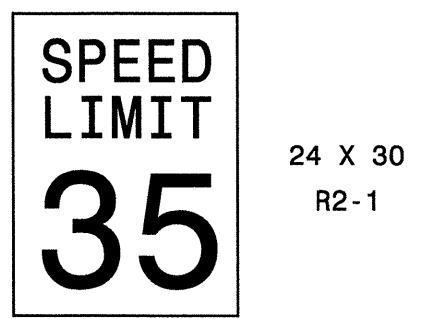

ONE "U" POST PER SIGN

409 QUANTITY REQ'D .10

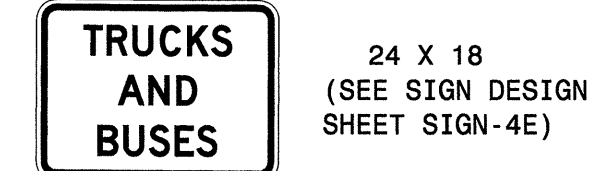

MOUNT BELOW SIGN 410  
IN 10 INSTALLATIONS

410 QUANTITY REQ'D .10



ONE "U" POST PER SIGN

411 QUANTITY REQ'D .4



ONE "U" POST PER SIGN

412 QUANTITY REQ'D .17

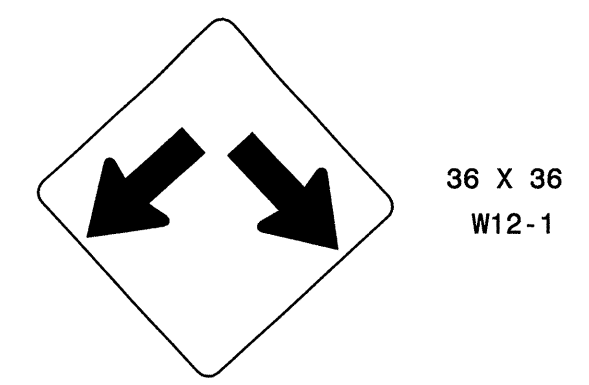

ONE "U" POST PER SIGN

413 QUANTITY REQ'D .2

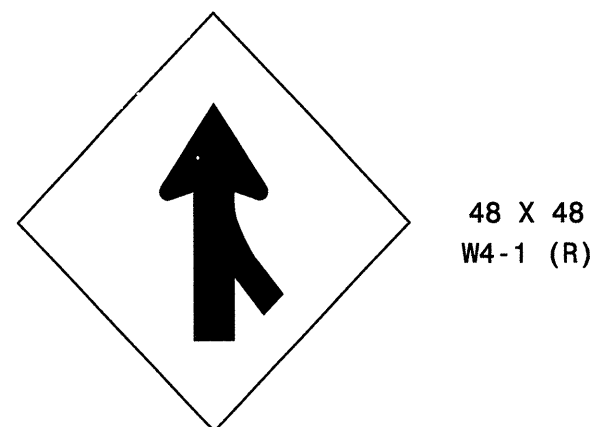

TWO "U" POSTS PER SIGN

414 QUANTITY REQ'D .1

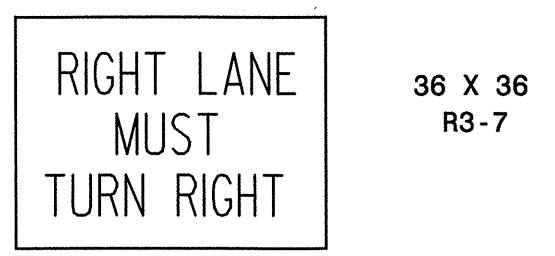

ONE "U" POST PER SIGN

415 QUANTITY REQ'D .4

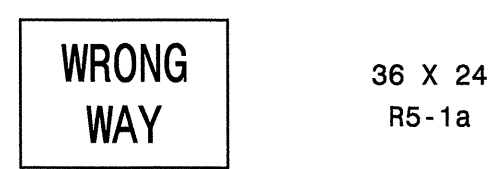

ONE "U" POST PER SIGN

416 QUANTITY REQ'D .8

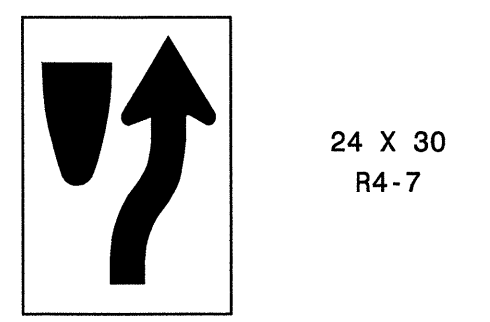

ONE "U" POST PER SIGN

417 QUANTITY REQ'D .4

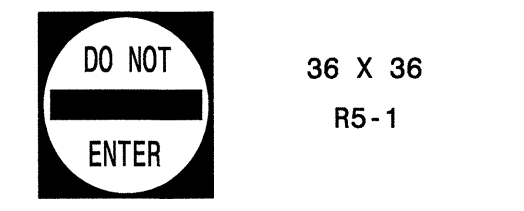

ONE "U" POST PER SIGN

418 QUANTITY REQ'D .2

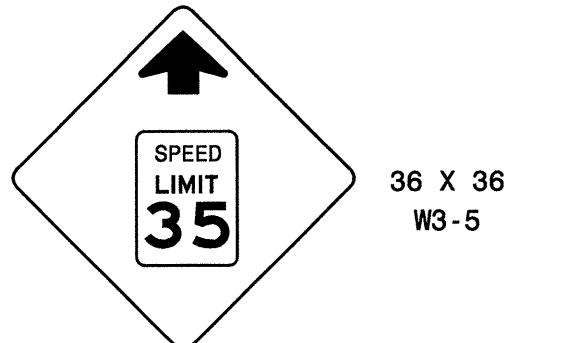

ONE "U" POST PER SIGN

419 QUANTITY REQ'D .7



MOUNT BELOW SIGN 501, 504, 507,  
510, 512, 517, 520  
IN 7 INSTALLATIONS

5/1/2013 P:\Signing\Delimitation\R-2303D\Signing\_Vr-2303d\_e-signs.dgn Florence & Hutcheson

APPROVED: *[Signature]*

DATE: 4-23-13

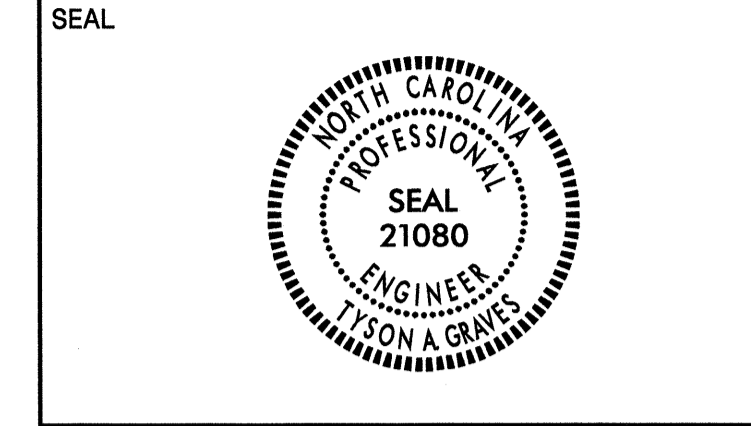

508  
513  
518  
521

EAST 1-24 X 12  
24 1-24 X 24

ONE "U"-POST PER SIGN

503  
509  
514  
522  
527

WEST 1-24 X 12  
24 1-24 X 24

ONE "U"-POST PER SIGN

502  
505  
516  
541

TO 1-24 X 12  
EAST WEST 2-24 X 12  
24 24 2-24 X 24  
→ → 2-21 X 15

TWO "U"-POSTS PER SIGN

523  
524  
528

EAST WEST 2-24 X 12  
24 24 2-24 X 24  
← → 2-21 X 15

TWO "U"-POSTS PER SIGN

501  
504  
510  
517

EAST 1-24 X 12  
24 1-24 X 24  
↻ 419

ONE "U"-POST PER SIGN

525  
526  
529

WEST EAST 2-24 X 12  
24 24 2-24 X 24  
← → 2-21 X 15

TWO "U"-POSTS PER SIGN

506  
511  
515  
519

TO 1-24 X 12  
WEST EAST 2-24 X 12  
24 24 2-24 X 24  
→ → 2-21 X 15

TWO "U"-POSTS PER SIGN

540

JCT 1-21 X 15  
421 1-30 X 24  
701 1-30 X 24  
24 1-24 X 24

ONE "U"-POST PER SIGN

507  
512  
520

WEST 1-24 X 12  
24 1-24 X 24  
↻ 419

ONE "U"-POST PER SIGN

535

WEST 1-24 X 12  
24 1-24 X 24  
→ 1-21 X 15

ONE "U"-POST PER SIGN

534

SOUTH 1-24 X 12  
421 1-30 X 24  
EAST 1-24 X 12  
701 24 1-30 X 24  
1-24 X 24  
← ← 2-21 X 15

TWO "U"-POSTS PER SIGN

537

WEST 1-24 X 12  
24 1-24 X 24  
← 1-21 X 15

ONE "U"-POST PER SIGN

530

JCT 1-21 X 15  
421 1-30 X 24  
701 1-30 X 24

ONE "U"-POST PER SIGN

531

EAST 1-24 X 12  
24 1-24 X 24  
↻ 1-21 X 15  
NORTH SOUTH 2-24 X 12  
421 421 2-30 X 24  
701 701 2-30 X 24  
↑ ↗ 2-21 X 15

TWO "U"-POSTS PER SIGN

532

EAST 1-24 X 12  
24 1-24 X 24  
↻ 1-21 X 15  
NORTH SOUTH 2-24 X 12  
421 421 2-30 X 24  
701 701 2-30 X 24  
↑ ↗ 2-21 X 15

TWO "U"-POSTS PER SIGN

533

NORTH 1-24 X 12  
421 1-30 X 24  
701 1-30 X 24  
↙ 1-21 X 15

ONE "U"-POST PER SIGN

536

NORTH 1-24 X 12  
421 1-30 X 24  
701 1-30 X 24  
← 1-21 X 15

ONE "U"-POST PER SIGN

538

WEST 1-24 X 12  
24 1-24 X 24  
1-24 X 12 SOUTH ↑ 1-21 X 15  
1-30 X 24 421 EAST 1-24 X 12  
1-30 X 24 701 24 1-24 X 24  
1-21 X 15 ← ← 1-21 X 15

TWO "U"-POSTS PER SIGN

539

SOUTH NORTH 2-24 X 12  
421 421 2-30 X 12  
701 701 2-30 X 24  
↑ → 2-21 X 15

TWO "U"-POSTS PER SIGN

5/1/2013 2:58pm R-2303D\Signting\--2303d.f.\_signs.dgn Florence & Hutcheson

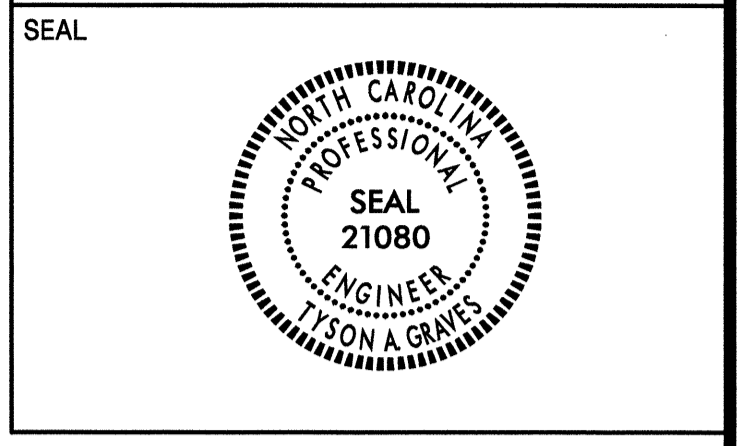

**SIGN NUMBER:** 101 **BACKG COLOR:** Green **DESIGN BY:** GEP **CHECKED BY:**   
**TYPE:** B **COPY COLOR:** White **PROJECT ID:** R-2303D **DIV:** DIV 3 **DATE:** Oct 18, 2012

**QUANTITY:** 1

SYMBOL	X	Y	WID	HT

**SIGN WIDTH:** 10'-0" **HEIGHT:** 3'-6" **TOTAL AREA:** 35.0 Sq.Ft.

**BORDER TYPE:** FLUSH **RECESS:** 0" **WIDTH:** 1.75" **RADII:** 6"

**NO. Z BARS:** 2 **LENGTH:** 112.0 **MAT'L:** 0.125" (3.2 mm) ALUMINUM

**USE NOTES:** 1,2

- Legend and border(except those that are colored black) shall be direct applied Grade C sheeting.
- Background shall be Grade C reflective sheeting.
- Shields; A, B, and C type arrows shall be on 0.032" (0.8mm) aluminum and demountable.

**LETTER POSITIONS**

Letter spacings are to start of next letter												Series/Size
												Text Length
10.6	7.9	7	7	7.8	7	7.9	5.2	5.4	5.4	5.4	5.4	EM 2000
1	1											55.4
98.8	4.5	2.4	14.3									EM 2000
	F	a	y	e	t	t	e	v	i	l	l	6.9
10.6	7.4	7.6	8.4	7	5.9	6	6.9	8.5	4.8	4.8	4.1	EM 2000
	3	3										76.6
95.2	7.7	6.5	10.6									EM 2000
												14.2

FILENAME: sign designs NORTH CAROLINA D.O.T. SIGN DETAIL

**SIGN NUMBER:** 102 **BACKG COLOR:** Green **DESIGN BY:** TAG **CHECKED BY:**   
**TYPE:** A **COPY COLOR:** White **PROJECT ID:** R-2303D **DIV:** DIV 3 **DATE:** Nov 28, 2012

**QUANTITY:** 1

SYMBOL	X	Y	WID	HT
M1-5-2-36-15C	29.3	85.9	36	36

**SIGN WIDTH:** 13'-0" **HEIGHT:** 11'-6" **TOTAL AREA:** 149.5 Sq.Ft.

**BORDER TYPE:** FLUSH **RECESS:** 0" **WIDTH:** 2" **RADII:** 12"

**NO. Z BARS:** 3 **LENGTH:** 148.0 **MAT'L:** 0.125" (3.2 mm) ALUMINUM

**USE NOTES:**

- Legend and border(except those that are colored black) shall be direct applied Grade C sheeting.
- Background shall be Grade C reflective sheeting.
- Shields; A, B, and C type arrows shall be on 0.032" (0.8mm) aluminum and demountable.
- Bottom panel shall be yellow Grade C sheeting. Legend shall be direct applied black non-reflective sheeting. Yellow panel is: 120" X 18"

**LETTER POSITIONS**

Letter spacings are to start of next letter												Series/Size
												Text Length
80.3	11.3	1.5	13.6	11	9	29.3						E 2000
	W	a	r	s	a	w						46.4
32	19.4	17	10.1	14.1	15.2	16.3	32					EM 2000
	1	/	2		M	I	L	E				92
44.7	4.3	11.2	8.1	10	12	4.4	9.2	7.5	44.6			E 2000
	L	E	F	T		E	X	I	T			68.7
32.9	11	11.4	10	9	12	10.7	12.8	4.2	9	32.9		E 2000
												90.1

FILENAME: sign designs NORTH CAROLINA D.O.T. SIGN DETAIL

5/1/2013  
 P:\Signing&Delineation\R-2303D\Signing\R-2303D.dwg  
 Florence & Hutcheson

**SIGN DESIGNS**



APPROVED: *[Signature]*

DATE: 4-23-13

SEAL

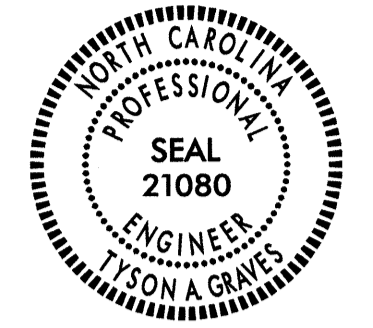

SIGN NUMBER: 103,106  
TYPE: A  
QUANTITY: 2  
SIGN WIDTH: 16'-0"  
HEIGHT: 15'-0"  
TOTAL AREA: 240.0 Sq.Ft.  
BORDER TYPE: FLUSH  
RECESS: 0"  
WIDTH: 2"  
RADII: 12"  
NO. Z BARS: 6  
LENGTH: 184.0

BACKG COLOR: Green  
COPY COLOR: White

SYMBOL	X	Y	WID	HT
M1-5-2-36-15C	45.9	127.9	36	36
AR_Type A	82.4	18.6	20	35

MAT'L: 0.125" (3.2 mm) ALUMINUM

USE NOTES:

- Legend and border(except those that are colored black) shall be direct applied Grade C sheeting.
- Background shall be Grade C reflective sheeting.
- Shields; A, B, and C type arrows shall be on 0.032" (0.8mm) aluminum and demountable.

DESIGN BY: TAG  
PROJECT ID: R-2303D

CHECKED BY:  
DIV: DIV 3

DATE: Nov 30, 2012

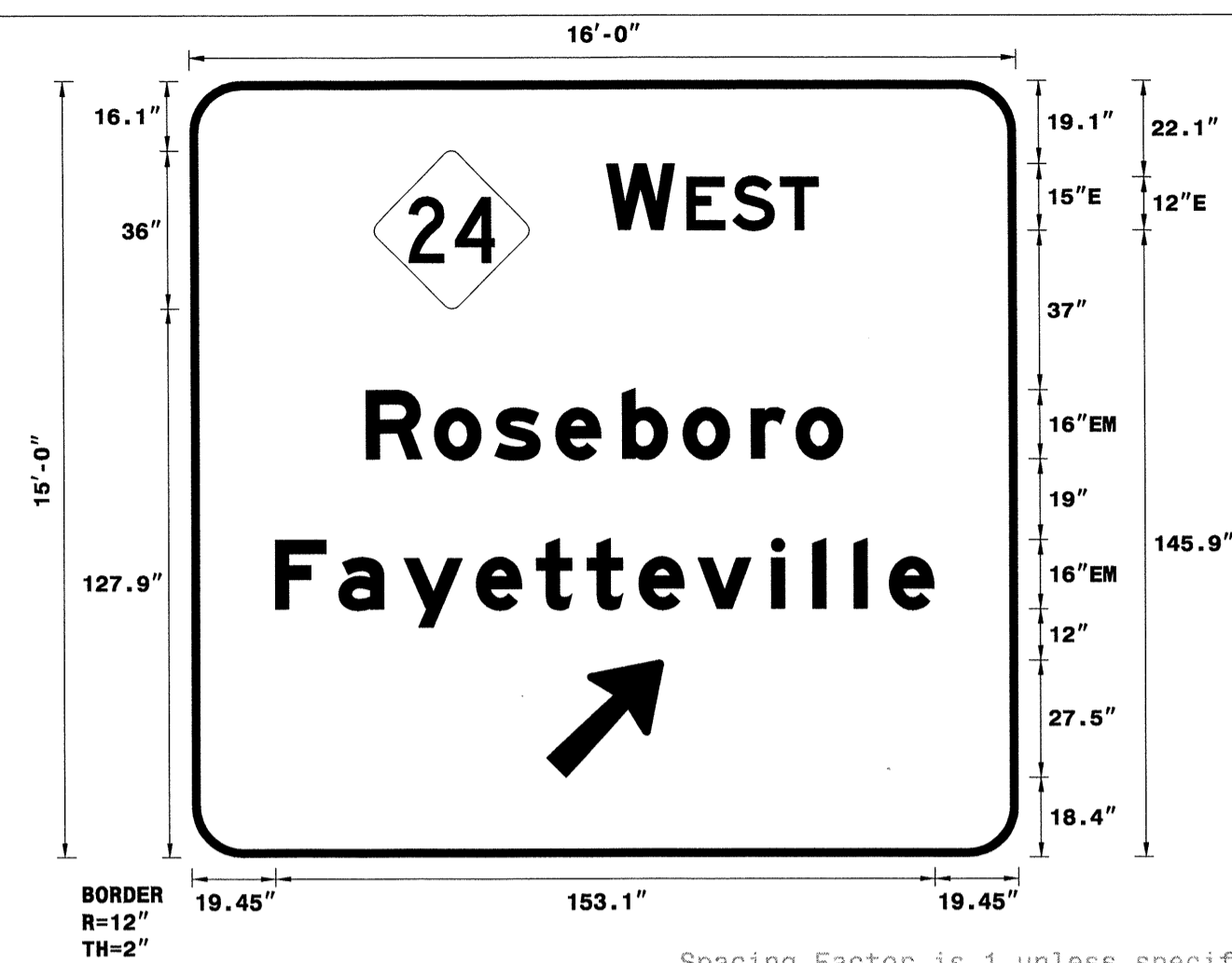

Spacing Factor is 1 unless specified otherwise

LETTER POSITIONS

Letter spacings are to start of next letter													Series/Size	Text Length	
96.8	15.9	2.7	10.7	11	9	45.9								E 2000	49.3
	R	o	s	e	b	o	r	o						EM 2000	110.7
40.6	15.8	14.1	14.1	15.5	14.1	15.8	10.4	10.9	40.6					EM 2000	153.1
	F	a	y	e	t	t	e	v	i	l	l	e			
19.4	14.7	15.2	16.8	13.9	11.8	12	13.8	17	9.6	9.6	8.2	10.6	19.4		

FILENAME: sign designs

NORTH CAROLINA D.O.T. SIGN DETAIL

SIGN NUMBER: 104  
TYPE: A  
QUANTITY: 1  
SIGN WIDTH: 7'-6"  
HEIGHT: 4'-6"  
TOTAL AREA: 33.8 Sq.Ft.  
BORDER TYPE: FLUSH  
RECESS: 0"  
WIDTH: 1"  
RADII: 6"  
NO. Z BARS: 2  
LENGTH: 82.0

BACKG COLOR: Green / Green  
COPY COLOR: White

SYMBOL	X	Y	WID	HT
ARSHRT	9.8	30.8	8	12
ARSHRT	8.8	6.3	8	12

MAT'L: 0.125" (3.2 mm) ALUMINUM

USE NOTES: 1,2

- Legend and border(except those that are colored black) shall be direct applied Grade C sheeting.
- Background shall be Grade C reflective sheeting.
- Shields; A, B, and C type arrows shall be on 0.032" (0.8mm) aluminum and demountable.

DESIGN BY: GEP  
PROJECT ID: R-2303D

CHECKED BY:  
DIV: DIV 3

DATE: Oct 18, 2012

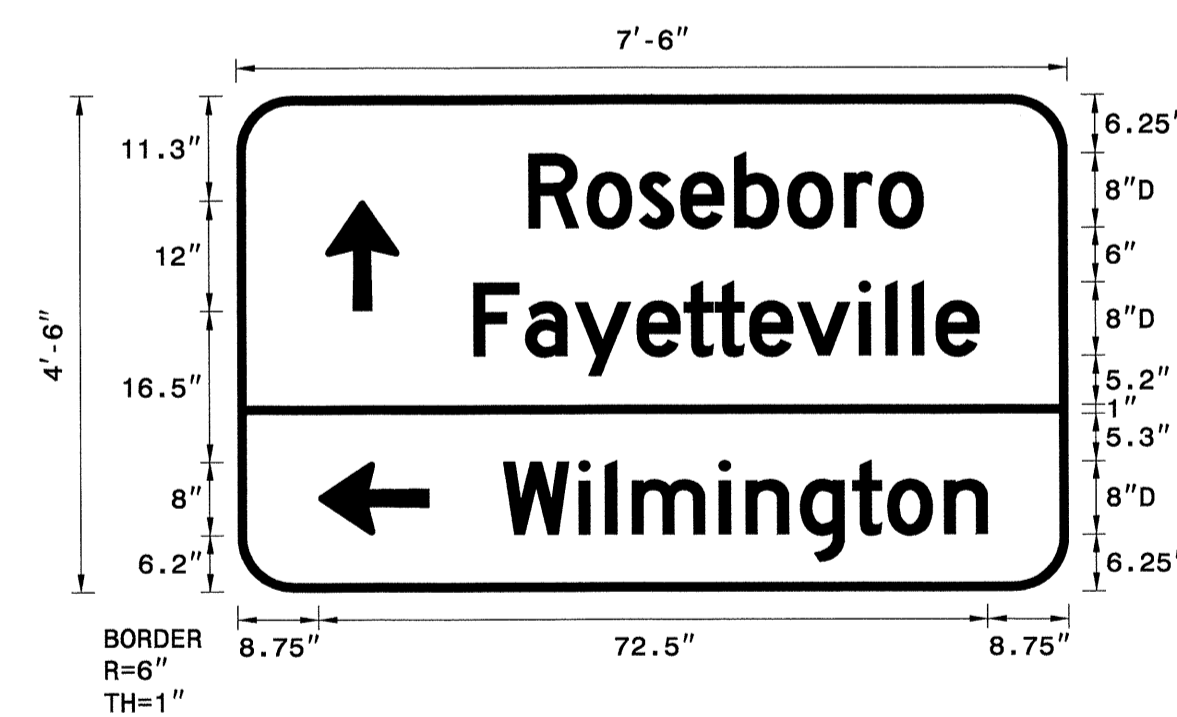

Spacing Factor is 1 unless specified otherwise

LETTER POSITIONS

Letter spacings are to start of next letter													Series/Size	Text Length	
31.6	6.3	5.7	4.5	5.8	5.8	6.2	3.7	4.9	15.6					D 2000	42.8
	R	o	s	e	b	o	r	o						D 2000	54.8
25.6	5.6	5.4	6.6	5.1	3.4	3.8	5.2	6.6	2.9	2.9	2.6	4.7	9.6		
	F	a	y	e	t	t	e	v	i	l	l	e			
28.8	8.2	2.9	2.9	9.4	2.9	5.9	5.7	3.8	6.2	4.7	6.8			D 2000	52.5
	W	i	l	m	i	n	g	t	o	n					

FILENAME: sign designs

NORTH CAROLINA D.O.T. SIGN DETAIL

**SIGN NUMBER:** 105 **BACKG COLOR:** Green / Green **DESIGN BY:** GEP **CHECKED BY:** GEP **DATE:** Oct 18, 2012  
**TYPE:** A **COPY COLOR:** White **PROJECT ID:** R-2303D **DIV:** DIV 3

**QUANTITY:** 1

SYMBOL	X	Y	WID	HT
ARSHRT	29.5	41.3	8	12
ARSHRT	8.4	13.8	8	12

**SIGN WIDTH:** 9'-0" **HEIGHT:** 5'-0" **TOTAL AREA:** 45.0 Sq.Ft.

**BORDER TYPE:** FLUSH **RECESS:** 0" **WIDTH:** 1" **RADII:** 6"

**NO. Z BARS:** 2 **MAT'L:** 0.125" (3.2 mm) ALUMINUM **LENGTH:** 100.0

**USE NOTES:** 1,2

- Legend and border(except those that are colored black) shall be direct applied Grade C sheeting.
- Background shall be Grade C reflective sheeting.
- Shields; A, B, and C type arrows shall be on 0.032" (0.8mm) aluminum and demountable.

Spacing Factor is 1 unless specified otherwise

**LETTER POSITIONS**

Letter spacings are to start of next letter

Series/Size	Text Length
D 2000	33
D 2000	24.2
D 2000	71.3

FILENAME: sign designs NORTH CAROLINA D.O.T. SIGN DETAIL

**SIGN NUMBER:** 107 **BACKG COLOR:** Green / Green **DESIGN BY:** GEP **CHECKED BY:** GEP **DATE:** Oct 18, 2012  
**TYPE:** A **COPY COLOR:** White **PROJECT ID:** R-2303D **DIV:** DIV 3

**QUANTITY:** 1

SYMBOL	X	Y	WID	HT
ARSHRT	7.4	30.8	8	12
ARSHRT	75.2	6.3	8	12

**SIGN WIDTH:** 8'-6" **HEIGHT:** 4'-6" **TOTAL AREA:** 38.3 Sq.Ft.

**BORDER TYPE:** FLUSH **RECESS:** 0" **WIDTH:** 1" **RADII:** 6"

**NO. Z BARS:** 2 **MAT'L:** 0.125" (3.2 mm) ALUMINUM **LENGTH:** 94.0

**USE NOTES:** 1,2

- Legend and border(except those that are colored black) shall be direct applied Grade C sheeting.
- Background shall be Grade C reflective sheeting.
- Shields; A, B, and C type arrows shall be on 0.032" (0.8mm) aluminum and demountable.

Spacing Factor is 1 unless specified otherwise

**LETTER POSITIONS**

Letter spacings are to start of next letter

Series/Size	Text Length
D 2000	24.2
D 2000	71.3
D 2000	52.5

FILENAME: sign designs NORTH CAROLINA D.O.T. SIGN DETAIL

**SIGN NUMBER:** 108 **BACKG COLOR:** Green / Green **DESIGN BY:** GEP **CHECKED BY:** GEP **DATE:** Oct 18, 2012  
**TYPE:** A **COPY COLOR:** White **PROJECT ID:** R-2303D **DIV:** DIV 3

**QUANTITY:** 1

SYMBOL	X	Y	WID	HT
ARSHRT	19.8	41.3	8	12
ARSHRT	87.6	13.7	8	12

**SIGN WIDTH:** 9'-0" **HEIGHT:** 5'-0" **TOTAL AREA:** 45.0 Sq.Ft.

**BORDER TYPE:** FLUSH **RECESS:** 0" **WIDTH:** 1" **RADII:** 6"

**NO. Z BARS:** 2 **MAT'L:** 0.125" (3.2 mm) ALUMINUM **LENGTH:** 100.0

**USE NOTES:** 1,2

- Legend and border(except those that are colored black) shall be direct applied Grade C sheeting.
- Background shall be Grade C reflective sheeting.

Spacing Factor is 1 unless specified otherwise

**LETTER POSITIONS**

Letter spacings are to start of next letter

Series/Size	Text Length
D 2000	52.5
D 2000	24.2
D 2000	71.3

FILENAME: sign designs NORTH CAROLINA D.O.T. SIGN DETAIL

5/1/2013  
 P:\Storming\Delineation\R-2303D\Signing\--2303D\_sign\_design\_sheet3.dgn  
 Florence & Hutcheson



**SIGN NUMBER:** 201,202  
**TYPE:** A  
**QUANTITY:** 2  
**BACKG COLOR:** Green  
**COPY COLOR:** White  
**DESIGN BY:** TAG  
**CHECKED BY:** DIV: DIV 3  
**DATE:** Nov 30, 2012  
**PROJECT ID:** R-2303D

SYMBOL	X	Y	WID	HT
AR_Type A	18.5	7	14.4	30

**SIGN WIDTH:** 5'-0"  
**HEIGHT:** 5'-0"  
**TOTAL AREA:** 25.0 Sq.Ft.  
**BORDER TYPE:** FLUSH  
**RECESS:** 0"  
**WIDTH:** 1.5"  
**RADII:** 8"  
**MAT'L:** 0.125" (3.2 mm) ALUMINUM  
**NO. Z BARS:** 2  
**LENGTH:** 52.0

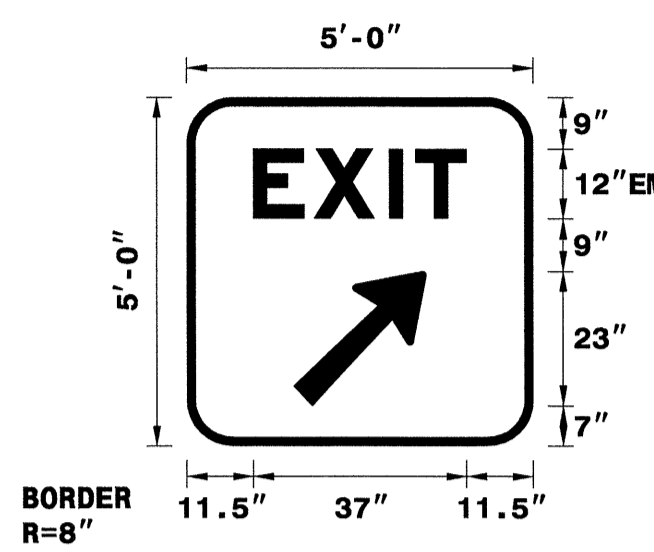

**USE NOTES:**  
 1. Legend and border(except those that are colored black) shall be direct applied Grade C sheeting.  
 2. Background shall be Grade C reflective sheeting.  
 3. Shields; A, B, and C type arrows shall be on 0.032" (0.8mm) aluminum and demountable.

Spacing Factor is 1 unless specified otherwise

**LETTER POSITIONS**

Letter spacings are to start of next letter							Series/Size	Text Length
	E	X	I	T			EM 2000	
	11.5	10.6	13	4.6	8.9	11.5	37	

FILENAME: sign designs NORTH CAROLINA D.O.T. SIGN DETAIL

**SIGN NUMBER:** 301  
**TYPE:** D  
**QUANTITY:** 1  
**BACKG COLOR:** Green  
**COPY COLOR:** White  
**DESIGN BY:** TAG  
**CHECKED BY:** DIV: DIV 3  
**DATE:** Oct 18, 2012  
**PROJECT ID:** R-2303D

SYMBOL	X	Y	WID	HT
ARMED	74.5	12.4	6	9

**SIGN WIDTH:** 7'-6"  
**HEIGHT:** 2'-6"  
**TOTAL AREA:** 18.8 Sq.Ft.  
**BORDER TYPE:** FLUSH  
**RECESS:** 0"  
**WIDTH:** 0.75"  
**RADII:** 2.25"  
**MAT'L:** 0.125" (3.2 mm) ALUMINUM  
**NO. Z BARS:** 1  
**LENGTH:**

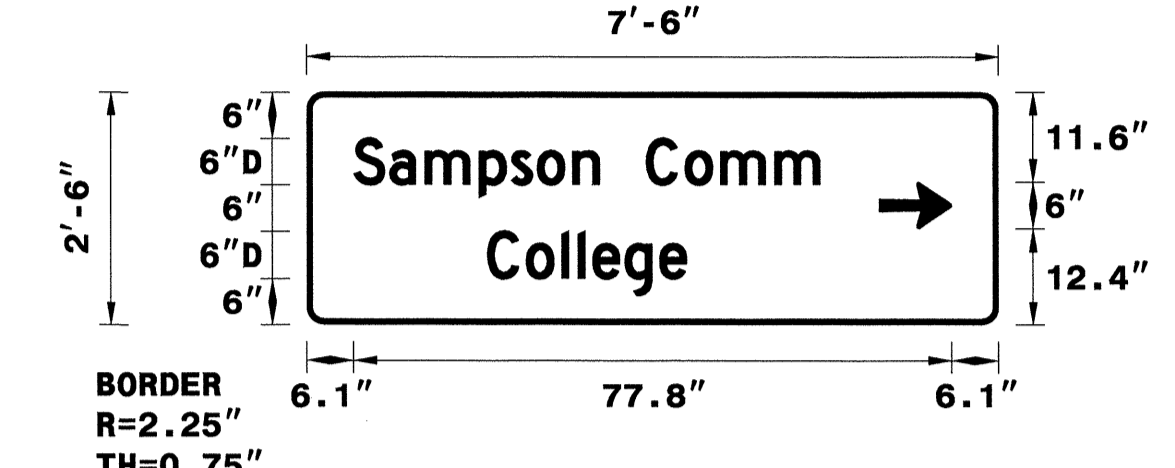

**USE NOTES:** 1,2  
 1. Legend and border(except those that are colored black) shall be direct applied Grade C sheeting.  
 2. Background shall be Grade C reflective sheeting.

Spacing Factor is 1 unless specified otherwise

**LETTER POSITIONS**

Letter spacings are to start of next letter													Series/Size	Text Length
	S	a	m	p	s	o	n	C	o	m	m		D 2000	
	6.1	4.7	4.8	7.1	4.2	3.4	4.6	3.5	6	5	4.6	7.1	5.9	23.2
	23.5	5	4.6	2.2	1.9	4.1	4.6	3.5	40.6				26	

FILENAME: sign designs NORTH CAROLINA D.O.T. SIGN DETAIL

**SIGN NUMBER:** 302  
**TYPE:** D  
**QUANTITY:** 1  
**BACKG COLOR:** Green  
**COPY COLOR:** White  
**DESIGN BY:** TAG  
**CHECKED BY:** DIV: DIV 3  
**DATE:** Oct 18, 2012  
**PROJECT ID:** R-2303D

SYMBOL	X	Y	WID	HT
ARMED	6.9	6	8	9

**SIGN WIDTH:** 4'-6"  
**HEIGHT:** 1'-6"  
**TOTAL AREA:** 6.8 Sq.Ft.  
**BORDER TYPE:** FLUSH  
**RECESS:** 0"  
**WIDTH:** 0.75"  
**RADII:** 1.5"  
**MAT'L:** 0.125" (3.2 mm) ALUMINUM  
**NO. Z BARS:** 1  
**LENGTH:**

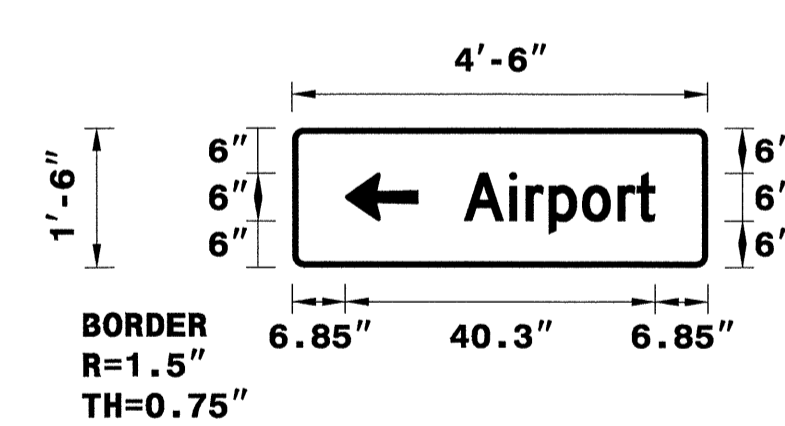

**USE NOTES:** 1,2  
 1. Legend and border(except those that are colored black) shall be direct applied Grade C sheeting.  
 2. Background shall be Grade C reflective sheeting.

Spacing Factor is 1 unless specified otherwise

**LETTER POSITIONS**

Letter spacings are to start of next letter										Series/Size	Text Length
	A	i	r	p	o	r	t			D 2000	
	22.3	5.9	2.2	3	4.3	4.8	2.5	2.4	6.9	24.8	

FILENAME: sign designs NORTH CAROLINA D.O.T. SIGN DETAIL

**SIGN NUMBER:** 303  
**TYPE:** D  
**QUANTITY:** 1  
**BACKG COLOR:** Green  
**COPY COLOR:** White  
**DESIGN BY:** TAG  
**CHECKED BY:** DIV: DIV 3  
**DATE:** Oct 18, 2012  
**PROJECT ID:** R-2303D

SYMBOL	X	Y	WID	HT
ARMED	6.1	12	6	9

**SIGN WIDTH:** 7'-6"  
**HEIGHT:** 2'-6"  
**TOTAL AREA:** 18.8 Sq.Ft.  
**BORDER TYPE:** FLUSH  
**RECESS:** 0"  
**WIDTH:** 0.75"  
**RADII:** 2.25"  
**MAT'L:** 0.125" (3.2 mm) ALUMINUM  
**NO. Z BARS:** 1  
**LENGTH:**

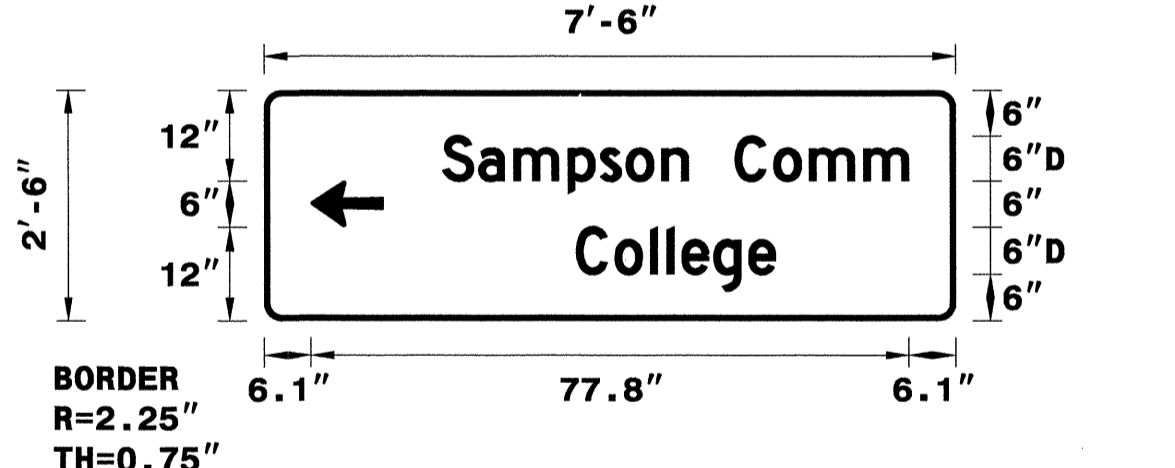

**USE NOTES:** 1,2  
 1. Legend and border(except those that are colored black) shall be direct applied Grade C sheeting.  
 2. Background shall be Grade C reflective sheeting.

Spacing Factor is 1 unless specified otherwise

**LETTER POSITIONS**

Letter spacings are to start of next letter													Series/Size	Text Length
	S	a	m	p	s	o	n	C	o	m	m		D 2000	
	23.2	4.7	4.8	7.1	4.2	3.4	4.6	3.5	6	5	4.6	7.1	5.9	6.1
	40.6	5	4.6	2.2	1.9	4.1	4.6	3.5	23.5				26	

FILENAME: sign designs NORTH CAROLINA D.O.T. SIGN DETAIL

5/6/2013  
 P:\Signing&Delineation\R-2303D\Signing\--2303d--sign\_design\_sheet4.dgn  
 Florence & Hutcheson

**SIGN NUMBER:** 304 **BACKG COLOR:** Green **DESIGN BY:** TAG **CHECKED BY:** **DATE:** Oct 18, 2012  
**TYPE:** D **COPY COLOR:** White **PROJECT ID:** R-2303D **DIV:** DIV 3

SYMBOL	X	Y	WID	HT
ARMED	37.7	6	6	9

**QUANTITY:** 1  
**SIGN WIDTH:** 4'-6"  
**HEIGHT:** 1'-6"  
**TOTAL AREA:** 6.8 Sq.Ft.  
**BORDER TYPE:** FLUSH  
**RECESS:** 0"  
**WIDTH:** 0.75"  
**RADII:** 1.5"  
**MAT'L:** 0.125" (3.2 mm) ALUMINUM

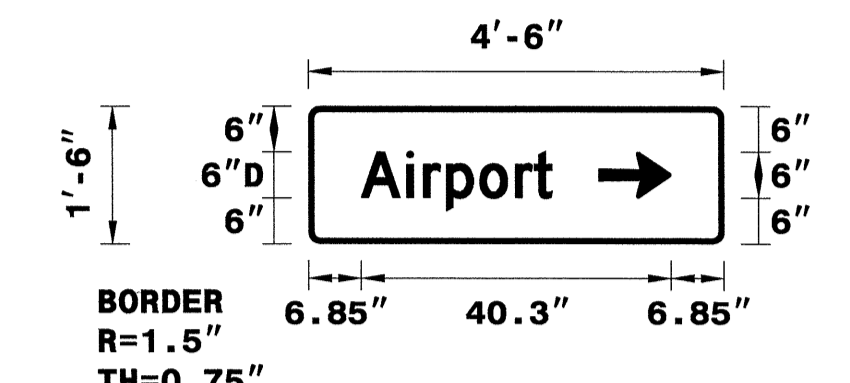

**USE NOTES:** 1,2  
 1. Legend and border(except those that are colored black) shall be direct applied Grade C sheeting.  
 2. Background shall be Grade C reflective sheeting.

Spacing Factor is 1 unless specified otherwise

**LETTER POSITIONS**

Letter spacings are to start of next letter											Series/Size
											Text Length
6.9	5.9	2.2	3	4.3	4.6	2.5	2.4	22.3			D 2000
											24.8

FILENAME: sign designs NORTH CAROLINA D.O.T. SIGN DETAIL

**SIGN NUMBER:** 305 **BACKG COLOR:** Green **DESIGN BY:** TAG **CHECKED BY:** **DATE:** Oct 23, 2012  
**TYPE:** D **COPY COLOR:** White **PROJECT ID:** R-2303D **DIV:** DIV 3

SYMBOL	X	Y	WID	HT

**QUANTITY:** 1  
**SIGN WIDTH:** 3'-0"  
**HEIGHT:** 2'-6"  
**TOTAL AREA:** 7.5 Sq.Ft.  
**BORDER TYPE:** FLUSH  
**RECESS:** 0"  
**WIDTH:** 0.75"  
**RADII:** 2.25"  
**MAT'L:** 0.080" (2 mm) ALUMINUM

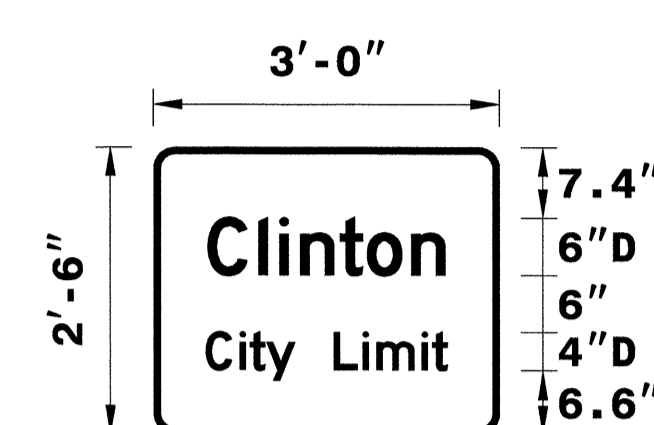

**USE NOTES:** 1,2  
 1. Legend and border(except those that are colored black) shall be direct applied Grade C sheeting.  
 2. Background shall be Grade C reflective sheeting.

Spacing Factor is 1 unless specified otherwise

**LETTER POSITIONS**

Letter spacings are to start of next letter											Series/Size
											Text Length
5.6	5.3	2.2	2.2	4.1	2.8	4.6	3.5	5.6			D 2000
											24.7
5.4	3.5	1.1	1.7	3	4	3	1.4	4.7	1.1	1.8	D 2000
											25.2

FILENAME: sign designs NORTH CAROLINA D.O.T. SIGN DETAIL

**SIGN NUMBER:** 306 **BACKG COLOR:** Green / Green **DESIGN BY:** GEP **CHECKED BY:** **DATE:** Oct 18, 2012  
**TYPE:** D **COPY COLOR:** White **PROJECT ID:** R-2303D **DIV:** DIV 3

SYMBOL	X	Y	WID	HT
ARSHRT	73.9	21.6	6	9
ARSHRT	55.9	3.9	6	9

**QUANTITY:** 1  
**SIGN WIDTH:** 7'-6"  
**HEIGHT:** 3'-0"  
**TOTAL AREA:** 22.5 Sq.Ft.  
**BORDER TYPE:** FLUSH  
**RECESS:** 0"  
**WIDTH:** 0.75"  
**RADII:** 6"  
**MAT'L:** 0.125" (3.2 mm) ALUMINUM

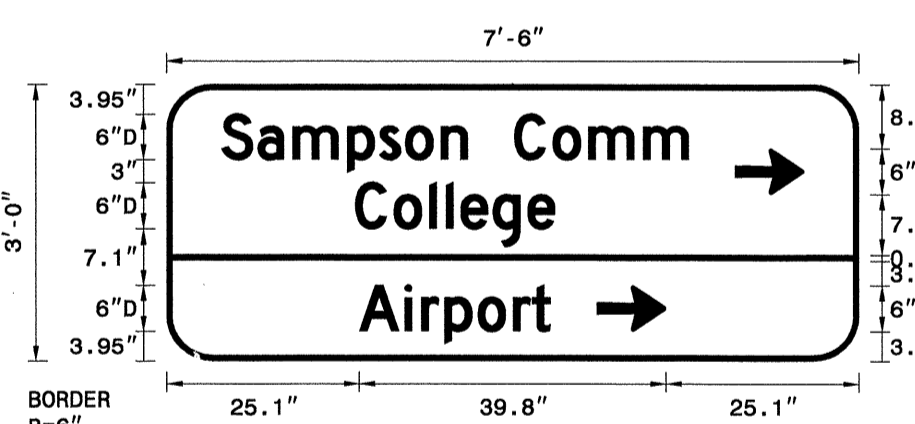

**USE NOTES:** 1,2  
 1. Legend and border(except those that are colored black) shall be direct applied Grade C sheeting.  
 2. Background shall be Grade C reflective sheeting.

Spacing Factor is 1 unless specified otherwise

**LETTER POSITIONS**

Letter spacings are to start of next letter											Series/Size
											Text Length
7.1	4.7	4.6	7.1	4.2	3.4	4.6	3.5	6	5	4.6	D 2000
											60.7
24.5	5	4.6	2.2	1.9	4.1	4.6	3.5	39.5			D 2000
											26
25.1	5.9	2.2	3	4.3	4.6	2.5	2.4	40.1			D 2000
											24.8

FILENAME: sign designs NORTH CAROLINA D.O.T. SIGN DETAIL

**SIGN NUMBER:** 307 **BACKG COLOR:** Green / Green **DESIGN BY:** GEP **CHECKED BY:** **DATE:** Oct 18, 2012  
**TYPE:** D **COPY COLOR:** White **PROJECT ID:** R-2303D **DIV:** DIV 3

SYMBOL	X	Y	WID	HT
ARSHRT	14.6	28.3	6	9
ARSHRT	52.1	9.2	6	9

**QUANTITY:** 1  
**SIGN WIDTH:** 5'-6"  
**HEIGHT:** 3'-6"  
**TOTAL AREA:** 19.3 Sq.Ft.  
**BORDER TYPE:** FLUSH  
**RECESS:** 0"  
**WIDTH:** 0.75"  
**RADII:** 6"  
**MAT'L:** 0.125" (3.2 mm) ALUMINUM

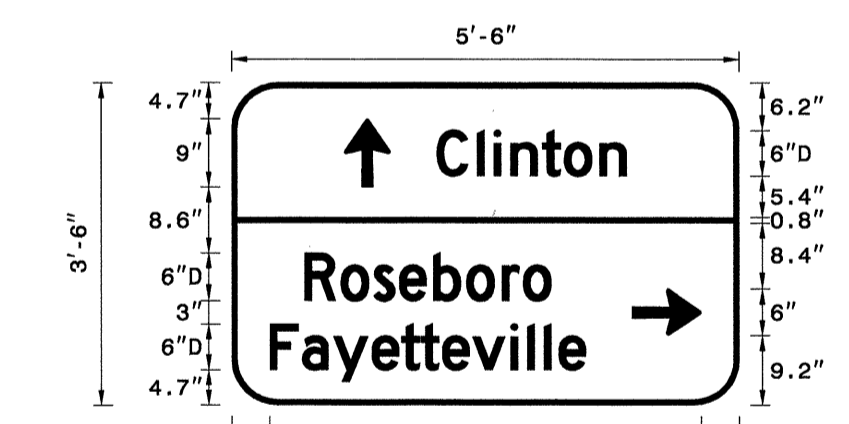

**USE NOTES:** 1,2  
 1. Legend and border(except those that are colored black) shall be direct applied Grade C sheeting.  
 2. Background shall be Grade C reflective sheeting.

Spacing Factor is 1 unless specified otherwise

**LETTER POSITIONS**

Letter spacings are to start of next letter											Series/Size
											Text Length
26.8	5.3	2.2	2.2	4.1	2.8	4.6	3.5	14.6			D 2000
											24.7
9.5	4.7	4.3	3.4	4.4	4.3	4.6	2.8	3.7	24.4		D 2000
											32.1
5	4.2	4.1	5	3.8	2.5	2.8	3.9	5	2.2	2.2	D 2000
											41.1

FILENAME: sign designs NORTH CAROLINA D.O.T. SIGN DETAIL

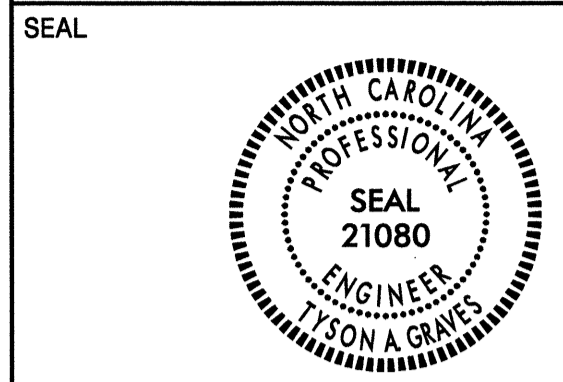

**SIGN NUMBER:** 308  
**TYPE:** D  
**QUANTITY:** 1  
**SIGN WIDTH:** 5'-6"  
**HEIGHT:** 3'-0"  
**TOTAL AREA:** 16.5 Sq.Ft.  
**BORDER TYPE:** FLUSH  
**RECESS:** 0"  
**WIDTH:** 0.75"  
**RADII:** 6"  
**NO. Z BARS:**  
**LENGTH:**

**BACKG COLOR:** Green / Green  
**COPY COLOR:** White

SYMBOL	X	Y	WID	HT
ARSHRT	5.5	21.6	6	9
ARSHRT	43.9	3.9	6	9

**DESIGN BY:** GEP  
**PROJECT ID:** R-2303D  
**CHECKED BY:** DIV: DIV 3  
**DATE:** Oct 18, 2012

**MAT'L:** 0.125" (3.2 mm) ALUMINUM

**USE NOTES:** 1,2  
 1. Legend and border (except those that are colored black) shall be direct applied Grade C sheeting.  
 2. Background shall be Grade C reflective sheeting.

Spacing Factor is 1 unless specified otherwise

**LETTER POSITIONS**

Letter spacings are to start of next letter													Series/Size	Text Length	
24	4.7	4.3	3.4	4.4	4.3	4.6	2.8	3.7	9.9				D 2000	32.1	
													D 2000	41.1	
19.5	4.2	4.1	5	3.8	2.5	2.8	3.9	5	2.2	2.2	1.9	3.5	5.4	D 2000	24.7
13.1	5.3	2.2	2.2	4.1	2.8	4.6	3.5	28.1							

FILENAME: sign designs NORTH CAROLINA D.O.T. SIGN DETAIL

**SIGN NUMBER:** 309  
**TYPE:** D  
**QUANTITY:** 1  
**SIGN WIDTH:** 7'-6"  
**HEIGHT:** 3'-0"  
**TOTAL AREA:** 22.5 Sq.Ft.  
**BORDER TYPE:** FLUSH  
**RECESS:** 0"  
**WIDTH:** 0.75"  
**RADII:** 6"  
**NO. Z BARS:**  
**LENGTH:**

**BACKG COLOR:** Green / Green  
**COPY COLOR:** White

SYMBOL	X	Y	WID	HT
ARSHRT	7.1	21.6	6	9
ARSHRT	25.1	3.9	6	9

**DESIGN BY:** GEP  
**PROJECT ID:** R-2303D  
**CHECKED BY:** DIV: DIV 3  
**DATE:** Oct 18, 2012

**MAT'L:** 0.125" (3.2 mm) ALUMINUM

**USE NOTES:** 1,2  
 1. Legend and border (except those that are colored black) shall be direct applied Grade C sheeting.  
 2. Background shall be Grade C reflective sheeting.

Spacing Factor is 1 unless specified otherwise

**LETTER POSITIONS**

Letter spacings are to start of next letter													Series/Size	Text Length	
22.1	4.7	4.6	7.1	4.2	3.4	4.6	3.5	6	5	4.6	7.1	5.9	7.1	D 2000	60.7
														D 2000	26
39.5	5	4.6	2.2	1.9	4.1	4.6	3.5	24.5						D 2000	24.8
40.1	5.9	2.2	3	4.3	4.6	2.5	2.4	25.1							

FILENAME: sign designs NORTH CAROLINA D.O.T. SIGN DETAIL

**SIGN NUMBER:** 409  
**TYPE:** E  
**QUANTITY:** X  
**SIGN WIDTH:** 2'-0"  
**HEIGHT:** 1'-6"  
**TOTAL AREA:** 3.0 Sq.Ft.  
**BORDER TYPE:** FLUSH  
**RECESS:** 0.47"  
**WIDTH:** 0.63"  
**RADII:** 1.5"  
**NO. Z BARS:**  
**LENGTH:**

**BACKG COLOR:** White  
**COPY COLOR:** Black

SYMBOL	X	Y	WID	HT

**DESIGN BY:** GEP  
**PROJECT ID:** R-2303B  
**CHECKED BY:** DIV: DIV 3  
**DATE:** Oct 17, 2012

**MAT'L:** 0.063" (1.6 mm) ALUMINUM

**USE NOTES:** 1,2  
 1. Legend and border (except those that are colored black) shall be direct applied Grade C sheeting.  
 2. Background shall be Grade C reflective sheeting.

Spacing Factor is 1 unless specified otherwise

**LETTER POSITIONS**

Letter spacings are to start of next letter													Series/Size	Text Length
4.6	2.3	2.5	2.7	2.7	2.4	2	4.7						D 2000	14.7
8.1	3	2.8	2	8.1									D 2000	7.8
6.1	2.5	2.5	2.5	2.2	2	6.1							D 2000	11.9

FILENAME: sign designs NORTH CAROLINA D.O.T. SIGN DETAIL

**SIGN NUMBER:** 419  
**TYPE:** E  
**QUANTITY:** 7

**LETTER POSITIONS**

Letter spacings are to start of next letter													Series/Size	Text Length
4.6	2.3	2.5	2.7	2.7	2.4	2	4.7						D 2000	14.7
8.1	3	2.8	2	8.1									D 2000	7.8
6.1	2.5	2.5	2.5	2.2	2	6.1							D 2000	11.9

**DIMENSIONS (INCHES)**

SIGN	A	B	C	D	E	F	G	H	J	K	L	M	N
SPECIAL	24	1/2	3/4	1/2	6-3/8	3-1/8	3-1/8	7-1/2	2 13/16	1-7/8	5/8	6-1/4	3-5/8

**COLORS**  
 ARROW AND BORDER - BLACK  
 BACKGROUND - WHITE

-L- STA. 1097+00.00  
 BEGIN SIGNING CONSTRUCTION  
 PROJECT R-2303D

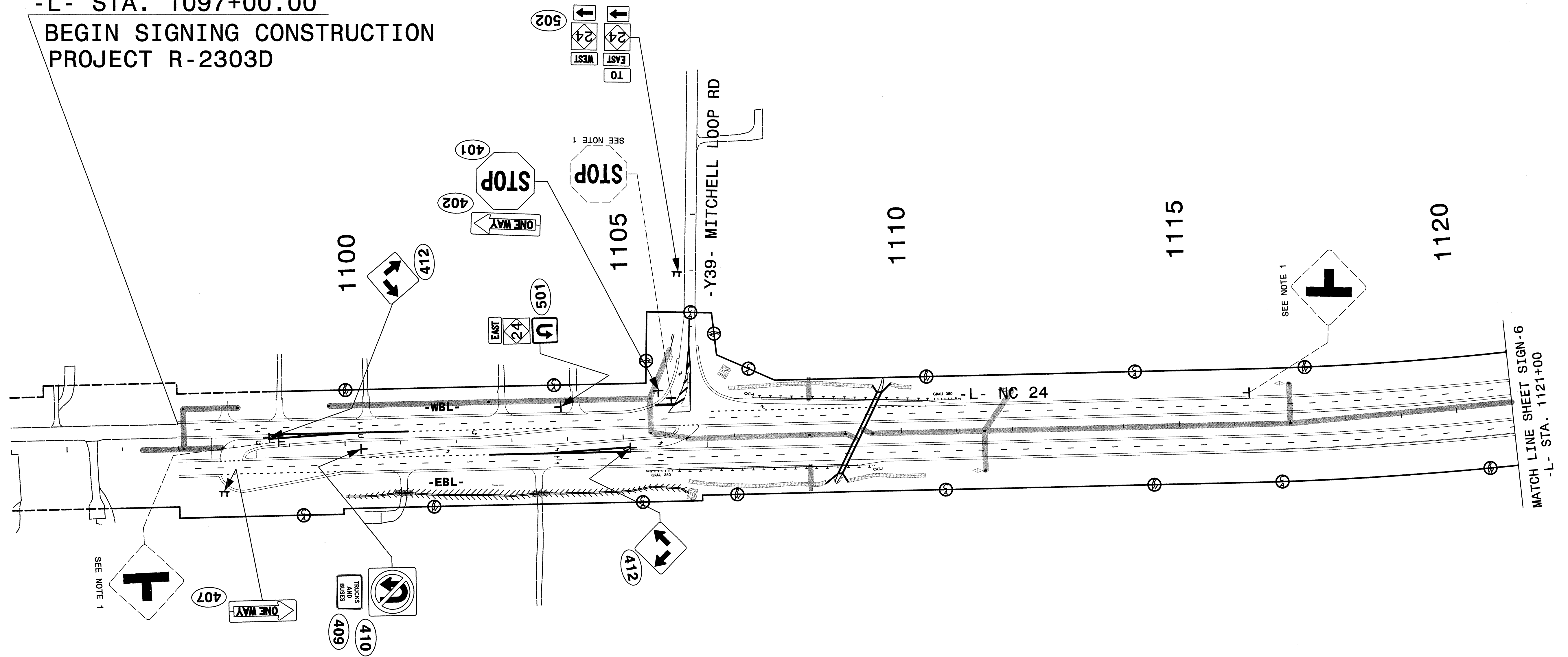

**PROJECT NOTES**

- 1 DISPOSAL OF SIGN SYSTEM, U-CHANNEL
- 2 RELOCATE SIGN, TYPE D
- 3 DISPOSAL OF SIGN SYSTEM, STEEL BEAM

**PROPOSED & EXISTING SIGNS**

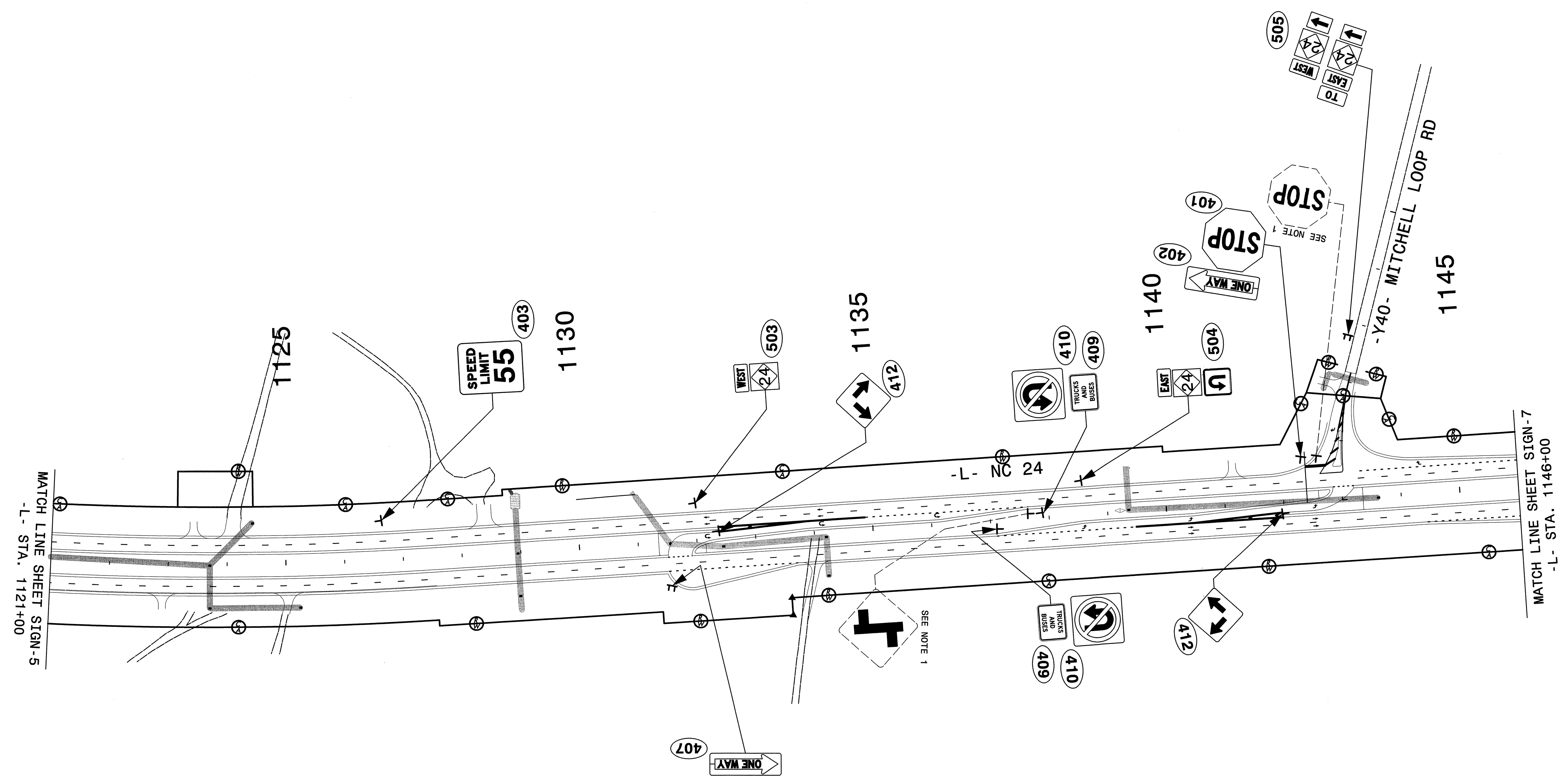
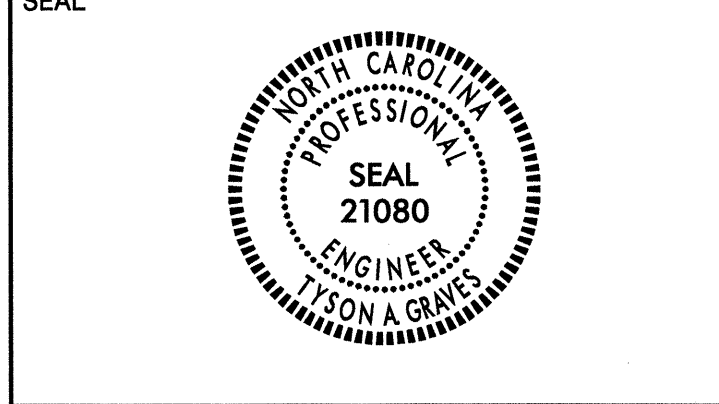

**PROJECT NOTES**

- 1 DISPOSAL OF SIGN SYSTEM, U-CHANNEL
- 2 RELOCATE SIGN, TYPE D
- 3 DISPOSAL OF SIGN SYSTEM, STEEL BEAM

**PROPOSED & EXISTING SIGNS**

5/1/2013  
 C:\Users\jstone\Documents\Projects\R-2303D\Signing\R-2303D\sign-plan\_rsign6.dgn  
 Florence & Hutcheson

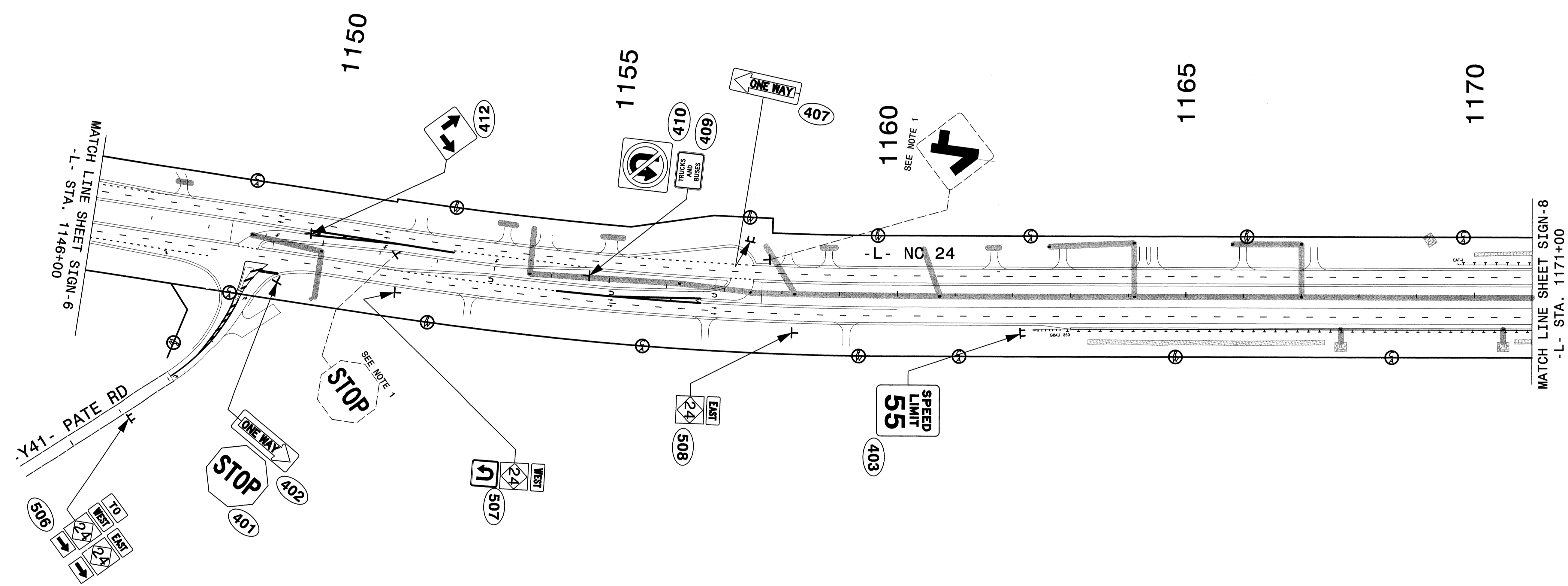
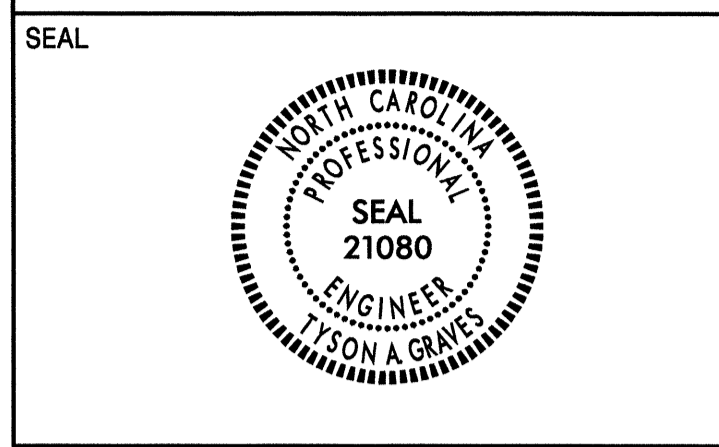

**PROJECT NOTES**

- 1 DISPOSAL OF SIGN SYSTEM, U-CHANNEL
- 2 RELOCATE SIGN, TYPE D
- 3 DISPOSAL OF SIGN SYSTEM, STEEL BEAM

**PROPOSED & EXISTING SIGNS**

5/1/2013 P:\Stations\Delin\Station\2303D\Signing\2303d\_sign\_plan\_sign7.dgn  
 Florence & Hutcheson

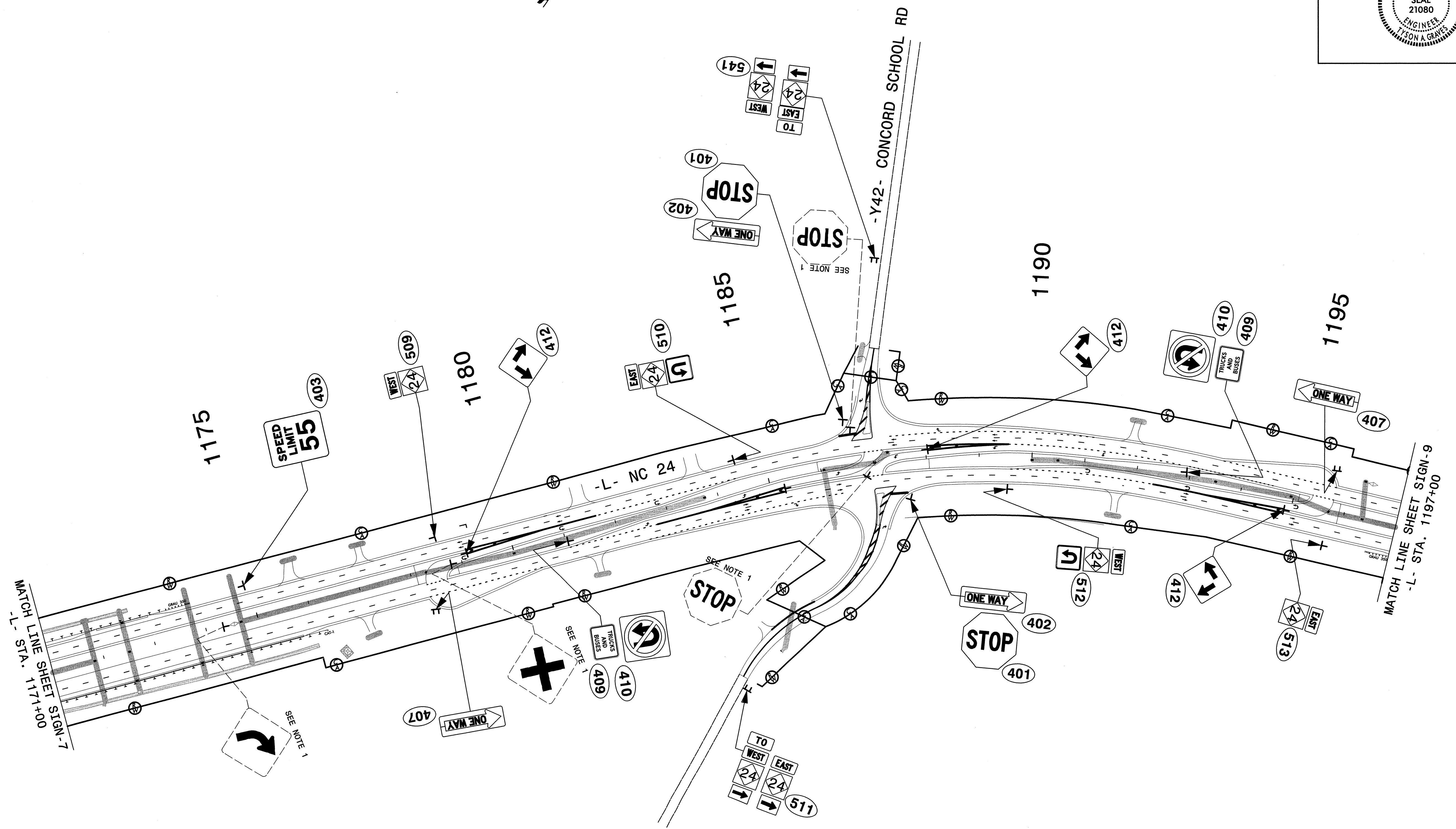

**PROJECT NOTES**

- 1 DISPOSAL OF SIGN SYSTEM, U-CHANNEL
- 2 RELOCATE SIGN, TYPE D
- 3 DISPOSAL OF SIGN SYSTEM, STEEL BEAM

**PROPOSED & EXISTING SIGNS**

5/1/2013  
 S:\Signing\Del\Inpection\R-2303D\Signing\Signing\2303D-sign-plm-.sigr8.dgn  
 Florence & Hutcheson

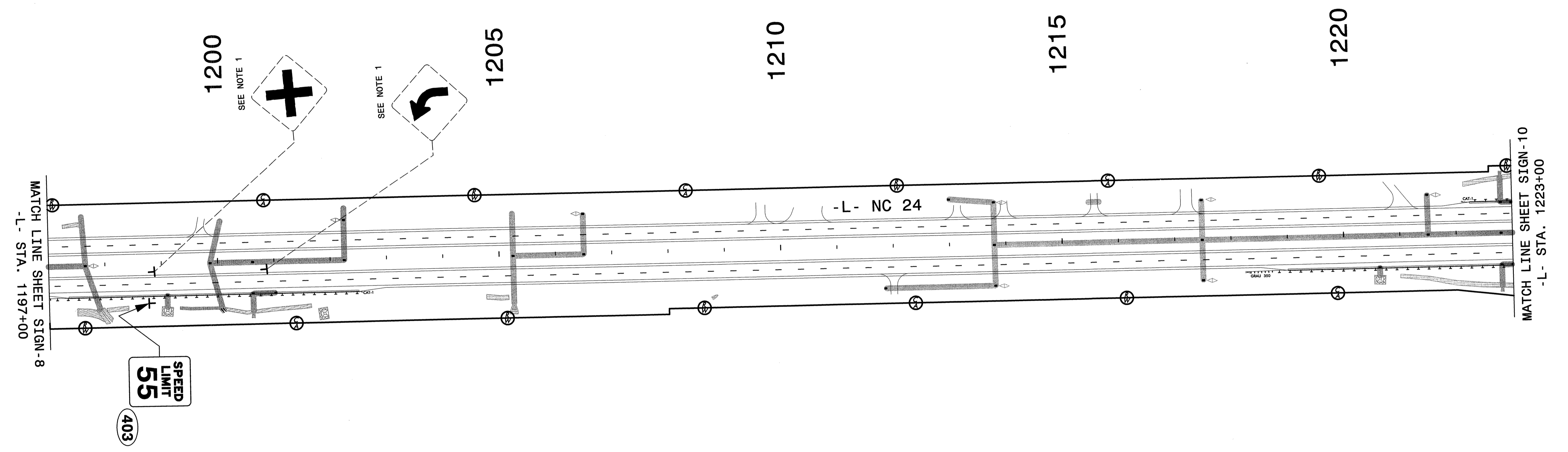
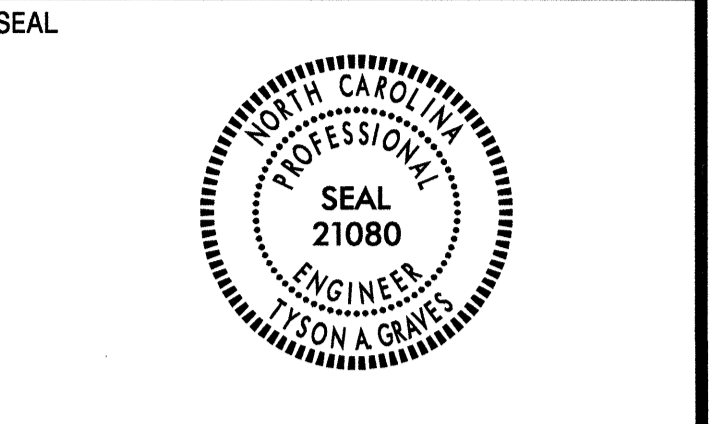

**PROJECT NOTES**

- 1 DISPOSAL OF SIGN SYSTEM, U-CHANNEL
- 2 RELOCATE SIGN, TYPE D
- 3 DISPOSAL OF SIGN SYSTEM, STEEL BEAM

**PROPOSED & EXISTING SIGNS**

5/1/2013  
 P:\Stations&Delin\Station\R-2303D\Signing\1-2303d-sign-plan\_-sign9.dgn  
 Florence & Hutcheson



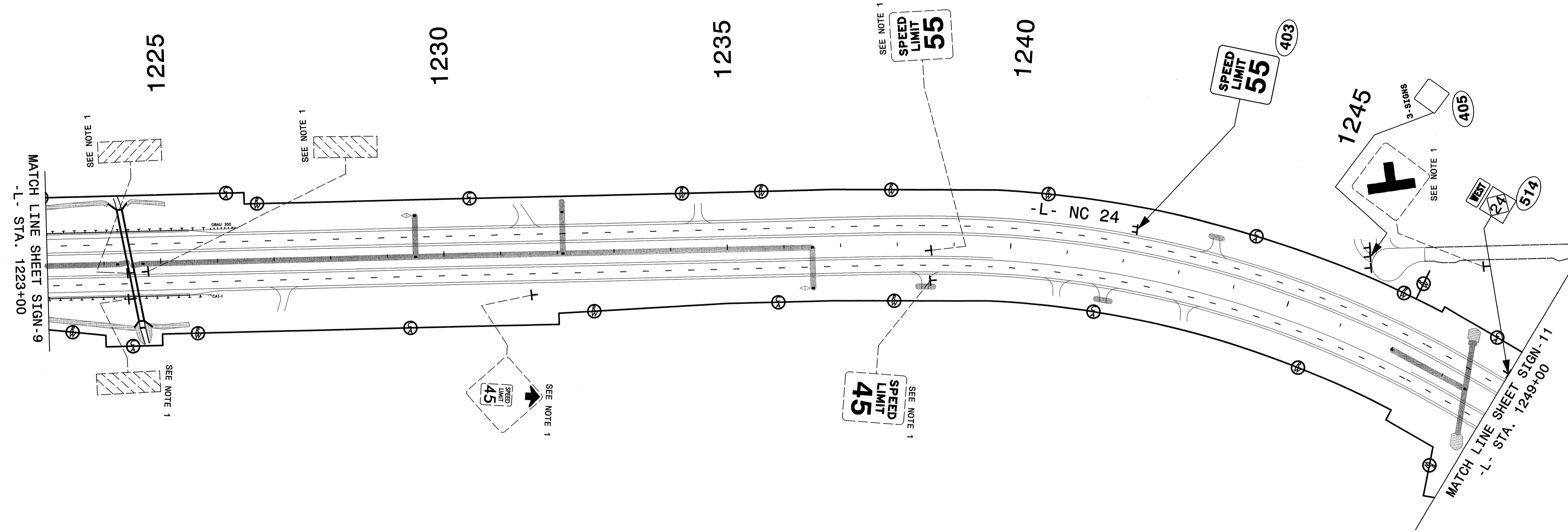

**PROJECT NOTES**

- 1 DISPOSAL OF SIGN SYSTEM, U-CHANNEL
- 2 RELOCATE SIGN, TYPE D
- 3 DISPOSAL OF SIGN SYSTEM, STEEL BEAM

**PROPOSED & EXISTING SIGNS**

5/1/2013  
 P:\Signing\Delinjection\R-2303D\Signing\2303d\_sign\_plan\_sign10.dgn  
 Florence & Hutcheson

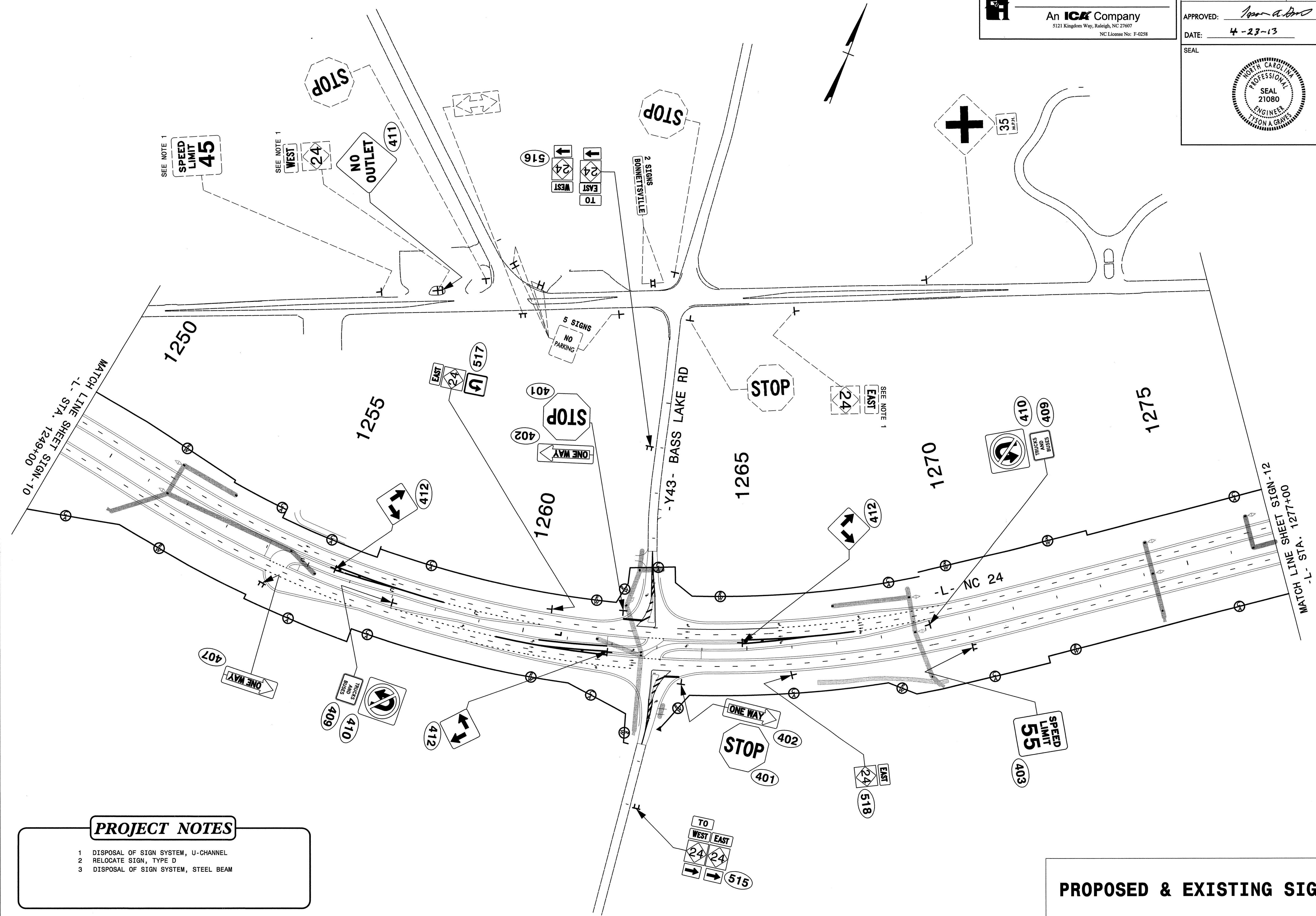

**PROJECT NOTES**

- 1 DISPOSAL OF SIGN SYSTEM, U-CHANNEL
- 2 RELOCATE SIGN, TYPE D
- 3 DISPOSAL OF SIGN SYSTEM, STEEL BEAM

**PROPOSED & EXISTING SIGNS**

5/1/2013  
 P:\Scanning\Delin\2303D\Signing\2303d\_sign\_plan\_-sign11.dgn  
 Florence & Hutcheson

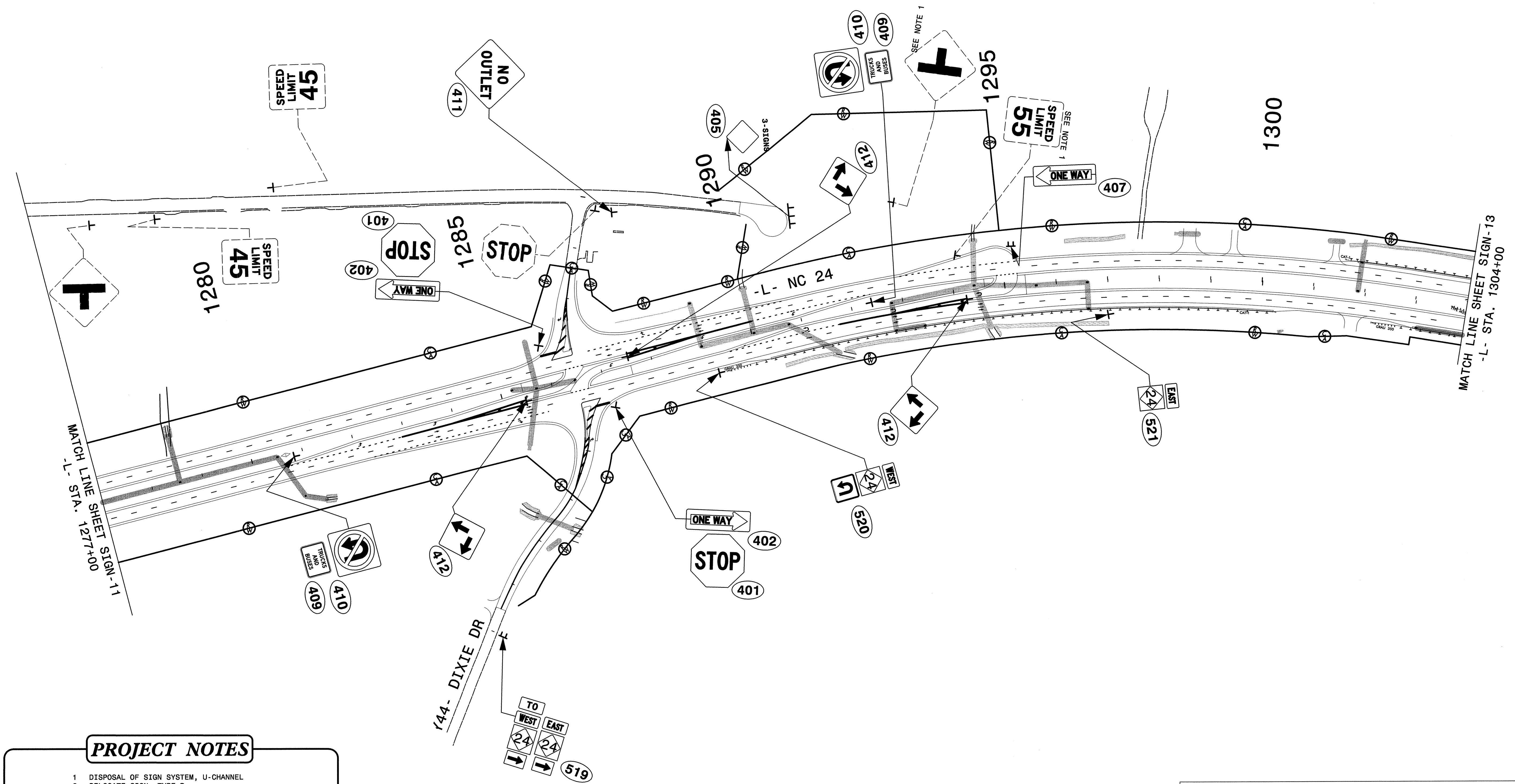

**PROJECT NOTES**

- 1 DISPOSAL OF SIGN SYSTEM, U-CHANNEL
- 2 RELOCATE SIGN, TYPE D
- 3 DISPOSAL OF SIGN SYSTEM, STEEL BEAM

**PROPOSED & EXISTING SIGNS**

5/1/2013  
 S:\Projects\Delin\Station\R-2303D\Sighting\2303d-sign-plan-r-sign12.dgn  
 Florence & Hutcheson

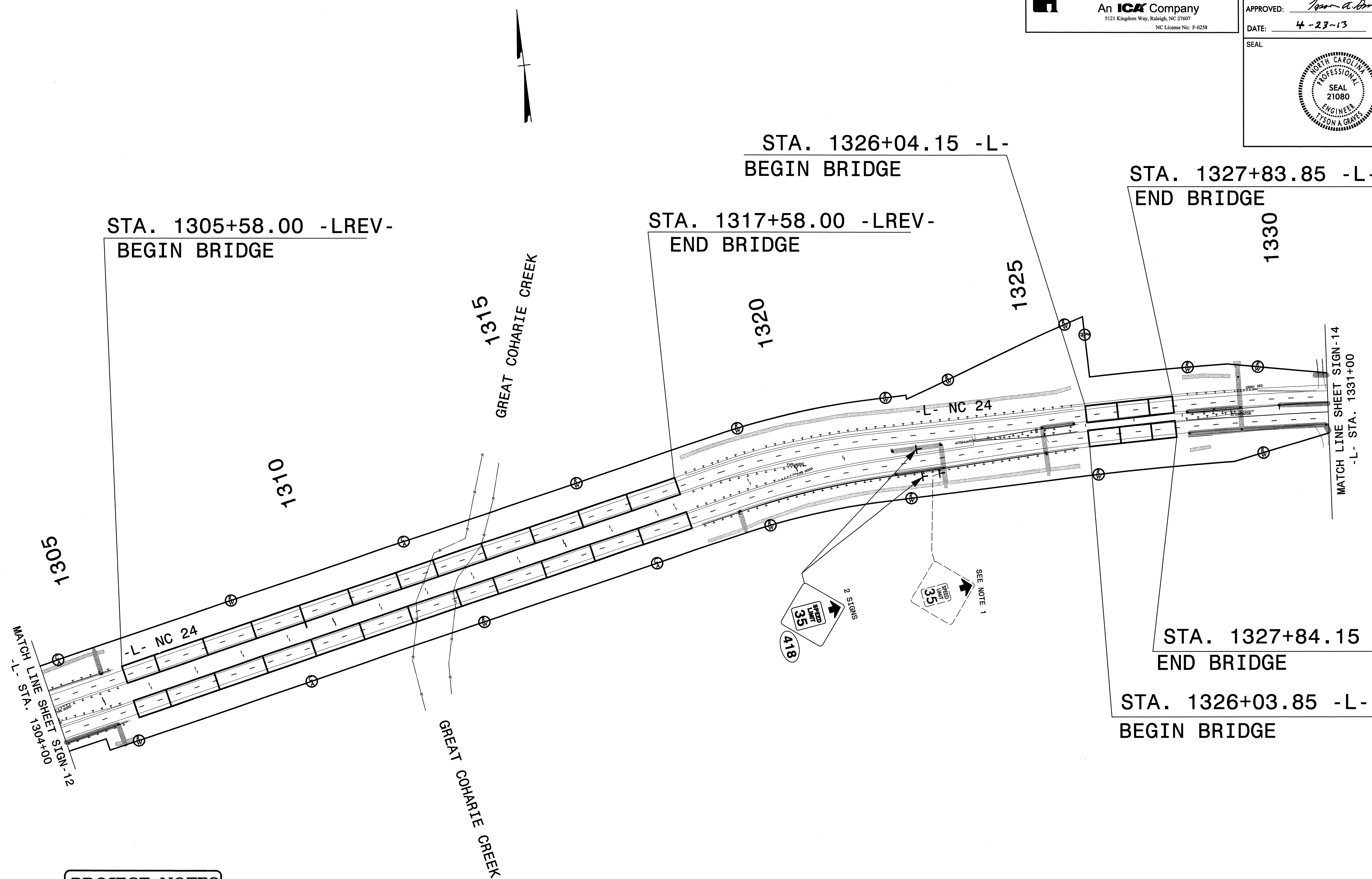

**PROJECT NOTES**

- 1 DISPOSAL OF SIGN SYSTEM, U-CHANNEL
- 2 RELOCATE SIGN, TYPE D
- 3 DISPOSAL OF SIGN SYSTEM, STEEL BEAM

**PROPOSED & EXISTING SIGNS**

5/1/2013  
 P:\Projects\Delin\action\VR-2303D\Signing\VR-2303D-sign-plan-raign13.dgn  
 Florence & Hutcheson

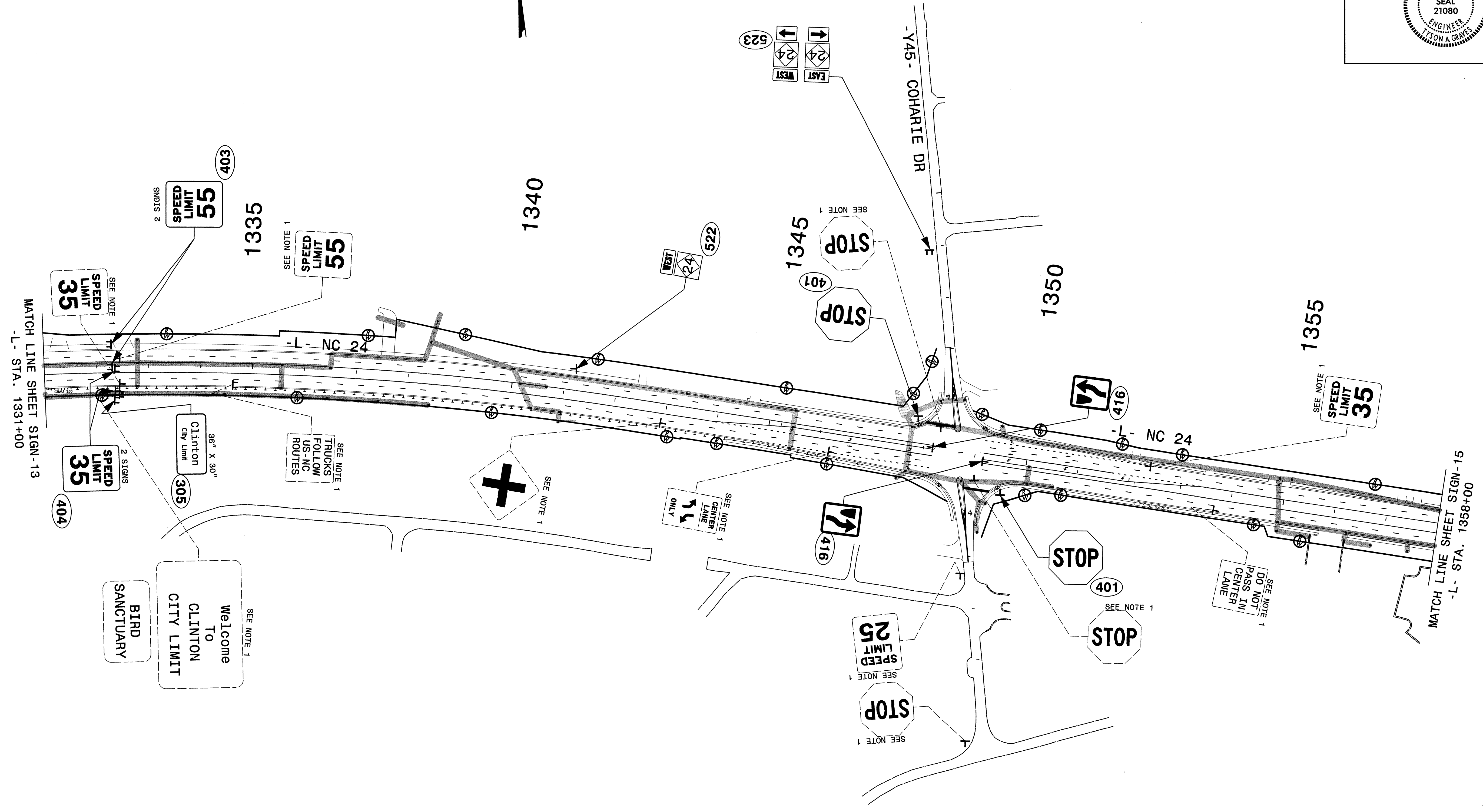

**PROJECT NOTES**

- 1 DISPOSAL OF SIGN SYSTEM, U-CHANNEL
- 2 RELOCATE SIGN, TYPE D
- 3 DISPOSAL OF SIGN SYSTEM, STEEL BEAM

**PROPOSED & EXISTING SIGNS**

5/1/2013  
 P:\Signage\Delin\action\R-2303D\Signting\R-2303D-sig-n-plan-r-sign14.dgn  
 Florence & Hutcheson

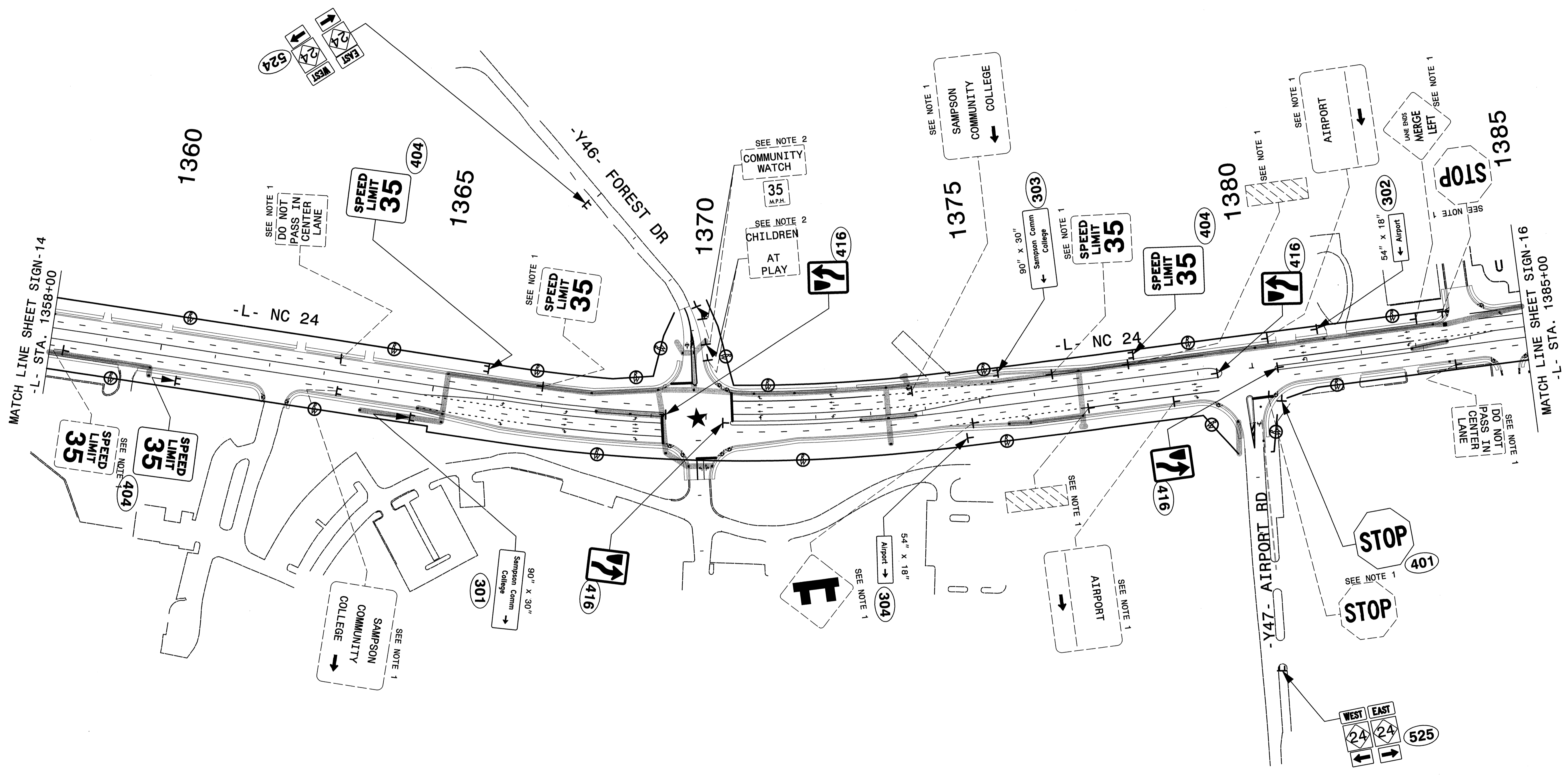

**PROJECT NOTES**

- DISPOSAL OF SIGN SYSTEM, U-CHANNEL
- RELOCATE SIGN, TYPE D
- DISPOSAL OF SIGN SYSTEM, STEEL BEAM

**PROPOSED & EXISTING SIGNS**

5/1/2013  
 P:\Signing\Del\lineation\R-2303D\Signing\R-2303D-sign-plan\_15.dgn  
 Florence & Hutcheson

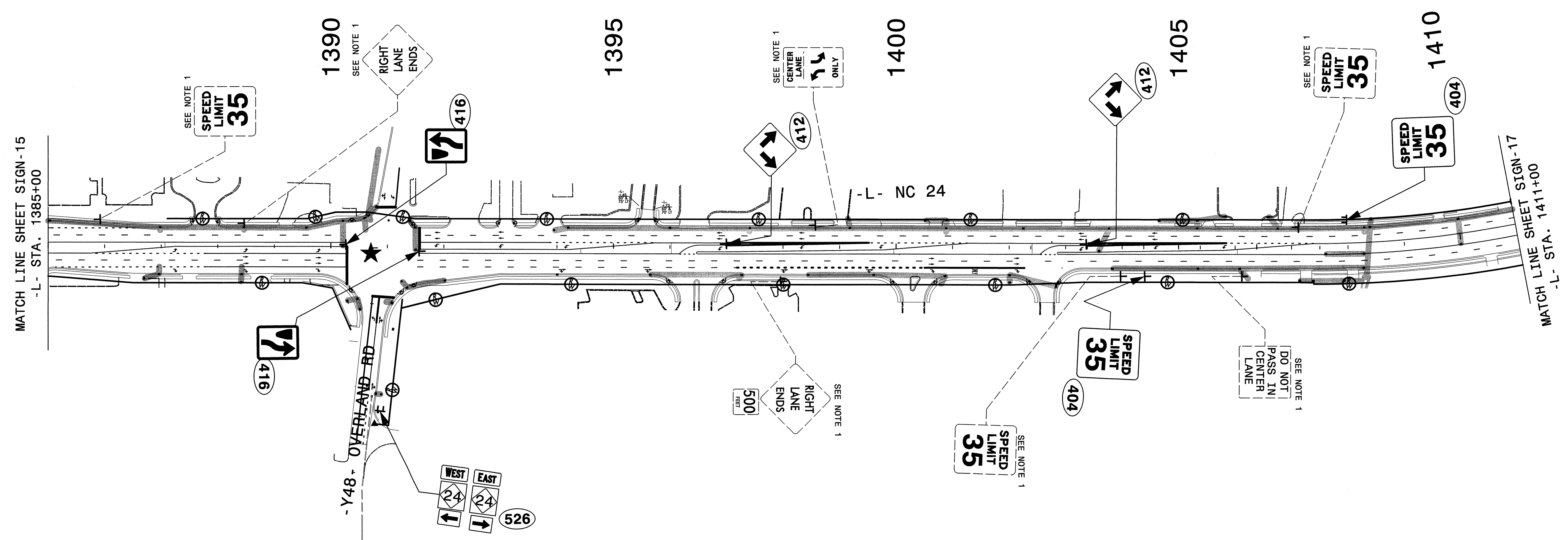
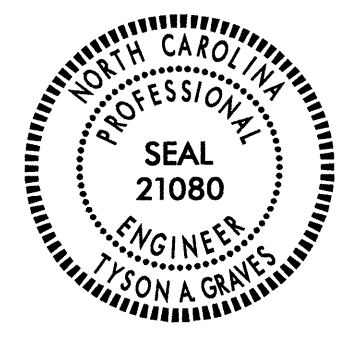

**PROJECT NOTES**

- 1 DISPOSAL OF SIGN SYSTEM, U-CHANNEL
- 2 RELOCATE SIGN, TYPE D
- 3 DISPOSAL OF SIGN SYSTEM, STEEL BEAM

**PROPOSED & EXISTING SIGNS**

5/1/2013  
 P:\Signing\Delin\Location\F-2303D\Signing\F-2303D-sign-plan-sign16.dgn  
 Florence & Hutcheson

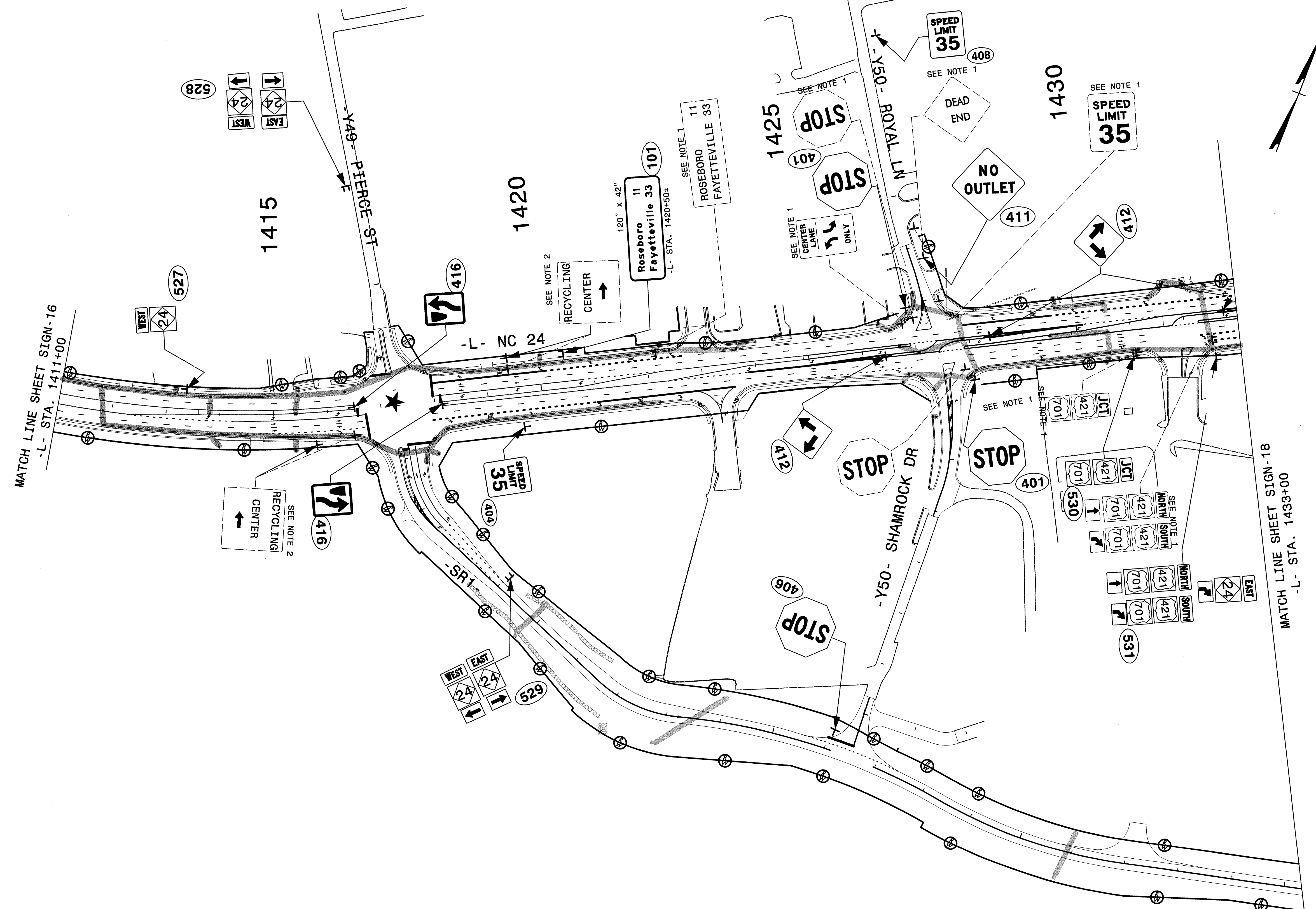

**PROJECT NOTES**

- 1 DISPOSAL OF SIGN SYSTEM, U-CHANNEL
- 2 RELOCATE SIGN, TYPE D
- 3 DISPOSAL OF SIGN SYSTEM, STEEL BEAM

**PROPOSED & EXISTING SIGNS**

E:\2013\mg\Delineation\R-2303D\Signing\2303d-sign-plan-sign17.dgn  
 Florence & Hutcheson



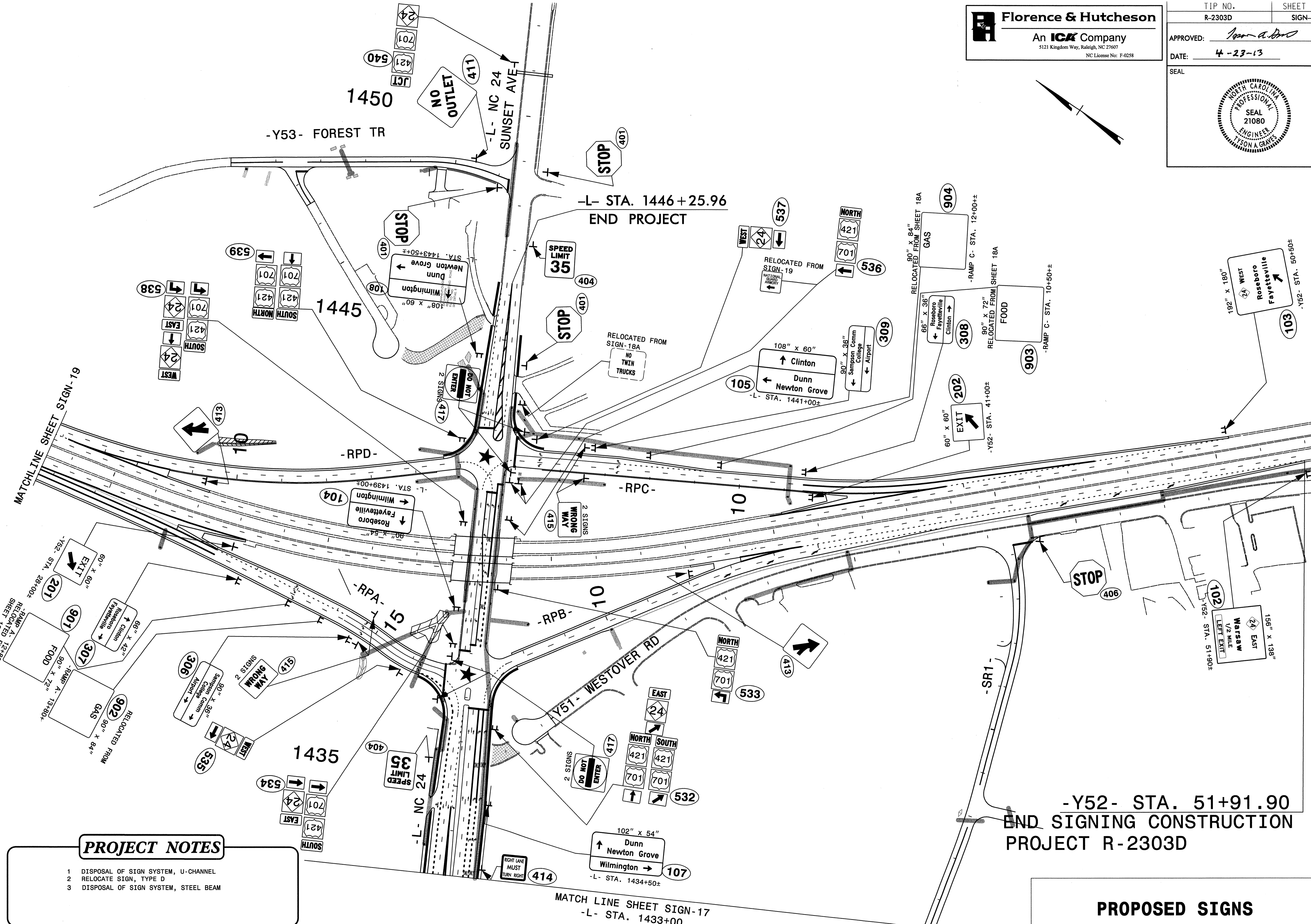
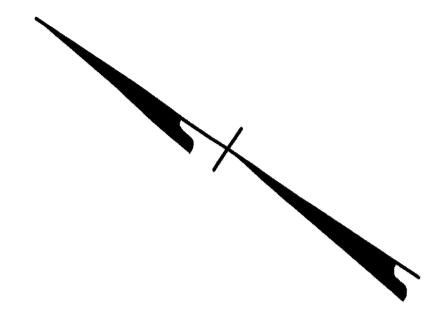

**PROJECT NOTES**

- 1 DISPOSAL OF SIGN SYSTEM, U-CHANNEL
- 2 RELOCATE SIGN, TYPE D
- 3 DISPOSAL OF SIGN SYSTEM, STEEL BEAM

-Y52- STA. 51+91.90  
 END SIGNING CONSTRUCTION  
 PROJECT R-2303D

**PROPOSED SIGNS**

5/6/2013 5:15:30 PM Signing\Project\R-2303D\Signing\Sign-18.dgn  
 Florence & Hutcheson

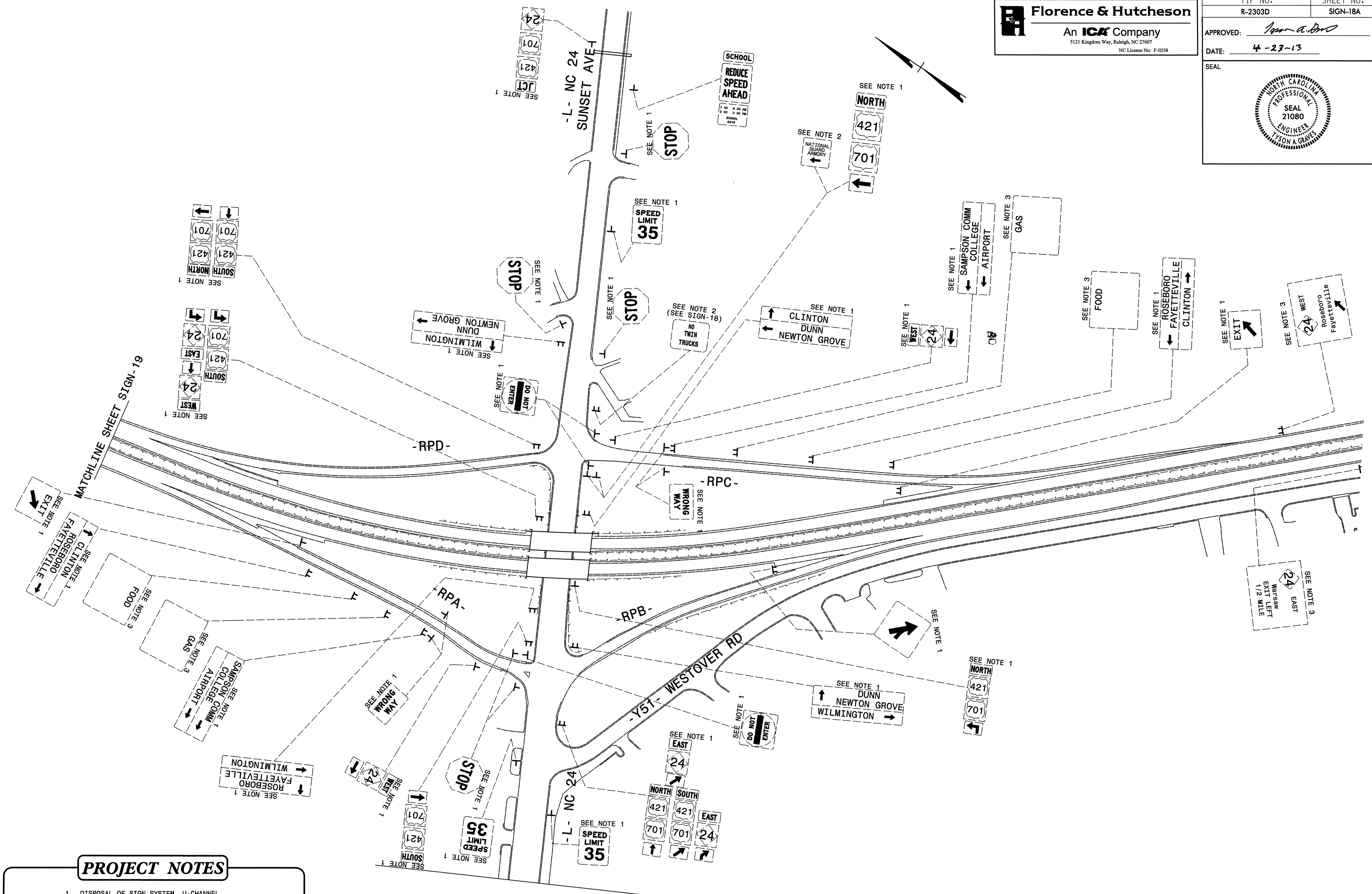

**PROJECT NOTES**

- 1 DISPOSAL OF SIGN SYSTEM, U-CHANNEL
- 2 RELOCATE SIGN, TYPE D
- 3 DISPOSAL OF SIGN SYSTEM, STEEL BEAM

MATCH LINE SHEET SIGN-17  
 -L- STA. 1433+00

**EXISTING SIGNS**

5/1/2013  
 C:\Users\jdelaney\Documents\Projects\R-2303D\Signting\2303d-sign-plan-existing.dgn  
 Florence & Hutcheson

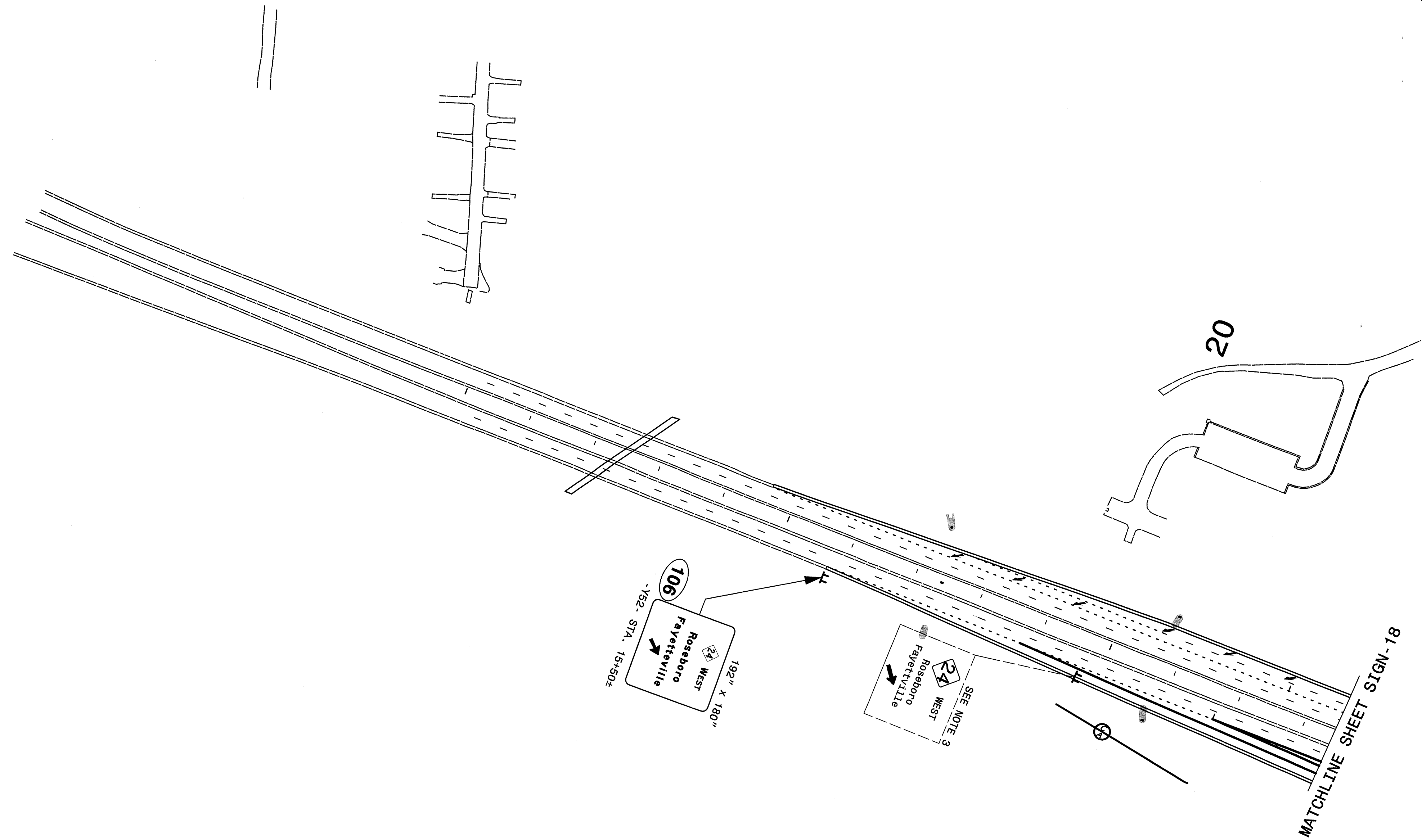
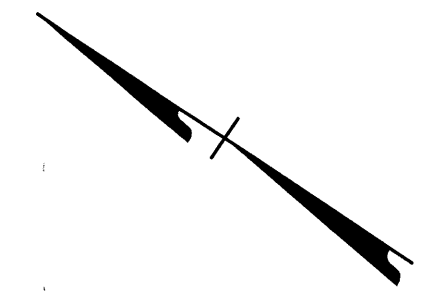
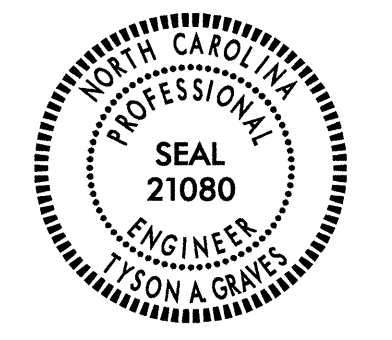

**PROJECT NOTES**

- 1 DISPOSAL OF SIGN SYSTEM, U-CHANNEL
- 2 RELOCATE SIGN, TYPE D
- 3 DISPOSAL OF SIGN SYSTEM, STEEL BEAM

**PROPOSED & EXISTING SIGNS**

5/1/2013  
 P:\Spring\Delination\R-2303D\Sigming\2303d\_sgn\_pln\_sgn19.dgn  
 Florence & Hutcheson