

**STATE OF NORTH CAROLINA
DEPARTMENT OF TRANSPORTATION**

TIP NO. R-5207A	SHEET NO. PMP-1
APPROVED: <i>Steve Miller</i>	
DATE: 9-5-12	
SEAL	

**PAVEMENT MARKING PLAN
HENDERSON COUNTY**

T.I.P.: R-5207A

CONTRACT: - -

INDEX

SHEET NO.	DESCRIPTION
PMP-1	PAVEMENT MARKING PLAN COVER SHEET
PMP-2 - 14	PAVEMENT MARKING DETAILS .
PMP-15	PAVEMENT MARKING SCHEDULE

GENERAL NOTES

- THE FOLLOWING GENERAL NOTES APPLY AT ALL TIMES FOR THE DURATION OF THE CONSTRUCTION PROJECT, EXCEPT WHEN OTHERWISE NOTED IN THE PLAN, OR DIRECTED BY THE ENGINEER.
- A) INSTALL PAVEMENT MARKINGS AND PAVEMENT MARKERS ON THE FINAL SURFACE AS FOLLOWS:

ROAD NAME	MARKING	MARKER
HOWARD GAP RD (SR 1006)	THERMOPLASTIC	SNOWPLOWABLE
 - B) TIE PROPOSED PAVEMENT MARKING LINES TO EXISTING PAVEMENT MARKING LINES.
 - C) REMOVE/REPLACE ANY CONFLICTING/DAMAGED PAVEMENT MARKINGS AND MARKERS.
 - D) PASSING ZONES WILL BE DETERMINED IN THE FIELD AND MUST BE APPROVED BY THE ENGINEER.
 - E) STOP BAR LOCATION AT NON-SIGNALIZED INTERSECTIONS MAY BE ADJUSTED AS DIRECTED BY THE ENGINEER.
 - F) ON ASPHALT SURFACES, USE HEATED-IN-PLACE THERMOPLASTIC OR EXTRUDED THERMOPLASTIC FOR STOP BARS, SYMBOLS, CHARACTERS AND DIAGONALS.
 - G) MARKERS SHALL BE INSTALLED ACCORDING TO THE NCDOT ROADWAY STANDARD DRAWING 1250.01.

ROADWAY STANDARD DRAWING

THE FOLLOWING ROADWAY STANDARDS AS APPEAR IN "ROADWAY STANDARD DRAWINGS" - PROJECT SERVICES UNIT - N.C. DEPARTMENT OF TRANSPORTATION - RALEIGH, N.C., DATED JANUARY 2012 ARE APPLICABLE TO THIS PROJECT AND BY REFERENCE HEREBY ARE CONSIDERED A PART OF THESE PLANS:

STD. NO.	TITLE
1205.01	PAVEMENT MARKINGS - LINE TYPES AND OFFSETS
1205.02	PAVEMENT MARKINGS - TWO-LANE AND MULTILANE ROADWAYS
1205.04	PAVEMENT MARKINGS - INTERSECTIONS
1205.05	PAVEMENT MARKINGS - TURN LANES
1205.06	PAVEMENT MARKINGS - LANE DROPS
1205.07	PAVEMENT MARKINGS - PEDESTRIAN CROSSWALKS
1205.08	PAVEMENT MARKINGS - SYMBOLS AND WORD MESSAGES
1205.09	PAVEMENT MARKINGS - PAINTED ISLANDS
1205.12	PAVEMENT MARKINGS - BRIDGES
1250.01	RAISED PAVEMENT MARKERS - INSTALLATION SPACING
1253.01	RAISED PAVEMENT MARKERS - SNOWPLOWABLE
1261.01	GUARDRAIL AND BARRIER DELINEATORS - INSTALLATION SPACING
1261.02	GUARDRAIL AND BARRIER DELINEATORS - TYPES AND MOUNTING
1262.01	GUARDRAIL END DELINEATION

PLAN REVIEWED BY: N.C.D.O.T. SIGNING AND DELINEATION UNIT

KELVIN JORDAN SIGNING & DELINEATION REGIONAL ENGINEER
DERRICK BEARD SIGNING & DELINEATION PROJECT DESIGN ENGINEER

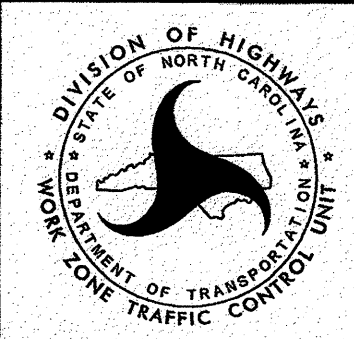

PLAN PREPARED BY: SEPI Engineering & Construction

STEVE MILLER, P.E. TRANSPORTATION ENGINEER
TERRY BENTON CADD TECHNICIAN

SEPI ENGINEERING & CONSTRUCTION
 1025 Wade Avenue
 Raleigh, NC 27605
 Tel: 919-789-9977
 Fax: 919-789-9591
 License: C-2197

 SYSTEMS

TIP NO.	SHEET NO.
R-5207A	PMP-2
APPROVED: <i>St. Webb</i>	
DATE: 9-5-12	
SEAL	

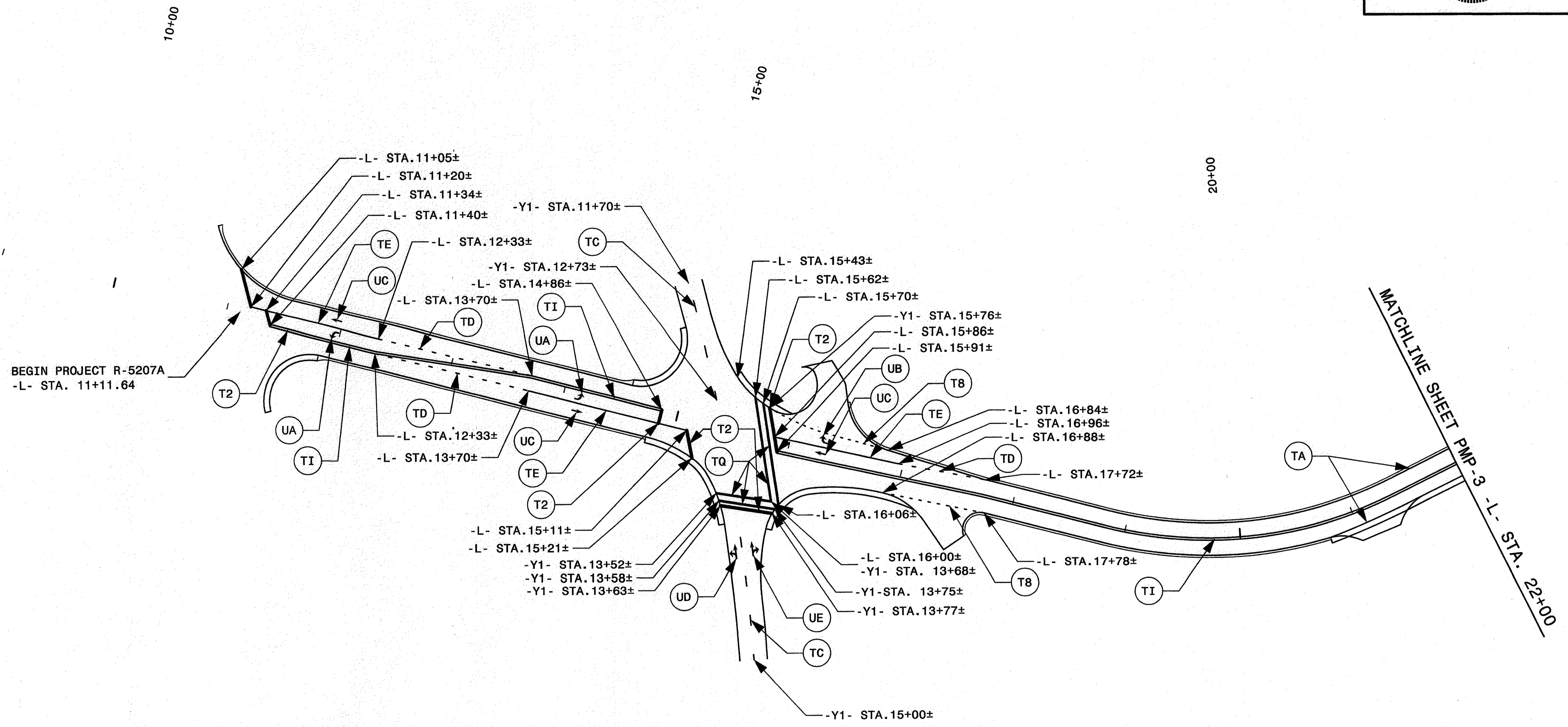
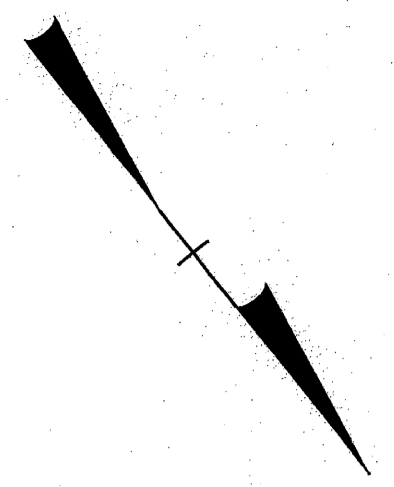

BEGIN PROJECT R-5207A
-L- STA. 11+11.64

MATCHLINE SHEET PMP-3
-L- STA. 22+00

\$\$\$\$\$SYTIME\$\$\$\$\$
\$\$\$\$\$DONS\$\$\$\$\$
\$\$\$\$\$SERNAME\$\$\$\$\$

SEPI
ENGINEERING &
CONSTRUCTION
1025 Wade Avenue
Raleigh, NC 27605
Tel: 919-789-9977
Fax: 919-789-9591
License: C-2197

PAVEMENT MARKING DETAIL

TIP NO. R-5207A	SHEET NO. PMP-3
APPROVED: <i>S.D. Miller</i>	
DATE: 9-5-12	
SEAL	

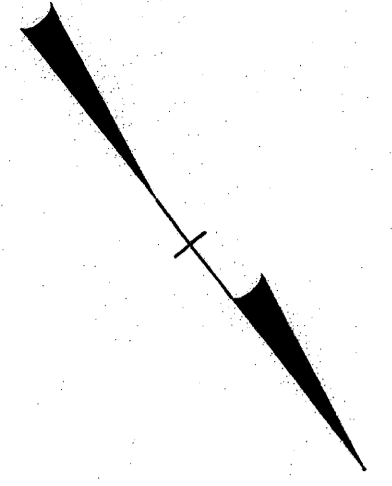

25+00

30+00

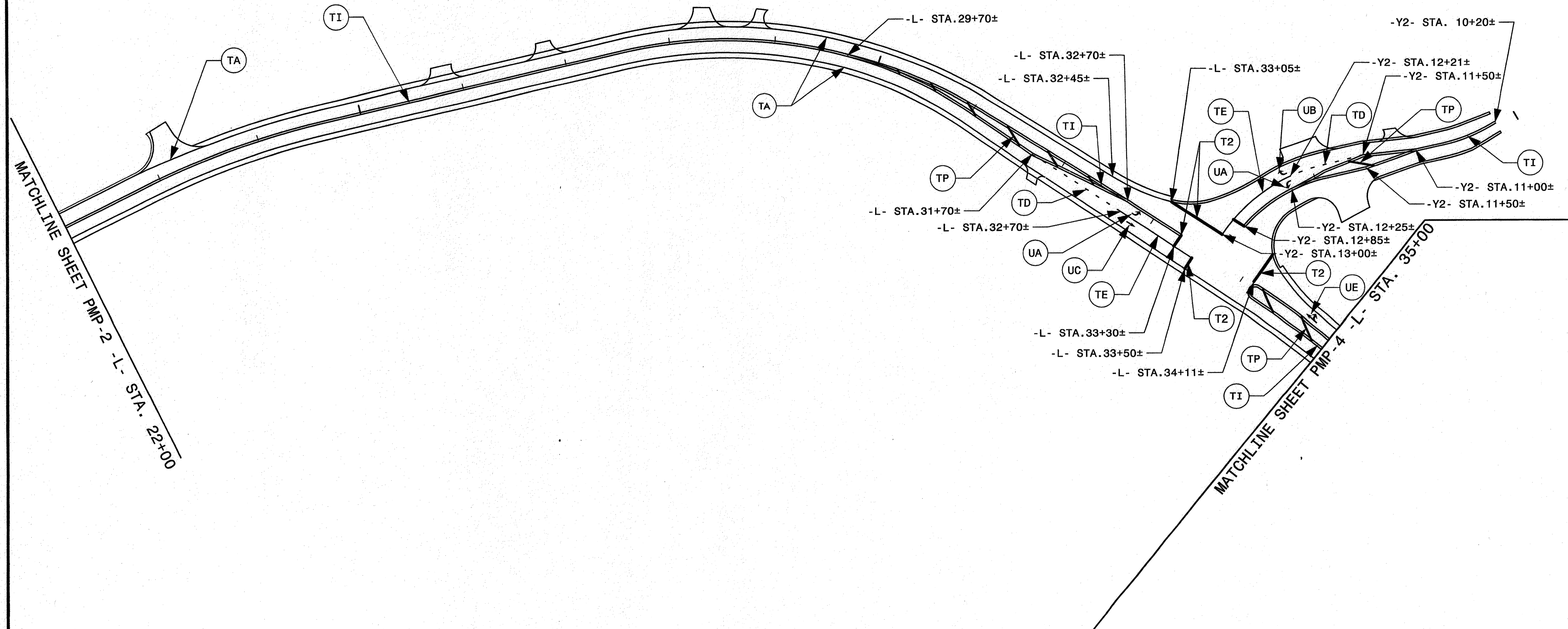

\$\$\$\$\$SYTIME\$\$\$\$\$
 \$\$\$\$\$\$DCN\$\$\$\$\$
 \$\$\$\$\$\$SERNAME\$\$\$\$\$

SEPI
 ENGINEERING &
 CONSTRUCTION
 1025 Wade Avenue
 Raleigh, NC 27605
 Tel: 919-789-9977
 Fax: 919-789-9591
 License: C-2197

PAVEMENT MARKING DETAIL

TIP NO.	SHEET NO.
R-5207A	PMP-4
APPROVED: <i>[Signature]</i>	
DATE: 9-5-12	
SEAL	

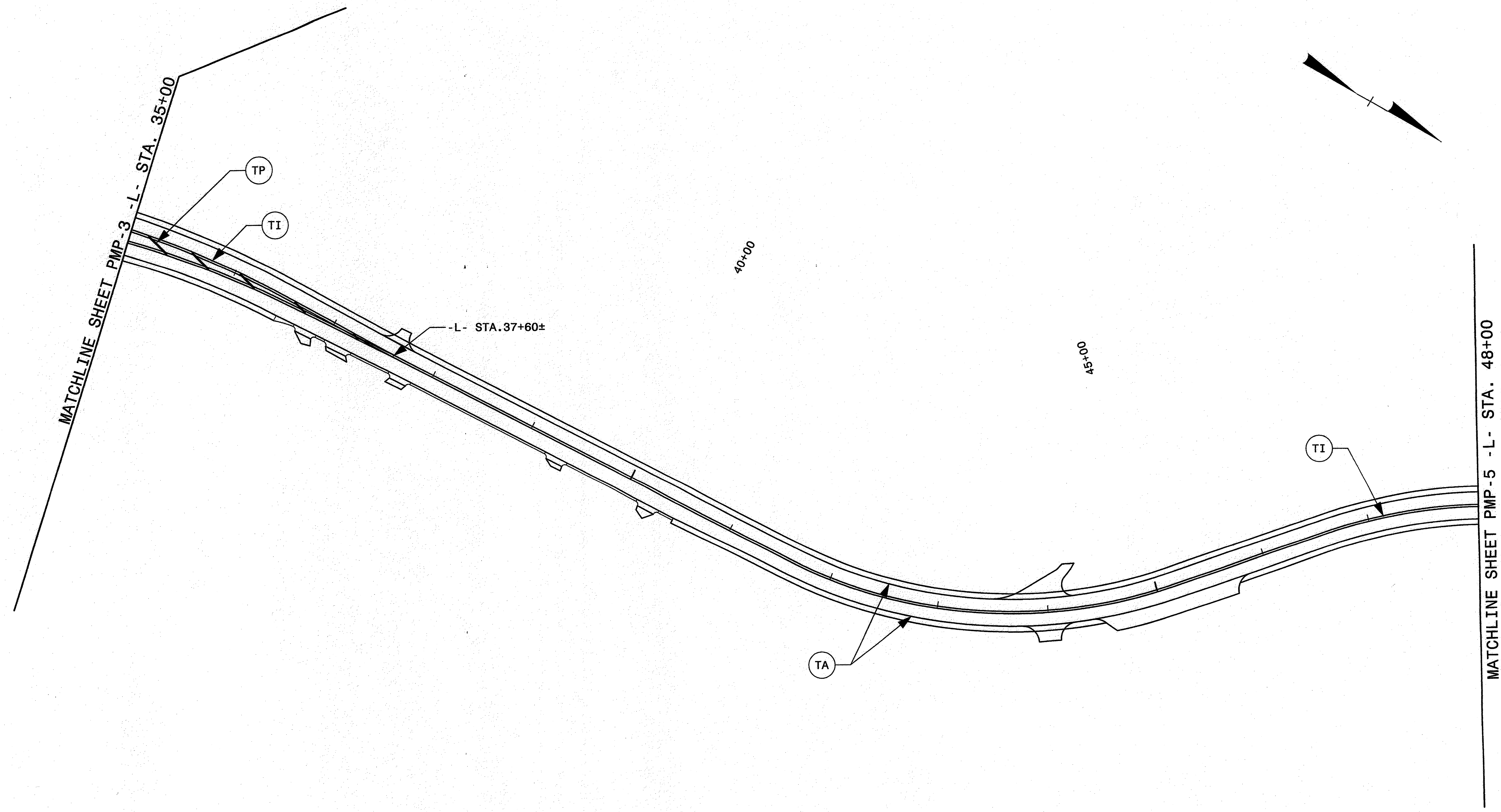

\$\$\$\$\$SYTIME\$\$\$\$\$
 \$\$\$DDON\$\$\$\$\$
 \$\$\$USERNAME\$\$\$\$\$

SEPI
 ENGINEERING &
 CONSTRUCTION
 1025 Wade Avenue
 Raleigh, NC 27605
 Tel: 919-789-9977
 Fax: 919-789-9591
 License: C-2197

PAVEMENT MARKING DETAIL

TIP NO.	SHEET NO.
R-5207A	PMP-6
APPROVED: <i>St. Miller</i>	
DATE: 9-5-12	
SEAL	

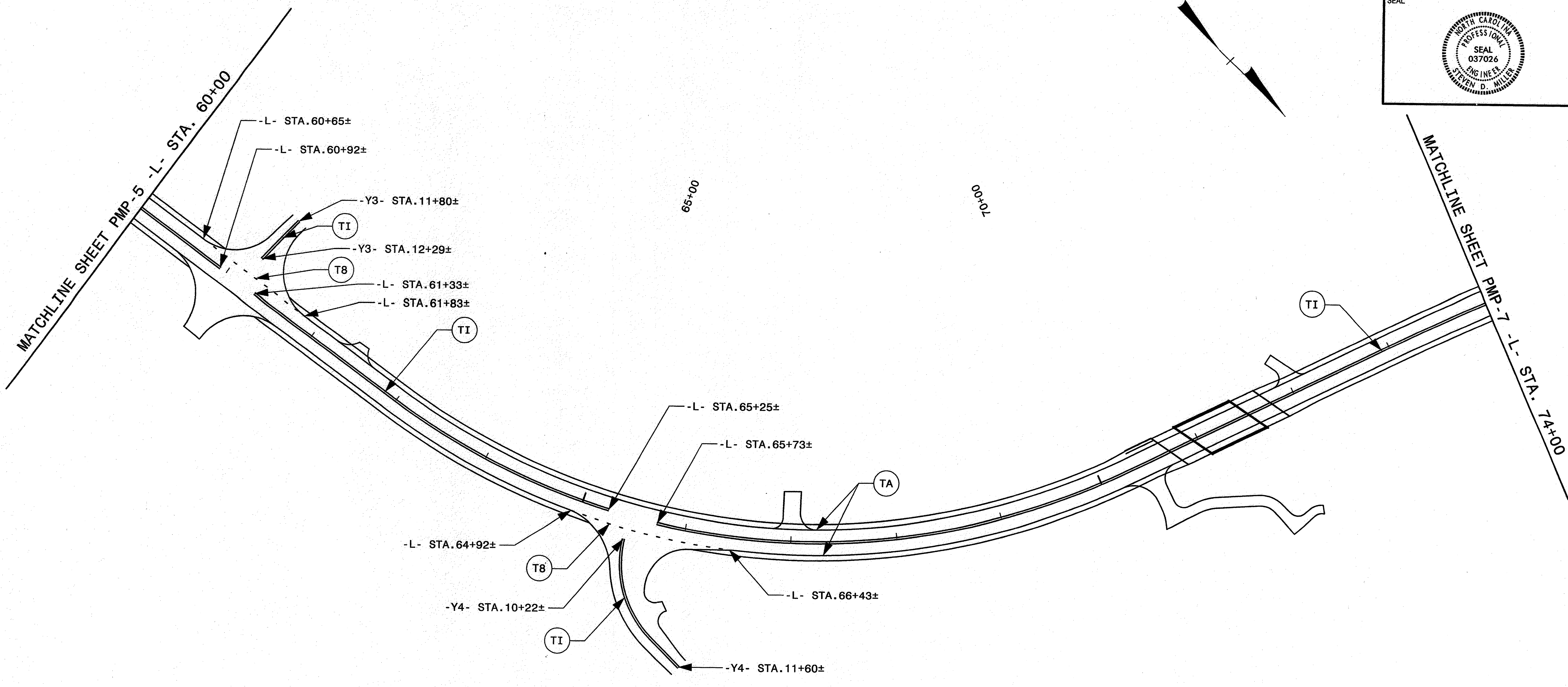

\$\$\$SYTIME\$\$\$
 \$\$\$DCN\$\$\$
 \$\$\$USERNAME\$\$\$
 \$\$\$

SEPI
 ENGINEERING &
 CONSTRUCTION
 1025 Wade Avenue
 Raleigh, NC 27605
 Tel: 919-789-9977
 Fax: 919-789-9591
 License: C-2197

PAVEMENT MARKING DETAIL

TIP NO. R-5207A	SHEET NO. PMP-7
APPROVED: <i>Stc Mdb</i>	
DATE: 9-5-12	
SEAL	

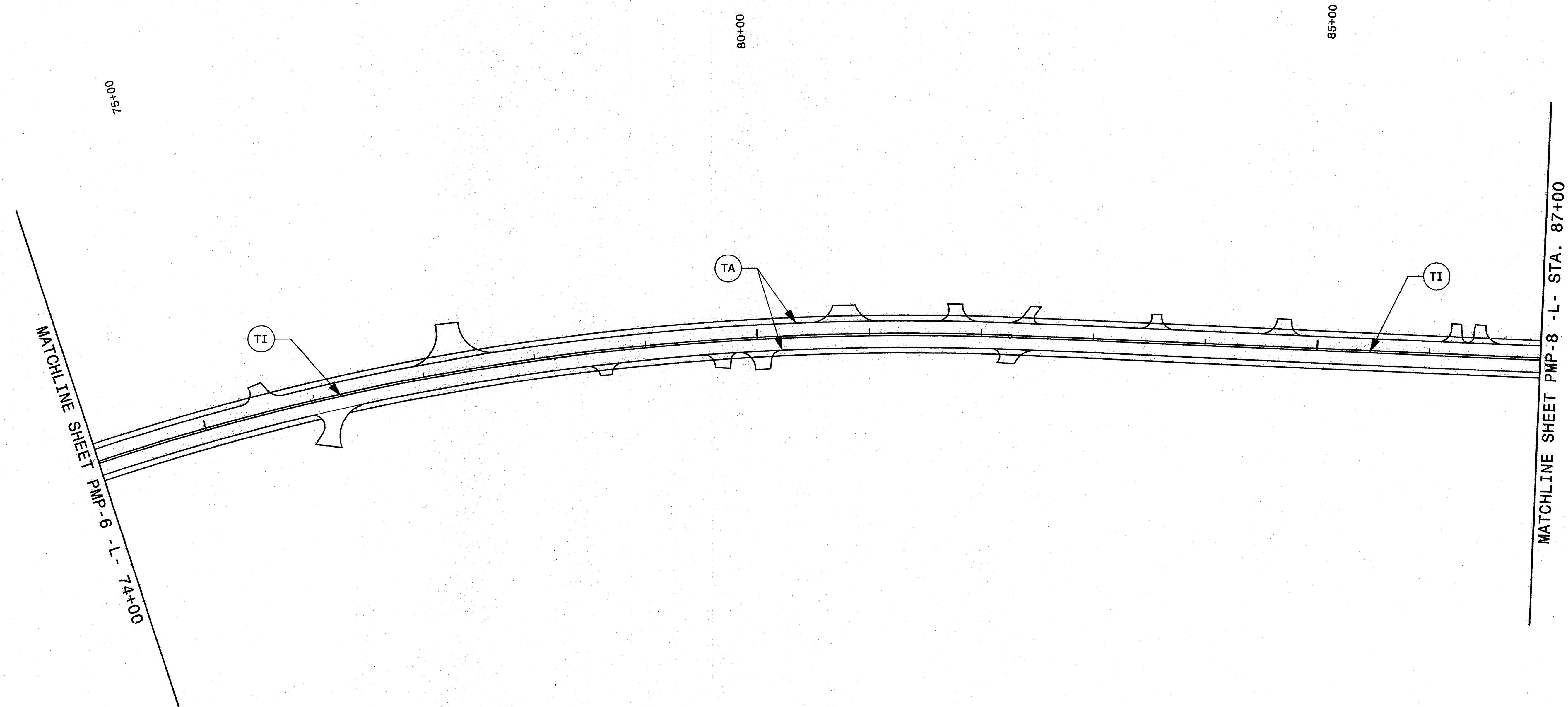

MATCHLINE SHEET PMP-6 - L - STA. 74+00

MATCHLINE SHEET PMP-8 - L - STA. 87+00

\$\$\$SYSTEM\$\$\$
 \$\$\$DGN\$\$\$
 \$\$\$USERNAME\$\$\$

SEPI
 ENGINEERING &
 CONSTRUCTION
 1025 Wade Avenue
 Raleigh, NC 27605
 Tel: 919-789-9977
 Fax: 919-789-9591
 License: C-2197

PAVEMENT MARKING DETAIL

TIP NO. R-5207A	SHEET NO. PMP-8
APPROVED: <i>St. Miller</i>	
DATE: 9-5-12	
SEAL	

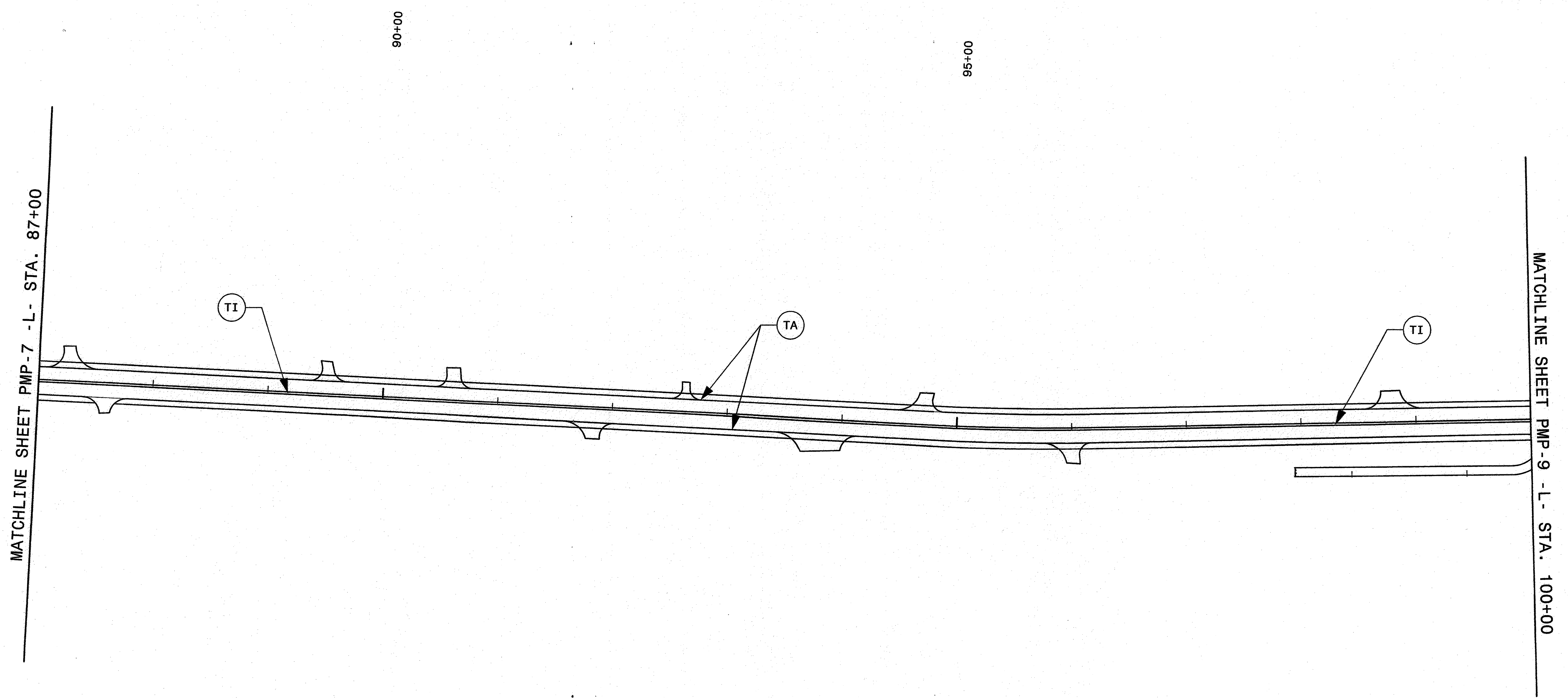

\$\$\$\$SYTIME\$\$\$\$
 \$\$\$CDGN\$\$\$\$
 \$\$\$USERNAME\$\$\$\$

SEPI
 ENGINEERING &
 CONSTRUCTION

1025 Wade Avenue
 Raleigh, NC 27605
 Tel: 919-789-9977
 Fax: 919-789-9591
 License: C-2197

PAVEMENT MARKING DETAIL

TIP NO.	SHEET NO.
R-5207A	PMP-10
APPROVED: <i>St. Miller</i>	
DATE: 9-5-12	
SEAL	

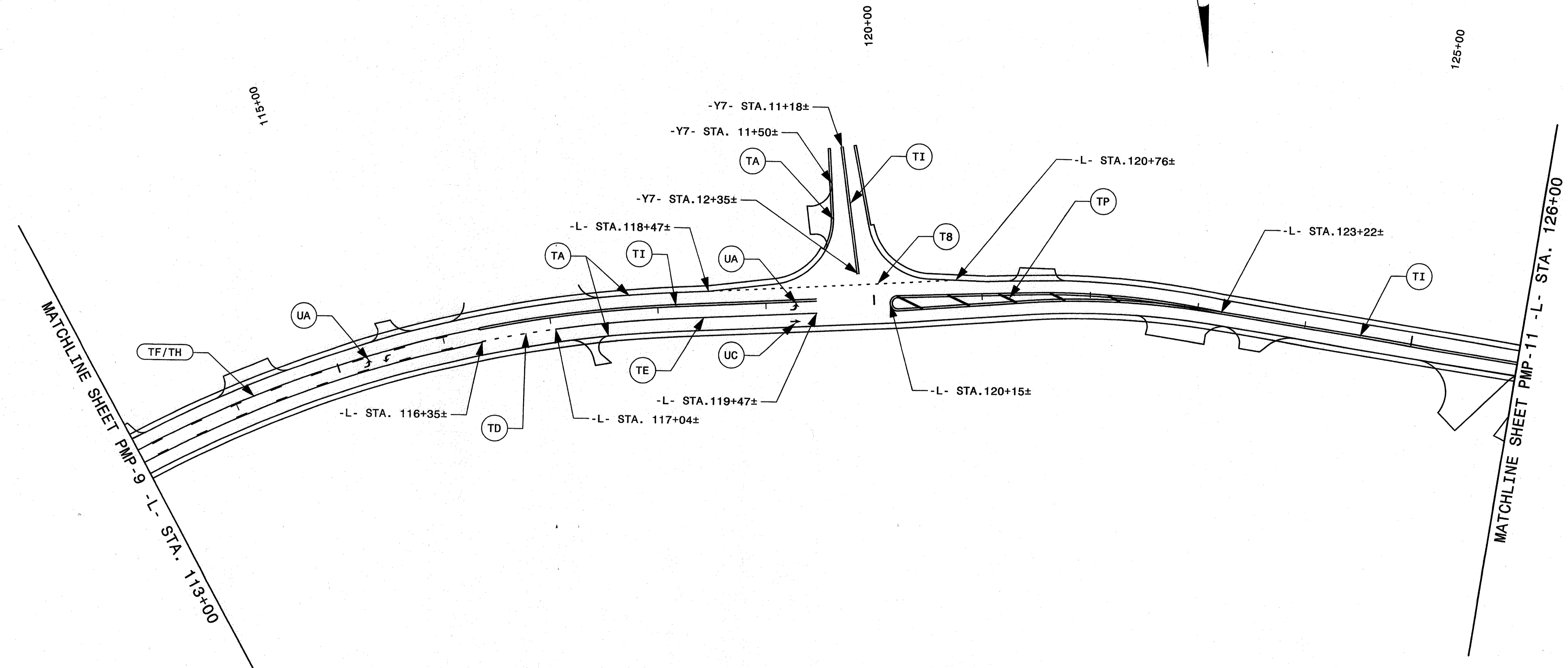

\$\$\$\$\$ SYSTEM \$\$\$\$\$\$
 \$\$\$ XREFS \$\$\$
 \$\$\$ USER NAME \$\$\$

SEPI
 ENGINEERING &
 CONSTRUCTION

1025 Wade Avenue
 Raleigh, NC 27605
 Tel: 919-789-9977
 Fax: 919-789-9591
 License: C-2197

PAVEMENT MARKING DETAIL

TIP NO. R-5207A	SHEET NO. PMP-11
APPROVED: <i>St. Mull</i>	
DATE: 9-5-12	
SEAL	

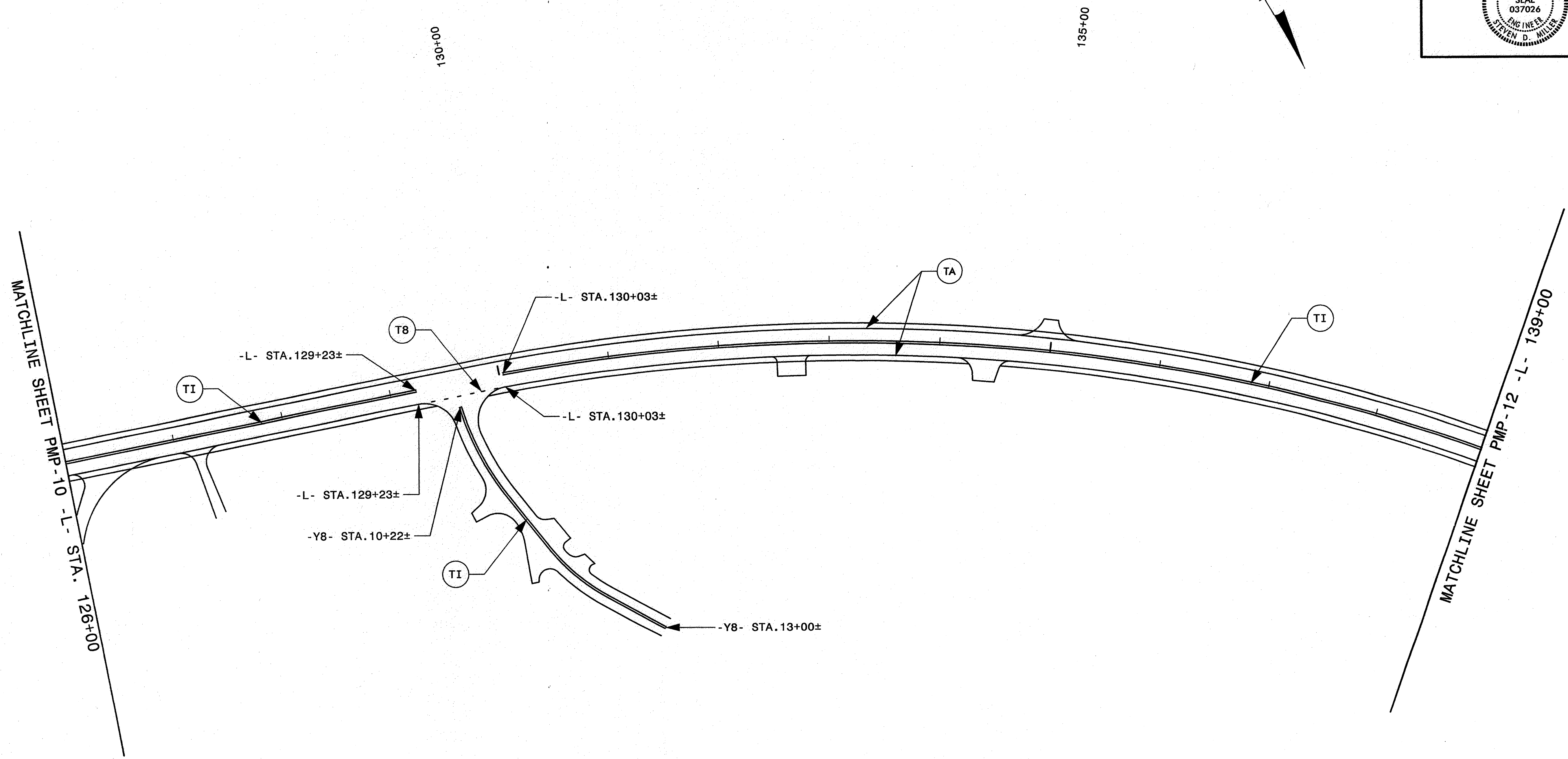
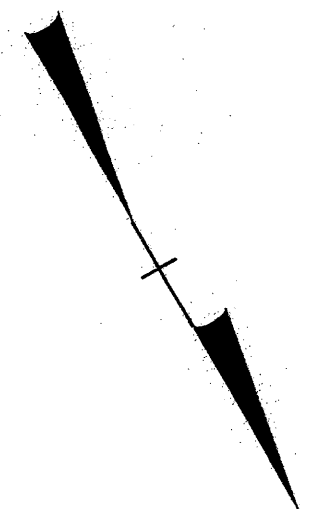

\$\$\$\$\$SYTIME\$\$\$\$\$
 \$\$\$\$\$\$DCI\$\$\$\$\$
 \$\$\$\$\$\$SERNAME\$\$\$\$\$

SEPI
 ENGINEERING &
 CONSTRUCTION

1025 Wade Avenue
 Raleigh, NC 27605
 Tel: 919-789-9977
 Fax: 919-789-9591
 License: C-2197

PAVEMENT MARKING DETAIL

TIP NO. R-5207A	SHEET NO. PMP-12
APPROVED: <i>St. Mill</i>	
DATE: 9-5-12	
SEAL	

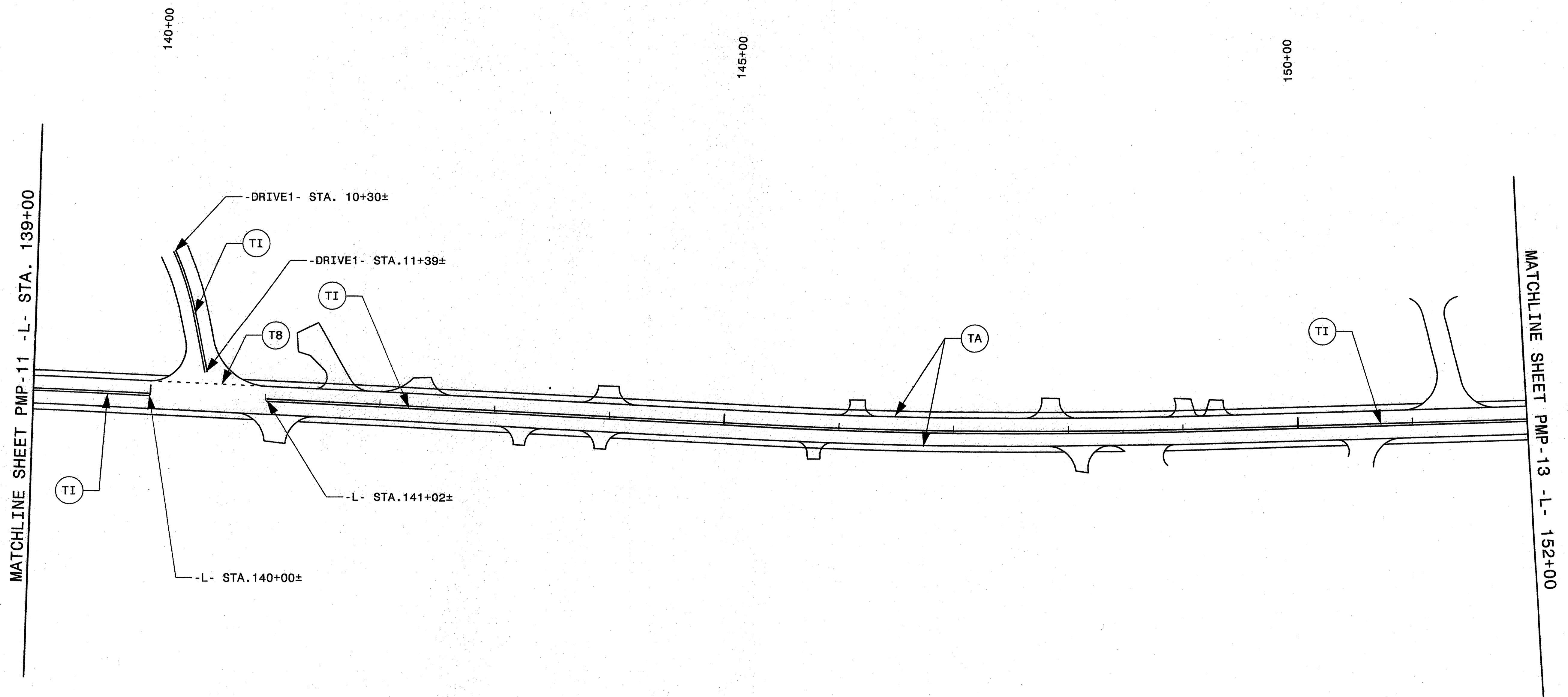
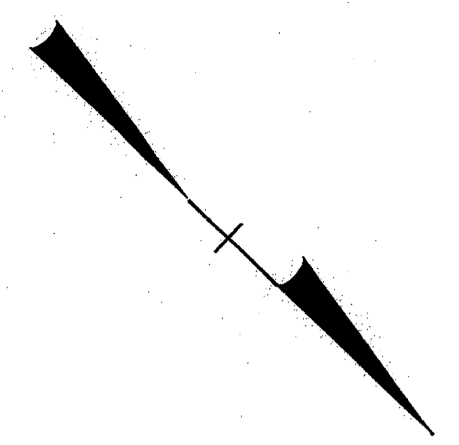

\$\$\$\$\$SYTIME\$\$\$\$\$
 \$\$\$SERVNAME\$\$\$\$\$

SEPI
 ENGINEERING &
 CONSTRUCTION

1025 Wade Avenue
 Raleigh, NC 27605
 Tel: 919-789-9977
 Fax: 919-789-9591
 License: C-2197

PAVEMENT MARKING DETAIL

TIP NO. R-5207A	SHEET NO. PMP-13
APPROVED: <i>St. M.</i>	
DATE: 9-5-12	
SEAL	

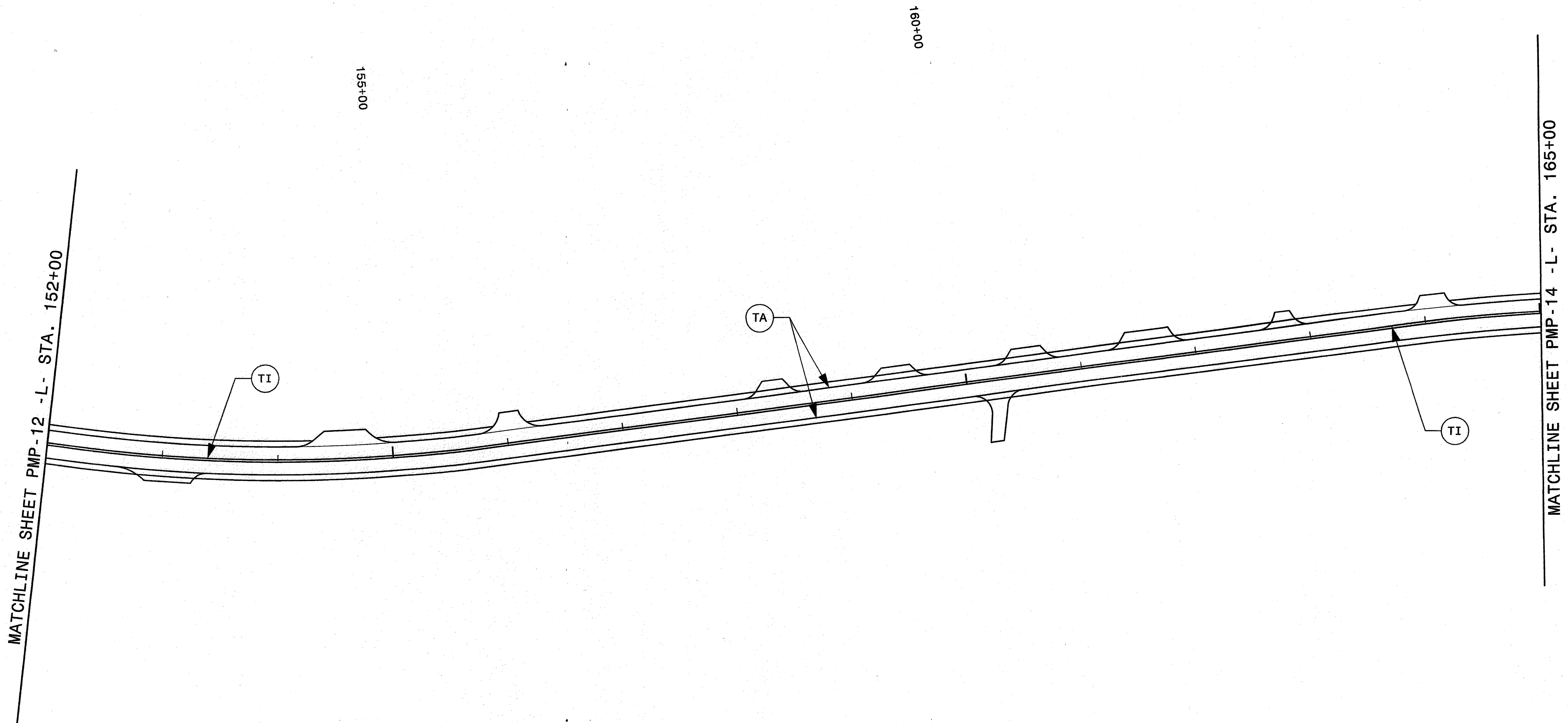
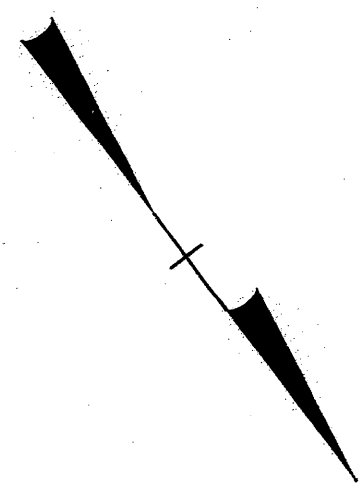

\$\$\$\$SYTIME\$\$\$\$
 \$\$\$USERNAME\$\$\$

SEPI
 ENGINEERING &
 CONSTRUCTION

1025 Wade Avenue
 Raleigh, NC 27605
 Tel: 919-789-9977
 Fax: 919-789-9591
 License: C-2197

PAVEMENT MARKING DETAIL

TIP NO.	SHEET NO.
R-5207A	PMP-14
APPROVED: <i>St. Miller</i>	
DATE: 0-5-12	
SEAL	

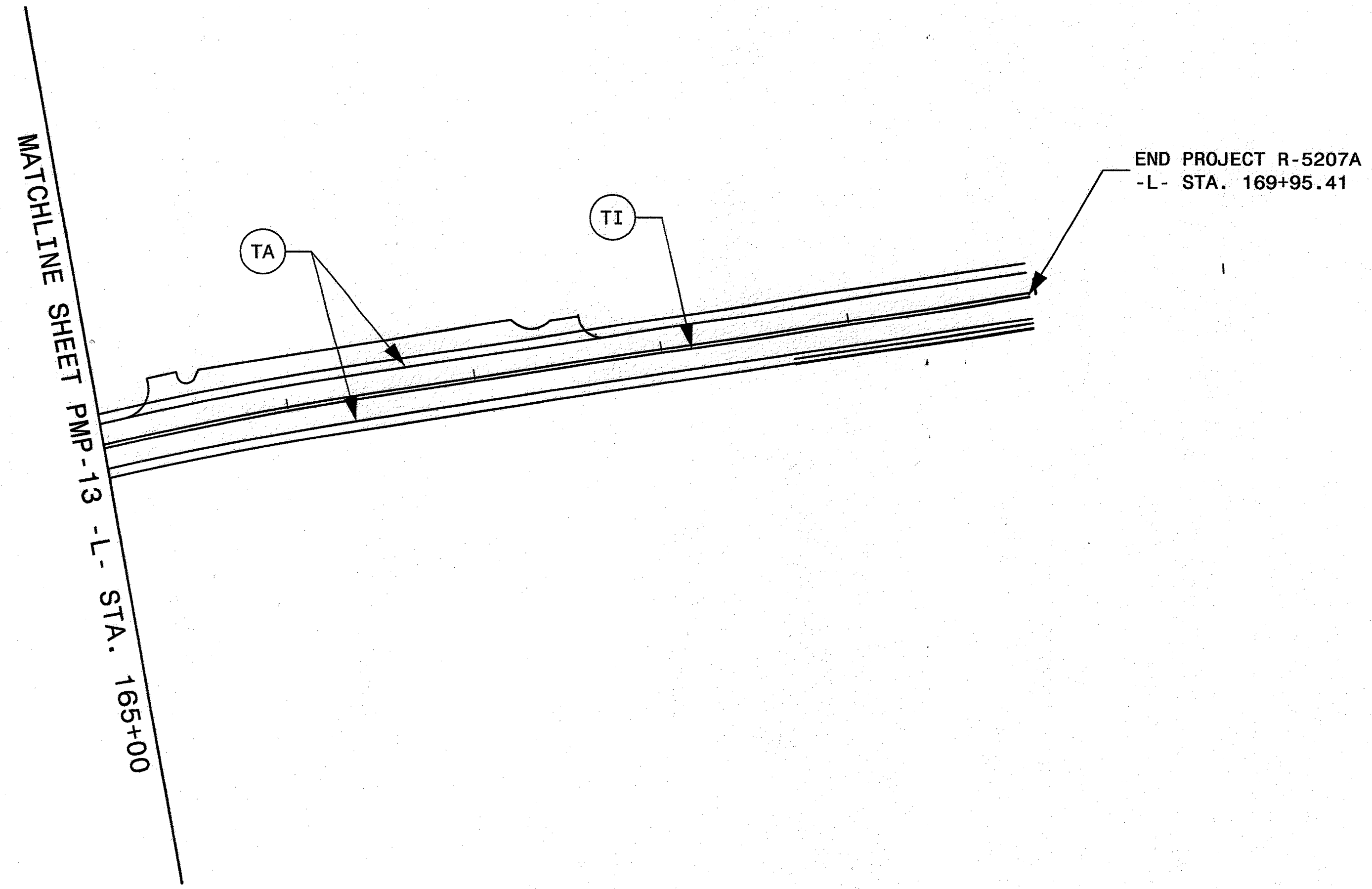
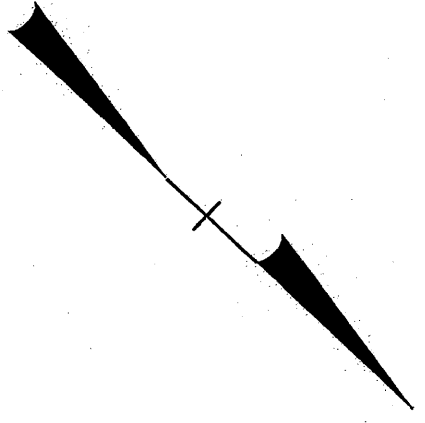

\$\$\$\$\$SYTIME\$\$\$\$\$
 \$\$\$>DGN\$\$\$\$\$
 \$\$\$USERNAME\$\$\$\$\$

SEPI
 ENGINEERING &
 CONSTRUCTION

1025 Wade Avenue
 Raleigh, NC 27605
 Tel: 919-789-9977
 Fax: 919-789-9591
 License: C-2197

PAVEMENT MARKING DETAIL

