

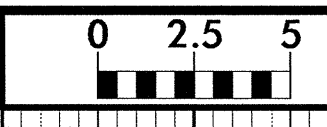

8/23/99

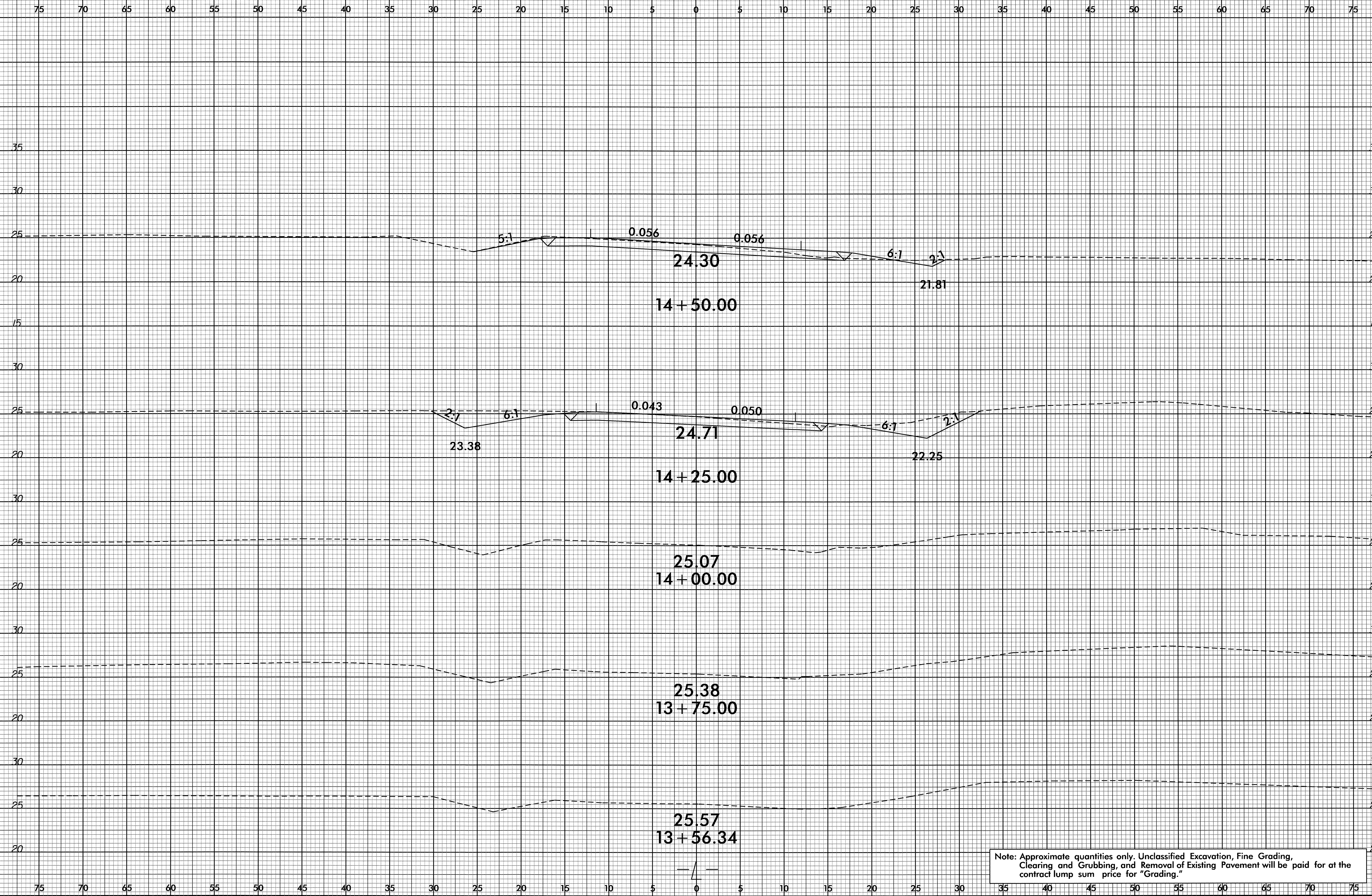

PROJ. REFERENCE NO.	SHEET NO.
B-4787	X-2



Note: Approximate quantities only. Unclassified Excavation, Fine Grading, Clearing and Grubbing, and Removal of Existing Pavement will be paid for at the contract lump sum price for "Grading."

01-MAY-2012 12:33  
 P:\Roads\X\CC\B4787\_rdu\_xpl.dgn  
 \$\$\$USERNAME\$\$\$

8/23/99

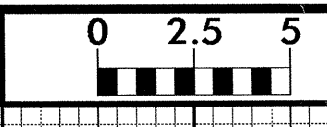

PROJ. REFERENCE NO.  
B-4787

SHEET NO.  
X-3

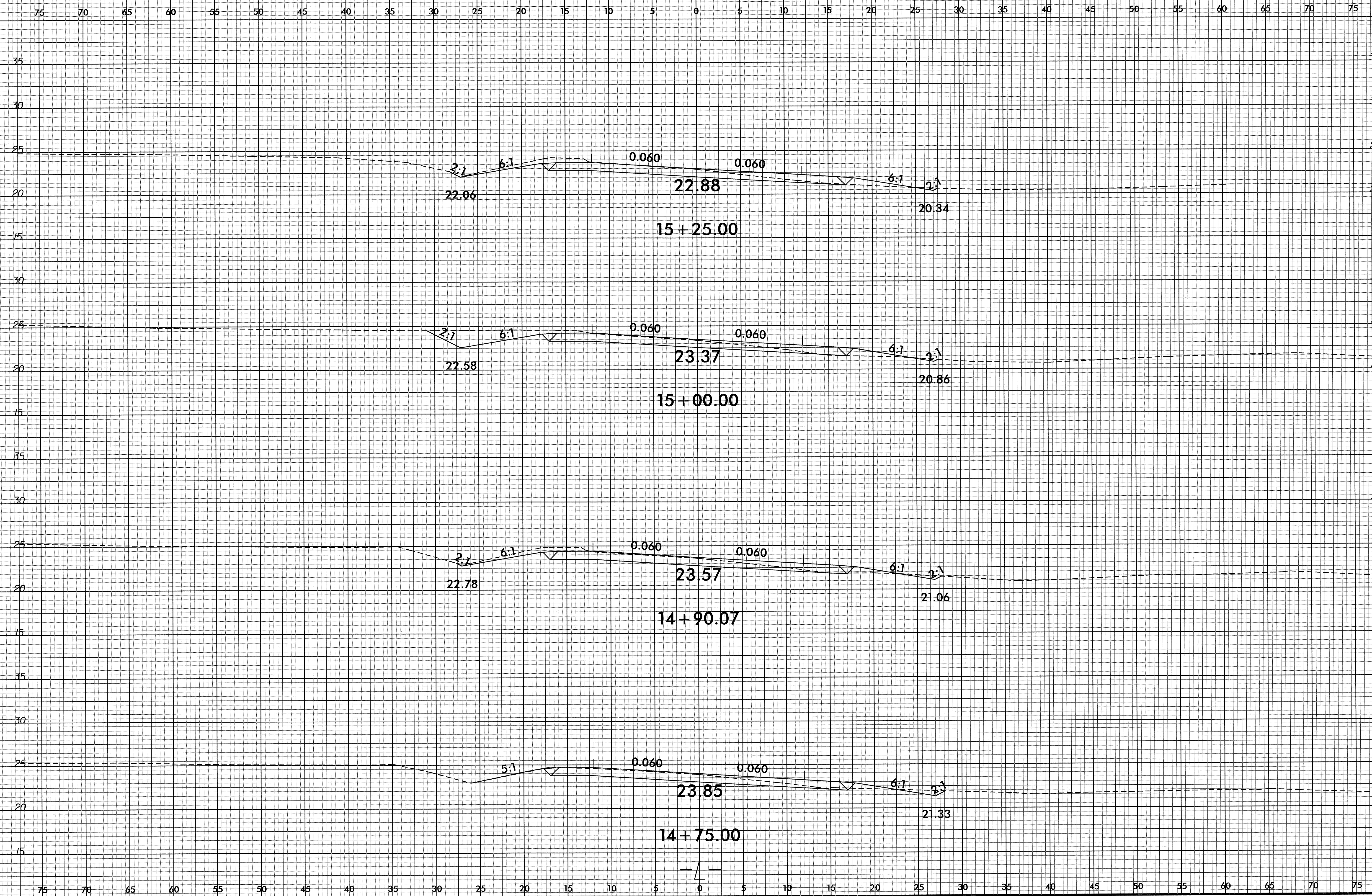

0-MAY-2012 12:33:47 787\_rdy\_xpl.dgn  
3135028787

8/23/99

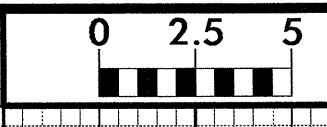

PROJ. REFERENCE NO.  
B-4787

SHEET NO.  
X-4

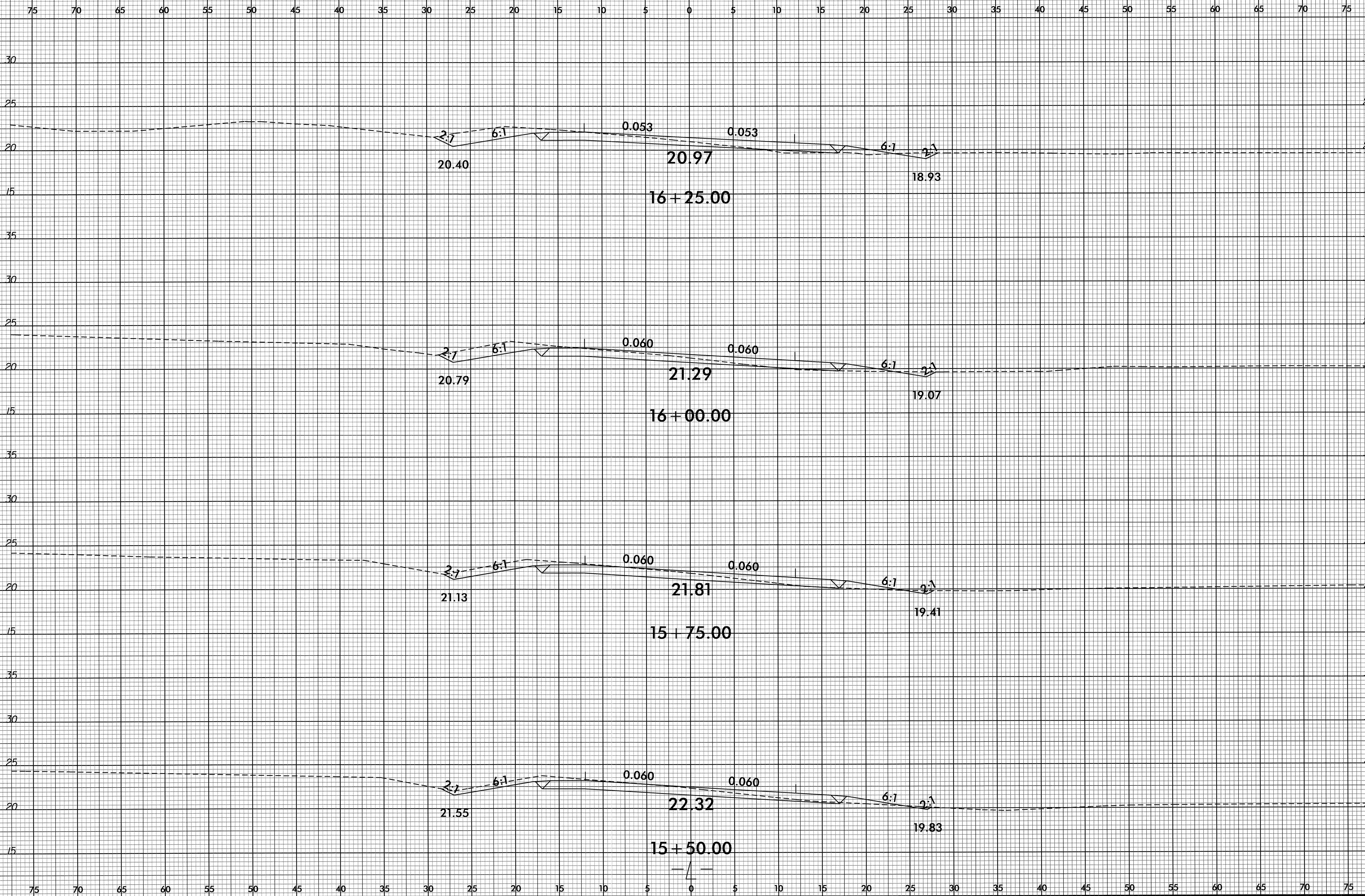

14-MAR-2012 09:06  
D:\MAR-2012\0906  
B-4787-rdu-1.dgn  
3:39:30 PM  
3:39:30 PM

8/23/99

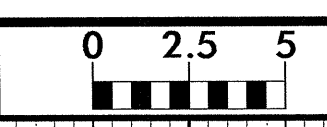

PROJ. REFERENCE NO.	SHEET NO.
B-4787	X-5

75 70 65 60 55 50 45 40 35 30 25 20 15 10 5 0 5 10 15 20 25 30 35 40 45 50 55 60 65 70 75

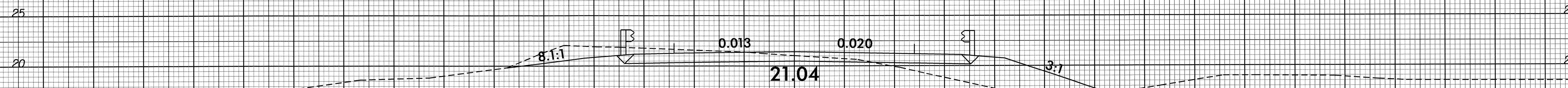

17+50.00

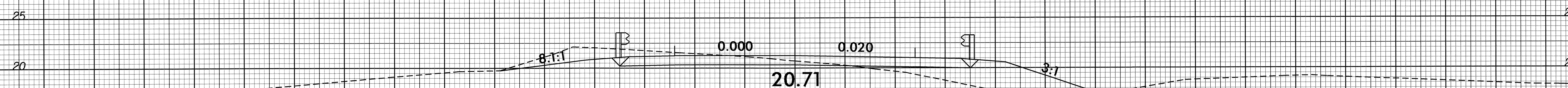

17+25.00

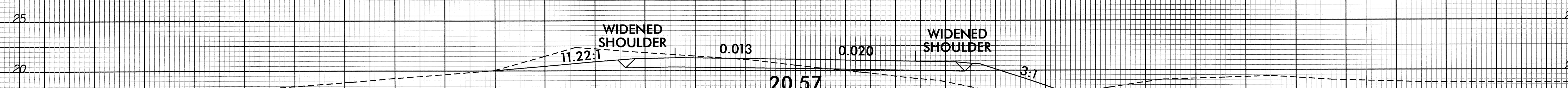

17+00.00

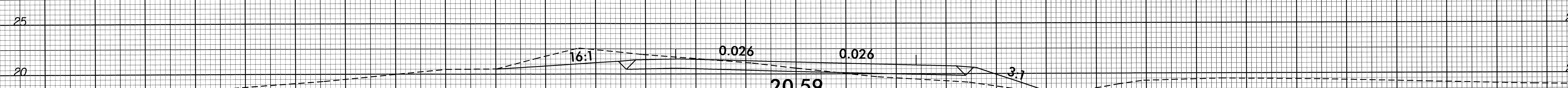

16+75.00

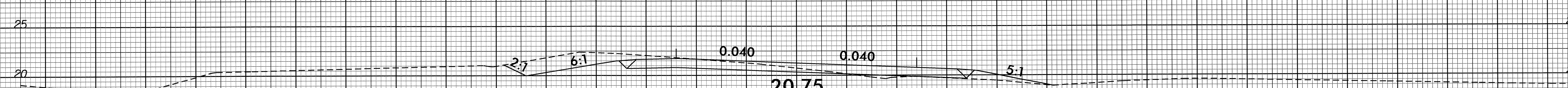

16+50.00

75 70 65 60 55 50 45 40 35 30 25 20 15 10 5 0 5 10 15 20 25 30 35 40 45 50 55 60 65 70 75

14-MAR-2012 09:06  
 P:\V\B\4787\_rdu\_xpl.dgn  
 \$\$\$\$SERIAL\$\$\$\$

8/23/99

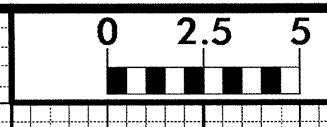

PROJ. REFERENCE NO.	SHEET NO.
B-4787	X-6

75 70 65 60 55 50 45 40 35 30 25 20 15 10 5 0 5 10 15 20 25 30 35 40 45 50 55 60 65 70 75

30 25 20 15 10

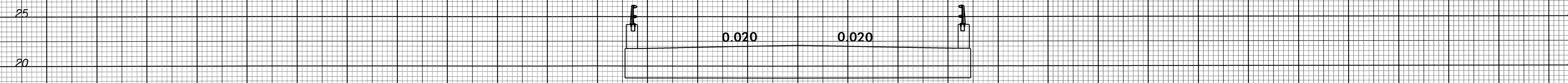

15.80  
18 + 25.00

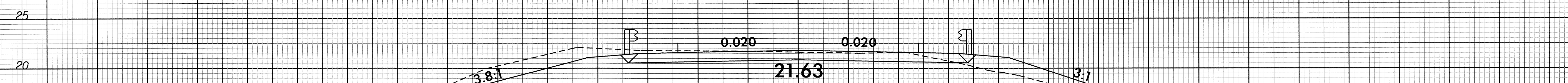

21.63  
17 + 92.00

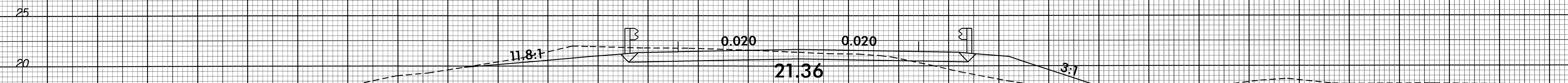

21.36  
17 + 75.00

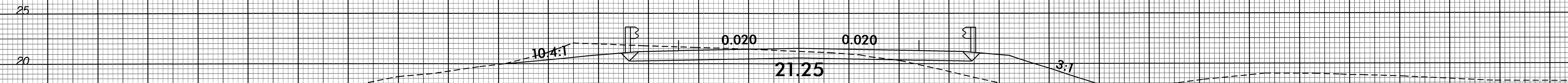

21.25  
17 + 63.16

75 70 65 60 55 50 45 40 35 30 25 20 15 10 5 0 5 10 15 20 25 30 35 40 45 50 55 60 65 70 75

14-MAR-2012 09:06  
S:\GIS\PROJECTS\1787\_rdy\_xpl.dgn

8/23/99

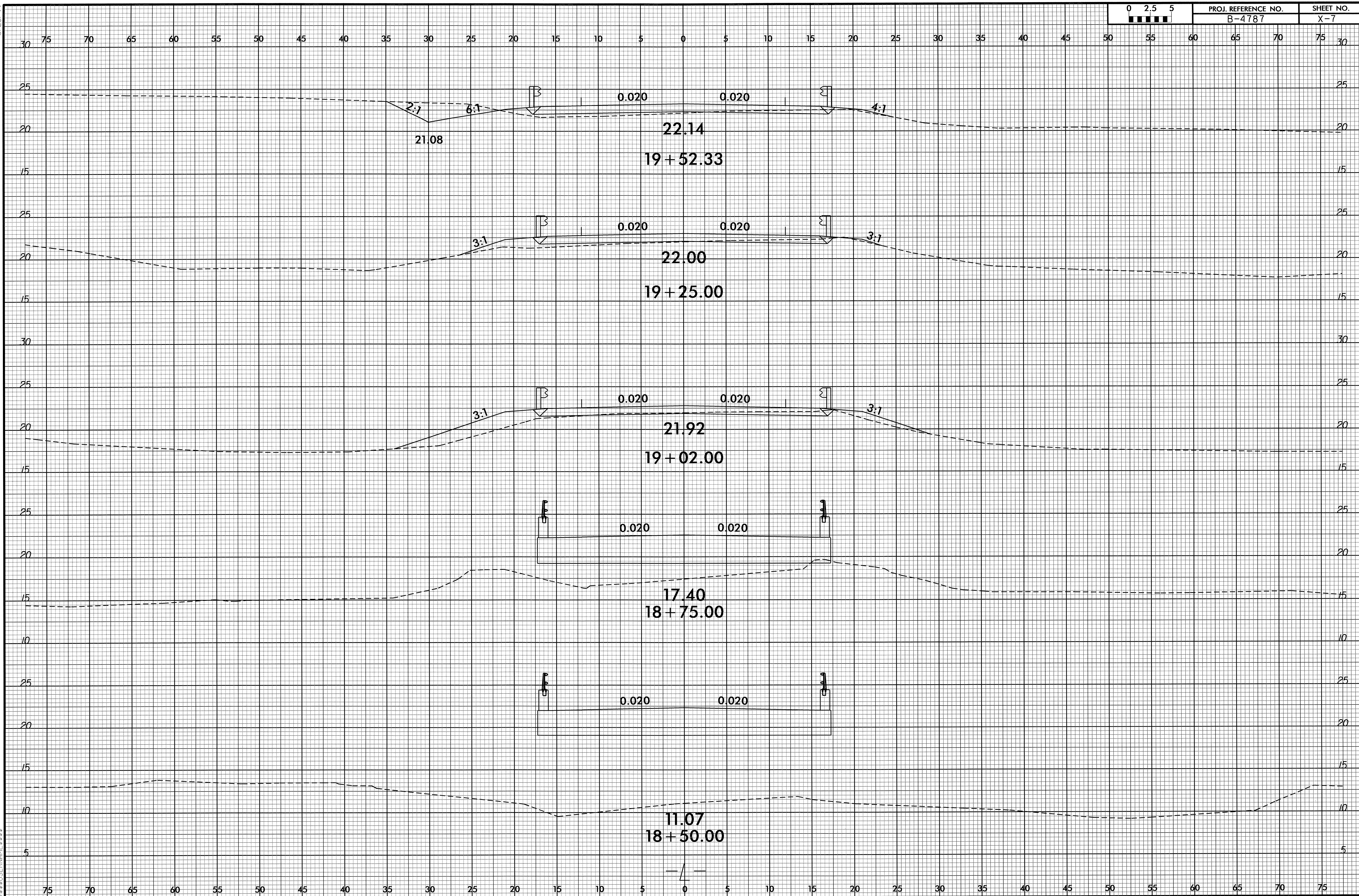

15-AUG-2002 14:42 I:\42\4787\_rdy\_xpl.dgn

8/23/99

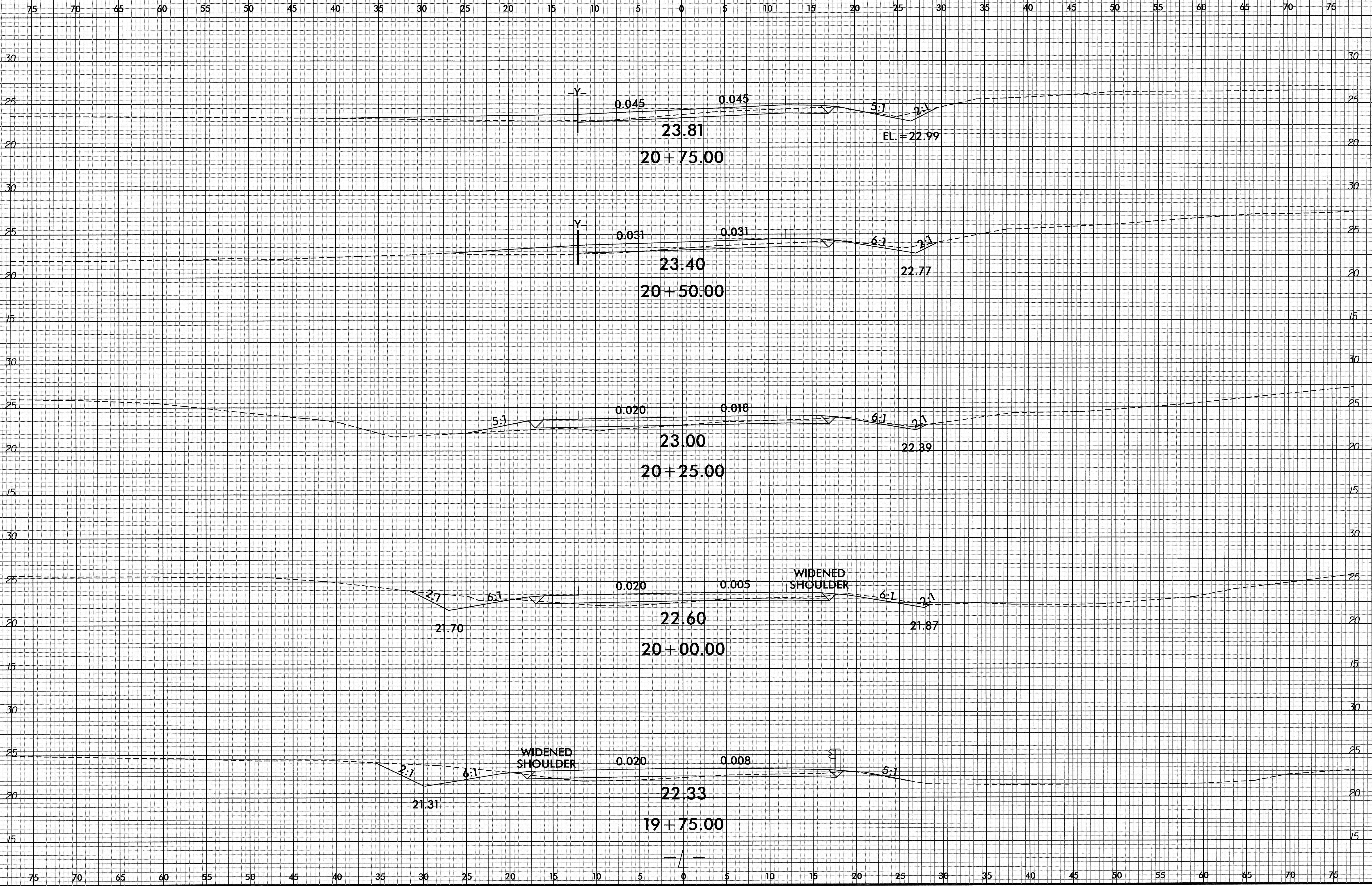

41 MAR-2012 09:06 23388.DWG 4787.rdy xpl.dgn



8/23/99

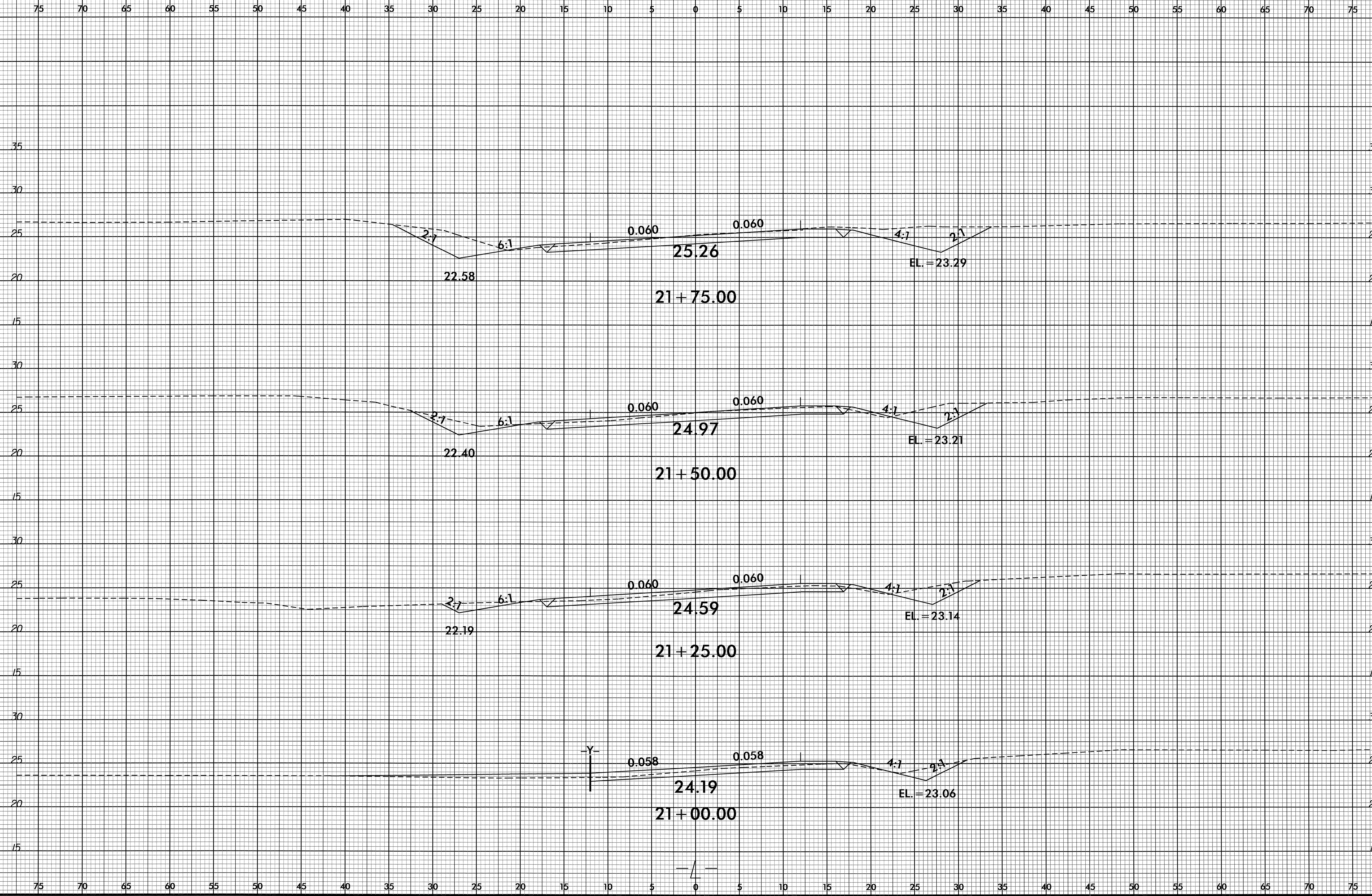

01-MAY-2012 12:33  
P:\Roadway\XSC\p4787\_rdy\_xpl.dgn  
\$\$\$\$USERNAME\$\$\$\$

8/23/99

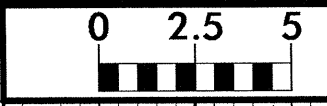

PROJ. REFERENCE NO.	SHEET NO.
B-4787	X-10

75 70 65 60 55 50 45 40 35 30 25 20 15 10 5 0 5 10 15 20 25 30 35 40 45 50 55 60 65 70 75

35  
30  
25  
20  
15

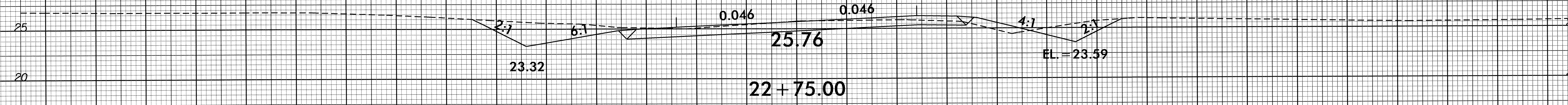

30  
25  
20  
15

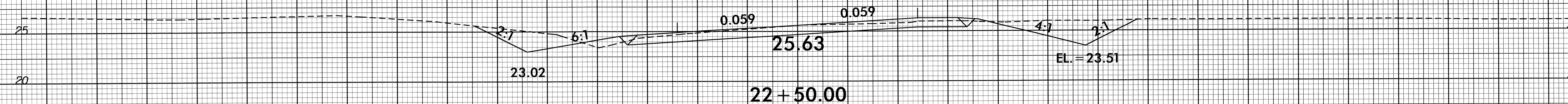

30  
25  
20  
15

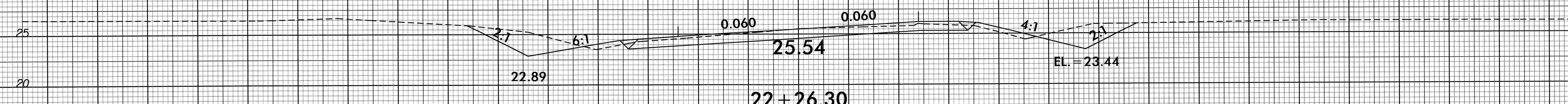

35  
30  
25  
20  
15

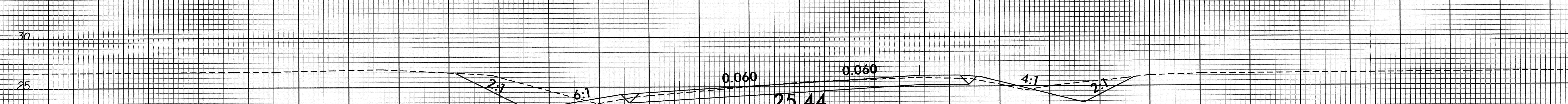

35  
30  
25  
20  
15

75 70 65 60 55 50 45 40 35 30 25 20 15 10 5 0 5 10 15 20 25 30 35 40 45 50 55 60 65 70 75

01-MAY-2012 12:33  
P:\PROJECTS\1256787\rdy\_xpl.dgn

8/23/99

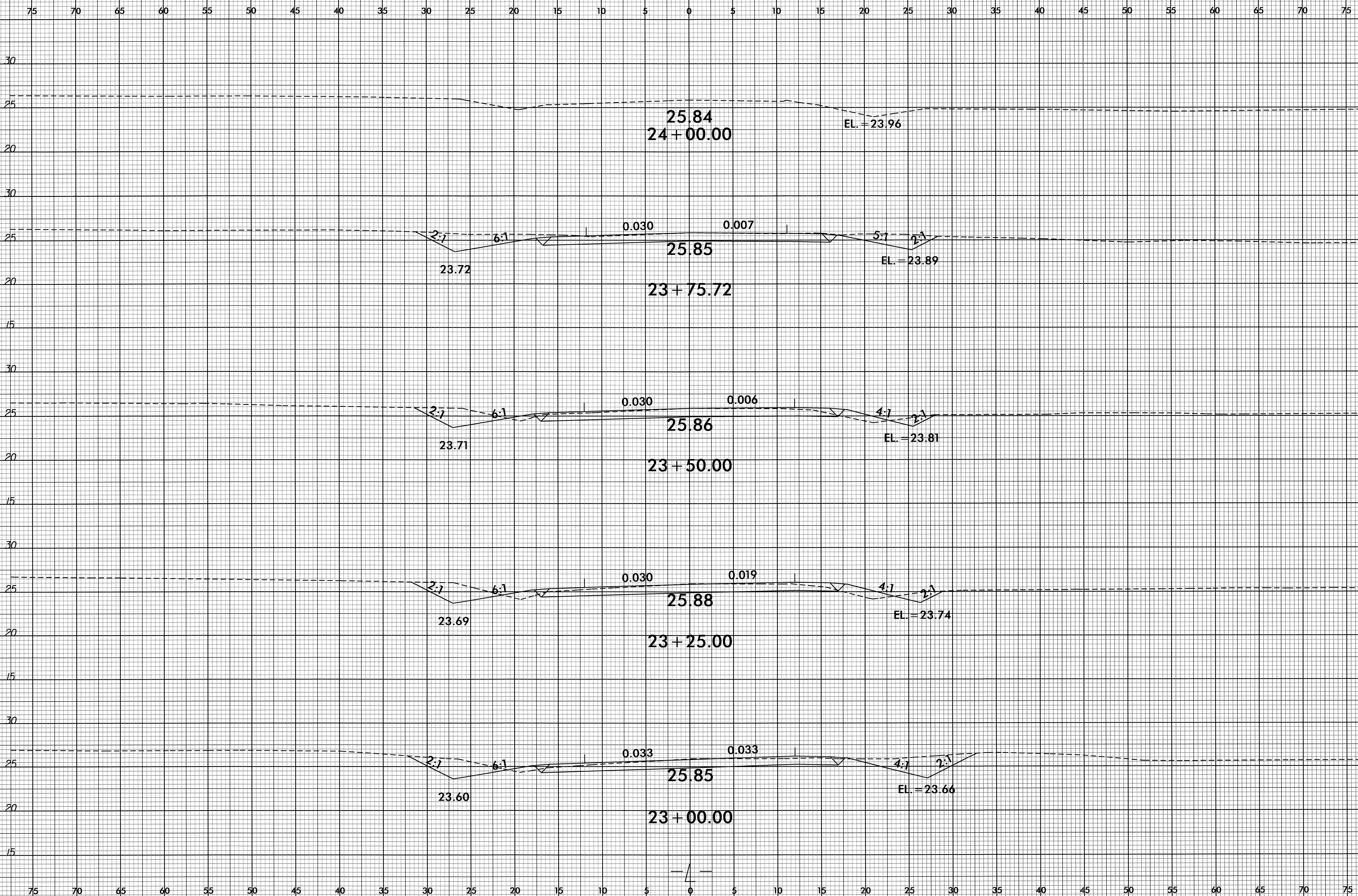

01 MAY 2010 09:33  
C:\PROJ\B30\B4787\_r.dwg - xpl.dgn  
\$\$\$\$\$USERNAME\$\$\$\$\$

8/23/99

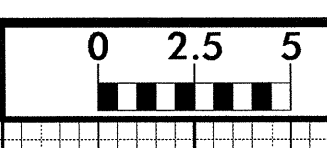

PROJ. REFERENCE NO.  
B-4787

SHEET NO.  
X-12

75 70 65 60 55 50 45 40 35 30 25 20 15 10 5 0 5 10 15 20 25 30 35 40 45 50 55 60 65 70 75

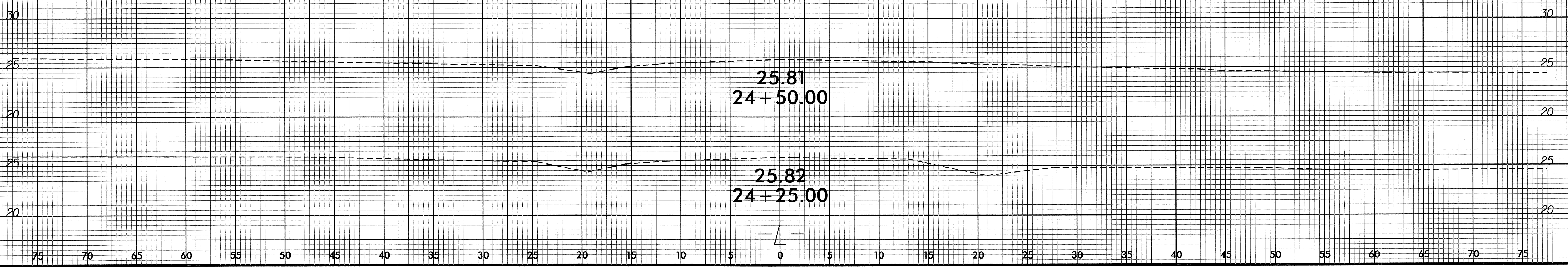

14-MAR-2002 09:05  
P:\V\N\VC\B-4787-rdy.xpl.dgn