

PROJECT SPECIAL PROVISION

(10-18-95)

Z-1

PERMITS

The Contractor's attention is directed to the following permits, which have been issued to the Department of Transportation by the authority granting the permit.

<u>PERMIT</u>	<u>AUTHORITY GRANTING THE PERMIT</u>
Dredge and Fill and/or Work in Navigable Waters (404)	U. S. Army Corps of Engineers
State Dredge and Fill and/or CAMA	Division of Coastal Management, DENR State of North Carolina
Water Quality (401)	Division of Environmental Management, DENR State of North Carolina
Buffer Certification	Division of Environmental Management, DENR State of North Carolina

The Contractor shall comply with all applicable permit conditions during construction of this project. Those conditions marked by * are the responsibility of the department and the Contractor has no responsibility in accomplishing those conditions.

Agents of the permitting authority will periodically inspect the project for adherence to the permits.

The Contractor's attention is also directed to Articles 107-10 and 107-13 of the *2012 Standard Specifications* and the following:

Should the Contractor propose to utilize construction methods (such as temporary structures or fill in waters and/or wetlands for haul roads, work platforms, cofferdams, etc.) not specifically identified in the permit (individual, general, or nationwide) authorizing the project it shall be the Contractor's responsibility to coordinate with the Engineer to determine what, if any, additional permit action is required. The Contractor shall also be responsible for initiating the request for the authorization of such construction method by the permitting agency. The request shall be submitted through the Engineer. The Contractor shall not utilize the construction method until it is approved by the permitting agency. The request normally takes approximately 60 days to process; however, no extensions of time or additional compensation will be granted for delays resulting from the Contractor's request for approval of construction methods not specifically identified in the permit.

Where construction moratoriums are contained in a permit condition which restricts the Contractor's activities to certain times of the year, those moratoriums will apply only to the portions of the work taking place in the waters or wetlands provided that activities outside those areas is done in such a manner as to not affect the waters or wetlands.



STATE OF NORTH CAROLINA
DEPARTMENT OF TRANSPORTATION

BEVERLY EAVES PURDUE
GOVERNOR

EUGENE A. CONTI, JR.
SECRETARY

May 22, 2012

To: File

From: Chris Underwood, Environmental Specialist

Subject: B-4421 Section 404 Permit by Default

The Section 404 permit for this project has been issued by default, as the U.S. Army Corps of Engineers review time period has exceeded 45 days (per Nationwide Permit General Condition number 27). Therefore, NCDOT must comply with all conditions, descriptions, and mitigation allowance in the January 30, 2012 permit application (includes the Pre-Construction Notification Form and Permit Drawings), as well as the 404 General Conditions and 401 Standard Conditions. A permit modification will be required if any of the above conditions, descriptions, and mitigation allowances cannot be met.

MAILING ADDRESS:
NC DEPARTMENT OF TRANSPORTATION
PROJECT DEVELOPMENT AND ENVIRONMENTAL ANALYSIS
1598 MAIL SERVICE CENTER
RALEIGH NC 27699-1598

TELEPHONE: 919-707-6100
FAX: 919-212-5785

WEBSITE: WWW.NCDOT.ORG

LOCATION:
1020 BIRCH RIDGE DRIVE
RALEIGH NC 27610-4328

**NATIONWIDE PERMIT 3
DEPARTMENT OF THE ARMY
CORPS OF ENGINEERS
FINAL NOTICE OF ISSUANCE AND MODIFICATION OF NATIONWIDE PERMITS
FEDERAL REGISTER
AUTHORIZED MARCH 19, 2007**

Maintenance. (a) The repair, rehabilitation, or replacement of any previously authorized, currently serviceable, structure, or fill, or of any currently serviceable structure or fill authorized by 33 CFR 330.3, provided that the structure or fill is not to be put to uses differing from those uses specified or contemplated for it in the original permit or the most recently authorized modification. Minor deviations in the structure's configuration or filled area, including those due to changes in materials, construction techniques, or current construction codes or safety standards that are necessary to make the repair, rehabilitation, or replacement are authorized. This NWP authorizes the repair, rehabilitation, or replacement of those structures or fills destroyed or damaged by storms, floods, fire or other discrete events, provided the repair, rehabilitation, or replacement is commenced, or is under contract to commence, within two years of the date of their destruction or damage. In cases of catastrophic events, such as hurricanes or tornadoes, this two-year limit may be waived by the district engineer, provided the permittee can demonstrate funding, contract, or other similar delays.

(b) This NWP also authorizes the removal of accumulated sediments and debris in the vicinity of and within existing structures (e.g., bridges, culverted road crossings, water intake structures, etc.) and the placement of new or additional riprap to protect the structure. The removal of sediment is limited to the minimum necessary to restore the waterway in the immediate vicinity of the structure to the approximate dimensions that existed when the structure was built, but cannot extend further than 200 feet in any direction from the structure. This 200 foot limit does not apply to maintenance dredging to remove accumulated sediments blocking or restricting outfall and intake structures or to maintenance dredging to remove accumulated sediments from canals associated with outfall and intake structures. All dredged or excavated materials must be deposited and retained in an upland area unless otherwise specifically approved by the district engineer under separate authorization. The placement of riprap must be the minimum necessary to protect the structure or to ensure the safety of the structure. Any bank stabilization measures not directly associated with the structure will require a separate authorization from the district engineer.

(c) This NWP also authorizes temporary structures, fills, and work necessary to conduct the maintenance activity. Appropriate measures must be taken to maintain normal downstream flows and minimize flooding to the maximum extent practicable, when temporary structures, work, and discharges, including cofferdams, are necessary for construction activities, access fills, or dewatering of construction sites. Temporary fills must consist of materials, and be placed in a manner, that will not be eroded by expected high flows. Temporary fills must be removed in their entirety and the affected areas returned to pre-construction elevations. The areas affected by temporary fills must be revegetated, as appropriate.

(d) This NWP does not authorize maintenance dredging for the primary purpose of navigation or beach restoration. This NWP does not authorize new stream channelization or stream relocation projects.

* Notification: For activities authorized by paragraph (b) of this NWP, the permittee must submit a pre-construction notification to the district engineer prior to commencing the activity (see general condition 27). Where maintenance dredging is proposed, the pre-construction notification must include information regarding the original design capacities and configurations of the outfalls, intakes, small impoundments, and canals. (Sections 10 and 404)

Note: This NWP authorizes the repair, rehabilitation, or replacement of any previously authorized structure or fill that does not qualify for the Clean Water Act Section 404(f) exemption for maintenance.

NATIONWIDE PERMIT 12
DEPARTMENT OF THE ARMY
CORPS OF ENGINEERS
FINAL NOTICE OF ISSUANCE AND MODIFICATION OF NATIONWIDE PERMITS
FEDERAL REGISTER
AUTHORIZED MARCH 19, 2007

Utility Line Activities. Activities required for the construction, maintenance, repair, and removal of utility lines and associated facilities in waters of the United States, provided the activity does not result in the loss of greater than 1/2 acre of waters of the United States.

Utility lines: This NWP authorizes the construction, maintenance, or repair of utility lines, including outfall and intake structures, and the associated excavation, backfill, or bedding for the utility lines, in all waters of the United States, provided there is no change in pre-construction contours. A “utility line” is defined as any pipe or pipeline for the transportation of any gaseous, liquid, liquescent, or slurry substance, for any purpose, and any cable, line, or wire for the transmission for any purpose of electrical energy, telephone, and telegraph messages, and radio and television communication. The term “utility line” does not include activities that drain a water of the United States, such as drainage tile or french drains, but it does apply to pipes conveying drainage from another area.

Material resulting from trench excavation may be temporarily sidecast into waters of the United States for no more than three months, provided the material is not placed in such a manner that it is dispersed by currents or other forces. The district engineer may extend the period of temporary side casting for no more than a total of 180 days, where appropriate. In wetlands, the top 6 to 12 inches of the trench should normally be backfilled with topsoil from the trench. The trench cannot be constructed or backfilled in such a manner as to drain waters of the United States (e.g., backfilling with extensive gravel layers, creating a french drain effect). Any exposed slopes and stream banks must be stabilized immediately upon completion of the utility line crossing of each waterbody.

Utility line substations: This NWP authorizes the construction, maintenance, or expansion of substation facilities associated with a power line or utility line in non-tidal waters of the United States, provided the activity, in combination with all other activities included in one single and complete project, does not result in the loss of greater than 1/2 acre of waters of the United States. This NWP does not authorize discharges into non-tidal wetlands adjacent to tidal waters of the United States to construct, maintain, or expand substation facilities.

Foundations for overhead utility line towers, poles, and anchors: This NWP authorizes the construction or maintenance of foundations for overhead utility line towers, poles, and anchors in all waters of the United States, provided the foundations are the minimum size necessary and separate footings for each tower leg (rather than a larger single pad) are used where feasible.

Access roads: This NWP authorizes the construction of access roads for the construction and maintenance of utility lines, including overhead power lines and utility line substations, in non-tidal waters of the United States, provided the total discharge from a single and complete project does not cause the loss of greater than 1/2-acre of non-tidal waters of the United States. This NWP does not authorize discharges into non-tidal wetlands adjacent to tidal waters for access roads. Access roads must be the minimum width necessary (see Note 2, below). Access

roads must be constructed so that the length of the road minimizes any adverse effects on waters of the United States and must be as near as possible to pre-construction contours and elevations (e.g., at grade corduroy roads or geotextile/gravel roads). Access roads constructed above pre-construction contours and elevations in waters of the United States must be properly bridged or culverted to maintain surface flows.

This NWP may authorize utility lines in or affecting navigable waters of the United States even if there is no associated discharge of dredged or fill material (See 33 CFR Part 322). Overhead utility lines constructed over section 10 waters and utility lines that are routed in or under section 10 waters without a discharge of dredged or fill material require a section 10 permit.

This NWP also authorizes temporary structures, fills, and work necessary to conduct the utility line activity. Appropriate measures must be taken to maintain normal downstream flows and minimize flooding to the maximum extent practicable, when temporary structures, work, and discharges, including cofferdams, are necessary for construction activities, access fills, or dewatering of construction sites. Temporary fills must consist of materials, and be placed in a manner, that will not be eroded by expected high flows. Temporary fills must be removed in their entirety and the affected areas returned to pre-construction elevations. The areas affected by temporary fills must be revegetated, as appropriate.

- * Notification: The permittee must submit a pre-construction notification to the district engineer prior to commencing the activity if any of the following criteria are met: (1) the activity involves mechanized land clearing in a forested wetland for the utility line right-of-way; (2) a section 10 permit is required; (3) the utility line in waters of the United States, excluding overhead lines, exceeds 500 feet; (4) the utility line is placed within a jurisdictional area (i.e., water of the United States), and it runs parallel to a stream bed that is within that jurisdictional area; (5) discharges that result in the loss of greater than 1/10-acre of waters of the United States; (6) permanent access roads are constructed above grade in waters of the United States for a distance of more than 500 feet; or (7) permanent access roads are constructed in waters of the United States with impervious materials. (See general condition 27.) (Sections 10 and 404)

Note 1: Where the proposed utility line is constructed or installed in navigable waters of the United States (i.e., section 10 waters), copies of the pre-construction notification and NWP verification will be sent by the Corps to the National Oceanic and Atmospheric Administration (NOAA), National Ocean Service (NOS), for charting the utility line to protect navigation.

Note 2: Access roads used for both construction and maintenance may be authorized, provided they meet the terms and conditions of this NWP. Access roads used solely for construction of the utility line must be removed upon completion of the work, accordance with the requirements for temporary fills.

Note 3: Pipes or pipelines used to transport gaseous, liquid, liquescent, or slurry substances over navigable waters of the United States are considered to be bridges, not utility lines, and may require a permit from the U.S. Coast Guard pursuant to Section 9 of the Rivers and Harbors Act of 1899. However, any discharges of dredged or fill material into waters of the United States associated with such pipelines will require a section 404 permit (see NWP 15).

NATIONWIDE PERMIT CONDITIONS

The following General Conditions must be followed in order for any authorization by a NWP to be valid:

1. Navigation. (a) No activity may cause more than a minimal adverse effect on navigation.
(b) Any safety lights and signals prescribed by the U.S. Coast Guard, through regulations or otherwise, must be installed and maintained at the permittee's expense on authorized facilities in navigable waters of the United States.
(c) The permittee understands and agrees that, if future operations by the United States require the removal, relocation, or other alteration, of the structure or work herein authorized, or if, in the opinion of the Secretary of the Army or his authorized representative, said structure or work shall cause unreasonable obstruction to the free navigation of the navigable waters, the permittee will be required, upon due notice from the Corps of Engineers, to remove, relocate, or alter the structural work or obstructions caused thereby, without expense to the United States. No claim shall be made against the United States on account of any such removal or alteration.
2. Aquatic Life Movements. No activity may substantially disrupt the necessary life cycle movements of those species of aquatic life indigenous to the waterbody, including those species that normally migrate through the area, unless the activity's primary purpose is to impound water. Culverts placed in streams must be installed to maintain low flow conditions.
3. Spawning Areas. Activities in spawning areas during spawning seasons must be avoided to the maximum extent practicable. Activities that result in the physical destruction (e.g., through excavation, fill, or downstream smothering by substantial turbidity) of an important spawning area are not authorized.
4. Migratory Bird Breeding Areas. Activities in waters of the United States that serve as breeding areas for migratory birds must be avoided to the maximum extent practicable.
5. Shellfish Beds. No activity may occur in areas of concentrated shellfish populations, unless the activity is directly related to a shellfish harvesting activity authorized by NWPs 4 and 48.
6. Suitable Material. No activity may use unsuitable material (e.g., trash, debris, car bodies, asphalt, etc.). Material used for construction or discharged must be free from toxic pollutants in toxic amounts (see Section 307 of the Clean Water Act).
7. Water Supply Intakes. No activity may occur in the proximity of a public water supply intake, except where the activity is for the repair or improvement of public water supply intake structures or adjacent bank stabilization.
8. Adverse Effects From Impoundments. If the activity creates an impoundment of water, adverse effects to the aquatic system due to accelerating the passage of water, and/or restricting its flow must be minimized to the maximum extent practicable.
9. Management of Water Flows. To the maximum extent practicable, the pre-construction course, condition, capacity, and location of open waters must be maintained for each activity, including stream channelization and storm water management activities, except as provided below. The activity must be constructed to withstand expected high flows. The activity must not restrict or impede the passage of normal or high flows, unless the primary purpose of the activity is to impound water or manage high flows. The activity may alter the pre-construction course, condition, capacity, and location of open waters if it benefits the aquatic environment (e.g., stream restoration or relocation activities).
10. Fills Within 100-Year Floodplains. The activity must comply with applicable FEMA-approved state or local floodplain management requirements.
11. Equipment. Heavy equipment working in wetlands or mudflats must be placed on mats, or other measures must be taken to minimize soil disturbance.

12. Soil Erosion and Sediment Controls. Appropriate soil erosion and sediment controls must be used and maintained in effective operating condition during construction, and all exposed soil and other fills, as well as any work below the ordinary high water mark or high tide line, must be permanently stabilized at the earliest practicable date. Permittees are encouraged to perform work within waters of the United States during periods of low-flow or no-flow.

13. Removal of Temporary Fills. Temporary fills must be removed in their entirety and the affected areas returned to pre-construction elevations. The affected areas must be revegetated, as appropriate.

14. Proper Maintenance. Any authorized structure or fill shall be properly maintained, including maintenance to ensure public safety.

15. Wild and Scenic Rivers. No activity may occur in a component of the National Wild and Scenic River System, or in a river officially designated by Congress as a “study river” for possible inclusion in the system while the river is in an official study status, unless the appropriate Federal agency with direct management responsibility for such river, has determined in writing that the proposed activity will not adversely affect the Wild and Scenic River designation or study status. Information on Wild and Scenic Rivers may be obtained from the appropriate Federal land management agency in the area (e.g., National Park Service, U.S. Forest Service, Bureau of Land Management, U.S. Fish and Wildlife Service).

16. Tribal Rights. No activity or its operation may impair reserved tribal rights, including, but not limited to, reserved water rights and treaty fishing and hunting rights.

17. Endangered Species. (a) No activity is authorized under any NWP which is likely to jeopardize the continued existence of a threatened or endangered species or a species proposed for such designation, as identified under the Federal Endangered Species Act (ESA), or which will destroy or adversely modify the critical habitat of such species. No activity is authorized under any NWP which “may affect” a listed species or critical habitat, unless Section 7 consultation addressing the effects of the proposed activity has been completed.

(b) Federal agencies should follow their own procedures for complying with the requirements of the ESA. Federal permittees must provide the district engineer with the appropriate documentation to demonstrate compliance with those requirements.

* (c) Non-federal permittees shall notify the district engineer if any listed species or designated critical habitat might be affected or is in the vicinity of the project, or if the project is located in designated critical habitat, and shall not begin work on the activity until notified by the district engineer that the requirements of the ESA have been satisfied and that the activity is authorized. For activities that might affect Federally-listed endangered or threatened species or designated critical habitat, the pre-construction notification must include the name(s) of the endangered or threatened species that may be affected by the proposed work or that utilize the designated critical habitat that may be affected by the proposed work. The district engineer will determine whether the proposed activity “may affect” or will have “no effect” to listed species and designated critical habitat and will notify the non-Federal applicant of the Corps’ determination within 45 days of receipt of a complete pre-construction notification. In cases where the non-Federal applicant has identified listed species or critical habitat that might be affected or is in the vicinity of the project, and has so notified the Corps, the applicant shall not begin work until the Corps has provided notification the proposed activities will have “no effect” on listed species or critical habitat, or until Section 7 consultation has been completed.

(d) As a result of formal or informal consultation with the FWS or NMFS the district engineer may add species-specific regional endangered species conditions to the NWPs.

(e) Authorization of an activity by a NWP does not authorize the “take” of a threatened or endangered species as defined under the ESA. In the absence of separate authorization (e.g., an ESA Section 10 Permit, a Biological Opinion with “incidental take” provisions, etc.) from the U.S. FWS or the

NMFS, both lethal and non-lethal “takes” of protected species are in violation of the ESA. Information on the location of threatened and endangered species and their critical habitat can be obtained directly from the offices of the U.S. FWS and NMFS or their world wide Web pages at <http://www.fws.gov/> and <http://www.noaa.gov/fisheries.html> respectively.

18. Historic Properties. (a) In cases where the district engineer determines that the activity may affect properties listed, or eligible for listing, in the National Register of Historic Places, the activity is not authorized, until the requirements of Section 106 of the National Historic Preservation Act (NHPA) have been satisfied.

(b) Federal permittees should follow their own procedures for complying with the requirements of Section 106 of the National Historic Preservation Act. Federal permittees must provide the district engineer with the appropriate documentation to demonstrate compliance with those requirements.

* (c) Non-federal permittees must submit a pre-construction notification to the district engineer if the authorized activity may have the potential to cause effects to any historic properties listed, determined to be eligible for listing on, or potentially eligible for listing on the National Register of Historic Places, including previously unidentified properties. For such activities, the pre-construction notification must state which historic properties may be affected by the proposed work or include a vicinity map indicating the location of the historic properties or the potential for the presence of historic properties. Assistance regarding information on the location of or potential for the presence of historic resources can be sought from the State Historic Preservation Officer or Tribal Historic Preservation Officer, as appropriate, and the National Register of Historic Places (see 33 CFR 330.4(g)). The district engineer shall make a reasonable and good faith effort to carry out appropriate identification efforts, which may include background research, consultation, oral history interviews, sample field investigation, and field survey. Based on the information submitted and these efforts, the district engineer shall determine whether the proposed activity has the potential to cause an effect on the historic properties. Where the non-Federal applicant has identified historic properties which the activity may have the potential to cause effects and so notified the Corps, the non-Federal applicant shall not begin the activity until notified by the district engineer either that the activity has no potential to cause effects or that consultation under Section 106 of the NHPA has been completed.

(d) The district engineer will notify the prospective permittee within 45 days of receipt of a complete pre-construction notification whether NHPA Section 106 consultation is required. Section 106 consultation is not required when the Corps determines that the activity does not have the potential to cause effects on historic properties (see 36 CFR 800.3(a)). If NHPA section 106 consultation is required and will occur, the district engineer will notify the non-Federal applicant that he or she cannot begin work until Section 106 consultation is completed.

(e) Prospective permittees should be aware that section 110k of the NHPA (16 U.S.C. 470h-2(k)) prevents the Corps from granting a permit or other assistance to an applicant who, with intent to avoid the requirements of Section 106 of the NHPA, has intentionally significantly adversely affected a historic property to which the permit would relate, or having legal power to prevent it, allowed such significant adverse effect to occur, unless the Corps, after consultation with the Advisory Council on Historic Preservation (ACHP), determines that circumstances justify granting such assistance despite the adverse effect created or permitted by the applicant. If circumstances justify granting the assistance, the Corps is required to notify the ACHP and provide documentation specifying the circumstances, explaining the degree of damage to the integrity of any historic properties affected, and proposed mitigation. This documentation must include any views obtained from the applicant, SHPO/THPO, appropriate Indian tribes if the undertaking occurs on or affects historic properties on tribal lands or affects properties of interest to those tribes, and other parties known to have a legitimate interest in the impacts to the permitted activity on historic properties.

19. Designated Critical Resource Waters. Critical resource waters include, NOAA-designated marine sanctuaries, National Estuarine Research Reserves, state natural heritage sites, and outstanding

national resource waters or other waters officially designated by a state as having particular environmental or ecological significance and identified by the district engineer after notice and opportunity for public comment. The district engineer may also designate additional critical resource waters after notice and opportunity for comment.

(a) Discharges of dredged or fill material into waters of the United States are not authorized by NWPs 7, 12, 14, 16, 17, 21, 29, 31, 35, 39, 40, 42, 43, 44, 49, and 50 for any activity within, or directly affecting, critical resource waters, including wetlands adjacent to such waters.

(b) For NWPs 3, 8, 10, 13, 15, 18, 19, 22, 23, 25, 27, 28, 30, 33, 34, 36, 37, and 38, notification is required in accordance with general condition 27, for any activity proposed in the designated critical resource waters including wetlands adjacent to those waters. The district engineer may authorize activities under these NWPs only after it is determined that the impacts to the critical resource waters will be no more than minimal.

20. Mitigation. The district engineer will consider the following factors when determining appropriate and practicable mitigation necessary to ensure that adverse effects on the aquatic environment are minimal:

(a) The activity must be designed and constructed to avoid and minimize adverse effects, both temporary and permanent, to waters of the United States to the maximum extent practicable at the project site (i.e., on site).

(b) Mitigation in all its forms (avoiding, minimizing, rectifying, reducing, or compensating) will be required to the extent necessary to ensure that the adverse effects to the aquatic environment are minimal.

(c) Compensatory mitigation at a minimum one-for-one ratio will be required for all wetland losses that exceed 1/10 acre and require pre-construction notification, unless the district engineer determines in writing that some other form of mitigation would be more environmentally appropriate and provides a project-specific waiver of this requirement. For wetland losses of 1/10 acre or less that require pre-construction notification, the district engineer may determine on a case-by-case basis that compensatory mitigation is required to ensure that the activity results in minimal adverse effects on the aquatic environment. Since the likelihood of success is greater and the impacts to potentially valuable uplands are reduced, wetland restoration should be the first compensatory mitigation option considered.

(d) For losses of streams or other open waters that require pre-construction notification, the district engineer may require compensatory mitigation, such as stream restoration, to ensure that the activity results in minimal adverse effects on the aquatic environment.

(e) Compensatory mitigation will not be used to increase the acreage losses allowed by the acreage limits of the NWPs. For example, if an NWP has an acreage limit of 1/2 acre, it cannot be used to authorize any project resulting in the loss of greater than 1/2 acre of waters of the United States, even if compensatory mitigation is provided that replaces or restores some of the lost waters. However, compensatory mitigation can and should be used, as necessary, to ensure that a project already meeting the established acreage limits also satisfies the minimal impact requirement associated with the NWPs.

(f) Compensatory mitigation plans for projects in or near streams or other open waters will normally include a requirement for the establishment, maintenance, and legal protection (e.g., conservation easements) of riparian areas next to open waters. In some cases, riparian areas may be the only compensatory mitigation required. Riparian areas should consist of native species. The width of the required riparian area will address documented water quality or aquatic habitat loss concerns. Normally, the riparian area will be 25 to 50 feet wide on each side of the stream, but the district engineer may require slightly wider riparian areas to address documented water quality or habitat loss concerns. Where both wetlands and open waters exist on the project site, the district engineer will determine the appropriate compensatory mitigation (e.g., riparian areas and/or wetlands compensation) based on what is best for the aquatic environment on a watershed basis. In cases where riparian areas are determined to be the most appropriate form of compensatory mitigation, the district engineer may waive or reduce the requirement to provide wetland compensatory mitigation for wetland losses.

(g) Permittees may propose the use of mitigation banks, in-lieu fee arrangements or separate activity-specific compensatory mitigation. In all cases, the mitigation provisions will specify the party responsible for accomplishing and/or complying with the mitigation plan.

(h) Where certain functions and services of waters of the United States are permanently adversely affected, such as the conversion of a forested or scrub-shrub wetland to a herbaceous wetland in a permanently maintained utility line right-of-way, mitigation may be required to reduce the adverse effects of the project to the minimal level.

21. Water Quality. Where States and authorized Tribes, or EPA where applicable, have not previously certified compliance of an NWP with CWA Section 401, individual 401 Water Quality Certification must be obtained or waived (see 33 CFR 330.4(c)). The district engineer or State or Tribe may require additional water quality management measures to ensure that the authorized activity does not result in more than minimal degradation of water quality.

22. Coastal Zone Management. In coastal states where an NWP has not previously received a state coastal zone management consistency concurrence, an individual state coastal zone management consistency concurrence must be obtained, or a presumption of concurrence must occur (see 33 CFR 330.4(d)). The district engineer or a State may require additional measures to ensure that the authorized activity is consistent with state coastal zone management requirements.

23. Regional and Case-By-Case Conditions. The activity must comply with any regional conditions that may have been added by the Division Engineer (see 33 CFR 330.4(e)) and with any case specific conditions added by the Corps or by the state, Indian Tribe, or U.S. EPA in its section 401 Water Quality Certification, or by the state in its Coastal Zone Management Act consistency determination.

24. Use of Multiple Nationwide Permits. The use of more than one NWP for a single and complete project is prohibited, except when the acreage loss of waters of the United States authorized by the NWPs does not exceed the acreage limit of the NWP with the highest specified acreage limit. For example, if a road crossing over tidal waters is constructed under NWP 14, with associated bank stabilization authorized by NWP 13, the maximum acreage loss of waters of the United States for the total project cannot exceed 1/3-acre.

25. Transfer of Nationwide Permit Verifications. If the permittee sells the property associated with a nationwide permit verification, the permittee may transfer the nationwide permit verification to the new owner by submitting a letter to the appropriate Corps district office to validate the transfer. A copy of the nationwide permit verification must be attached to the letter, and the letter must contain the following statement and signature:

“When the structures or work authorized by this nationwide permit are still in existence at the time the property is transferred, the terms and conditions of this nationwide permit, including any special conditions, will continue to be binding on the new owner(s) of the property. To validate the transfer of this nationwide permit and the associated liabilities associated with compliance with its terms and conditions, have the transferee sign and date below.”

(Transferee)

(Date)

* 26. Compliance Certification. Each permittee who received an NWP verification from the Corps must submit a signed certification regarding the completed work and any required mitigation. The certification form must be forwarded by the Corps with the NWP verification letter and will include:

- (a) A statement that the authorized work was done in accordance with the NWP authorization, including any general or specific conditions;
- (b) A statement that any required mitigation was completed in accordance with the permit conditions; and
- (c) The signature of the permittee certifying the completion of the work and mitigation.

- * 27. Pre-Construction Notification. (a) Timing. Where required by the terms of the NWP, the prospective permittee must notify the district engineer by submitting a pre-construction notification (PCN) as early as possible. The district engineer must determine if the PCN is complete within 30 calendar days of the date of receipt and, as a general rule, will request additional information necessary to make the PCN complete only once. However, if the prospective permittee does not provide all of the requested information, then the district engineer will notify the prospective permittee that the PCN is still incomplete and the PCN review process will not commence until all of the requested information has been received by the district engineer. The prospective permittee shall not begin the activity until either:
- (1) He or she is notified in writing by the district engineer that the activity may proceed under the NWP with any special conditions imposed by the district or division engineer; or
 - (2) Forty-five calendar days have passed from the district engineer's receipt of the complete PCN and the prospective permittee has not received written notice from the district or division engineer. However, if the permittee was required to notify the Corps pursuant to general condition 17 that listed species or critical habitat might be affected or in the vicinity of the project, or to notify the Corps pursuant to general condition 18 that the activity may have the potential to cause effects to historic properties, the permittee cannot begin the activity until receiving written notification from the Corps that is "no effect" on listed species or "no potential to cause effects" on historic properties, or that any consultation required under Section 7 of the Endangered Species Act (see 33 CFR 330.4(f)) and/or Section 106 of the National Historic Preservation Act (see 33 CFR 330.4(g)) is completed. Also, work cannot begin under NWPs 21, 49, or 50 until the permittee has received written approval from the Corps. If the proposed activity requires a written waiver to exceed specified limits of an NWP, the permittee cannot begin the activity until the district engineer issues the waiver. If the district or division engineer notifies the permittee in writing that an individual permit is required within 45 calendar days of receipt of a complete PCN, the permittee cannot begin the activity until an individual permit has been obtained. Subsequently, the permittee's right to proceed under the NWP may be modified, suspended, or revoked only in accordance with the procedure set forth in 33 CFR 330.5(d)(2).
- (b) Contents of Pre-Construction Notification: The PCN must be in writing and include the following information:
- (1) Name, address and telephone numbers of the prospective permittee;
 - (2) Location of the proposed project;
 - (3) A description of the proposed project; the project's purpose; direct and indirect adverse environmental effects the project would cause; any other NWP(s), regional general permit(s), or individual permit(s) used or intended to be used to authorize any part of the proposed project or any related activity. The description should be sufficiently detailed to allow the district engineer to determine that the adverse effects of the project will be minimal and to determine the need for compensatory mitigation. Sketches should be provided when necessary to show that the activity complies with the terms of the NWP. (Sketches usually clarify the project and when provided result in a quicker decision.);
 - (4) The PCN must include a delineation of special aquatic sites and other waters of the United States on the project site. Wetland delineations must be prepared in accordance with the current method required by the Corps. The permittee may ask the Corps to delineate the special aquatic sites and other waters of the United States, but there may be a delay if the Corps does the delineation, especially if the project site is large or contains many waters of the United States. Furthermore, the 45 day period will not start until the delineation has been submitted to or completed by the Corps, where appropriate;
 - (5) If the proposed activity will result in the loss of greater than 1/10 acre of wetlands and a PCN is required, the prospective permittee must submit a statement describing how the mitigation requirement

will be satisfied. As an alternative, the prospective permittee may submit a conceptual or detailed mitigation plan.

(6) If any listed species or designated critical habitat might be affected or is in the vicinity of the project, or if the project is located in designated critical habitat, for non-Federal applicants the PCN must include the name(s) of those endangered or threatened species that might be affected by the proposed work or utilize the designated critical habitat that may be affected by the proposed work. Federal applicants must provide documentation demonstrating compliance with the Endangered Species Act; and

(7) For an activity that may affect a historic property listed on, determined to be eligible for listing on, or potentially eligible for listing on, the National Register of Historic Places, for non-Federal applicants the PCN must state which historic property may be affected by the proposed work or include a vicinity map indicating the location of the historic property. Federal applicants must provide documentation demonstrating compliance with Section 106 of the National Historic Preservation Act.

(c) Form of Pre-Construction Notification: The standard individual permit application form (Form ENG 4345) may be used, but the completed application form must clearly indicate that it is a PCN and must include all of the information required in paragraphs (b)(1) through (7) of this general condition. A letter containing the required information may also be used.

(d) Agency Coordination: (1) The district engineer will consider any comments from Federal and state agencies concerning the proposed activity's compliance with the terms and conditions of the NWP's and the need for mitigation to reduce the project's adverse environmental effects to a minimal level.

(2) For all NWP 48 activities requiring pre-construction notification and for other NWP activities requiring pre-construction notification to the district engineer that result in the loss of greater than 1/2-acre of waters of the United States, the district engineer will immediately provide (e.g., via facsimile transmission, overnight mail, or other expeditious manner) a copy of the PCN to the appropriate Federal or state offices (U.S. FWS, state natural resource or water quality agency, EPA, State Historic Preservation Officer (SHPO) or Tribal Historic Preservation Office (THPO), and, if appropriate, the NMFS). With the exception of NWP 37, these agencies will then have 10 calendar days from the date the material is transmitted to telephone or fax the district engineer notice that they intend to provide substantive, site-specific comments. If so contacted by an agency, the district engineer will wait an additional 15 calendar days before making a decision on the pre-construction notification. The district engineer will fully consider agency comments received within the specified time frame, but will provide no response to the resource agency, except as provided below. The district engineer will indicate in the administrative record associated with each pre-construction notification that the resource agencies' concerns were considered. For NWP 37, the emergency watershed protection and rehabilitation activity may proceed immediately in cases where there is an unacceptable hazard to life or a significant loss of property or economic hardship will occur. The district engineer will consider any comments received to decide whether the NWP 37 authorization should be modified, suspended, or revoked in accordance with the procedures at 33 CFR 330.5.

(3) In cases of where the prospective permittee is not a Federal agency, the district engineer will provide a response to NMFS within 30 calendar days of receipt of any Essential Fish Habitat conservation recommendations, as required by Section 305(b)(4)(B) of the Magnuson-Stevens Fishery Conservation and Management Act.

(4) Applicants are encouraged to provide the Corps multiple copies of pre-construction notifications to expedite agency coordination.

(5) For NWP 48 activities that require reporting, the district engineer will provide a copy of each report within 10 calendar days of receipt to the appropriate regional office of the NMFS.

(e) District Engineer's Decision: In reviewing the PCN for the proposed activity, the district engineer will determine whether the activity authorized by the NWP will result in more than minimal individual or cumulative adverse environmental effects or may be contrary to the public interest. If the proposed activity requires a PCN and will result in a loss of greater than 1/10 acre of wetlands, the prospective permittee should submit a mitigation proposal with the PCN. Applicants may also propose compensatory mitigation for projects with smaller impacts. The district engineer will consider any

proposed compensatory mitigation the applicant has included in the proposal in determining whether the net adverse environmental effects to the aquatic environment of the proposed work are minimal. The compensatory mitigation proposal may be either conceptual or detailed. If the district engineer determines that the activity complies with the terms and conditions of the NWP and that the adverse effects on the aquatic environment are minimal, after considering mitigation, the district engineer will notify the permittee and include any conditions the district engineer deems necessary. The district engineer must approve any compensatory mitigation proposal before the permittee commences work. If the prospective permittee elects to submit a compensatory mitigation plan with the PCN, the district engineer will expeditiously review the proposed compensatory mitigation plan. The district engineer must review the plan within 45 calendar days of receiving a complete PCN and determine whether the proposed mitigation would ensure no more than minimal adverse effects on the aquatic environment. If the net adverse effects of the project on the aquatic environment (after consideration of the compensatory mitigation proposal) are determined by the district engineer to be minimal, the district engineer will provide a timely written response to the applicant. The response will state that the project can proceed under the terms and conditions of the NWP.

If the district engineer determines that the adverse effects of the proposed work are more than minimal, then the district engineer will notify the applicant either: (1) That the project does not qualify for authorization under the NWP and instruct the applicant on the procedures to seek authorization under an individual permit; (2) that the project is authorized under the NWP subject to the applicant's submission of a mitigation plan that would reduce the adverse effects on the aquatic environment to the minimal level; or (3) that the project is authorized under the NWP with specific modifications or conditions. Where the district engineer determines that mitigation is required to ensure no more than minimal adverse effects occur to the aquatic environment, the activity will be authorized within the 45-day PCN period. The authorization will include the necessary conceptual or specific mitigation or a requirement that the applicant submit a mitigation plan that would reduce the adverse effects on the aquatic environment to the minimal level. When mitigation is required, no work in waters of the United States may occur until the district engineer has approved a specific mitigation plan.

28. Single and Complete Project. The activity must be a single and complete project. The same NWP cannot be used more than once for the same single and complete project.

FURTHER INFORMATION

1. District Engineers have authority to determine if an activity complies with the terms and conditions of an NWP.
2. NWPs do not obviate the need to obtain other federal, state, or local permits, approvals, or authorizations required by law.
3. NWPs do not grant any property rights or exclusive privileges.
4. NWPs do not authorize any injury to the property or rights of others.
5. NWPs do not authorize interference with any existing or proposed Federal project.

DEFINITIONS

Best management practices (BMPs): Policies, practices, procedures, or structures implemented to mitigate the adverse environmental effects on surface water quality resulting from development. BMPs are categorized as structural or non-structural.

Compensatory mitigation: The restoration, establishment (creation), enhancement, or preservation of aquatic resources for the purpose of compensating for unavoidable adverse impacts which remain after all appropriate and practicable avoidance and minimization has been achieved.

Currently serviceable: Useable as is or with some maintenance, but not so degraded as to essentially require reconstruction.

Discharge: The term "discharge" means any discharge of dredged or fill material.

Enhancement: The manipulation of the physical, chemical, or biological characteristics of an aquatic resource to heighten, intensify, or improve a specific aquatic resource function(s). Enhancement results in the gain of selected aquatic resource function(s), but may also lead to a decline in other aquatic resource function(s). Enhancement does not result in a gain in aquatic resource area.

Ephemeral stream: An ephemeral stream has flowing water only during, and for a short duration after, precipitation events in a typical year. Ephemeral stream beds are located above the water table year-round. Groundwater is not a source of water for the stream. Runoff from rainfall is the primary source of water for stream flow.

Establishment (creation): The manipulation of the physical, chemical, or biological characteristics present to develop an aquatic resource that did not previously exist at an upland site. Establishment results in a gain in aquatic resource area.

Historic Property: Any prehistoric or historic district, site (including archaeological site), building, structure, or other object included in, or eligible for inclusion in, the National Register of Historic Places maintained by the Secretary of the Interior. This term includes artifacts, records, and remains that are related to and located within such properties. The term includes properties of traditional religious and cultural importance to an Indian tribe or Native Hawaiian organization and that meet the National Register criteria (36 CFR part 60).

Independent utility: A test to determine what constitutes a single and complete project in the Corps regulatory program. A project is considered to have independent utility if it would be constructed absent the construction of other projects in the project area. Portions of a multi-phase project that depend upon other phases of the project do not have independent utility. Phases of a project that would be constructed even if the other phases were not built can be considered as separate single and complete projects with independent utility.

Intermittent stream: An intermittent stream has flowing water during certain times of the year, when groundwater provides water for stream flow. During dry periods, intermittent streams may not have flowing water. Runoff from rainfall is a supplemental source of water for stream flow.

Loss of waters of the United States: Waters of the United States that are permanently adversely affected by filling, flooding, excavation, or drainage because of the regulated activity. Permanent adverse effects include permanent discharges of dredged or fill material that change an aquatic area to dry land, increase the bottom elevation of a waterbody, or change the use of a waterbody. The acreage of loss of waters of the United States is a threshold measurement of the impact to jurisdictional waters for determining whether a project may qualify for an NWP; it is not a net threshold that is calculated after considering compensatory mitigation that may be used to offset losses of aquatic functions and services. The loss of stream bed includes the linear feet of stream bed that is filled or excavated. Waters of the United States temporarily filled, flooded, excavated, or drained, but restored to pre-construction contours and elevations after construction, are not included in the measurement of loss of waters of the United States. Impacts resulting from activities eligible for exemptions under Section 404(f) of the Clean Water Act are not considered when calculating the loss of waters of the United States.

Non-tidal wetland: A non-tidal wetland is a wetland that is not subject to the ebb and flow of tidal waters. The definition of a wetland can be found at 33 CFR 328.3(b). Non-tidal wetlands contiguous to tidal waters are located landward of the high tide line (i.e., spring high tide line).

Open water: For purposes of the NWPs, an open water is any area that in a year with normal patterns of precipitation has water flowing or standing above ground to the extent that an ordinary high water mark can be determined. Aquatic vegetation within the area of standing or flowing water is either non-emergent, sparse, or absent. Vegetated shallows are considered to be open waters. Examples of “open waters” include rivers, streams, lakes, and ponds.

Ordinary High Water Mark: An ordinary high water mark is a line on the shore established by the fluctuations of water and indicated by physical characteristics, or by other appropriate means that consider the characteristics of the surrounding areas (see 33 CFR 328.3(e)).

Perennial stream: A perennial stream has flowing water year-round during a typical year. The water table is located above the stream bed for most of the year. Groundwater is the primary source of water for stream flow. Runoff from rainfall is a supplemental source of water for stream flow.

Practicable: Available and capable of being done after taking into consideration cost, existing technology, and logistics in light of overall project purposes.

Pre-construction notification: A request submitted by the project proponent to the Corps for confirmation that a particular activity is authorized by nationwide permit. The request may be a permit application, letter, or similar document that includes information about the proposed work and its anticipated environmental effects. Pre-construction notification may be required by the terms and conditions of a nationwide permit, or by regional conditions. A pre-construction notification may be voluntarily submitted in cases where pre-construction notification is not required and the project proponent wants confirmation that the activity is authorized by nationwide permit.

Preservation: The removal of a threat to, or preventing the decline of, aquatic resources by an action in or near those aquatic resources. This term includes activities commonly associated with the protection and maintenance of aquatic resources through the implementation of appropriate legal and physical mechanisms. Preservation does not result in a gain of aquatic resource area or functions.

Re-establishment: The manipulation of the physical, chemical, or biological characteristics of a site with the goal of returning natural/historic functions to a former aquatic resource. Re-establishment results in rebuilding a former aquatic resource and results in a gain in aquatic resource area.

Rehabilitation: The manipulation of the physical, chemical, or biological characteristics of a site with the goal of repairing natural/historic functions to a degraded aquatic resource. Rehabilitation results in a gain in aquatic resource function, but does not result in a gain in aquatic resource area.

Restoration: The manipulation of the physical, chemical, or biological characteristics of a site with the goal of returning natural/historic functions to a former or degraded aquatic resource. For the purpose of tracking net gains in aquatic resource area, restoration is divided into two categories: re-establishment and rehabilitation.

Riffle and pool complex: Riffle and pool complexes are special aquatic sites under the 404(b)(1) Guidelines. Riffle and pool complexes sometimes characterize steep gradient sections of streams. Such stream sections are recognizable by their hydraulic characteristics. The rapid movement of water over a coarse substrate in riffles results in a rough flow, a turbulent surface, and high dissolved oxygen levels in the water. Pools are deeper areas associated with riffles. A slower stream velocity, a streaming flow, a smooth surface, and a finer substrate characterize pools.

Riparian areas: Riparian areas are lands adjacent to streams, lakes, and estuarine-marine shorelines. Riparian areas are transitional between terrestrial and aquatic ecosystems, through which surface and subsurface hydrology connects waterbodies with their adjacent uplands. Riparian areas provide a variety of ecological functions and services and help improve or maintain local water quality. (See general condition 20.)

Shellfish seeding: The placement of shellfish seed and/or suitable substrate to increase shellfish production. Shellfish seed consists of immature individual shellfish or individual shellfish attached to shells or shell fragments (i.e., spat on shell). Suitable substrate may consist of shellfish shells, shell fragments, or other appropriate materials placed into waters for shellfish habitat.

Single and complete project: The term “single and complete project” is defined at 33 CFR 330.2(i) as the total project proposed or accomplished by one owner/developer or partnership or other association of owners/developers. A single and complete project must have independent utility (see definition). For linear projects, a “single and complete project” is all crossings of a single water of the United States (i.e., a single waterbody) at a specific location. For linear projects crossing a single waterbody several times at separate and distant locations, each crossing is considered a single and complete project. However, individual channels in a braided stream or river, or individual arms of a large, irregularly shaped wetland or lake, etc., are not separate waterbodies, and crossings of such features cannot be considered separately.

Stormwater management: Stormwater management is the mechanism for controlling stormwater runoff for the purposes of reducing downstream erosion, water quality degradation, and flooding and mitigating the adverse effects of changes in land use on the aquatic environment.

Stormwater management facilities: Stormwater management facilities are those facilities, including but not limited to, stormwater retention and detention ponds and best management practices, which retain water for a period of time to control runoff and/or improve the quality (i.e., by reducing the concentration of nutrients, sediments, hazardous substances and other pollutants) of stormwater runoff.

Stream bed: The substrate of the stream channel between the ordinary high water marks. The substrate may be bedrock or inorganic particles that range in size from clay to boulders. Wetlands contiguous to the stream bed, but outside of the ordinary high water marks, are not considered part of the stream bed.

Stream channelization: The manipulation of a stream's course, condition, capacity, or location that causes more than minimal interruption of normal stream processes. A channelized stream remains a water of the United States.

Structure: An object that is arranged in a definite pattern of organization. Examples of structures include, without limitation, any pier, boat dock, boat ramp, wharf, dolphin, weir, boom, breakwater, bulkhead, revetment, riprap, jetty, artificial island, artificial reef, permanent mooring structure, power transmission line, permanently moored floating vessel, piling, aid to navigation, or any other manmade obstacle or obstruction.

Tidal wetland: A tidal wetland is a wetland (i.e., water of the United States) that is inundated by tidal waters. The definitions of a wetland and tidal waters can be found at 33 CFR 328.3(b) and 33 CFR 328.3(f), respectively. Tidal waters rise and fall in a predictable and measurable rhythm or cycle due to the gravitational pulls of the moon and sun. Tidal waters end where the rise and fall of the water surface can no longer be practically measured in a predictable rhythm due to masking by other waters, wind, or other effects. Tidal wetlands are located channelward of the high tide line, which is defined at 33 CFR 328.3(d).

Vegetated shallows: Vegetated shallows are special aquatic sites under the 404(b)(1) Guidelines. They are areas that are permanently inundated and under normal circumstances have rooted aquatic vegetation, such as seagrasses in marine and estuarine systems and a variety of vascular rooted plants in freshwater systems.

Waterbody: For purposes of the NWP, a waterbody is a jurisdictional water of the United States that, during a year with normal patterns of precipitation, has water flowing or standing above ground to the extent that an ordinary high water mark (OHWM) or other indicators of jurisdiction can be determined, as well as any wetland area (see 33 CFR 328.3(b)). If a jurisdictional wetland is adjacent--meaning bordering, contiguous, or neighboring--to a jurisdictional waterbody displaying an OHWM or other indicators of jurisdiction, that waterbody and its adjacent wetlands are considered together as a single aquatic unit (see 33 CFR 328.4(c)(2)). Examples of "waterbodies" include streams, rivers, lakes, ponds, and wetlands.

REGIONAL CONDITIONS FOR NATIONWIDE PERMITS IN THE WILMINGTON DISTRICT

1.0. Excluded Waters

The Corps has identified waters that will be excluded from the use of all NWP's during certain timeframes. These waters are:

1.1. Anadromous Fish Spawning Areas

Waters of the United States identified by either the North Carolina Division of Marine Fisheries (NCDMF) or the North Carolina Wildlife Resources Commission (NCWRC) as anadromous fish spawning areas are excluded during the period between February 15 and June 30, without prior written approval from NCDMF or NCWRC and the Corps.

1.2. Trout Waters Moratorium

Waters of the United States in the twenty-five designated trout counties of North Carolina are excluded during the period between October 15 and April 15 without prior written approval from the NCWRC. (see Section I. b. 7. for a list of the twenty-five trout counties).

1.3. Sturgeon Spawning Areas

Waters of the United States designated as sturgeon spawning areas are excluded during the period between February 1 and June 30, without prior written approval from the National Marine Fisheries Service (NMFS).

* 2.0. Waters Requiring Additional Notification

The Corps has identified waters that will be subject to additional notification requirements for activities authorized by all NWP's. These waters are:

* 2.1. Western NC Counties that Drain to Designated Critical Habitat

Waters of the U.S. that requires a Pre-Construction Notification pursuant to General Condition 27 (PCN) and located in the sixteen counties listed below, applicants must provide a copy of the PCN to the US Fish and Wildlife Service, 160 Zillicoa Street, Asheville, North Carolina 28805. This PCN must be sent concurrently to the US Fish and Wildlife Service and the Corps Asheville Regulatory Field Office. Please see General Condition 17 for specific notification requirements related to Federally Endangered Species and the following website for information on the location of designated critical habitat.

Counties with tributaries that drain to designated critical habitat that require notification to the Asheville US Fish and Wildlife Service: Avery, Cherokee, Forsyth, Graham, Haywood, Henderson, Jackson, Macon Mecklenburg, Mitchell, Stokes, Surry, Swain, Transylvania, Union and Yancey.

Website and office addresses for Endangered Species Act Information:

The Wilmington District has developed the following website for applicants which provide guidelines on how to review linked websites and maps in order to fulfill NWP general condition 17 requirements.

<http://www.saw.usace.army.mil/wetlands/ESA>

Applicants who do not have internet access may contact the appropriate US Fish and Wildlife Service offices or the US Army Corps of Engineers office listed below.

US Fish and Wildlife Service
Asheville Field Office
160 Zillicoa Street
Asheville, NC 28801
Telephone: (828) 258-3939

Asheville US Fish and Wildlife Service Office counties: All counties west of and including Anson, Stanly, Davidson, Forsyth and Stokes Counties

US Fish and Wildlife Service
 Raleigh Field Office
 Post Office Box 33726
 Raleigh, NC 27636-3726
 Telephone: (919) 856-4520

Raleigh US Fish and Wildlife Service Office counties: all counties east of and including Richmond, Montgomery, Randolph, Guilford, and Rockingham Counties.

*** 2.2. Special Designation Waters**

Prior to the use of any NWP in any of the following North Carolina identified waters and contiguous wetlands, applicants must comply with Nationwide Permit General Condition 27 (PCN). The North Carolina waters and contiguous wetlands that require additional notification requirements are:

“Outstanding Resource Waters” (ORW) and “High Quality Waters” (HQW) (as designated by the North Carolina Environmental Management Commission), or
 “Inland Primary Nursery Areas” (IPNA) (as designated by the North Carolina Wildlife Resources Commission), or “Contiguous Wetlands” (as defined by the North Carolina Environmental Management Commission), or “Primary Nursery Areas” (PNA) (as designated by the North Carolina Marine Fisheries Commission).

2.3. Coastal Area Management Act (CAMA) Areas of Environmental Concern

Non-Federal applicants for any NWP in a designated “Area of Environmental Concern” (AEC) in the twenty (20) counties of Eastern North Carolina covered by the North Carolina Coastal Area Management Act (CAMA), must also obtain the required CAMA permit. Construction activities for non-Federal projects may not commence until a copy of the approved CAMA permit is furnished to the appropriate Wilmington District Regulatory Field Office (Wilmington Field Office – P.O. Box 1890, Wilmington, NC 28402 or Washington Field Office – P.O. Box 1000, Washington, NC 27889).

*** 2. 4. Barrier Islands**

Prior to the use of any NWP on a barrier island of North Carolina, applicants must comply with Nationwide Permit General Condition 27 (PCN).

*** 2.5. Mountain or Piedmont Bogs**

Prior to the use of any NWP in a “Mountain or Piedmont Bog” of North Carolina, applicants shall comply with Nationwide Permit General Condition 27 (PCN).

Note: The following wetland community types identified in the N.C. Natural Heritage Program document, “Classification of Natural communities of North Carolina (Michael P. Schafale and Alan S. Weakley, 1990), are subject to this regional condition.

Mountain Bogs	Piedmont Bogs
Swamp Forest-Bog Complex	Upland depression Swamp Forest
Swamp Forest-Bog Complex (Spruce Subtype)	
Southern Appalachian Bog (Northern Subtype)	
Southern Appalachian Bog (Southern Subtype)	
Southern Appalachian Fen	

*** 2.6. Animal Waste Facilities**

Prior to use of any NWP for construction of animal waste facilities in waters of the US, including wetlands, applicants shall comply with Nationwide Permit General Condition 27 (PCN).

*** 2.7. Trout Waters**

Prior to any discharge of dredge or fill material into streams or waterbodies within the twenty-five (25) designated trout counties of North Carolina, the applicant shall comply with

Nationwide Permit General Condition 27 (PCN). The applicant shall also provide a copy of the notification to the appropriate NCWRC office to facilitate the determination of any potential impacts to designated Trout Waters. Notification to the Corps of Engineers will include a statement with the name of the NCWRC biologist contacted, the date of the notification, the location of work, a delineation of wetlands, a discussion of alternatives to working in the mountain trout waters, why alternatives were not selected, and a plan to provide compensatory mitigation for all unavoidable adverse impacts to mountain trout waters.

NCWRC and NC Trout Counties

Mr. Ron Linville			
Western Piedmont Region Coordinator	Alleghany	Caldwell	Watauga
3855 Idlewild Road	Ashe	Mitchell	Wilkes
Kernersville, NC 27284-9180	Avery	Stokes	
Telephone: (336) 769-9453	Burke	Surry	
Mr. Dave McHenry			
Mountain Region Coordinator	Buncombe	Henderson	Polk
20830 Great Smoky Mtn. Expressway	Cherokee	Jackson	Rutherford
Waynesville, NC 28786	Clay	Macon	Swain
Telephone: (828) 452-2546	Graham	Madison	Transylvania
Fax: (828) 452-7772	Haywood	McDowell	Yancey

3.0. List of Corps Regional Conditions for All Nationwide Permits

The following conditions apply to all Nationwide Permits in the Wilmington District:

3.1. Limitation of Loss of Perennial Stream Bed

NWPs may not be used for activities that may result in the loss or degradation of greater than 300 total linear feet of perennial streams. The NWPs may not be used for activities that may result in the loss or degradation of greater than 300 total linear feet of ephemeral and intermittent streams that exhibit important aquatic function(s)* Loss of stream includes the linear feet of stream bed that is filled, excavated, or flooded by the proposed activity. The District Commander can waive the 300 linear foot limit for ephemeral and intermittent streams on a case-by-case basis if he determines that the proposed activity will result in minimal individual and cumulative adverse impacts to the aquatic environment. Waivers for the loss of ephemeral and intermittent streams must be in writing. This waiver only applies to the 300 linear feet threshold for NWPs. Mitigation may still be required for impacts to ephemeral and intermittent streams, on a case-by-case basis, depending on the impacts to the aquatic environment of the

proposed project. [*Note: The Corps uses the Stream Quality Assessment Worksheet, located with Permit Information on the Regulatory Program Web Site, to aid in the determination of aquatic function within the intermittent stream channel.]

3.2. Mitigation for Loss of Stream Bed Exceeding 150 Feet.

For any NWP that results in a loss of more than 150 linear feet of perennial and/or ephemeral/intermittent stream, the applicant shall provide a mitigation proposal to compensate for the loss of aquatic function associated with the proposed activity. For stream losses less than 150 linear feet, that require a PCN, the District Commander may determine, on a case-by-case basis that compensatory mitigation is required to ensure that the activity results in minimal adverse effect on the aquatic environment.

3.3. Pre-construction Notification for Loss of Streambed Exceeding 150 Feet.

Prior to use of any NWP for any activity which impacts more than 150 total linear feet of perennial stream or ephemeral/ intermittent stream, the applicant must comply with Nationwide Permit General Condition 27 (PCN). This applies to NWPs that do not have specific notification requirements. If a NWP has specific notification requirements, the requirements of the NWP should be followed.

3.4. Restriction on Use of Live Concrete

For all NWPs which allow the use of concrete as a building material, measures will be taken to prevent live or fresh concrete, including bags of uncured concrete, from coming into contact with waters of the state until the concrete has hardened.

3.5. Requirements for Using Riprap for Bank Stabilization

For all NWPs that allow for the use of riprap material for bank stabilization, the following measures shall be applied:

3.5.1. Filter cloth must be placed underneath the riprap as an additional requirement of its use in North Carolina waters.

3.5.2. The placement of riprap shall be limited to the areas depicted on submitted work plan drawings.

3.5.3. The riprap material shall be clean and free from loose dirt or any pollutant except in trace quantities that would not have an adverse environmental effect.

3.5.4. It shall be of a size sufficient to prevent its movement from the authorized alignment by natural forces under normal conditions.

3.5.5. The riprap material shall consist of clean rock or masonry material such as, but not limited to, granite, marl, or broken concrete.

21

3.5.6. A waiver from the specifications in this Regional Condition may be requested in writing. The waiver will only be issued if it can be demonstrated that the impacts of complying with this Regional condition would result in greater adverse impacts to the aquatic environment.

3.6. Safe Passage Requirements for Culvert Placement

For all NWPs that involve the construction/installation of culverts, measures will be included in the construction/installation that will promote the safe passage of fish and other aquatic organisms. The dimension, pattern, and profile of the stream above and below a pipe or culvert should not be modified by widening the stream channel or by reducing the depth of the stream in connection with the construction activity. The width, height, and gradient of a proposed opening should be such as to pass the average historical low flow and spring flow without adversely altering flow velocity. Spring flow should be determined from gage data, if available. In the absence of such data, bankfull flow can be used as a comparable level.

In the twenty (20) counties of North Carolina designated as coastal counties by the Coastal Area Management Act (CAMA): All pipe and culvert bottoms shall be buried at least one foot below normal bed elevation when they are placed within the Public Trust Area of Environmental Concern (AEC) and/or the Estuarine Waters AEC as designated by CAMA, and/or all streams appearing as blue lines on United States Geological Survey (USGS) quad sheets.

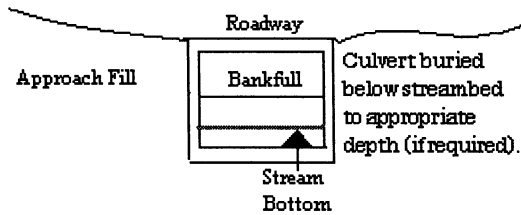

In all other counties: Culverts greater than 48 inches in diameter will be buried at least one foot below the bed of the stream. Culverts 48 inches in diameter or less shall be buried or placed on the stream bed as practicable and appropriate to maintain aquatic passage, and every effort shall be made to maintain the existing channel slope. The bottom of the culvert must be placed at a depth below the natural stream bottom to provide for passage during drought or low flow conditions.

Destabilizing the channel and head cutting upstream should be considered in the placement of the culvert.

A waiver from the depth specifications in this condition may be requested in writing. The waiver will be issued if it can be demonstrated that the proposal would result in the least impacts to the aquatic environment.

All counties: Culverts placed in wetlands do not have to be buried.

3.7. Notification to NCDENR Shellfish Sanitation Section

Applicants shall notify the NCDENR Shellfish Sanitation Section prior to dredging in or removing sediment from an area closed to shell fishing where the effluent may be released to an area open for shell fishing or swimming in order to avoid contamination from the disposal area and cause a temporary shellfish closure to be made. Such notification shall also be provided to the appropriate Corps of Engineers Regulatory Field Office. Any disposal of sand to the ocean beach should occur between November 1 and April 30 when recreational usage is low. Only clean sand should be used and no dredged sand from closed shell fishing areas may be used. If beach disposal were to occur at times other than stated above or if sand from a closed shell fishing area is to be used, a swimming advisory shall be posted, and a press release shall be issued.

3.8. Preservation of Submerged Aquatic Vegetation

Adverse impacts to Submerged Aquatic Vegetation (SAV) are not authorized by any NWP within any of the twenty coastal counties defined by North Carolina's Coastal Area Management Act of 1974 (CAMA).

The following regional conditions are required for NWP #12 - Utility Line Activities:

4.1. Directional Drilling or Boring

Pipeline/utility line construction through jurisdictional waters and wetlands will be accomplished utilizing directional drilling/boring methods to the maximum extent practicable.

4.2. Temporary Discharge and Fill

Temporary discharge of excavated or fill material into wetlands and waters of the United States will be for the absolute minimum period of time necessary to accomplish the work. Temporary discharges will be fully contained with appropriate erosion control or containment methods or otherwise such fills will consist of non-erodible materials.

4.3. Work Corridor Restrictions

The work area authorized by this permit, including temporary and/or permanent fills, will be minimized to the greatest extent practicable. Justification for work corridors exceeding forty (40) feet in width is required and will be based on pipeline diameter and length, size of equipment required to construct the utility line, and other construction information deemed necessary to support the request. The applicant is required to provide this information to the Corps with the initial notification package.

4.4. Depth Requirement in Federal Channels

In areas where a sub-aqueous utility line is to cross a Federally maintained channel, (i.e., the Atlantic Intracoastal Waterway [AIWW]), the line will be buried at least six (6) feet below the depth of the authorized channel. For areas outside Federally-maintained channels, sub-aqueous lines must be installed at a minimum depth of two (2) feet below the substrate when such lines might interfere with navigation.

4.5. Clearance Requirement for Non-electric Aerial Lines

The minimum clearance for aerial communication lines, or any lines not transmitting electrical power, will be ten (10) feet above the clearance required for nearby stationary bridges as established by the U.S. Coast Guard. In the event the U.S. Coast Guard has not established a bridge clearance, minimum vertical clearances for power and aerial lines will not be less than required by Section 23, Rule 232, of the latest revision of the National Electrical Safety Code (ANSI C2). Clearances will not be less than shown in Table 232-1, Item 7, ANSI C2.

4.6. Reference Conditions for Electrical Aerial Lines

The clearance for an aerial line is based on the low point of the line under conditions that produce the greatest sag, taking into consideration temperature, load, wind, length or span and the type of supports. The minimum clearance for an aerial electrical power transmission line crossing navigable waters shall be governed by the system voltage, as indicated below:

Nominal System	Minimum Clearance
Voltage, kilovolt	Above Bridge Clearance (As Established by the U.S. Coast Guard)
115 and below	20 feet
138	22
161	24
230	26
350	30
500	35
700	42
750 to 765	45

4.7. Restoration of Wetland Areas Using Native Vegetation

A plan to restore and re-vegetate wetland areas cleared for construction must be submitted with the required PCN. Cleared wetland areas shall be re-vegetated to the maximum extent practicable with native species of canopy, shrub, and herbaceous species. Fescue grass shall not be used.

4.8. Compensatory Mitigation for Permanently Maintained Corridors For the purposes of this NWP, any permanently maintained corridor along the utility ROW shall be considered a permanent impact and a compensatory mitigation plan will be required for all such impacts associated with the requested activity.

4.9. Rip-rap Restriction

Use of rip-rap or any other engineered structures to stabilize a stream bed should be avoided to the maximum extent possible.

NC DIVISION OF WATER QUALITY - GENERAL CERTIFICATION CONDITIONS

For the most recent General Certification conditions, call the NC Division of Water Quality, Wetlands/401 Certification Unit at (919) 733-1786 or access the following website:

<http://h2o.enr.state.nc.us/ncwetlands/certs.html>

NC DIVISION OF COASTAL MANAGEMENT - STATE CONSISTENCY

In a letter dated May 7, 2007, the North Carolina Division of Coastal Management found this NWP consistent with the North Carolina Coastal Zone Management Program. Updates on CAMA Consistency for NC can be found on the NC DCM web site at:

<http://dcm2.enr.state.nc.us/Permits/consist.htm>

EASTERN BAND OF THE CHEROKEE INDIANS TRIBAL WATER QUALITY CERTIFICATIONS

In a letter dated May 8, 2007, US EPA, on behalf of the Eastern Band of Cherokee Indians, provided Tribal General Conditions for Nationwide Permits on Cherokee Indian Reservation. These Tribal General Conditions are located on the Corps website at:

<http://www.saw.usace.army.mil/WETLANDS/NWP2007/EBCI-certs.html>

Citations:

2007 Nationwide Permits Public Notice for Final Issue Date: March 15, 2007

Correction Notice for Nationwide Permits, Federal Register / Vol. 72, No. 88 / Tuesday, May 8, 2007 / Notices p.26082

2007 SAW Regional Conditions – Authorized June 1, 2007

This and other information can be found on the Corps web site at:

<http://www.saw.usace.army.mil/WETLANDS/NWP2007/nationwide-permits.html>



Office Use Only:
 Corps action ID no. _____
 DWQ project no. _____
 Form Version 1.3 Dec 10 2008

Pre-Construction Notification (PCN) Form		
A. Applicant Information		
1. Processing		
1a. Type(s) of approval sought from the Corps:	<input checked="" type="checkbox"/> Section 404 Permit <input type="checkbox"/> Section 10 Permit	
1b. Specify Nationwide Permit (NWP) number: 3 12 or General Permit (GP) number:		
1c. Has the NWP or GP number been verified by the Corps?		<input type="checkbox"/> Yes <input checked="" type="checkbox"/> No
1d. Type(s) of approval sought from the DWQ (check all that apply):		
<input checked="" type="checkbox"/> 401 Water Quality Certification – Regular <input type="checkbox"/> Non-404 Jurisdictional General Permit <input type="checkbox"/> 401 Water Quality Certification – Express <input checked="" type="checkbox"/> Riparian Buffer Authorization		
1e. Is this notification solely for the record because written approval is not required?	For the record only for DWQ 401 Certification: <input type="checkbox"/> Yes <input checked="" type="checkbox"/> No	For the record only for Corps Permit: <input checked="" type="checkbox"/> Yes <input type="checkbox"/> No
1f. Is payment into a mitigation bank or in-lieu fee program proposed for mitigation of impacts? If so, attach the acceptance letter from mitigation bank or in-lieu fee program.		<input type="checkbox"/> Yes <input checked="" type="checkbox"/> No
1g. Is the project located in any of NC's twenty coastal counties. If yes, answer 1h below.		<input checked="" type="checkbox"/> Yes <input type="checkbox"/> No
1h. Is the project located within a NC DCM Area of Environmental Concern (AEC)?		<input checked="" type="checkbox"/> Yes <input type="checkbox"/> No
2. Project Information		
2a. Name of project:	Replacement of Bridge 42 over Durham Creek on SR 1003	
2b. County:	Beaufort	
2c. Nearest municipality / town:	Aurora	
2d. Subdivision name:	<i>not applicable</i>	
2e. NCDOT only, T.I.P. or state project no:	B-4421	
3. Owner Information		
3a. Name(s) on Recorded Deed:	North Carolina Department of Transportation	
3b. Deed Book and Page No.	<i>not applicable</i>	
3c. Responsible Party (for LLC if applicable):	<i>not applicable</i>	
3d. Street address:	1598 Mail Service Center	
3e. City, state, zip:	Raleigh, NC 27699-1598	
3f. Telephone no.:	(919) 707-6158	
3g. Fax no.:	(919) 212-5785	
3h. Email address:	csunderwood@ncdot.gov	

4. Applicant Information (If different from owner)	
4a. Applicant is:	<input type="checkbox"/> Agent <input type="checkbox"/> Other, specify:
4b. Name:	<i>not applicable</i>
4c. Business name (if applicable):	
4d. Street address:	
4e. City, state, zip:	
4f. Telephone no.:	
4g. Fax no.:	
4h. Email address:	
5. Agent/Consultant Information (If applicable)	
5a. Name:	<i>not applicable</i>
5b. Business name (if applicable):	
5c. Street address:	
5d. City, state, zip:	
5e. Telephone no.:	
5f. Fax no.:	
5g. Email address:	

B. Project Information and Prior Project History	
1. Property Identification	
1a. Property identification no. (tax PIN or parcel ID):	<i>not applicable</i>
1b. Site coordinates (in decimal degrees):	Latitude: 35.2951 (DD.DDDDD) Longitude: - 76.8730 (-DD.DDDDD)
1c. Property size:	~2 acres
2. Surface Waters	
2a. Name of nearest body of water (stream, river, etc.) to proposed project:	Durham Creek
2b. Water Quality Classification of nearest receiving water:	C NSW
2c. River basin:	Tar Pamlico
3. Project Description	
3a. Describe the existing conditions on the site and the general land use in the vicinity of the project at the time of this application: Forested	
3b. List the total estimated acreage of all existing wetlands on the property: >1	
3c. List the total estimated linear feet of all existing streams (intermittent and perennial) on the property: 200	
3d. Explain the purpose of the proposed project: To replace a bridge on FHWA's Highway Bridge Program.	
3e. Describe the overall project in detail, including the type of equipment to be used: The project involves replacing a 104-foot bridge with a 130-foot, 3-span bridge on the existing alignment with an off-site detour. Standard road building equipment, such as trucks, dozers, and cranes will be used.	
4. Jurisdictional Determinations	
4a. Have jurisdictional wetland or stream determinations by the Corps or State been requested or obtained for this property / project (including all prior phases) in the past? Comments:	<input checked="" type="checkbox"/> Yes <input type="checkbox"/> No <input type="checkbox"/> Unknown
4b. If the Corps made the jurisdictional determination, what type of determination was made?	<input checked="" type="checkbox"/> Preliminary <input type="checkbox"/> Final
4c. If yes, who delineated the jurisdictional areas? Name (if known): Veronica Barnes	Agency/Consultant Company: NCDOT Other:
4d. If yes, list the dates of the Corps jurisdictional determinations or State determinations and attach documentation. June 20, 2011	
5. Project History	
5a. Have permits or certifications been requested or obtained for this project (including all prior phases) in the past?	<input type="checkbox"/> Yes <input checked="" type="checkbox"/> No <input type="checkbox"/> Unknown
5b. If yes, explain in detail according to "help file" instructions.	
6. Future Project Plans	
6a. Is this a phased project?	<input type="checkbox"/> Yes <input checked="" type="checkbox"/> No
6b. If yes, explain.	

C. Proposed Impacts Inventory						
1. Impacts Summary						
1a. Which sections were completed below for your project (check all that apply):						
<input checked="" type="checkbox"/> Wetlands <input type="checkbox"/> Streams - tributaries <input checked="" type="checkbox"/> Buffers <input type="checkbox"/> Open Waters <input type="checkbox"/> Pond Construction						
2. Wetland Impacts						
If there are wetland impacts proposed on the site, then complete this question for each wetland area impacted.						
2a. Wetland impact number – Permanent (P) or Temporary (T)	2b. Type of impact	2c. Type of wetland (if known)	2d. Forested	2e. Type of jurisdiction (Corps - 404, 10 DWQ – non-404, other)	2f. Area of impact (acres)	
Site 1 <input checked="" type="checkbox"/> P <input type="checkbox"/> T	Fill	bottomland hardwood	<input checked="" type="checkbox"/> Yes <input type="checkbox"/> No	<input checked="" type="checkbox"/> Corps <input type="checkbox"/> DWQ	0.01	
Site 2 <input type="checkbox"/> P <input type="checkbox"/> T			<input type="checkbox"/> Yes <input type="checkbox"/> No	<input type="checkbox"/> Corps <input type="checkbox"/> DWQ		
Site 3 <input type="checkbox"/> P <input type="checkbox"/> T			<input type="checkbox"/> Yes <input type="checkbox"/> No	<input type="checkbox"/> Corps <input type="checkbox"/> DWQ		
Site 4 <input type="checkbox"/> P <input type="checkbox"/> T			<input type="checkbox"/> Yes <input type="checkbox"/> No	<input type="checkbox"/> Corps <input type="checkbox"/> DWQ		
Site 5 <input type="checkbox"/> P <input type="checkbox"/> T			<input type="checkbox"/> Yes <input type="checkbox"/> No	<input type="checkbox"/> Corps <input type="checkbox"/> DWQ		
Site 6 <input type="checkbox"/> P <input type="checkbox"/> T			<input type="checkbox"/> Yes <input type="checkbox"/> No	<input type="checkbox"/> Corps <input type="checkbox"/> DWQ		
2g. Total wetland impacts					0.01 permanent 0.0 temp	
2h. Comments: There will be 0.02 ac of hand clearing due to bridge construction. Proposed temporary impacts of <0.01 ac of Temporary Fill in the Hand Clearing areas, for the installation of erosion control measures, including Temporary Silt Fence and/or Special Sediment Control Fence. Additionally, there will be <0.01 acre of fill for utility poles and 0.15 ac of hand clearing for utility relocations.						
3. Stream Impacts						
If there are perennial or intermittent stream impacts (including temporary impacts) proposed on the site, then complete this question for all stream sites impacted.						
3a. Stream impact number - Permanent (P) or Temporary (T)	3b. Type of impact	3c. Stream name	3d. Perennial (PER) or intermittent (INT)?	3e. Type of jurisdiction (Corps - 404, 10 DWQ – non-404, other)	3f. Average stream width (feet)	3g. Impact length (linear feet)
Site 1 <input type="checkbox"/> P <input type="checkbox"/> T			<input type="checkbox"/> PER <input type="checkbox"/> INT	<input type="checkbox"/> Corps <input type="checkbox"/> DWQ		
Site 2 <input type="checkbox"/> P <input type="checkbox"/> T			<input type="checkbox"/> PER <input type="checkbox"/> INT	<input type="checkbox"/> Corps <input type="checkbox"/> DWQ		
Site 3 <input type="checkbox"/> P <input type="checkbox"/> T			<input type="checkbox"/> PER <input type="checkbox"/> INT	<input type="checkbox"/> Corps <input type="checkbox"/> DWQ		
Site 4 <input type="checkbox"/> P <input type="checkbox"/> T			<input type="checkbox"/> PER <input type="checkbox"/> INT	<input type="checkbox"/> Corps <input type="checkbox"/> DWQ		
Site 5 <input type="checkbox"/> P <input type="checkbox"/> T			<input type="checkbox"/> PER <input type="checkbox"/> INT	<input type="checkbox"/> Corps <input type="checkbox"/> DWQ		
3h. Total stream and tributary impacts						
3i. Comments:						

4. Open Water Impacts								
If there are proposed impacts to lakes, ponds, estuaries, tributaries, sounds, the Atlantic Ocean, or any other open water of the U.S. then individually list all open water impacts below.								
4a. Open water impact number – Permanent (P) or Temporary (T)	4b. Name of waterbody (if applicable)	4c. Type of impact			4d. Waterbody type	4e. Area of impact (acres)		
O1 <input type="checkbox"/> P <input type="checkbox"/> T								
O2 <input type="checkbox"/> P <input type="checkbox"/> T								
O3 <input type="checkbox"/> P <input type="checkbox"/> T								
O4 <input type="checkbox"/> P <input type="checkbox"/> T								
4f. Total open water impacts								
4g. Comments:								
5. Pond or Lake Construction								
If pond or lake construction proposed, then complete the chart below.								
5a. Pond ID number	5b. Proposed use or purpose of pond	5c. Wetland Impacts (acres)			5d. Stream Impacts (feet)			5e. Upland (acres)
		Flooded	Filled	Excavated	Flooded	Filled	Excavated	Flooded
P1								
P2								
5f. Total								
5g. Comments:								
5h. Is a dam high hazard permit required?				<input type="checkbox"/> Yes <input type="checkbox"/> No If yes, permit ID no:				
5i. Expected pond surface area (acres):								
5j. Size of pond watershed (acres):								
5k. Method of construction:								

6. Buffer Impacts (for DWQ)					
If project will impact a protected riparian buffer, then complete the chart below. If yes, then individually list all buffer impacts below. If any impacts require mitigation, then you MUST fill out Section D of this form.					
6a. Project is in which protected basin?			<input type="checkbox"/> Neuse <input checked="" type="checkbox"/> Tar-Pamlico <input type="checkbox"/> Other: <input type="checkbox"/> Catawba <input type="checkbox"/> Randleman		
6b. Buffer impact number – Permanent (P) or Temporary (T)	6c. Reason for impact	6d. Stream name	6e. Buffer mitigation required?	6f. Zone 1 impact (square feet)	6g. Zone 2 impact (square feet)
B1 <input checked="" type="checkbox"/> P <input type="checkbox"/> T	Bridge	Durham Creek	<input type="checkbox"/> Yes <input checked="" type="checkbox"/> No	568	34
B2 <input checked="" type="checkbox"/> P <input type="checkbox"/> T	Road Crossing	Durham Creek	<input type="checkbox"/> Yes <input checked="" type="checkbox"/> No	699	797
B3 <input checked="" type="checkbox"/> P <input type="checkbox"/> T	Utility Relocation	Durham Creek	<input type="checkbox"/> Yes <input checked="" type="checkbox"/> No	2,529	1,595
6h. Total buffer impacts				3,796	2,426
6i. Comments:					

D. Impact Justification and Mitigation		
1. Avoidance and Minimization		
<p>1a. Specifically describe measures taken to avoid or minimize the proposed impacts in designing project.</p> <p>The proposed bridge is 26 feet longer than the existing bridge with the corresponding removal of fill and the opening up of area under the bridge; the proposed bridge will be at approximately the same grade as the existing structure; an off site detour will be used; 3:1 fill slopes will be used where practicable; the use of a pre-formed scour hole.</p>		
<p>1b. Specifically describe measures taken to avoid or minimize the proposed impacts through construction techniques.</p> <p>No deck drains on bridge; no direct discharge into wetlands or buffer; top-down construction; adherence to an in-water construction moratorium from February 15 to June 15 due to anadromous fish.</p>		
2. Compensatory Mitigation for Impacts to Waters of the U.S. or Waters of the State		
2a. Does the project require Compensatory Mitigation for impacts to Waters of the U.S. or Waters of the State?	<input type="checkbox"/> Yes <input checked="" type="checkbox"/> No If no, explain: Due to the minimal amount of impacts, no mitigation is proposed.	
2b. If yes, mitigation is required by (check all that apply):	<input type="checkbox"/> DWQ <input type="checkbox"/> Corps	
2c. If yes, which mitigation option will be used for this project?	<input type="checkbox"/> Mitigation bank <input type="checkbox"/> Payment to in-lieu fee program <input type="checkbox"/> Permittee Responsible Mitigation	
3. Complete if Using a Mitigation Bank		
3a. Name of Mitigation Bank: not applicable		
3b. Credits Purchased (attach receipt and letter)	Type	Quantity
3c. Comments:		
4. Complete if Making a Payment to In-lieu Fee Program		
4a. Approval letter from in-lieu fee program is attached.	<input type="checkbox"/> Yes	
4b. Stream mitigation requested:	linear feet	
4c. If using stream mitigation, stream temperature:	<input type="checkbox"/> warm <input type="checkbox"/> cool <input type="checkbox"/> cold	
4d. Buffer mitigation requested (DWQ only):	square feet	
4e. Riparian wetland mitigation requested:	acres	
4f. Non-riparian wetland mitigation requested:	acres	
4g. Coastal (tidal) wetland mitigation requested:	acres	
4h. Comments:		
5. Complete if Using a Permittee Responsible Mitigation Plan		
5a. If using a permittee responsible mitigation plan, provide a description of the proposed mitigation plan.		

6. Buffer Mitigation (State Regulated Riparian Buffer Rules) – required by DWQ				
6a. Will the project result in an impact within a protected riparian buffer that requires buffer mitigation?				<input type="checkbox"/> Yes <input checked="" type="checkbox"/> No
6b. If yes, then identify the square feet of impact to each zone of the riparian buffer that requires mitigation. Calculate the amount of mitigation required.				
Zone	6c. Reason for impact	6d. Total impact (square feet)	Multiplier	6e. Required mitigation (square feet)
Zone 1			3 (2 for Catawba)	
Zone 2			1.5	
6f. Total buffer mitigation required:				
6g. If buffer mitigation is required, discuss what type of mitigation is proposed (e.g., payment to private mitigation bank, permittee responsible riparian buffer restoration, payment into an approved in-lieu fee fund).				
6h. Comments:				

E. Stormwater Management and Diffuse Flow Plan (required by DWQ)	
1. Diffuse Flow Plan	
1a. Does the project include or is it adjacent to protected riparian buffers identified within one of the NC Riparian Buffer Protection Rules?	<input checked="" type="checkbox"/> Yes <input type="checkbox"/> No
1b. If yes, then is a diffuse flow plan included? If not, explain why. Comments: If required from 1a, see attached buffer permit drawings.	<input checked="" type="checkbox"/> Yes <input type="checkbox"/> No
2. Stormwater Management Plan	
2a. What is the overall percent imperviousness of this project?	N/A
2b. Does this project require a Stormwater Management Plan?	<input checked="" type="checkbox"/> Yes <input type="checkbox"/> No
2c. If this project DOES NOT require a Stormwater Management Plan, explain why:	
2d. If this project DOES require a Stormwater Management Plan, then provide a brief, narrative description of the plan: See attached permit drawings.	
2e. Who will be responsible for the review of the Stormwater Management Plan?	<input type="checkbox"/> Certified Local Government <input type="checkbox"/> DWQ Stormwater Program <input checked="" type="checkbox"/> DWQ 401 Unit
3. Certified Local Government Stormwater Review	
3a. In which local government's jurisdiction is this project?	not applicable
3b. Which of the following locally-implemented stormwater management programs apply (check all that apply):	<input type="checkbox"/> Phase II <input type="checkbox"/> NSW <input type="checkbox"/> USMP <input type="checkbox"/> Water Supply Watershed <input type="checkbox"/> Other:
3c. Has the approved Stormwater Management Plan with proof of approval been attached?	<input type="checkbox"/> Yes <input type="checkbox"/> No
4. DWQ Stormwater Program Review	
4a. Which of the following state-implemented stormwater management programs apply (check all that apply):	<input checked="" type="checkbox"/> Coastal counties <input type="checkbox"/> HQW <input type="checkbox"/> ORW <input type="checkbox"/> Session Law 2006-246 <input type="checkbox"/> Other:
4b. Has the approved Stormwater Management Plan with proof of approval been attached?	<input type="checkbox"/> Yes <input checked="" type="checkbox"/> No
5. DWQ 401 Unit Stormwater Review	
5a. Does the Stormwater Management Plan meet the appropriate requirements?	<input type="checkbox"/> Yes <input type="checkbox"/> No N/A
5b. Have all of the 401 Unit submittal requirements been met?	<input type="checkbox"/> Yes <input type="checkbox"/> No N/A

F. Supplementary Information	
1. Environmental Documentation (DWQ Requirement)	
1a. Does the project involve an expenditure of public (federal/state/local) funds or the use of public (federal/state) land?	<input checked="" type="checkbox"/> Yes <input type="checkbox"/> No
1b. If you answered "yes" to the above, does the project require preparation of an environmental document pursuant to the requirements of the National or State (North Carolina) Environmental Policy Act (NEPA/SEPA)?	<input checked="" type="checkbox"/> Yes <input type="checkbox"/> No
1c. If you answered "yes" to the above, has the document review been finalized by the State Clearing House? (If so, attach a copy of the NEPA or SEPA final approval letter.) Comments:	<input checked="" type="checkbox"/> Yes <input type="checkbox"/> No
2. Violations (DWQ Requirement)	
2a. Is the site in violation of DWQ Wetland Rules (15A NCAC 2H .0500), Isolated Wetland Rules (15A NCAC 2H .1300), DWQ Surface Water or Wetland Standards, or Riparian Buffer Rules (15A NCAC 2B .0200)?	<input type="checkbox"/> Yes <input checked="" type="checkbox"/> No
2b. Is this an after-the-fact permit application?	<input type="checkbox"/> Yes <input checked="" type="checkbox"/> No
2c. If you answered "yes" to one or both of the above questions, provide an explanation of the violation(s):	
3. Cumulative Impacts (DWQ Requirement)	
3a. Will this project (based on past and reasonably anticipated future impacts) result in additional development, which could impact nearby downstream water quality?	<input type="checkbox"/> Yes <input checked="" type="checkbox"/> No
3b. If you answered "yes" to the above, submit a qualitative or quantitative cumulative impact analysis in accordance with the most recent DWQ policy. If you answered "no," provide a short narrative description. Due to the minimal transportation impact resulting from this bridge replacement, this project will neither influence nearby land uses nor stimulate growth. Therefore, a detailed indirect or cumulative effects study will not be necessary.	
4. Sewage Disposal (DWQ Requirement)	
4a. Clearly detail the ultimate treatment methods and disposition (non-discharge or discharge) of wastewater generated from the proposed project, or available capacity of the subject facility. not applicable	

5. Endangered Species and Designated Critical Habitat (Corps Requirement)		
5a. Will this project occur in or near an area with federally protected species or habitat?	<input type="checkbox"/> Yes	<input checked="" type="checkbox"/> No
5b. Have you checked with the USFWS concerning Endangered Species Act impacts?	<input type="checkbox"/> Yes	<input checked="" type="checkbox"/> No
5c. If yes, indicate the USFWS Field Office you have contacted.	<input type="checkbox"/> Raleigh <input type="checkbox"/> Asheville	
5d. What data sources did you use to determine whether your site would impact Endangered Species or Designated Critical Habitat? The USFWS County Website.		
6. Essential Fish Habitat (Corps Requirement)		
6a. Will this project occur in or near an area designated as essential fish habitat?	<input type="checkbox"/> Yes	<input checked="" type="checkbox"/> No
6b. What data sources did you use to determine whether your site would impact Essential Fish Habitat? NMFS County Index		
7. Historic or Prehistoric Cultural Resources (Corps Requirement)		
7a. Will this project occur in or near an area that the state, federal or tribal governments have designated as having historic or cultural preservation status (e.g., National Historic Trust designation or properties significant in North Carolina history and archaeology)?	<input type="checkbox"/> Yes	<input checked="" type="checkbox"/> No
7b. What data sources did you use to determine whether your site would impact historic or archeological resources? NEPA Documentation		
8. Flood Zone Designation (Corps Requirement)		
8a. Will this project occur in a FEMA-designated 100-year floodplain?	<input checked="" type="checkbox"/> Yes	<input type="checkbox"/> No
8b. If yes, explain how project meets FEMA requirements: NCDOT Hydraulics Unit coordination with FEMA		
8c. What source(s) did you use to make the floodplain determination? FEMA Maps		
Dr. Gregory J. Thorpe, Ph D Applicant/Agent's Printed Name	 Applicant/Agent's Signature <small>(Agent's signature is valid only if an authorization letter from the applicant is provided.)</small>	1-30-12 Date



North Carolina Department of Environment and Natural Resources
Division of Water Quality

Seventy Eaves Perdue
Governor

Charles Warkilic, P. E.
Director

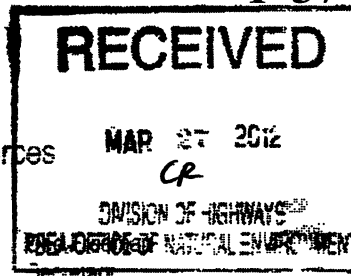

March 21, 2012
Beaufort County
DWQ Project No. 20120101
Bridge 42 over Durham Creek
TIP B-4421

APPROVAL of 401 WATER QUALITY CERTIFICATION with ADDITIONAL CONDITIONS

Dr. Gregory Thorpe, Ph.D., Environmental Management Director
Project Development and Environmental Analysis Branch
N. C. Department of Transportation
1548 Mail Service Center
Raleigh, North Carolina. 27699-1548

Dear Dr. Thorpe:

You have our approval, in accordance with the conditions listed below, for the following impacts for the purpose of replacing Bridge Number 42 over Durham Creek on SR 1003 (Tunstall Swamp Rd.) in Beaufort County:

Wetland and Stream Impacts in the Tar-Pamlico Basin

Site Number	Wetlands Fill (ac)	Wetlands Hand Clearing (ac)	Streams Fill (sq ft)
Bridge 42	0.01	0.02	24.9
Utility	0.01	0.14	
Total	0.02	0.16	
Net Total Impacts	0.18		24.9*

*impacts due to bridge pilings

The project shall be constructed in accordance with your application dated received February 6, 2012. After reviewing your application, we have decided that these impacts are covered by General Water Quality Certification Numbers 3687 and 3819. These certifications correspond to the Nationwide Permits 3 and 12 issued by the Corps of Engineers. In addition, you should acquire any other federal, state or local permits before you proceed with your project including (but not limited to) Sediment and Erosion Control, Non-Discharge and Water Supply Watershed regulations. This approval will expire with the accompanying 404 permit.

This approval is valid solely for the purpose and design described in your application (unless modified below). Should your project change, you must notify the DWQ and submit a new application. If the property is sold, the new owner must be given a copy of this Certification and approval letter, and is thereby responsible for complying with all the conditions. If total wetland fills for this project (now or in the future) exceed one acre, or of total impacts to streams (now or in the future) exceed 150 linear feet, compensatory mitigation may be required as described in 15A NCAC 2H .0506 (h) (6) and (7). For this approval to remain valid, you must adhere to the conditions listed in the attached certification.

1. The issuance of this certification does not exempt the Permittee from complying with any and all statutes, rules, regulations, or ordinances that may be imposed by other government agencies (i.e. local, state, and federal) having jurisdiction, including but not limited to applicable buffer rules, stormwater management rules, soil erosion and sedimentation control requirements, etc.

North Carolina Division of Water Quality
943 Washington Square Mall
Washington, NC 27889

Internet: www.ncwaterquality.org
Phone: 252-946-6481
FAX: 252-946-9215



2. The permittee and its authorized agents shall conduct its activities in a manner consistent with State water quality standards (including any requirements resulting from compliance with §303(d) of the Clean Water Act) and any other appropriate requirements of State and Federal law. If DWQ determines that such standards or laws are not being met (including the failure to sustain a designated or achieved use) or that State or federal law is being violated, or that further conditions are necessary to assure compliance, DWQ may reevaluate and modify this certification.
- * 3. The Permittee shall ensure that the final design drawings adhere to the certification and to the drawings submitted for approval.
4. The permittee will need to adhere to all appropriate in-water work moratoria (including the use of pile driving or vibration techniques) prescribed by the NC Wildlife Resources Commission and NC Division of Marine Fisheries. No in-water work is permitted between February 15 and June 15 of any year, without prior approval from the NC Division of Water Quality and the NC Wildlife Resources Commission. In addition, the permittee shall conform with the NCDOT policy entitled "Stream Crossing Guidelines for Anadromous Fish Passage (May 12, 1997) at all times.
5. If concrete is used during construction, a dry work area shall be maintained to prevent direct contact between curing concrete and stream water. Water that inadvertently contacts uncured concrete shall not be discharged to surface waters due to the potential for elevated pH and possible aquatic life and fish kills.
6. The use of rip-rap above the Normal High Water Mark shall be minimized. Any rip-rap placed for stream stabilization shall be placed in stream channels in such a manner that it does not impede aquatic life passage.
7. During the construction of the project, no staging of equipment of any kind is permitted in waters of the U.S., or protected riparian buffers.
8. The dimension, pattern and profile of the stream above and below the crossing shall not be modified. Disturbed floodplains and streams shall be restored to natural geomorphic conditions.
9. Heavy equipment shall be operated from the banks rather than in the stream channel in order to minimize sedimentation and reduce the introduction of other pollutants into the stream.
10. All mechanized equipment operated near surface waters must be regularly inspected and maintained to prevent contamination of stream waters from fuels, lubricants, hydraulic fluids, or other toxic materials.
11. Erosion and sediment control practices must be in full compliance with all specifications governing the proper design, installation and operation and maintenance of such Best Management Practices in order to protect surface waters standards:
 - a. The erosion and sediment control measures for the project must be designed, installed, operated, and maintained in accordance with the most recent version of the *North Carolina Sediment and Erosion Control Planning and Design Manual*.
 - b. The design, installation, operation, and maintenance of the sediment and erosion control measures must be such that they equal, or exceed, the requirements specified in the most recent version of the *North Carolina Sediment and Erosion Control Manual*. The devices shall be maintained on all construction sites, borrow sites, and waste pile (spoil) projects, including contractor-owned or leased borrow pits associated with the project.
 - c. For borrow pit sites, the erosion and sediment control measures must be designed, installed, operated, and maintained in accordance with the most recent version of the *North Carolina Surface Mining Manual*.
 - d. The reclamation measures and implementation must comply with the reclamation in accordance with the requirements of the Sedimentation Pollution Control Act.
12. No rock, sand or other materials shall be dredged from the stream channel except where authorized by this certification.
13. Discharging hydroseed mixtures and washing out hydroseeders and other equipment in or adjacent to surface waters is prohibited.
14. All fill slopes located in jurisdictional wetlands shall be placed at slopes no flatter than 3:1, unless otherwise authorized by this certification.
15. The outside buffer, wetland or water boundary located within the construction corridor approved by this certification shall be clearly marked by highly visible fencing prior to any land disturbing activities. Impacts to areas within the fencing are prohibited unless otherwise authorized by this certification.

16. Native riparian vegetation (ex. list trees and shrubs native to your geographic region) must be reestablished within the construction limits of the project by the end of the growing season following completion of construction.
17. There shall be no excavation from, or waste disposal into, jurisdictional wetlands or waters associated with this certification without appropriate modification. Should waste or borrow sites, or access roads to waste or borrow sites, be located in wetlands or streams, compensatory mitigation will be required since that is a direct impact from road construction activities.
18. Strict adherence to the most recent version of NCDOT's Best Management Practices For Bridge Demolition and Removal approved by the US Army Corps of Engineers is a condition of the 401 Water Quality Certification.
19. The post-construction removal of any temporary bridge structures must return the project site to its preconstruction contours and elevations. The impacted areas shall be revegetated with appropriate native species.
20. Bridge piles and bents shall be constructed using driven piles (hammer or vibratory) or drilled shaft construction methods. More specifically, jetting or other methods of pile driving are prohibited without prior written approval from NCDWQ.
21. All pile driving or drilling activities shall be enclosed in turbidity curtains unless otherwise approved by NCDWQ in this certification.
22. Bridge deck drains shall not discharge directly into the stream. Stormwater shall be directed across the bridge and pre-treated through site-appropriate means (grassed swales, pre-formed scour holes, vegetated buffers, etc.) before entering the stream. Please refer to the most current version of *Stormwater Best Management Practices*.
23. Riprap shall not be placed in the active thalweg channel or placed in the streambed in a manner that precludes aquatic life passage. Bioengineering boulders or structures should be properly designed, sized and installed.
24. The Permittee shall report any violations of this certification to the Division of Water Quality within 24 hours of discovery.
- * 25. Upon completion of the project (including any impacts at associated borrow or waste site), the NCDOT Division Engineer shall complete and return the enclosed "Certification of Completion Form" to notify DWQ when all work included in the 401 Certification has been completed.
26. A copy of this Water Quality Certification shall be maintained on site at the construction site at all times. In addition, the Water Quality Certification and all subsequent modifications, if any, shall be maintained with the Division Engineer and the on-site project manager.

If you do not accept any of the conditions of this certification, you may ask for an adjudicatory hearing. You must act within 60 days of the date that you receive this letter. To ask for a hearing, send a written petition that conforms to Chapter 150B of the North Carolina General Statutes to the Office of Administrative Hearings, 6714 Mail Service Center, Raleigh, N.C. 27699. This certification and its conditions are final and binding unless you ask for a hearing. This letter completes the review of the Division of Water Quality under Section 401 of the Clean Water Act. If you have any questions, please contact Garcy Ward at (252) 948-3922.

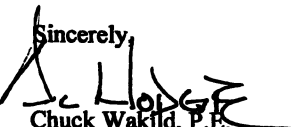
Sincerely,

for
Chuck Wakild, P.E.

Attachments (General Certification and Certificate of Completion form)

cc: Jay Johnson, DOT Division 2 Environmental Officer
Tom Steffens, US Army Corps of Engineers, Washington Field Office
Stephen Lane, DCM, Morehead City
Sonia Carrillo, DWQ, 401/Wetlands Unit
File Copy

Water Quality Certification N^o. 3687

GENERAL CERTIFICATION FOR PROJECTS ELIGIBLE FOR U.S. ARMY CORPS OF ENGINEERS NATIONWIDE PERMIT NUMBERS: 3 (MAINTENANCE), 4 (FISH AND WILDLIFE HARVESTING, ENHANCEMENT, AND ATTRACTION DEVICES AND ACTIVITIES), 5 (SCIENTIFIC MEASUREMENT DEVICES—25 CUBIC YARDS FOR WEIRS AND FLUMES), 6 (SURVEY ACTIVITIES—25 CUBIC YARDS FOR TEMPORARY PADS), 7 (OUTFALL STRUCTURES AND ASSOCIATED INTAKE STRUCTURES), 19 (MINOR DREDGING), 20 (OIL SPILL CLEANUP), 22 (REMOVAL OF VESSELS), 25 (STRUCTURAL DISCHARGE), 30(MOIST SOIL MANAGEMENT FOR WILDLIFE), 32 (COMPLETED ENFORCEMENT ACTIONS), 36 (BOAT RAMPS (IN NONWETLAND SITES)), AND REGIONAL PERMIT 197800056 (PIERS, DOCKS AND BOATHOUSES), AND REGIONAL PERMIT 197800125 (BOAT RAMPS) AND RIPARIAN AREA PROTECTION RULES (BUFFER RULES)

Water Quality Certification Number 3687 is issued in conformity with the requirements of Section 401, Public Laws 92-500 and 95-217 of the United States and subject to the North Carolina Division of Water Quality (DWQ) Regulations in 15 NCAC 2H, Section .0500 and 15 NCAC 2B .0200 for the discharge of fill material to waters and wetland areas which are waters of the United States as described in 33 CFR 330 Appendix A (B) (3, 4, 5, 6, 7, 19, 20, 22, 25, 30, 32, and 36) of the Corps of Engineers regulations and Regional Permits 197800056 and 19780125 and for the Riparian Area Protection Rules (Buffer Rules) in 15A NCAC 2B .0200.

The State of North Carolina certifies that the specified category of activity will not violate applicable portions of Sections 301, 302, 303, 306 and 307 of the Public Laws 92-500 and 95-217 if conducted in accordance with the conditions hereinafter set forth.

Activities meeting any one (1) of the following thresholds or circumstances require *written approval* for a 401 Water Quality Certification from the Division of Water Quality (the "Division"):

- a. Impacts equal or greater than 40 linear feet of additional permanent stream impact at an existing stream crossing location, or
- b. Temporary or permanent impacts equal to or exceeding: one-third (1/3) acre of wetlands East of Interstate-95, or one-tenth (1/10) of acre of wetlands West of Interstate-95; or
- c. Any impact associated with a Notice of Violation or an enforcement action initiated by the Division and/or the Division of Land Resources; or
- d. Projects with any impacts to streams, wetlands, and/or waters that have received a Notice of Violation from the Division and/or Division of Land Resources; or
- e. Any impacts to streams and/or buffers in the Neuse, Tar-Pamlico, Randleman and Catawba River Basins (or any other basins with Riparian Area Protection Rules [Buffer Rules] in effect at the time of application) *unless* the activities are listed as "EXEMPT" from these Rules.

*

In accordance with North Carolina General Statute Section 143-215.3D(e), written approval for a 401 Water Quality General Certification must include the appropriate fee. If a project also requires a CAMA Permit, then one payment to both agencies shall be submitted and will be the higher of the two fees.

Activities included in this General Certification and below the thresholds listed above *do not* require written approval from the Division of Water Quality as long as they comply with the Conditions of Certification listed below. If any of these Conditions cannot be met, written approval from the Division is required.

Water Quality Certification N^o. 3687

Conditions of Certification:

1. No Impacts Beyond Those Authorized for this General Certification

No waste, spoil, solids, or fill of any kind shall occur in wetlands, waters, or riparian areas beyond the thresholds established for use of this General Certification, or beyond the footprint of the impacts authorized in the written approval, including incidental impacts. All construction activities, including the design, installation, operation, and maintenance of sediment and erosion control Best Management Practices, shall be performed so that no violations of state water quality standards, statutes, or rules occur.

2. Standard Erosion and Sediment Control Practices

Erosion and sediment control practices must be in full compliance with all specifications governing the proper design, installation and operation and maintenance of such Best Management Practices:

- a. Design, installation, operation, and maintenance of the sediment and erosion control measures must be such that they equal, or exceed, the requirements specified in the most recent version of the *North Carolina Sediment and Erosion Control Manual*. The devices shall be maintained on all construction sites, borrow sites, and waste pile (spoil) projects, including contractor-owned or leased borrow pits associated with the project.
- b. For borrow pit sites, the erosion and sediment control measures must be designed, installed, operated, and maintained in accordance with the most recent version of the *North Carolina Surface Mining Manual*.
- c. Reclamation measures and implementation must comply with the reclamation in accordance with the requirements of the Sedimentation Pollution Control Act and the Mining Act of 1971.
- d. Sufficient materials required for stabilization and/or repair of erosion control measures and stormwater routing and treatment shall be on site at all times, except for publicly funded linear transportation projects when materials can be accessed offsite in a timely manner.
- e. If the project occurs in waters or watersheds classified as Primary Nursery Areas (PNAs), Trout (Tr), SA, WS-I, WS-II, High Quality (HQW), or Outstanding Resource (ORW) waters, then the sediment and erosion control requirements contained within *Design Standards in Sensitive Watersheds* (15A NCAC 04B .0124) supercede all other sediment and erosion control requirements.

3. No Sediment and Erosion Control Measures in Wetlands or Waters

Sediment and erosion control measures should not be placed in wetlands or waters outside of the permitted impact areas without prior approval from the Division. If placement of sediment and erosion control devices in wetlands and waters is unavoidable, then the design and placement of temporary erosion control measures shall not be conducted in a manner that may result in dis-equilibrium of wetlands or stream beds or banks, adjacent to or upstream and down stream of the above structures. All sediment and erosion control devices shall be removed and the natural grade restored within two (2) months of the date that the Division of Land Resources or locally delegated program has released the project.

4. Construction Stormwater Permit NCG010000

Upon the approval of an Erosion and Sedimentation Control Plan issued by the Division of Land Resources (DLR) or a DLR delegated local erosion and sedimentation control program, an NPDES General stormwater permit (NCG010000) administered by the Division is automatically issued to the project. This General Permit allows stormwater to be discharged during land disturbing construction activities as stipulated by conditions in the permit. If the

Water Quality Certification N^o. 3687

activity is covered by this permit [applicable to construction projects that disturb one (1) or more acres], full compliance with permit conditions including the sedimentation control plan, self-monitoring, record keeping and reporting requirements are required. A copy of this permit and monitoring report forms may be found at http://h2o.enr.state.nc.us/su/Forms_Documents.htm.

NCDOT shall be required to be in full compliance with the conditions related to construction activities within the most recent version of their individual NPDES (NCS000250) stormwater permit.

5. Work in the Dry

All work in or adjacent to stream waters shall be conducted in a dry work area. Approved best management practices from the most current version of the NC Sediment and Erosion Control Manual, or the NC DOT Construction and Maintenance Activities Manual, such as sandbags, rock berms, cofferdams, and other diversion structures shall be used to minimize excavation in flowing water. Exceptions to this condition require submittal to, and approval by, the Division.

6. Construction Moratoriums and Coordination

If activities must occur during periods of high biological activity (i.e. sea turtle or bird nesting), then biological monitoring may be required at the request of other state or federal agencies and coordinated with these activities. This condition can be waived through written concurrence on a case by case basis upon reasonable justification.

All moratoriums on construction activities established by the NC Wildlife Resources Commission (WRC), US Fish and Wildlife Service (USFWS), NC Division of Marine Fisheries (DMF), or National Marine Fisheries Service (NMFS) to protect trout, anadromous fish, larval/post-larval fishes and crustaceans, or other aquatic species of concern shall be obeyed. This condition can be waived through written concurrence on a case by case basis upon reasonable justification.

Work within the twenty-five (25) designated trout counties or identified state or federal endangered or threatened species habitat shall be coordinated with the appropriate WRC, USFWS, NMFS personnel.

7. Riparian Area Protection Rules (Buffer Rules)

Activities located in the protected 50-foot wide riparian areas (whether jurisdictional wetlands or not) within the Neuse, Tar-Pamlico, Randleman, Catawba (or any other basin with buffer rules), shall be limited to "uses" identified within and constructed in accordance with 15A NCAC 2B .0233, .0259, .0250, and .0243, and shall be located, designed, constructed, and maintained to have minimal disturbance to protect water quality to the maximum extent practicable through the use of best management practices. All riparian area protection rule requirements, including diffuse flow requirements, must be met.

8. Water Supply Watershed Buffers

The 100-foot wide (high-density development) or the 30-foot wide vegetative buffer (all other development) must be maintained adjacent to all perennial waters except for allowances as provided in the Water Supply Watershed Protection Rules [15A NCAC 2B .0212 through .0215].

Water Quality Certification N^o. 3687

9. Placement of Culverts and Other Structures in Waters and Wetlands

The application must include construction plans with cross-sectional details in order to indicate that the current stability of the stream will be maintained or enhanced (i.e., not result in head cuts).

Culverts required for this project shall be designed and installed in such a manner that the original stream profiles are not altered and allow for aquatic life movement during low flows. Existing stream dimensions (including the cross section dimensions, pattern, and longitudinal profile) must be maintained above and below locations of each culvert. Placement of culverts and other structures in waters, streams, and wetlands must be placed below the elevation of the streambed by one foot for all culverts with a diameter greater than 48 inches, and 20 percent of the culvert diameter for culverts having a diameter less than 48 inches, to allow low flow passage of water and aquatic life, unless otherwise justified and approved by the Division.

Installation of culverts in wetlands must ensure continuity of water movement and be designed to adequately accommodate high water or flood conditions. Additionally, when roadways, causeways or other fill projects are constructed across FEMA-designated floodways or wetlands, openings such as culverts or bridges must be provided to maintain the natural hydrology of the system as well as prevent constriction of the floodway that may result in destabilization of streams or wetlands.

Any rip rap required for normal pipe burial and stabilization shall be buried such that the original stream elevation is restored and maintained.

The establishment of native, woody vegetation and other soft stream bank stabilization techniques must be used where practicable instead of rip-rap or other bank hardening methods.

10. If concrete is used during the construction, then a dry work area should be maintained to prevent direct contact between curing concrete and stream water. Water that inadvertently contacts uncured concrete should not be discharged to surface waters due to the potential for elevated pH and possible aquatic life/fish kills.
11. Applications for riprap groins proposed in accordance with 15A NCAC 07H .1401 (NC Division of Coastal Management General Permit for construction of Wooden and Riprap Groins in Estuarine and Public Trust Waters) must meet all the specific conditions for design and construction specified in 15A NCAC 07H .1405.

12. Temporary Fills and/or Access Roads

All temporary fill and culverts shall be removed and the impacted area returned to the original grade, including each stream's original cross sectional dimensions, plan form pattern, and longitudinal bed and bed profile after construction is complete or within two (2) months of the establishment of the crossing, whichever is sooner, and the various sites shall be stabilized with natural woody vegetation (except for the maintenance areas of permanent utility crossings) and restored to prevent erosion. If the crossings are not completely removed and restored as described above within the specified time above, then written approval from the Division must be obtained to modify this condition.

Water Quality Certification N^o. 3687

13. For activities requiring written approval, additional site-specific conditions may be added to the approval letter in order to ensure compliance with all applicable water quality and effluent standards.
- * 14. Certificate of Completion
- When written authorization is required for use of this certification, upon completion of all permitted impacts included within the approval and any subsequent modifications, the applicant shall be required to return the certificate of completion attached to the approval. One copy of the certificate shall be sent to the DWQ Central Office in Raleigh at 1650 Mail Service Center, Raleigh, NC, 27699-1650.
- * 15. If an environmental document is required under NEPA or SEPA, then this General Certification is not valid until a Finding of No Significant Impact (FONSI) or Record of Decision (ROD) is issued by the State Clearinghouse.
16. This General Certification shall expire three (3) years from the date of issuance of the written approval or on the same day as the expiration date of these corresponding Nationwide and Regional General Permits. In accordance with General Statute 136-44.7B, certifications issued to the NCDOT shall expire only upon expiration of the federal 404 Permit. The conditions in effect on the date of issuance of Certification for a specific project shall remain in effect for the life of the project, regardless of the expiration date of this Certification. If the construction process for approved activities will overlap the expiration and renewal date of the corresponding 404 Permit and the Corps allows for continued use of the 404 Permit, then the General Certification shall also remain in effect without requiring re-application and re-approval to use this Certification for the specific impacts already approved.
17. The applicant/permittee and their authorized agents shall conduct all activities in a manner consistent with State water quality standards (including any requirements resulting from compliance with §303(d) of the Clean Water Act), and any other appropriate requirements of State and Federal Law. If the Division determines that such standards or laws are not being met, including failure to sustain a designated or achieved use, or that State or Federal law is being violated, or that further conditions are necessary to assure compliance, then the Division may reevaluate and modify this General Water Quality Certification.

Non-compliance with or violation of the conditions herein set forth by a specific fill project shall result in revocation of this General Certification for the project and may result in criminal and/or civil penalties.

The Director of the North Carolina Division of Water Quality may require submission of a formal application for Individual Certification for any project in this category of activity if it is determined that the project is likely to have a significant adverse effect upon water quality, including state or federally listed endangered or threatened aquatic species, or degrade the waters so that existing uses of the wetland or downstream waters are precluded.

Public hearings may be held for specific applications or group of applications prior to a Certification decision if deemed in the public's best interest by the Director of the North Carolina Division of Water Quality.

Water Quality Certification N^o. 3687

Effective date: November 1, 2007

DIVISION OF WATER QUALITY

By

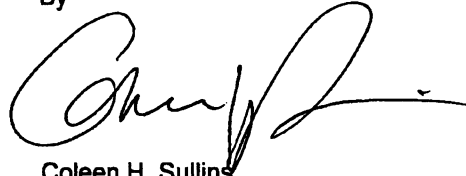
A handwritten signature in black ink, appearing to read 'Coleen H. Sullins', written over a horizontal line.

Coleen H. Sullins

Director

History Note: Water Quality Certification Number 3687 replaces Water Quality Certification Number 3376 issued on March 18, 2002, Water Quality Certification Number 3494 issued December 31, 2004, and Water Quality Certification Number 3624 issued March 2007. This General Certification is rescinded when the Corps of Engineers re-authorizes any of these Nationwide or Regional Permits or when deemed appropriate by the Director of the Division of Water Quality.

Water Quality Certification N^o. 3819

**GENERAL CERTIFICATION FOR PROJECTS ELIGIBLE
FOR U.S. ARMY CORPS OF ENGINEERS NATIONWIDE PERMIT
NUMBERS 12 (UTILITY LINE ACTIVITIES) AND 47 (PIPELINE SAFETY PROGRAM
DESIGNATED TIME SENSITIVE INSPECTIONS AND REPAIRS),
AND RIPARIAN AREA PROTECTION RULES (BUFFER RULES)**

Water Quality Certification Number 3819 is issued in conformity with the requirements of Section 401, Public Laws 92-500 and 95-217 of the United States and subject to the North Carolina Division of Water Quality (DWQ) Regulations in 15A NCAC 2H, Section .0500 and 15A NCAC 2B .0200 for the discharge of fill material to waters and wetland areas as described in 33 CFR 330 Appendix A (B) (12) and Nationwide Permit No. 47 of the Corps of Engineers regulations including any fill activity for utility line backfill and bedding, and for the Riparian Area Protection Rules (Buffer Rules) in 15A NCAC 2B .0200.

The State of North Carolina certifies that the specified category of activity will not violate applicable portions of Sections 301, 302, 303, 306 and 307 of the Public Laws 92-500 and 95-217 if conducted in accordance with the conditions hereinafter set forth.

- * **Permanent impacts to any wetlands and/or waters, including streams, under this General Certification requires application to, and approval from, the Division of Water Quality (the "Division").**
 - * Temporary impacts covered by this General Certification do not require written approval from the Division as long as they comply with the Conditions listed below. ***Written approval is required if the maintenance corridor is greater than 15 feet wide. Gas pipelines may have a maintenance corridor wider than fifteen feet if mitigation is provided for these additional wetland fills.***
- If any of these Conditions cannot be met, or if the activities are associated with, or in response to a Notice of Violation or an enforcement action initiated by the Division of Water Quality or the Division of Land Resources, then written approval from the Division is required to use this Certification. Activities that are located within river basins with Riparian Area Protection Rules (Buffer Rules) require written approval unless listed in the Table of Uses as "EXEMPT".**
- * In accordance with North Carolina General Statute Section 143-215.3D(e), any requirement for written approval for a 401 Water Quality Certification must include the appropriate fee. If a project also requires a CAMA Permit, then one payment to both agencies shall be submitted and will be the higher of the two fees.

Conditions of Certification:

1. No Impacts Beyond Thresholds that Qualify for this Certification

No waste, spoil, solids, or fill of any kind shall occur in wetlands, waters, or riparian areas beyond the thresholds established for use of this Certification, including incidental impacts. All construction activities, including the design, installation, operation, and maintenance of sediment and erosion control Best Management Practices, shall be performed so that no violations of state water quality standards, statutes, or rules occur.

2. Standard Erosion and Sediment Control Practices

Erosion and sediment control practices must be in full compliance with all specifications governing the proper design, installation and operation and maintenance of such Best Management Practices:

Water Quality Certification N^o. 3819

- a. Design, installation, operation, and maintenance of the sediment and erosion control measures must be such that they equal, or exceed, the requirements specified in the most recent version of the *North Carolina Sediment and Erosion Control Manual*. The devices shall be maintained on all construction sites, borrow sites, and waste pile (spoil) projects, including contractor-owned or leased borrow pits associated with the project.
 - b. For borrow pit sites, the erosion and sediment control measures must be designed, installed, operated, and maintained in accordance with the most recent version of the *North Carolina Surface Mining Manual*.
 - c. Reclamation measures and implementation must comply with the reclamation in accordance with the requirements of the Sedimentation Pollution Control Act and the Mining Act of 1971.
 - d. Sufficient materials required for stabilization and/or repair of erosion control measures and stormwater routing and treatment shall be on site at all times.
 - e. If the project occurs in waters or watersheds classified as Primary Nursery Areas (PNA's), Trout (Tr), SA, WS-I, WS-II, High Quality (HQW), or Outstanding Resource (ORW) waters, then the sediment and erosion control requirements contained within *Design Standards in Sensitive Watersheds* (15A NCAC 04B .0124) supercede all other sediment and erosion control requirements.
3. No Sediment and Erosion Control Measures in Wetlands or Waters

Sediment and erosion control measures should not be placed in wetlands or waters without approval by the Division. . If placement of sediment and erosion control devices in wetlands and waters is unavoidable, design and placement of temporary erosion control measures shall not be conducted in a manner that may result in dis-equilibrium of wetlands or stream beds or banks, adjacent to or upstream and down stream of the above structures. All sediment and erosion control devices shall be removed and the natural grade restored within two (2) months of the date that the Division of Land Resources or locally delegated program has released the project.

4. Construction Stormwater Permit NCG010000

Upon the approval of an Erosion and Sedimentation Control Plan issued by the Division of Land Resources (DLR) or a DLR delegated local erosion and sedimentation control program, an NPDES General stormwater permit (NCG010000) administered by the Division is automatically issued to the project. This General Permit allows stormwater to be discharged during land disturbing construction activities as stipulated by conditions in the permit. If your project is covered by this permit [applicable to construction projects that disturb one (1) or more acres], full compliance with permit conditions including the sedimentation control plan, self-monitoring, record keeping and reporting requirements are required. A copy of this permit and monitoring report forms may be found at http://h2o.enr.state.nc.us/su/Forms_Documents.htm.

5. Construction Moratoriums and Coordination

All moratoriums on construction activities established by the NC Wildlife Resources Commission (WRC), US Fish and Wildlife Service (USFWS), NC Division of Marine Fisheries (DMF), or National Marine Fisheries Service (NMFS) to protect trout, anadromous fish, larval/post-larval fishes and crustaceans, or other aquatic species of concern shall be implemented.

Work within the twenty-five (25) designated trout counties or identified state or federal endangered or threatened species habitat shall be coordinated with the appropriate WRC, USFWS, NMFS, and/or DMF personnel.

Water Quality Certification N^o. 3819

6. Work in the Dry

All work in or adjacent to stream waters shall be conducted in a dry work area. Approved best management practices from the most current version of the NC Sediment and Erosion Control Manual, or the NC DOT Construction and Maintenance Activities Manual, such as sandbags, rock berms, cofferdams, and other diversion structures shall be used to minimize excavation in flowing water.

7. Riparian Area Protection (Buffer) Rule

Activities located in the protected 50-foot wide riparian areas (whether jurisdictional wetlands or not), within the Neuse, Tar-Pamlico, Catawba, Randleman, and Jordan (or any other basin with buffer rules), shall be limited to "uses" identified within and constructed in accordance with 15A NCAC 2B .0233, .0259, .0250, .0243, and .0267, and shall be located, designed, constructed, and maintained to have minimal disturbance to protect water quality to the maximum extent practicable through the use of best management practices. All buffer rule requirements, including diffuse flow requirements, must be met.

8. Water Supply Watershed Buffers

The 30-foot wide vegetative buffer (low-density development) or the 100-foot wide (high-density development) must be maintained adjacent to all perennial waters except for allowances as provided in the Water Supply Watershed Protection Rules [15A NCAC 2B .0212 through .0215].

9. Any rip rap required for normal pipe burial and stabilization shall be buried such that the original stream elevation is restored and maintained.

10. Compensatory Mitigation

In accordance with 15A NCAC 2H .0506 (h), compensatory mitigation may be required for losses of 150 linear feet or more of streams and/or one (1) acre or more of wetlands. For linear, public transportation projects, impacts equal to or exceeding 150 linear feet per stream shall require mitigation.

Compensatory stream mitigation shall be required at a 1:1 ratio for all perennial and intermittent stream impacts.

Buffer mitigation may be required for any project with Buffer Rules in effect at the time of application for buffer impacts resulting from activities classified as "Allowable with Mitigation" within the "Table of Uses" section of the Buffer Rules or require a variance under the Buffer Rules.

A determination of buffer, wetland and stream mitigation requirements shall be made by the Division for any application for this Certification. Design and monitoring protocols shall follow the US Army Corps of Engineers Wilmington District *Stream Mitigation Guidelines* (April 2003), or its subsequent updates. Compensatory mitigation plans shall be submitted for written Division approval as required in those protocols. Alternatively, the Division will accept payment into an in-lieu fee program or credit purchase from a mitigation bank.

Finally, the mitigation plan must be implemented and/or constructed before any permanent building or structure on site is occupied. In the case of public road projects, the mitigation plan must be implemented before the road is opened to the public. Proof of payment to an in-lieu fee program or mitigation bank must be provided to the Division to satisfy this requirement.

Water Quality Certification N^o. 3819

- * 11. For all activities requiring re-alignment of streams, a stream relocation plan must be included for written Division approval. Relocated stream designs should include the same dimensions, patterns and profiles as the existing channel (or a stable reference reach if the existing channel is unstable), to the maximum extent practical. The new channel should be constructed in the dry and water shall not be turned into the new channel until the banks are stabilized. Vegetation used for bank stabilization shall be limited to native woody species, and should include establishment of a 30-foot wide wooded and an adjacent 20-foot wide vegetated buffer on both sides of the relocated channel to the maximum extent practical. A transitional phase incorporating coir fiber and seedling establishment is allowable. Rip-rap, A-Jacks, concrete, gabions or other hard structures may be allowed if it is necessary to maintain the physical integrity of the stream, but the applicant must provide written justification and any calculations used to determine the extent of rip-rap coverage. Please note that if the stream relocation is conducted as a stream restoration as defined in the US Army Corps of Engineers Wilmington District, April 2003 *Stream Mitigation Guidelines* (or its subsequent updates), the restored length can be used as compensatory mitigation for the impacts resulting from the relocation.

12. For sewer lines, the edge of the construction corridor shall not be installed parallel to and closer than 10 feet from top of bank to a stream except for the following classifications; 50 feet to waters classified as WS (except WS-IV or WS-V), B, SA, ORW, HQW, or SB from normal high water (or tide elevation) and wetlands; or 100 feet to private or public water supply sources or waters classified as WS-I waters or Class I or Class II impounded reservoirs used as a source of drinking water in accordance with 15A NCAC 02T .0305(f).

Utility lines shall not cross a stream channel at other than a near-perpendicular direction (i.e., stream channel crossings shall not be at an angle of less than 75 degrees or more than 105 degrees to the stream bank).

13. Any wastewater line that crosses any stream shown on the most recent version of the 1:24,000 USGS topographic map or NRCS (SCS) County Soil Survey as permanent or intermittent shall be installed either a) with no joints connected within the footprint of a stream channel or within two (2) feet of the stream banks in the case of plastic or PVC pipes or b) with properly bedded and supported ductile iron. *Otherwise, written approval from DWQ is required.*
14. If concrete is used during the construction, then a dry work area should be maintained to prevent direct contact between curing concrete and stream water. Water that inadvertently contacts uncured concrete should not be discharged to surface waters due to the potential for elevated pH and possible aquatic life/fish kills.
15. Herbicides can be applied in wetlands or other waters only when applied by a certified applicator, and in strict accordance with product labeling.
16. Placement of rip-rap shall be restricted to the stream bottom and banks directly impacted by the placement of the utility line. Rip-rap shall only be used below the normal high water level. The stream berm must be restored to the original contour after construction. Placement of rip-rap or other materials shall not result in de-stabilization of the stream bed or banks upstream or downstream of the crossing.
17. Annual native species suitable for wet locations shall be planted and established within jurisdictional wetlands for soil and erosion control. Non-native perennials such as fescue are prohibited.
18. A one-time application of fertilizer to re-establish vegetation is allowed, but is restricted to no closer than 10 feet (3 meters) from top of bank of streams. Any fertilizer application must comply with all other Federal, State and Local regulations.

Water Quality Certification N°. 3819

19. The construction corridor (including access roads and stockpiling of materials) is limited to 40 feet (12.2 meters) in width in wetlands and across stream channels and must be minimized to the maximum extent practicable.
20. Permanent, maintained access corridors shall be restricted to the minimum width practicable and shall not exceed 15 feet in width except at manhole locations. A 15-foot by 15-foot perpendicular vehicle turnaround must be spaced at least 500 feet (152.4 meters) apart.
21. An anti-seep collar shall be placed at the downstream (utility line gradient) wetland boundary and every 150 feet (45.7 meters) up the gradient until the utility exits the wetland for buried utility lines. Anti-seep collars may be constructed with class B concrete, compacted clay, PVC pipe, or metal collars. Wetland crossings that are directionally drilled, and perpendicular wetland crossings that are open cut and less than 150 feet (45.7 meters) long do not require anti-seep collars. The compacted clay shall have a specific infiltration of 1×10^{-5} cm/sec or less. A section and plan view diagram is attached for the anti-seep collars.

The following specifications shall apply to class B concrete:

 - a) Minimum cement content, sacks per cubic yard with rounded course aggregate 5.0
 - b) Minimum cement content, sacks per cubic yard with angular course aggregate 5.5
 - c) Maximum water-cement ratio gallons per sack 6.8
 - d) Slump range 2" to 4"
 - e) Minimum strength - 28 day psi 2,500
22. The applicant shall have a specific plan for restoring wetland contours. Any excess material will be removed to a high ground disposal area.
- * 23. If an environmental document is required under NEPA or SEPA, then this General Certification is not valid until a Finding of No Significant Impact (FONSI) or Record of Decision (ROD) is issued by the State Clearinghouse.
24. In the twenty (20) coastal counties, the appropriate DWQ Regional Office must be contacted to determine if Coastal Stormwater Regulations will be required. .
25. This General Certification does not relieve the applicant of the responsibility to obtain all other required Federal, State or local approvals.
- * 26. When written authorization is required for use of this certification, upon completion of all permitted impacts included within the approval and any subsequent modifications, the applicant shall be required to return the certificate of completion attached to the approval. One copy of the certificate shall be sent to the DWQ Central Office in Raleigh at 1650 Mail Service Center, Raleigh, NC, 27699-1650.
27. This General Certification shall expire three (3) years from the date of issuance of the written approval letter or on the same day as the expiration date of the corresponding Nationwide Permit 12 or Nationwide Permit 47. The conditions in effect on the date of issuance of Certification for a specific project shall remain in effect for the life of the project, regardless of the expiration date of this Certification. If the construction process for approved activities will overlap the expiration and renewal date of the corresponding 404 Permit and the Corps allows for continued use of the 404 Permit, then the General Certification shall also remain in effect without requiring re-application and re-approval to use this Certification for the specific impacts already approved.

Water Quality Certification N°. 3819

28. The applicant/permittee and their authorized agents shall conduct all activities in a manner consistent with State water quality standards (including any requirements resulting from compliance with §303(d) of the Clean Water Act), and any other appropriate requirements of State and Federal Law. If the Division determines that such standards or laws are not being met, including failure to sustain a designated or achieved use, or that State or Federal law is being violated, or that further conditions are necessary to assure compliance, then the Division may reevaluate and modify this General Water Quality Certification.

Non-compliance with or violation of the conditions herein set forth by a specific fill project may result in revocation of this General Certification for the project and may also result in criminal and/or civil penalties.

The Director of the North Carolina Division of Water Quality may require submission of a formal application for individual certification for any project in this category of activity, if it is determined that the project is likely to have a significant adverse effect upon water quality including state or federally listed endangered or threatened aquatic species or degrade the waters so that existing uses of the wetland or downstream waters are precluded.

Public hearings may be held for specific applications or group of applications prior to a certification decision if deemed in the public's best interest by the Director of the North Carolina Division of Water Quality.

Effective date: March 19, 2010

DIVISION OF WATER QUALITY

By

Coleen H. Sullins

Director

History Note: Water Quality General Certification (WQC) Number 3819 issued on March 19, 2010 replaces WQC Number 3699 issued on November 1, 2007, WQC Number 3625 issued on March 19, 2007, WQC Number 3374 issued on March 18, 2002, WQC Number 3288 issued on June 1, 2000, WQC Number 3101 issued on February 11, 1997, WQC Number 3022 issued on September 6, 1995 and WQC Number 2664 issued on January 21, 1992. This General Certification is rescinded when the Corps of Engineers reauthorizes Nationwide 12 or when deemed appropriate by the Director of the Division of Water Quality.

ANTI -SEEP COLLAR

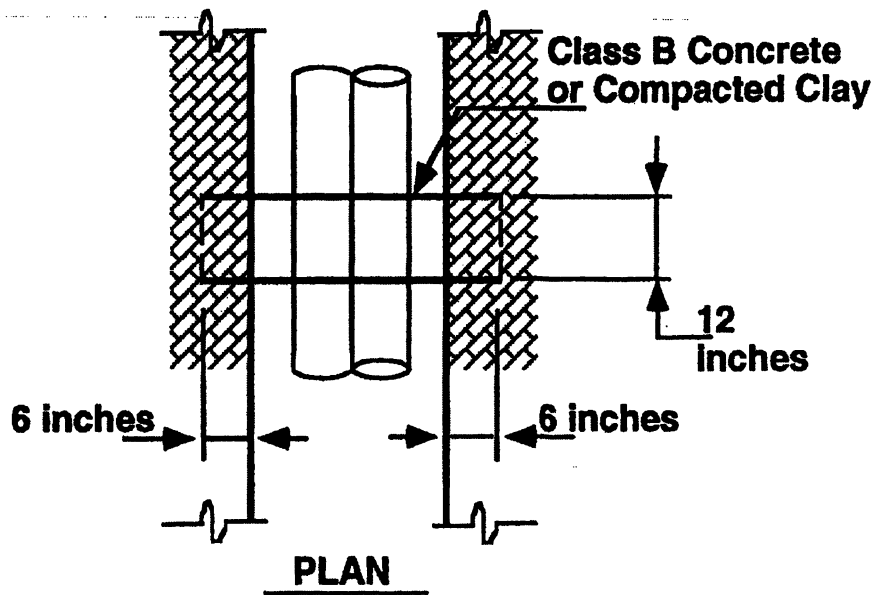
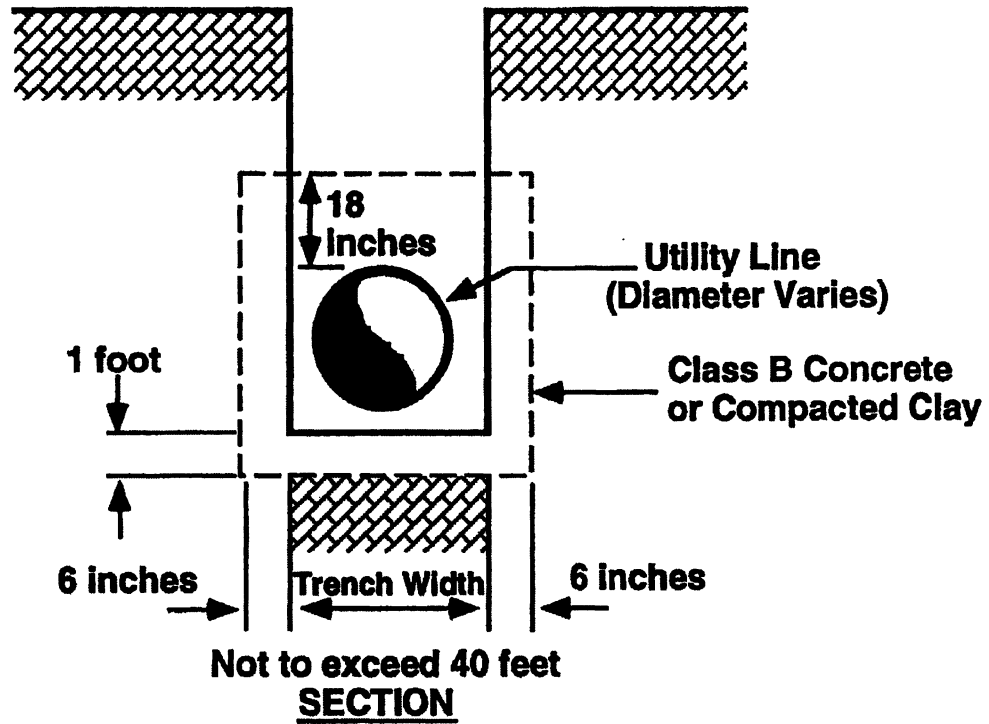

BUFFER AUTHORIZATION CERTIFICATION FOR BRIDGE REPLACEMENT PROJECTS

A riparian buffer authorization is required for bridge replacement activities within the Neuse and Tar-Pamlico River basins per Division of Water Quality (DWQ) regulations 15A NCAC 02B.0233 & .0259. The Division of Coastal Management (DCM) through a Memorandum of Understanding with the Division of Water Quality (DWQ) has reviewed your project proposal, determined that the project as proposed complies with the aforementioned regulations, and made a "no practical alternatives" determination per those regulations.

Those activities covered by your Coastal Area Management Act (CAMA) permit have received Buffer authorization as long as the project is constructed in a manner that continues to meet all of the conditions listed below. Failure to comply with this Buffer Authorization shall subject the property owner & the party (contractor) performing the construction &/or land clearing to a civil penalty of up to \$25,000 per day per violation.

- 1) All stormwater runoff shall be directed as sheetflow through stream buffers at non-erosive velocities, unless otherwise approved by this certification.
- 2) All riparian buffers impacted by the placement of temporary fill or clearing activities shall be restored to the preconstruction contours and re-vegetated. Maintained buffers shall be permanently re-vegetated with non-woody species by the end of the growing season following completion of construction. For the purpose of this condition, maintained buffer areas are defined as areas within the transportation corridor that will be subject to regular NCDOT maintenance activities including mowing. The area with non-maintained buffers shall be permanently re-vegetated with native woody species before the next growing season following completion of construction.
- 3) Pursuant to NCAC15A 2B .0233 & .0259, sediment and erosion control devices shall not be placed in Zone 1 of any Neuse or Tar-Pamlico Buffer without prior approval by NCDWQ. At this time, NCDWQ has approved no sediment and erosion control devices in Zone 1, outside of the approved project impacts, anywhere on this project. Moreover, sediment and erosion control devices shall be allowed in Zone 2 of the buffers provided that Zone 1 is not compromised and that discharge is released as diffuse flow.
- 4) Bridge deck drains shall not discharge directly into the stream. Stormwater shall be directed across the bridge and pre-treated through site-appropriate means (grassed swales, pre-formed scour holes, vegetated buffers, etc.) before entering the stream. Please refer to the most current version of *Stormwater Best Management Practices*.

By your signature below you agree to be held responsible for meeting all of the above listed conditions and verify that all information is complete and accurate.

Gregory J. Thorne, PhD
Agent or Applicant Printed Name

E. J. Lusk
Agent or Applicant Signature

Stephen Davis
Permit Officer's Signature

3-22-12
Issue Date

CAMA GENERAL PERMIT #: 58381



CAMA / DREDGE & FILL
GENERAL PERMIT

New Modification Complete Reissue Partial Reissue

N^o: 0838154

Previous permit # _____
 Date previous permit issued _____

As authorized by the State of North Carolina, Department of Environment and Natural Resources and the Coastal Resources Commission in an area of environmental concern pursuant to 15A NCAC _____

07 H. 1600, 2300

Rules attached.

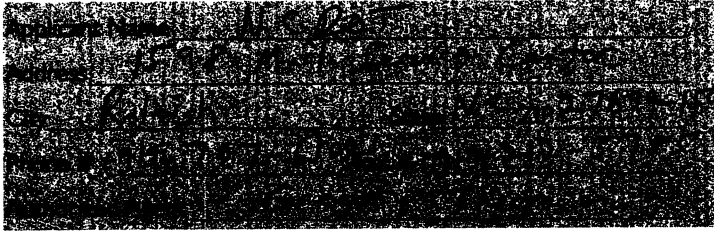

Project Location: County Beaufort
 Street Address/ State Road/ Lot # (s) Bridge # 42 (B-442)
on SR 1003, 0.42 miles east of SR 1932
 Subdivision _____
 City Aurora, NC ZIP 27608
 Phone # (____) _____ River Basin Tar-Pamlico
 Adj. Wtr. Body Durham Creek (nat/man/unkn)
 Closest Maj. Wtr. Body Pamlico River

Affected AEC(s): CW EW FTA ES FTS
 OEA HHF IH UBA N/A
 PWS: _____ FC: _____

ORW: yes / no PNA: yes / no Crit.Hab. yes / no

Type of Project/ Activity Replace the existing bridge with a 33' wide x 130' long bridge and associated infrastructure, including water, telephone, and electrical utility line relocations (Scale: N/A)

- Pier (dock) length _____
- Platform(s) _____
- Finger pier(s) _____
- Groin length _____
number _____
- Bulkhead/ Riprap length _____
avg distance offshore _____
max distance offshore _____
- Basin, channel _____
cubic yards _____
- Boat ramp _____
- Boathouse/ Boatlift _____
- Beach Bulldozing _____
- Other 33' x 130' bridge
Directionally bored 12" waterline
Directionally bored telephone lines
Aerial electrical lines

<p>New Bridge Plans and Utility Plans</p> <p>Attached and Incorporated into Permit.</p>	
---	--

- Shoreline Length 263'
- SAY: not sure yes no
- Sandbags: not sure yes no
- Moratorium: n/a yes no
- Photos: yes no
- Waiver Attached: yes no

A building permit may be required by: Beaufort County See note on back regarding River Basin rules.

Notes/ Special Conditions 1) No in-water work is allowed from February 15 to June 15 of any year without prior approval from DCM 2) Turbidity curtains and other measures shall be implemented in accordance with BMP's 3) The existing bridge shall be removed in its entirety (including any relic piling)

Agent or Applicant Printed Name: Gregory J. Thorne PhD
 Signature: E.L. Fush
 Application Fee(s): \$800 W.B.S.# 33694.1.1
 Check # _____

Permit Officer's Signature: Stephen [unclear]
 Issuing Date: 3-22-12
 Local Planning Jurisdiction: Beaufort County
 No Expiration Date pursuant to 65.136-4K.7B
 Expiration Date: 35° 17' 42" N
76° 52' 23" W
 River File Name _____

Statement of Compliance and Consistency

This permit is subject to compliance with this application, site drawing and attached general and specific conditions. Any violation of these terms may subject the permittee to a fine or criminal or civil action; and may cause the permit to become null and void.

This permit must be on the project site and accessible to the permit officer when the project is inspected for compliance. The applicant certifies by signing this permit that 1) prior to undertaking any activities authorized by this permit, the applicant will confer with appropriate local authorities to confirm that this project is consistent with the local land use plan and all local ordinances, and 2) a written statement or certified mail return receipt has been obtained from the adjacent riparian landowner(s).

The State of North Carolina and the Division of Coastal Management, in issuing this permit under the best available information and belief, certify that this project is consistent with the North Carolina Coastal Management Program.

River Basin Rules Applicable To Your Project:

- Tar - Pamlico River Basin Buffer Rules
- Neuse River Basin Buffer Rules

Other: _____

If indicated on front of permit, your project is subject to the Environmental Management Commission's Buffer Rules for the River Basin checked above due to its location within that River Basin. These buffer rules are enforced by the NC Division of Water Quality. Contact the Division of Water Quality at the Washington Regional Office (252-946-6481) or the Wilmington Regional Office (910-796-7215) for more information on how to comply with these buffer rules.

Division of Coastal Management Offices

Raleigh Office

Mailing Address:
1638 Mail Service Center
Raleigh, NC 27699-1638

Location:
2728 Capital Blvd.
Raleigh, NC 27604
919-733-2293
Fax: 919-733-1495

Morehead City Headquarters

400 Commerce Ave
Morehead City, NC 28557
252-808-2808/ 1-888-4RCOAST
Fax: 252-247-3330
(Serves: Carteret, Craven, Onslow -above
New River Inlet- and Pamlico Counties)

Elizabeth City District

1367 U.S. 17 South
Elizabeth City, NC 27909
252-264-3901
Fax: 252-264-3723
(Serves: Camden, Chowan, Currituck,
Dare, Gates, Pasquotank and Perquimans
Counties)

Washington District

943 Washington Square Mall
Washington, NC 27889
252-946-6481
Fax: 252-948-0478
(Serves: Beaufort, Bertie, Hertford, Hyde,
Tyrrell and Washington Counties)

Wilmington District

127 Cardinal Drive Ext.
Wilmington, NC 28405-3845
910-796-7215
Fax: 910-395-3964
(Serves: Brunswick, New Hanover,
Onslow -below New River Inlet- and
Pender Counties)

STATE OF NORTH CAROLINA
DIVISION OF HIGHWAYS
BEAUFORT COUNTY

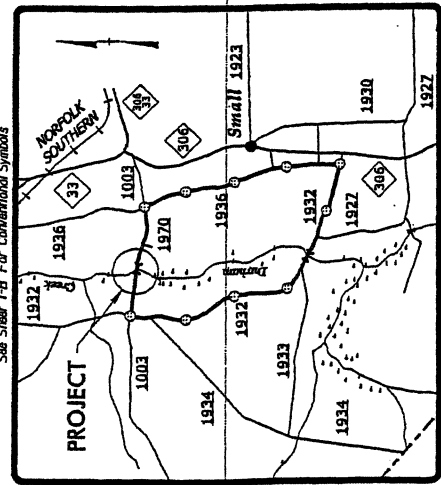

LOCATION: BRIDGE NO. 42 OVER DURHAM CREEK ON SR 1003
TYPE OF WORK: GRADING, PAVING, DRAINAGE, AND STRUCTURE

NC	B-4421	1
PROJECT NUMBER	38941.1	PROJECT NUMBER
DATE	08/17/10	DATE
DESIGNER	P.E.	DESIGNER

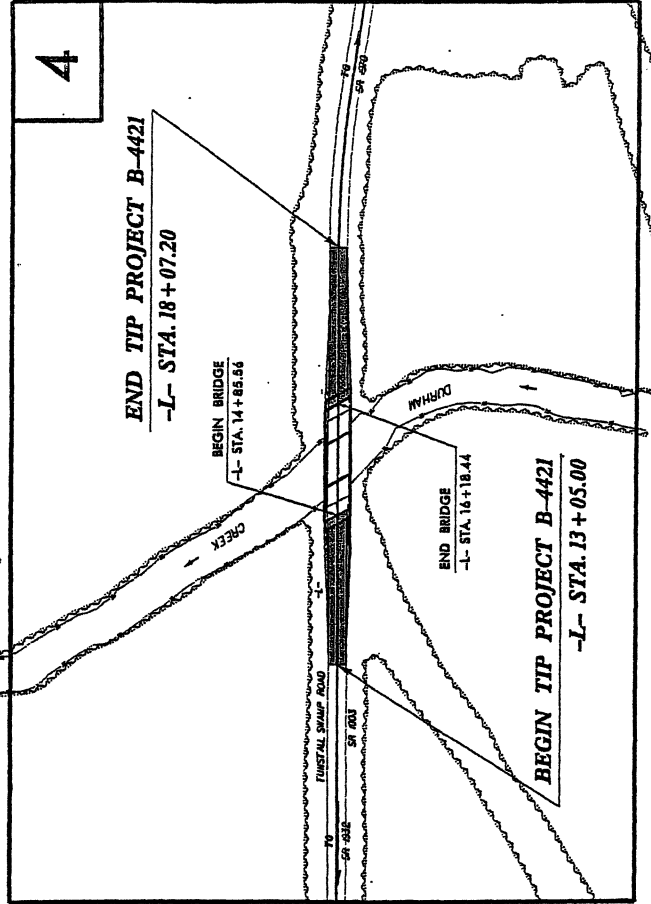
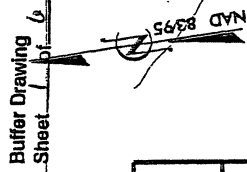

THIS PROJECT IS NOT WITHIN ANY MUNICIPAL BOUNDARIES.
CLEARING ON THIS PROJECT SHALL BE PERFORMED TO THE LIMITS ESTABLISHED BY METHOD III.

INCOMPLETE PLANS
PRELIMINARY PLANS



HYDRAULICS ENGINEER
ROADWAY DESIGN ENGINEER

Prepared in the Office of
DIVISION OF HIGHWAYS
1800 Brierley Blvd., Raleigh, NC, 27618

RIGHT OF WAY DATE:
SEPTEMBER 16, 2011

ISSUING DATE:
SEPTEMBER 18, 2012

GARY LOVERING, PE
PROJECT MANAGER

RICK DECOLA, PE
PROJECT DESIGN MANAGER

PROJECT LENGTH

LENGTH ROADWAY TIP PROJECT B-4421 = 0.070 MILES
LENGTH STRUCTURE TIP PROJECT B-4421 = 0.025 MILES
TOTAL LENGTH TIP PROJECT B-4421 = 0.095 MILES

DESIGN DATA

ADT 2012 = 1,050
ADT 2032 = 1,430
DRY = 12%
D = 80%
T = 13%
V = 60 MPH
FUNC CLASS = DUAL-6K
RURAL MAJOR COLLECTOR
SUBREGIONAL TIER

GRAPHIC SCALES

PLANS: 1" = 100'

PROFILE (HORIZONTAL): 1" = 20'

PROFILE (VERTICAL): 1" = 20'

CONTRACT: TIP PROJECT: B-4421

PROJECT REFERENCE NO. B-492	SHEET NO. 4
BY SHEET NO. HYDRAULIC ENGINEER	INSTRUMENTED ENGINEER
INCONSISTENT PLANS TO BE ACCURATE PRELIMINARY PLANS NO PART FOR CONSTRUCTION	

Buffer Drawing
Sheet 2 of 2

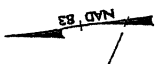

1- CURVE DATA
 P = 50.0
 Δ = 92° 37' 2" (RT)
 D = 207.365
 T = 111.1
 R = 1350.007

2- CURVE DATA
 P = 50.0
 Δ = 92° 37' 2" (RT)
 D = 207.365
 T = 111.1
 R = 1350.007

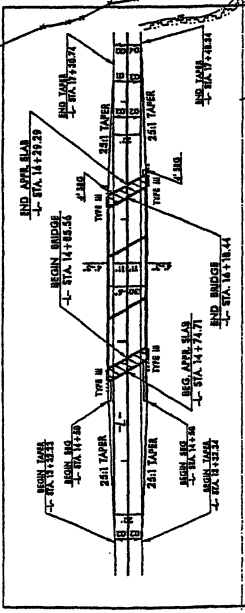
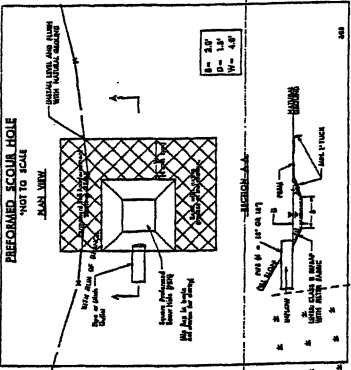

RELATIONSHIP OF BRIDGE TO PROPOSED PAVEMENT

B/17/99

REVISIONS

FOR -4- PROFILE, SEE SHEET 5
 FOR BRIDGE APPROACH SLAB
 FOR STRUCTURE PLANS, SEE SHEETS 3-1 THRU 3-11

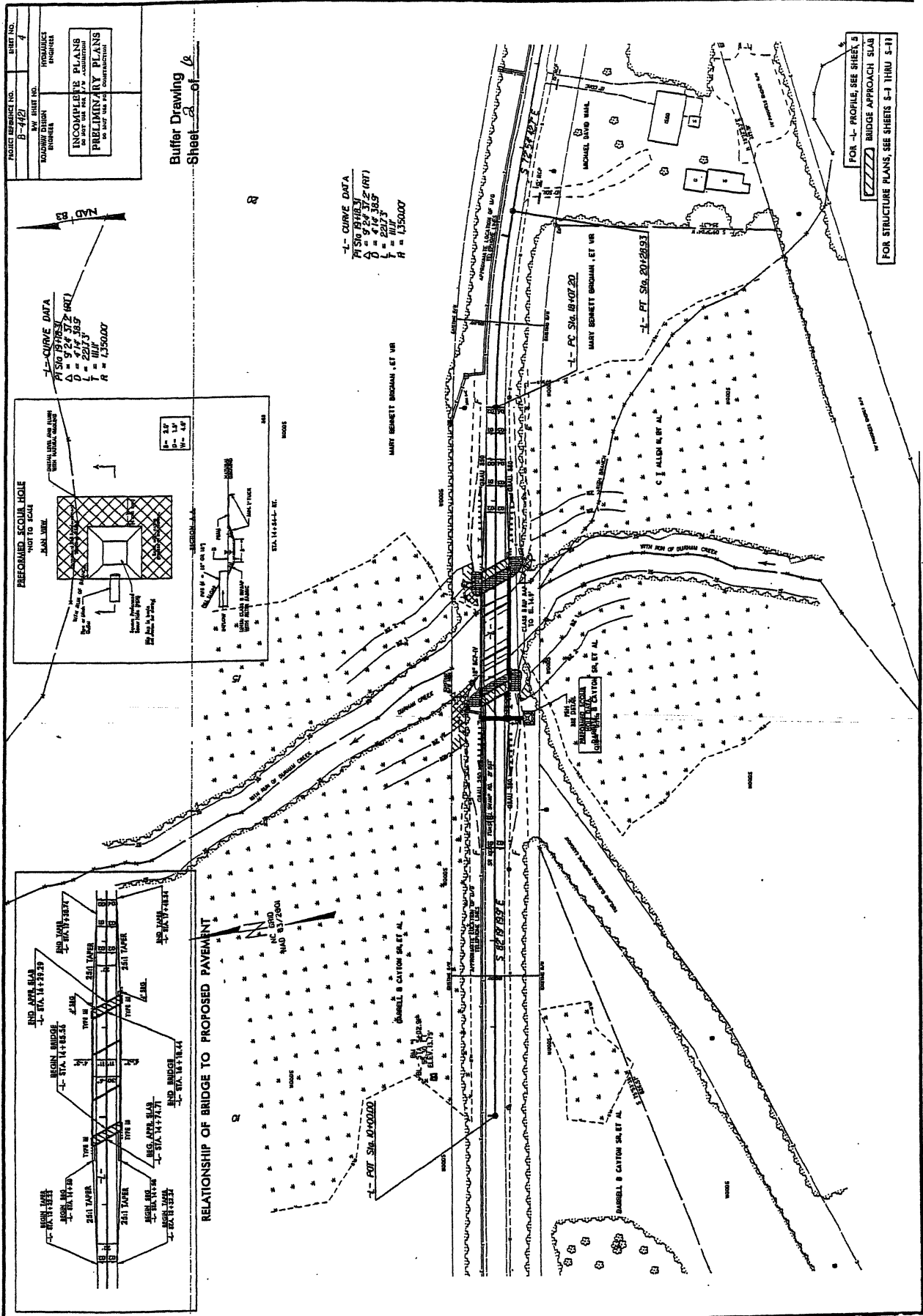

12/16/11

RAW SHEET NO.	PROJ. NO.
RAILWAY DESIGN	ROADWAY DESIGN
INCOMPLETE PLANS PRELIMINARY BY PLANS AS THEY ARE FOR CONSTRUCTION	

Buffer Drawing
Sheet 3 of 6

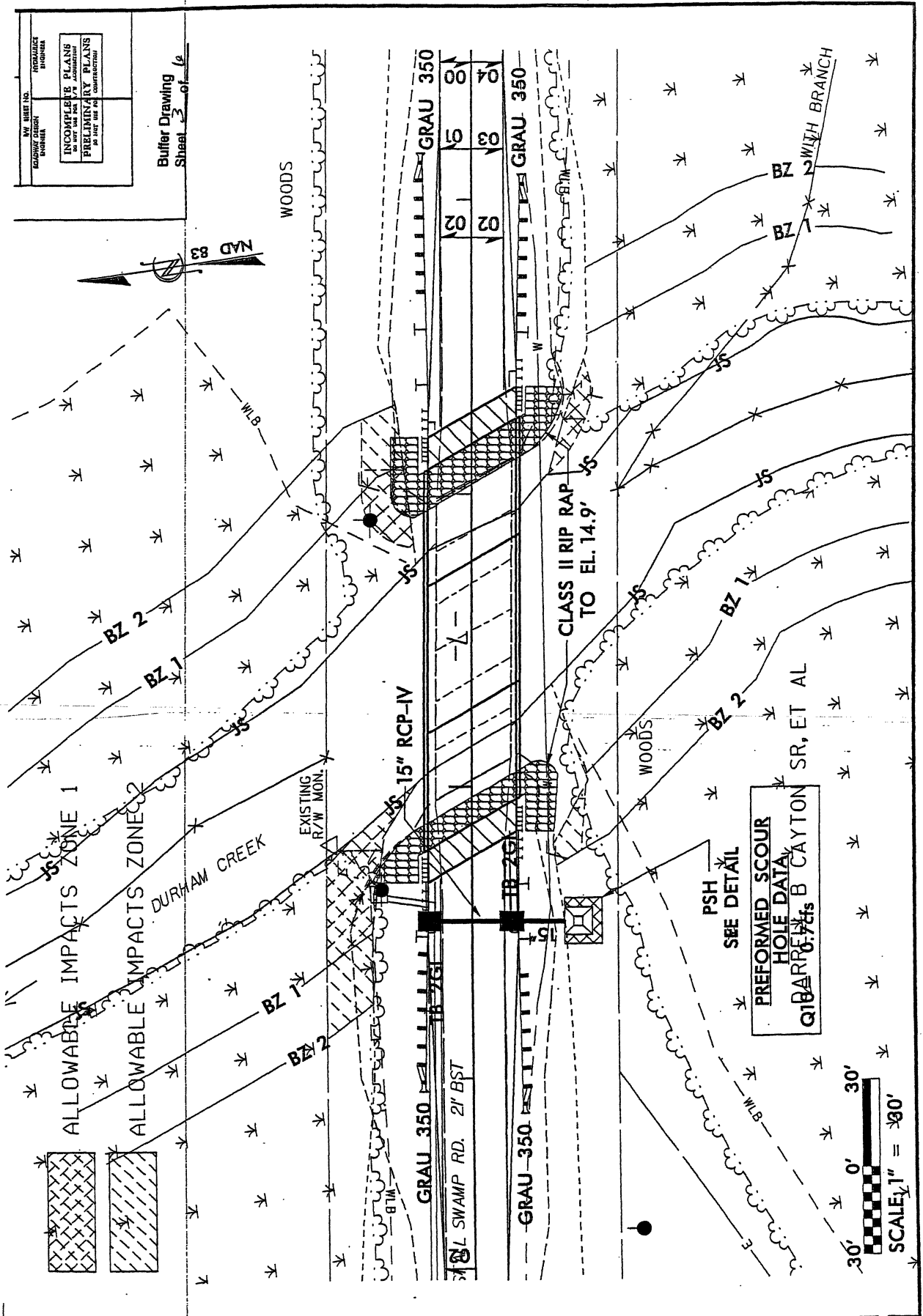

B/17/99

REVISIONS

12/16/11

PROJECT REFERENCE NO.	B-442
SHEET NO.	4
DESIGNER	PROJENCO
ENGINEER	PROJENCO
DATE	12/16/11

INCOMPLETE PLANS
OR NOT FOR THE
PRELIMINARY PLANS
FOR THE USE OF THE
CONTRACTOR

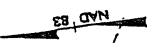

1- CURVE DATA
P/SIG 0.9483
Δ = 97.4385 (RT)
D = 221.3
T = 111.7
R = 1350.07

1- CURVE DATA
P/SIG 0.9483
Δ = 97.4385 (RT)
D = 221.3
T = 111.7
R = 1350.07

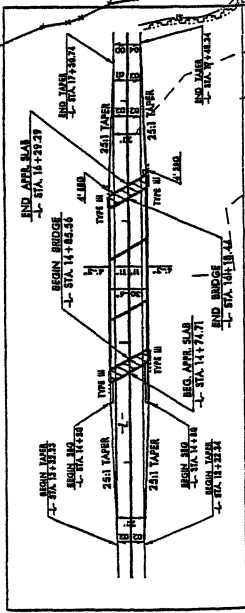
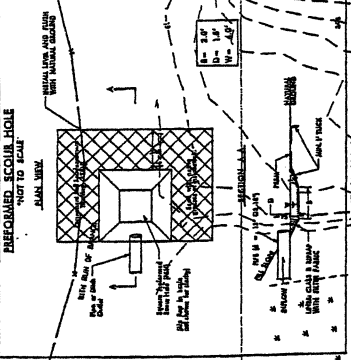

RELATIONSHIP OF BRIDGE TO PROPOSED PAVEMENT

Buffer Drawing
Sheet of 16

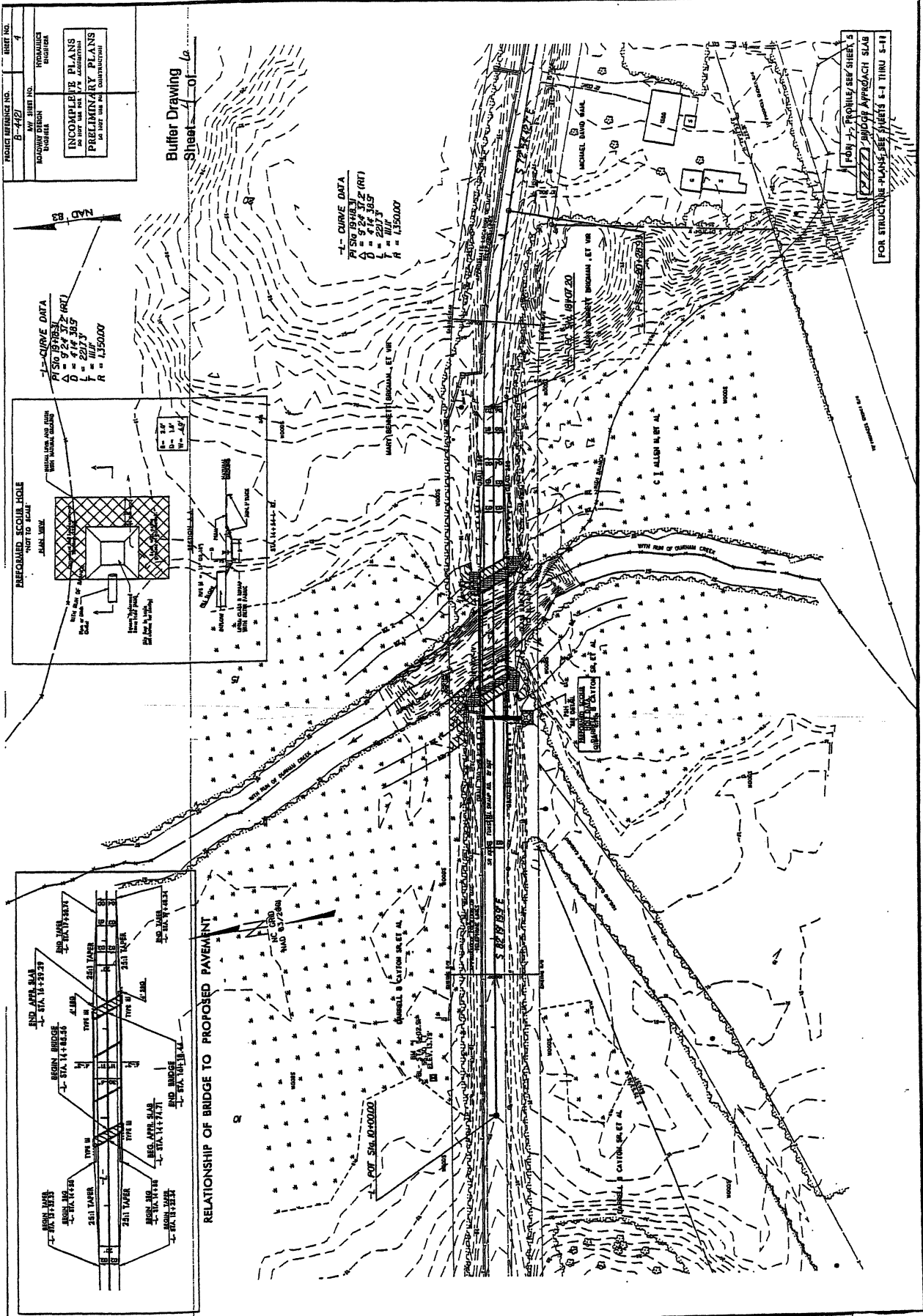

FOR STRUCTURE PLANS SEE SHEETS 4-1 THRU 4-11

BUFFER IMPACTS SUMMARY

SITE NO.	STRUCTURE SIZE / TYPE	STATION (FROM/TO)	IMPACT					MITIGABLE			BUFFER REPLACEMENT								
			TYPE		ALLOWABLE		TOTAL (ft²)	ZONE 1 (ft²)	ZONE 2 (ft²)	TOTAL (ft²)	ZONE 1 (ft²)	ZONE 2 (ft²)							
			ROAD CROSSING	BRIDGE	PARALLEL IMPACT	ZONE 1 (ft²)							ZONE 2 (ft²)						
	1@40', 1@50', 1@40' 21" ORED SLAB	14+13-L- LT. TO 16+31-L- LT.		X			468.7	34.4	503.1										
			X				589.2	655.1	1244.3										
		14+72-L- RT. TO 16+47-L- RT.		X			98.9	0.0	98.9										
			X				109.9	142.2	252.1										
TOTAL:							1267	832	2098	0.0	0.0	0.0	0.0						

N.C. DEPT. OF TRANSPORTATION
 DIVISION OF HIGHWAYS
 BEAUFORT COUNTY
 PROJECT: 33694.1.1 (B-4421)

8/24/2011
 SHEET OF
 Buffer Drawing

WETLANDS IN BUFFER IMPACTS SUMMARY

SITE NO.	STATION (FROM/TO)	WETLANDS IN BUFFERS	
		ZONE 1 (ft ²)	ZONE 2 (ft ²)
1	13+37-L- LT. TO 14+95-L- LT.	100.2	178.8
		448.7	239.6
1	16+07-L- RT. TO 17+27-L- RT.	39.2	0.0
		165.5	392.0
TOTAL:		653	810

N.C. DEPT. OF TRANSPORTATION
 DIVISION OF HIGHWAYS
 BEAUFORT COUNTY
 PROJECT: 33884.1.1 (B-4421)

8/24/2011 SHEET OF
 Rev. Jan 2009

Buffer Drawing
 Sheet 6 of 6

See Sheet 1-A For Index of Sheets
See Sheet 1-B For Conventional Symbols

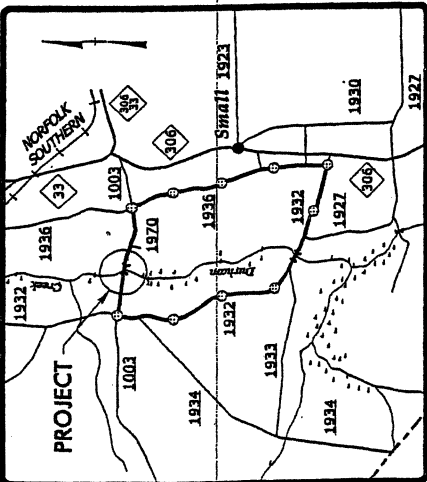

VICINITY MAP

DETOUR ROUTE ○—○—○

STATE OF NORTH CAROLINA
DIVISION OF HIGHWAYS
BEAUFORT COUNTY

LOCATION: BRIDGE NO. 42 OVER DURHAM CREEK ON SR 1003
TYPE OF WORK: GRADING, PAVING, DRAINAGE, AND STRUCTURE

STATE	N.C.
FED. PROJECT NUMBER	B-4421
STATE PROJECT NUMBER	BSR-1003(1)
PROJECT NUMBER	3349(1.1)
DATE	P.E.
DESIGNER	
CHECKER	
INCHES	1
SCALE	

Permit Drawing
Sheet 7

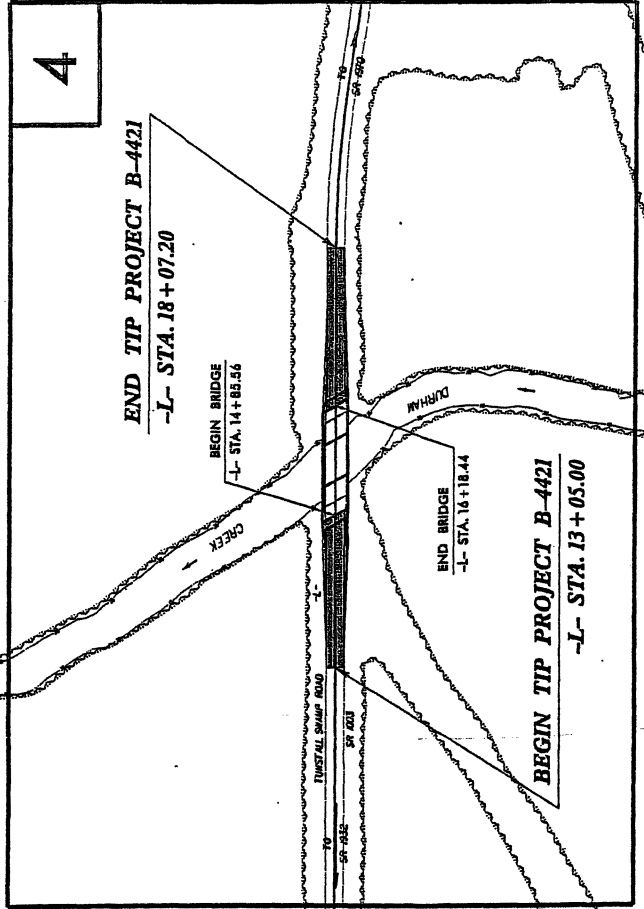

INCOMPLETE PLANS
DO NOT USE FOR P.A. ADJUSTMENT
PRELIMINARY PLANS
DO NOT USE FOR CONSTRUCTION

DIVISION OF HIGHWAYS
STATE OF NORTH CAROLINA

STATE HIGHWAY DESIGN ENGINEER P.E.

HYDRAULICS ENGINEER

ROADWAY DESIGN ENGINEER

Prepared in the Office of:
DIVISION OF HIGHWAYS
1009 Brick Ridge Dr., Raleigh, NC, 27610

RIGHT OF WAY DATE: SEPTEMBER 16, 2011

LETTING DATE: SEPTEMBER 18, 2012

PROJECT LENGTH

LENGTH ROADWAY TIP PROJECT B-4421 = 0.070 MILES

LENGTH STRUCTURE TIP PROJECT B-4421 = 0.025 MILES

TOTAL LENGTH TIP PROJECT B-4421 = 0.095 MILES

DESIGN DATA

ADT 2012 = 1,050

ADT 2032 = 1,530

DHV = 12%

D = 80%

T = 134'

V = 60 MPH

*TTST = 7% DUAL = 6%

RURAL MAJOR COLLECTOR

SUBREGIONAL TIER

GRAPHIC SCALES

PLANS
50 25 0 50 100

PROFILE (HORIZONTAL)
50 25 0 50 100

PROFILE (VERTICAL)
10 5 0 10 20

THIS PROJECT IS NOT WITHIN ANY MUNICIPAL BOUNDARIES.
CLEARING ON THIS PROJECT SHALL BE PERFORMED TO THE LIMITS ESTABLISHED BY METHOD III.

TIP PROJECT: B-4421

CONTRACT:

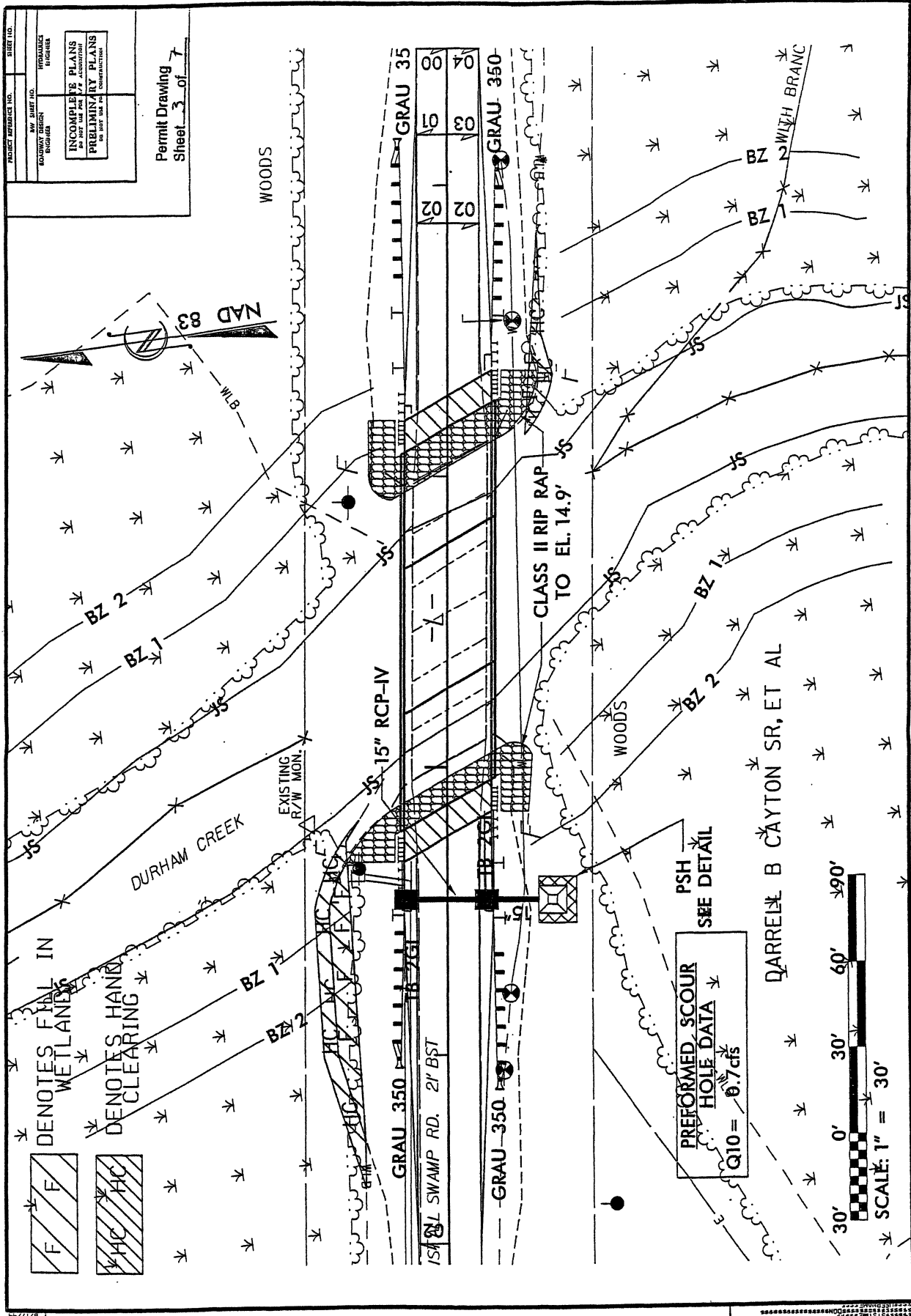

PROJECT REFERENCE NO. _____ SHEET NO. _____

REV. SHEET NO. _____

DATE: _____

DESIGNED BY: _____

CHECKED BY: _____

INCOMPLETE PLANS
DO NOT USE FOR PERMITS

PRELIMINARY PLANS
DO NOT USE FOR CONSTRUCTION

1/23/2012
 m Kelly
 R:\Hydraulics\PERMITS_Environment\Drawings\Wetlands\B421\Hyd.prm_wet_impact_sblowp.dgn
 REVISIONS
 8/17/04

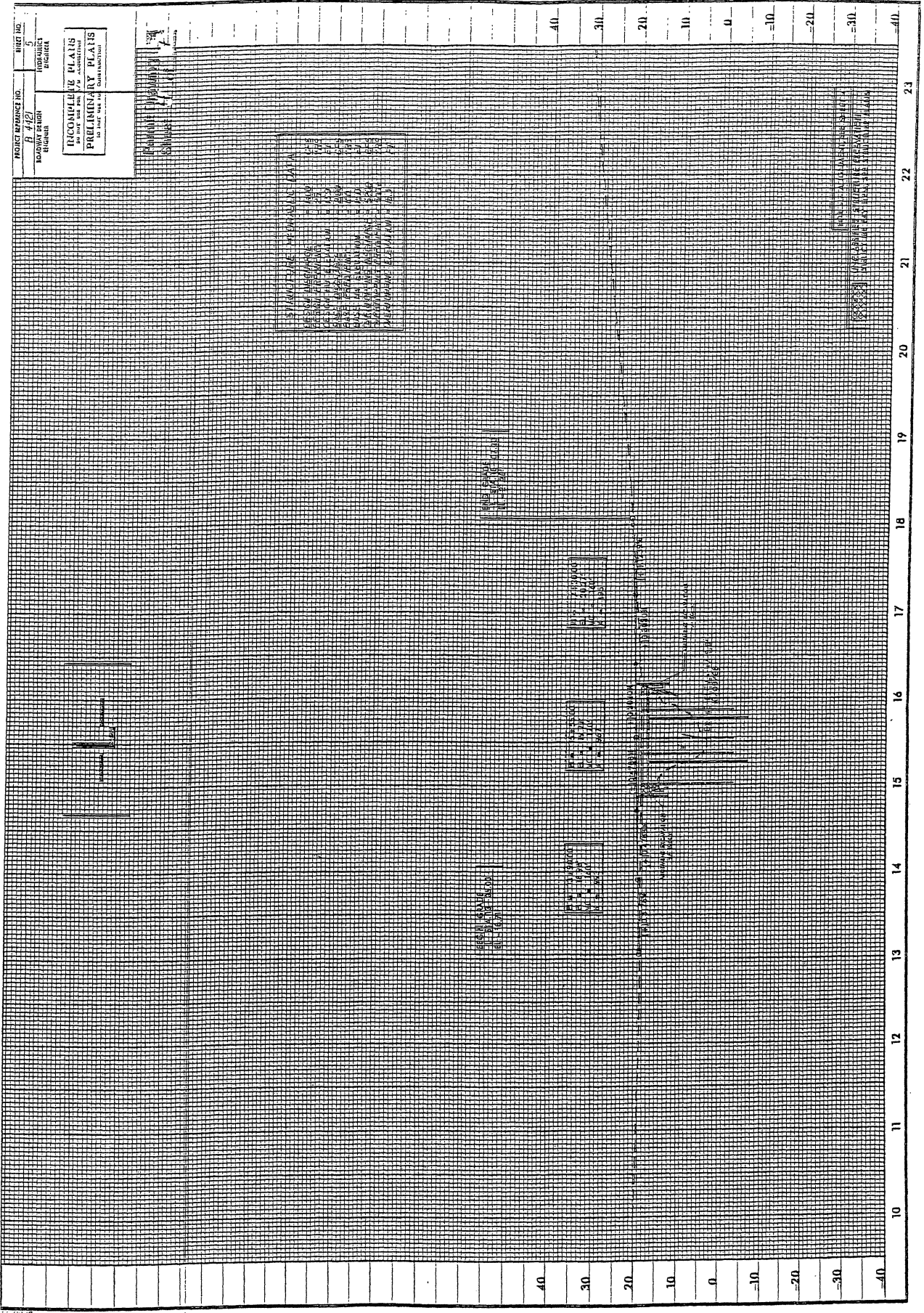

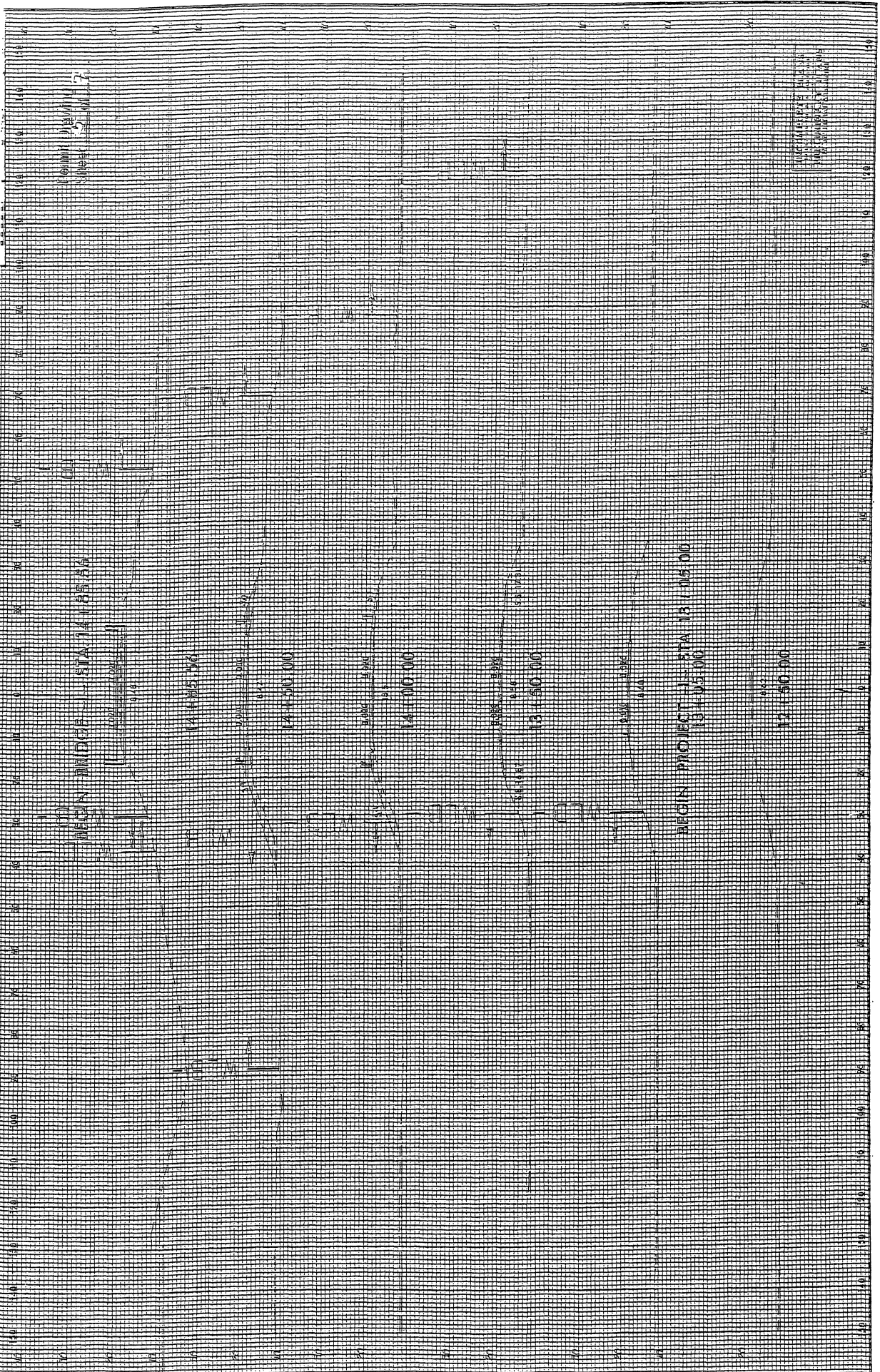

PROJECT 13+50.00

BEGIN PROJECT 13+50.00

BEGIN PROJECT 13+50.00

13+05.00

14+00.00

15+05.00

15+50.00

PROJECT 13+50.00

WETLAND PERMIT IMPACT SUMMARY																		
Site No.	Station (From/To)	Structure Size / Type	WETLAND IMPACTS				SURFACE WATER IMPACTS											
			Permanent Fill In Wetlands (ac)	Temp. Fill In Wetlands (ac)	Excavation in Wetlands (ec)	Mechanized Clearing in Wetlands (ec)	Hand Clearing in Wetlands (ac)	Permanent SW Impacts (ac)	Temp. SW Impacts (ac)	Existing Channel Impacts Permanent (ft)	Existing Channel Impacts Temp. (ft)	Natural Stream Design (ft)						
1	13+54-L- LT. TO 14+81-L- LT.		0.01					0.01										
1	16+14-L- RT. TO 16+85-L- RT.		<0.01					0.01										
TOTALS:			0.01					0.02										

AREA OF IMPACT IN SURFACE WATERS DUE TO PROPOSED PIERS= 24.9 sq.ft.

<0.01 acres of Temporary Fill in the Hand Clearing areas for erosion control measures.

NC DEPARTMENT OF TRANSPORTATION
DIVISION OF HIGHWAYS

BEAUFORT COUNTY
WBS - 33694.1.1 (B-4421)

SHEET 1/24/2012

Permit Drawing
Sheet 6 of 7

PROPERTY OWNERS

NAMES AND ADDRESSES

PARCEL NO.	NAMES	ADDRESSES
	Robert Cayton	2331 Tunstall Swamp Rd. Aurora, N.C. 27806
	C.T. Allen	372 Spring Branch Rd. Aurora, N.C. 27806
	Mary Bennett Brigman	106 Henry Street Hamlet, N.C. 28345
	Michael Wahl	951 Tunstall Swamp Rd. Aurora, N.C. 27806

NCDOT
DIVISION OF HIGHWAYS
BEAUFORT COUNTY
PROJECT: 33694.11 CR-442D
REPLACEMENT OF BRG. #46
ON SR 1003 (TUNSTALL SWAMP RD.)
OVER DURHAM CREEK

SHEET OF - 08 / 11
Permit Drawing
Sheet 7 of 7

STATE OF NORTH CAROLINA
DIVISION OF HIGHWAYS

**NEU PERMIT DRAWING PLANS
BEAUFORT COUNTY**

LOCATION: BRIDGE NO. 42 OVER DURHAM CREEK ON SR 1003
TYPE OF WORK: GRADING, PAVING, DRAINAGE, AND STRUCTURE

STATE	N.C.
PROJECT NO.	B-4421
DATE	1
DESIGNER	83494.11
CHECKER	83494.11
DATE	8/16/11
PROJECT	83494.11
DESCRIPTION	R/W & UTILITY

Utility Permit Drawing
Sheet 1 of 4
MB 8395

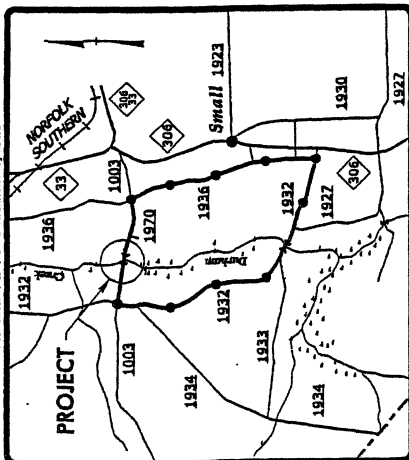

VICINITY MAP

DETOUR ROUTE

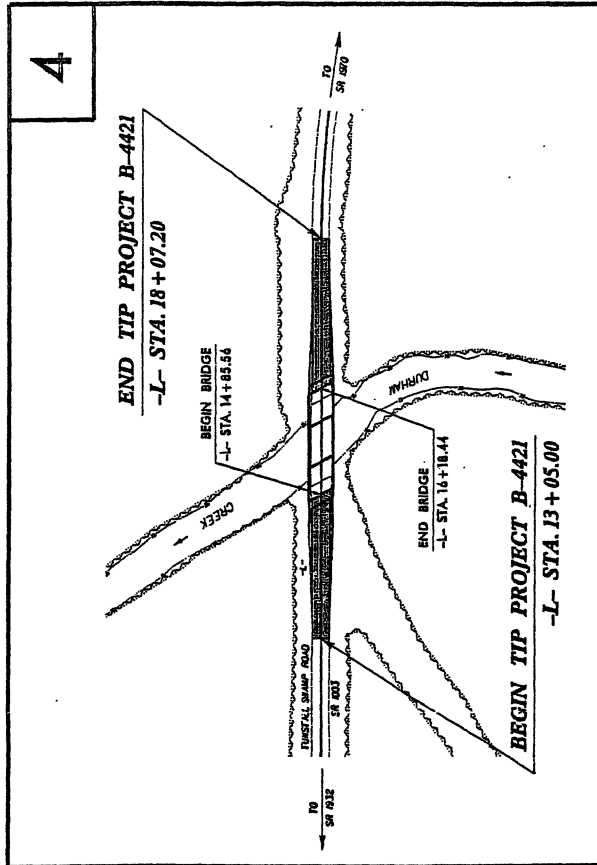

THIS PROJECT IS NOT WITHIN ANY MUNICIPAL BOUNDARIES.
CLEARING ON THIS PROJECT SHALL BE PERFORMED TO THE LIMITS ESTABLISHED BY METHOD III.

GRAPHIC SCALES

PLANS: 1" = 25', 1" = 50', 1" = 100'

PROFILE (HORIZONTAL): 1" = 25', 1" = 50', 1" = 100'

PROFILE (VERTICAL): 1" = 20'

DESIGN DATA

ADT 2012 = 1,050
ADT 2032 = 1,530
DHW = 12%
D = 80%
T = 13%
V = 60 MPH
*TST = 7% DUAL = 6%
RURAL MAJOR COLLECTOR
SUBREGIONAL TIER

PROJECT LENGTH

LENGTH ROADWAY TIP PROJECT B-4421 = 0.070 MILES
LENGTH STRUCTURE TIP PROJECT B-4421 = 0.025 MILES
TOTAL LENGTH TIP PROJECT B-4421 = 0.095 MILES

DIVISION OF HIGHWAYS
1000 North Ridge Dr., Raleigh, NC, 27610

Prepared in the Office of:
PROJECT MANAGER: GARY LOVERING, PE
PROJECT MANAGER: RICK DECOLA, PE

RIGHT OF WAY DATE: SEPTEMBER 16, 2011
LETTING DATE: SEPTEMBER 18, 2012

DIVISION OF HIGHWAYS
STATE OF NORTH CAROLINA

HYDRAULICS ENGINEER: _____
ROADWAY DESIGN ENGINEER: _____
PROJECT NUMBER: _____



CONTRACT: TTP PROJECT: B-4421

26-AUG-2011 11:53 AM L:\P\0\4421\03-1\1\MBL.dgn

PROJECT REFERENCE NO. B-419
 SHEET NO. 1
 DATE SHEET NO. 12-18-11
 INCOMPLETE PLANS
 IN THE EVENT OF ANY DISCREPANCIES
 BETWEEN THESE PLANS AND ANY
 PREVIOUS PLANS FOR THIS PROJECT,
 THESE PLANS SHALL CONTROL.

1- CURVE DATA
 A = 1000
 B = 1000
 C = 1000
 D = 1000
 E = 1000
 F = 1000
 G = 1000
 H = 1000
 I = 1000
 J = 1000
 K = 1000
 L = 1000
 M = 1000
 N = 1000
 O = 1000
 P = 1000
 Q = 1000
 R = 1000

REVISED 12-18-11

Utility Permit Drawing Sheet 3 of 4

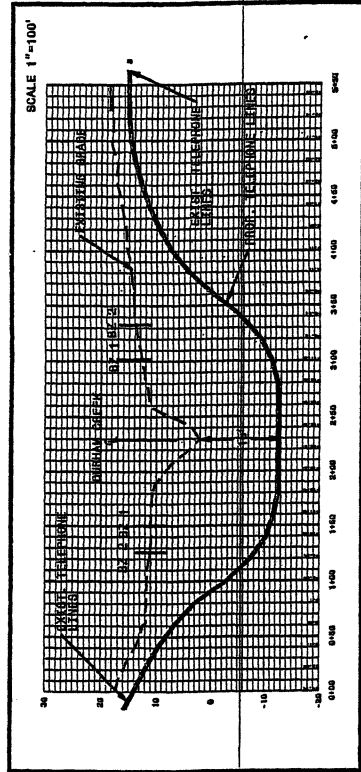

END TIP PROJECT B-421
 -L- STA. 18+07.20

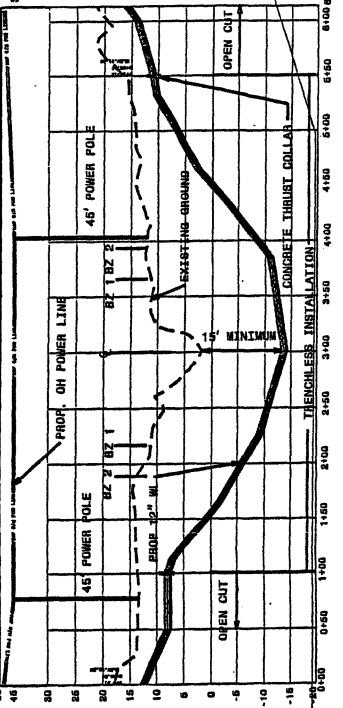
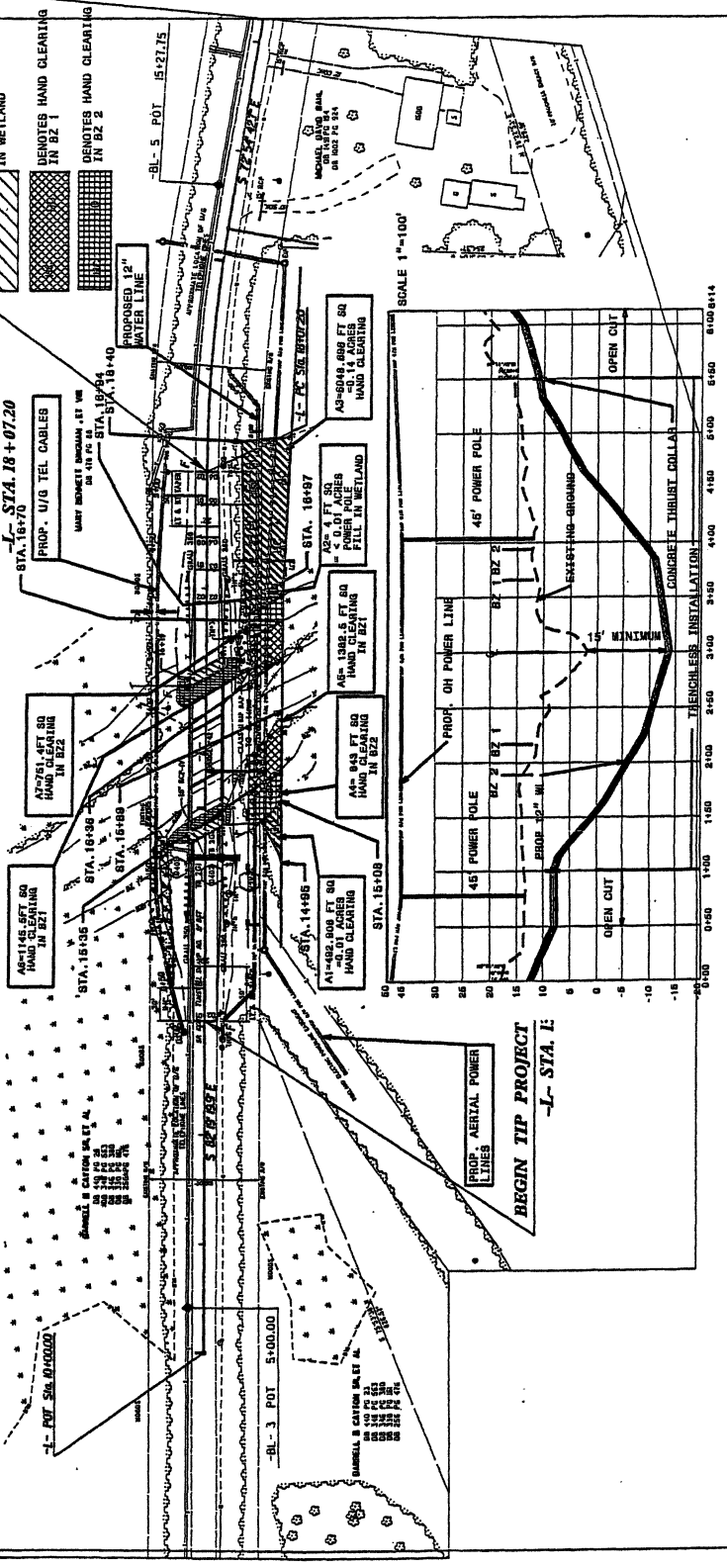

BEGIN TIP PROJECT
 -L- STA. 1

REVISIONS
 1- 12/18/11
 2- 12/18/11
 3- 12/18/11
 4- 12/18/11
 5- 12/18/11
 6- 12/18/11
 7- 12/18/11
 8- 12/18/11
 9- 12/18/11
 10- 12/18/11
 11- 12/18/11
 12- 12/18/11
 13- 12/18/11
 14- 12/18/11
 15- 12/18/11
 16- 12/18/11
 17- 12/18/11
 18- 12/18/11
 19- 12/18/11
 20- 12/18/11
 21- 12/18/11
 22- 12/18/11
 23- 12/18/11
 24- 12/18/11
 25- 12/18/11
 26- 12/18/11
 27- 12/18/11
 28- 12/18/11
 29- 12/18/11
 30- 12/18/11
 31- 12/18/11
 32- 12/18/11
 33- 12/18/11
 34- 12/18/11
 35- 12/18/11
 36- 12/18/11
 37- 12/18/11
 38- 12/18/11
 39- 12/18/11
 40- 12/18/11
 41- 12/18/11
 42- 12/18/11
 43- 12/18/11
 44- 12/18/11
 45- 12/18/11
 46- 12/18/11
 47- 12/18/11
 48- 12/18/11
 49- 12/18/11
 50- 12/18/11
 51- 12/18/11
 52- 12/18/11
 53- 12/18/11
 54- 12/18/11
 55- 12/18/11
 56- 12/18/11
 57- 12/18/11
 58- 12/18/11
 59- 12/18/11
 60- 12/18/11
 61- 12/18/11
 62- 12/18/11
 63- 12/18/11
 64- 12/18/11
 65- 12/18/11
 66- 12/18/11
 67- 12/18/11
 68- 12/18/11
 69- 12/18/11
 70- 12/18/11
 71- 12/18/11
 72- 12/18/11
 73- 12/18/11
 74- 12/18/11
 75- 12/18/11
 76- 12/18/11
 77- 12/18/11
 78- 12/18/11
 79- 12/18/11
 80- 12/18/11
 81- 12/18/11
 82- 12/18/11
 83- 12/18/11
 84- 12/18/11
 85- 12/18/11
 86- 12/18/11
 87- 12/18/11
 88- 12/18/11
 89- 12/18/11
 90- 12/18/11
 91- 12/18/11
 92- 12/18/11
 93- 12/18/11
 94- 12/18/11
 95- 12/18/11
 96- 12/18/11
 97- 12/18/11
 98- 12/18/11
 99- 12/18/11
 100- 12/18/11

WETLAND PERMIT IMPACT SUMMARY																	
Site No.	Station (From/To)	Structure Size / Type	WETLAND IMPACTS					SURFACE WATER IMPACTS									
			Permanent Fill In Wetlands (ac)	Temp. Fill In Wetlands (ac)	Excavation In Wetlands (ac)	Mechanized Clearing In Wetlands (ac)	Hand Clearing In Wetlands (ac)	Permanent SW Impacts (ac)	Temp. SW Impacts (ac)	Existing Channel Impacts Permanent (ft)	Existing Channel Impacts Temp. (ft)	Natural Stream Design (ft)					
A1	-L-14+95 TO 15+08	AERIAL POWER POLE						0.01									
A2	L- STA.16+97	POWER POLE	<0.01														
A3	L- STA.16+94 TO 18+40	AERIAL POWER POLE						0.14									
TOTALS:			<.01			0.00		0.15		0.00		0.00		0.00		0.00	0.00

NC DEPARTMENT OF TRANSPORTATION
 DIVISION OF HIGHWAYS
 Beaufort County
 TIP PROJECT (B-4421)

Rev. 12/16/2011

ATN Revised 3/31/05

Utility Permit Drawing
 Sheet 3 of 4

BUFFER IMPACTS SUMMARY

SITE NO.	STRUCTURE SIZE / TYPE	STATION (FROM/TO)	IMPACT					BUFFER REPLACEMENT				
			TYPE		ALLOWABLE		MITIGABLE		ZONE 1 (ft ²)	ZONE 2 (ft ²)		
			ROAD CROSSING	BRIDGE	PARALLEL IMPACT	ZONE 1 (ft ²)	ZONE 2 (ft ²)	TOTAL (ft ²)			ZONE 1 (ft ²)	ZONE 2 (ft ²)
A4	Power Line	15+08 to 15+35-L-				843	843					
A5	Power Line	15+35 to 15+89 -L-			1383		1383					
A6	Power Line	16+36 to 16+70 -L-			1146		1146					
A7	Power Line	16+70 to 16+94 -L-				751	751					
TOTALS:					2529		1594	4123				

N.C. DEPT. OF TRANSPORTATION
DIVISION OF HIGHWAYS

BEAUFORT COUNTY
PROJECT: B-4421
Rev.12/16/2011

Utility Permit Drawing
Sheet 4 of 4

SHEET 1 OF 1

Rev. May 2006