

INDEX OF CROSS SECTION SHEETS

-Y1- US 70	X-2 TO X-14
-Y8- PARKWAY DRIVE	X-15 TO X-18
-Y9- RELOCATED LANDMARK DRIVE	X-19 TO X-22
-Y10- BANKS SCHOOL ROAD	X-23
-Y15- US 70 TIE TO -Y1-	X-24 TO X-27

Note: "Quantities are approximate only. The Resident Engineer will re-cross-section the work accurately when the project is staked out. These cross-section notes will be used in computing the final quantities for which the contractor will be paid."

8/23/99

150 140 130 120 110 100 90 80 70 60 50 40 30 20 10 0 10 20 30 40 50 60 70 80 90 100 110 120 130 140 150

-Y/-

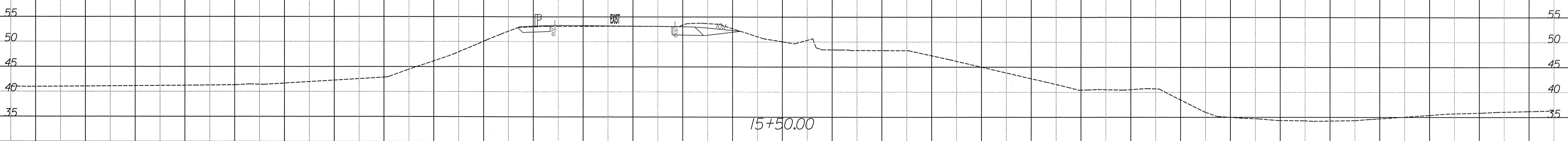
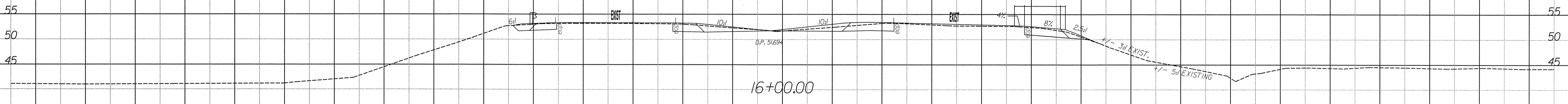
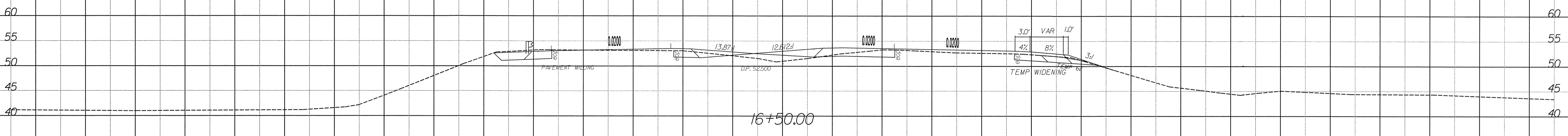
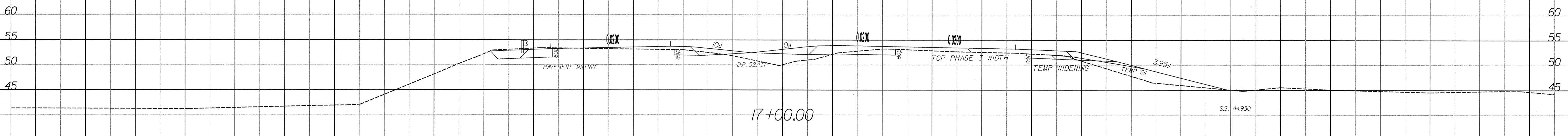

150 140 130 120 110 100 90 80 70 60 50 40 30 20 10 0 10 20 30 40 50 60 70 80 90 100 110 120 130 140 150

4/18/2012
 R:\Roadway_Xsc\V8_XPL_Paving\R2719A_RDY_XPL_Y1.dgn
 Mike.Littlefield

8/23/99

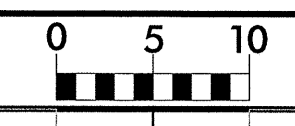

PROJ. REFERENCE NO.	SHEET NO.
R-2719AA	X-4

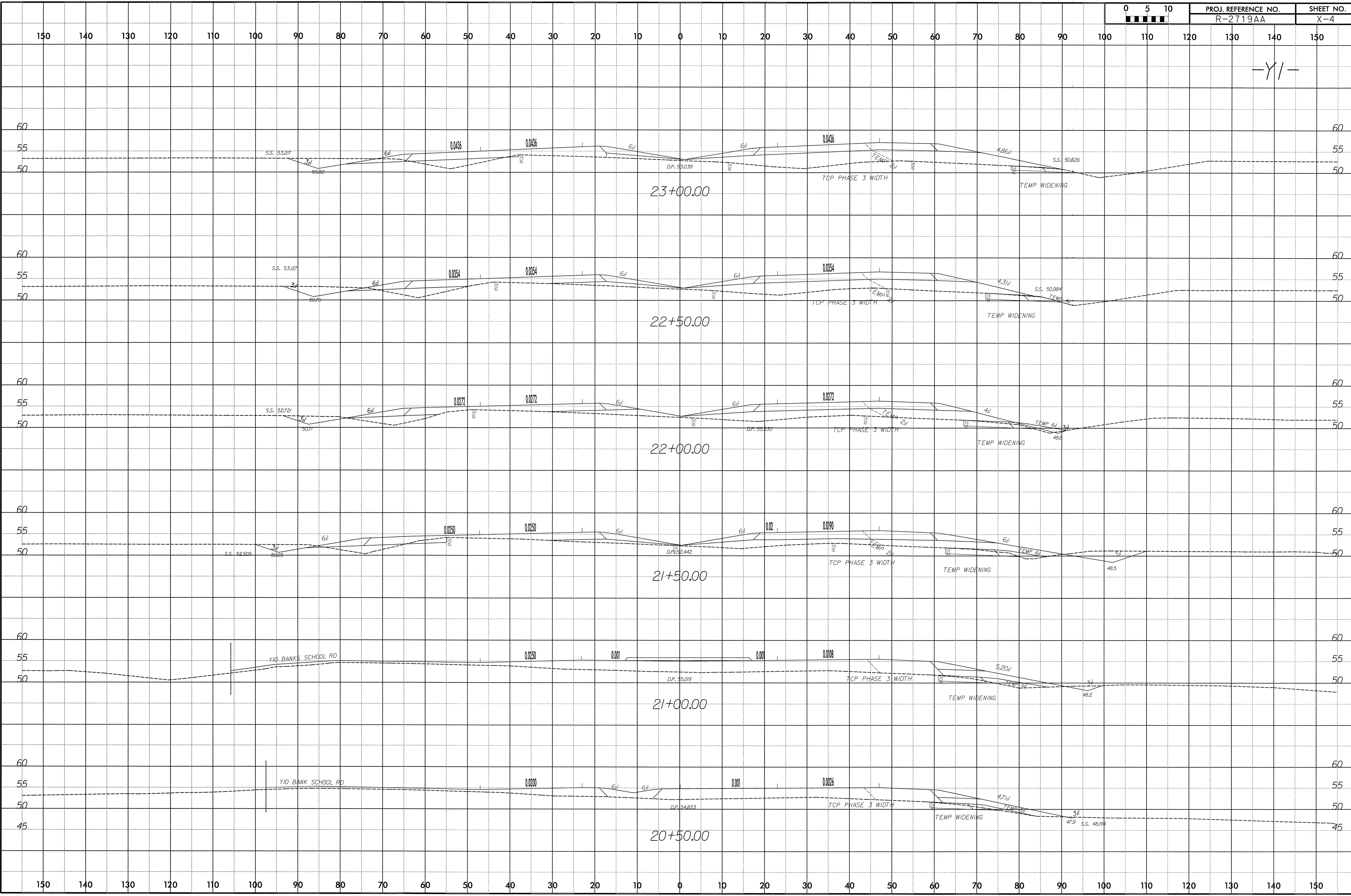

4/18/2012
 R:\Roadway\Xsc\Y10_XPL_Paving\AR2719A_RDY_XPL_Y1.dgn
 Mike Littlefield

8/23/99

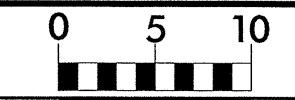

PROJ. REFERENCE NO.
R-2719AA

SHEET NO.
X-5

150 140 130 120 110 100 90 80 70 60 50 40 30 20 10 0 10 20 30 40 50 60 70 80 90 100 110 120 130 140 150

-Y/-

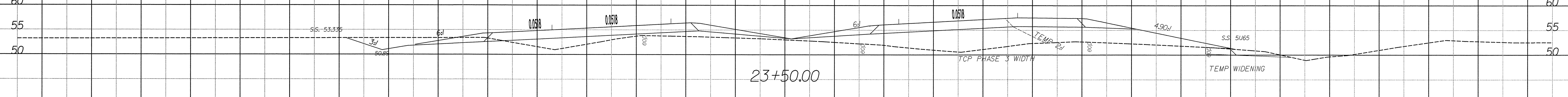
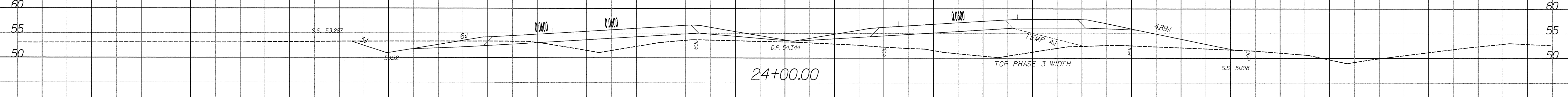
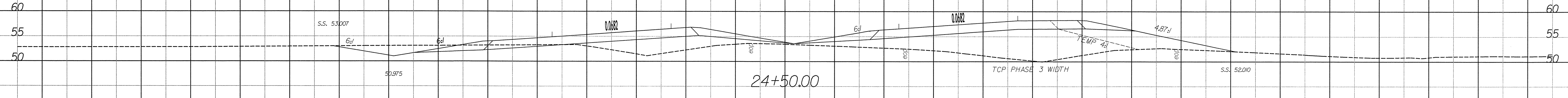
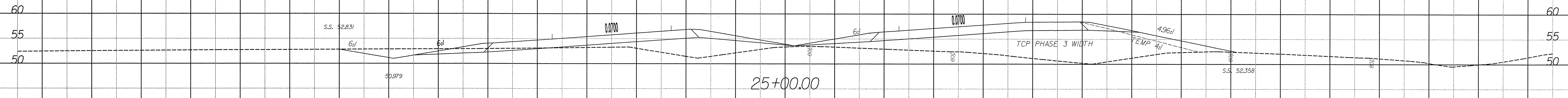
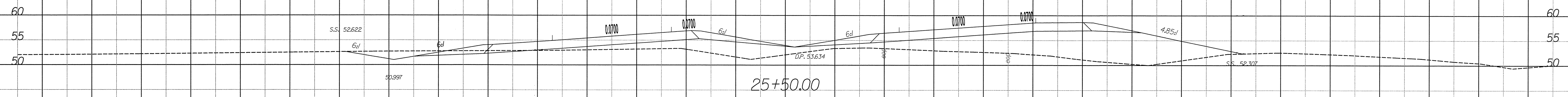
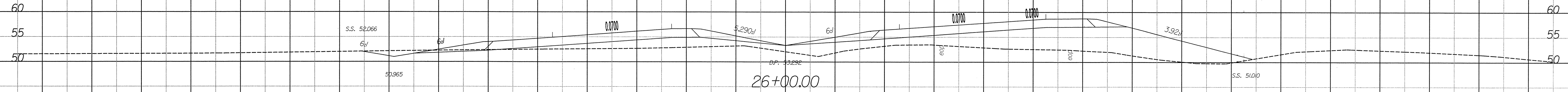

150 140 130 120 110 100 90 80 70 60 50 40 30 20 10 0 10 20 30 40 50 60 70 80 90 100 110 120 130 140 150

4/18/2012
R:\Roadway_Xsc\18_XPL_Paving\2719A_RDY_XPL_Y1.dgn
Mike Littlefield

8/23/99

150 140 130 120 110 100 90 80 70 60 50 40 30 20 10 0 10 20 30 40 50 60 70 80 90 100 110 120 130 140 150

-Y/-

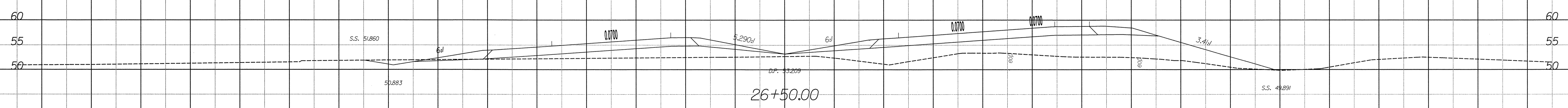
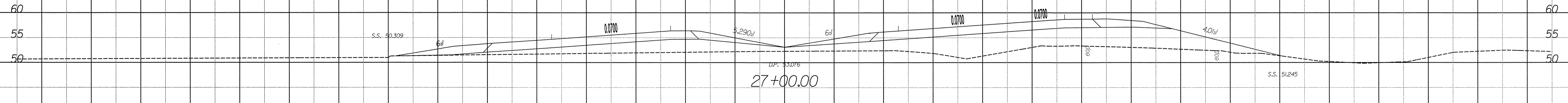
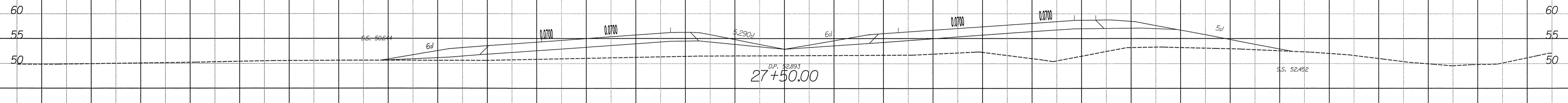
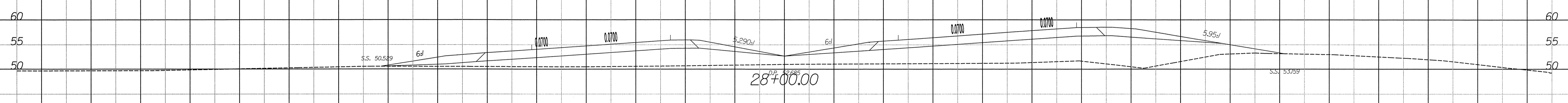
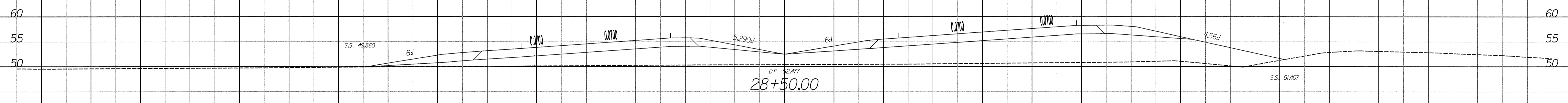
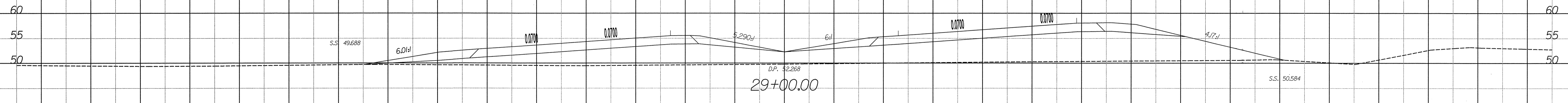

150 140 130 120 110 100 90 80 70 60 50 40 30 20 10 0 10 20 30 40 50 60 70 80 90 100 110 120 130 140 150

4/18/2012 R:\Roadway_Xsc\Y6_XPL_Paving\R2719A_RDY_XPL_Y1.dgn Mike Little field

8/22/99

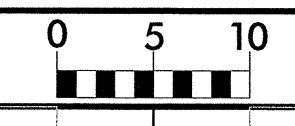

PROJ. REFERENCE NO.
R-2719AA

SHEET NO.
X-7

150 140 130 120 110 100 90 80 70 60 50 40 30 20 10 0 10 20 30 40 50 60 70 80 90 100 110 120 130 140 150

-Y/-

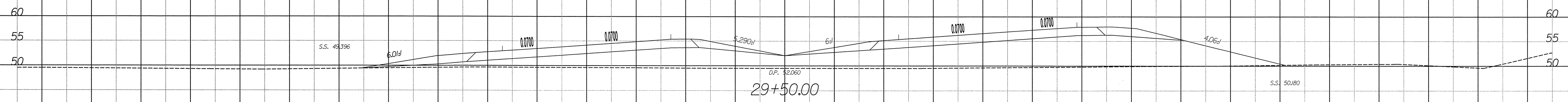

150 140 130 120 110 100 90 80 70 60 50 40 30 20 10 0 10 20 30 40 50 60 70 80 90 100 110 120 130 140 150

4/18/2012
R:\Roadway\Xsec\8_XPL_Paving\AR2719A.RD\XPL_Y1.dgn
Mike Littlefield

8/23/09

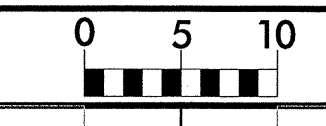

PROJ. REFERENCE NO. R-2719AA	SHEET NO. X-8
---------------------------------	------------------

150 140 130 120 110 100 90 80 70 60 50 40 30 20 10 0 10 20 30 40 50 60 70 80 90 100 110 120 130 140 150

-Y/-

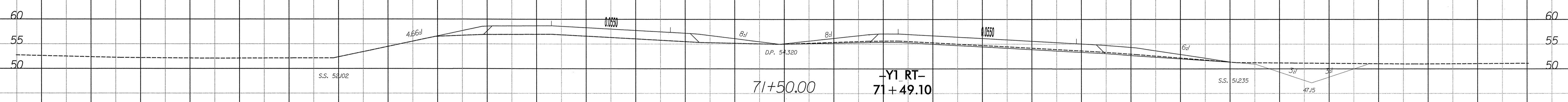
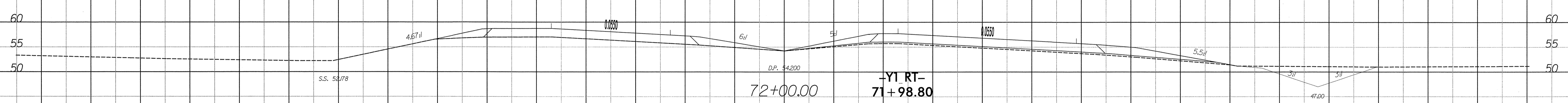
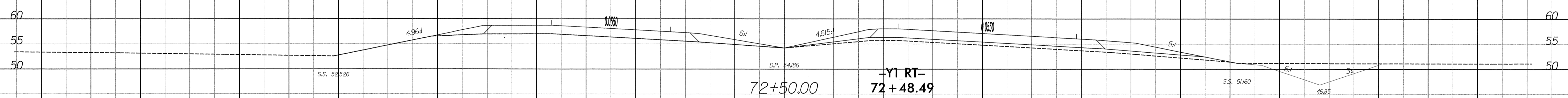
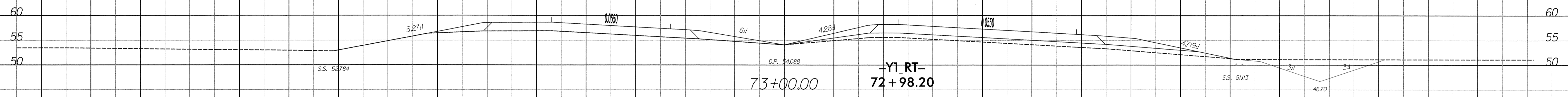
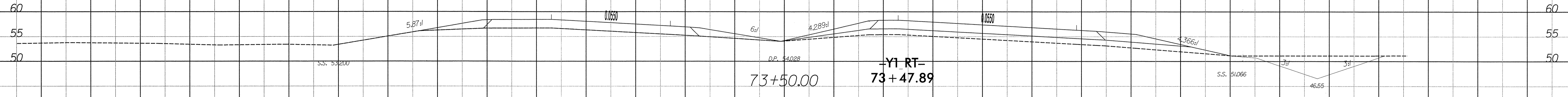

150 140 130 120 110 100 90 80 70 60 50 40 30 20 10 0 10 20 30 40 50 60 70 80 90 100 110 120 130 140 150

4/18/2012
R:\Roadway\Xsc\8-XPL_Paving\AR2719A_RDY_XPL_Y1.dgn
Mike Littlefield

8/23/99

150 140 130 120 110 100 90 80 70 60 50 40 30 20 10 0 10 20 30 40 50 60 70 80 90 100 110 120 130 140 150

-Y/-

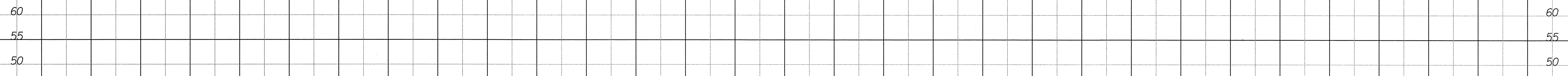

D.P. 55.73
75+50.00

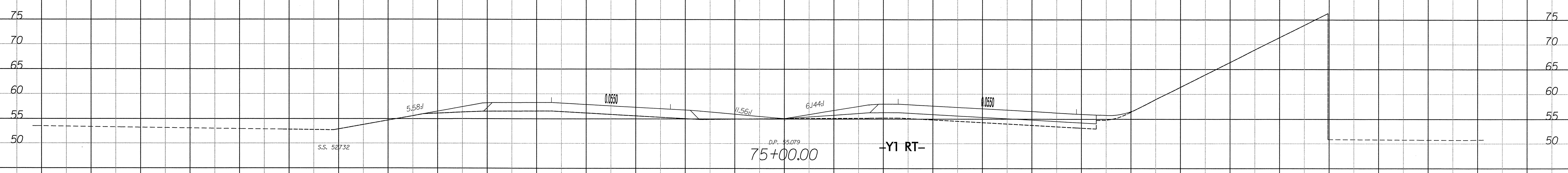

D.P. 55.079
75+00.00

-Y1 RT-

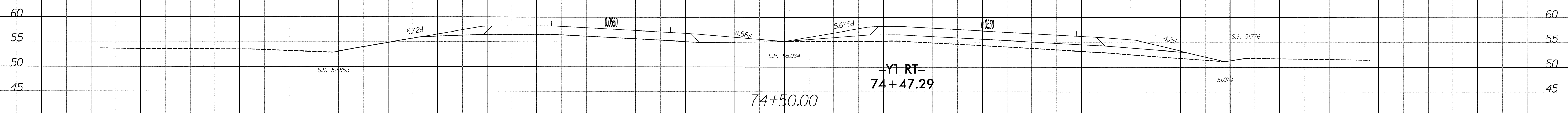

D.P. 55.064
74+50.00

-Y1 RT-
74+47.29

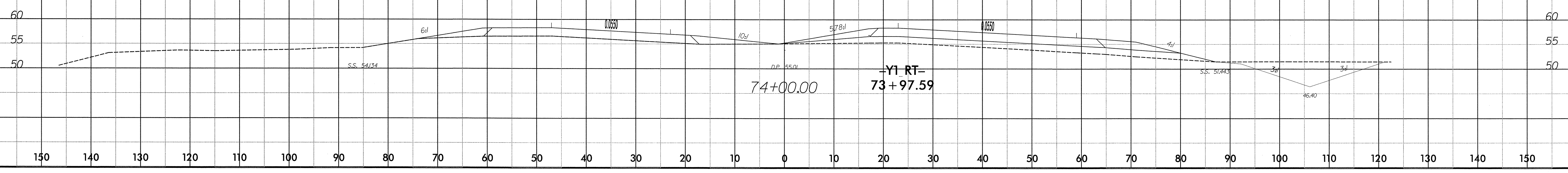

D.P. 55.01
74+00.00

-Y1 RT-
73+97.59

4/18/2012
R:\Roadway\Xso\W8_XPL_Paving\2719A\FDY_XPL_Y1.dgn
Mike.Littler

8/23/99

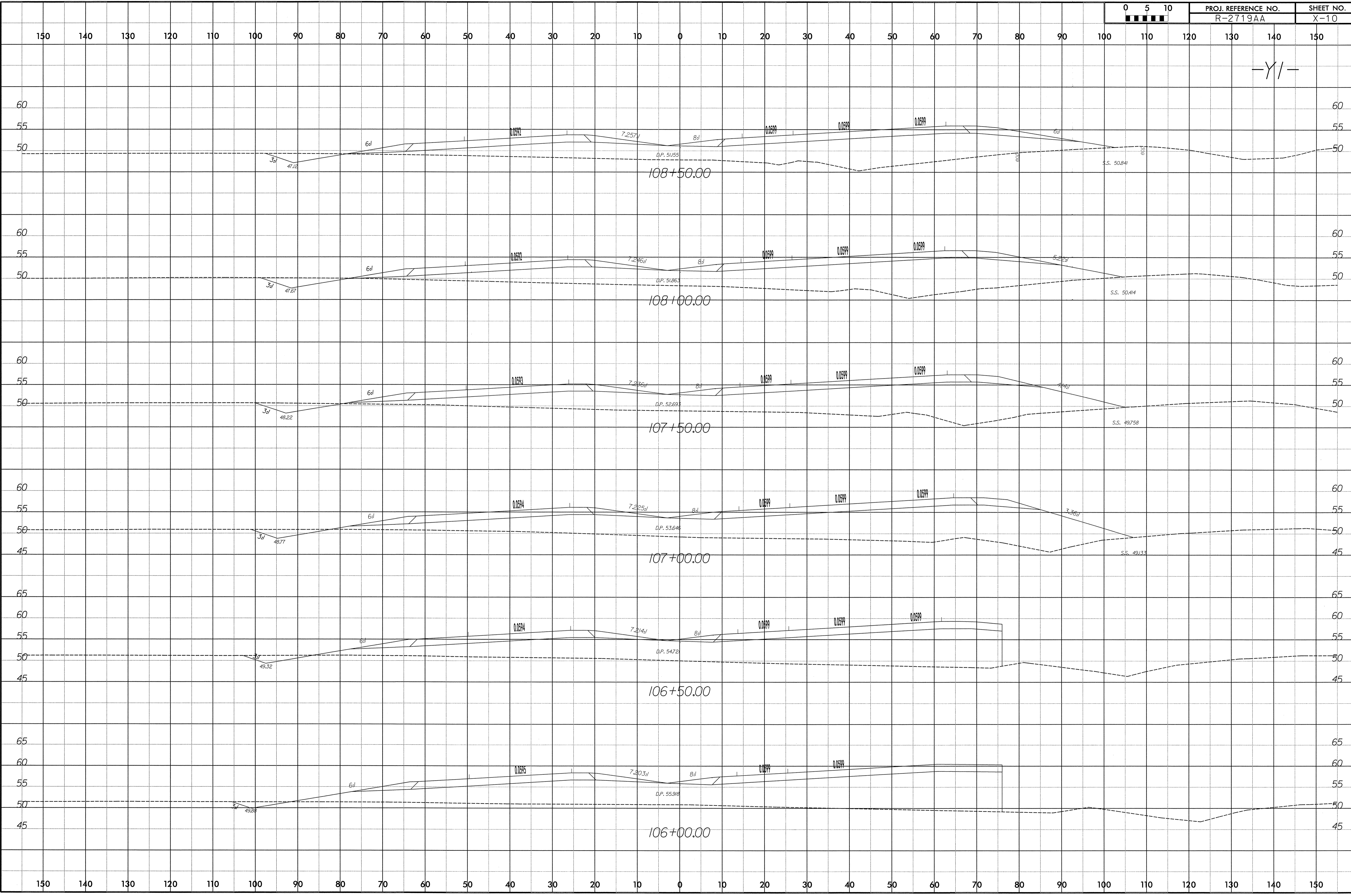

4/18/2012
R:\Roadway\Xsc\Y8_XPL_Paving\2719A_RDY_XPL_Y1.dgn
Mike.Littlefield

8/23/99

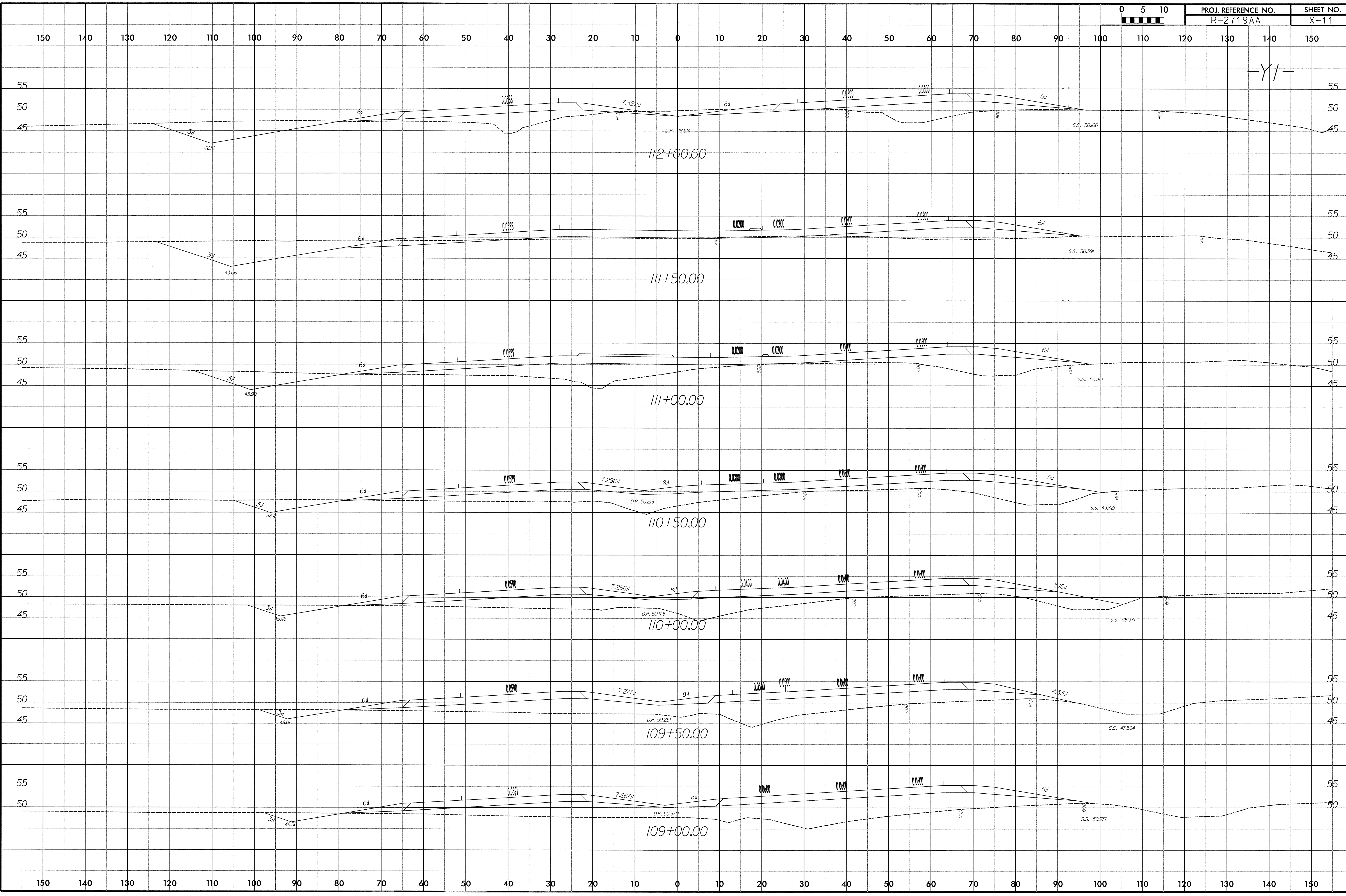

4/18/2012
P:\Roadway\Xs6\X6_XPL_Paving\R2719A-RDY_XPL_X1.dgn
Mike.Littlefield

8/23/99

150 140 130 120 110 100 90 80 70 60 50 40 30 20 10 0 10 20 30 40 50 60 70 80 90 100 110 120 130 140 150

-Y/-

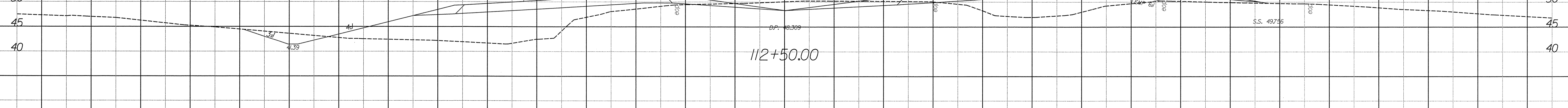
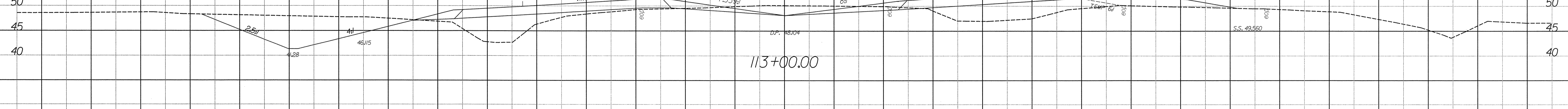
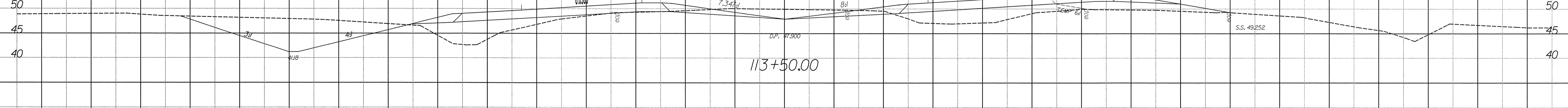
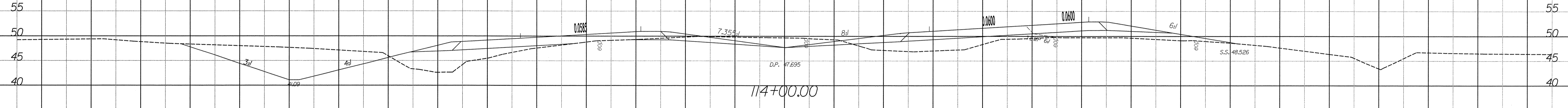
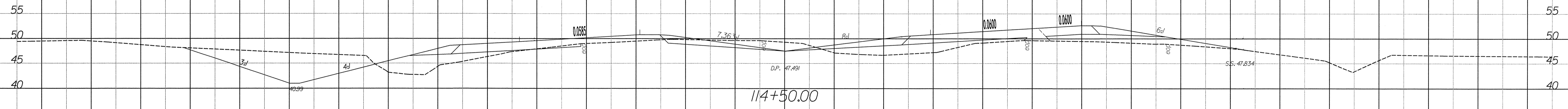
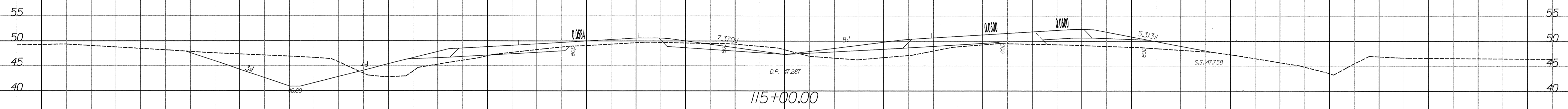

150 140 130 120 110 100 90 80 70 60 50 40 30 20 10 0 10 20 30 40 50 60 70 80 90 100 110 120 130 140 150

4/18/2012
R:\Roadway\Xsc\Y6_XPL_Paving\R2719A_RDY_XPL_Y1.dgn
Mike Littlefield

8/23/99

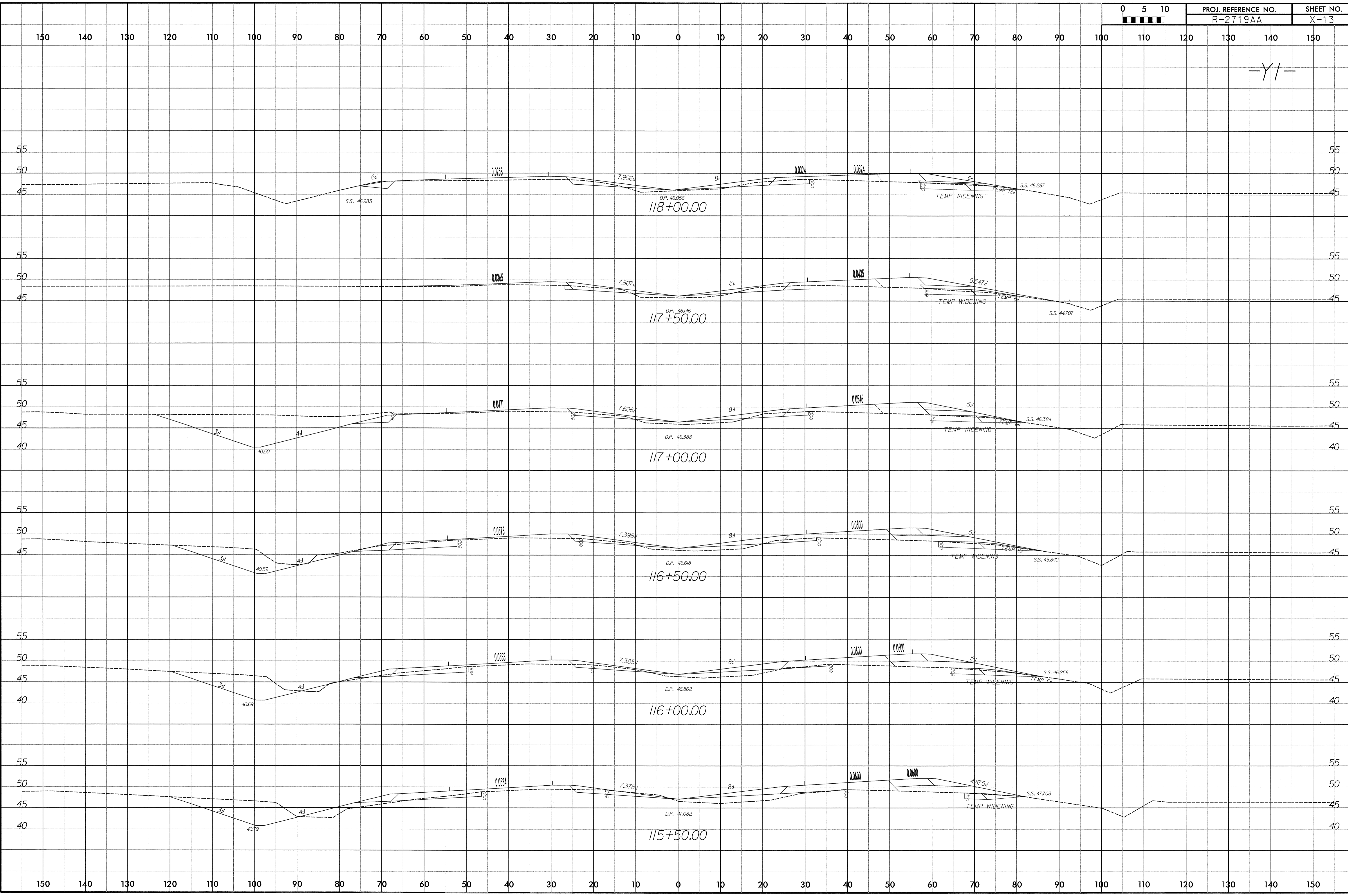

4/18/2012
R:\Roadway\Xsc\Y8_XPL_Paving\R2719A_RDY_XPL_Y1.dgn
Mike Littlefield

8/23/09

150 140 130 120 110 100 90 80 70 60 50 40 30 20 10 0 10 20 30 40 50 60 70 80 90 100 110 120 130 140 150

-Y/-

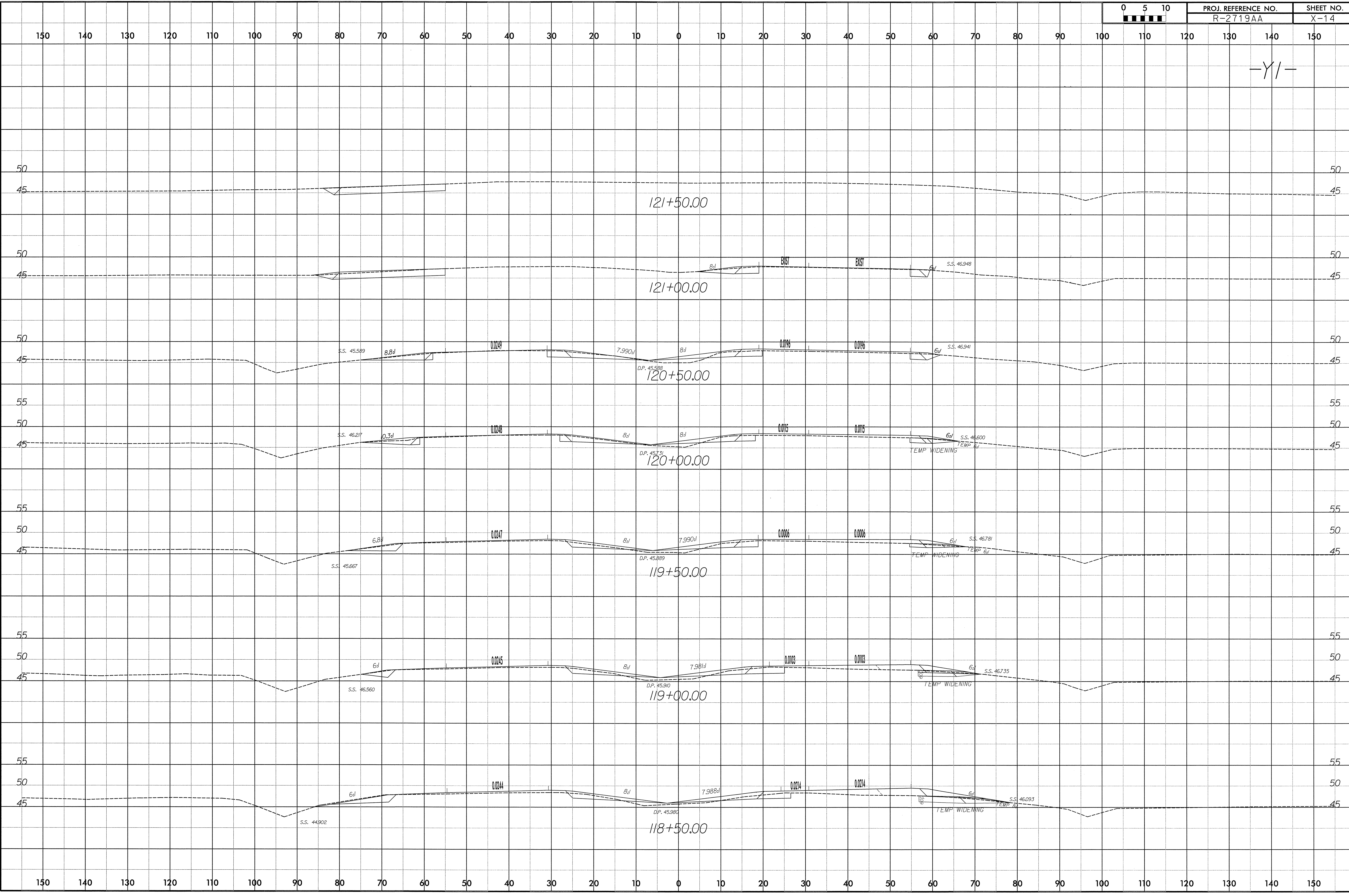

4/18/2012
 R:\Roadway\Ysc\Y8_XPL_Paving\2719A\FDY_XPL_Y1.dgn
 Mike.Littlefield

150 140 130 120 110 100 90 80 70 60 50 40 30 20 10 0 10 20 30 40 50 60 70 80 90 100 110 120 130 140 150

8/23/99

150 140 130 120 110 100 90 80 70 60 50 40 30 20 10 0 10 20 30 40 50 60 70 80 90 100 110 120 130 140 150

-Y8-

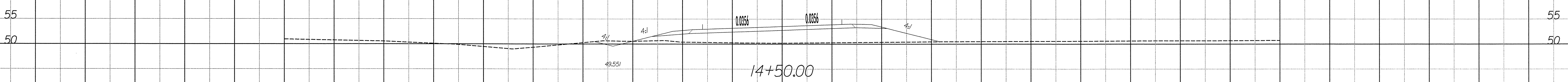
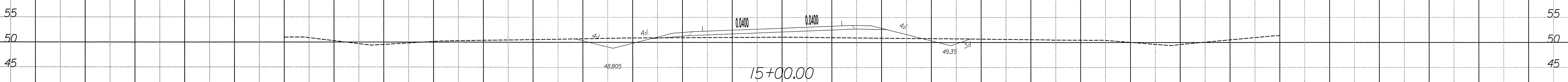
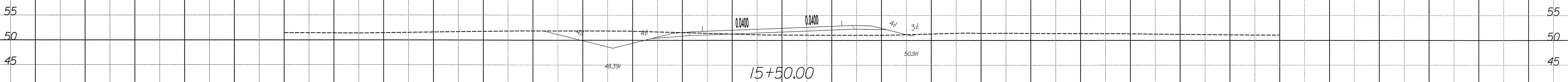
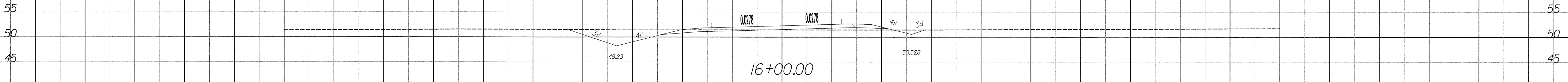
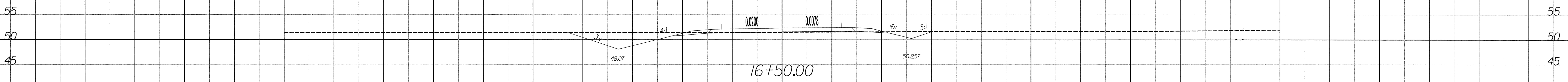
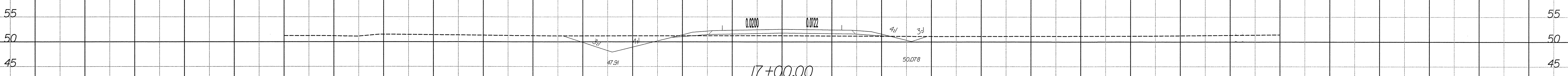

150 140 130 120 110 100 90 80 70 60 50 40 30 20 10 0 10 20 30 40 50 60 70 80 90 100 110 120 130 140 150

4/18/2012
 R:\Roadway\Xsc\Y8_XPL_Paving\R2719A_RDY_XPL_Y8.dgn
 Mike.Little

8/23/99

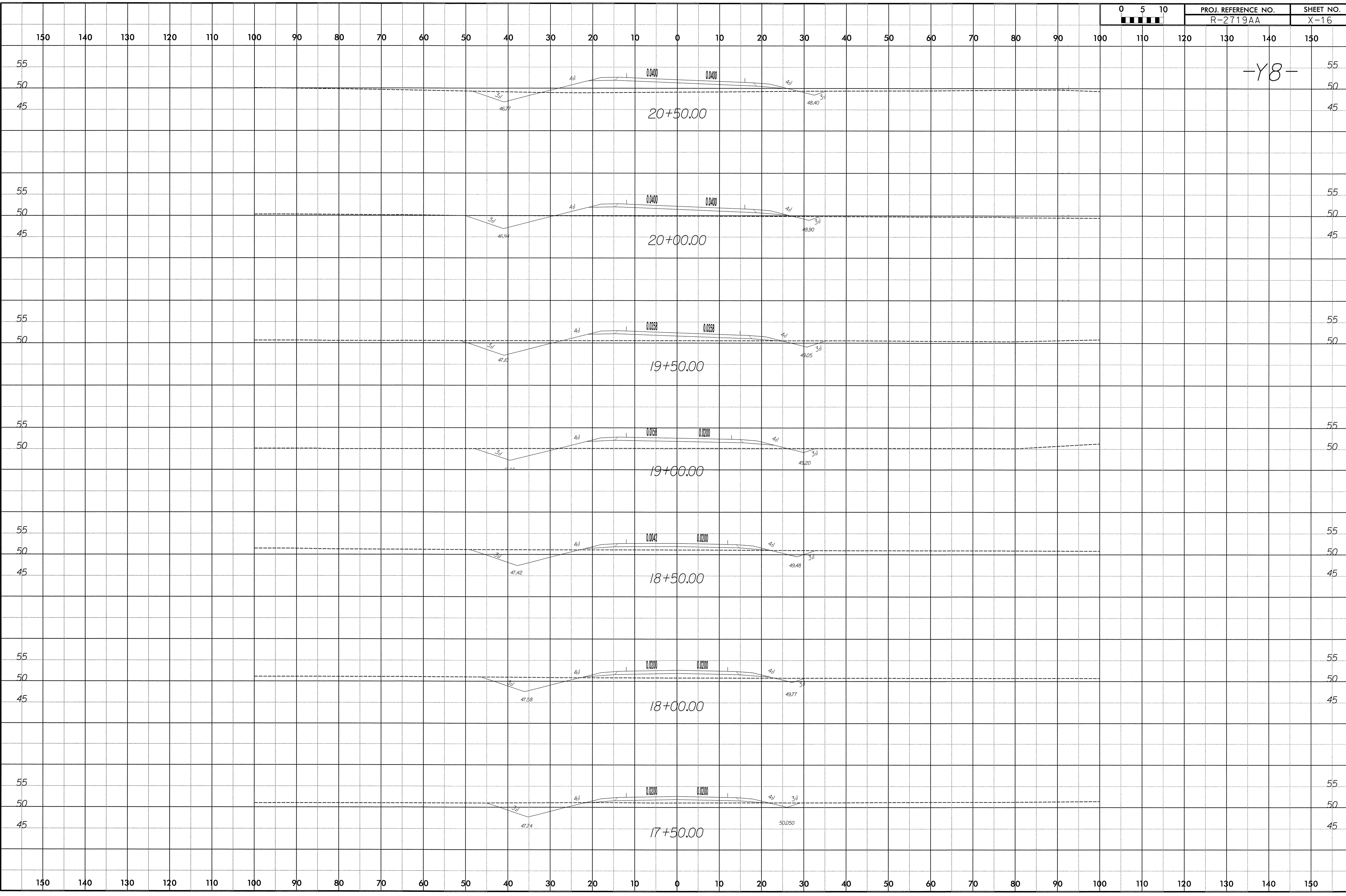

-Y8-

4/18/2012
R:\Roadway\Xsq\W8_XPL_Paving\R2719A-RDY_XPL_Y8.dgn
File:littefield

8/23/99

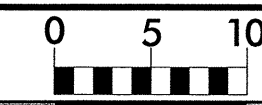

PROJ. REFERENCE NO. R-2719AA	SHEET NO. X-17
---------------------------------	-------------------

150 140 130 120 110 100 90 80 70 60 50 40 30 20 10 0 10 20 30 40 50 60 70 80 90 100 110 120 130 140 150

-Y8-

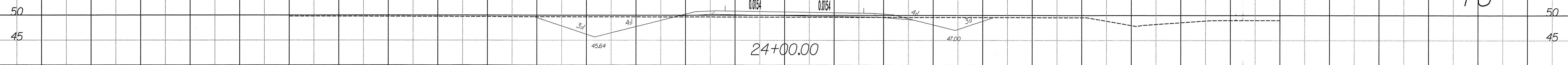

24+00.00

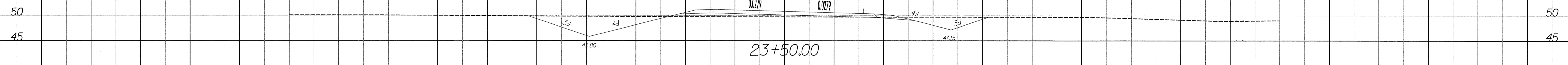

23+50.00

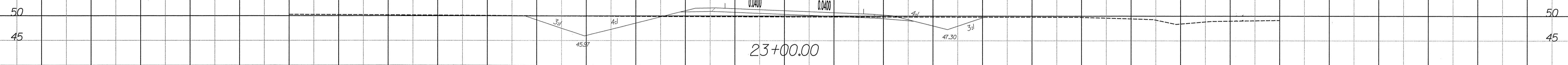

23+00.00

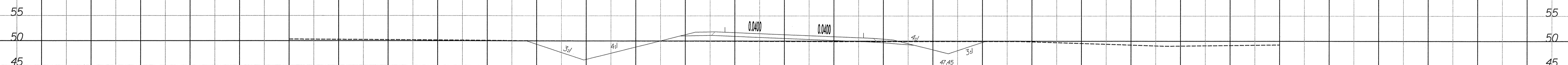

22+50.00

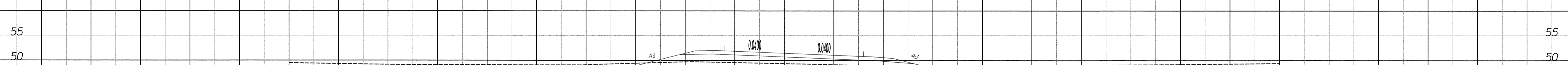

22+00.00

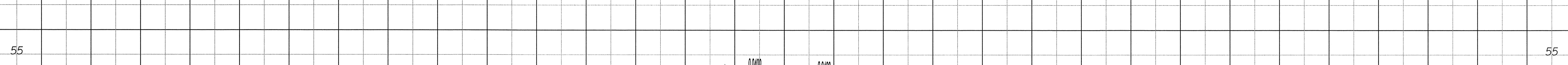

21+50.00

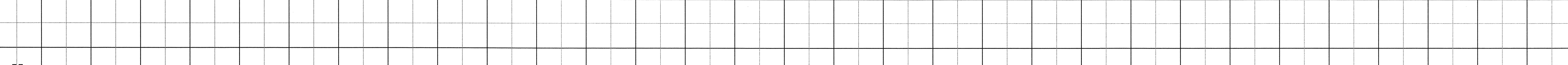

21+00.00

150 140 130 120 110 100 90 80 70 60 50 40 30 20 10 0 10 20 30 40 50 60 70 80 90 100 110 120 130 140 150

4/18/2012
 R:\Roadway_Xisc\Y8_XPL_Paving\R2719A_RDY_XPL_Y8.dgn
 Mike.Little@field

8/23/99

150 140 130 120 110 100 90 80 70 60 50 40 30 20 10 0 10 20 30 40 50 60 70 80 90 100 110 120 130 140 150

-Y8-

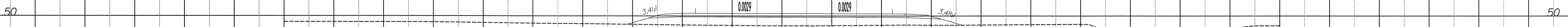

150 140 130 120 110 100 90 80 70 60 50 40 30 20 10 0 10 20 30 40 50 60 70 80 90 100 110 120 130 140 150

4/18/2012
 R:\Roadway\Xsc\Y8_XPL_Paving\R2719A_RDY_XPL_Y8.dgn
 Mike Littlefield

8/23/99

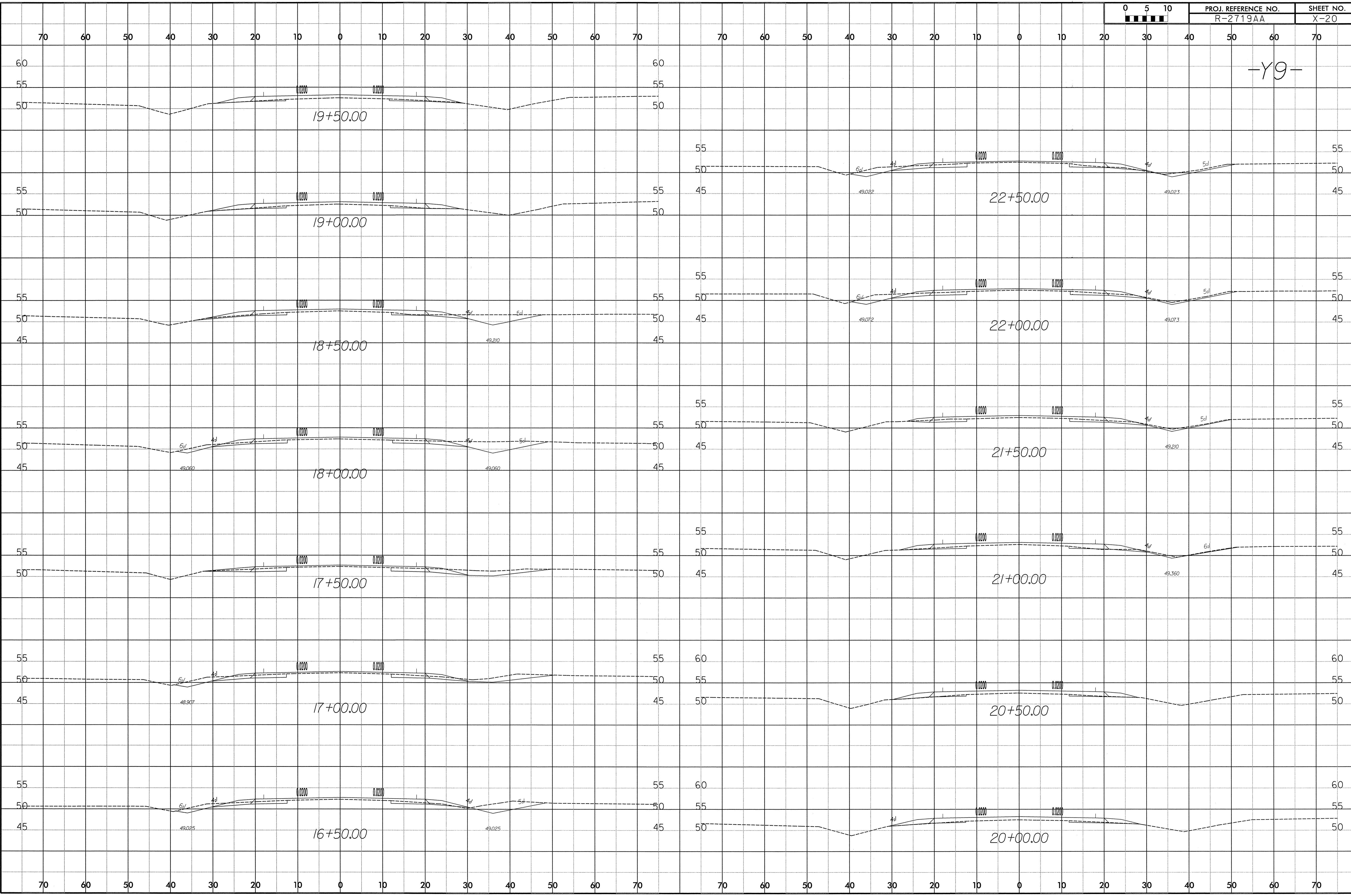

-Y9-

4/18/2012
R:\Roadway\Xsc\8-XPL_Paving\AR2719A_RDY_XPL_Y9.dgn
Mike Littlefield

8/23/99

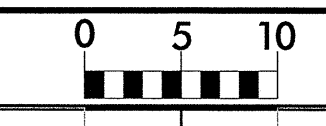

PROJ. REFERENCE NO. R-2719AA	SHEET NO. X-21
---------------------------------	-------------------

70 60 50 40 30 20 10 0 10 20 30 40 50 60 70 70 60 50 40 30 20 10 0 10 20 30 40 50 60 70

-Y9-

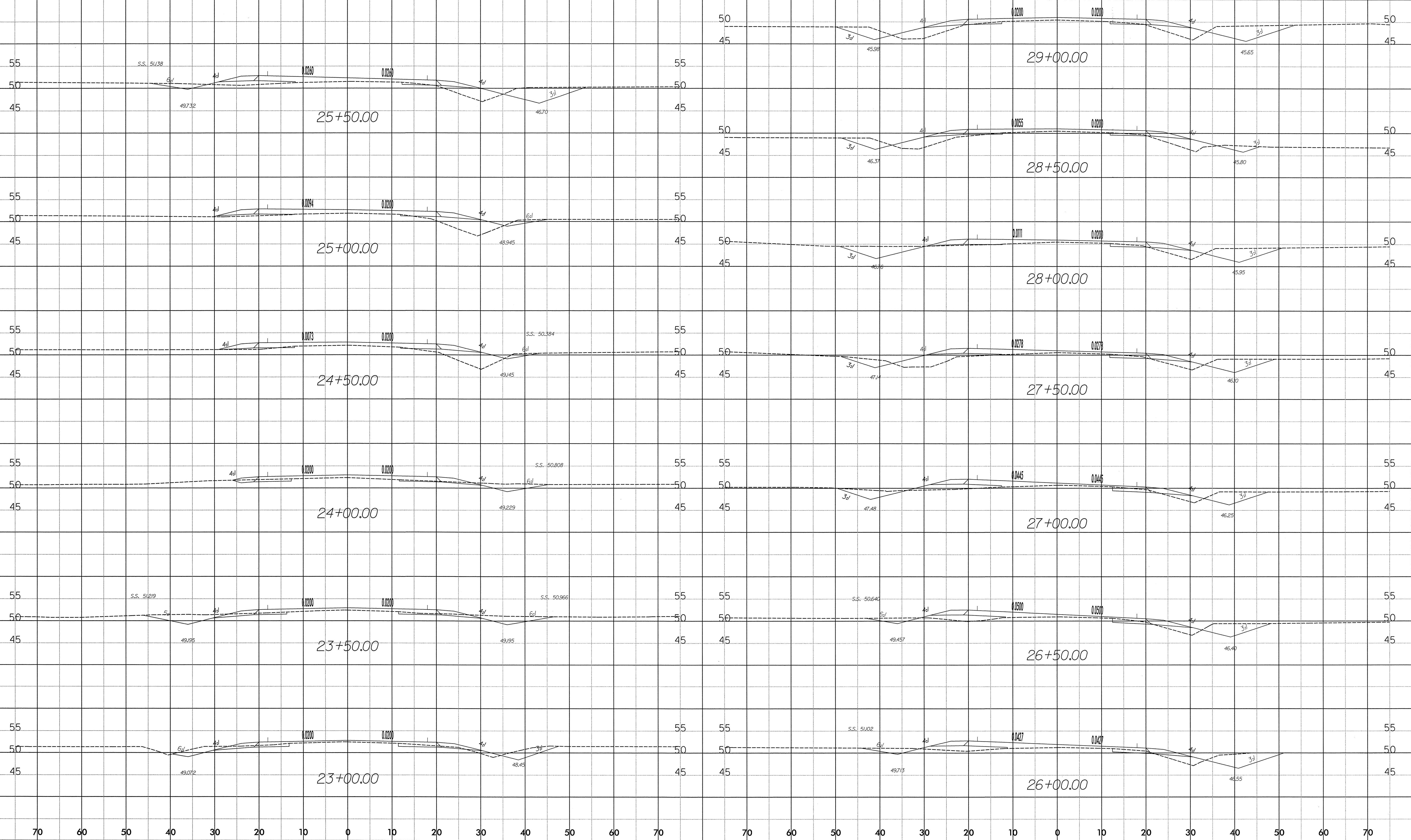

4/18/2012
R:\Roadway\Xisc\Y6_XPL_Paving\N2719A_RDY_XPL_Y9.dgn
Mike Little

8/23/99

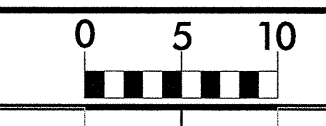

PROJ. REFERENCE NO.
R-2719AA

SHEET NO.
X-22

-Y9-

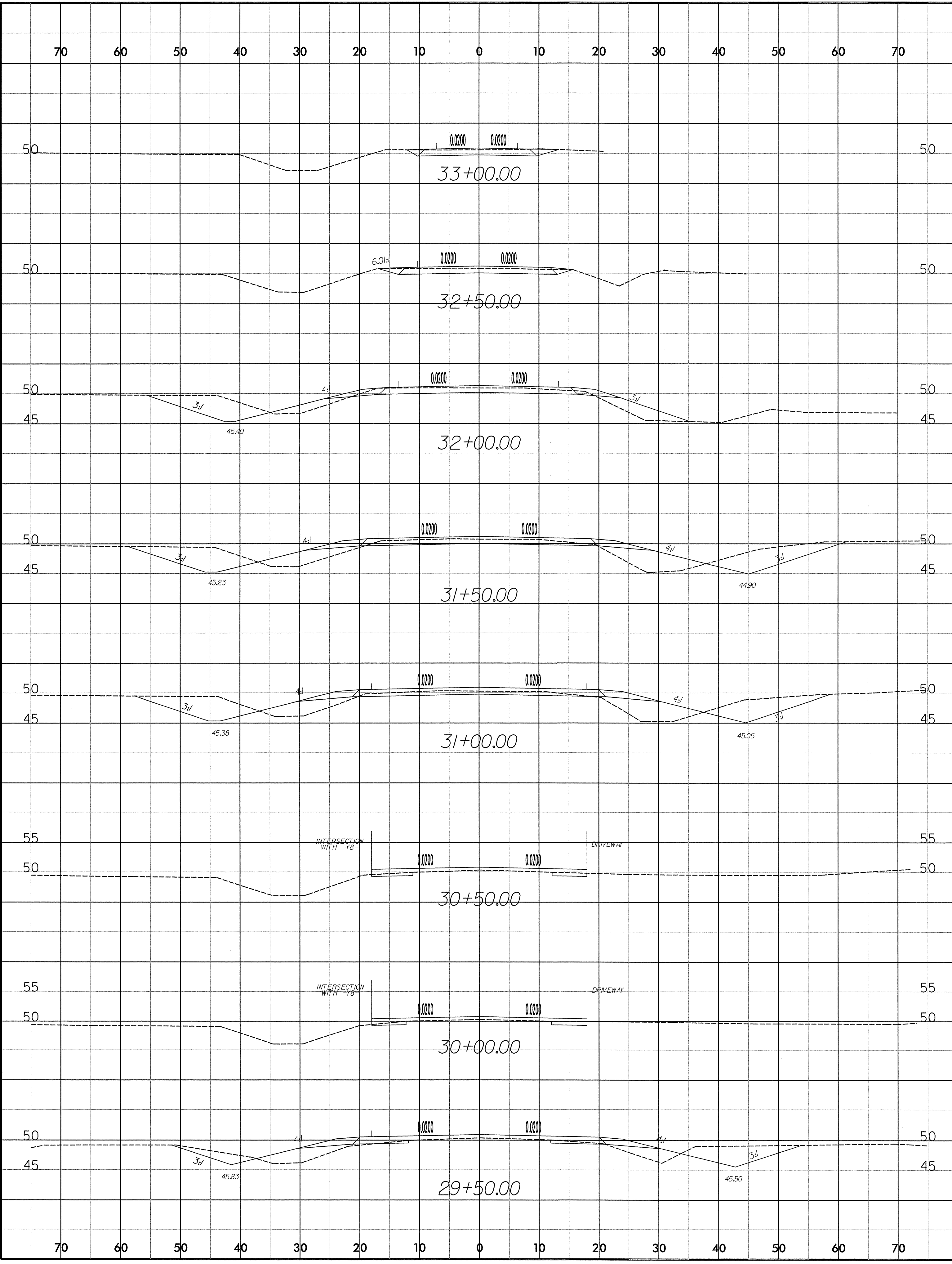

4/18/2012
R:\Roadway\Xsc\Y6_XPL_Paving\R2719A_RDY_XPL_Y9.dgn
Mike Littlefield

8/23/99

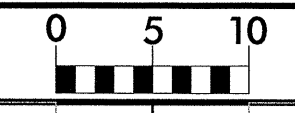

PROJ. REFERENCE NO.
R-2719AA

SHEET NO.
X-23

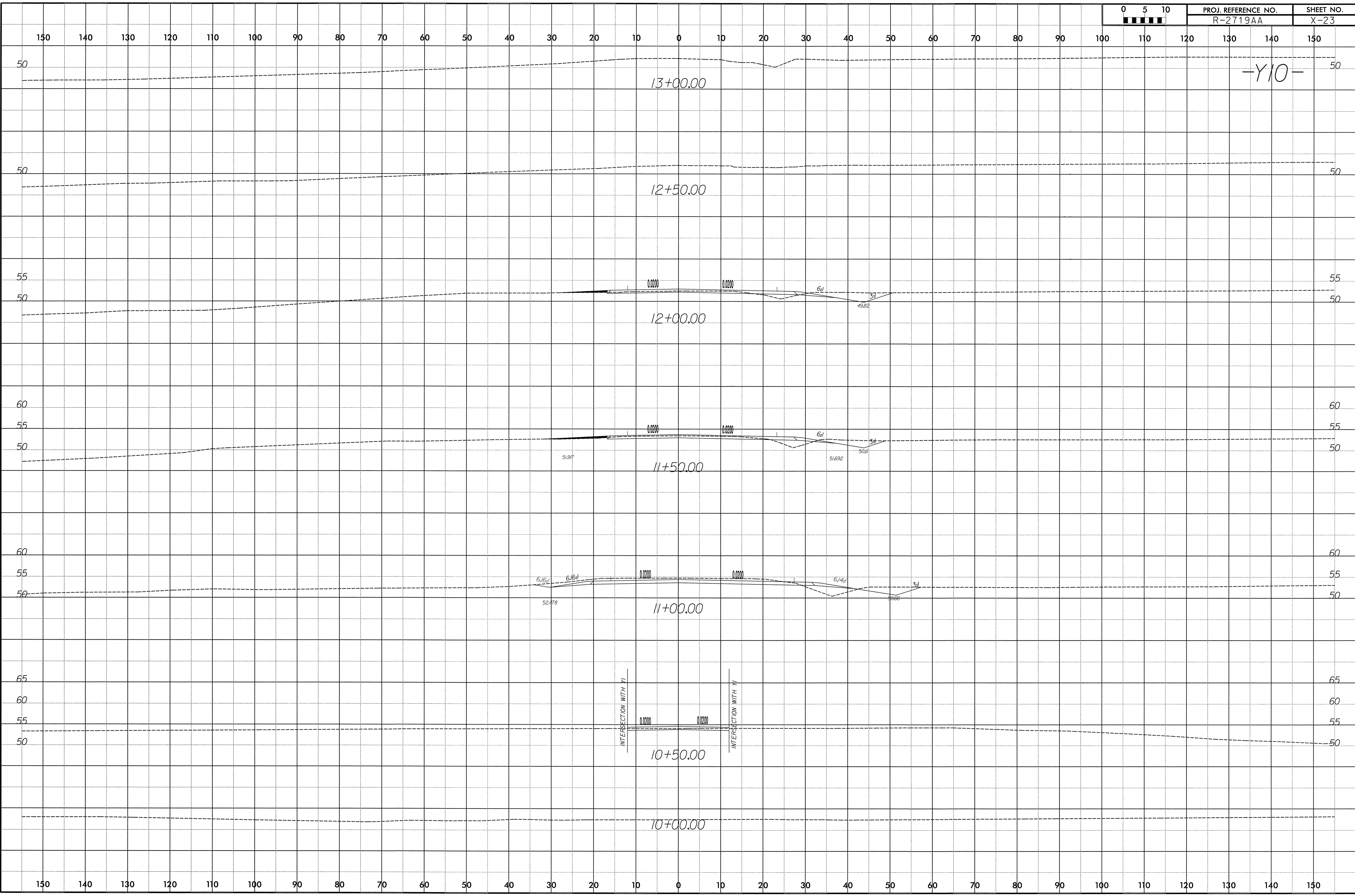

4/18/2012
R:\Roadway\Xsc\Y8_XPL_Paving\R2719A_RDY_XPL_Y10.dgn
Mike Littlefield

150 140 130 120 110 100 90 80 70 60 50 40 30 20 10 0 10 20 30 40 50 60 70 80 90 100 110 120 130 140 150

8/23/99

150 140 130 120 110 100 90 80 70 60 50 40 30 20 10 0 10 20 30 40 50 60 70 80 90 100 110 120 130 140 150

-Y15-

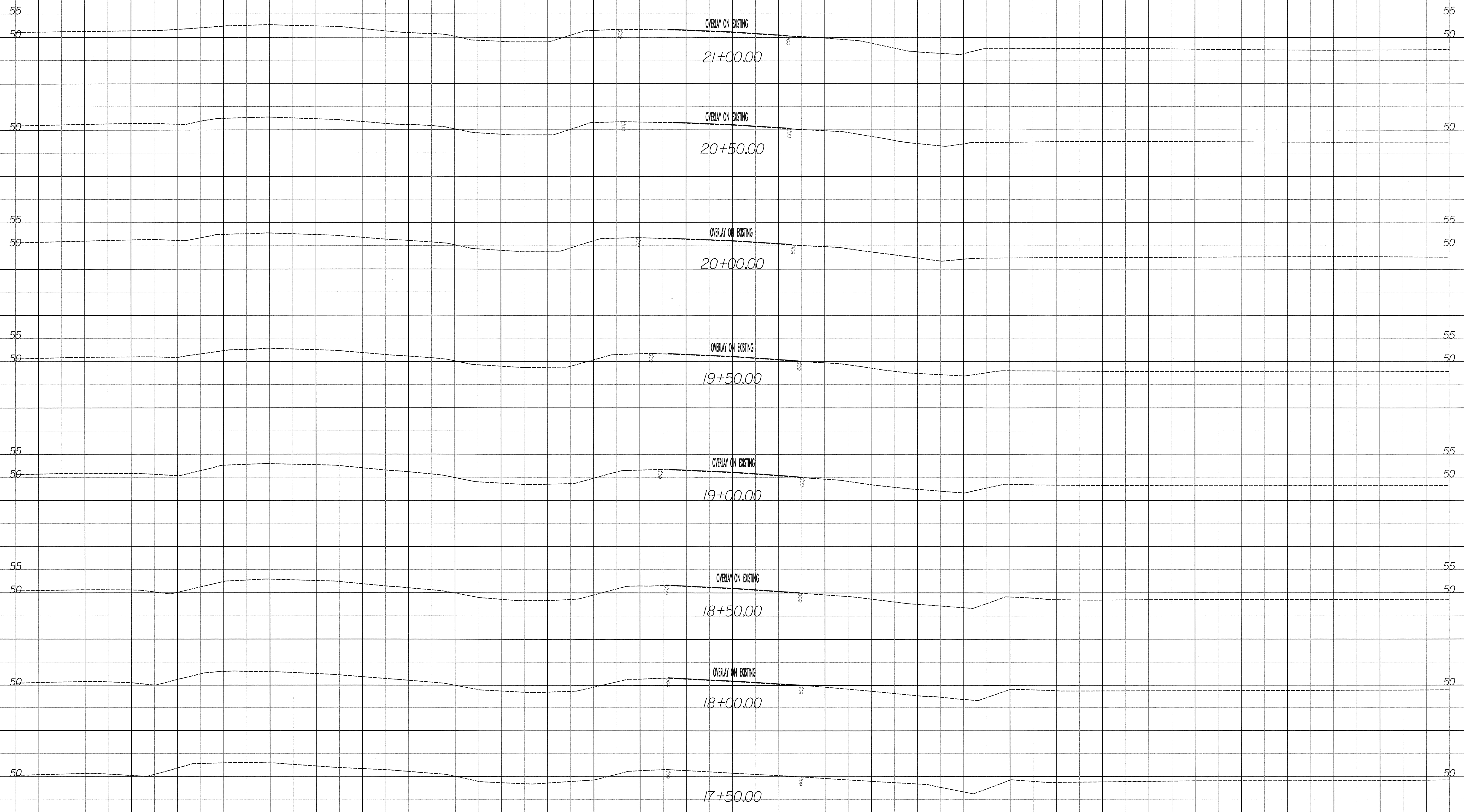

150 140 130 120 110 100 90 80 70 60 50 40 30 20 10 0 10 20 30 40 50 60 70 80 90 100 110 120 130 140 150

4/18/2012
 R:\Roadway\Xsc\Y8_XPL_Paving\R2719A_RDY_XPL_Y15.dgn
 Mike Littlefield

8/23/99

150 140 130 120 110 100 90 80 70 60 50 40 30 20 10 0 10 20 30 40 50 60 70 80 90 100 110 120 130 140 150

-Y15-

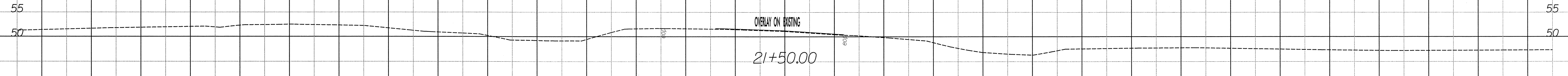
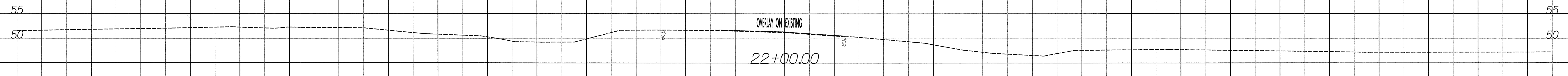
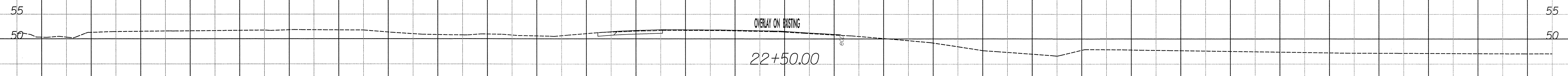
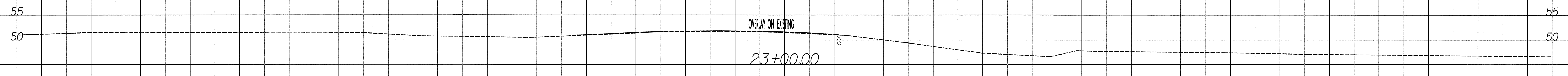
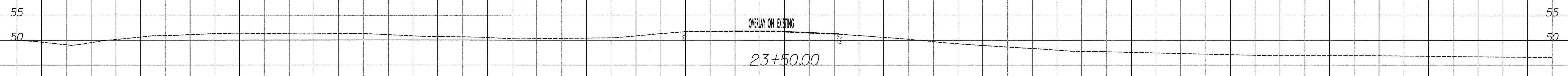
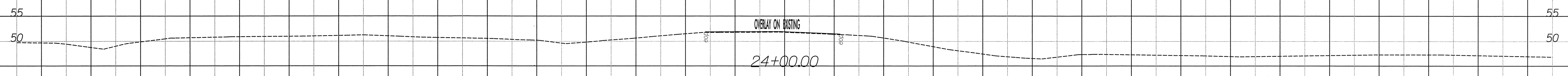
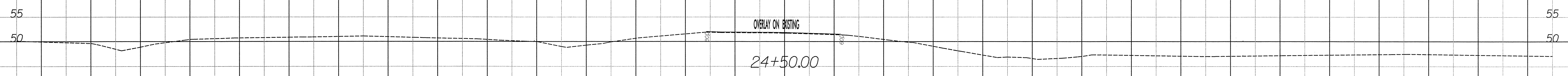

150 140 130 120 110 100 90 80 70 60 50 40 30 20 10 0 10 20 30 40 50 60 70 80 90 100 110 120 130 140 150

4/18/2002 R:\Roadway\Xseq\Y8_XPL_Paving\R2719A-RDY_XPL_Y15.dgn Mike Littlefield

8/23/99

150 140 130 120 110 100 90 80 70 60 50 40 30 20 10 0 10 20 30 40 50 60 70 80 90 100 110 120 130 140 150

-Y15-

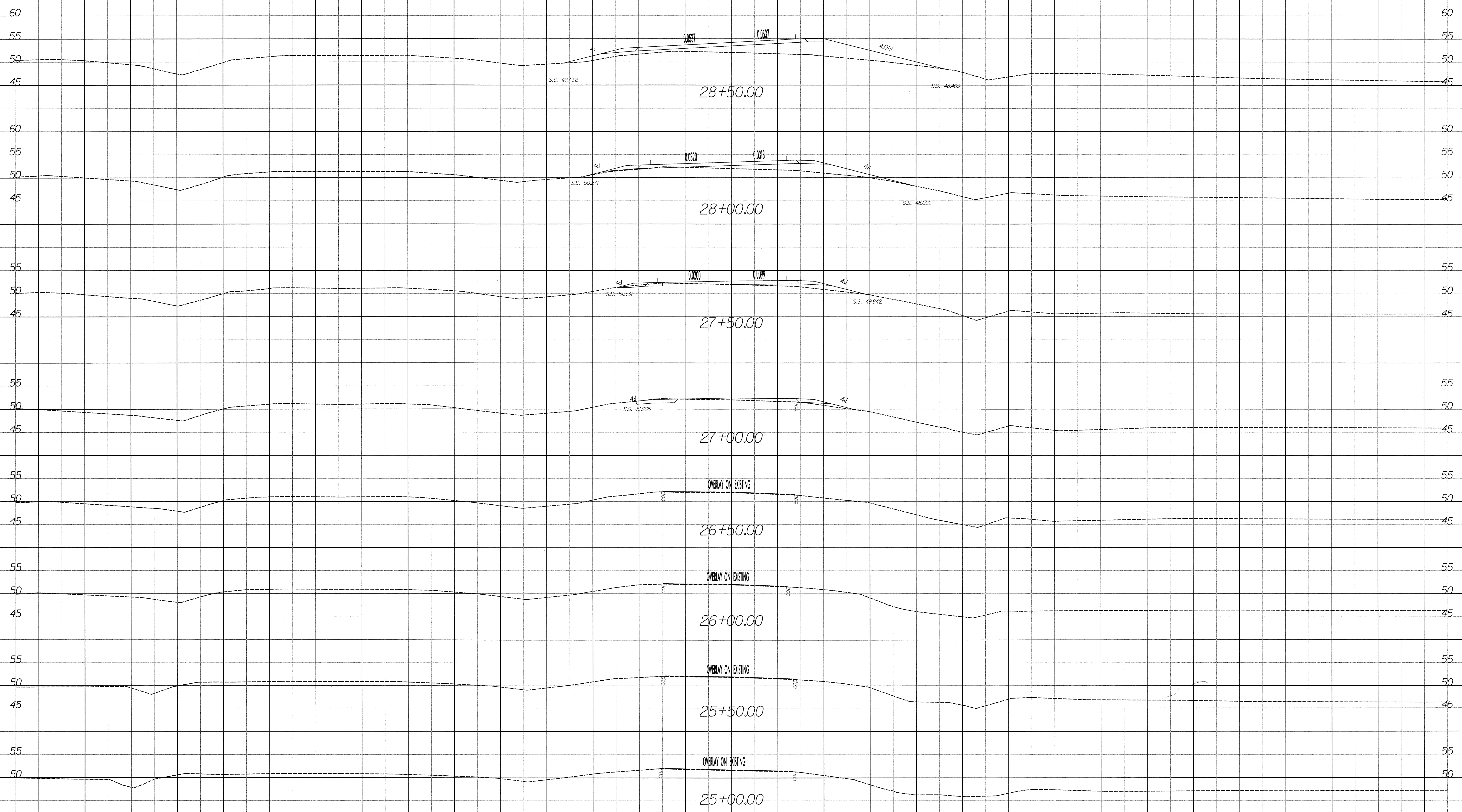

4/18/2012 R:\Roadway\Xsc\Y8-XPL_Paving\AR2719A_RDY_XPL_Y15.dgn Mike Littlefield

150 140 130 120 110 100 90 80 70 60 50 40 30 20 10 0 10 20 30 40 50 60 70 80 90 100 110 120 130 140 150

8/23/99

150 140 130 120 110 100 90 80 70 60 50 40 30 20 10 0 10 20 30 40 50 60 70 80 90 100 110 120 130 140 150

-Y15-

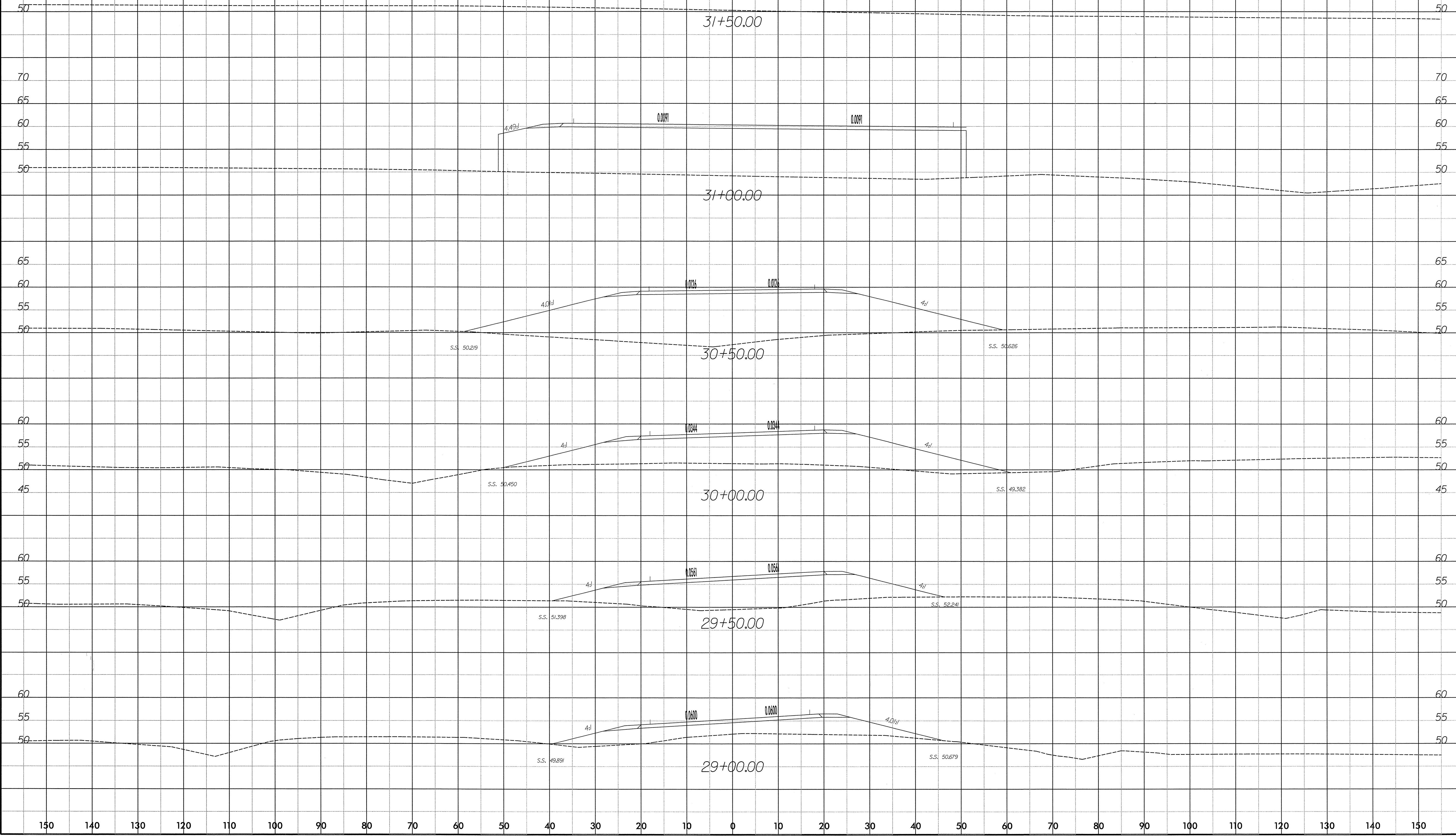

4/18/2012 R:\Roadway\Xsc\Y6_XPL_Paving\R2719A_RDY_XPL_Y15.dgn Mike.Littlefield