

STATE OF NORTH CAROLINA
DIVISION OF HIGHWAYS

TRANSPORTATION MANAGEMENT PLAN

CUMBERLAND COUNTY

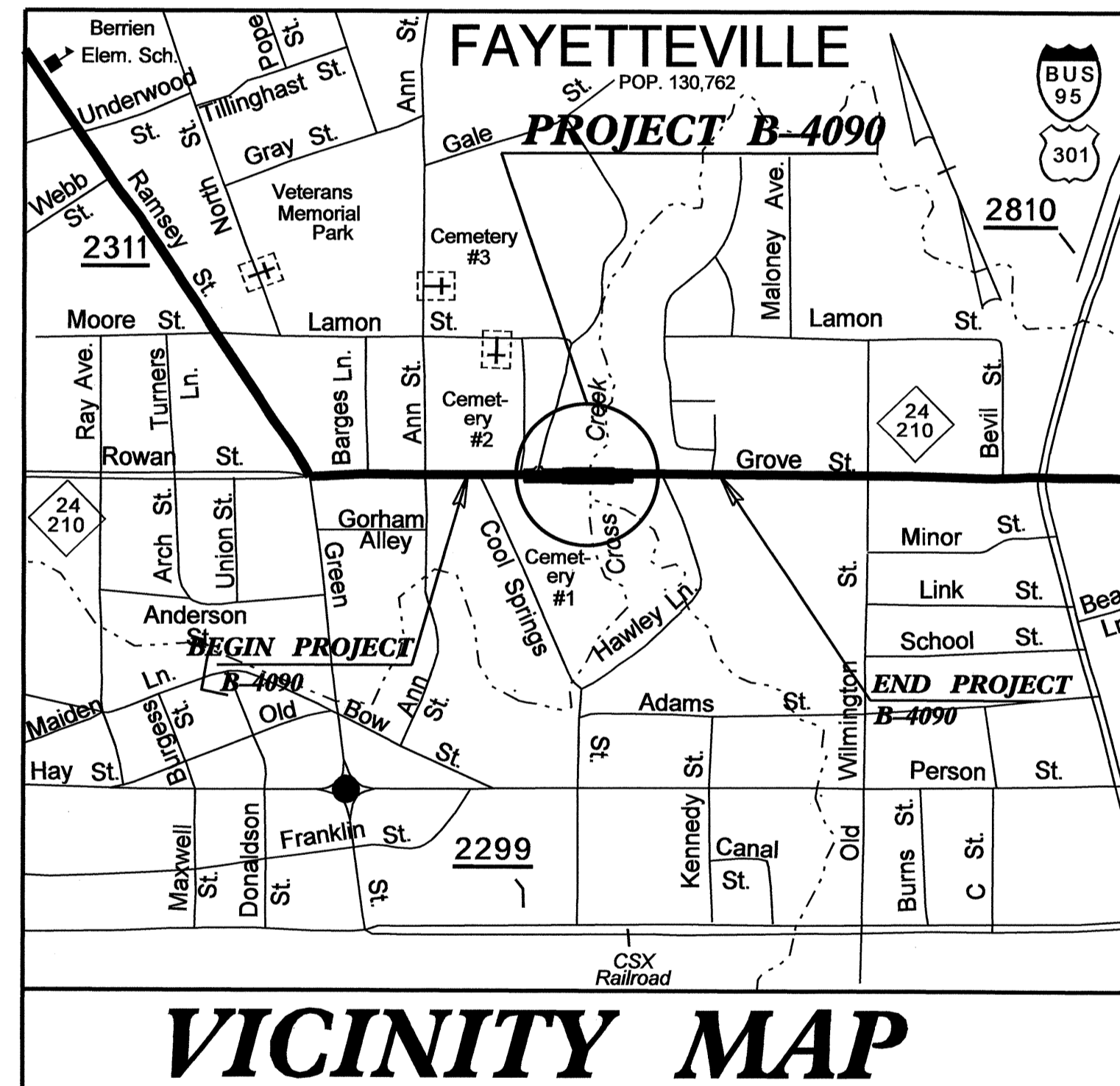
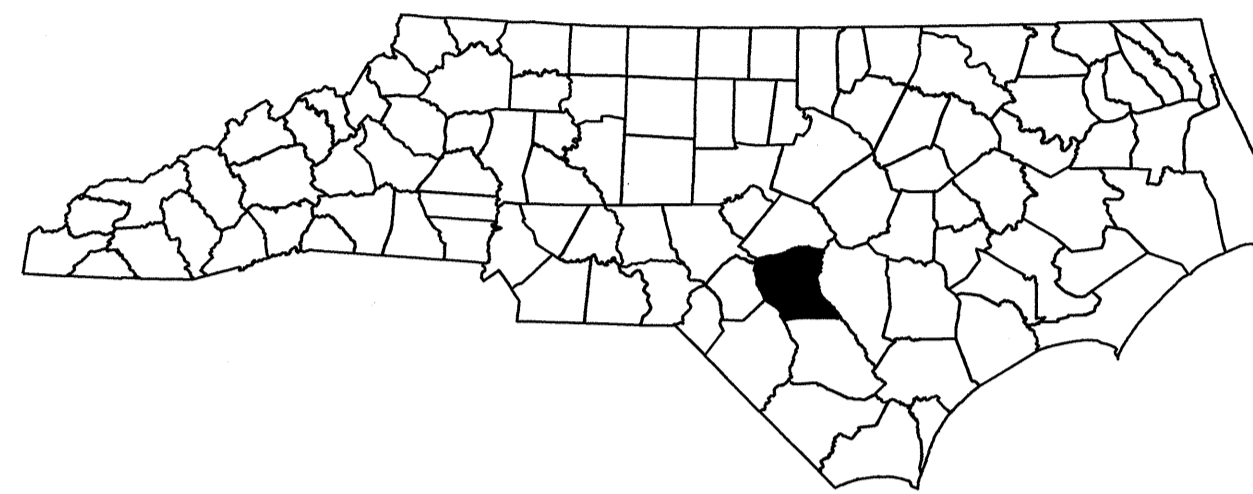

**DESCRIPTION: REPLACE BRIDGE NO. 125 OVER CROSS CREEK
ON NC 24 / NC 210 IN FAYETTEVILLE**

INDEX OF SHEETS

SHEET NO.	TITLE
TMP-1	TITLE SHEET, AND INDEX OF SHEETS
TMP-1A	LIST OF APPLICABLE ROADWAY STANDARD DRAWINGS, LEGEND, AND TEMPORARY PAVEMENT MARKINGS/MARKERS
TMP-1B, TMP-1C	TRANSPORTATION OPERATIONS PLAN & GENERAL NOTES
TMP-2A	PORTABLE CONCRETE BARRIER AT TEMPORARY SHORING LOCATIONS
TMP-2B	TEMPORARY SHORING DATA
TMP-2C	DETAIL DRAWING FOR TWO-WAY UNDIVIDED AND URBAN FREEWAYS WORK ZONE WARNING SIGNS
TMP-2D	SPECIAL SIGN DESIGNS
TMP-3	PHASING
TMP-4, TMP-5	PHASE I DETAILS
TMP-6, TMP-7	PHASE II DETAILS
TMP-8, TMP-9	PHASE III DETAILS
TMP-10, TMP-11	PHASE IV DETAILS
TMP-12	NC 24/NC 210 ALTERNATE ROUTE

SHEET NO.
TMP-1

B-4090

TIP PROJECT:

20-JUL-2011 10:07 AM C:\Users\jg\Documents\Projects\B-4090\TrafficControl\B-4090-TMP-1.dgn

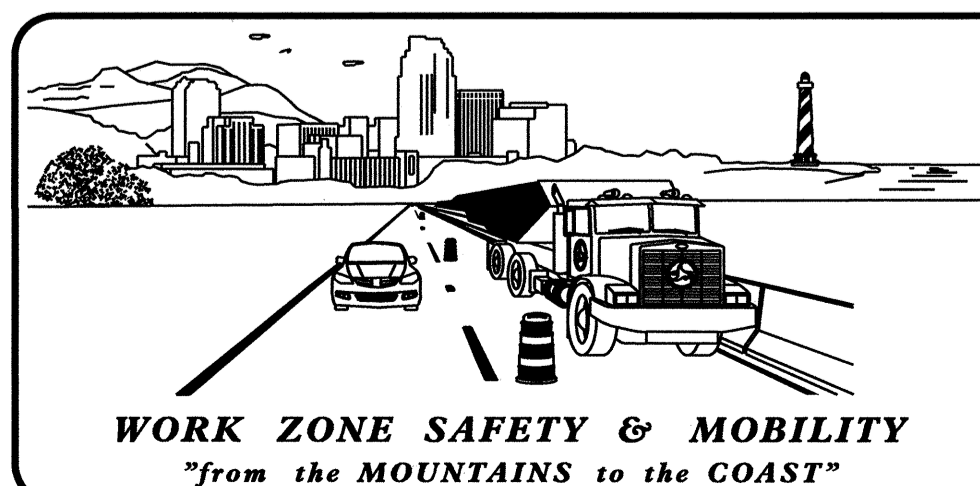

N.C.D.O.T. WORK ZONE TRAFFIC CONTROL
1561 MAIL SERVICE CENTER (MSC) RALEIGH, NC 27699-1561
750 N. GREENFIELD PARKWAY, GARNER, NC 27529 (DELIVERY)
PHONE: (919) 773-2800 FAX: (919) 771-2745

J. S. BOURNE, P.E. STATE TRAFFIC MANAGEMENT ENGINEER
G. L. GETTIER, P.E. TRAFFIC CONTROL PROJECT ENGINEER
J. W. GILSTRAP TRAFFIC CONTROL PROJECT DESIGN ENGINEER
K. P. BROADWELL TRAFFIC CONTROL DESIGN ENGINEER

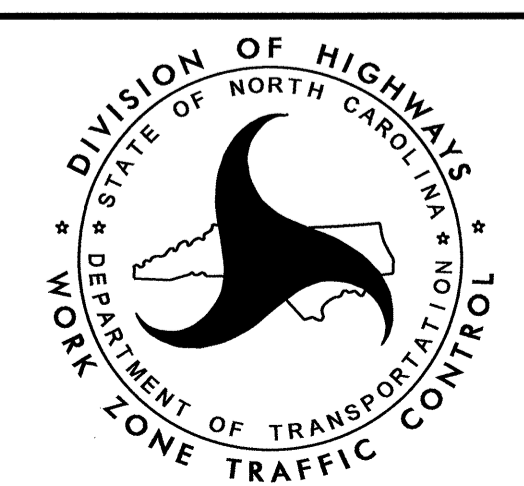

APPROVED: _____
DATE: _____

SEAL

ROADWAY STANDARD DRAWINGS

THE FOLLOWING ROADWAY STANDARDS AS SHOWN IN "ROADWAY STANDARD DRAWINGS" - PROJECT SERVICES UNIT - N.C. DEPARTMENT OF TRANSPORTATION - RALEIGH, N.C., DATED JULY 2006 ARE APPLICABLE TO THIS PROJECT AND BY REFERENCE HEREBY ARE CONSIDERED A PART OF THESE PLANS:

STD. NO.	TITLE
1101.02	TEMPORARY LANE CLOSURES
1101.03	TEMPORARY ROAD CLOSURES
1101.05	WORK ZONE VEHICLE ACCESSES
1101.11	TRAFFIC CONTROL DESIGN TABLES
1110.01	STATIONARY WORK ZONE SIGNS
1110.02	PORTABLE WORK ZONE SIGNS
1115.01	FLASHING ARROW PANELS
1130.01	DRUMS
1135.01	CONES
1145.01	BARRICADES
1150.01	FLAGGING DEVICES
1160.01	TEMPORARY CRASH CUSHION
1165.01	TRUCK MOUNTED IMPACT ATTENUATOR
1170.01	PORTABLE CONCRETE BARRIER
1180.01	SKINNY-DRUM
1205.01	PAVEMENT MARKINGS - LINE TYPES & OFFSETS
1205.02	PAVEMENT MARKINGS - 2 LANE & MULTILANE ROADWAYS
1205.04	PAVEMENT MARKINGS - INTERSECTIONS
1205.05	PAVEMENT MARKINGS - TURN LANES
1205.06	PAVEMENT MARKINGS - THRU LANE DROPS
1205.07	PAVEMENT MARKINGS - PEDESTRIAN CROSSWALKS
1205.08	PAVEMENT MARKINGS - SYMBOLS & WORD MESSAGES
1205.09	PAVEMENT MARKINGS - PAINTED ISLANDS
1250.01	PAVEMENT MARKER SPACING
1251.01	RAISED PAVEMENT MARKERS - (TEMPORARY & PERMANENT)

LEGEND

GENERAL

- DIRECTION OF TRAFFIC FLOW
- EXIST. PVMT.
- NORTH ARROW
- PROPOSED PVMT.
- WORK AREA
- REMOVAL

TEMPORARY PAVEMENT MARKINGS

- PAINT 4"
- PA WHITE EDGELINE
 - PB YELLOW EDGELINE
 - PC 10 FT. WHITE SKIP
 - PD 2 FT. WHITE MINISKIP
 - PE WHITE SOLID LANE LINE
 - PI YELLOW DOUBLE CENTER

- PAINT 8"
- PV YELLOW DIAGONAL

- PAINT-24"
- P5 WHITE CROSSWALK LINE

- PAINT MARKING SYMBOLS
- QA LEFT TURN ARROW
 - QB RIGHT TURN ARROW
 - QM YIELD LINE (SHARKS TEETH)

- PAINT MARKING CHARACTERS
- QI ALPHANUMERIC CHAR.

- COLD APPLIED PLASTIC TYPE IV (REMOVEABLE TAPE)
- RA WHITE EDGELINE
 - RC 10 FT. WHITE SKIP
 - RI DOUBLE YELLOW CENTER

- MARKERS
- MH YELLOW - YELLOW (TEMPORARY RAISED)
 - MI CRYSTAL & RED (TEMPORARY RAISED)

TRAFFIC CONTROL DEVICES

- BARRICADE (TYPE III)
- CONE
- DRUM SKINNY DRUM TUBULAR MARKER
- TEMPORARY CRASH CUSHION
- FLASHING ARROW PANEL (TYPE C)
- FLAGGER
- LAW ENFORCEMENT
- TRUCK MOUNTED IMPACT ATTENUATOR (TMIA)
- CHANGEABLE MESSAGE SIGN

TEMPORARY SIGNING

- PORTABLE SIGN
- STATIONARY SIGN
- STATIONARY OR PORTABLE SIGN

SIGNALS

- EXISTING
- PROPOSED
- TEMPORARY

PAVEMENT MARKINGS

- EXISTING LINES
- TEMPORARY LINES

PAVEMENT MARKERS



- CRYSTAL/CRYSTAL
- CRYSTAL/RED
- YELLOW/YELLOW

PAVEMENT MARKING SYMBOLS

- PAVEMENT MARKING SYMBOLS

APPROVED: _____ DATE: _____

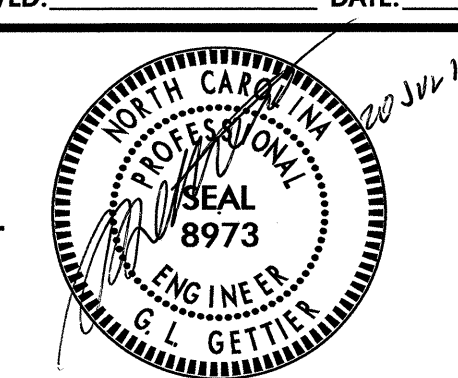
SEAL

**ROADWAY STANDARD
DRAWINGS & LEGEND**

20-JUL-2011 10:06 K:\DOT\GIS\DOT\Projects\TIP\Projects\B-4090\TrafficControl\tp\B-4090_TMP-1.dgn

TRANSPORTATION OPERATIONS

CONSTRUCTION

REPLACE EXISTING BRIDGE NO. 125 UTILIZING ON-SITE DETOUR.

TMP DESIGN PARAMETERS

CONTRACTOR SHALL INSTALL ALTERNATE ROUTE SIGNAGE FOR NC 24 / NC 210 AS SHOWN ON SHEET TMP-12.

CONTRACTOR SHALL CONVERT THE OUTSIDE LANES OF TRAFFIC INTO LANE DROP/RIGHT TURN ONLY LANES AS SHOWN ON SHEETS TMP-4 AND TMP-5. TRAFFIC WILL BE IN A FOUR-LANE, TWO-WAY TRAFFIC PATTERN FOR THE DURATION OF PROJECT.

FOR THE DURATION OF THE PROJECT LEFT TURNS WILL BE PROHIBITED OUT OF COOL SPRINGS STREET AND HAWLEY LANE.

FOR THE DURATION OF THE PROJECT THE DRIVEWAY TO THE CITY OF FAYETTEVILLE'S MAINTENANCE FACILITY FROM GROVE STREET (-L-) WILL BE CLOSED AND ACCESS PROVIDED VIA THE LAMON STREET ENTRANCE.

THIS PROJECT CONTAINS DAILY LANE CLOSURE TIME RESTRICTIONS, IN ADDITION TO HOLIDAYS AND SPECIAL EVENTS (SEE SHEET TMP-1B).

PEDESTRIAN TRAFFIC OVER CROSS CREEK SHALL BE MAINTAINED THROUGHOUT THE DURATION OF THE PROJECT.

GENERAL OUTLINE

1. CONVERT OUTSIDE LANES OF TRAFFIC INTO DROP/RIGHT TURN ONLY LANES AS SHOWN ON SHEETS TMP-4 AND TMP-5. TRANSITION FROM EXISTING PATTERN TO A FOUR-LANE, TWO-WAY TRAVELWAY. CONSTRUCT THE TEMPORARY DETOUR BRIDGE AND APPROACHES BEHIND PORTABLE CONCRETE BARRIER, UTILIZING TEMPORARY SHORING.
2. SHIFT TRAFFIC TO TEMPORARY DETOUR, CONSTRUCT PROPOSED BRIDGE AND APPROACHES BEHIND PORTABLE CONCRETE BARRIER AS SHOWN ON SHEETS TMP-6 AND TMP-7.
3. SHIFT TRAFFIC TO THE PROPOSED BRIDGE IN A FOUR-LANE, TWO-WAY PATTERN. REMOVE THE TEMPORARY DETOUR BRIDGE BEHIND PORTABLE CONCRETE BARRIER AS SHOWN ON SHEETS TMP-8 AND TMP-9.
4. SHIFT TRAFFIC TO THE OUTSIDE LANES IN A FOUR-LANE, TWO-WAY DIVIDED PATTERN. CONSTRUCT PROPOSED CONCRETE MEDIAN BEHIND DRUMS AS SHOWN ON SHEETS TMP-10 AND TMP-11.
5. INSTALL FINAL LAYER OF SURFACE COURSE AND FINAL PAVEMENT MARKINGS/MARKERS USING LANE CLOSURES AND FLAGGING AS REQUIRED. REMOVE ALL TRAFFIC CONTROL DEVICES AND OPEN TO THE FINAL TRAFFIC PATTERN.

GENERAL NOTES

PROJ. REFERENCE NO.	SHEET NO.
B-4090	TMP-1B

LANE AND SHOULDER CLOSURE REQUIREMENTS

- E) REMOVE LANE CLOSURE DEVICES FROM THE LANE WHEN WORK IS NOT BEING PERFORMED BEHIND THE LANE CLOSURE OR WHEN A LANE CLOSURE IS NO LONGER NEEDED, OR AS DIRECTED BY THE ENGINEER.
- F) WHEN PERSONNEL AND/OR EQUIPMENT ARE WORKING ON THE SHOULDER ADJACENT TO AN UNDIVIDED FACILITY AND WITHIN 5 FT OF AN OPEN TRAVEL LANE, CLOSE THE NEAREST OPEN TRAVEL LANE USING ROADWAY STANDARD DRAWING NO. 1101.02 UNLESS THE WORK AREA IS PROTECTED BY BARRIER OR GUARDRAIL.

WHEN PERSONNEL AND/OR EQUIPMENT ARE WORKING ON THE SHOULDER ADJACENT TO A DIVIDED FACILITY AND WITHIN 10 FT OF AN OPEN TRAVEL LANE, CLOSE THE NEAREST OPEN TRAVEL LANE USING ROADWAY STANDARD DRAWING NO. 1101.02 UNLESS THE WORK AREA IS PROTECTED BY BARRIER OR GUARDRAIL.

- G) WHEN PERSONNEL AND/OR EQUIPMENT ARE WORKING WITHIN A LANE OF TRAVEL OF AN UNDIVIDED OR DIVIDED FACILITY, CLOSE THE LANE ACCORDING TO THE TRAFFIC CONTROL PLANS, ROADWAY STANDARD DRAWINGS OR AS DIRECTED BY THE ENGINEER. CONDUCT THE WORK SO THAT ALL PERSONNEL AND/OR EQUIPMENT REMAIN WITHIN THE CLOSED TRAVEL LANE.

- H) DO NOT WORK SIMULTANEOUSLY WITHIN 15 FT ON BOTH SIDES OF AN OPEN TRAVELWAY, RAMP OR LOOP WITHIN THE SAME LOCATION UNLESS PROTECTED WITH GUARDRAIL OR BARRIER.

- I) PROVIDE TRAFFIC CONTROL FOR APPROPRIATE LANE CLOSURES FOR SURVEYING DONE BY THE DEPARTMENT.

PAVEMENT EDGE DROP OFF REQUIREMENTS

- J) BACKFILL AT A 6:1 SLOPE UP TO THE EDGE AND ELEVATION OF EXISTING PAVEMENT IN AREAS ADJACENT TO AN OPENED TRAVEL LANE THAT HAS A DROP-OFF AS FOLLOWS:

BACKFILL DROP-OFFS THAT EXCEED 2 INCHES ON ROADWAYS WITH POSTED SPEED LIMITS OF 45 MPH OR GREATER.

BACKFILL DROP-OFFS THAT EXCEED 3 INCHES ON ROADWAYS WITH POSTED SPEED LIMITS LESS THAN 45 MPH.

BACKFILL WITH SUITABLE COMPACTED MATERIAL, AS APPROVED BY THE ENGINEER, AT NO EXPENSE TO THE DEPARTMENT.

- K) DO NOT EXCEED A DIFFERENCE OF 2 INCHES IN ELEVATION BETWEEN OPEN LANES OF TRAFFIC FOR NOMINAL LIFTS OF 1.5 INCHES. INSTALL ADVANCE WARNING "UNEVEN LANES" SIGNS (W8-11) 200 FT IN ADVANCE AND A MINIMUM OF ONCE EVERY HALF MILE THROUGHOUT THE UNEVEN AREA.

TRAFFIC PATTERN ALTERATIONS

- L) NOTIFY THE ENGINEER TWENTY ONE (21) CALENDAR DAYS PRIOR TO ANY TRAFFIC PATTERN ALTERATION.

SIGNING

- M) INSTALL ADVANCE WORK ZONE WARNING SIGNS WHEN WORK IS WITHIN 40 FT FROM THE EDGE OF TRAVEL LANE AND NO MORE THAN THREE (3) DAYS PRIOR TO THE BEGINNING OF CONSTRUCTION.
- N) PROVIDE PERMANENT SIGNING.
- O) ENSURE ALL NECESSARY SIGNING IS IN PLACE PRIOR TO ALTERING ANY TRAFFIC PATTERN.

CHANGES MAY BE REQUIRED WHEN PHYSICAL DIMENSIONS IN THE DETAIL DRAWINGS, STANDARD DETAILS AND ROADWAY DETAILS ARE NOT ATTAINABLE TO MEET FIELD CONDITIONS, OR RESULT IN DUPLICATE, OR UNDESIRED OVERLAPPING OF DEVICES. MODIFICATION MAY INCLUDE: MOVING, SUPPLEMENTING, COVERING OR REMOVAL OF DEVICES, AS DIRECTED BY THE ENGINEER.

THE FOLLOWING GENERAL NOTES APPLY AT ALL TIMES FOR THE DURATION OF THE CONSTRUCTION PROJECT EXCEPT WHEN OTHERWISE NOTED IN THE PLAN OR AS DIRECTED BY THE ENGINEER.

TIME RESTRICTIONS

- A) DO NOT CLOSE OR NARROW TRAVEL LANES AS FOLLOWS:

ROAD NAME	DAY AND TIME RESTRICTIONS
1. NC 24/210 GROVE ST. (-L-) (EXISTING 6-LANE, 2-WAY PATTERN, CLOSE 2-LANES MAX. IN EACH DIRECTION)	6:00 A.M. TO 9:00 P.M. MONDAY THROUGH FRIDAY AND 9:00 A.M. TO 9:00 P.M. SATURDAY AND SUNDAY
(TEMPORARY 4-LANE, 2-WAY PATTERN, CLOSE 1-LANE MAX. IN EACH DIRECTION)	
2. NC 24/210 GROVE ST. (-L-) (EXISTING 6-LANE, 2-WAY PATTERN, CLOSE 1-LANE MAX. IN EACH DIRECTION)	NO RESTRICTIONS

- B) DO NOT CLOSE OR NARROW TRAVEL LANES DURING HOLIDAYS AND SPECIAL EVENTS AS FOLLOWS:

ROAD NAME	HOLIDAY
1. NC 24/210 GROVE ST. (-L-)	
	1. FOR ANY UNEXPECTED OCCURRENCE THAT CREATES UNUSUALLY HIGH TRAFFIC VOLUMES, AS DIRECTED BY THE ENGINEER.
	2. FOR THE DOGWOOD FESTIVAL, BETWEEN THE HOURS OF 6:00 A.M. THE FRIDAY OF THE DOGWOOD FESTIVAL WEEKEND AND 9:00 P.M. THE FOLLOWING SUNDAY OF THE DOGWOOD FESTIVAL WEEKEND.
	3. FOR THE INTERNATIONAL FOLK FESTIVAL, BETWEEN THE HOURS OF 6:00 A.M. THE FRIDAY OF THE INTERNATIONAL FOLK FESTIVAL WEEKEND AND 9:00 P.M. THE FOLLOWING SUNDAY OF THE INTERNATIONAL FOLK FESTIVAL WEEKEND.

- C) DO NOT STOP TRAFFIC AS FOLLOWS:

ROAD NAME	DAY AND TIME RESTRICTIONS	DURATION AND OPERATION
1. NC 24/210 GROVE ST. (-L-)	5:30 A.M. TO 10:00 P.M. MONDAY THROUGH SUNDAY	30 MINUTES MAX. TO SET BRIDGE GIRDERS & FOR TRAFFIC OPERATIONS

- D) DO NOT CONDUCT ANY HAULING OPERATIONS AGAINST THE FLOW OF TRAFFIC OF AN OPEN TRAVELWAY UNLESS THE HAULING OPERATION IS PROTECTED BY BARRIER OR GUARDRAIL OR AS DIRECTED BY THE ENGINEER.

20-JUL-2011 10:04 AM C:\Users\jgibson\Documents\Projects\B\B4090\TrafficControl\tpd\B-4090-TMP-1.dgn

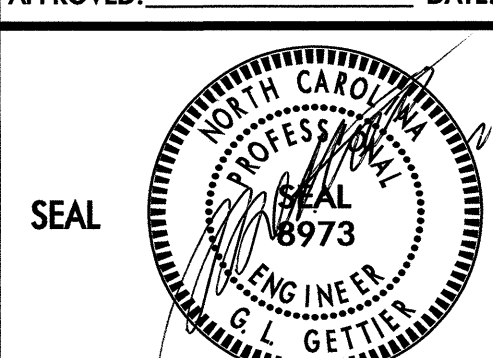
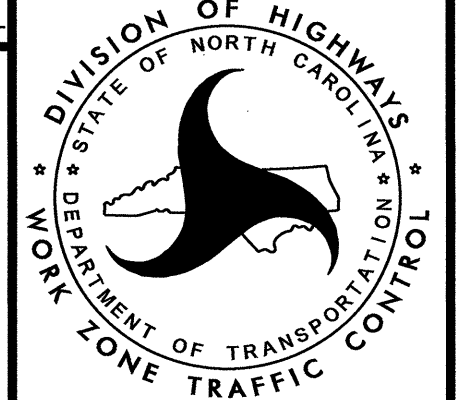
APPROVED: _____ DATE: _____ 		TRANSPORTATION OPERATIONS AND GENERAL NOTES
--	---	--

GENERAL NOTES cont'd

PROJ. REFERENCE NO. B-4090	SHEET NO. TMP-1C
-------------------------------	---------------------

TRAFFIC BARRIER

P) INSTALL TEMPORARY BARRIER ACCORDING TO THE TRAFFIC CONTROL PLANS A MAXIMUM OF TWO (2) WEEKS PRIOR TO BEGINNING WORK IN ANY LOCATION. ONCE TEMPORARY BARRIER IS INSTALLED AT ANY LOCATION, PROCEED IN A CONTINUOUS MANNER TO COMPLETE THE PROPOSED WORK IN THAT LOCATION UNLESS OTHERWISE STATED IN THE TRAFFIC CONTROL PLANS OR AS DIRECTED BY THE ENGINEER.

DO NOT PLACE BARRIER DIRECTLY ON ANY SURFACE OTHER THAN ASPHALT OR CONCRETE.

ONCE TEMPORARY BARRIER IS INSTALLED AT ANY LOCATION AND NO WORK IS PERFORMED BEHIND THE TEMPORARY BARRIER FOR A PERIOD LONGER THAN TWO (2) MONTHS, REMOVE/RESET TEMPORARY BARRIER AT NO COST TO THE DEPARTMENT UNLESS OTHERWISE STATED IN THE TRAFFIC CONTROL PLANS, TEMPORARY BARRIER IS PROTECTING A HAZARD, OR AS DIRECTED BY THE ENGINEER.

INSTALL TEMPORARY BARRIER WITH THE TRAFFIC FLOW, BEGINNING WITH THE UPSTREAM SIDE OF TRAFFIC. REMOVE TEMPORARY BARRIER AGAINST THE TRAFFIC FLOW, BEGINNING WITH THE DOWNSTREAM SIDE OF TRAFFIC.

INSTALL AND SPACE DRUMS NO GREATER THAN TWICE THE POSTED SPEED LIMIT (MPH) TO CLOSE OR KEEP THE SECTION OF THE ROADWAY CLOSED UNTIL THE TEMPORARY BARRIER CAN BE PLACED OR AFTER THE TEMPORARY BARRIER IS REMOVED.

Q) PROTECT THE APPROACH END OF MOVABLE/PORTABLE CONCRETE BARRIER AT ALL TIMES DURING THE INSTALLATION AND REMOVAL OF THE BARRIER BY EITHER A TRUCK MOUNTED IMPACT ATTENUATOR (MAXIMUM 72 HOURS) OR A TEMPORARY CRASH CUSHION.

PROTECT THE APPROACH END OF MOVABLE/PORTABLE CONCRETE BARRIER FROM ONCOMING TRAFFIC AT ALL TIMES BY A TEMPORARY CRASH CUSHION UNLESS THE APPROACH END OF MOVABLE/PORTABLE CONCRETE BARRIER IS OFFSET FROM ONCOMING TRAFFIC AS FOLLOWS OR AS SHOWN IN THE PLANS:

POSTED SPEED LIMIT	MINIMUM OFFSET
40 OR LESS	15 FT
45-50	20 FT
55	25 FT
60 MPH or HIGHER	30 FT

TRAFFIC CONTROL DEVICES

R) SPACE CHANNELIZING DEVICES IN WORK AREAS NO GREATER IN FEET THAN TWICE THE POSTED SPEED LIMIT (MPH), EXCEPT 10 FT ON-CENTER IN RADII, AND 3 FT OFF THE EDGE OF AN OPEN TRAVELWAY, WHEN LANE CLOSURES ARE NOT IN EFFECT. WHEN SKINNY DRUMS ARE ALLOWED REFER TO SECTION 1180 OF STANDARD SPECIFICATIONS FOR ROADS AND STRUCTURES OR AS SHOWN IN THE PLANS.

S) PLACE TYPE III BARRICADES WITH "ROAD CLOSED" SIGN R11-2 ATTACHED OF SUFFICIENT LENGTH TO CLOSE ENTIRE ROADWAY.

T) PLACE ADDITIONAL SETS OF THREE CHANNELIZING DEVICES (DRUMS, CONES OR SKINNY DRUMS) PERPENDICULAR TO THE EDGE OF TRAVELWAY ON 200 FT CENTERS WHEN UNOPENED LANES ARE CLOSED TO TRAFFIC.

PAVEMENT MARKINGS AND MARKERS

U) INSTALL PAVEMENT MARKINGS AND PAVEMENT MARKERS ON THE FINAL SURFACE AS SHOWN IN THE PAVEMENT MARKING PLAN.

V) INSTALL TEMPORARY PAVEMENT MARKINGS AND TEMPORARY PAVEMENT MARKERS ON INTERIM LAYERS OF PAVEMENT AS FOLLOWS:

ROAD NAME	MARKING	MARKER
1. ALL ROADWAYS, DETOUR BRIDGE	PAINT	TEMPORARY RAISED
2. PROPOSED BRIDGE	COLD APPLIED PLASTIC TYPE IV (REM. TAPE)	TEMPORARY RAISED

W) PLACE ONE APPLICATION OF PAINT FOR TEMPORARY TRAFFIC PATTERNS. PLACE A SECOND APPLICATION OF PAINT SIX (6) MONTHS AFTER THE INITIAL APPLICATION AND EVERY SIX MONTHS AS DIRECTED BY THE ENGINEER.

X) TIE PROPOSED PAVEMENT MARKING LINES TO EXISTING PAVEMENT MARKING LINES.

Y) REMOVE/REPLACE ANY CONFLICTING/DAMAGED PAVEMENT MARKINGS AND MARKERS BY THE END OF EACH DAY'S OPERATION.



Z) TRACE THE (EXISTING AND/OR PROPOSED) MONOLITHIC ISLAND LOCATIONS WITH THE PROPER COLOR PAVEMENT MARKING PRIOR TO (REMOVAL AND/OR INSTALLATION). PLACE (DRUMS, CONES, OR TUBULAR MARKERS) TO DELINEATE ANY (EXISTING AND/OR PROPOSED) MONOLITHIC ISLANDS (AFTER REMOVAL AND/OR BEFORE INSTALLATION).

MISCELLANEOUS

AA) LAW ENFORCEMENT MAY BE USED TO MAINTAIN TRAFFIC THROUGH THE WORK AREA AND/OR INTERSECTIONS, AS DIRECTED BY THE ENGINEER.

BB) CONTRACTOR SHALL MAINTAIN SIDEWALK ACCESS AT ALL TIME AS STATED IN THE PHASING. CONTRACTOR SHALL BE RESPONSIBLE TO PROVIDE TEMPORARY SIDEWALKS (CONCRETE, ASPHALT, OR OTHER SUITABLE MATERIAL AS APPROVED BY THE ENGINEER) AT ALL LOCATIONS WHERE THE OPEN PEDESTRIAN TRAVELWAY HAS BEEN REMOVED FOR CONSTRUCTION OPERATIONS (UTILITIES, DRAINAGE, ETC.).

20-JUL-2011 10:04 AM C:\DOT\Projects\B\B4090\TrafficControl\TCP\B-4090-TMP-1.dgn kbroodwell AT TE244739

APPROVED: _____ DATE: _____			<h2 style="margin: 0;">GENERAL NOTES cont'd</h2>
-----------------------------	---	---	--

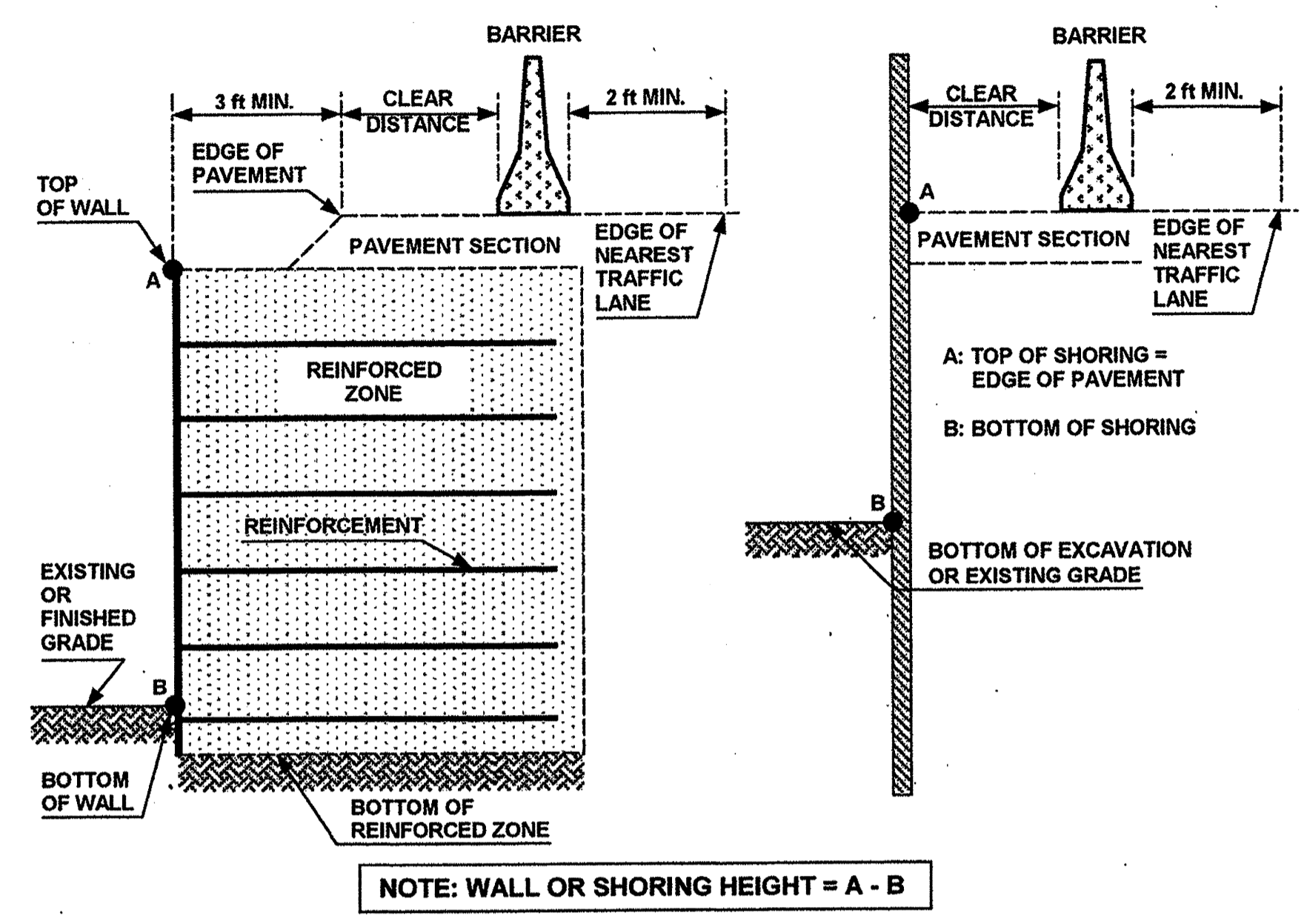

FIGURE A

NOTES

- 1- REFER TO THE TRAFFIC CONTROL PLANS FOR SHORING LOCATIONS AND SOIL PARAMETERS.
- 2- REFER TO THE "TEMPORARY SHORING" PROJECT SPECIAL PROVISION FOR MORE INFORMATION ABOUT TEMPORARY SHORING, MEASUREMENT AND PAYMENT.
- 3- PROVIDE PORTABLE CONCRETE BARRIER TO PROTECT TEMPORARY SHORING IF SHORING IS LOCATED WITHIN THE CLEAR ZONE AS DEFINED IN THE AASHTO ROADSIDE DESIGN GUIDE. DO NOT PLACE BARRIER DIRECTLY ON ANY SURFACE OTHER THAN ASPHALT OR CONCRETE. (CONTACT NCDOT PAVEMENT MANAGEMENT UNIT FOR APPLICABLE PAVEMENT DESIGN).
- 4- BASED ON THE CLEAR DISTANCE, OFFSET, DESIGN SPEED AND PAVEMENT TYPE, CHOOSE AN UNANCHORED PCB, ANCHORED PCB OR AN OREGON BARRIER FROM THE TABLE SHOWN IN FIGURE B. FOR TRAFFIC LANES AND PORTABLE CONCRETE BARRIER LOCATED ABOVE AND BEHIND TEMPORARY SHORING, THE FOLLOWING ARE DEFINED AS:

CLEAR DISTANCE - HORIZONTAL DISTANCE FROM THE BACK FACE OF THE BARRIER TO THE EDGE OF PAVEMENT FOR TEMPORARY MSE WALL OR TO THE FACE OF NON-ANCHORED TEMPORARY SHORING AS SHOWN IN FIGURE A.

OFFSET - HORIZONTAL DISTANCE FROM THE FRONT FACE OF THE BARRIER TO CENTERLINE OF THE FURTHEST TRAFFIC LANE AS SHOWN IN FIGURE B FOR 3 TRAFFIC LANES.
- 5- AT THE CONTRACTOR'S OPTION OR IF THE MINIMUM REQUIRED CLEAR DISTANCE IS NOT AVAILABLE, SET AN UNANCHORED PCB AGAINST THE TRAFFIC SIDE OF THE SHORING AND DESIGN SHORING FOR TRAFFIC IMPACT OR USE THE "SURCHARGE CASE WITH TRAFFIC IMPACT" FOR THE STANDARD TEMPORARY SHORING. DO NOT PLACE BARRIER DIRECTLY ON ANY SURFACE OTHER THAN ASPHALT OR CONCRETE. (CONTACT NCDOT PAVEMENT MANAGEMENT UNIT FOR APPLICABLE PAVEMENT DESIGN).
- 6- USE NCDOT PORTABLE CONCRETE BARRIER (PCB) IN ACCORDANCE WITH ROADWAY STANDARD DRAWING NO. 1170.01 AND SECTION 1170 OF THE STANDARD SPECIFICATIONS.
- 7- USE OREGON TALL F-SHAPE CONCRETE BARRIER IN ACCORDANCE WITH DETAIL DRAWING AND SPECIAL PROVISION OBTAINED FROM: WORK ZONE TRAFFIC CONTROL UNIT WEB PAGE.
- 8- UNLESS NOTED OTHERWISE ON THE PLANS, SET PORTABLE CONCRETE BARRIER WITH A MINIMUM DISTANCE OF 2 FT BETWEEN THE FRONT FACE OF THE BARRIER AND THE EDGE OF THE NEAREST TRAFFIC LANE AS SHOWN IN FIGURE A.
- 9- FOR PORTABLE CONCRETE BARRIER ABOVE AND BEHIND TEMPORARY MSE WALLS, PROVIDE A MINIMUM DISTANCE OF 3 FT BETWEEN THE EDGE OF PAVEMENT AND THE WALL FACE AS SHOWN IN FIGURE A. IF THESE MINIMUM REQUIRED DISTANCES ARE NOT AVAILABLE, CONTACT THE ENGINEER.
- 10- TABLE SHOWN IN FIGURE B IS BASED ON NCDOT RESEARCH PROJECT NO. 2005-010 WITH VEHICLE TYPE USED FOR NCHRP 350 CRASH TESTS. BARRIER DEFLECTIONS AND RESULTING MINIMUM REQUIRED CLEAR DISTANCES MIGHT VARY SIGNIFICANTLY FOR LARGER HEAVIER VEHICLES, RUNS OF BARRIER LESS THAN 200' IN LENGTH AND WET OR DRY PAVEMENT.

MINIMUM REQUIRED CLEAR DISTANCE, inches

Barrier Type	Pavement Type	Offset * ft	Design Speed, mph						
			<30	31-40	41-50	51-60	61-70	71-80	
Unanchored PCB	Asphalt	<8	24	26	29	32	36	40	
		8-14	26	28	31	35	38	42	
		14-20	27	29	34	36	39	43	
		20-26	28	31	35	38	40	44	
		26-32	29	32	36	39	42	45	
		32-38	30	34	38	41	43	46	
		38-44	31	34	41	43	45	48	
		44-50	31	35	41	43	46	49	
		50-56	32	36	42	44	47	50	
	>56	32	36	42	45	47	51		
	Concrete	<8	17	18	21	22	25	26	
		8-14	19	20	23	25	26	29	
		14-20	22	22	24	26	28	31	
		20-26	23	24	26	27	30	34	
		26-32	24	25	27	28	32	35	
		32-38	24	26	27	30	33	36	
		38-44	25	26	28	30	34	37	
		44-50	26	26	28	32	35	37	
50-56		26	26	28	32	35	38		
>56	26	27	29	32	36	38			
Anchored PCB or Oregon Barrier	Asphalt	All Offsets	24 for All Design Speeds						
Anchored PCB or Oregon Barrier	Concrete (including bridge approach slabs)	All Offsets	12 for All Design Speeds						

* See Figure Below

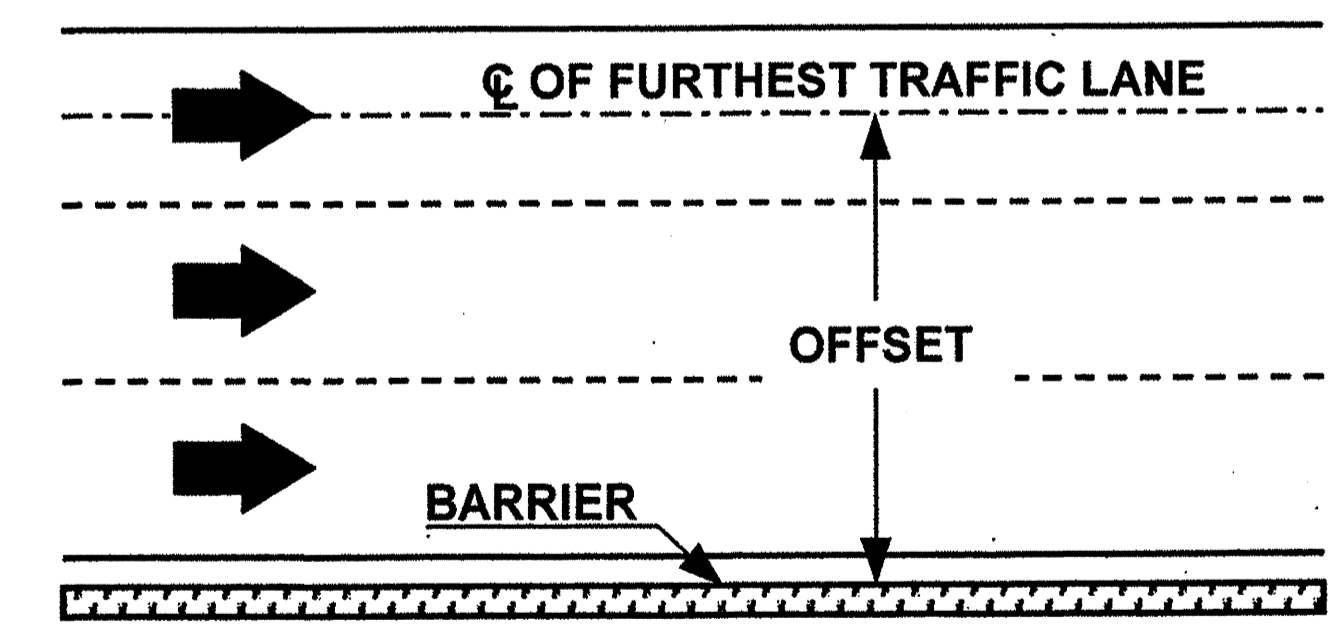

FIGURE B

APPROVED:	DATE:		PORTABLE CONCRETE BARRIER AT TEMPORARY SHORING LOCATIONS
	Sept 10, 2010		

TEMPORARY SHORING DATA

Temporary Shoring No. 1

FOR TEMPORARY SHORING, SEE TEMPORARY SHORING PROVISION.

DO NOT USE A TEMPORARY MSE WALL FROM -DET- STA. 14+40± 32 ft. ± RIGHT TO -DET- STA. 15+40 ± 32 ft. ± RIGHT.

DO NOT USE STANDARD SHORING FROM -DET- STA. 14+40± 32 ft. ± RIGHT TO -DET- STA. 15+40 ± 32 ft. ± RIGHT.

WHEN USING CONTRACTOR DESIGNED SHORING FROM -DET- STA. 14+40± 32 ft. ± RIGHT TO -DET- STA. 15+40 ± 32 ft. ± RIGHT. DESIGN SHORING FOR THE FOLLOWING IN-SITU ASSUMED SOIL PARAMETERS:

UNIT WEIGHT OF SOIL ABOVE WATER TABLE, γ = 120 pcf
 UNIT WEIGHT OF SOIL BELOW WATER TABLE, γ' = 60 pcf
 FRICTION ANGLE, ϕ = 30 DEGREES
 COHESION, c = 0 psf

FOR CONTRACTOR DESIGNED SHORING, SURVEY THE SHORING LOCATION TO DETERMINE EXISTING ELEVATIONS AND ACTUAL DESIGN HEIGHTS BEFORE BEGINNING DESIGN.

FOR PORTABLE CONCRETE BARRIERS ABOVE AND BEHIND TEMPORARY SHORING, USE AN NCDOT PORTABLE CONCRETE BARRIER (UNANCHORED OR ANCHORED) OR AN OREGON TALL F-SHAPE CONCRETE BARRIER IN ACCORDANCE WITH THE TRAFFIC CONTROL PLANS.

IT MAY BE PREFERRED OR NECESSARY TO ANCHOR TEMPORARY SHORING FROM -DET- STA. 14+40± 32 ft. ± RIGHT TO -DET- STA. 15+40 ± 32 ft. ± RIGHT. FOR ANCHORED TEMPORARY SHORING, SEE ANCHORED TEMPORARY SHORING PROVISION.

Temporary Shoring No. 2

FOR TEMPORARY SHORING, SEE TEMPORARY SHORING PROVISION.

DO NOT USE A TEMPORARY MSE WALL FROM -DET- STATION 16+65 +/-, 32 ft. RIGHT, TO -DET- STATION 17+45 +/-, 32 ft. RIGHT.

WHEN USING CONTRACTOR DESIGNED SHORING FROM *DET- STATION 16+65 +/-, 32 ft. RIGHT, TO -DET- STATION 17+45 +/-, 32 ft. RIGHT. DESIGN SHORING FOR THE FOLLOWING IN-SITU ASSUMED SOIL PARAMETERS:

UNIT WEIGHT OF SOIL ABOVE WATER TABLE, γ = 120 pcf
 UNIT WEIGHT OF SOIL BELOW WATER TABLE, γ' = 60 pcf
 FRICTION ANGLE, ϕ = 30 DEGREES
 COHESION, c = 0 psf

FOR CONTRACTOR DESIGNED SHORING, SURVEY THE SHORING LOCATION TO DETERMINE EXISTING ELEVATIONS AND ACTUAL DESIGN HEIGHTS BEFORE BEGINNING DESIGN.

FOR PORTABLE CONCRETE BARRIERS ABOVE AND BEHIND TEMPORARY SHORING, USE AN NCDOT PORTABLE CONCRETE BARRIER (UNANCHORED OR ANCHORED) OR AN OREGON TALL F-SHAPE CONCRETE BARRIER IN ACCORDANCE WITH THE TRAFFIC CONTROL PLANS.

21-SEP-2010 07:41
 K:\dot\cfr\101\Proj\TIP\Projects-B\B4090\TrafficControl\Tcp\B-4090-TMP-2B.dgn
 kbroodwell AT 1E244739

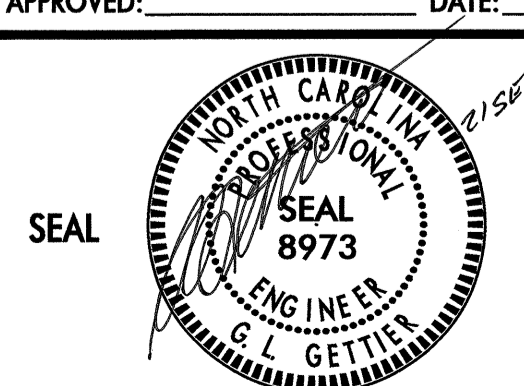
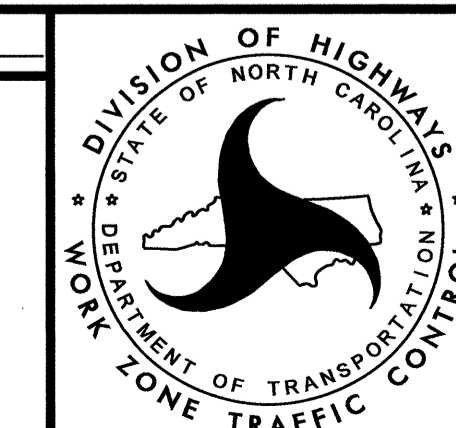
APPROVED: _____ DATE: _____ 		<h3>TEMPORARY SHORING DATA</h3>
--	---	---------------------------------

TWO-WAY UNDIVIDED ** (L-LINES)

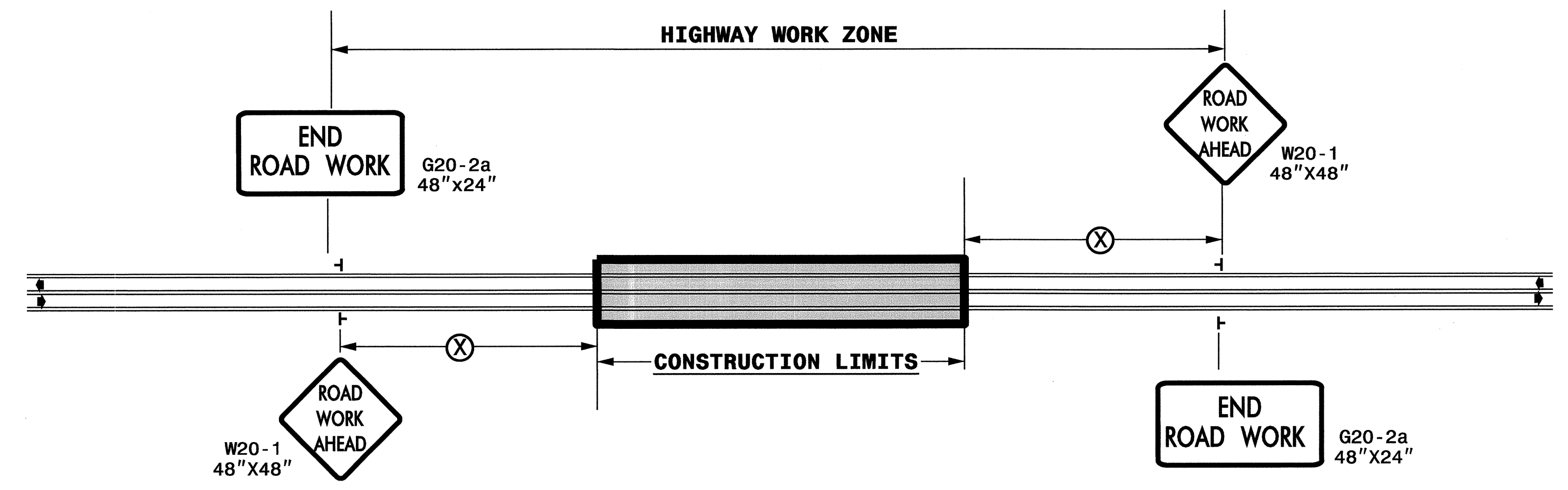

POSTED SPEED LIMIT (M.P.H.)	RECOMMENDED MINIMUM SIGN SPACING
≤ 50	500'
≥ 55	1000'

STATE OF NORTH CAROLINA
 DEPT. OF TRANSPORTATION
 DIVISION OF HIGHWAYS
 RALEIGH, N.C.

ROADWAYS INTERSECTING ALONG 2 WAY UNDIVIDED WORK ZONE (Y-LINES)

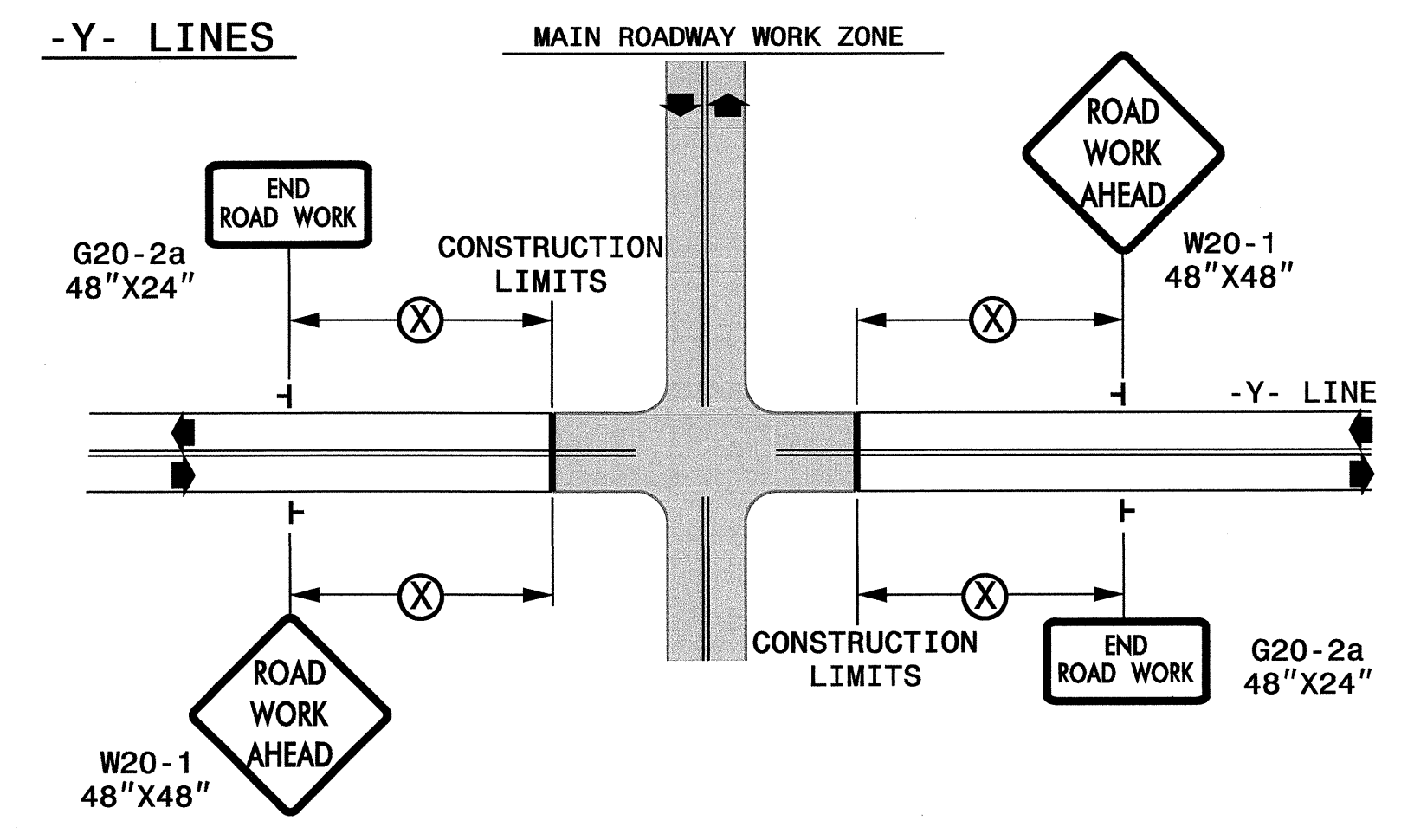

DETAIL DRAWING FOR
 TWO-WAY UNDIVIDED
 WORK ZONE WARNING SIGNS

GENERAL NOTES

- USE FLUORESCENT ORANGE SHEETING (TYPE VII OR HIGHER) ON ALL ADVANCED WORK ZONE SIGNS.
- DO NOT INSTALL ADVANCE WARNING SIGNS MORE THAN 3 DAYS PRIOR TO BEGINNING OF WORK.
- SIGNS SHOWN ARE REQUIRED FOR WORK ZONES THAT WILL REMAIN IN EFFECT OVERNIGHT. FOR SHORT-TERM DAILY MAINTENANCE TYPE OPERATIONS, THIS SIGNING APPLICATION IS OPTIONAL; MAY USE ONLY APPLICABLE ROADWAY STANDARD DRAWINGS INSTEAD. HOWEVER, IF THIS SIGNING APPLICATION IS USED, SIGNS MAY BE PORTABLE MOUNTED.
- ALL SIGN SPACING DIMENSIONS ARE APPROXIMATE, FIELD ADJUST AS NECESSARY OR AS DIRECTED.
- USE 3LB STEEL U-CHANNEL POST OR 4" X 4" WOOD POST FOR ALL WORK ZONE SIGNS. 3LB STEEL U-CHANNEL POSTS MUST MEET THE REQUIREMENTS OF STANDARD SPECIFICATION SECTION 1094-1(B), MAY BE GALVANIZED STEEL, OR MAY BE PAINTED GREEN BY THE POST MANUFACTURER. SQUARE STEEL TUBING POSTS HAVING EQUIVALENT STRENGTH OF THE 3 LB STEEL U-CHANNEL POST ARE ALSO ACCEPTABLE FOR USE. ERECT SIGNS PER ROADWAY STANDARD DRAWING 1110.01. PAYMENT FOR WOOD POSTS, 3LB STEEL U-CHANNEL AND SQUARE STEEL TUBING POSTS WITH SIGNS WILL BE MADE ACCORDING TO STANDARD SPECIFICATION "WORK ZONE SIGNS" SECTION 1110.
- WHEN NECESSARY, USE SPLICING IN ACCORDANCE WITH ROADWAY STANDARD DRAWING NO. 1110.01. REMOVE ENTIRE POST WHEN REMOVING SIGNS WITH SPLICED POSTS.
- DO NOT BACK BRACE SIGN SUPPORTS.
- ** TWO-WAY UNDIVIDED ADVANCE WARNING SIGN CONFIGURATION MAY BE USED ON URBAN MULTI-LANE FACILITIES WHERE CONDITIONS LIMIT THE USE OF DUAL MOUNTED SIGNS AS DETERMINED BY THE ENGINEER.

LEGEND

┆ STATIONARY SIGN

◀ DIRECTION OF TRAFFIC FLOW

APPROVED: _____ DATE: _____

SEAL

DETAIL DRAWING FOR TWO-WAY UNDIVIDED AND URBAN FREEWAYS
 WORK ZONE WARNING SIGNS

20-JUL-2011 10:01
 \\dot\dfsroot\01\Proj\TrafficControl\top\B-4090_TMP-2C.dgn
 kbroodwell AT TE244739

SIGN NUMBER: SP-1 TYPE: WZTC QUANTITY: 1 SIGN WIDTH: 2'-6" HEIGHT: 2'-0" TOTAL AREA: 5.0 Sq.Ft. BORDER TYPE: INSET RECESS: 0.38" WIDTH: 0.63" RADII: 1.5" NO. Z BARS: LENGTH:	BACKG COLOR: Fluorescent Orange COPY COLOR: Black SYMBOL X Y WID HT MAT'L: 0.080" (2.0 mm) ALUMINUM	DESIGN BY: D. PILLAR PROJECT ID: B-4090 CHECKED BY: A.I.A. DIV: 6 DATE: June 23, 2011
--	--	---

BORDER
R=1.5"
TH=0.63"
IN=0.38"

Spacing Factor is 1 unless specified otherwise

USE NOTES: 1,2
 1. Legend and border shall be direct applied black non-reflective sheeting.
 2. Background shall be Type VII, VIII, or IX (prismatic) fluorescent orange retroreflective sheeting.

LETTER POSITIONS

Letter locations are panel edge to lower left corner						Series/Size
R	O	A	D			Text Length
6.3	10.6	14.9	19.5			C 2000 16.6
C	O	N	S	T		C 2000
4.7	9.2	13.9	18.3	22.2		20.5

FILENAME: B_4090_SpecialSigns NORTH CAROLINA D.O.T. SIGN DETAIL

SIGN NUMBER: SP-2 TYPE: WZTC QUANTITY: 1 SIGN WIDTH: 4'-0" HEIGHT: 2'-0" TOTAL AREA: 8.0 Sq.Ft. BORDER TYPE: INSET RECESS: 0.38" WIDTH: 0.63" RADII: 1.5" NO. Z BARS: LENGTH:	BACKG COLOR: Fluorescent Orange COPY COLOR: Black SYMBOL X Y WID HT MAT'L: 0.080" (2.0 mm) ALUMINUM	DESIGN BY: D. PILLAR PROJECT ID: B-4090 CHECKED BY: A.I.A. DIV: 6 DATE: June 23, 2011
--	--	---

BORDER
R=1.5"
TH=0.63"
IN=0.38"

Spacing Factor is 1 unless specified otherwise

USE NOTES: 1,2
 1. Legend and border shall be direct applied black non-reflective sheeting.
 2. Background shall be Type VII, VIII, or IX (prismatic) fluorescent orange retroreflective sheeting.

LETTER POSITIONS

Letter locations are panel edge to lower left corner										Series/Size
A	L	T	R	O	U	T	E			Text Length
5.3	10	13.4	16.5	22.5	26.8	31.5	35.7	39.6		C 2000 37.3
A	H	E	A	D						C 2000
13.6	18.3	23	26.6	31.3						21

FILENAME: B_4090_SpecialSigns NORTH CAROLINA D.O.T. SIGN DETAIL

20-JUL-2011 11:45 AM
 C:\Users\kdr\Documents\Projects\B4090\TrafficControl\B-4090_TMP-2D.dgn
 kdr\cagwell AT TEL44739

APPROVED: _____ DATE: _____			SPECIAL SIGN DESIGNS

PHASING

PHASE I

- STEP 1: - CONTRACTOR SHALL PLACE "ROAD WORK AHEAD" AND "END ROAD WORK" SIGNS AS SHOWN ON SHEET TMP-2C.
- CONTRACTOR SHALL PLACE ALTERNATE ROUTE SIGNAGE AS SHOWN ON SHEET TMP-12 AND TMP-2D.
- STEP 2: - CONTRACTOR SHALL PLACE TYPE III BARRICADES TO CLOSE DRIVEWAY TO THE CITY OF FAYETTEVILLE'S MAINTENANCE FACILITY AS SHOWN ON SHEET TMP-4.
- CONTRACTOR SHALL USE LANE CLOSURES PER RSD 1101.02 SHEETS 1, 3, 4 & 5:
 - INSTALL DRUMS, SIGNAGE, BARRICADES AND TEMPORARY PAVEMENT MARKINGS AND TEMPORARY PAVEMENT MARKERS TO CONVERT THE OUTSIDE LANES TO TURN LANES THEN PLACE TRAFFIC INTO A FOUR-LANE, TWO-WAY TRAFFIC PATTERN AS SHOWN ON SHEETS TMP-4 AND TMP-5.
 - INSTALL SIGNAGE AND RIGHT TURN ARROWS TO PROHIBIT LEFT TURNS ONTO -L- FROM N. COOLSPRING ROAD AND HAWLEY LANE AS SHOWN ON SHEET TMP-4.
 - INSTALL PCB/CRASH CUSHIONS AS SHOWN ON SHEET TMP-4.
 - INSTALL TEMPORARY HIGH VISIBILITY CROSSWALK PAVEMENT MARKINGS AND ASSOCIATED ADVANCE SIGNAGE AS SHOWN ON SHEET TMP-5.
 - INSTALL BARRICADES AND SIGNAGE AND DETOUR PEDESTRIANS TO THE SOUTH SIDEWALK AS SHOWN ON SHEETS TMP-4 AND TMP-5.
- STEP 3: - CONTRACTOR, AWAY FROM TRAFFIC, SHALL CONSTRUCT THE DETOUR BRIDGE AND APPROACHES AS SHOWN ON SHEET TMP-4 AND THE CONSTRUCTION PLANS.
- CONTRACTOR, AWAY FROM TRAFFIC, MAY BEGIN INSTALLATION OF PCB/CRASH CUSHIONS AS SHOWN ON SHEET TMP-6.

PHASE II

CONTRACTOR SHALL WORK IN A CONTINUOUS MANNER TO COMPLETE PHASE II, STEP 1.

- STEP 1: - CONTRACTOR SHALL, AWAY FROM TRAFFIC AND USING LANE CLOSURES PER RSD 1101.02, SHEETS 3, 4 & 5, INSTALL TEMPORARY PAVEMENT MARKINGS AND TEMPORARY PAVEMENT MARKERS, SIGNAGE, PCB/CRASH CUSHIONS, BARRICADES, AND DRUMS THEN PLACE TRAFFIC ONTO THE ON-SITE DETOUR IN A FOUR-LANE, TWO-WAY PATTERN AS SHOWN ON SHEET TMP-6.

NOTE: THE CONTRACTOR SHALL ENSURE THAT THE PCB ON THE SOUTH SIDE OF THE DETOUR IS TIED INTO THE TEMPORARY BRIDGE RAILS IN A MANNER THAT MEETS NCHRP 350 REQUIREMENTS OR UTILIZE PCB (ANCHORED) AS THE TEMPORARY BRIDGE RAIL AS DIRECTED BY THE ENGINEER.

- CONTRACTOR SHALL INSTALL BARRICADES AND SIGNAGE AND DETOUR PEDESTRIANS TO THE NORTH SIDEWALK AND ON THE NORTH SIDE OF THE DETOUR AS SHOWN ON SHEETS TMP-6 AND TMP-7.
- STEP 2: - CONTRACTOR, AWAY FROM TRAFFIC, SHALL DEMO THE EXISTING BRIDGE AND CONSTRUCT THE PROPOSED BRIDGE AND APPROACHES UP TO BUT NOT INCLUDING THE FINAL LAYER OF SURFACE COURSE AS SHOWN ON SHEET TMP-6 AND THE CONSTRUCTION PLANS.
- CONTRACTOR, AWAY FROM TRAFFIC, MAY BEGIN INSTALLATION OF PCB AS SHOWN ON SHEET TMP-8.

PHASE III

CONTRACTOR SHALL WORK IN A CONTINUOUS MANNER TO COMPLETE PHASE III, STEP 1.

- STEP 1: - CONTRACTOR SHALL, AWAY FROM TRAFFIC AND USING LANE CLOSURES PER RSD 1101.02 SHEETS 3, 5 & 5, INSTALL TEMPORARY PAVEMENT MARKINGS AND TEMPORARY PAVEMENT MARKERS, SIGNAGE, PCB/CRASH CUSHIONS, BARRICADES, AND DRUMS THEN PLACE TRAFFIC ONTO THE PROPOSED BRIDGE IN A FOUR-LANE, TWO-WAY PATTERN AS SHOWN ON SHEET TMP-8.
- CONTRACTOR SHALL INSTALL BARRICADES AND SIGNAGE AND DETOUR PEDESTRIANS TO THE SOUTH SIDEWALK AND ON THE PROPOSED BRIDGE AS SHOWN ON SHEETS TMP-8 AND TMP-9.
- STEP 2: - CONTRACTOR, AWAY FROM TRAFFIC, SHALL DEMO THE DETOUR BRIDGE AND COMPLETE CONSTRUCTION ON THE NORTH SIDE OF THE PROPOSED BRIDGE AS SHOWN ON SHEET TMP-8 AND THE CONSTRUCTION PLANS.

PHASE IV

CONTRACTOR SHALL WORK IN A CONTINUOUS MANNER TO COMPLETE PHASE IV, STEP 1.

- STEP 1: - CONTRACTOR SHALL USING LANE CLOSURES PER RSD 1101.02, SHEETS 3, 4 & 5, REMOVE PCB/CRASH CUSHIONS, INSTALL TEMPORARY PAVEMENT MARKINGS AND TEMPORARY RAISED PAVEMENT MARKERS, DRUMS, AND PROPOSED NEW SIGNAGE THEN PLACE TRAFFIC IN THE OUTSIDE TWO LANES IN EACH DIRECTION IN A FOUR-LANE, TWO-WAY DIVIDED PATTERN AS SHOWN ON SHEET TMP-10.
- STEP 2: - CONTRACTOR SHALL, BEHIND DRUMS AND USING LANE CLOSURES PER RSD 1101.02, SHEETS 3, 4 & 5, CONSTRUCT PROPOSED MONOLITHIC CONCRETE ISLAND AS SHOWN ON SHEET TMP-10 AND THE CONSTRUCTION PLANS.
- STEP 3: - CONTRACTOR SHALL USE LANE CLOSURES PER RSD 1101.02, SHEETS 1, 3, 4 & 5:
 - PLACE THE FINAL LAYER OF SURFACE COURSE, INSTALL FINAL PAVEMENT MARKINGS AND FINAL PAVEMENT MARKERS AS SHOWN ON THE FINAL PAVEMENT MARKING PLANS.
 - REMOVE TEMPORARY PAVEMENT MARKINGS/MARKERS FOR RIGHT TURN DROP LANES ON -L- AND RIGHT ARROWS ON N. COOLSPRING ROAD AND HAWLEY LANE AND REMOVE ASSOCIATED SIGNS FOR TEMPORARY PATTERNS.
 - REMOVE ALL REMAINING TRAFFIC CONTROL DEVICES (INCLUDING ALTERNATE ROUTE SIGNAGE), AND OPEN TO THE FINAL TRAFFIC PATTERN.

PCB NOTES:

1. THE PHASING ABOVE GENERALLY SPECIFIES PCB INSTALLATION. SEE THE TMP PLAN SHEETS FOR LIMITS OF PORTABLE CONCRETE BARRIER, PORTABLE CONCRETE BARRIER (ANCHORED), PORTABLE CONCRETE BARRIER (DRAINAGE), RESET PORTABLE CONCRETE BARRIER, RESET PORTABLE CONCRETE BARRIER (DRAINAGE), TEMPORARY CRASH CUSHION AND RESET TEMPORARY CRASH CUSHION.
2. ANCHORED PCB THAT IS RESET "UNANCHORED" SHALL BE PAID FOR AS RESET PCB.

20-JUL-2011 05:57:40 \\N:\Projects\B\4090\TrafficControl\B-4090-TMP-3.dgn
KorOodwell AT 12:47:39

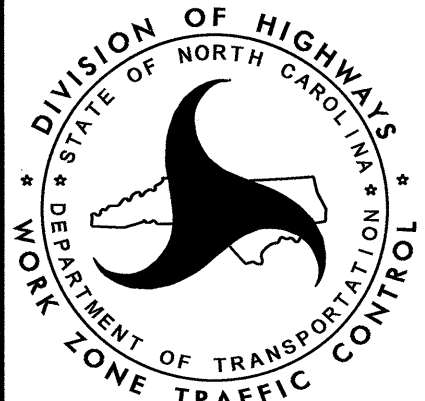
APPROVED: _____	DATE: _____			<h2 style="margin: 0;">PHASING</h2>
-----------------	-------------	---	---	-------------------------------------

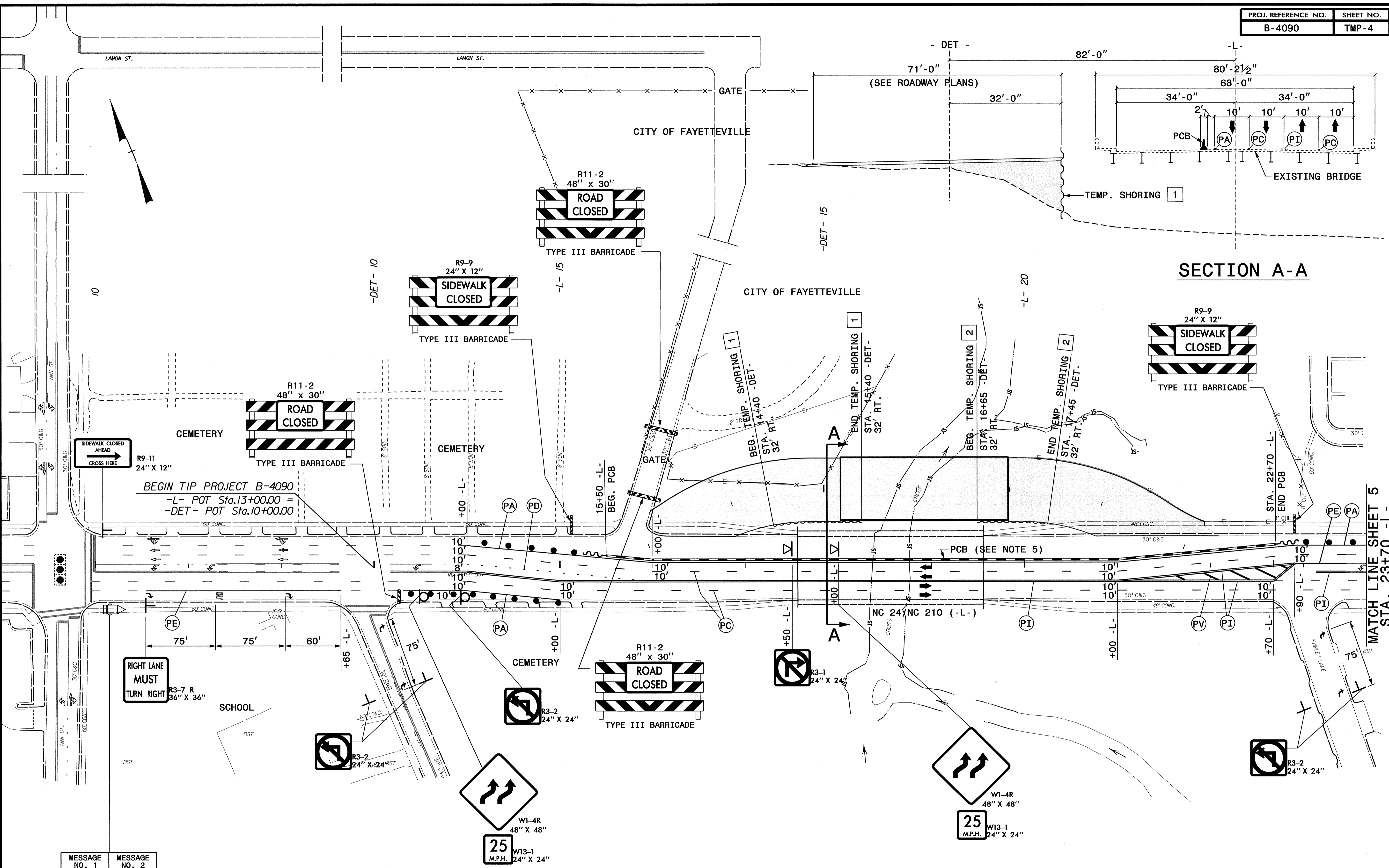

SECTION A-A

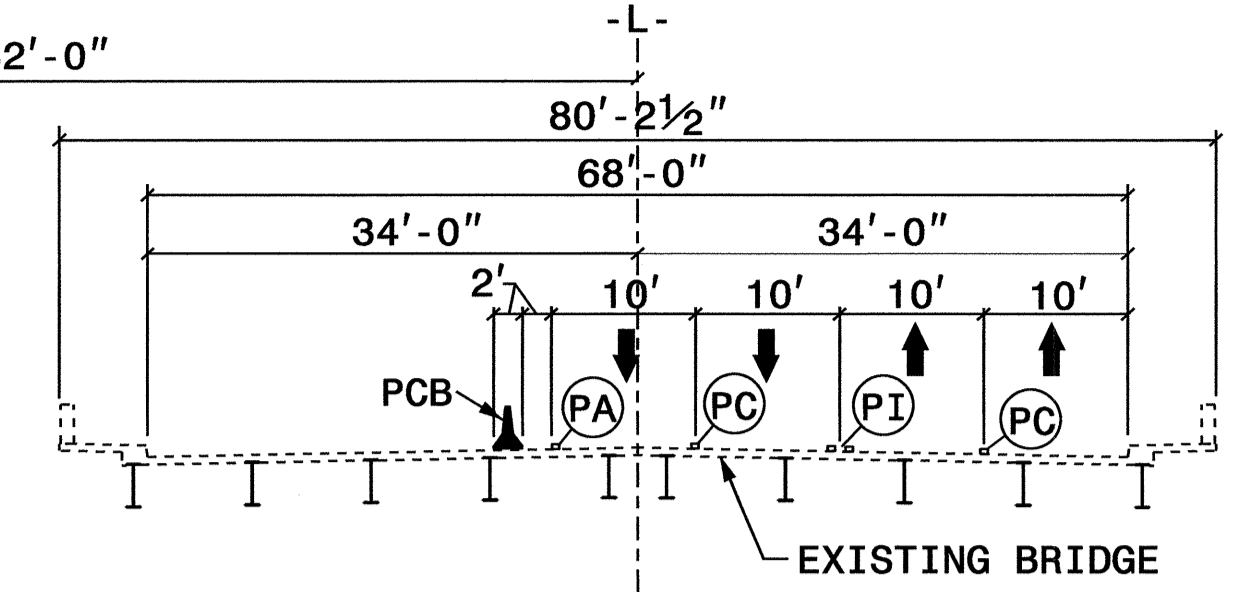

MESSAGE NO. 1	MESSAGE NO. 2
NEW TRAFFIC PATTERN	RT LANE MUST TURN RT
CHANGEABLE MESSAGE SIGN (LOCATE AS DIRECTED BY THE ENGINEER)	

- NOTES:**
- ALL STATIONS AND DIMENSIONS ARE APPROXIMATE AND MAY BE ADJUSTED AS DIRECTED BY THE ENGINEER.
 - SEE SHEET TMP-1A FOR THE TEMPORARY PAVEMENT MARKING SCHEDULE.
 - ☐ - SEE SHEET TMP-2B FOR TEMP. SHORING DATA.
 - RELOCATE EXISTING SIGNS AS DIRECTED BY THE ENGINEER.
 - INSTALL PCB (DRAINAGE) AS REQUIRED.

APPROVED: _____ DATE: _____

SEAL

PHASE I DETAILS

20-JUL-2011 10:56
 \\dot\dfs000\Proj\TIP\Projects-B\B4090\TrafficControl\Tcb\B-4090-TMP-4.dgn
 KBRoadwell AT 12:44:39

MATCH LINE SHEET 5
 STA. 23+70 -L-

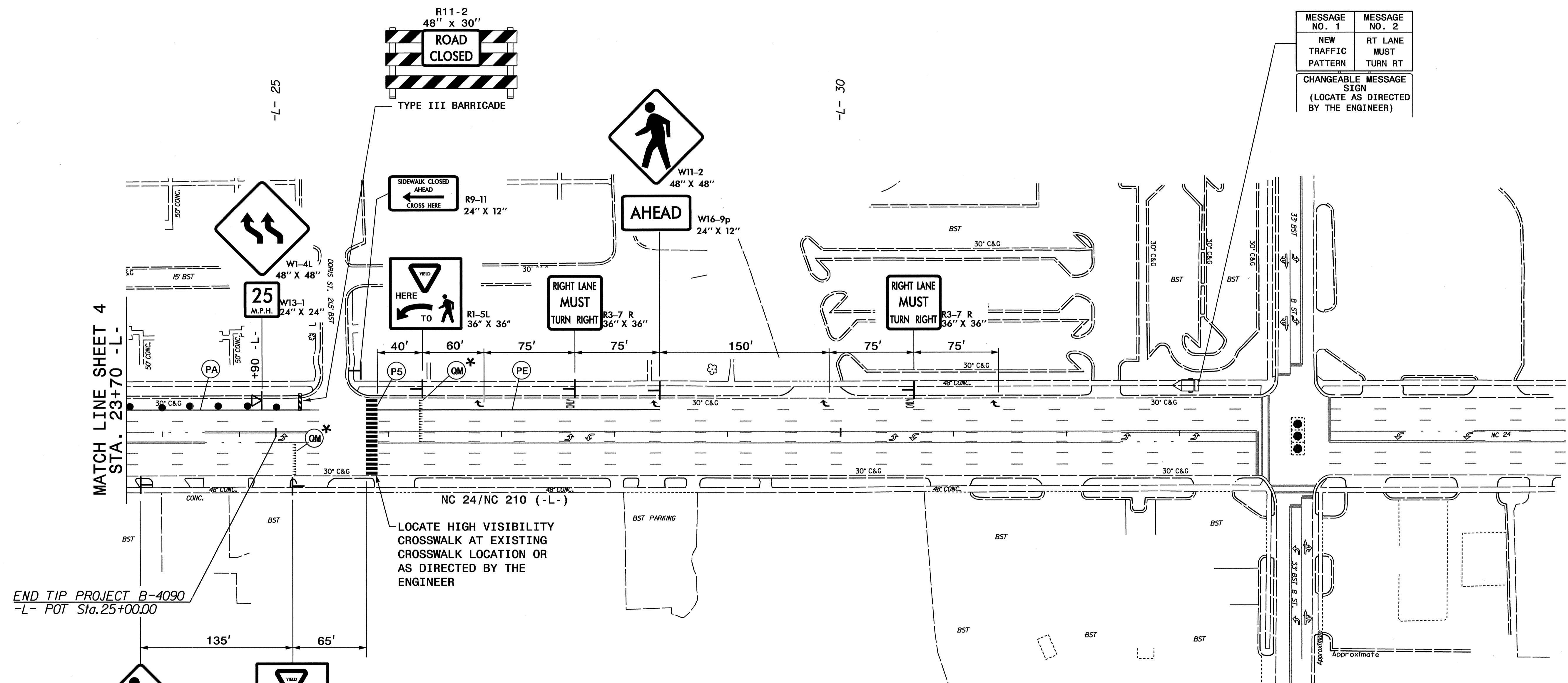

END TIP PROJECT B-4090
-L- POT Sta. 25+00.00

MATCH LINE SHEET 4
STA. 23+70 -L-

LOCATE HIGH VISIBILITY CROSSWALK AT EXISTING CROSSWALK LOCATION OR AS DIRECTED BY THE ENGINEER

- NOTES:
1. ALL STATIONS AND DIMENSIONS ARE APPROXIMATE AND MAY BE ADJUSTED AS DIRECTED BY THE ENGINEER.
 2. SEE SHEET TMP-1A FOR THE TEMPORARY PAVEMENT MARKING SCHEDULE.

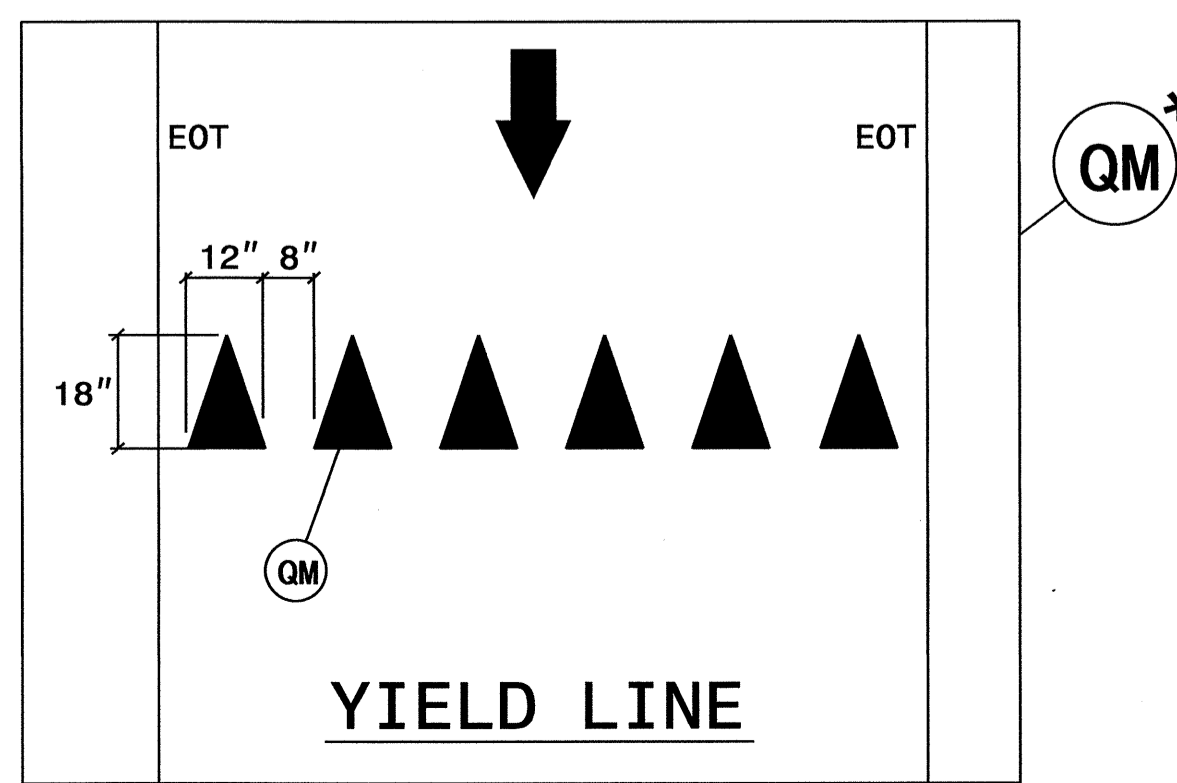

APPROVED: _____ DATE: _____		<p>PHASE I DETAILS</p>

20-JUL-2011 05:55
 C:\Users\kbr\Documents\Projects\B-4090\TrafficControl\cp\B-4090-TMP-5.dgn
 kbr\oadwell AT TEL244733

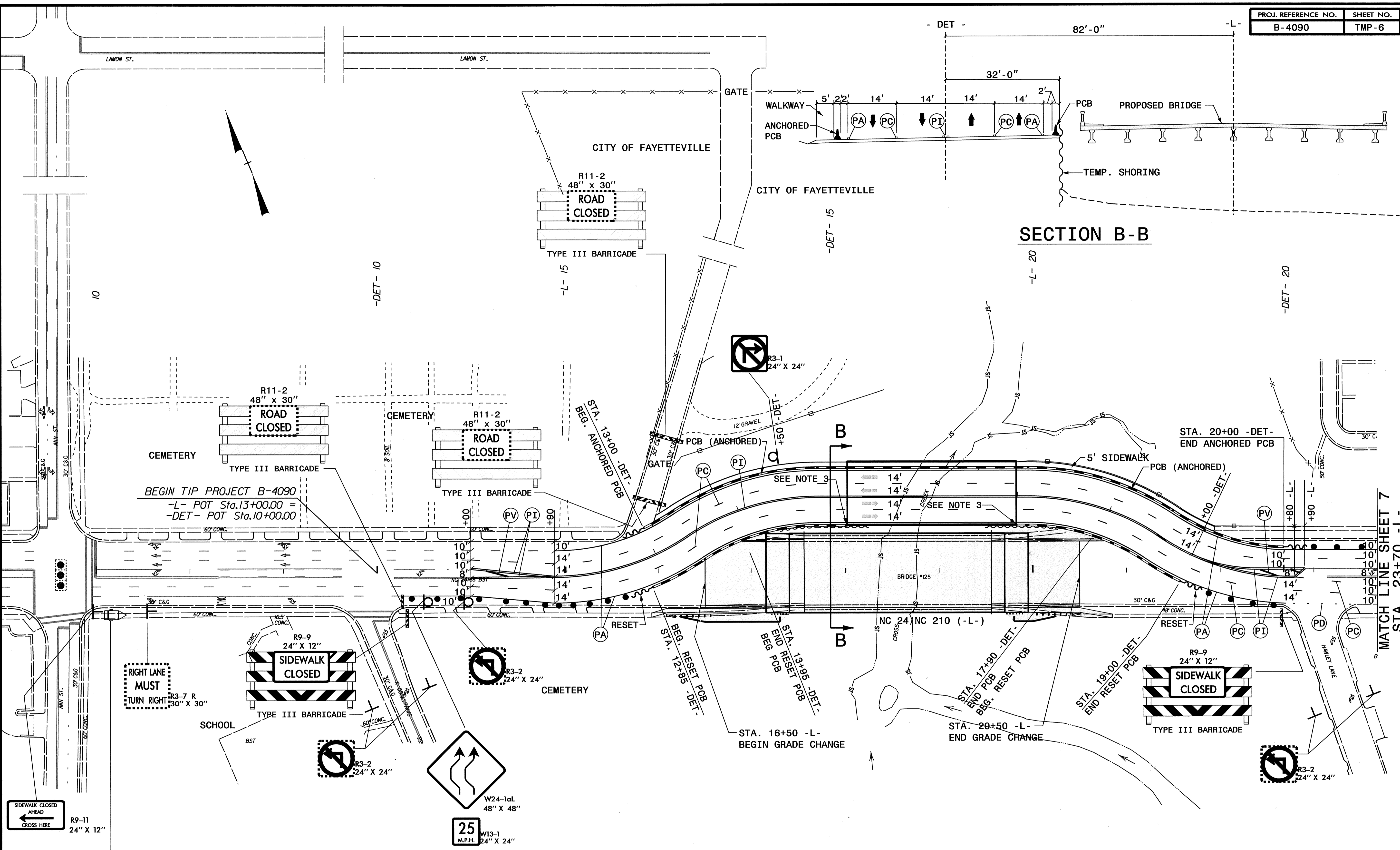

SECTION B-B

BEGIN TIP PROJECT B-4090
 -L- POT Sta. 13+00.00 =
 -DET- POT Sta. 10+00.00

RIGHT LANE
 MUST
 TURN RIGHT
 R3-7 R
 30" X 30"

SIDEWALK CLOSED
 AHEAD
 CROSS HERE
 R9-11
 24" X 12"

MESSAGE NO. 1
 NEW TRAFFIC PATTERN
 CHANGEABLE MESSAGE SIGN
 (LOCATE AS DIRECTED BY THE ENGINEER)

MESSAGE NO. 2
 RT LANE MUST TURN RT
 (LOCATE AS DIRECTED BY THE ENGINEER)

- NOTES:**
1. ALL STATIONS AND DIMENSIONS ARE APPROXIMATE AND MAY BE ADJUSTED AS DIRECTED BY THE ENGINEER.
 2. SEE SHEET TMP-1A FOR THE TEMPORARY PAVEMENT MARKING SCHEDULE.
 3. THE METHOD OF PCB ATTACHMENT TO THE TEMPORARY BRIDGE'S RAIL SHALL BE APPROVED BY THE ENGINEER.
 4. RELOCATE EXISTING SIGNS AS DIRECTED BY THE ENGINEER.

APPROVED: _____ DATE: _____

SEAL

PHASE II DETAILS

20-JUL-2011 10:53
 C:\dot\des\01\Proj\TIP\Projects-B\B4090\TrafficControl\cp\B-4090-TMP-6.dgn
 KBroodwell AT 12244739

MATCH LINE SHEET 7
 STA. 23+70 -L-

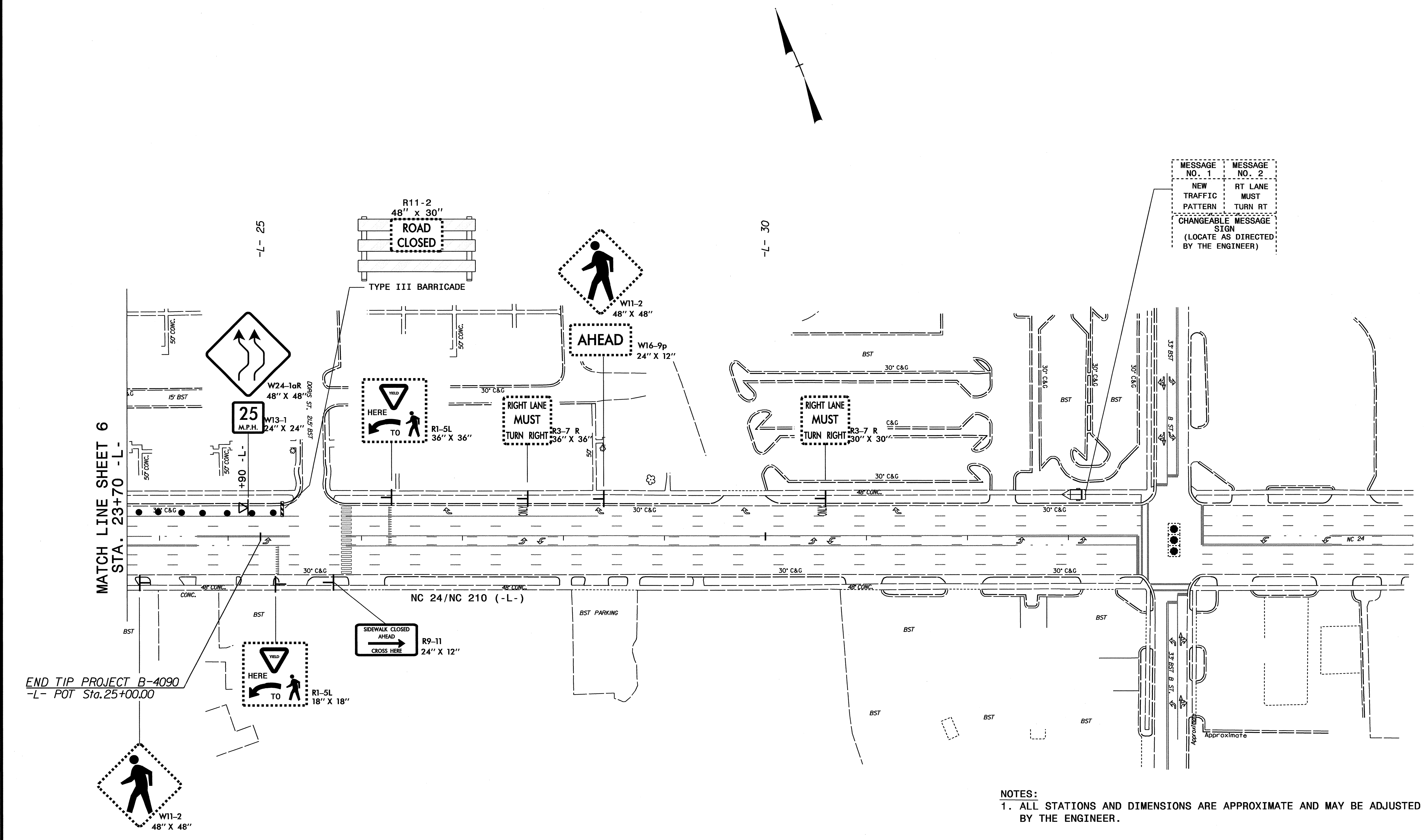

MESSAGE NO. 1	MESSAGE NO. 2
NEW TRAFFIC PATTERN	RT LANE MUST TURN RT
CHANGEABLE MESSAGE SIGN (LOCATE AS DIRECTED BY THE ENGINEER)	

NOTES:
1. ALL STATIONS AND DIMENSIONS ARE APPROXIMATE AND MAY BE ADJUSTED AS DIRECTED BY THE ENGINEER.

APPROVED: _____ DATE: _____		<p>PHASE II DETAILS</p>

20-JUL-2011 10:59 AM
 C:\Users\kdc\Documents\Projects\B-4090\TrafficControl\Tcpl\B-4090-TMP-7.dgn
 KDC\GAWH AT TEL44739

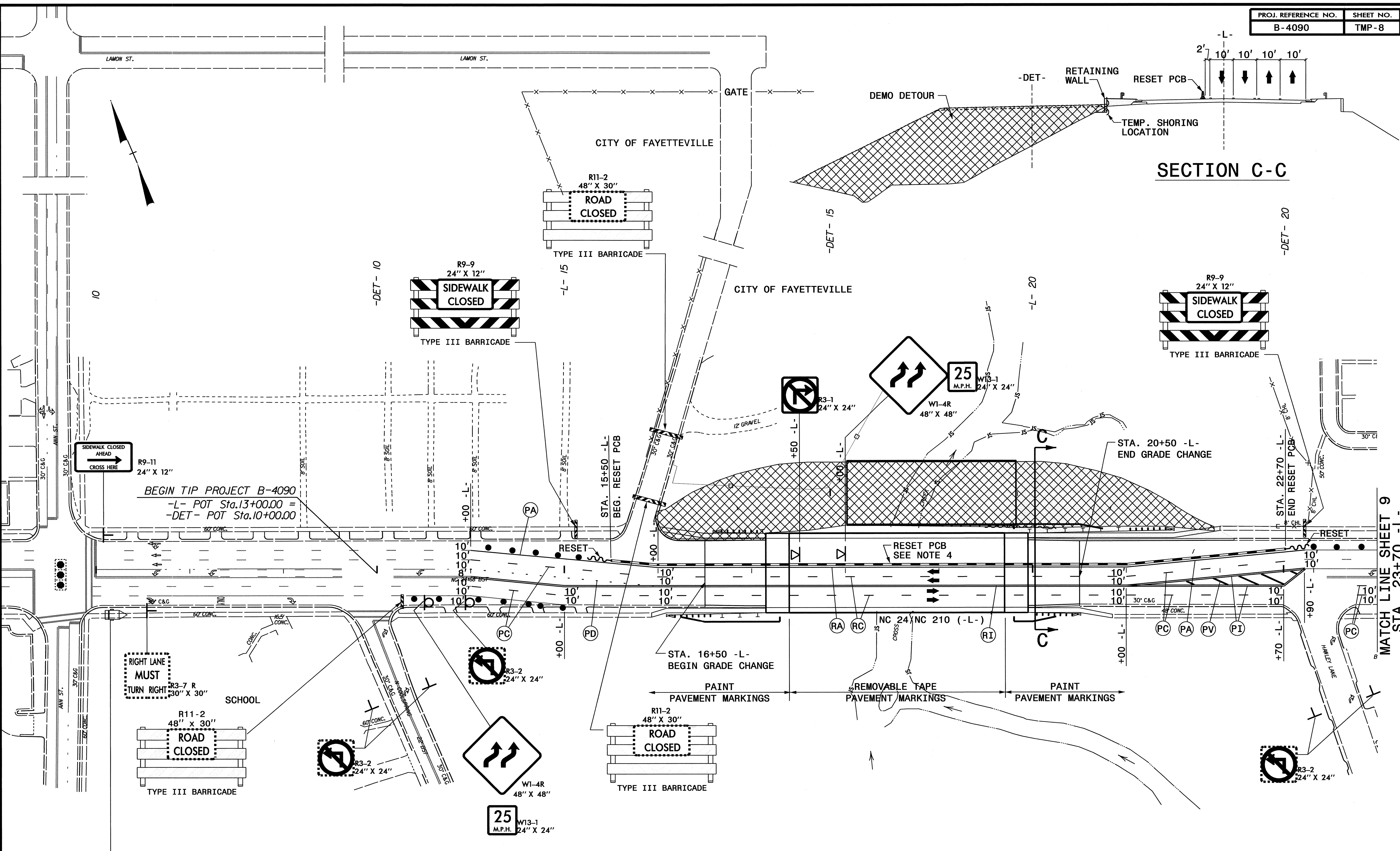

BEGIN TIP PROJECT B-4090
 -L- POT Sta. 13+00.00 =
 -DET- POT Sta. 10+00.00

RIGHT LANE
 MUST
 TURN RIGHT
 R3-7 R
 30" X 30"

R11-2
 48" X 30"
 ROAD
 CLOSED

R11-2
 48" X 30"
 ROAD
 CLOSED

MESSAGE NO. 1	MESSAGE NO. 2
NEW TRAFFIC PATTERN	RT LANE MUST TURN RT
CHANGEABLE MESSAGE SIGN (LOCATE AS DIRECTED BY THE ENGINEER)	

- NOTES:**
1. ALL STATIONS AND DIMENSIONS ARE APPROXIMATE AND MAY BE ADJUSTED AS DIRECTED BY THE ENGINEER.
 2. SEE SHEET TMP-1A FOR THE TEMPORARY PAVEMENT MARKING SCHEDULE.
 3. RELOCATE EXISTING SIGNS AS DIRECTED BY THE ENGINEER.
 4. RESET PCB (DRAINAGE) AS REQUIRED.

APPROVED: _____ DATE: _____			<p>PHASE III DETAILS</p>
SEAL			

20-JUL-2011 10:51
 C:\dot\des\c040\Proj\TIP\Projects-B\B4090\TrafficControl\top\B-4090-TMP-8.dgn
 KBRoadwell AT TE244739

MATCH LINE SHEET 9
 STA. 23+70 -L-

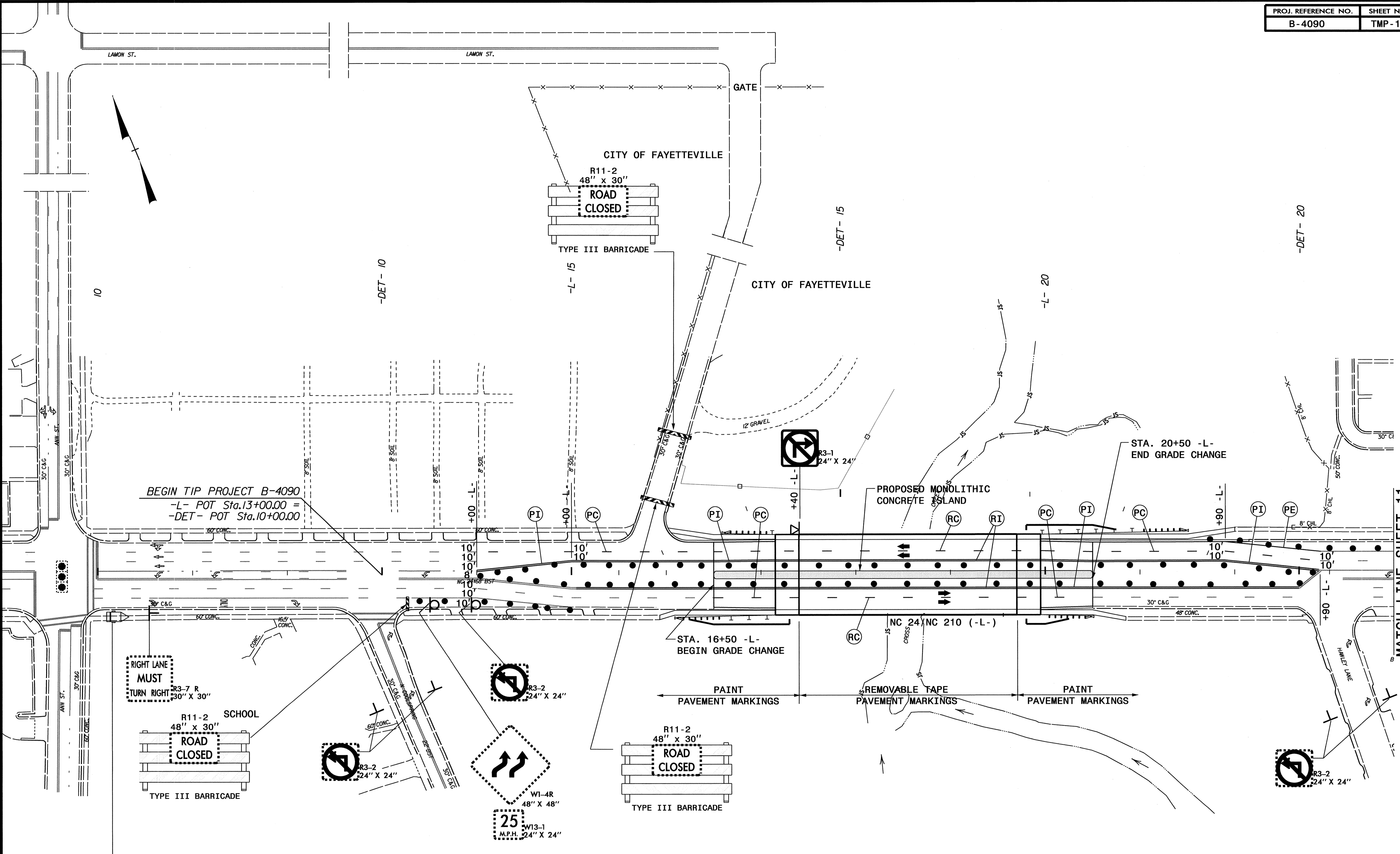

BEGIN TIP PROJECT B-4090
 -L- POT Sta. 13+00.00 =
 -DET- POT Sta. 10+00.00

RIGHT LANE
 MUST
 TURN RIGHT
 R3-7 R
 30" X 30"

R11-2
 48" X 30"
 ROAD
 CLOSED
 TYPE III BARRICADE

SCHOOL

R3-2
 24" X 24"

W1-4R
 48" X 48"
 25
 W13-1
 M.P.H. 24" X 24"

R11-2
 48" X 30"
 ROAD
 CLOSED
 TYPE III BARRICADE

STA. 16+50 -L-
 BEGIN GRADE CHANGE

NC 24 / NC 210 (-L-)

STA. 20+50 -L-
 END GRADE CHANGE

MATCH LINE SHEET 11
 STA. 23+70 -L-

MESSAGE NO. 1	MESSAGE NO. 2
NEW TRAFFIC PATTERN	RT LANE MUST TURN RT
CHANGEABLE MESSAGE SIGN (LOCATE AS DIRECTED BY THE ENGINEER)	

- NOTES:**
- ALL STATIONS AND DIMENSIONS ARE APPROXIMATE AND MAY BE ADJUSTED AS DIRECTED BY THE ENGINEER.
 - SEE SHEET TMP-1A FOR THE TEMPORARY PAVEMENT MARKING SCHEDULE.
 - RELOCATE EXISTING SIGNS, OR PLACE NEW FINAL SIGNS, AS DIRECTED BY THE ENGINEER.

APPROVED: _____ DATE: _____

SEAL

PHASE IV DETAILS

20-JUL-2011 04:46
 K:\CADD\Projects\TrafficControl\B-4090\TrafficControl\B-4090-TMP-10.dgn
 kbroodwell AT TEL244739

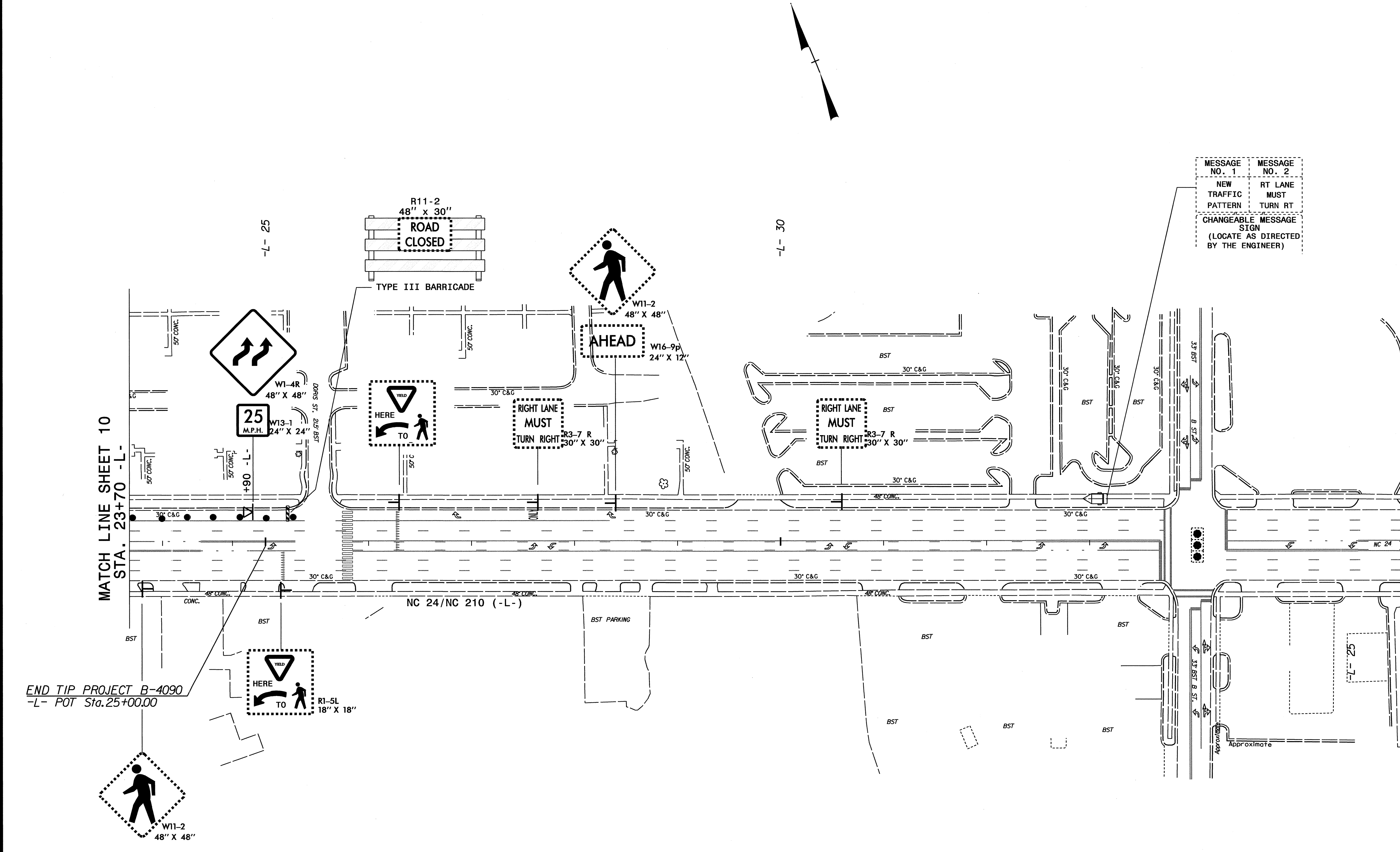

MESSAGE NO. 1	MESSAGE NO. 2
NEW TRAFFIC PATTERN	RT LANE MUST TURN RT
CHANGEABLE MESSAGE SIGN (LOCATE AS DIRECTED BY THE ENGINEER)	

20-JUL-2011 10:45
 \\dot\cfe\p\proj\TIP\Projects-B\B4090\TrafficControl\top\B-4090_TMP-11.dgn
 KBOGOWELL, A. | TE244739

END TIP PROJECT B-4090
-L- POT Sta. 25+00.00

APPROVED: _____	DATE: 20 JUL 11		PHASE IV DETAILS

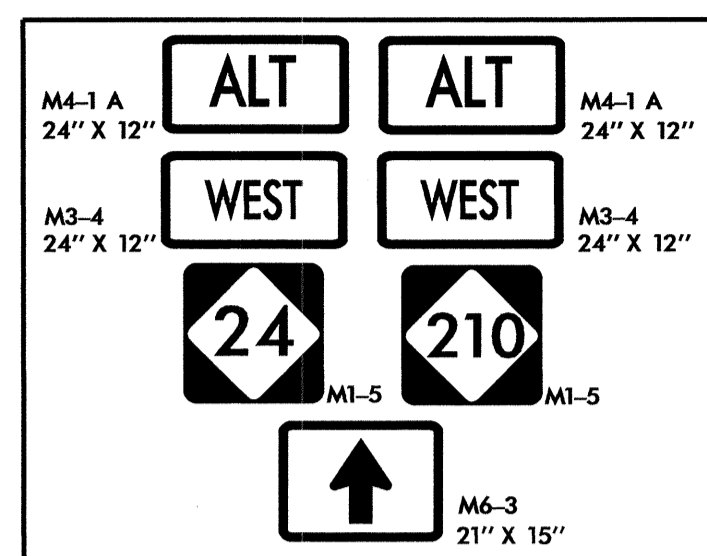

SIGN ①

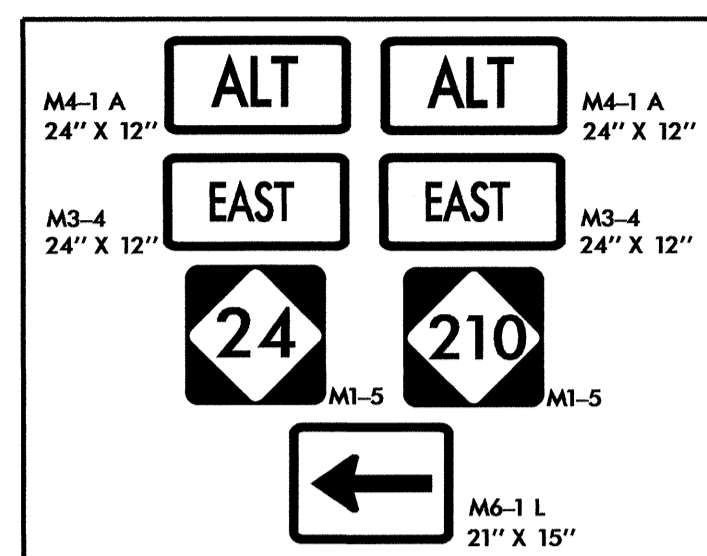

SIGN ⑥

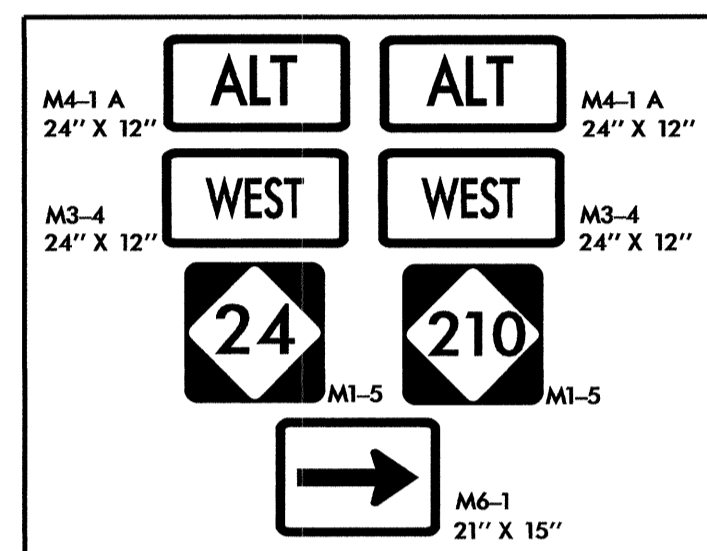

SIGN ②

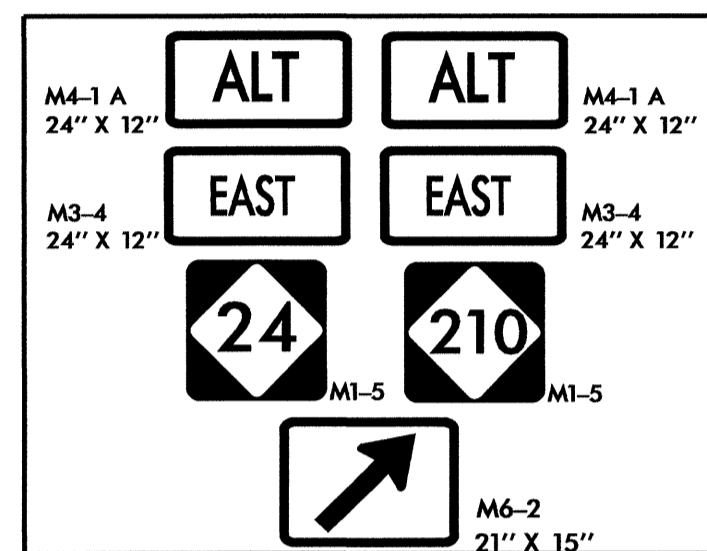

SIGN ⑦

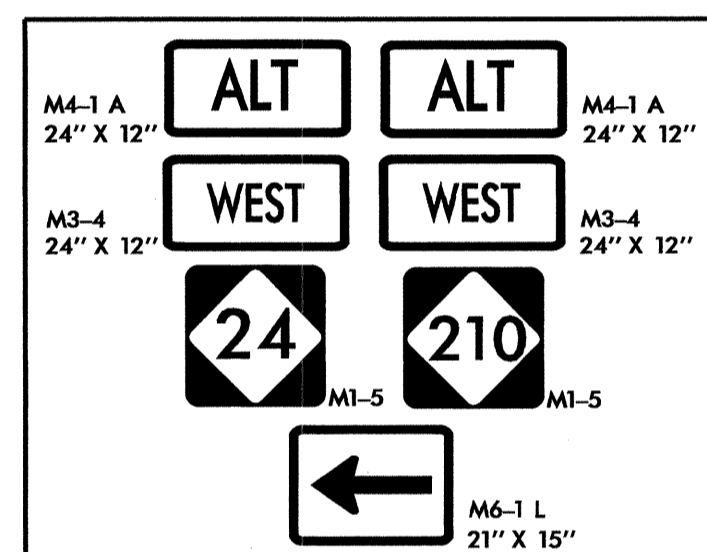

SIGN ③

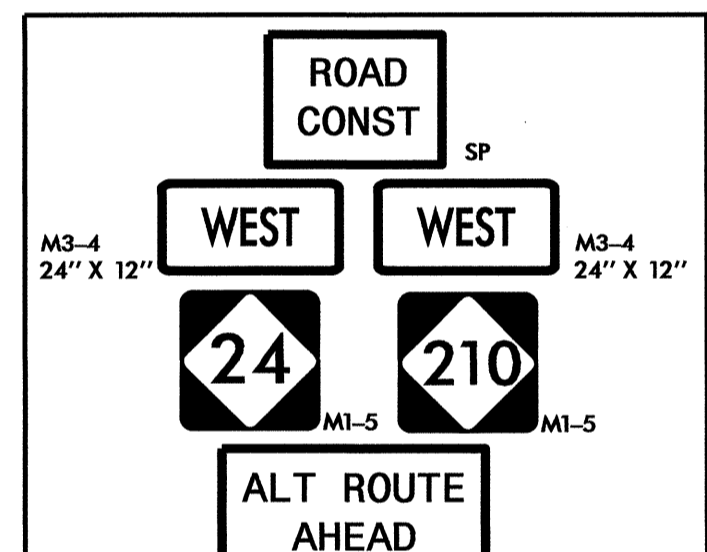

SIGN ⑧

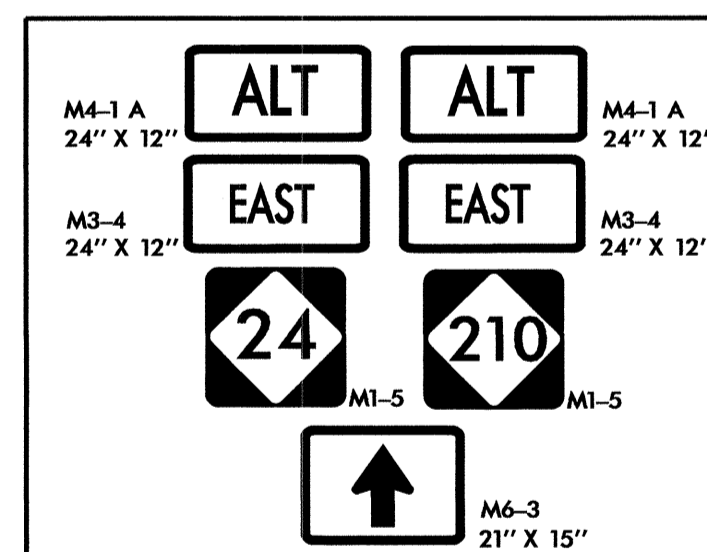

SIGN ④

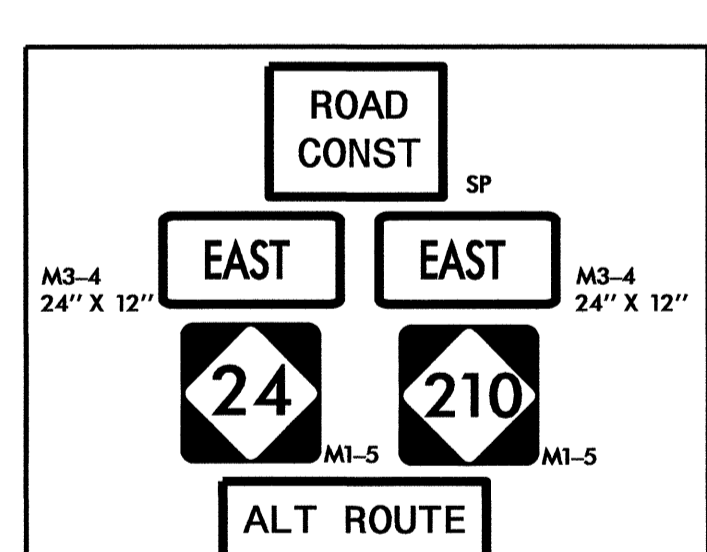

SIGN ⑨

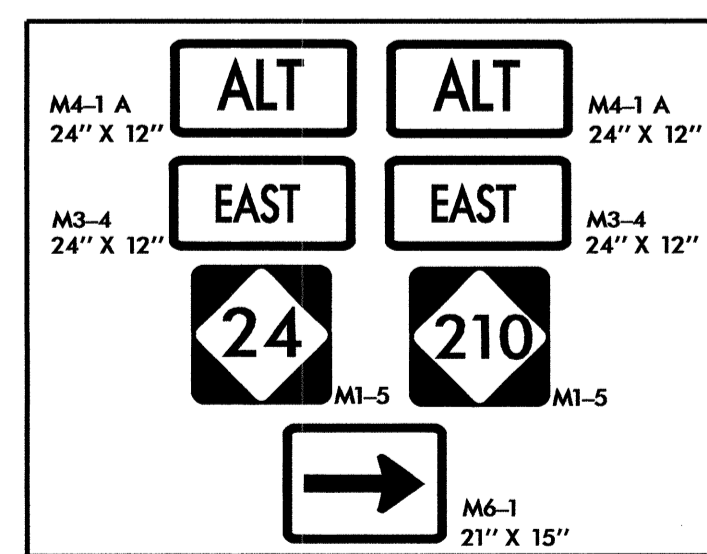

SIGN ⑤

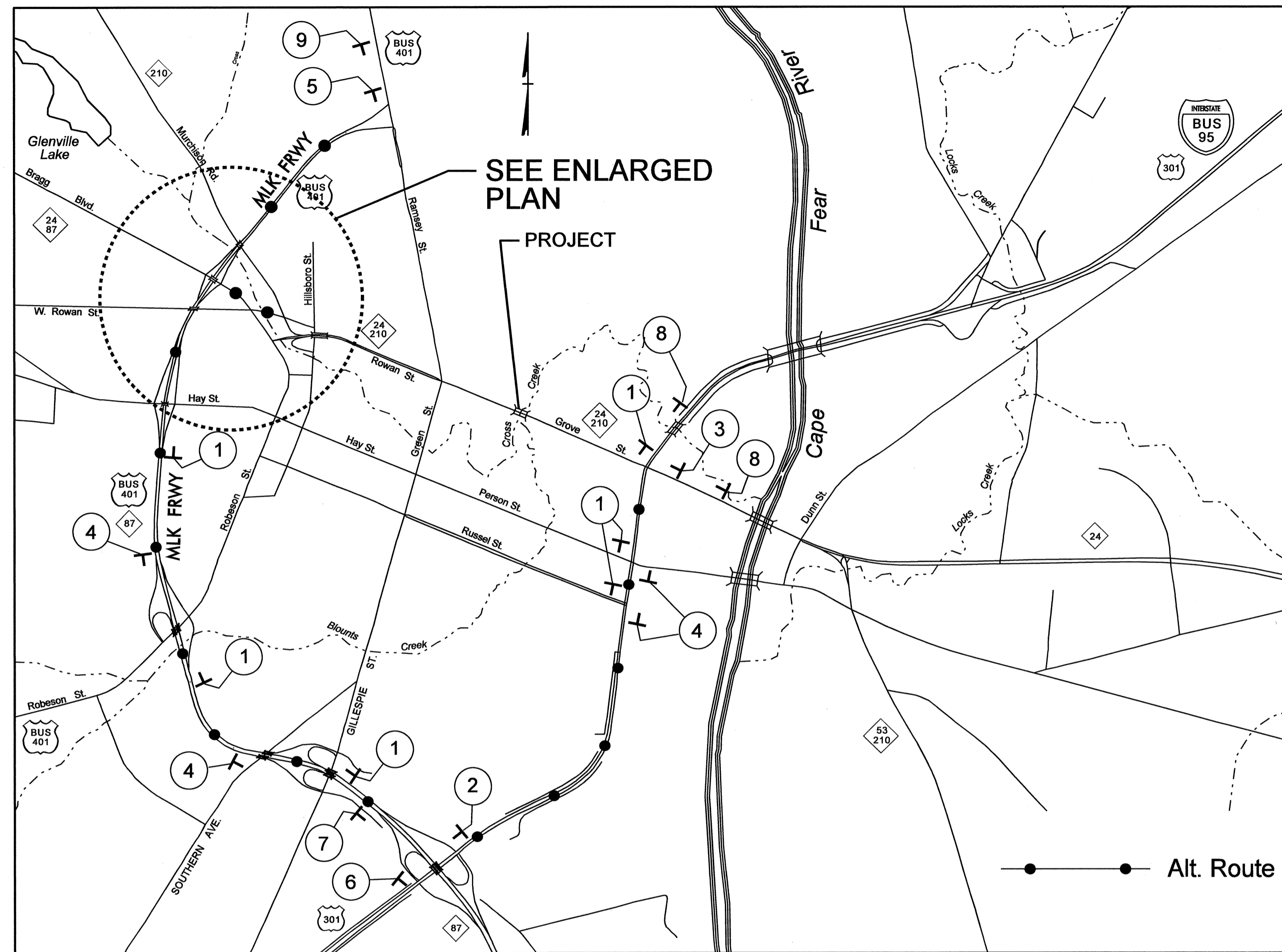

NC 24 / NC 210 ALTERNATE ROUTE PLAN

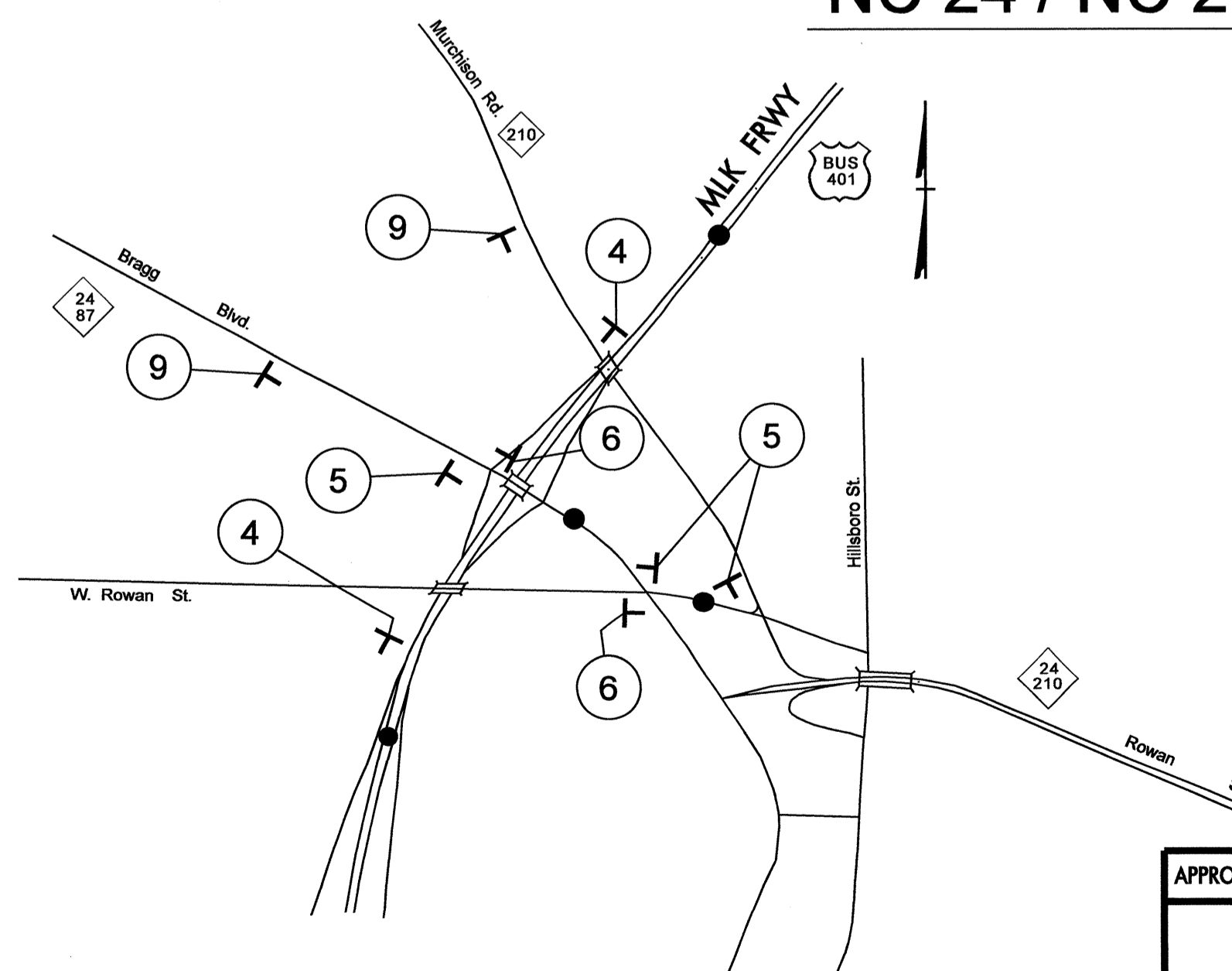

ENLARGED PLAN

NOTES

1. - CHANGEABLE MESSAGE SIGNS MAY BE ADDED AS DIRECTED BY ENGINEER.
2. - THE "ALT" SIGN (M4-1 A) SHALL BE BLACK ON FLUORESCENT ORANGE.
3. - SEE SHEET TMP-2D FOR SPECIAL SIGN DESIGNS.

APPROVED: _____ DATE: _____

NC 24 / NC 210 ALTERNATE ROUTE

20-JUL-2010 10:44
 \\dot\vgi\esr\dot\Pro\TIP\Projects-B\B4090\TrafficControl\top\B-4090_TMP-12.dgn
 kbr\codwell AT 1E24739