

INDEX BY SPL-ICE NO.

| Splice Sheet # | Plan Sheet # | Device | Location | Ring | IP Address |
|----------------|--------------|------------------------|---|---------|------------|
| SPL 1C | - | SPLICE | Division 9 TOC | A, B, C | |
| SPL 1D | - | SPLICE | Triad Regional TMC | A, B, C | |
| SPL 2 | 80 | SPLICE | Salem Avenue at Stadium Drive | A, B, C | |
| SPL 3 | 53 | SPLICE | Martin Luther King Jr. Drive at Stadium Drive | C | |
| SPL 4 | 72 | MVD 43 | Martin Luther King Jr. Drive at US 421 | C | |
| SPL 4 | 73 | MVD 44 | Martin Luther King Jr. Drive at US 421 | C | |
| SPL 4 | 73 | MVD 45 | US 52 Near Stadium Drive | C | |
| SPL 5 | 52 | DMS 8 | Martin Luther King Jr. Drive at Third Street | C | |
| SPL 5 | 52 | MVD 36 | Martin Luther King Jr. Drive at Third Street | C | |
| SPL 6 | 51 | CCTV 12 | Martin Luther King Jr. Drive North of New Walkerton | C | |
| SPL 7 | 50 | MVD 34 | Martin Luther King Jr. Drive North of Highland Avenue | C | |
| SPL 8 | 49 | DMS 7 | US 52 South of Martin Luther King Jr. Drive | C | |
| SPL 8 | 49 | MVD 35 | US 52 South of Martin Luther King Jr. Drive | C | |
| SPL 9 | 54 | SPLICE | Vargrave Street at Parkview Street | C | |
| SPL 10 | 54 | CCTV 13 | US 52 South of Stadium Drive | C | |
| SPL 11 | 55 | DMS 4E | US 52 South of Diggs Blvd. | C | |
| SPL 11 | 55 | MVD 47 | US 52 South of Diggs Blvd. | C | |
| SPL 11 | 74 | MVD 49 | US 52 South of Diggs Blvd. | C | |
| SPL 11 | 74 | MVD 50 | US 52 South of Diggs Blvd. | C | |
| SPL 12 | 59 | DMS 9 | Martin Luther King Jr. Drive South of Williamson Street | C | |
| SPL 12 | 59 | MVD 48 | Martin Luther King Jr. Drive South of Williamson Street | C | |
| SPL 13 | 63 | MVD 51 | Thomasville Road South of Goldfloss Street | C | |
| SPL 14 | 75 | CCTV 14 | I-40 at US 52 | C | |
| SPL 14 | 76 | CCTV 15 | I-40 Near Old Lexington Road | C | |
| SPL 14 | 65 | CCTV 16 | I-40 Near Thomasville Road | C | |
| SPL 14 | 76 | CCTV 17 | I-40 Near Thomasville Road | C | |
| SPL 14 | 77 | CCTV 18 | I-40 Near Thomasville Road | C | |
| SPL 14 | 77 | CCTV 19 | I-40 Near US 311 | C | |
| SPL 14 | 65 | DMS 10 | I-40 Near Thomasville Road | C | |
| SPL 14 | 79 | DMS 5E | I-40 Near Willard Road | C | |
| SPL 14 | 76 | MVD 52 | I-40 Near Thomasville Road | C | |
| SPL 14 | 75 | TRUCK ROLLOVER WARNING | I-40 at US 52 | C | |
| SPL 15 | 68 | MVD 42 | US 421 East of Church Street | B | |
| SPL 15 | 68 | CCTV 5E | US 421 East of Church Street | B | |
| SPL 16 | 67 | SPLICE | Bryce A. Stuart Municipal Building | A, B | |
| SPL 16A | 67 | SPLICE | Winston Salem Transit Center | A, B | |
| SPL 17 | 80 | MVD 32 | University Parkway South of Glenn Avenue | B | |
| SPL 18 | 80 | MVD 29 | University Parkway Near Thurmond Street | B | |
| SPL 19 | 71 | MVD 20 | N. Cherry Street Near Howell Road | A | |
| SPL 19 | 80 | MVD 23 | Deacon Blvd. at University Parkway | A | |
| SPL 20 | 44 | SPLICE | Bethabara Road at Cherry Street | A, B | |
| SPL 21 | 42 | DMS 6 | University Parkway South of Howell Road | A | |
| SPL 22 | 42 | DMS 5 | University Parkway South of Wake Forest Road | B | |
| SPL 22 | 42 | MVD 19 | University Parkway South of Wake Forest Road | B | |
| SPL 23 | 41 | CCTV 9 | University Parkway North of Wake Forest Road | B | |
| SPL 24 | 38 | CCTV 8 | University Parkway Near Ranch Drive | A | |
| SPL 24 | 38 | MVD 17 | University Parkway Near Ranch Drive | A | |
| SPL 25 | 35 | MVD 14 | University Parkway South of Bethabara Park Blvd. | B | |
| SPL 26 | 35 | CCTV 6 | University Parkway Near Bethabara Park Blvd. | B | |
| SPL 27 | 34 | DMS 3 | University Parkway North of Bethabara Park Blvd. | B | |
| SPL 28 | 33 | MVD 11 | University Parkway South of Cherry Street | A | |
| SPL 29 | 32 | CCTV 5 | University Parkway North of Oak Summit Road | A | |
| SPL 30 | 31 | MVD 8 | University Parkway North of Hanes Mill Road | B | |
| SPL 31 | 9 | SPLICE | US 52 at University Parkway | A, B | |

| Splice Sheet # | Plan Sheet # | Device | Location | Ring | IP Address |
|----------------|--------------|---------|---|------|------------|
| SPL 32 | 9 | CCTV 3 | US 52 North of University Parkway | A | |
| SPL 33 | 7 | CCTV 1E | US 52 South of Hanes Mill Road | A | |
| SPL 33 | 7 | MVD 5 | US 52 South of Hanes Mill Road | A | |
| SPL 34 | 4 | CCTV 1 | US 52 South of Ziglar Road | A | |
| SPL 34 | 4 | DMS 1 | US 52 South of Ziglar Road | A | |
| SPL 34 | 4 | MVD 3 | US 52 South of Ziglar Road | A | |
| SPL 35 | 4 | DMS 1E | US 52 North of Ziglar Road | A | |
| SPL 35 | 69 | MVD 1 | US 52 North of Ziglar Road | A | |
| SPL 35 | 69 | MVD 2 | US 52 North of Ziglar Road | A | |
| SPL 36 | 28 | DMS 2 | University Parkway Near University Center Drive | B | |
| SPL 36 | 29 | MVD 6 | University Parkway Near University Center Drive | B | |
| SPL 37 | 28 | CCTV 2 | University Parkway Near Hanes Mill Road | B | |
| SPL 38 | 27 | MVD 4 | University Parkway North of Coral Drive | B | |
| SPL 39 | 10 | MVD 7 | US 52 South of University Parkway | B | |
| SPL 40 | 11 | CCTV 4 | US 52 North of Oak Summit Road | A | |
| SPL 41 | 13 | MVD 9 | US 52 South of Oak Summit Road | A | |
| SPL 42 | 15 | CCTV 7 | US 52 North of Germanton Road | B | |
| SPL 43 | 70 | MVD 10 | US 52 South of Germanton Road | B | |
| SPL 43 | 70 | MVD 12 | US 52 South of Germanton Road | B | |
| SPL 43 | 15 | MVD 13 | US 52 South of Germanton Road | B | |
| SPL 43 | 70 | MVD 15 | US 52 South of Germanton Road | B | |
| SPL 44 | 17 | MVD 16 | US 52 North of Motor Road | A | |
| SPL 45 | 18 | CCTV 7E | US 52 Near Motor Road | B | |
| SPL 45 | 18 | DMS 2E | US 52 Near Motor Road | B | |
| SPL 45 | 18 | DMS 4 | US 52 Near Motor Road | B | |
| SPL 46 | 19 | MVD 18 | US 52 South of Motor Road | A | |
| SPL 47 | 22 | MVD 21 | University Parkway South of Patterson Avenue | A | |
| SPL 48 | 22 | CCTV 10 | University Parkway South of Patterson Avenue | B | |
| SPL 49 | 24 | SPLICE | US 52 at Akron Drive | A, B | |
| SPL 50 | 25 | CCTV 2E | US 52 South of Akron Drive | B | |
| SPL 50 | 25 | MVD 25 | US 52 South of Akron Drive | B | |
| SPL 51 | 26 | DMS 11 | Patterson Avenue Near Akron Drive | A | |
| SPL 51 | 71 | MVD 22 | Patterson Avenue Near Frampton Street | A | |
| SPL 52 | 81 | MVD 24 | Patterson Avenue Near 34th Street | A | |
| SPL 53 | 81 | MVD 27 | Patterson Avenue Near 29th Street | B | |
| SPL 54 | 81 | MVD 30 | Patterson Avenue Near 17th Street | B | |
| SPL 55 | 82 | SPLICE | 15th Street at Patterson Avenue | A, B | |
| SPL 56 | 48 | CCTV 4E | US 52 North of 16th Street | A | |
| SPL 56 | 48 | MVD 31 | US 52 North of 16th Street | A | |
| SPL 57 | 47 | DMS 3E | US 52 North of Liberty Street | A | |
| SPL 58 | 47 | MVD 28 | US 52 North of Liberty Street | A | |
| SPL 59 | 46 | CCTV 3E | US 52 North of 25th Street | A | |
| SPL 60 | 45 | CCTV 11 | US 52 South of Liberty Street | A | |
| SPL 60 | 45 | MVD 26 | US 52 South of Liberty Street | A | |
| SPL 61 | 82 | SPLICE | Patterson Avenue at Northwest Blvd. | A, B | |
| SPL 62 | 81 | MVD 33 | Patterson Avenue Near 11th Street | B | |
| SPL 63 | 78 | SPLICE | Cloverdale Avenue at First Street | A, B | |
| SPL 64 | 79 | MVD 37 | Cloverdale Avenue at First Street | A | |
| SPL 64 | 79 | MVD 38 | Cloverdale Avenue at First Street | A | |
| SPL 64 | 78 | MVD 39 | US 421 Near Cloverdale Avenue | A | |
| SPL 64 | 79 | MVD 40 | Cloverdale Avenue at First Street | A | |
| SPL 64 | 66 | MVD 41 | US 421 Near Brooktown Avenue | A | |
| SPL 65 | 82 | DMS 6E | I-40 Near Peters Creek Parkway | C | |
| SPL 65 | 82 | CCTV 6E | I-40 Near Peters Creek Parkway | C | |
| SPL 66 | 66 | DMS 7E | I-40 Business at Green Street | - | |

K:\BAK_P770_LTS_011056158-US 52 ITS (U-2826B)\Plan_Spl_ICE.mxd (SPL-1.dgn) 1/25/2011 1:29:21 PM susan.openmation

PLANS PREPARED IN THE OFFICE OF:

Kimley-Horn and Associates, Inc.
 P.O. Box 33068
 Raleigh, N.C. 27636-3068
 (919) 677-2000
 N.C. License # F-002

750 N. Greenfield Place, Garner, NC 27529
 SCALE: NONE

| | | | |
|-----------------------|--------------|----------------|-------------|
| U-2826B | | | |
| SPLICE DETAILS | | | |
| DIVISION 9 | | FORSYTH COUNTY | |
| WINSTON SALEM | | | |
| PLAN DATE: | JANUARY 2011 | REVIEWED BY: | S. Phillips |
| PREPARED BY: | J. Cross | REVIEWED BY: | S. Privette |
| SCALE | INIT. | DATE | |
| | | | |
| | | | |

SEAL

SIGNATURE: *Stephanie B. Privette* 1-25-11
 DATE

CADD Filename:

MVD 1

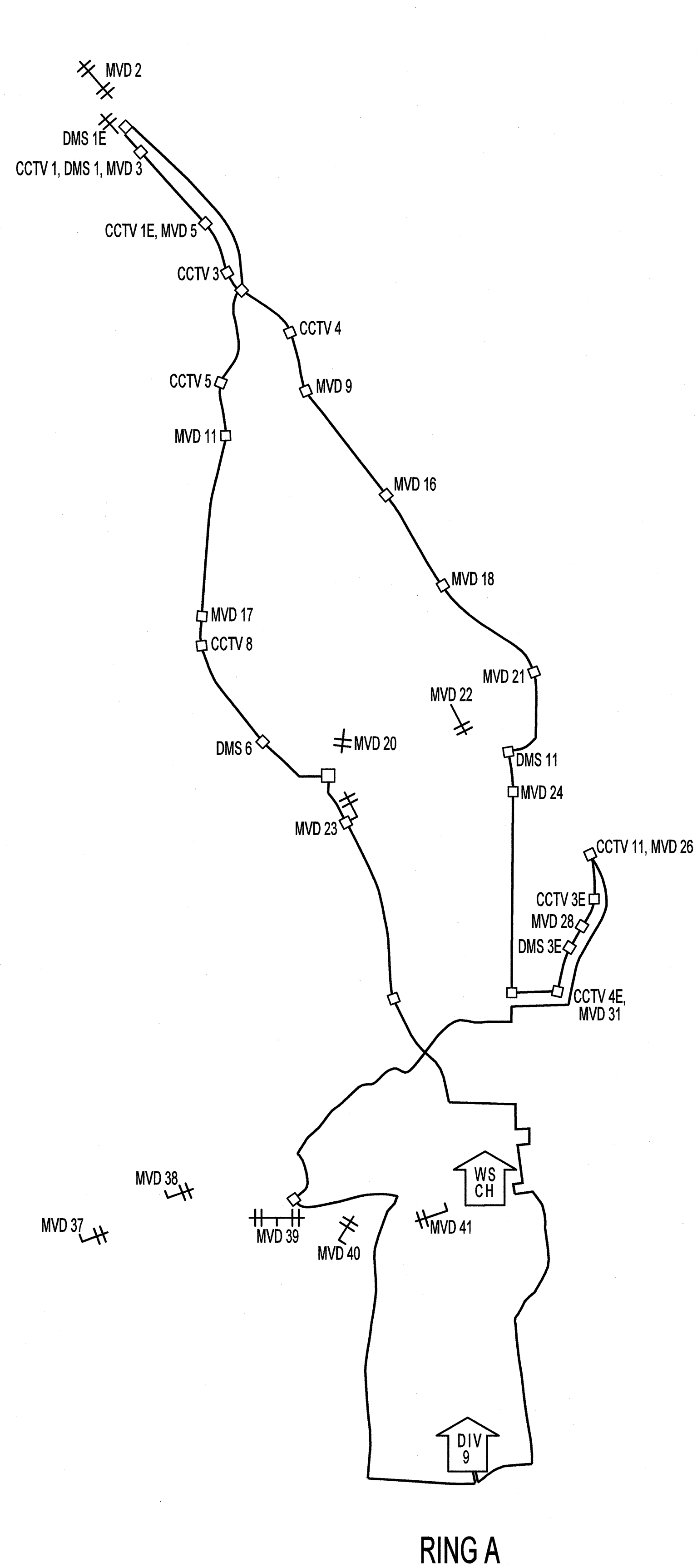

RING A

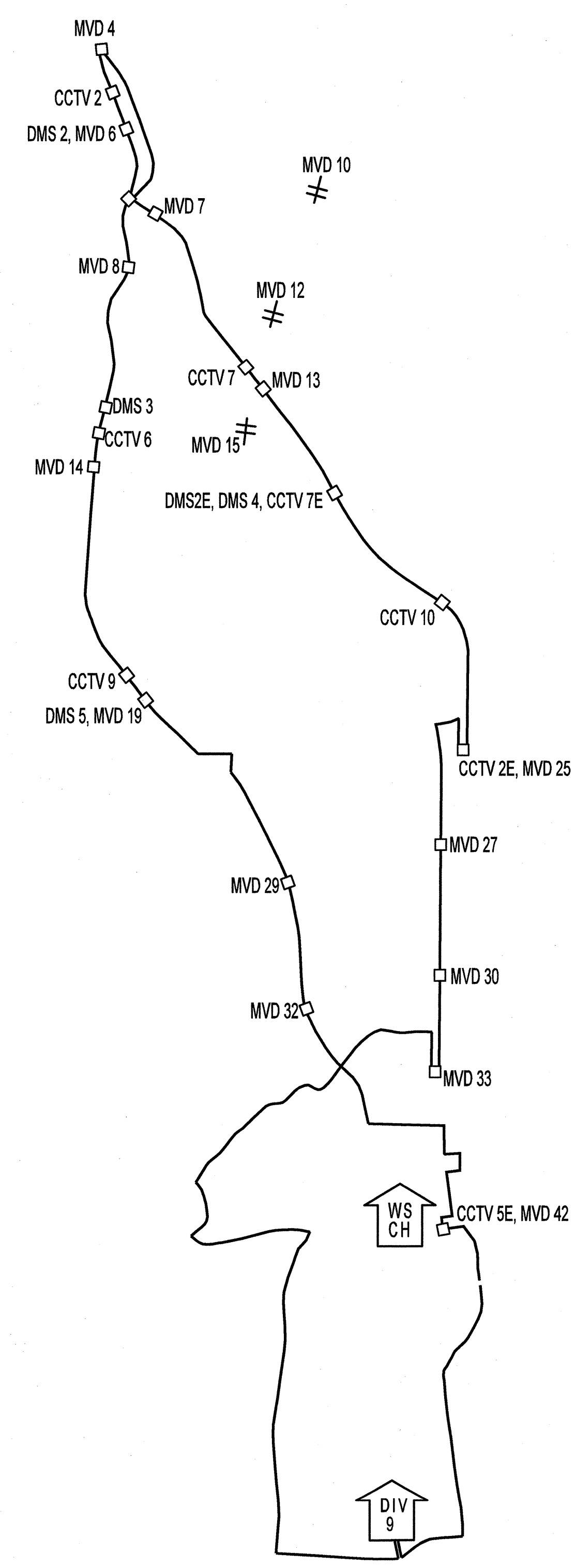

RING B

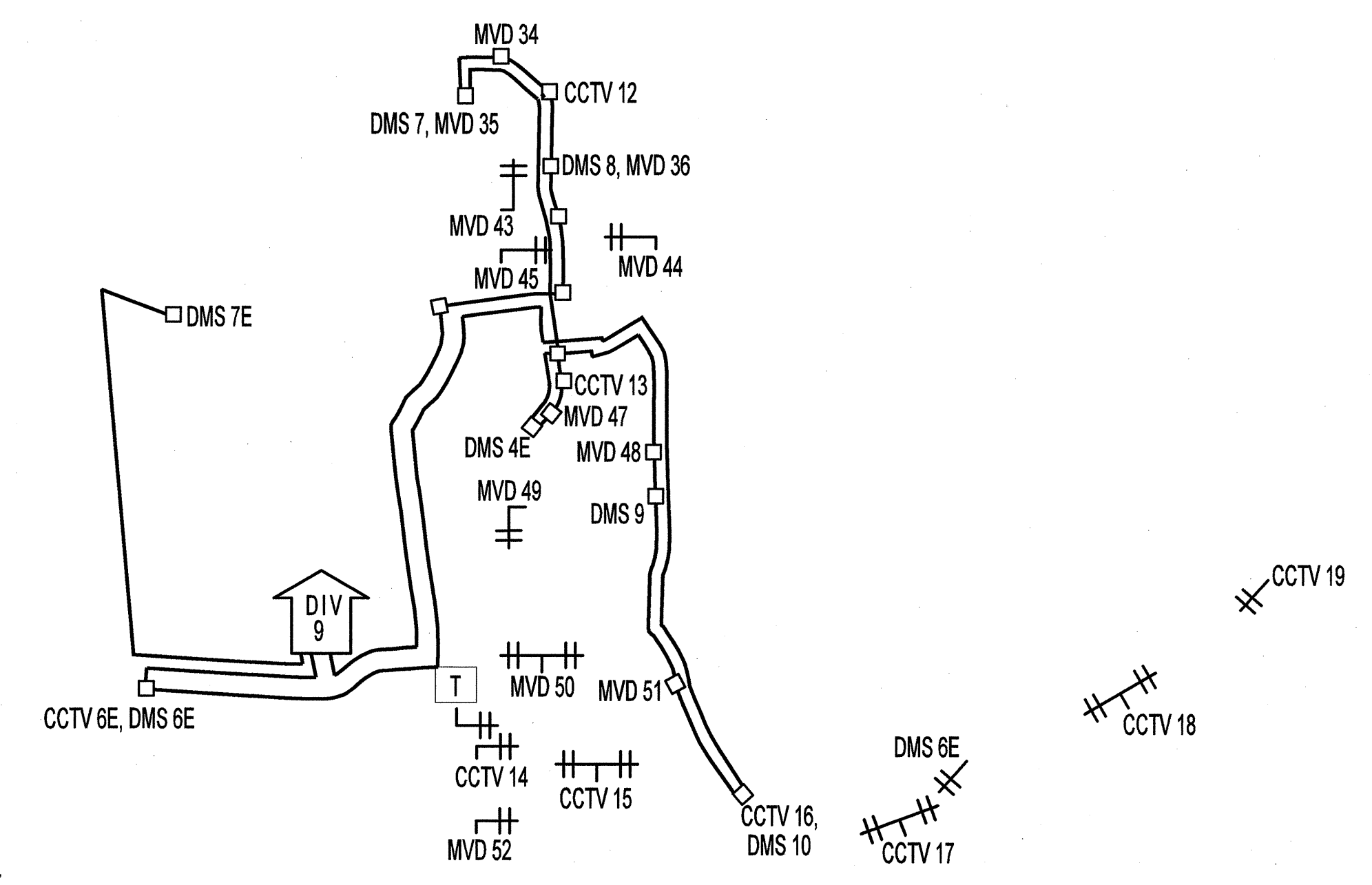

RING C AND HOMERUN DMS

k:\na\proj_its\0108658.us_82_its (u-2826B) (plan)\SplCmp\SPLO1B.dgn
 1/25/2011 11:47:31 AM jerry.cross

PLANS PREPARED IN THE OFFICE OF:

Kimley-Horn and Associates, Inc.
 P.O. Box 33068
 Raleigh, N.C. 27636-3068
 (919) 677-2000
 N.C. License # F-0102

| | |
|---|--------------------------|
| U-2826B | |
| SPLICE DETAILS | |
| DIVISION 9 FORSYTH COUNTY WINSTON SALEM | |
| PLAN DATE: JANUARY 2011 | REVIEWED BY: S. Phillips |
| PREPARED BY: J. Cross | REVIEWED BY: S. Privette |
| SCALE | REVISIONS |
| 0 | INIT. DATE |
| NONE | |

SEAL

SIGNATURE: *Stephanie B. Privette* DATE: 1-25-11

CADD Filename:

DIVISION 9 TOC FIBER INTERCONNECT CENTER

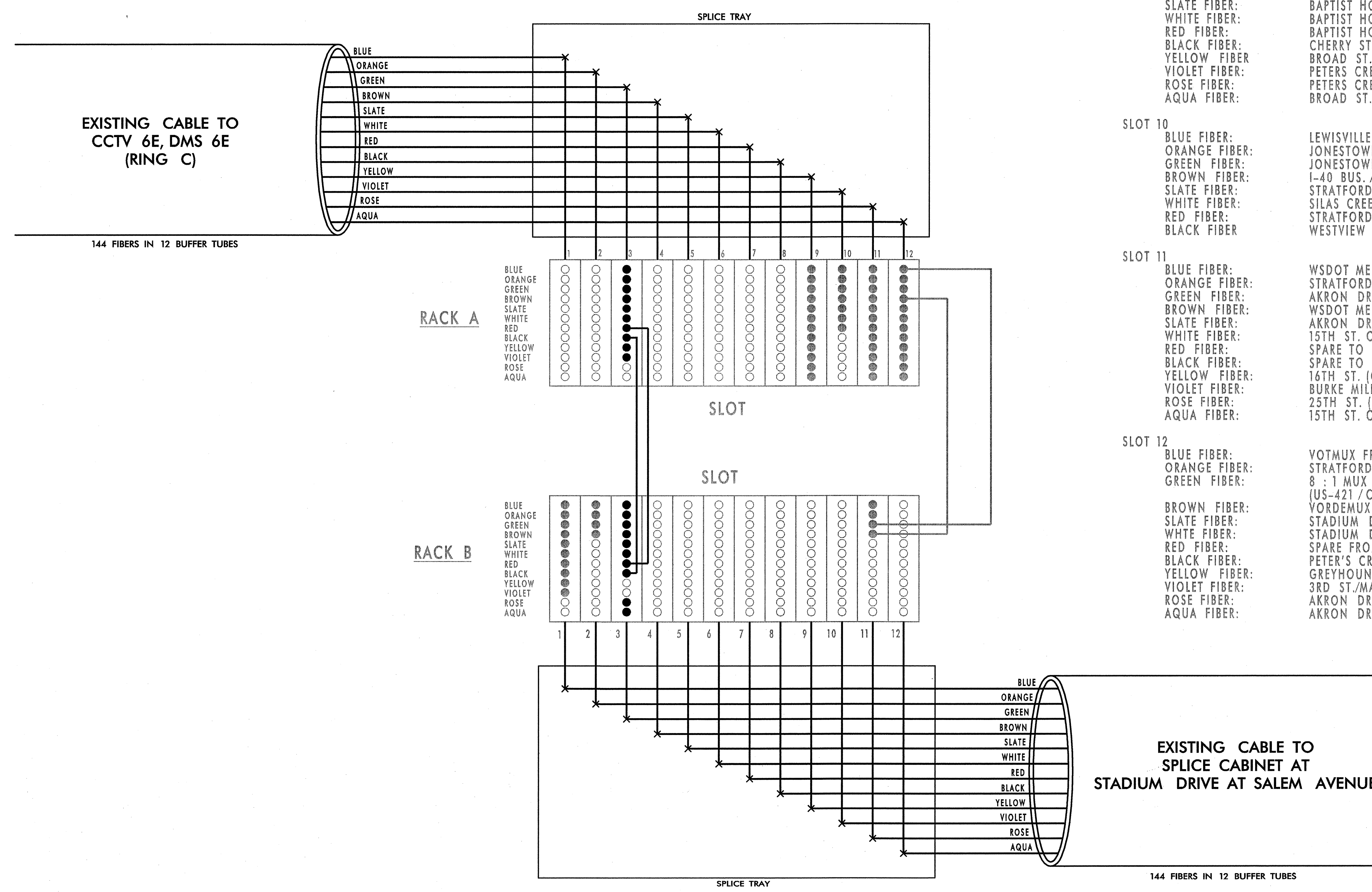

RACK A

- SLOT 3
 - BLUE FIBER: RING A
 - ORANGE FIBER: RING A
 - GREEN FIBER: RING B
 - BROWN FIBER: RING B
 - SLATE FIBER: RING C
 - WHITE FIBER: RING C
 - RED FIBER: RING C
 - BLACK FIBER: RING C
 - YELLOW FIBER: RING C
 - VIOLET FIBER: DMS 7E
- SLOT 9
 - BLUE FIBER: PEACE HAVE RD. /US-421 CCTV
 - ORANGE FIBER: JONESTOWN RD. /US-421 CCTV
 - GREEN FIBER: STRATFORD RD /I-40 BUS. CCTV
 - BROWN FIBER: BAPTIST HOSPITAL ANTENNA
 - SLATE FIBER: BAPTIST HOSPITAL ANTENNA
 - WHITE FIBER: BAPTIST HOSPITAL ANTENNA
 - RED FIBER: BAPTIST HOSPITAL ANTENNA
 - BLACK FIBER: CHERRY ST. /I-40 BUS. CCTV
 - YELLOW FIBER: BROAD ST. /I-40 BUS. CCTV
 - VIOLET FIBER: PETERS CREEK PKWY /I-40 BUS. CCTV
 - ROSE FIBER: PETERS CREEK PKWY /SILAS CREEK PKWY
 - AQUA FIBER: BROAD ST./I-40 BUS DMS
- SLOT 10
 - BLUE FIBER: LEWISVILLE RD. /I-40 CCTV
 - ORANGE FIBER: JONESTOWN RD. /MACGREGOR AT I-40 CCTV
 - GREEN FIBER: JONESTOWN RD. /I-40 CCTV
 - BROWN FIBER: I-40 BUS. /US-421 MEDIAN W/O VINEYARD RD. CCTV
 - SLATE FIBER: STRATFORD RD. /I-40 CCTV
 - WHITE FIBER: SILAS CREEK PKWY /I-40 BUS. CCTV
 - RED FIBER: STRATFORD RD /SILAS CREEK PKWY
 - BLACK FIBER: WESTVIEW DR. /I-40 BUS. /US 421
- SLOT 11
 - BLUE FIBER: WSDOT MEDIA CONVERTER
 - ORANGE FIBER: STRATFORD SPARE
 - GREEN FIBER: AKRON DR. (CAM 1)
 - BROWN FIBER: WSDOT MEDIA CONVERTER
 - SLATE FIBER: AKRON DR. SPARE
 - WHITE FIBER: 15TH ST. CABINET
 - RED FIBER: SPARE TO WSDOT
 - BLACK FIBER: SPARE TO WSDOT
 - YELLOW FIBER: 16TH ST. (CAM 2)
 - VIOLET FIBER: BURKE MILL (CAM 27)
 - ROSE FIBER: 25TH ST. (CAM 6)
 - AQUA FIBER: 15TH ST. CABINET
- SLOT 12
 - BLUE FIBER: VOTMUX FROM WSDOT
 - ORANGE FIBER: STRATFORD SPARE
 - GREEN FIBER: 8 : 1 MUX FROM 3RD ST. /MAPLE ST. SPLICE CABINET (US-421 /CEMETARY, GREYHOUND US-421 /MLK JR. VORDEMUX FROM WSDOT
 - BROWN FIBER: STADIUM DR. SPARE
 - SLATE FIBER: STADIUM DR. SPARE
 - WHITE FIBER: SPARE FROM WSDOT
 - RED FIBER: PETER'S CREEK /SILAS CREEK (CAM 26)
 - BLACK FIBER: GREYHOUND SPARE
 - YELLOW FIBER: 3RD ST./MAPLE ST. SPLICE CABINET
 - VIOLET FIBER: AKRON DR SPARE
 - ROSE FIBER: AKRON DR SPARE
 - AQUA FIBER: AKRON DR SPARE

RACK B

- SLOT 1
 - BLUE FIBER: VOTMUX
 - ORANGE FIBER: VOTMUX
 - GREEN FIBER: VOTMUX
 - BROWN FIBER: VOTMUX
 - SLATE FIBER: VOTMUX
 - WHITE FIBER: FOTMUX
 - RED FIBER: FOTMUX
 - BLACK FIBER: FOTMUX
 - YELLOW FIBER: FOTMUX
 - VIOLET FIBER: VORDEMUX
- SLOT 2
 - BLUE FIBER: FOT
 - ORANGE FIBER: FOT
 - GREEN FIBER: FOT
 - BROWN FIBER: FOT
- SLOT 3
 - BLUE FIBER: RING A
 - ORANGE FIBER: RING A
 - GREEN FIBER: RING B
 - BROWN FIBER: RING B
 - SLATE FIBER: RING C
 - WHITE FIBER: RING C
 - RED FIBER: RING C
 - BLACK FIBER: RING C
 - ROSE FIBER: ETHERNET LINK WITH TRTMC
 - AQUA FIBER: ETHERNET LINK WITH TRTMC
- SLOT 11
 - BLUE FIBER: MEDIA CONVERTER
 - ORANGE FIBER: MEDIA CONVERTER
 - GREEN FIBER: VOTMUX TO WSDOT (JUMPERED THROUGH)
 - BROWN FIBER: VORDEMUX FROM WS DOT (JUMPERED THROUGH)

LEGEND

| | | |
|------------------------------------|-------------|------------------------------------|
| COLOR CODE TIA/EIA 598-B | | |
| (1) BLUE | (7) RED | |
| (2) ORANGE | (8) BLACK | X - FUSION SPLICE INDIVIDUAL FIBER |
| (3) GREEN | (9) YELLOW | ○ OPEN ● EXISTING ● NEW |
| (4) BROWN | (10) VIOLET | |
| (5) SLATE | (11) ROSE | EXPRESS EXPRESS ENTIRE BUFFER TUBE |
| (6) WHITE | (12) AQUA | SPLICE SPLICE ENTIRE BUFFER TUBE |

ETHERNET SWITCH TERMINATION CONFIGURATIONS ARE GENERIC. CONTRACTOR IS RESPONSIBLE FOR DETERMINING / ENSURING PROPER TERMINATION.

- NOTES:**
1. TERMINATE BUFFER TUBES TO PATCH PANEL AS SHOWN.
 2. TERMINATE LIKE FIBER COLOR IN BUFFER TUBES TO CORRESPONDING PORT IN PATCH PANEL.
 3. FIBER INTERCONNECT CENTER RACKS ARE SCHEMATIC ONLY - ACTUAL EQUIPMENT FORM FACTOR MAY VARY.

PLANS PREPARED IN THE OFFICE OF:

Kimley-Horn and Associates, Inc.
 P.O. Box 33068
 Raleigh, N.C. 27636-3068
 (919) 677-2000
 N.C. License # F-002

| | | | | |
|---|--|--|--|-------------------------------------|
| U-2826B | | SPLICE DETAILS | | SEAL |
| DIVISION 9 FORSYTH COUNTY WINSTON SALEM | | PREPARED BY: J. CROSS REVIEWED BY: S. Privette | | DATE: 1/25/11 CADD Filename: |
| PLAN DATE: JANUARY 2011 | | REVIEWED BY: S. Phillips | | |
| SCALE: 0 NONE | | REVISIONS | | |

k:\real\proj_11s\01086158-us_52_11s (u-2826B) (plan)Splice.dwg (SPL-1C.dgn) 1/25/2011 11:47:32 AM jerry.cross

TRIAD REGIONAL TRAFFIC MANAGEMENT CENTER

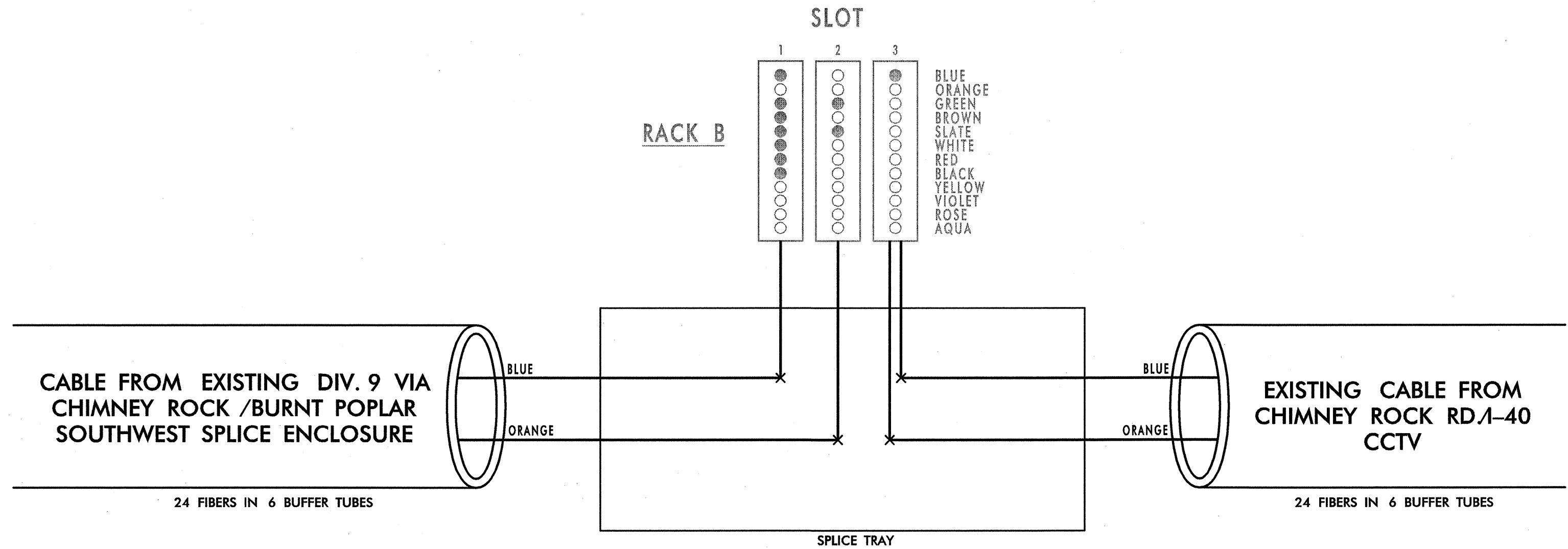
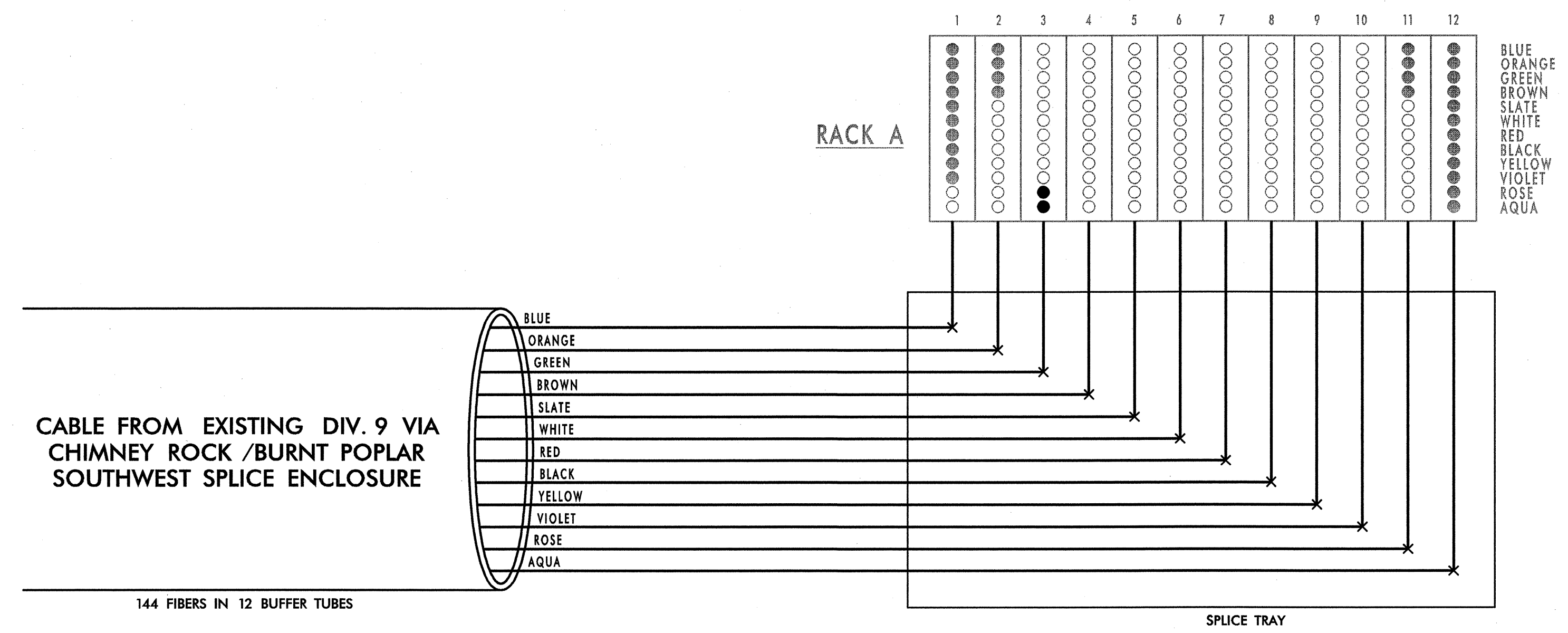

TERMINATE BLUE, ORANGE, GREEN, BROWN, SLATE, AND WHITE FIBERS IN BLUE BUFFER TUBE TO CORRESPONDING COLOR CONNECTOR.
TERMINATE BLUE, ORANGE, GREEN, BROWN, SLATE, AND WHITE FIBERS IN ORANGE BUFFER TUBE TO RED, BLACK, YELLOW, VIOLET, ROSE, AND AQUA CONNECTORS RESPECTIVELY.

- NOTES:**
1. TERMINATE BUFFER TUBES TO PATCH PANEL AS SHOWN.
 2. FIBER INTERCONNECT CENTER RACKS ARE SCHEMATIC ONLY - ACTUAL EQUIPMENT FORM FACTOR MAY VARY.

| COLOR CODE | | LEGEND | |
|---------------|-------------|--|----------------------------------|
| TIA/EIA 598-B | | ETHERNET SWITCH TERMINATION CONFIGURATIONS ARE GENERIC. CONTRACTOR IS RESPONSIBLE FOR DETERMINING / ENSURING PROPER TERMINATION. | |
| (1) BLUE | (7) RED | X | - FUSION SPLICE INDIVIDUAL FIBER |
| (2) ORANGE | (8) BLACK | | |
| (3) GREEN | (9) YELLOW | | |
| (4) BROWN | (10) VIOLET | | |
| (5) SLATE | (11) ROSE | EXPRESS | EXPRESS ENTIRE BUFFER TUBE |
| (6) WHITE | (12) AQUA | SPLICE | SPLICE ENTIRE BUFFER TUBE |

| RACK A | |
|---------|---|
| SLOT 1 | BLUE FIBER: VORDEMUX ORANGE FIBER: VORDEMUX GREEN FIBER: VORDEMUX BROWN FIBER: VORDEMUX SLATE FIBER: FOTDEMUX WHITE FIBER: FOTDEMUX RED FIBER: FOTDEMUX BLACK FIBER: FOTDEMUX YELLOW FIBER: FOTDEMUX VIOLET FIBER: VOTMUX |
| SLOT 2 | BLUE FIBER: FOT ORANGE FIBER: FOT GREEN FIBER: FOT BROWN FIBER: FOT |
| SLOT 3 | BLUE FIBER: ETHERNET LINK WITH DIVISION 9 ORANGE FIBER: ETHERNET LINK WITH DIVISION 9 |
| SLOT 11 | BLUE FIBER: MEDIA CONVERTER ORANGE FIBER: MEDIA CONVERTER GREEN FIBER: VOTMUX TO WSDOT BROWN FIBER: VORDEMUX FROM WSDOT |
| SLOT 12 | BLUE: SPARE ORANGE: CCTV H GREEN FIBER: DMS G AND K BROWN FIBER: DMS G AND K SLATE FIBER: CCTV F WHITE FIBER: CCTV E RED FIBER: CCTV D BLACK FIBER: DMS C AND J YELLOW FIBER: DMS C AND J VIOLET FIBER: CCTV B ROSE FIBER: CCTV A2 AQUA FIBER: SPARE |

| RACK B | |
|--------|--|
| SLOT 1 | BLUE FIBER: I-40 /US 421 /GUILFORD COLLEGE RD CCTV GREEN FIBER: FOTDEMUX BROWN FIBER: VORDEMUX SLATE FIBER: VORDEMUX WHITE FIBER: VOTMUX RED FIBER: MEDIA CONVERTER BLACK FIBER: MEDIA CONVERTER |
| SLOT 2 | GREEN FIBER: I-40 /US 421 /GALLIMORE RD CCTV SLATE FIBER: I-40 /US 421 /REGIONAL RD CCTV |
| SLOT 3 | BLUE FIBER: CHIMNEY ROCK CCTV |

PLANS PREPARED IN THE OFFICE OF:
Kimley-Horn and Associates, Inc.
P.O. Box 33068
Raleigh N.C. 27636-3068
(919) 617-2000
N.C. License # F-0102

| | |
|-------------------------|------------------------------|
| U-2826B | |
| SPLICE DETAILS | |
| DIVISION 9 | FORSYTH COUNTY WINSTON SALEM |
| PLAN DATE: JANUARY 2011 | REVIEWED BY: S. Phillips |
| PREPARED BY: J. Cross | REVIEWED BY: S. Privette |
| SCALE | INIT. DATE |
| 0 | |
| NONE | |

SEAL

STEPHANIE B. PRIVETTE

1.25.11

DATE

CADD Filename

k:\na\l\trco_1ts\011056158-us 52_1ts (u-2826B)\plan\Splicing\SP1.DWG
 1/25/2011 11:47:39 AM jerry.cross

**EXISTING SPLICE ENCLOSURE
AT SALEM AVENUE AT
STADIUM DRIVE**

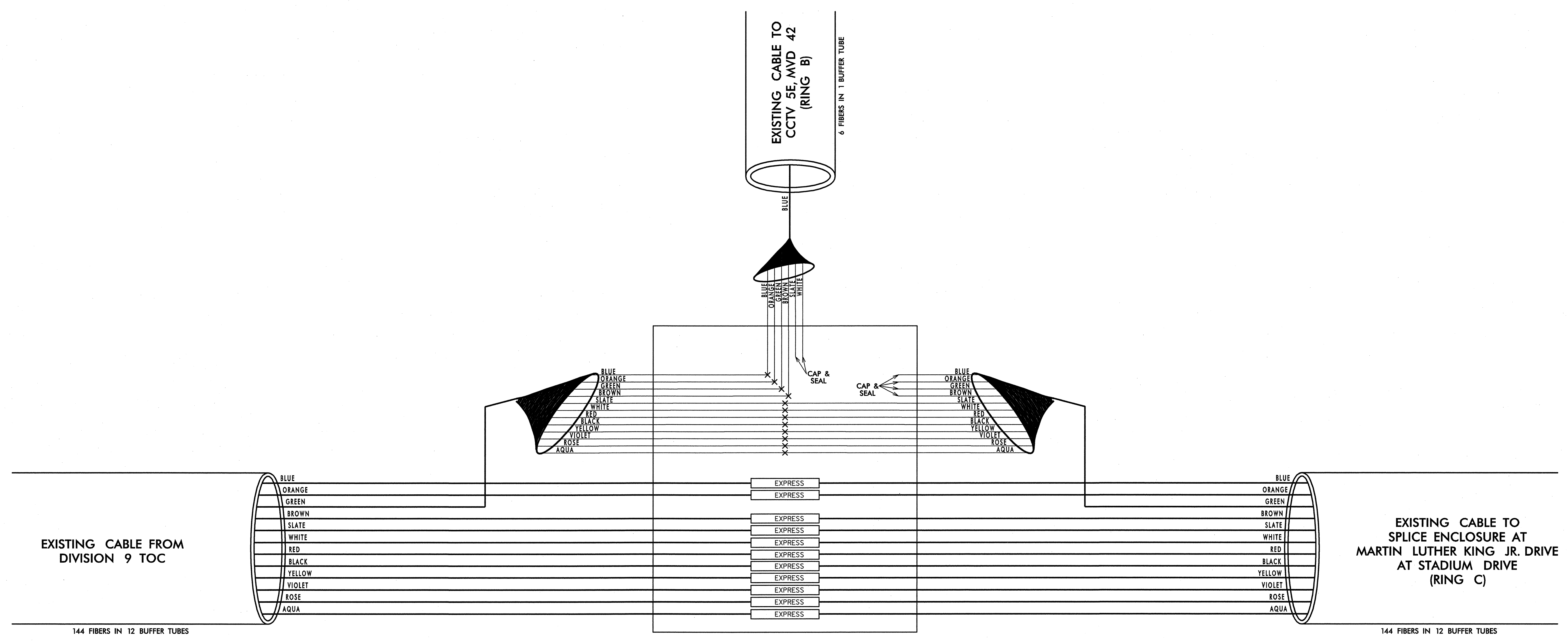

LEGEND

COLOR CODE
TIAEIA 598-B

| | | | | | | |
|------------|----------------------------|---|---------|----------------------------|--------|---------------------------|
| (1) BLUE | (7) RED | X - FUSION SPLICE INDIVIDUAL FIBER <table border="0"> <tr> <td>EXPRESS</td> <td>EXPRESS ENTIRE BUFFER TUBE</td> </tr> <tr> <td>SPLICE</td> <td>SPLICE ENTIRE BUFFER TUBE</td> </tr> </table> | EXPRESS | EXPRESS ENTIRE BUFFER TUBE | SPLICE | SPLICE ENTIRE BUFFER TUBE |
| EXPRESS | EXPRESS ENTIRE BUFFER TUBE | | | | | |
| SPLICE | SPLICE ENTIRE BUFFER TUBE | | | | | |
| (2) ORANGE | (8) BLACK | | | | | |
| (3) GREEN | (9) YELLOW | | | | | |
| (4) BROWN | (10) VIOLET | | | | | |
| (5) SLATE | (11) ROSE | | | | | |
| (6) WHITE | (12) AQUA | | | | | |

ETHERNET SWITCH TERMINATION CONFIGURATIONS ARE GENERIC. CONTRACTOR IS RESPONSIBLE FOR DETERMINING / ENSURING PROPER TERMINATION.

**RESPLICE EXISTING
SPLICE ENCLOSURE**

RING A, RING B, RING C

NOTES:
1. FIBER INTERCONNECT CENTER RACKS ARE SCHEMATIC ONLY - ACTUAL EQUIPMENT FORM MAY VARY.

PLANS PREPARED IN THE OFFICE OF:
Kimley-Horn and Associates, Inc.
P.O. Box 33068
Raleigh N.C. 27636-3068
(919) 677-2000
N.C. License # F-0102

| | U-2826B SPLICE DETAILS | | SEAL | | | | | | |
|--------------------|---|--|----------|------|--|--|--|---------------|-----------------|
| | DIVISION 9 FORSYTH COUNTY WINSTON SALEM | | | | | | | | |
| | PLAN DATE: JANUARY 2011 PREPARED BY: J. Cross | REVIEWED BY: S. Phillips REVIEWED BY: S. Privette | | | | | | | |
| SCALE 0 NONE | REVISIONS <table border="1"> <tr> <th>NO.</th> <th>INIT.</th> <th>DATE</th> </tr> <tr> <td> </td> <td> </td> <td> </td> </tr> </table> | NO. | INIT. | DATE | | | | SIGNATURE | DATE 1-26-11 |
| NO. | INIT. | DATE | | | | | | | |
| | | | | | | | | | |

k:\na\trn\tsa\0108658-us 52.tss (U-2826B)\plan\splice.dwg
 11:47:34 AM
 jerry.cross
 1/26/2011

**EXISTING SPLICE ENCLOSURE
MARTIN LUTHER KING JR. DRIVE
AT STADIUM DRIVE**

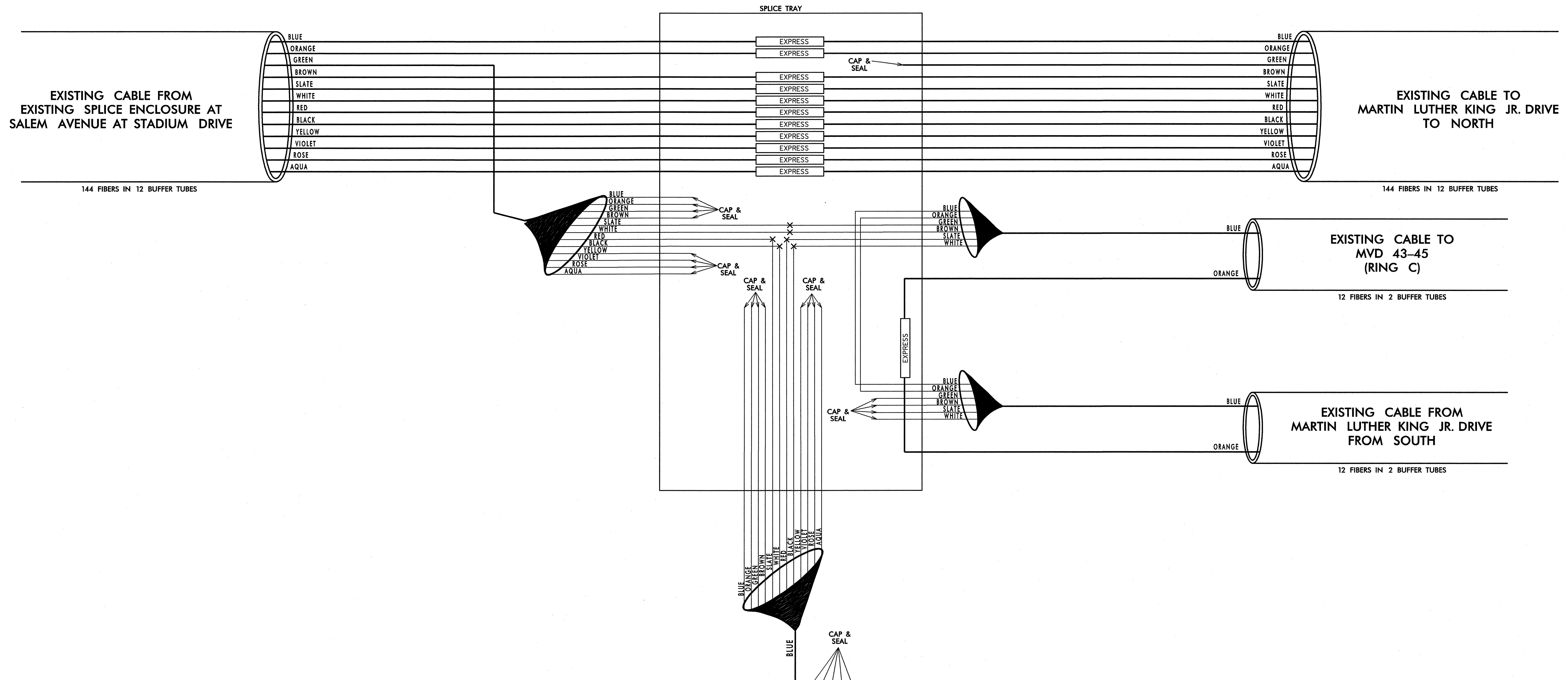

LEGEND

| | | |
|------------------------------------|-------------|--|
| COLOR CODE TIA/EIA 598-B | | ETHERNET SWITCH TERMINATION CONFIGURATIONS ARE GENERIC. CONTRACTOR IS RESPONSIBLE FOR DETERMINING / ENSURING PROPER TERMINATION. |
| (1) BLUE | (7) RED | X - FUSION SPLICE INDIVIDUAL FIBER |
| (2) ORANGE | (8) BLACK | |
| (3) GREEN | (9) YELLOW | |
| (4) BROWN | (10) VIOLET | |
| (5) SLATE | (11) ROSE | EXPRESS ENTIRE BUFFER TUBE |
| (6) WHITE | (12) AQUA | SPLICE ENTIRE BUFFER TUBE |

NOTES:
1. FIBER INTERCONNECT CENTER RACKS ARE SCHEMATIC ONLY - ACTUAL EQUIPMENT FORM MAY VARY.

**NEW CABLE TO
VARGRAVE STREET
AT PARKVIEW ST.**
72 FIBERS IN 6 BUFFER TUBES

RING C

U-2826B

SPLICE DETAILS

PLANS PREPARED IN THE OFFICE OF:

Kimley-Horn and Associates, Inc.
P.O. Box 33068
Raleigh N.C. 27636-3068
(919) 677-2000
N.C. License # F-002

750 N. Greenfield Pkwy., Garner, NC 27529

| | |
|---|--------------------------|
| DIVISION 9 FORSYTH COUNTY WINSTON SALEM | |
| PLAN DATE: JANUARY 2011 | REVIEWED BY: S. Phillips |
| PREPARED BY: J. Cross | REVIEWED BY: S. Privette |
| REVISIONS | INIT. DATE |
| | |
| | |

SEAL

STEPHANIE B. PRIVETTE
ENGINEER
24432

[Signature] 1-25-11
DATE

CADD Filename

k:\val_tproj_1\ts\011056158-us 52.tss (U-2826B)\plan(Spl)SPL03.dgn 11:47:35 AM jerry.cross 1/25/2011

**SPLICE ENCLOSURE AT MVD 43-45
MARTIN LUTHER KING JR. DRIVE
AT US 421**

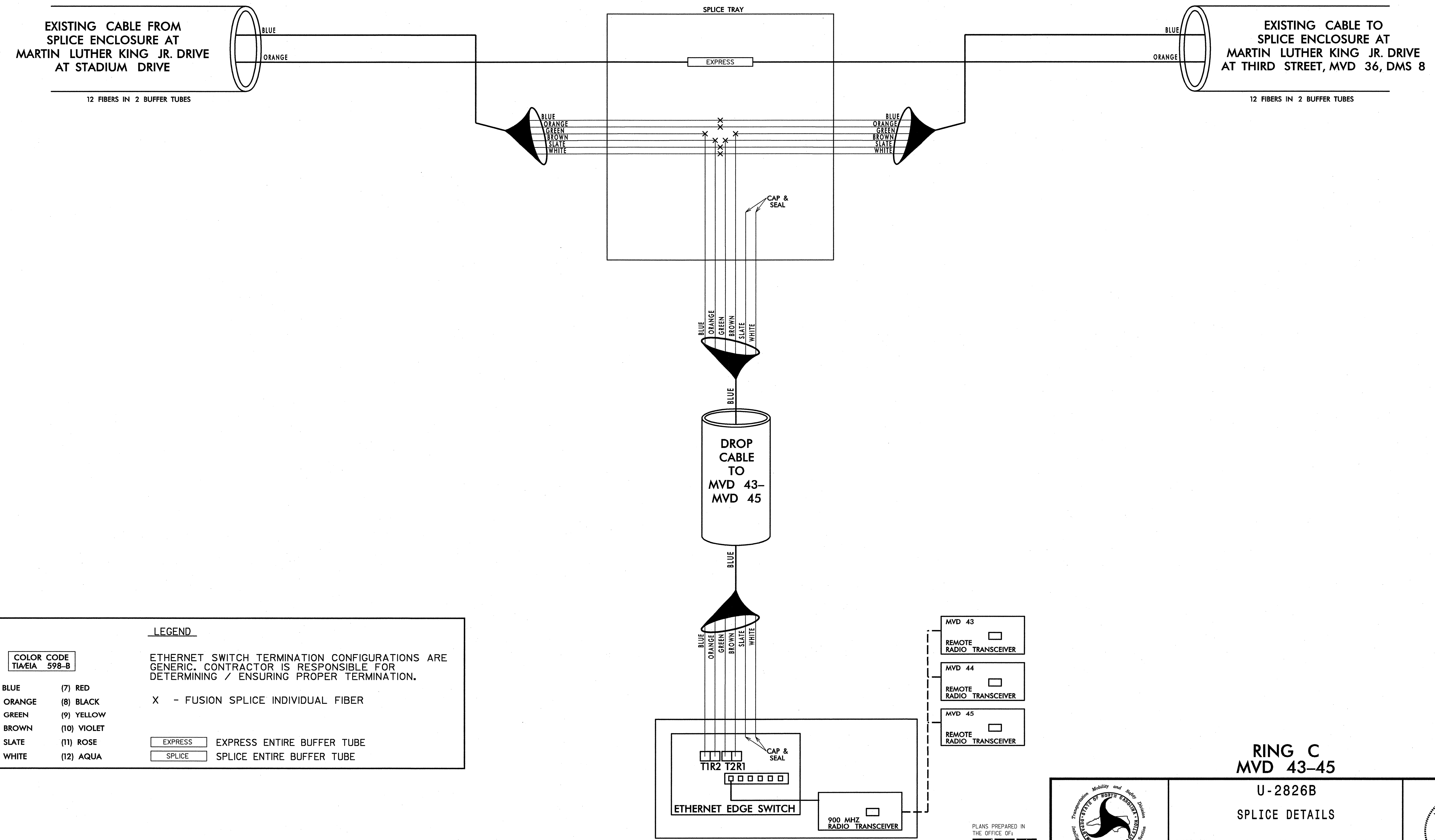

LEGEND

COLOR CODE TIA/EIA 598-B

| | | |
|------------|-------------|--|
| (1) BLUE | (7) RED | ETHERNET SWITCH TERMINATION CONFIGURATIONS ARE GENERIC. CONTRACTOR IS RESPONSIBLE FOR DETERMINING / ENSURING PROPER TERMINATION. |
| (2) ORANGE | (8) BLACK | |
| (3) GREEN | (9) YELLOW | |
| (4) BROWN | (10) VIOLET | |
| (5) SLATE | (11) ROSE | |
| (6) WHITE | (12) AQUA | |

X - FUSION SPLICE INDIVIDUAL FIBER

EXPRESS - EXPRESS ENTIRE BUFFER TUBE

SPLICE - SPLICE ENTIRE BUFFER TUBE

NOTES:
1. FIBER INTERCONNECT CENTER RACKS ARE SCHEMATIC ONLY - ACTUAL EQUIPMENT FORM MAY VARY.

**RING C
MVD 43-45**

U-2826B
SPLICE DETAILS

| | |
|---|--------------------------|
| DIVISION 9 FORSYTH COUNTY WINSTON SALEM | |
| PLAN DATE: JANUARY 2011 | REVIEWED BY: S. Phillips |
| PREPARED BY: J. Cross | REVIEWED BY: S. Privette |
| SCALE | REVISIONS |
| 0 | INIT. DATE |
| NONE | |

CADD Filename

PLANS PREPARED IN THE OFFICE OF:

Kimley-Horn and Associates, Inc.

P.O. Box 33068
Raleigh, N.C. 27636-3068
(919) 677-2000
N.C. License # F-0102

k:\ral_tpro_its\0106168-us 52_its (u-2826B)\plan\Splicing\SP104.dgn
 1/25/2011 11:47:36 AM jerry.cross

**SPLICE ENCLOSURE AT MVD 36, DMS 8
MARTIN LUTHER KING JR. DRIVE
AT THIRD STREET**

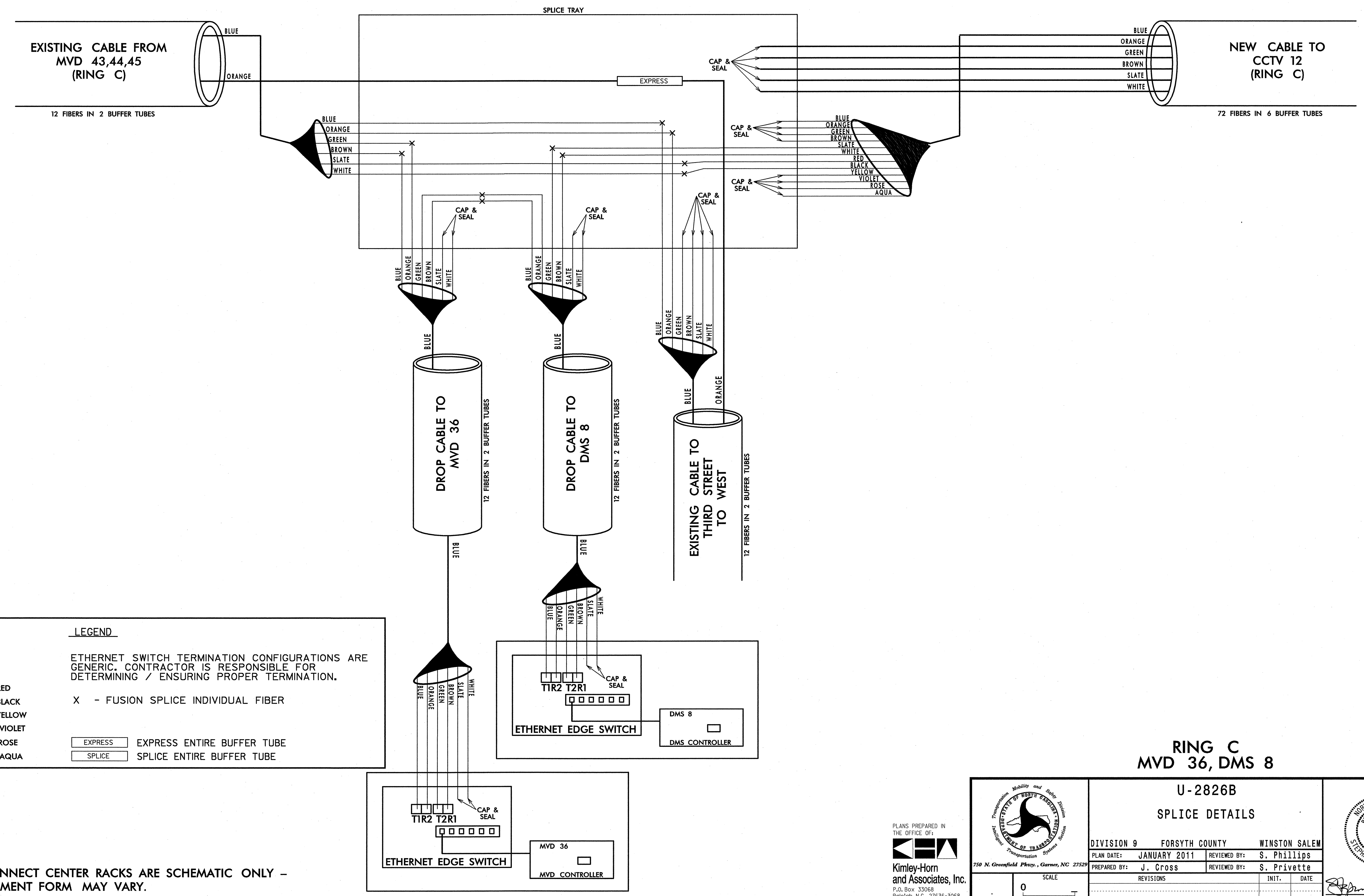

LEGEND

ETHERNET SWITCH TERMINATION CONFIGURATIONS ARE GENERIC. CONTRACTOR IS RESPONSIBLE FOR DETERMINING / ENSURING PROPER TERMINATION.

X - FUSION SPLICE INDIVIDUAL FIBER

| | |
|---------|----------------------------|
| EXPRESS | EXPRESS ENTIRE BUFFER TUBE |
| SPLICE | SPLICE ENTIRE BUFFER TUBE |

COLOR CODE TIA/EIA 598-B

| | |
|------------|-------------|
| (1) BLUE | (7) RED |
| (2) ORANGE | (8) BLACK |
| (3) GREEN | (9) YELLOW |
| (4) BROWN | (10) VIOLET |
| (5) SLATE | (11) ROSE |
| (6) WHITE | (12) AQUA |

NOTES:
1. FIBER INTERCONNECT CENTER RACKS ARE SCHEMATIC ONLY - ACTUAL EQUIPMENT FORM MAY VARY.

**RING C
MVD 36, DMS 8**

| | | | |
|-------------------|---|--|---|
| | U-2826B SPLICE DETAILS | | |
| | DIVISION 9 FORSYTH COUNTY WINSTON SALEM PLAN DATE: JANUARY 2011 REVIEWED BY: S. Phillips PREPARED BY: J. Cross REVIEWED BY: S. Privette | REVISIONS INIT. DATE _____ _____ | |
| SCALE NONE | SIGNATURE DATE 1/25/11 | | SEAL NORTH CAROLINA PROFESSIONAL ENGINEER SEAL 24432 STEPHANIE B. PRIVETTE |

PLANS PREPARED IN THE OFFICE OF:

Kimley-Horn and Associates, Inc.
 P.O. Box 33068
 Raleigh, N.C. 27636-3068
 (919) 677-2000
 N.C. License # F-0102

k:\real\proj_115\01086158-us_52_115 (U-2826B)\plan\SplTray.dwg SPL-05.dgn
 1/25/2011 11:47:37 AM jerry.cross

**SPLICE ENCLOSURE AT CCTV 12
MARTIN LUTHER KING JR. DRIVE
NORTH OF
NEW WALKERTOWN ROAD**

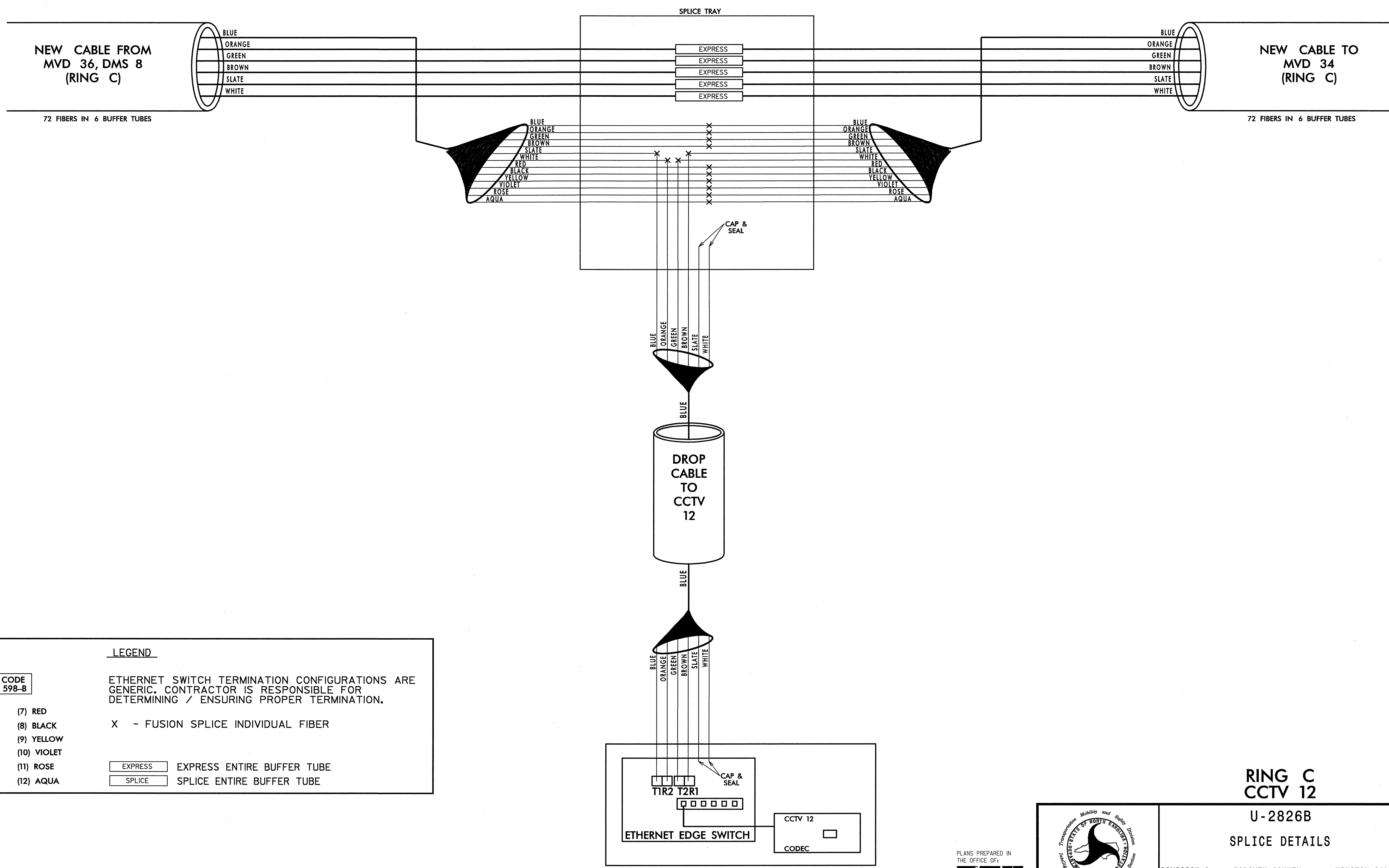

LEGEND

COLOR CODE
TIA/EIA 598-B

| | | |
|------------|-------------|--|
| (1) BLUE | (7) RED | ETHERNET SWITCH TERMINATION CONFIGURATIONS ARE GENERIC. CONTRACTOR IS RESPONSIBLE FOR DETERMINING / ENSURING PROPER TERMINATION. |
| (2) ORANGE | (8) BLACK | |
| (3) GREEN | (9) YELLOW | |
| (4) BROWN | (10) VIOLET | |
| (5) SLATE | (11) ROSE | |
| (6) WHITE | (12) AQUA | |

X - FUSION SPLICE INDIVIDUAL FIBER

EXPRESS - EXPRESS ENTIRE BUFFER TUBE

SPLICE - SPLICE ENTIRE BUFFER TUBE

NOTES:
1. FIBER INTERCONNECT CENTER RACKS ARE SCHEMATIC ONLY - ACTUAL EQUIPMENT FORM MAY VARY.

**RING C
CCTV 12**

**U-2826B
SPLICE DETAILS**

PLANS PREPARED IN THE OFFICE OF:
Kimley-Horn and Associates, Inc.
P.O. Box 33068
Raleigh, N.C. 27636-3068
(919) 677-2000
N.C. License # F-0102

| | | | |
|-----------------------|---|--------------------------|---------------|
| | DIVISION 9 FORSYTH COUNTY WINSTON SALEM | | |
| | PLAN DATE: JANUARY 2011 | REVIEWED BY: S. Phillips | |
| PREPARED BY: J. Cross | REVISIONS | INIT. | DATE |
| SCALE 0 NONE | SIGNATURE <i>J. Cross</i> | DATE 1-25-11 | SEAL 24432 |

k:\nd\proj\fa\01086158-us_52_tss (u-2826B)\plan\splice.dwg SPL06.dgn
 1/25/2011 11:47:38 AM jerry.cross

**SPLICE ENCLOSURE AT MVD 34
MARTIN LUTHER KING JR. DRIVE
NORTH OF HIGHLAND AVENUE**

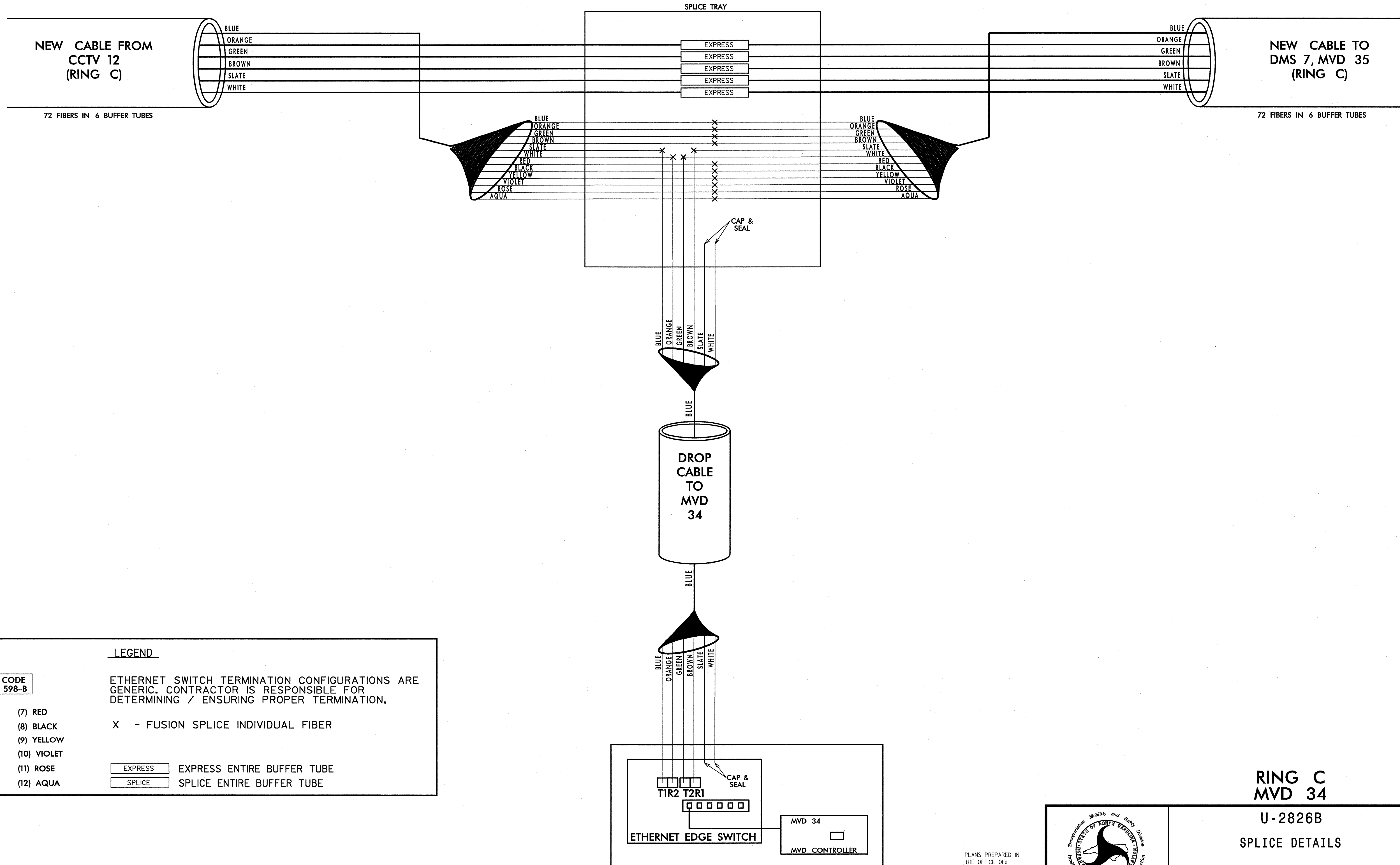

LEGEND

ETHERNET SWITCH TERMINATION CONFIGURATIONS ARE GENERIC. CONTRACTOR IS RESPONSIBLE FOR DETERMINING / ENSURING PROPER TERMINATION.

X - FUSION SPLICE INDIVIDUAL FIBER

| | |
|---------|----------------------------|
| EXPRESS | EXPRESS ENTIRE BUFFER TUBE |
| SPLICE | SPLICE ENTIRE BUFFER TUBE |

| COLOR CODE TIA/EIA 598-B | |
|-----------------------------|-------------|
| (1) BLUE | (7) RED |
| (2) ORANGE | (8) BLACK |
| (3) GREEN | (9) YELLOW |
| (4) BROWN | (10) VIOLET |
| (5) SLATE | (11) ROSE |
| (6) WHITE | (12) AQUA |

NOTES:
1. FIBER INTERCONNECT CENTER RACKS ARE SCHEMATIC ONLY - ACTUAL EQUIPMENT FORM MAY VARY.

**RING C
MVD 34**

**U-2826B
SPLICE DETAILS**

| | |
|---|--------------------------|
| DIVISION 9 FORSYTH COUNTY WINSTON SALEM | |
| PLAN DATE: JANUARY 2011 | REVIEWED BY: S. Phillips |
| PREPARED BY: J. Cross | REVIEWED BY: S. Privette |
| REVISIONS | INIT. DATE |
| | |

SCALE: NONE

SEAL: NORTH CAROLINA PROFESSIONAL ENGINEER SEAL 24432 STEPHANIE B. PRIVETTE

SIGNATURE: [Signature] DATE: 1-25-11

PLANS PREPARED IN THE OFFICE OF:
Kimley-Horn and Associates, Inc.
P.O. Box 33068
Raleigh, N.C. 27636-3068
(919) 677-2000
N.C. License # F-0102

1/25/2011 11:47:39 AM jerry.cross k:\nal_tproj_11s\01036158-us_52_11s (u-2826b)\dms\Splicing\SP1.07.dgn

**SPLICE ENCLOSURE AT
DMS 7, MVD 35
US 52 SOUTH OF MARTIN LUTHER
KING JUNIOR DRIVE**

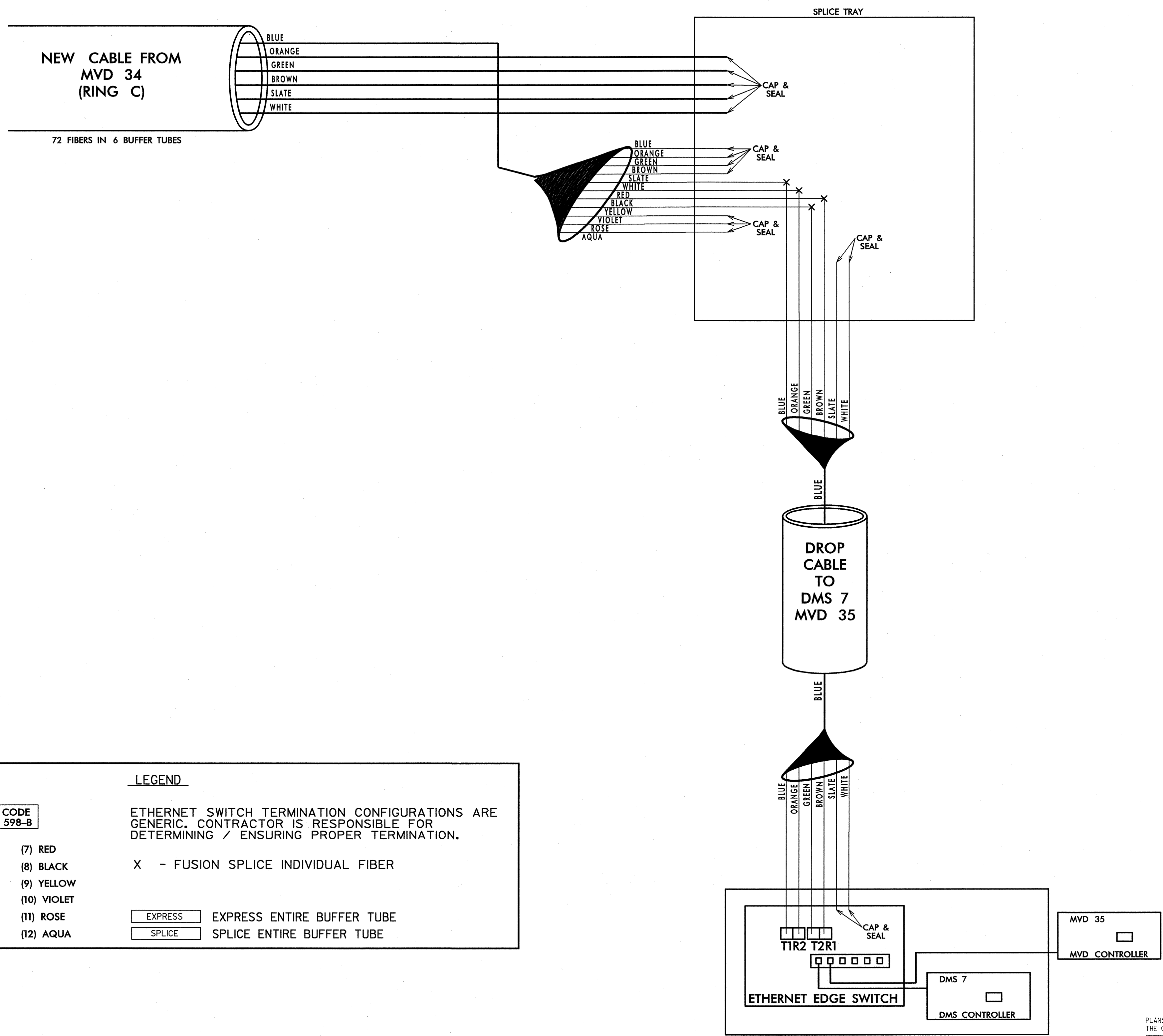

LEGEND

| | | |
|------------------------------------|-------------|--|
| COLOR CODE TIA/EIA 598-B | | ETHERNET SWITCH TERMINATION CONFIGURATIONS ARE GENERIC. CONTRACTOR IS RESPONSIBLE FOR DETERMINING / ENSURING PROPER TERMINATION. |
| (1) BLUE | (7) RED | X - FUSION SPLICE INDIVIDUAL FIBER |
| (2) ORANGE | (8) BLACK | |
| (3) GREEN | (9) YELLOW | |
| (4) BROWN | (10) VIOLET | |
| (5) SLATE | (11) ROSE | EXPRESS ENTIRE BUFFER TUBE |
| (6) WHITE | (12) AQUA | SPLICE ENTIRE BUFFER TUBE |

NOTES:
1. FIBER INTERCONNECT CENTER RACKS ARE SCHEMATIC ONLY - ACTUAL EQUIPMENT FORM MAY VARY.

**RING C
DMS 7, MVD 35**

**U-2826B
SPLICE DETAILS**

| | |
|---|--------------------------|
| DIVISION 9 FORSYTH COUNTY WINSTON SALEM | |
| PLAN DATE: JANUARY 2011 | REVIEWED BY: S. Phillips |
| PREPARED BY: J. Cross | REVIEWED BY: S. Privette |
| SCALE | REVISIONS |
| 0 | INIT. DATE |
| NONE | |

CADD Filename:

PLANS PREPARED IN THE OFFICE OF:
Kimley-Horn and Associates, Inc.
P.O. Box 33068
Raleigh, N.C. 27636-3068
(919) 677-2000
N.C. License # F-0102

k:\na1_tproj_11s\0103859-us_52_11s (u-2826b)\na1m\Splicing\SP108.dgn
 1/25/2011 11:47:40 AM jerry.cross

**SPLICE ENCLOSURE
VARGRAVE STREET AT
PARKVIEW STREET**

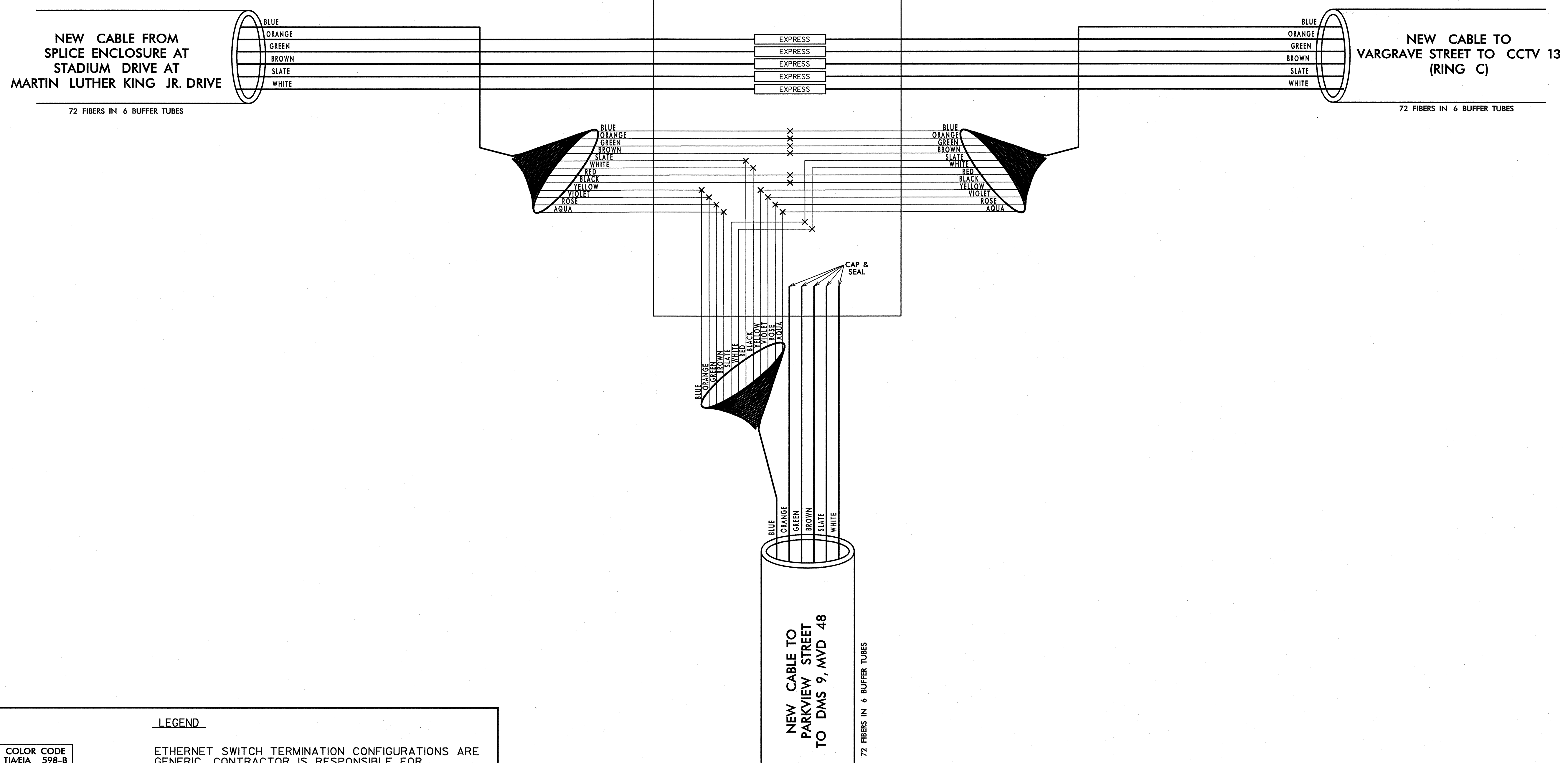

COLOR CODE
TIA/EIA 598-B

| | | |
|------------|-------------|--|
| (1) BLUE | (7) RED | <p>LEGEND</p> <p>ETHERNET SWITCH TERMINATION CONFIGURATIONS ARE GENERIC. CONTRACTOR IS RESPONSIBLE FOR DETERMINING / ENSURING PROPER TERMINATION.</p> <p>X - FUSION SPLICE INDIVIDUAL FIBER</p> <p>EXPRESS - EXPRESS ENTIRE BUFFER TUBE</p> <p>SPLICE - SPLICE ENTIRE BUFFER TUBE</p> |
| (2) ORANGE | (8) BLACK | |
| (3) GREEN | (9) YELLOW | |
| (4) BROWN | (10) VIOLET | |
| (5) SLATE | (11) ROSE | |
| (6) WHITE | (12) AQUA | |

NOTES:
1. FIBER INTERCONNECT CENTER RACKS ARE SCHEMATIC ONLY - ACTUAL EQUIPMENT FORM MAY VARY.

PLANS PREPARED IN THE OFFICE OF:
Kimley-Horn and Associates, Inc.
P.O. Box 33068
Raleigh, N.C. 27636-3068
(919) 677-2000
N.C. License # F-0102

RING C

U-2826B

SPLICE DETAILS

| | | |
|---|--------------------------|----------------------------|
| DIVISION 9 FORSYTH COUNTY WINSTON SALEM | | |
| PLAN DATE: JANUARY 2011 | REVIEWED BY: S. Phillips | |
| PREPARED BY: J. Cross | REVIEWED BY: S. Privette | <p>1/25/11</p> <p>DATE</p> |
| SCALE: NONE | REVISIONS | |

1/25/2011 11:47:41 AM jbrty.cross k:\na1\proj_11s\011088158-us_82_11s (u-2826B)\plan\Spllicing\SPC09.dgn

**SPLICE ENCLOSURE AT CCTV 13
US 52 SOUTH OF STADIUM DRIVE**

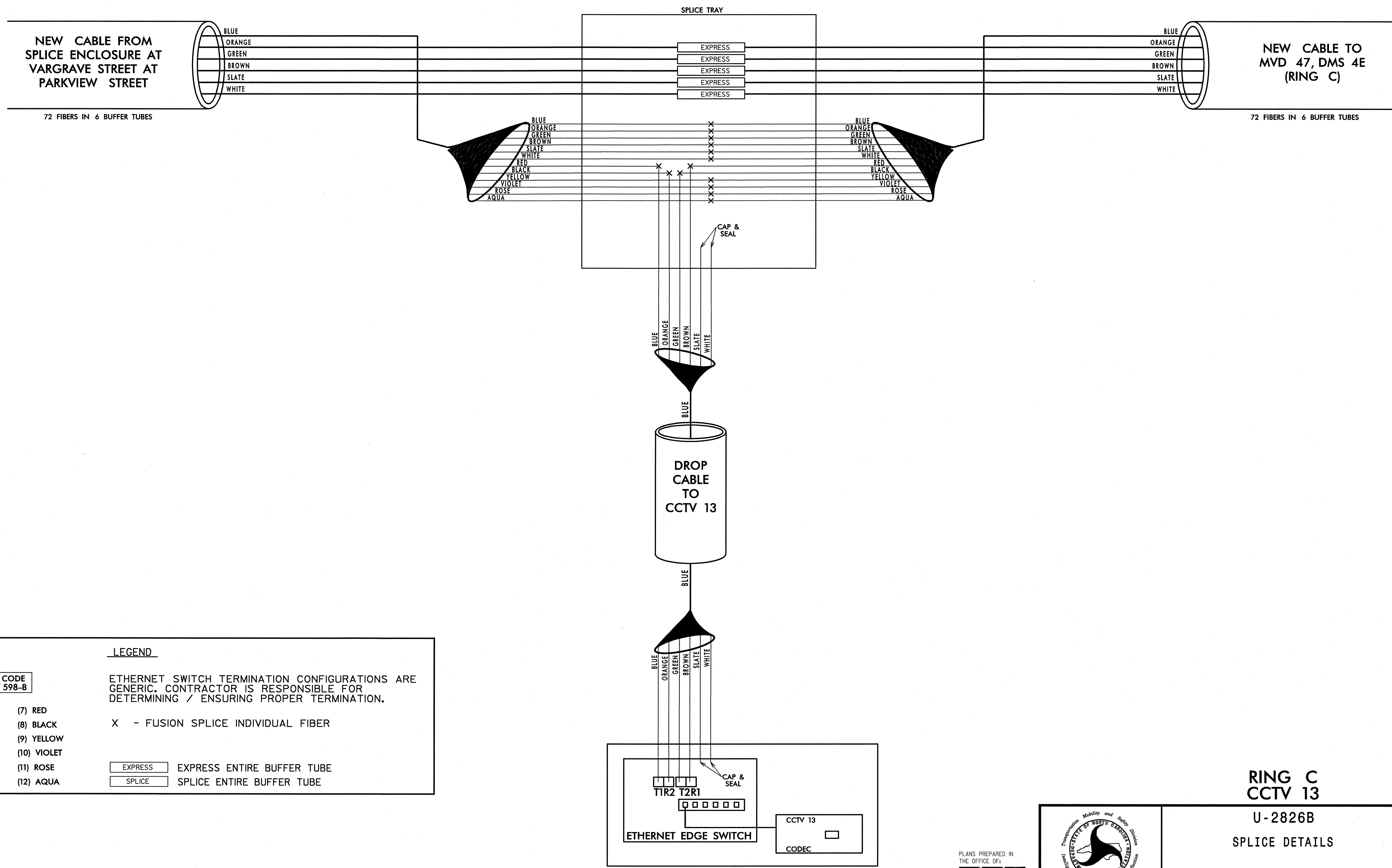

LEGEND

| | | |
|------------------------------------|-------------|--|
| COLOR CODE TIA/EIA 598-B | | ETHERNET SWITCH TERMINATION CONFIGURATIONS ARE GENERIC. CONTRACTOR IS RESPONSIBLE FOR DETERMINING / ENSURING PROPER TERMINATION. |
| (1) BLUE | (7) RED | X - FUSION SPLICE INDIVIDUAL FIBER |
| (2) ORANGE | (8) BLACK | |
| (3) GREEN | (9) YELLOW | |
| (4) BROWN | (10) VIOLET | |
| (5) SLATE | (11) ROSE | EXPRESS ENTIRE BUFFER TUBE |
| (6) WHITE | (12) AQUA | SPLICE ENTIRE BUFFER TUBE |

NOTES:
1. FIBER INTERCONNECT CENTER RACKS ARE SCHEMATIC ONLY - ACTUAL EQUIPMENT FORM MAY VARY.

**RING C
CCTV 13**

**U-2826B
SPLICE DETAILS**

| | | | |
|-----------------------|---|--------------------------|---------------|
| | DIVISION 9 FORSYTH COUNTY WINSTON SALEM | | |
| | PLAN DATE: JANUARY 2011 | REVIEWED BY: S. Phillips | |
| PREPARED BY: J. Cross | REVISIONS | INIT. | DATE |
| SCALE 0 NONE | SIGNATURE <i>[Signature]</i> | DATE 1-25-11 | SEAL 24432 |

PLANS PREPARED IN THE OFFICE OF:
Kimley-Horn and Associates, Inc.
P.O. Box 33068
Raleigh, N.C. 27636-3068
(919) 677-2000
N.C. License # F-0102

k:\val_tproj_11s\011086158-us 52_11s (u-2826B)\plan\Spl10.dwg
 1/25/2011 11:47:42 AM jerry.cross

**SPLICE ENCLOSURE AT
DMS 4E, MVD 47
US 52 SOUTH OF DIGGS BLVD.**

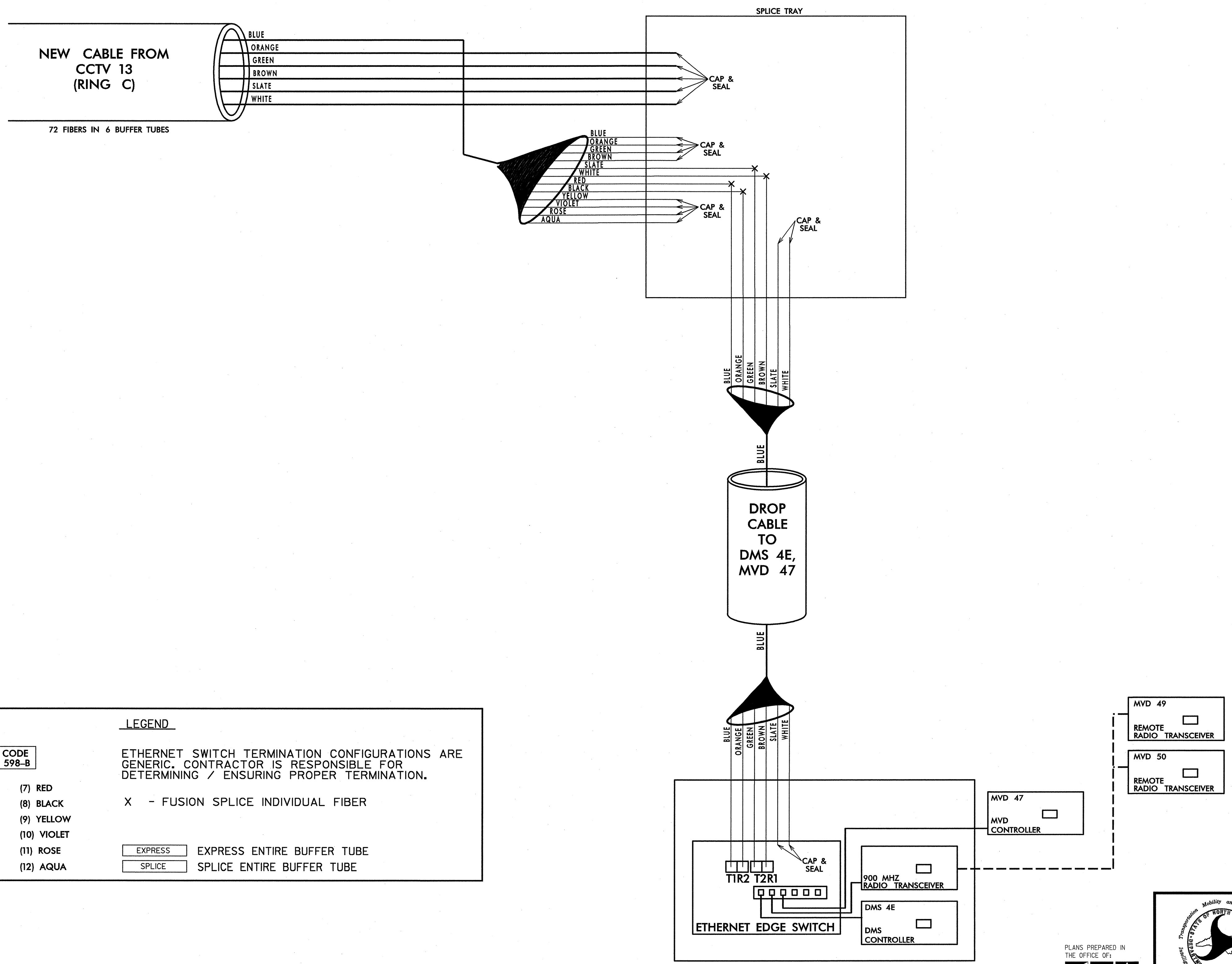

LEGEND

ETHERNET SWITCH TERMINATION CONFIGURATIONS ARE GENERIC. CONTRACTOR IS RESPONSIBLE FOR DETERMINING / ENSURING PROPER TERMINATION.

X - FUSION SPLICE INDIVIDUAL FIBER

| COLOR CODE TIA/EIA 598-B | |
|-----------------------------|-------------|
| (1) BLUE | (7) RED |
| (2) ORANGE | (8) BLACK |
| (3) GREEN | (9) YELLOW |
| (4) BROWN | (10) VIOLET |
| (5) SLATE | (11) ROSE |
| (6) WHITE | (12) AQUA |

EXPRESS EXPRESS ENTIRE BUFFER TUBE
SPLICE SPLICE ENTIRE BUFFER TUBE

NOTES:
1. FIBER INTERCONNECT CENTER RACKS ARE SCHEMATIC ONLY - ACTUAL EQUIPMENT FORM MAY VARY.

**RING C
DMS 4E, MVD 47, MVD 49, MVD 50**

PLANS PREPARED IN THE OFFICE OF:
Kimley-Horn and Associates, Inc.
P.O. Box 33068
Raleigh N.C. 27636-3068
(919) 677-2000
N.C. License # F-002

| | | |
|--------------------|--|--|
| | U-2826B SPLICE DETAILS | |
| | DIVISION 9 FORSYTH COUNTY WINSTON SALEM | |
| | PLAN DATE: JANUARY 2011 PREPARED BY: J. Cross | REVIEWED BY: S. Phillips REVIEWED BY: S. Privette |
| SCALE 0 NONE | REVISIONS INIT. DATE | SIGNATURE DATE CADD Filename |

1/25/2011 11:47:43 AM jerry.cross k:\p1\proj\proj_135\0106658-us 52_115 (u-2826B)\p1\an\splice.spl 11.dgn

**SPLICE ENCLOSURE AT
DMS 9, MVD 48
MARTIN LUTHER KING JR. DRIVE
SOUTH OF WILLIAMSON STREET**

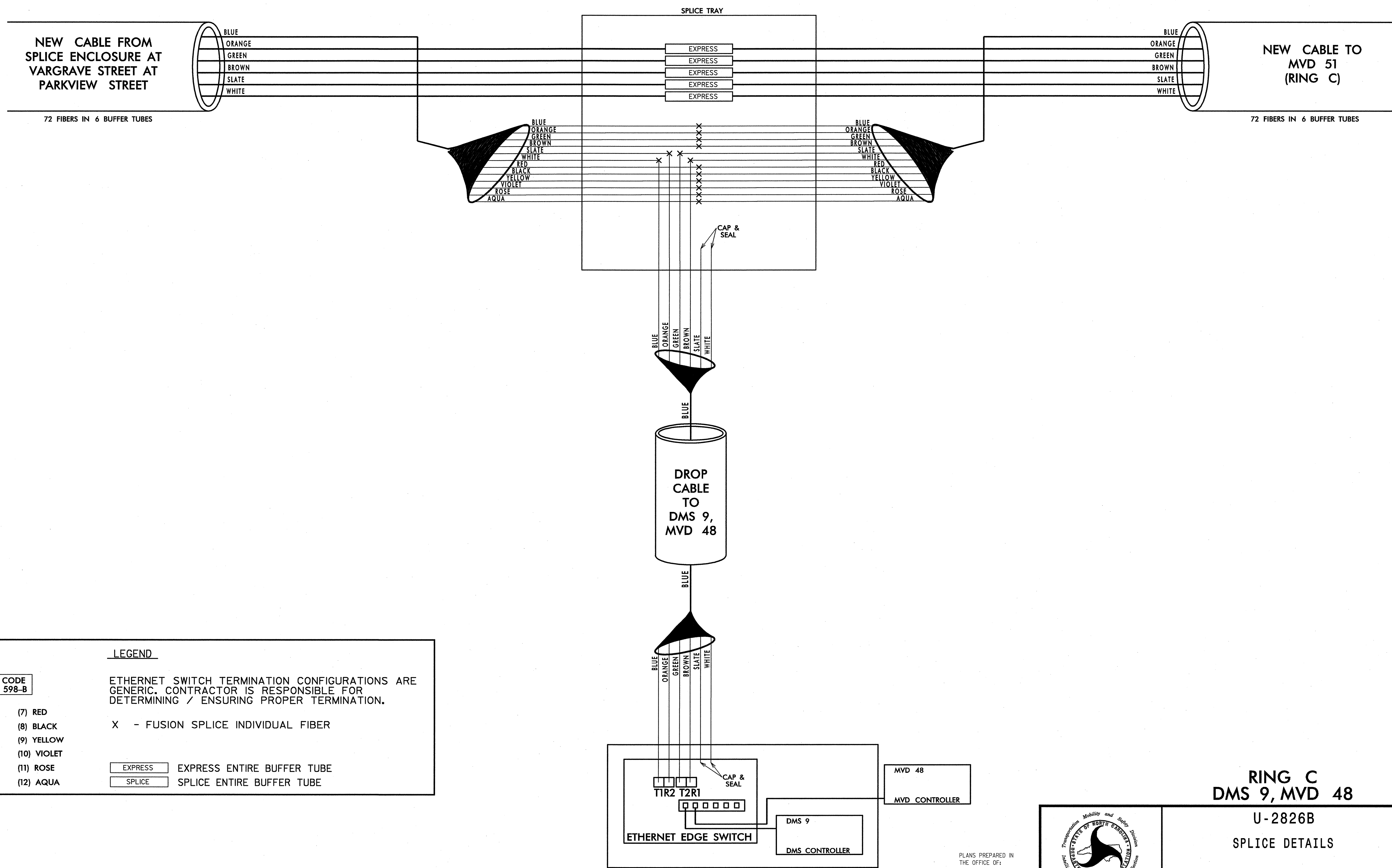

LEGEND

COLOR CODE TIA/EIA 598-B

| | | |
|------------|-------------|---|
| (1) BLUE | (7) RED | X - FUSION SPLICE INDIVIDUAL FIBER EXPRESS ENTIRE BUFFER TUBE SPLICE ENTIRE BUFFER TUBE |
| (2) ORANGE | (8) BLACK | |
| (3) GREEN | (9) YELLOW | |
| (4) BROWN | (10) VIOLET | |
| (5) SLATE | (11) ROSE | |
| (6) WHITE | (12) AQUA | |

ETHERNET SWITCH TERMINATION CONFIGURATIONS ARE GENERIC. CONTRACTOR IS RESPONSIBLE FOR DETERMINING / ENSURING PROPER TERMINATION.

NOTES:
1. FIBER INTERCONNECT CENTER RACKS ARE SCHEMATIC ONLY - ACTUAL EQUIPMENT FORM MAY VARY.

**RING C
DMS 9, MVD 48**

**U-2826B
SPLICE DETAILS**

PLANS PREPARED IN THE OFFICE OF:
Kimley-Horn and Associates, Inc.
P.O. Box 33068
Raleigh, N.C. 27636-3068
(919) 677-2000
N.C. License # F-0102

| | | | |
|--|---|-------------------------|---|
| | DIVISION 9 FORSYTH COUNTY WINSTON SALEM PLAN DATE: JANUARY 2011 REVIEWED BY: S. Phillips PREPARED BY: J. Cross REVIEWED BY: S. Privette | | SEAL NORTH CAROLINA PROFESSIONAL ENGINEER SEAL 24432 STEPHANIE B. PRIVETTE |
| | SCALE 0 NONE | REVISIONS INIT. DATE | |

k:\na1\proj_11s\01036158-us_11s (u-2826B)\plan\Spllicing(SPL12).dgn
 1/25/2011 11:47:44 AM jerry.cross

**SPLICE ENCLOSURE AT MVD 51
THOMASVILLE ROAD SOUTH OF
GOLDFLOSS STREET**

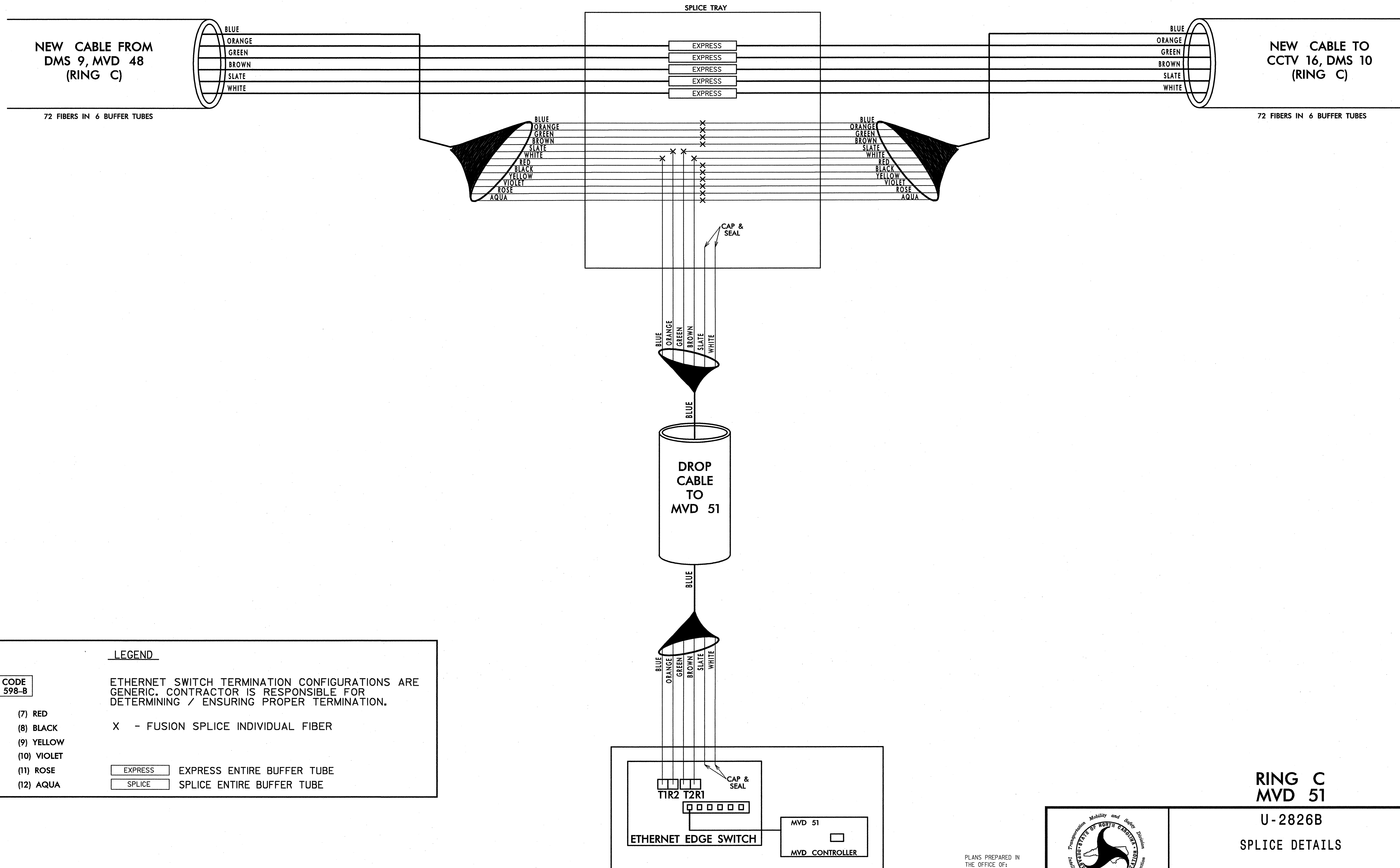

LEGEND

COLOR CODE
TIA/EIA 598-B

| | | |
|------------|-------------|--|
| (1) BLUE | (7) RED | ETHERNET SWITCH TERMINATION CONFIGURATIONS ARE GENERIC. CONTRACTOR IS RESPONSIBLE FOR DETERMINING / ENSURING PROPER TERMINATION. |
| (2) ORANGE | (8) BLACK | |
| (3) GREEN | (9) YELLOW | |
| (4) BROWN | (10) VIOLET | |
| (5) SLATE | (11) ROSE | |
| (6) WHITE | (12) AQUA | |

X - FUSION SPLICE INDIVIDUAL FIBER

| | |
|--|----------------------------|
| | EXPRESS ENTIRE BUFFER TUBE |
| | SPLICE ENTIRE BUFFER TUBE |

NOTES:
1. FIBER INTERCONNECT CENTER RACKS ARE SCHEMATIC ONLY - ACTUAL EQUIPMENT FORM MAY VARY.

**RING C
MVD 51**

**U-2826B
SPLICE DETAILS**

PLANS PREPARED IN THE OFFICE OF:

Kimley-Horn and Associates, Inc.
P.O. Box 33068
Raleigh N.C. 27636-3068
(919) 617-2000
N.C. License # F-0102

| | | | |
|---|---|--------------------------|-----------------------------------|
| 750 N. Greenfield Place, Garner, NC 27529 | DIVISION 9 FORSYTH COUNTY WINSTON SALEM | | SEAL STEPHANIE B. PRIVETTE |
| | PLAN DATE: JANUARY 2011 | REVIEWED BY: S. Phillips | |
| SCALE | REVISIONS | INIT. | DATE |
| SIGNATURE: | | DATE: 1/25/11 | |

k:\real_tproj_11a\01080618b-us_p2_11a (U-2826B)\plan\SpliceEnclosureSPL13.dgn
 1/25/2011 11:47:45 AM jerry.cross

**SPLICE ENCLOSURE AT
CCTV 16, DMS 10
I-40 NEAR THOMASVILLE ROAD**

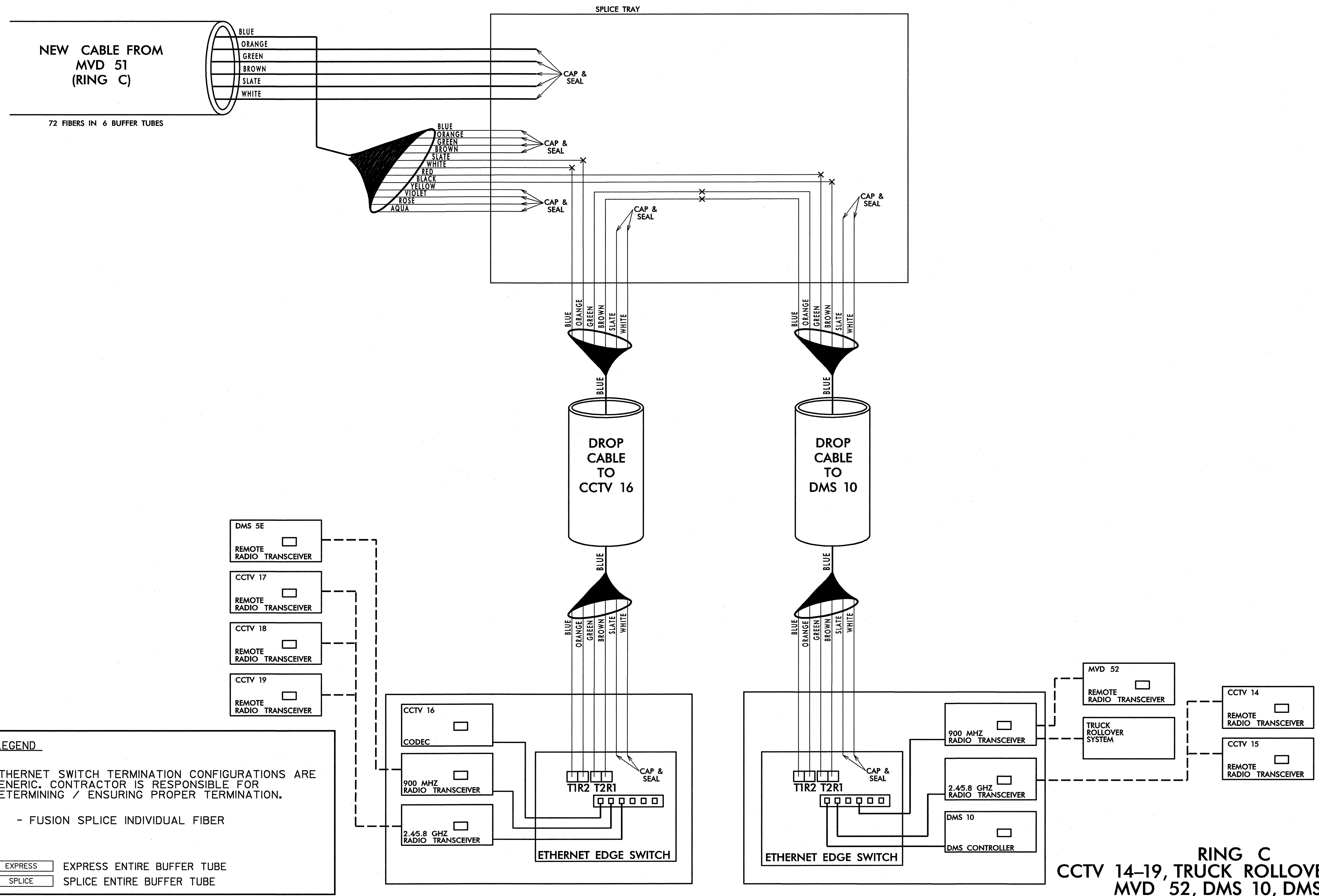

LEGEND

ETHERNET SWITCH TERMINATION CONFIGURATIONS ARE GENERIC. CONTRACTOR IS RESPONSIBLE FOR DETERMINING / ENSURING PROPER TERMINATION.

X - FUSION SPLICE INDIVIDUAL FIBER

EXPRESS - EXPRESS ENTIRE BUFFER TUBE
SPLICE - SPLICE ENTIRE BUFFER TUBE

| COLOR CODE TIA/EIA 598-B | |
|-----------------------------|-------------|
| (1) BLUE | (7) RED |
| (2) ORANGE | (8) BLACK |
| (3) GREEN | (9) YELLOW |
| (4) BROWN | (10) VIOLET |
| (5) SLATE | (11) ROSE |
| (6) WHITE | (12) AQUA |

NOTES:
1. FIBER INTERCONNECT CENTER RACKS ARE SCHEMATIC ONLY - ACTUAL EQUIPMENT FORM MAY VARY.

**RING C
CCTV 14-19, TRUCK ROLLOVER SYSTEM
MVD 52, DMS 10, DMS 5E**

PLANS PREPARED IN THE OFFICE OF:
Kimley-Horn and Associates, Inc.
P.O. Box 33068
Raleigh, N.C. 27636-3068
(919) 677-2000
N.C. License # F-0102

| | | | |
|--|--|-------------|--|
| | U-2826B | | |
| | SPLICE DETAILS | | |
| | DIVISION 9 FORSYTH COUNTY WINSTON SALEM | | |
| PLAN DATE: JANUARY 2011 PREPARED BY: J. Cross | REVIEWED BY: S. Phillips REVIEWED BY: S. Privette | SCALE: NONE | SIGNATURE: <i>S. Phillips</i> 1/25/11 DATE: |

1/25/2011 11:47:46 AM jbrty_cross k:\ra\proj\14s\01086156.us_02_11s (U-2826B)\plan\splice.dwg SPL-14.dwg

**SPLICE ENCLOSURE AT
CCTV 5E, MVD 42
US 421 WEST OF SALEM AVENUE**

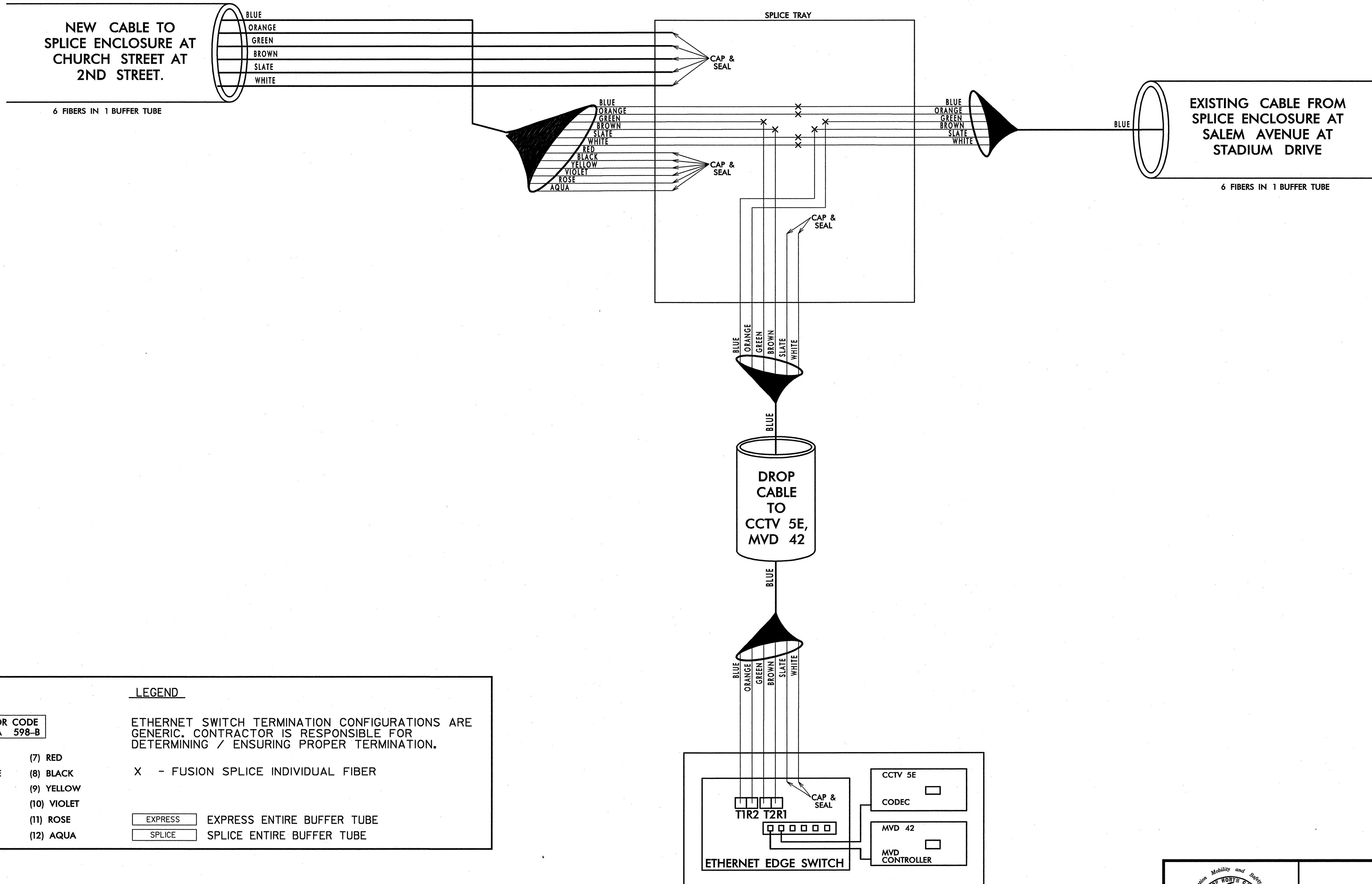

| COLOR CODE TIA/EIA 598-B | | LEGEND | |
|-----------------------------|-------------|--|----------------------------------|
| (1) BLUE | (7) RED | ETHERNET SWITCH TERMINATION CONFIGURATIONS ARE GENERIC. CONTRACTOR IS RESPONSIBLE FOR DETERMINING / ENSURING PROPER TERMINATION. | |
| (2) ORANGE | (8) BLACK | X | - FUSION SPLICE INDIVIDUAL FIBER |
| (3) GREEN | (9) YELLOW | | |
| (4) BROWN | (10) VIOLET | | |
| (5) SLATE | (11) ROSE | EXPRESS | EXPRESS ENTIRE BUFFER TUBE |
| (6) WHITE | (12) AQUA | SPLICE | SPLICE ENTIRE BUFFER TUBE |

NOTES:
1. FIBER INTERCONNECT CENTER RACKS ARE SCHEMATIC ONLY - ACTUAL EQUIPMENT FORM MAY VARY.

**RING B
MVD 42**

**U-2826B
SPLICE DETAILS**

PLANS PREPARED IN THE OFFICE OF:
Kimley-Horn and Associates, Inc.
P.O. Box 33068
Raleigh, N.C. 27636-3068
(919) 617-2000
N.C. License # F-0102

750 N. Greenfield Pkwy., Garner, NC 27529

| | |
|---|--------------------------|
| DIVISION 9 FORSYTH COUNTY WINSTON SALEM | |
| PLAN DATE: JANUARY 2011 | REVIEWED BY: S. Phillips |
| PREPARED BY: J. Cross | REVIEWED BY: S. Privette |
| SCALE | REVISIONS |
| 0 | INIT. DATE |
| NONE | |

SEAL

STEPHANIE B. PRIVETTE
ENGINEER
SEAL 24432

SIGNATURE: *[Signature]* DATE: 1-25-11
CADD Filename:

1/25/2011 11:47:47 AM jbrty_cross k:\ral_gpro_1\3101086158-us_82_118 (U-2826B)\plan\Splice.dwg SPL15.dgn

**BRYCE A. STUART
MUNICIPAL BUILDING
3RD FLOOR SERVER ROOM**

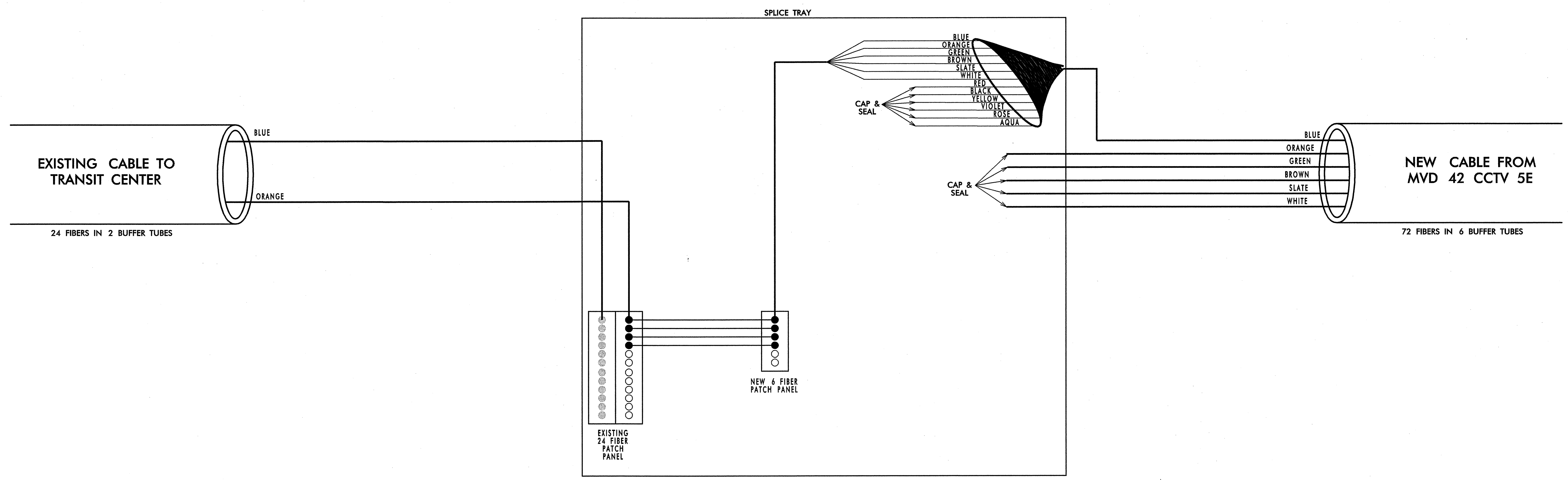

LEGEND

COLOR CODE TIA/EIA 598-B

| | | |
|------------|-------------|--|
| (1) BLUE | (7) RED | ETHERNET SWITCH TERMINATION CONFIGURATIONS ARE GENERIC. CONTRACTOR IS RESPONSIBLE FOR DETERMINING / ENSURING PROPER TERMINATION. |
| (2) ORANGE | (8) BLACK | |
| (3) GREEN | (9) YELLOW | |
| (4) BROWN | (10) VIOLET | |
| (5) SLATE | (11) ROSE | |
| (6) WHITE | (12) AQUA | |

X - FUSION SPLICE INDIVIDUAL FIBER

EXPRESS - EXPRESS ENTIRE BUFFER TUBE

SPLICE - SPLICE ENTIRE BUFFER TUBE

k:\na1_tproj_115101038158-us_52_115 (U-2826B)\plan\Splicing\SP116.dgn
1/25/2011 11:47:48 AM jerry.cross

RING A, RING B

PLANS PREPARED IN THE OFFICE OF:
Kimley-Horn and Associates, Inc.
P.O. Box 33068
Raleigh N.C. 27636-3068
(919) 677-2000
N.C. License # F-0102

| | | | |
|-------------------------|---|-------|---|
| | U-2826B SPLICE DETAILS | | SEAL |
| | DIVISION 9 FORSYTH COUNTY WINSTON SALEM | | |
| PLAN DATE: JANUARY 2011 | REVIEWED BY: S. Phillips | | SIGNATURE: <i>S. Phillips</i> DATE: 1-25-11 |
| PREPARED BY: J. Cross | REVIEWED BY: S. Privette | | |
| SCALE 0 NONE | REVISIONS | INIT. | DATE |

WINSTON SALEM
TRANSIT CENTER

EXISTING CABLE
FROM
CITY HALL

EXISTING CABLE FROM
BRYCE A. STUART MUNICIPAL
BUILDING

CITY HALL

FOR REFERENCE ONLY

EXISTING CABLE
TO MVD 32
(RING B)

k:\ncal_tproj_118\011026158-us_02_118 (u-2826B)\plan\SplDetail\SP116A.dgn

36 FIBERS IN 6 BUFFER TUBES

48 FIBERS IN 4 BUFFER TUBES

24 FIBERS IN 2 BUFFER TUBES

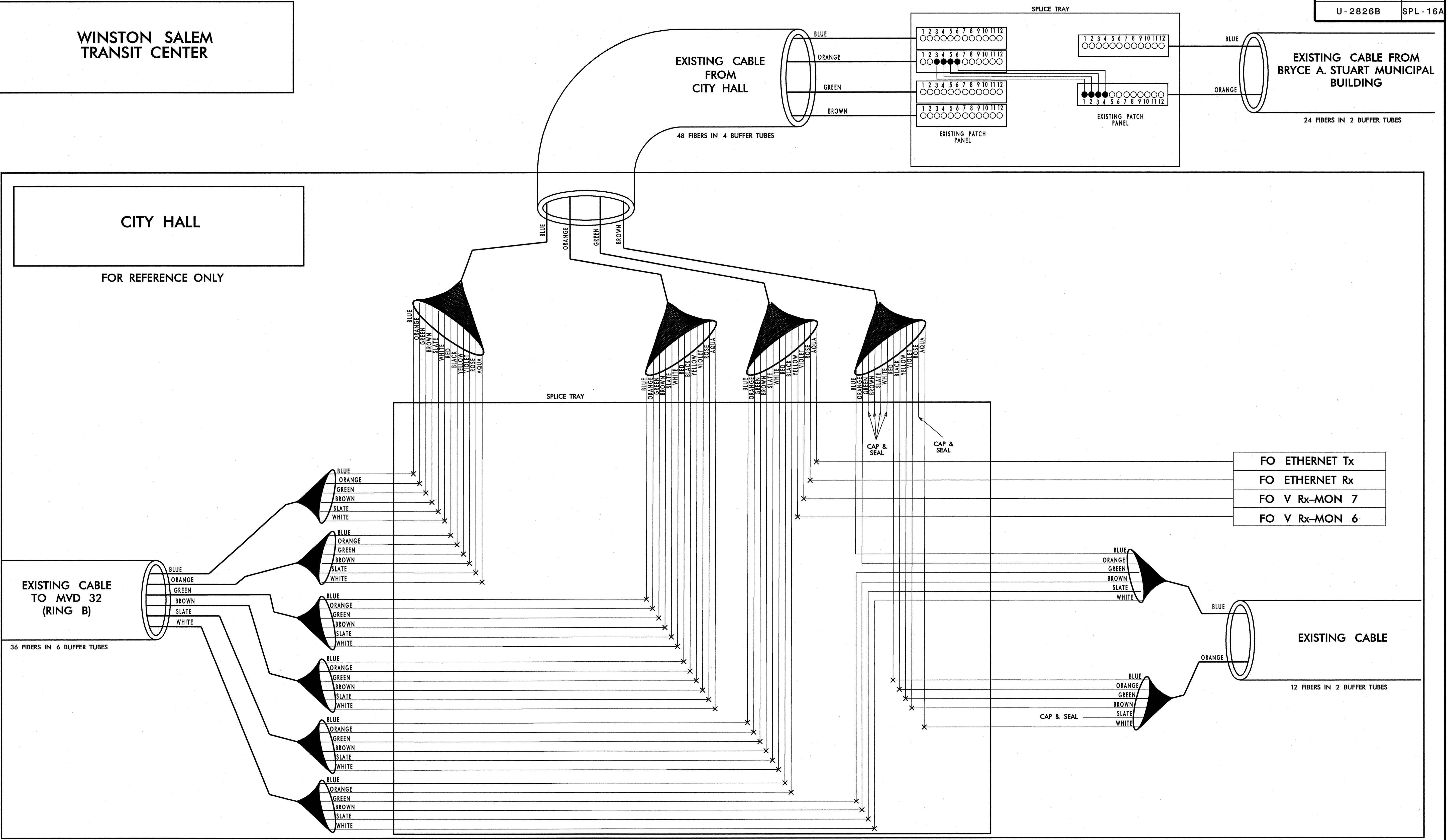

- FO ETHERNET Tx
- FO ETHERNET Rx
- FO V Rx-MON 7
- FO V Rx-MON 6

RING A, RING B

LEGEND

ETHERNET SWITCH TERMINATION CONFIGURATIONS ARE GENERIC. CONTRACTOR IS RESPONSIBLE FOR DETERMINING / ENSURING PROPER TERMINATION.

X - FUSION SPLICE INDIVIDUAL FIBER

| | |
|---------|----------------------------|
| EXPRESS | EXPRESS ENTIRE BUFFER TUBE |
| SPLICE | SPLICE ENTIRE BUFFER TUBE |

| | |
|---------------------------------|-------------|
| COLOR CODE TIA/EIA 598-B | |
| (1) BLUE | (7) RED |
| (2) ORANGE | (8) BLACK |
| (3) GREEN | (9) YELLOW |
| (4) BROWN | (10) VIOLET |
| (5) SLATE | (11) ROSE |
| (6) WHITE | (12) AQUA |

PLANS PREPARED IN THE OFFICE OF:

Kimley-Horn and Associates, Inc.
P.O. Box 33068
Raleigh N.C. 27636-3068
(919) 677-2000
N.C. License # F-002

| | | | |
|-----------------------|---|--------------------------|------|
| | U-2826B | | |
| | SPLICE DETAILS | | |
| | DIVISION 9 FORSYTH COUNTY WINSTON SALEM | | |
| | PLAN DATE: JANUARY 2011 | REVIEWED BY: S. Phillips | |
| PREPARED BY: J. Cross | REVIEWED BY: S. Privette | INIT. | DATE |
| | | | |
| SCALE: NONE | | DATE: 1-25-11 | |

1/25/2011 11:47:49 AM jerry.cross

**SPLICE ENCLOSURE AT MVD 32
UNIVERSITY PARKWAY
SOUTH OF GLENN AVENUE**

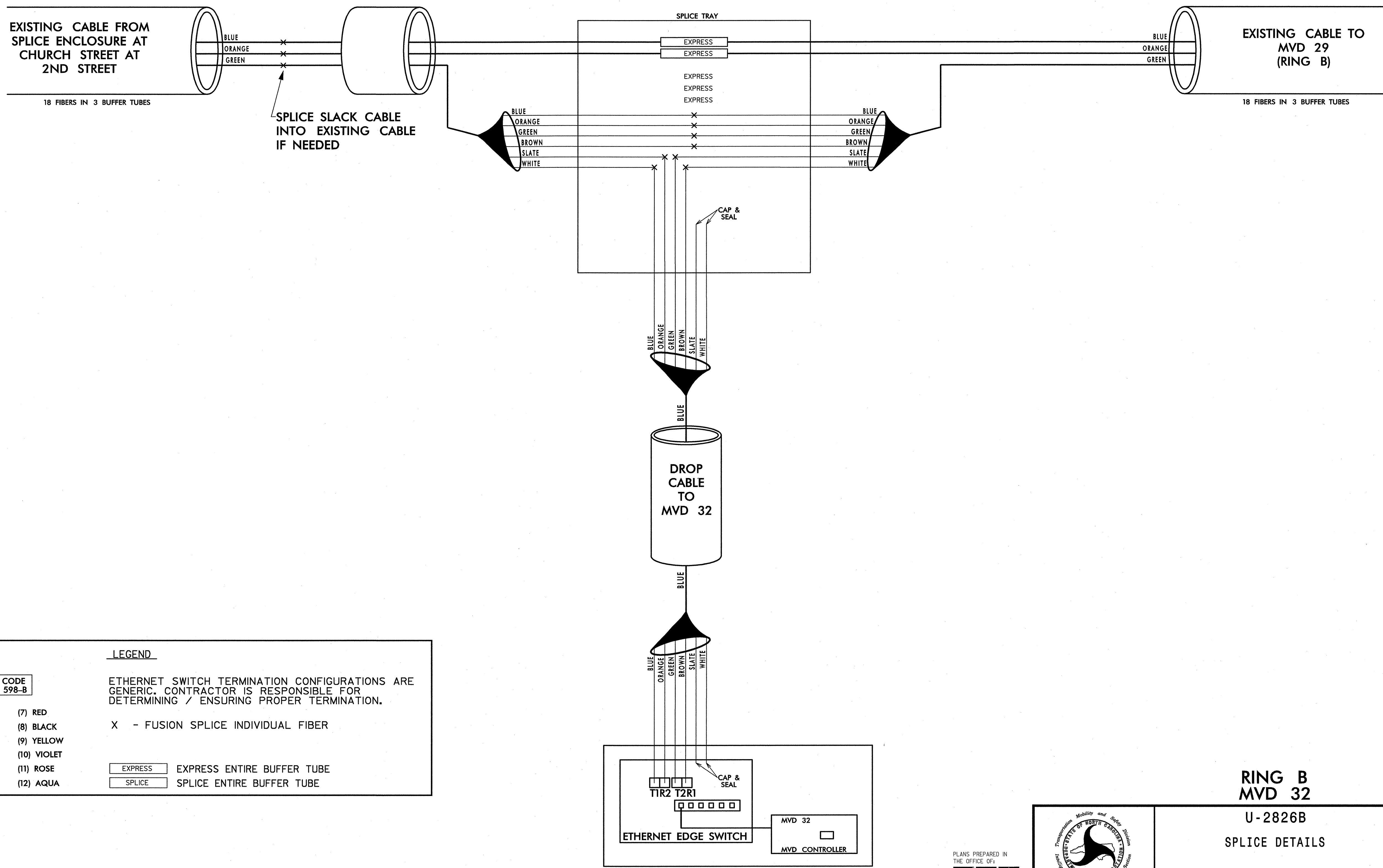

LEGEND

| | | |
|---------------------------------|-------------|--|
| COLOR CODE TIA/EIA 598-B | | ETHERNET SWITCH TERMINATION CONFIGURATIONS ARE GENERIC. CONTRACTOR IS RESPONSIBLE FOR DETERMINING / ENSURING PROPER TERMINATION. |
| (1) BLUE | (7) RED | X - FUSION SPLICE INDIVIDUAL FIBER |
| (2) ORANGE | (8) BLACK | |
| (3) GREEN | (9) YELLOW | |
| (4) BROWN | (10) VIOLET | |
| (5) SLATE | (11) ROSE | EXPRESS ENTIRE BUFFER TUBE |
| (6) WHITE | (12) AQUA | SPLICE ENTIRE BUFFER TUBE |

NOTES:
1. FIBER INTERCONNECT CENTER RACKS ARE SCHEMATIC ONLY - ACTUAL EQUIPMENT FORM MAY VARY.

**RING B
MVD 32**

| | | | |
|---------------|---|------------------------------|---|
| | U-2826B | | |
| | SPLICE DETAILS | | |
| | DIVISION 9 FORSYTH COUNTY WINSTON SALEM PLAN DATE: JANUARY 2011 REVIEWED BY: S. Phillips PREPARED BY: J. Cross REVIEWED BY: S. Privette | | |
| SCALE NONE | REVISIONS INIT. DATE | SIGNATURE DATE 1-25-11 | SEAL NORTH CAROLINA PROFESSIONAL ENGINEER SEAL 24432 STEPHANIE B. PRIVETTE |

PLANS PREPARED IN THE OFFICE OF:
Kimley-Horn and Associates, Inc.
P.O. Box 33068
Raleigh, N.C. 27636-3068
(919) 677-2000
N.C. License # F-0102

1/25/2011 11:47:50 AM jerry.cross k:\real_tproj_118\01086188-us 52 118 (u-2826B)\plan\splice\splic17.dgn

**SPLICE ENCLOSURE AT MVD 29
UNIVERSITY PARKWAY NORTH
OF 25TH STREET**

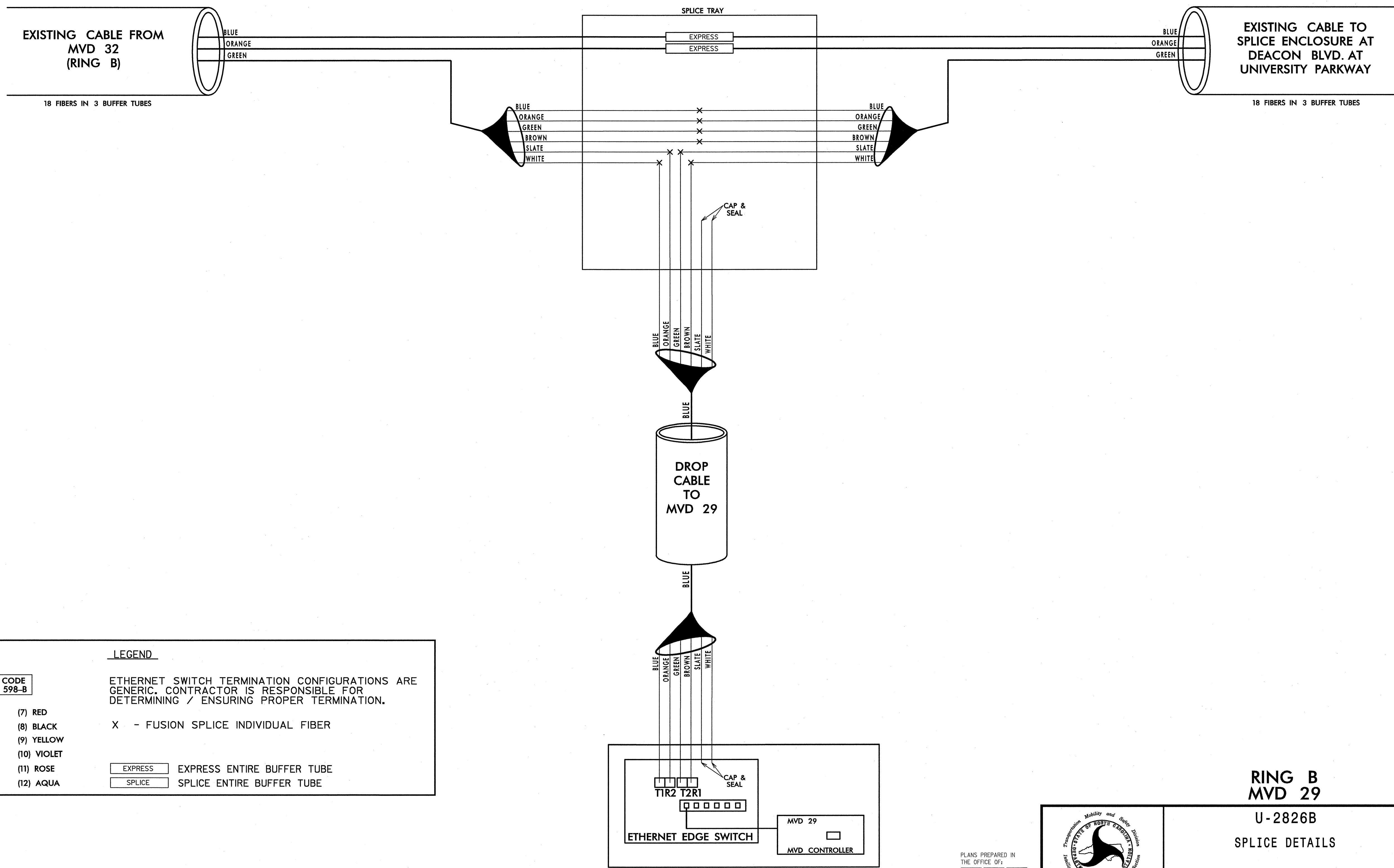

LEGEND

ETHERNET SWITCH TERMINATION CONFIGURATIONS ARE GENERIC. CONTRACTOR IS RESPONSIBLE FOR DETERMINING / ENSURING PROPER TERMINATION.

X - FUSION SPLICE INDIVIDUAL FIBER

| | |
|---------|----------------------------|
| EXPRESS | EXPRESS ENTIRE BUFFER TUBE |
| SPLICE | SPLICE ENTIRE BUFFER TUBE |

COLOR CODE TIA/EIA 598-B

| | |
|------------|-------------|
| (1) BLUE | (7) RED |
| (2) ORANGE | (8) BLACK |
| (3) GREEN | (9) YELLOW |
| (4) BROWN | (10) VIOLET |
| (5) SLATE | (11) ROSE |
| (6) WHITE | (12) AQUA |

NOTES:
1. FIBER INTERCONNECT CENTER RACKS ARE SCHEMATIC ONLY - ACTUAL EQUIPMENT FORM MAY VARY.

**RING B
MVD 29**

U-2826B

SPLICE DETAILS

DIVISION 9 FORSYTH COUNTY WINSTON SALEM

PLAN DATE: JANUARY 2011 REVIEWED BY: S. Phillips

PREPARED BY: J. Cross REVIEWED BY: S. Privette

SCALE: NONE

SEAL: NORTH CAROLINA PROFESSIONAL SEAL 24432 ENGINEER STEPHANIE B. PRIVETTE

SIGNATURE: [Signature] DATE: 1-25-11

CADD Filenames

PLANS PREPARED IN THE OFFICE OF:
Kimley-Horn and Associates, Inc.
P.O. Box 33068
Raleigh, N.C. 27636-3068
(919) 677-2000
N.C. License # F-0102

1/25/2011 11:47:51 AM jbrty_cross k:\ncal\proj\18\1038158-us_52_18 (u-2826B)\plan\Spllicing SPL-18.dgn

**SPLICE ENCLOSURE AT
BETHABARA ROAD AT
CHERRY STREET**

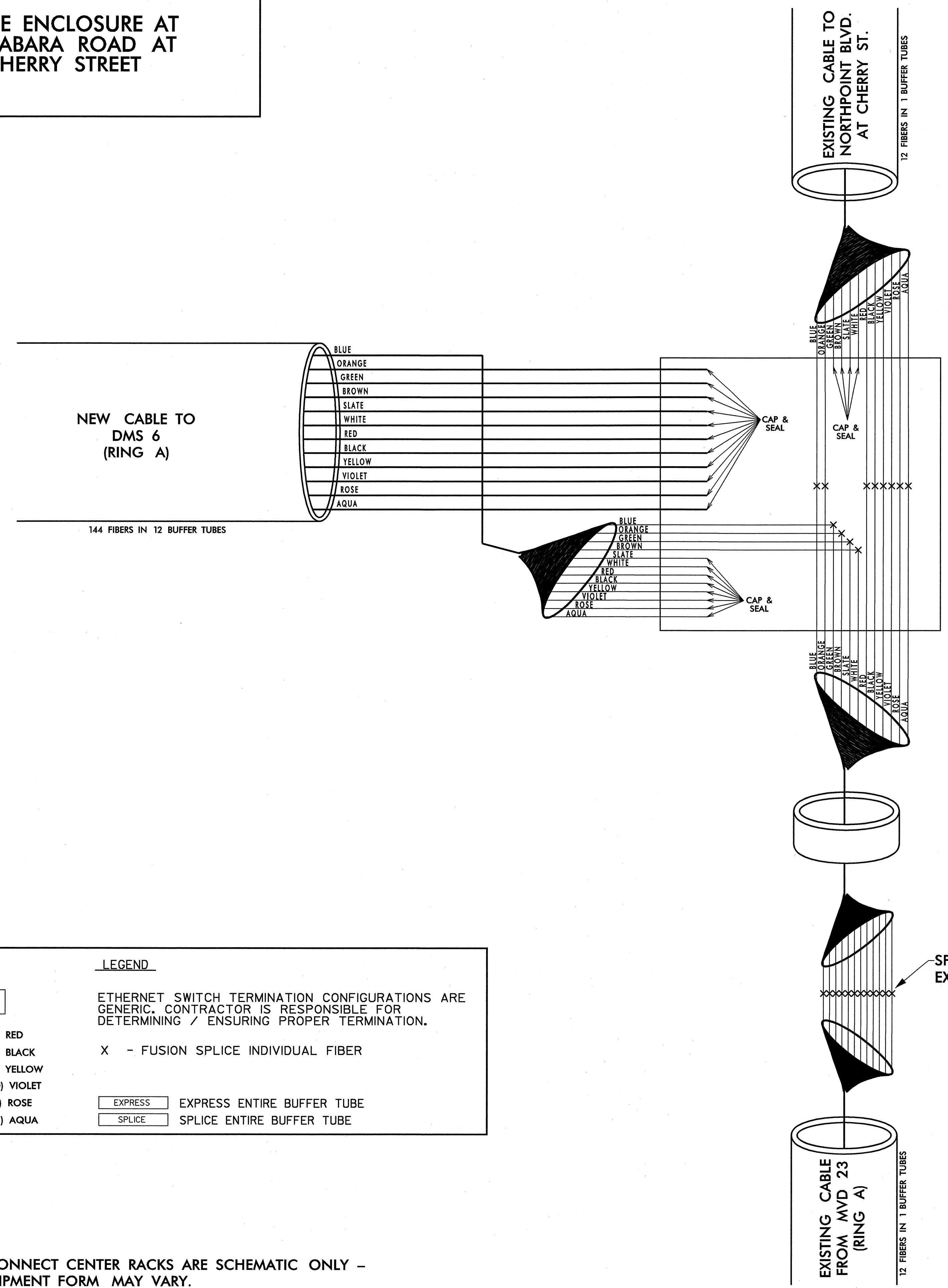

LEGEND

COLOR CODE
TIAEIA 598-B

| | | |
|------------|-------------|--|
| (1) BLUE | (7) RED | ETHERNET SWITCH TERMINATION CONFIGURATIONS ARE GENERIC. CONTRACTOR IS RESPONSIBLE FOR DETERMINING / ENSURING PROPER TERMINATION. |
| (2) ORANGE | (8) BLACK | |
| (3) GREEN | (9) YELLOW | |
| (4) BROWN | (10) VIOLET | |
| (5) SLATE | (11) ROSE | |
| (6) WHITE | (12) AQUA | |

X - FUSION SPLICE INDIVIDUAL FIBER

EXPRESS - EXPRESS ENTIRE BUFFER TUBE
SPLICE - SPLICE ENTIRE BUFFER TUBE

NOTES:
1. FIBER INTERCONNECT CENTER RACKS ARE SCHEMATIC ONLY - ACTUAL EQUIPMENT FORM MAY VARY.

SPlice SLACK CABLE INTO EXISTING CABLE IF NEEDED

RING A, RING B

PLANS PREPARED IN THE OFFICE OF:
Kimley-Horn and Associates, Inc.
P.O. Box 33068
Raleigh N.C. 27636-3068
(919) 677-2000
N.C. License # F-0102

| | | | |
|-------------------------|---|-----------------------|------------------------------------|
| | U-2826B SPLICE DETAILS | | |
| | DIVISION 9 FORSYTH COUNTY WINSTON SALEM | | |
| PLAN DATE: JANUARY 2011 | REVIEWED BY: S. Phillips | PREPARED BY: J. Cross | |
| REVISIONS | INIT. | DATE | SIGNATURE: <i>J. Cross</i> 1-25-11 |
| SCALE: NONE | | CADD Filename: | |

**SPLICE ENCLOSURE AT DMS 6
UNIVERSITY PARKWAY
SOUTH OF HOWELL ROAD**

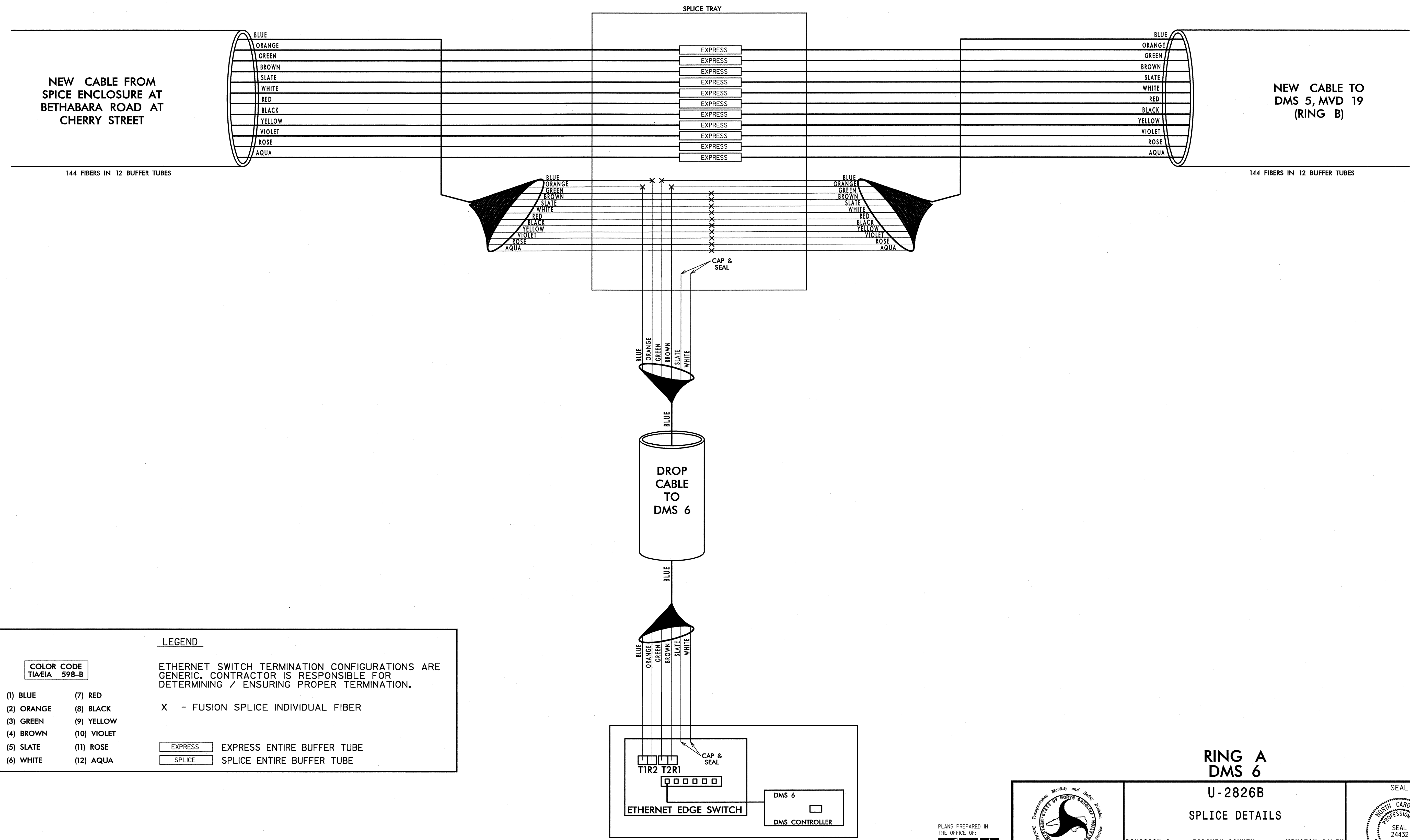

LEGEND

COLOR CODE
TIA/EIA 598-B

| | | |
|------------|-------------|--|
| (1) BLUE | (7) RED | ETHERNET SWITCH TERMINATION CONFIGURATIONS ARE GENERIC. CONTRACTOR IS RESPONSIBLE FOR DETERMINING / ENSURING PROPER TERMINATION. |
| (2) ORANGE | (8) BLACK | |
| (3) GREEN | (9) YELLOW | |
| (4) BROWN | (10) VIOLET | |
| (5) SLATE | (11) ROSE | |
| (6) WHITE | (12) AQUA | |

X - FUSION SPLICE INDIVIDUAL FIBER

| | |
|--|----------------------------|
| | EXPRESS ENTIRE BUFFER TUBE |
| | SPLICE ENTIRE BUFFER TUBE |

NOTES:
1. FIBER INTERCONNECT CENTER RACKS ARE SCHEMATIC ONLY - ACTUAL EQUIPMENT FORM MAY VARY.

**RING A
DMS 6**

**U-2826B
SPLICE DETAILS**

PLANS PREPARED IN THE OFFICE OF:

Kimley-Horn and Associates, Inc.
P.O. Box 33068
Raleigh N.C. 27636-3068
(919) 677-2000
N.C. License # F-9102

750 N. Greenfield Place, Garner, NC 27529

| | |
|---|--------------------------|
| DIVISION 9 FORSYTH COUNTY WINSTON SALEM | |
| PLAN DATE: JANUARY 2011 | REVIEWED BY: S. Phillips |
| PREPARED BY: J. Cross | REVIEWED BY: S. Privette |
| REVISIONS | INIT. DATE |
| | |

SEAL

STEPHANIE B. PRIVETTE
ENGINEER
24432

Stephanie B. Privette 1-25-11
SIGNATURE DATE

CADD Filenames

k:\nal_tproj_11s\011056186-us 52_11s (U-2826B)\plan\Splice.dwg(SPL21.dgn) 11:47:54 AM jerry.cross 1/25/2011

**SPLICE ENCLOSURE AT
DMS 5, MVD 19
UNIVERSITY PARKWAY
SOUTH OF WAKE FOREST ROAD**

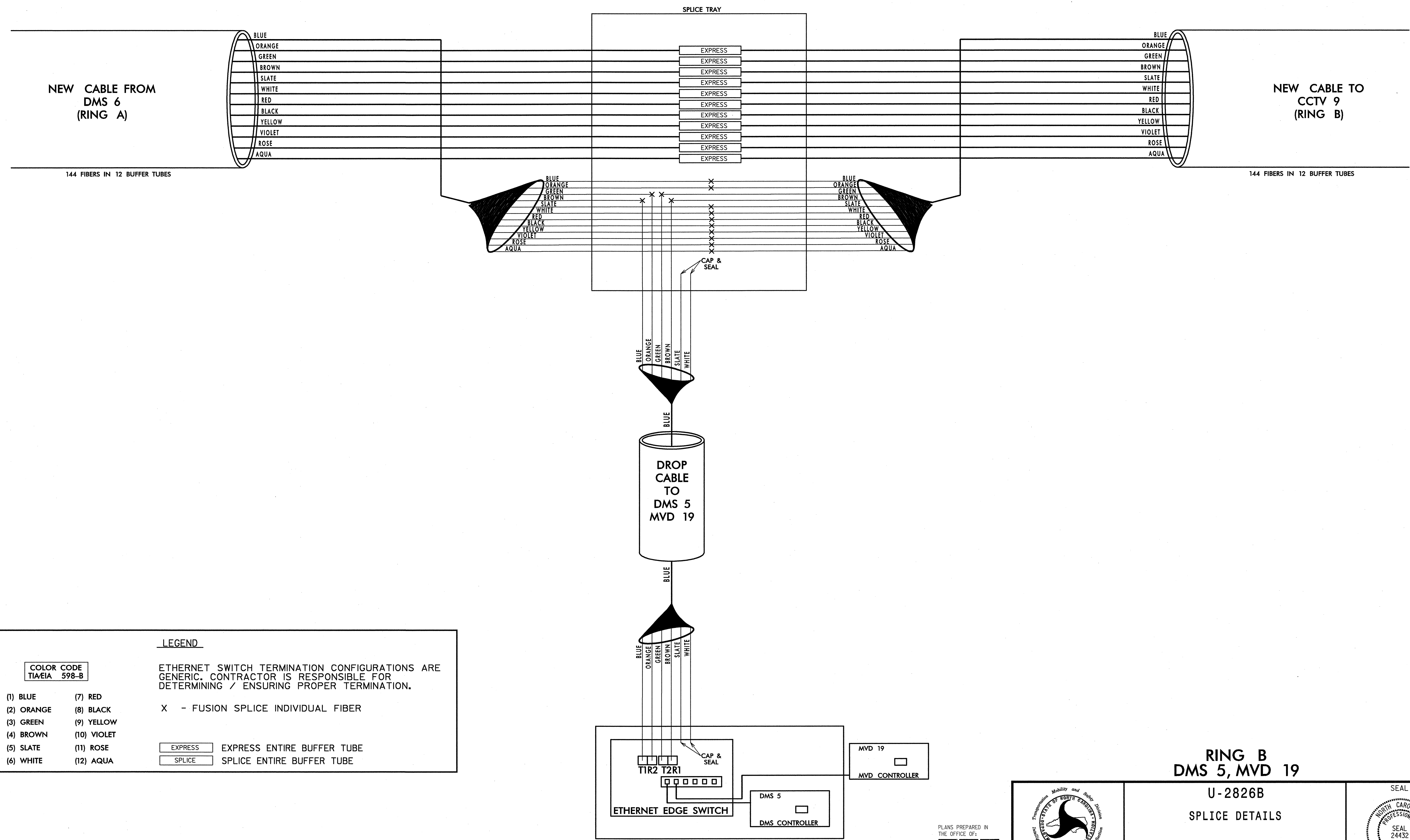

LEGEND

ETHERNET SWITCH TERMINATION CONFIGURATIONS ARE GENERIC. CONTRACTOR IS RESPONSIBLE FOR DETERMINING / ENSURING PROPER TERMINATION.

X - FUSION SPLICE INDIVIDUAL FIBER

| | |
|---------|----------------------------|
| EXPRESS | EXPRESS ENTIRE BUFFER TUBE |
| SPLICE | SPLICE ENTIRE BUFFER TUBE |

COLOR CODE TIA/EIA 598-B

| | |
|------------|-------------|
| (1) BLUE | (7) RED |
| (2) ORANGE | (8) BLACK |
| (3) GREEN | (9) YELLOW |
| (4) BROWN | (10) VIOLET |
| (5) SLATE | (11) ROSE |
| (6) WHITE | (12) AQUA |

NOTES:
1. FIBER INTERCONNECT CENTER RACKS ARE SCHEMATIC ONLY - ACTUAL EQUIPMENT FORM MAY VARY.

**RING B
DMS 5, MVD 19**

**U-2826B
SPLICE DETAILS**

| | |
|---|--------------------------|
| DIVISION 9 FORSYTH COUNTY WINSTON SALEM | |
| PLAN DATE: JANUARY 2011 | REVIEWED BY: S. Phillips |
| PREPARED BY: J. Cross | REVIEWED BY: S. Privette |
| SCALE: NONE | INIT. DATE |

SEAL
NORTH CAROLINA PROFESSIONAL ENGINEER
STEPHANIE B. PRIVETTE
24432

SIGNATURE DATE
[Signature] 1/25/11

PLANS PREPARED IN THE OFFICE OF:
Kimley-Horn and Associates, Inc.
P.O. Box 33068
Raleigh N.C. 27636-3068
(919) 617-2000
N.C. License # F-0102

1/25/2011 11:47:55 AM jerry.cross k:\real\proj_115\011038158-us_52_115 (U-2826B)\plan\splice.dwg SPL22.dgn

**SPLICE ENCLOSURE AT CCTV 9
UNIVERSITY PARKWAY
NORTH OF WAKE FOREST ROAD**

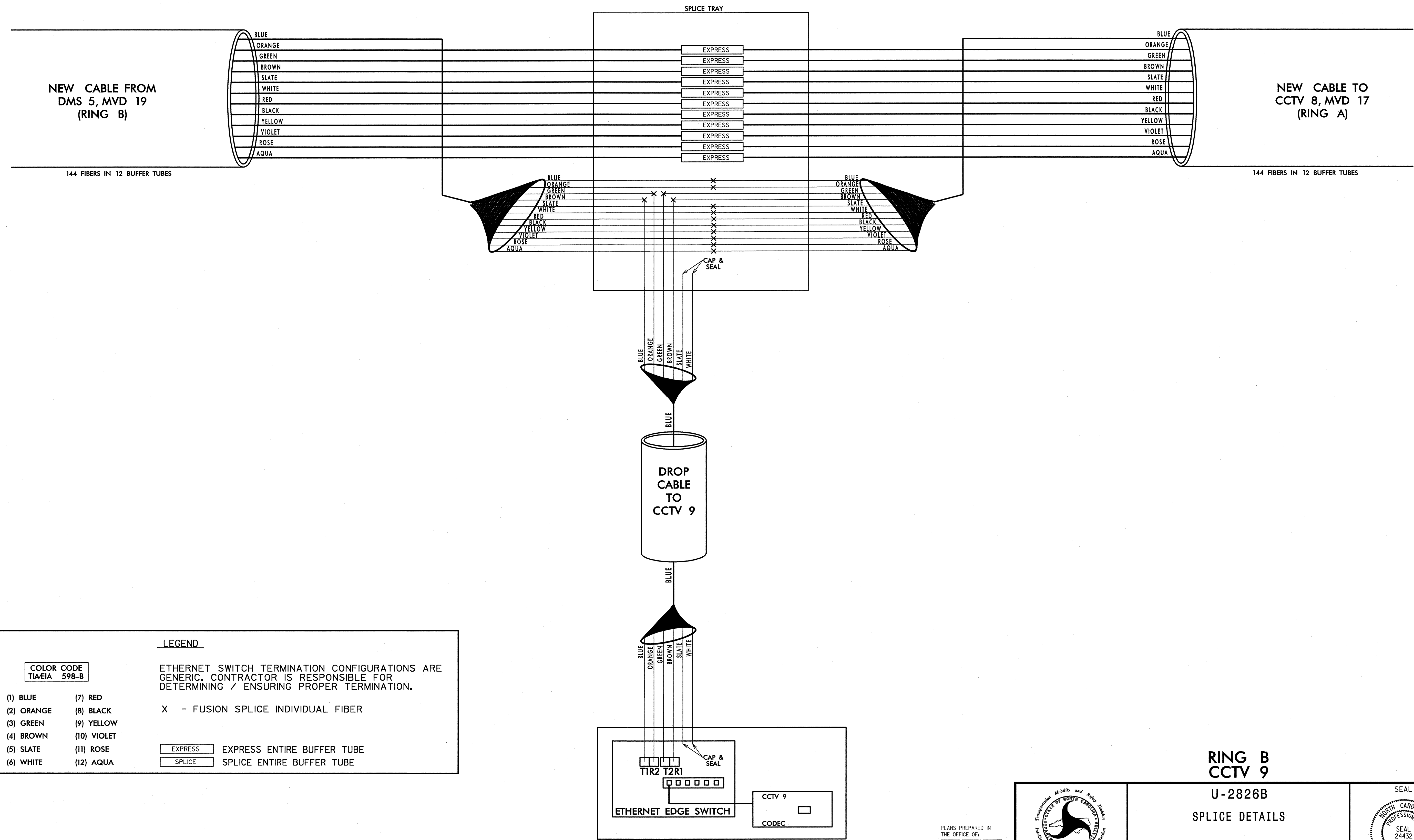

LEGEND

ETHERNET SWITCH TERMINATION CONFIGURATIONS ARE GENERIC. CONTRACTOR IS RESPONSIBLE FOR DETERMINING / ENSURING PROPER TERMINATION.

X - FUSION SPLICE INDIVIDUAL FIBER

| | |
|---------|----------------------------|
| EXPRESS | EXPRESS ENTIRE BUFFER TUBE |
| SPLICE | SPLICE ENTIRE BUFFER TUBE |

COLOR CODE
TIA/EIA 598-B

| | |
|------------|-------------|
| (1) BLUE | (7) RED |
| (2) ORANGE | (8) BLACK |
| (3) GREEN | (9) YELLOW |
| (4) BROWN | (10) VIOLET |
| (5) SLATE | (11) ROSE |
| (6) WHITE | (12) AQUA |

NOTES:
1. FIBER INTERCONNECT CENTER RACKS ARE SCHEMATIC ONLY - ACTUAL EQUIPMENT FORM MAY VARY.

**RING B
CCTV 9**

**U-2826B
SPLICE DETAILS**

PLANS PREPARED IN THE OFFICE OF:
Kimley-Horn and Associates, Inc.
P.O. Box 33068
Raleigh, N.C. 27636-3068
(919) 677-2000
N.C. License # F-0102

| | |
|---|--------------------------|
| DIVISION 9 FORSYTH COUNTY WINSTON SALEM | |
| PLAN DATE: JANUARY 2011 | REVIEWED BY: S. Phillips |
| PREPARED BY: J. Cross | REVIEWED BY: S. Privette |
| SCALE | REVISIONS |
| 0 | INIT. DATE |
| NONE | |

SEAL

STEPHANIE B. PRIVETTE
ENGINEER
24432

SIGNATURE: *Stephanie B. Privette*
DATE: _____
CADD Filename: _____

k:\real\proj\11086196.us_52_11s (u-2826B)\plan\splice.dwg (SPL23.dgn) 11:47:56 AM JERTY, CROSS 1/25/2011

**SPLICE ENCLOSURE AT
CCTV 8, MVD 17
UNIVERSITY PARKWAY
NEAR RANCH DRIVE**

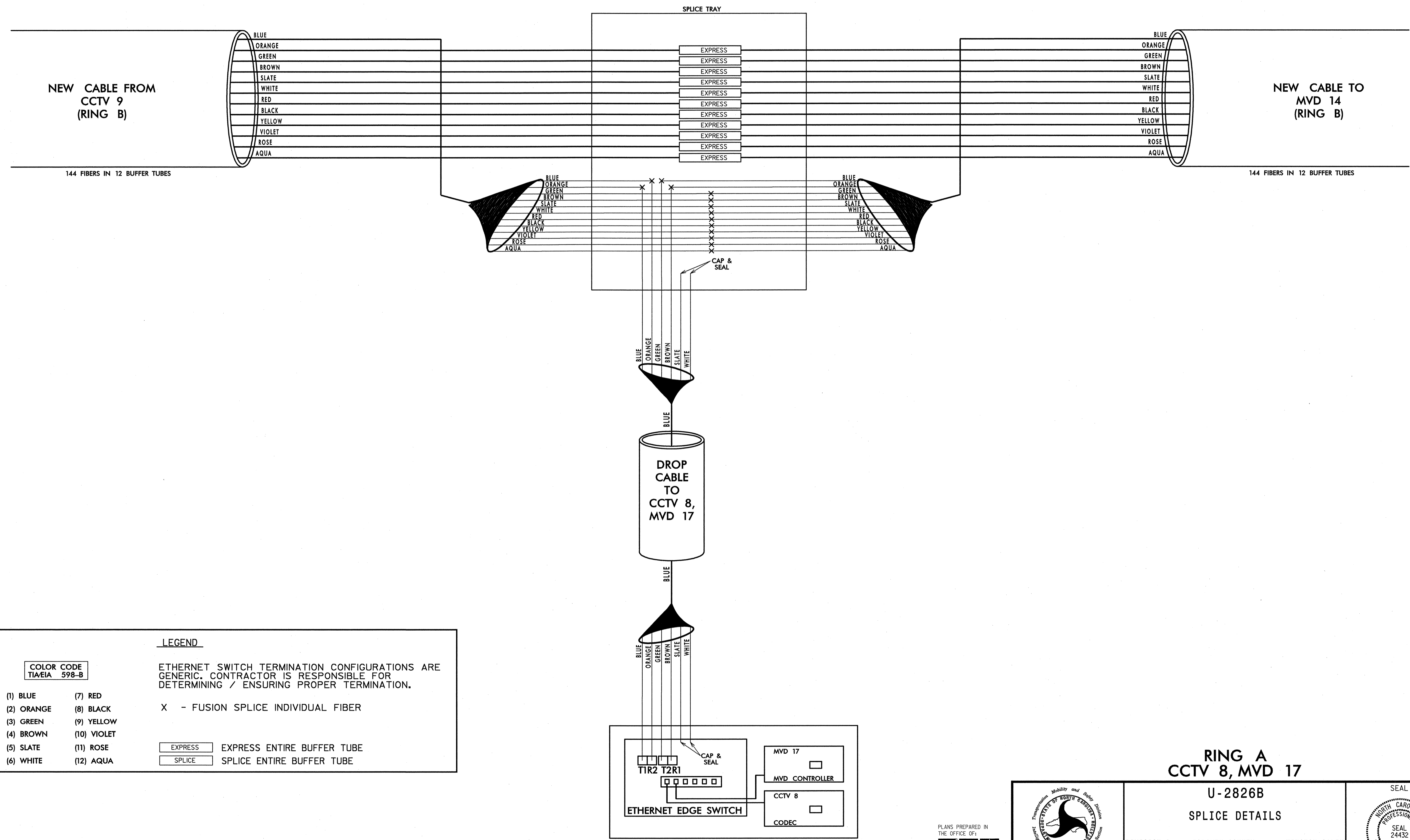

LEGEND

COLOR CODE
TIA/EIA 598-B

| | | |
|------------|-------------|--------------------------------------|
| (1) BLUE | (7) RED | X - FUSION SPLICE INDIVIDUAL FIBER |
| (2) ORANGE | (8) BLACK | |
| (3) GREEN | (9) YELLOW | |
| (4) BROWN | (10) VIOLET | |
| (5) SLATE | (11) ROSE | EXPRESS - EXPRESS ENTIRE BUFFER TUBE |
| (6) WHITE | (12) AQUA | SPLICE - SPLICE ENTIRE BUFFER TUBE |

ETHERNET SWITCH TERMINATION CONFIGURATIONS ARE GENERIC. CONTRACTOR IS RESPONSIBLE FOR DETERMINING / ENSURING PROPER TERMINATION.

NOTES:
1. FIBER INTERCONNECT CENTER RACKS ARE SCHEMATIC ONLY - ACTUAL EQUIPMENT FORM MAY VARY.

**RING A
CCTV 8, MVD 17**

**U-2826B
SPLICE DETAILS**

| | | | | |
|--------------------|---|--------------------------|---|---------------------------|
| | DIVISION 9 FORSYTH COUNTY WINSTON SALEM | | SEAL NORTH CAROLINA PROFESSIONAL ENGINEER SEAL 24432 STEPHANIE B. PRIVETTE | |
| | PLAN DATE: JANUARY 2011 | REVIEWED BY: S. Phillips | | SIGNATURE DATE 1-25-11 |
| | PREPARED BY: J. Cross | REVIEWED BY: S. Privette | | |
| SCALE 0 NONE | REVISIONS INIT. DATE | CADD Filename: | | |

PLANS PREPARED IN THE OFFICE OF:

Kimley-Horn and Associates, Inc.
 P.O. Box 33068
 Raleigh N.C. 27636-3068
 (919) 677-2000
 N.C. License # F-002

**SPLICE ENCLOSURE AT MVD 14
UNIVERSITY PARKWAY
SOUTH OF BETHABARA PARK BLVD.**

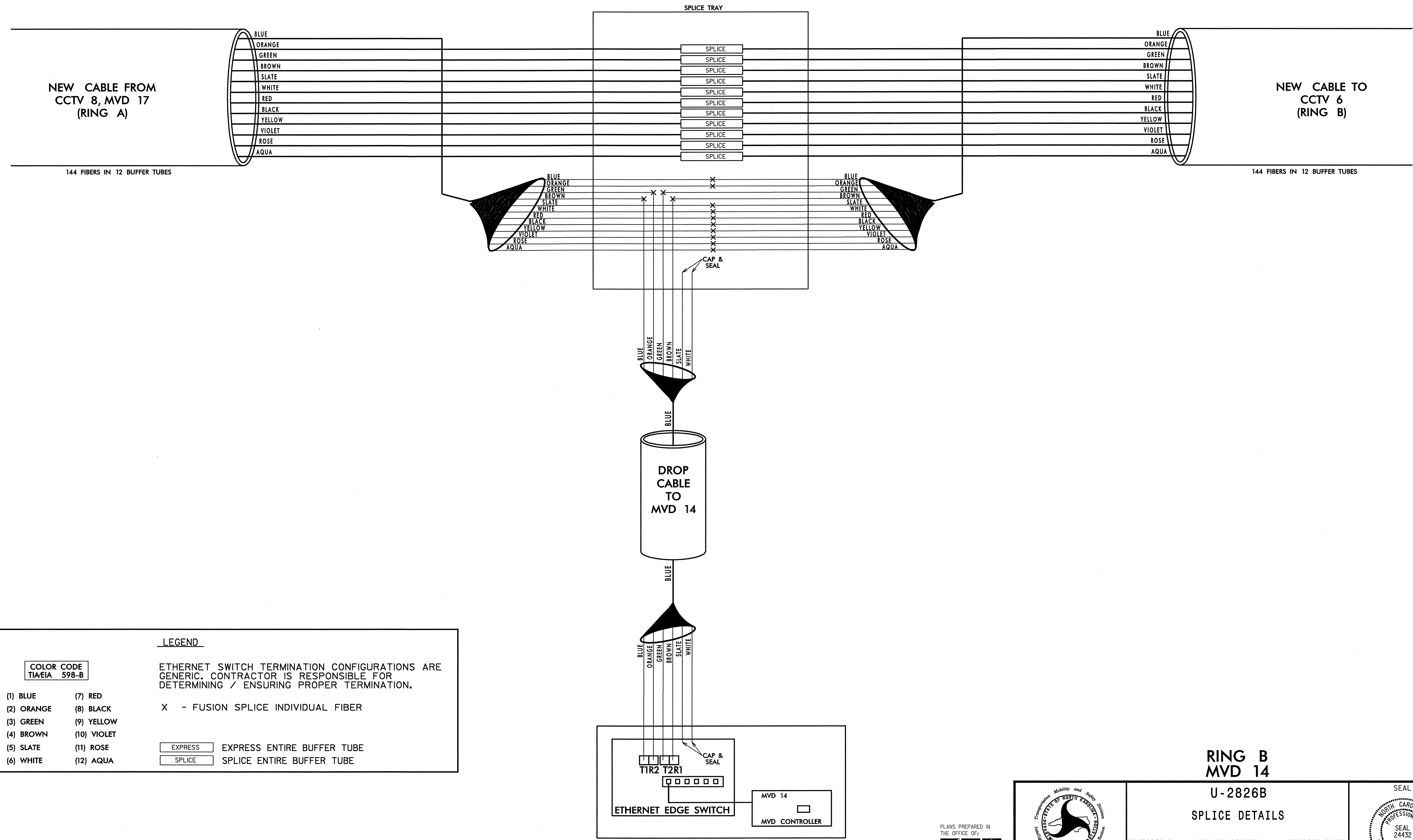

LEGEND

COLOR CODE
TIA/EIA 598-B

| | | |
|------------|-------------|--|
| (1) BLUE | (7) RED | ETHERNET SWITCH TERMINATION CONFIGURATIONS ARE GENERIC. CONTRACTOR IS RESPONSIBLE FOR DETERMINING / ENSURING PROPER TERMINATION. |
| (2) ORANGE | (8) BLACK | |
| (3) GREEN | (9) YELLOW | |
| (4) BROWN | (10) VIOLET | |
| (5) SLATE | (11) ROSE | |
| (6) WHITE | (12) AQUA | |

X - FUSION SPLICE INDIVIDUAL FIBER

| | |
|--|----------------------------|
| | EXPRESS ENTIRE BUFFER TUBE |
| | SPLICE ENTIRE BUFFER TUBE |

NOTES:
1. FIBER INTERCONNECT CENTER RACKS ARE SCHEMATIC ONLY - ACTUAL EQUIPMENT FORM MAY VARY.

**RING B
MVD 14**

**U-2826B
SPLICE DETAILS**

PLANS PREPARED IN THE OFFICE OF:

Kimley-Horn and Associates, Inc.
P.O. Box 33068
Raleigh N.C. 27636-3068
(919) 677-2000
N.C. License # F-0102

750 N. Greenfield Pkwy., Garner, NC 27529

| | |
|---|--------------------------|
| DIVISION 9 FORSYTH COUNTY WINSTON SALEM | |
| PLAN DATE: JANUARY 2011 | REVIEWED BY: S. Phillips |
| PREPARED BY: J. Cross | REVIEWED BY: S. Privette |
| REVISIONS | INIT. DATE |
| | |
| | |

SEAL

STEPHANIE B. PRIVETTE
ENGINEER
SEAL 24432

SIGNATURE DATE

CADD File name:

1/25/2011 11:47:59 AM jerry.cross k:\real_tproj_118\011086188-us 52_118 (u-2826B)\plan\splice.dwg SPL-25.dwg

**SPLICE ENCLOSURE AT CCTV 6
UNIVERSITY PARKWAY
NEAR BETHABARA PARK BLVD.**

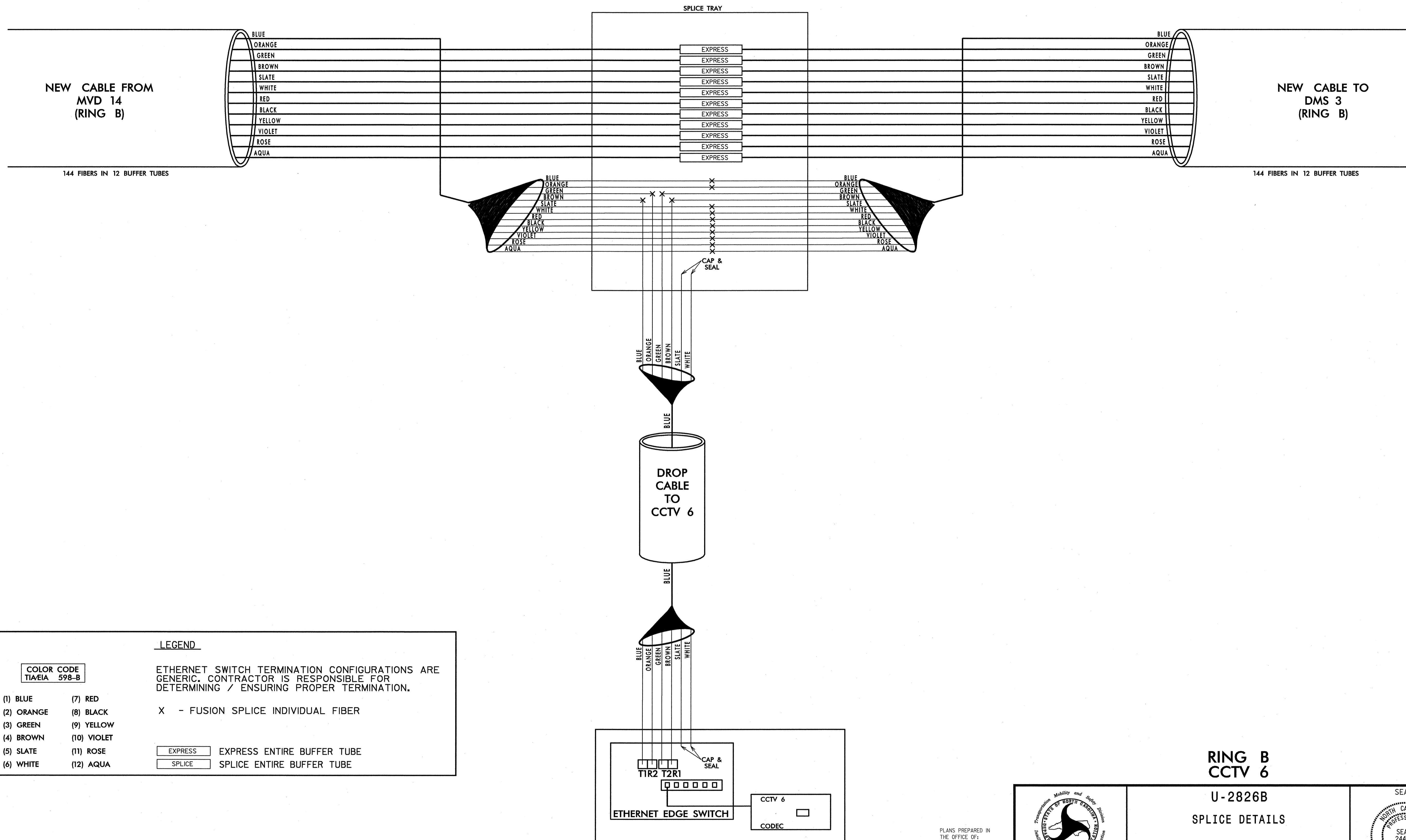

LEGEND

COLOR CODE
TIA/EIA 598-B

| | | |
|------------|-------------|--|
| (1) BLUE | (7) RED | ETHERNET SWITCH TERMINATION CONFIGURATIONS ARE GENERIC. CONTRACTOR IS RESPONSIBLE FOR DETERMINING / ENSURING PROPER TERMINATION. X - FUSION SPLICE INDIVIDUAL FIBER |
| (2) ORANGE | (8) BLACK | |
| (3) GREEN | (9) YELLOW | |
| (4) BROWN | (10) VIOLET | |
| (5) SLATE | (11) ROSE | |
| (6) WHITE | (12) AQUA | |

| | |
|--|----------------------------|
| | EXPRESS ENTIRE BUFFER TUBE |
| | SPLICE ENTIRE BUFFER TUBE |

NOTES:
1. FIBER INTERCONNECT CENTER RACKS ARE SCHEMATIC ONLY -
ACTUAL EQUIPMENT FORM MAY VARY.

**RING B
CCTV 6**

**U-2826B
SPLICE DETAILS**

PLANS PREPARED IN
THE OFFICE OF:

**Kimley-Horn
and Associates, Inc.**
P.O. Box 33068
Raleigh, N.C. 27636-3068
(919) 677-2000
N.C. License # F-0102

750 N. Greenfield Pkwy., Garner, NC 27529

SCALE
0
NONE

| | |
|---|--------------------------|
| DIVISION 9 FORSYTH COUNTY WINSTON SALEM | |
| PLAN DATE: JANUARY 2011 | REVIEWED BY: S. Phillips |
| PREPARED BY: J. Cross | REVIEWED BY: S. Privette |
| SCALE | REVISIONS |
| INIT. | DATE |

SEAL
NORTH CAROLINA
PROFESSIONAL
SEAL
24432
STEPHANIE B. PRIVETTE
ENGINEER
DATE: 1-25-11
SIGNATURE
CADD Filename:

1/25/2011 11:47:59 AM jerry.cross k:\nal_tproj_11s\01086158-us_02_11s (U-2826B)\plan\splice\splic26.dgn

**SPLICE ENCLOSURE AT DMS 3
UNIVERSITY PARKWAY
NORTH OF BETHABARA PARK BLVD.**

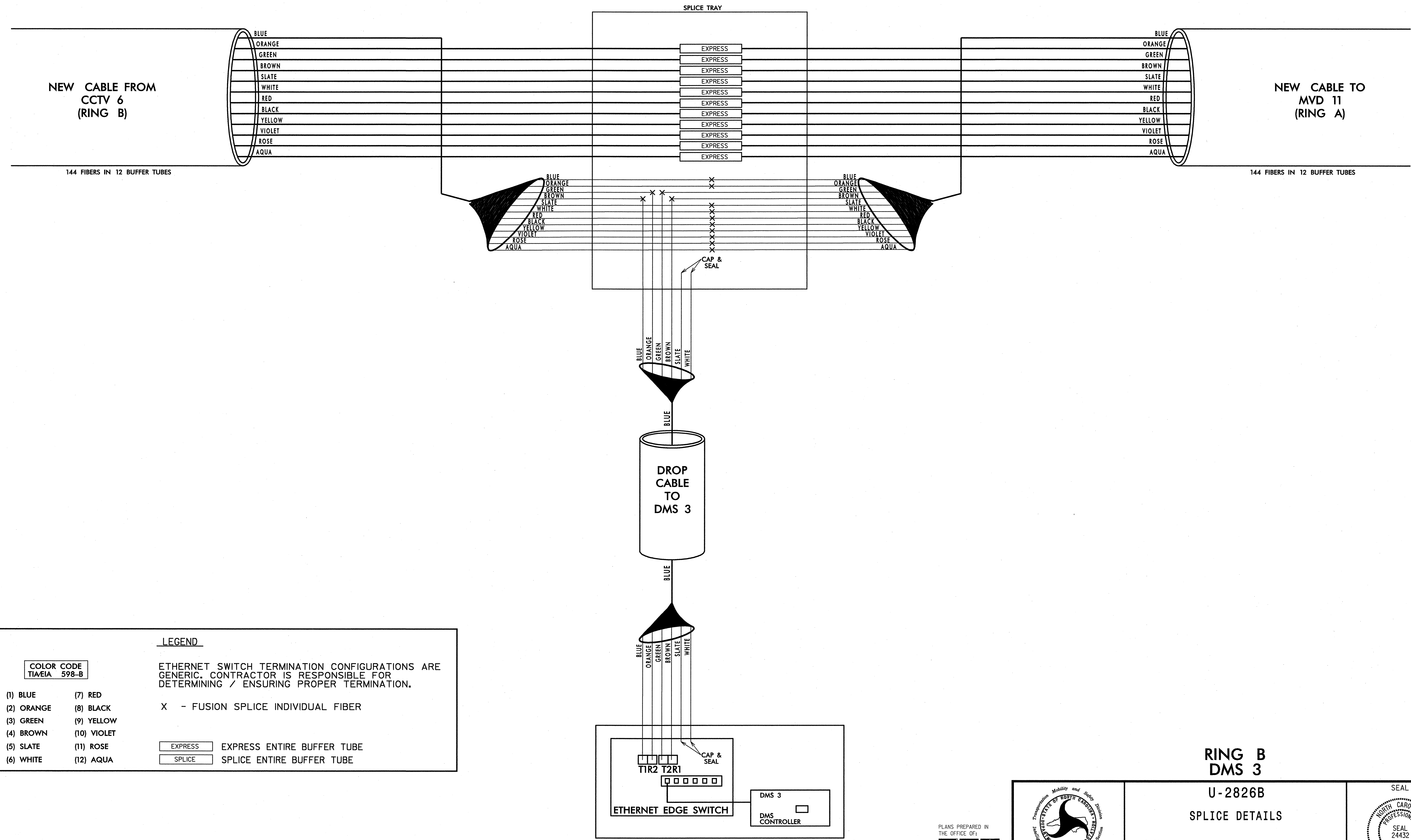

LEGEND

ETHERNET SWITCH TERMINATION CONFIGURATIONS ARE GENERIC. CONTRACTOR IS RESPONSIBLE FOR DETERMINING / ENSURING PROPER TERMINATION.

X - FUSION SPLICE INDIVIDUAL FIBER

| | | |
|---------|--|----------------------------|
| EXPRESS | | EXPRESS ENTIRE BUFFER TUBE |
| SPLICE | | SPLICE ENTIRE BUFFER TUBE |

COLOR CODE
TIA/EIA 598-B

| | |
|------------|-------------|
| (1) BLUE | (7) RED |
| (2) ORANGE | (8) BLACK |
| (3) GREEN | (9) YELLOW |
| (4) BROWN | (10) VIOLET |
| (5) SLATE | (11) ROSE |
| (6) WHITE | (12) AQUA |

NOTES:
1. FIBER INTERCONNECT CENTER RACKS ARE SCHEMATIC ONLY - ACTUAL EQUIPMENT FORM MAY VARY.

**RING B
DMS 3**

**U-2826B
SPLICE DETAILS**

PLANS PREPARED IN THE OFFICE OF:
Kimley-Horn and Associates, Inc.
P.O. Box 33068
Raleigh N.C. 27636-3068
(919) 677-2000
N.C. License # F-0102

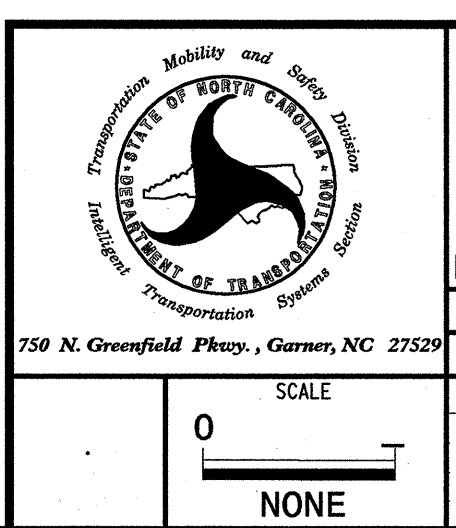

| | |
|---|--------------------------|
| DIVISION 9 FORSYTH COUNTY WINSTON SALEM | |
| PLAN DATE: JANUARY 2011 | REVIEWED BY: S. Phillips |
| PREPARED BY: J. Cross | REVIEWED BY: S. Privette |
| REVISIONS | INIT. DATE |
| | |
| | |

SCALE: NONE

SIGNATURE: *Stephanie B. Privette* 1/25/11
DATE: 1/25/11
CADD Filename:

1/25/2011 11:46:00 AM jerry.cross k:\val_tproj_11s\011086158-us 52_11s (U-2826B)\plan\splice\splice SPL-27.dgn

**SPLICE ENCLOSURE AT MVD 11
UNIVERSITY PARKWAY
SOUTH OF CHERRY STREET**

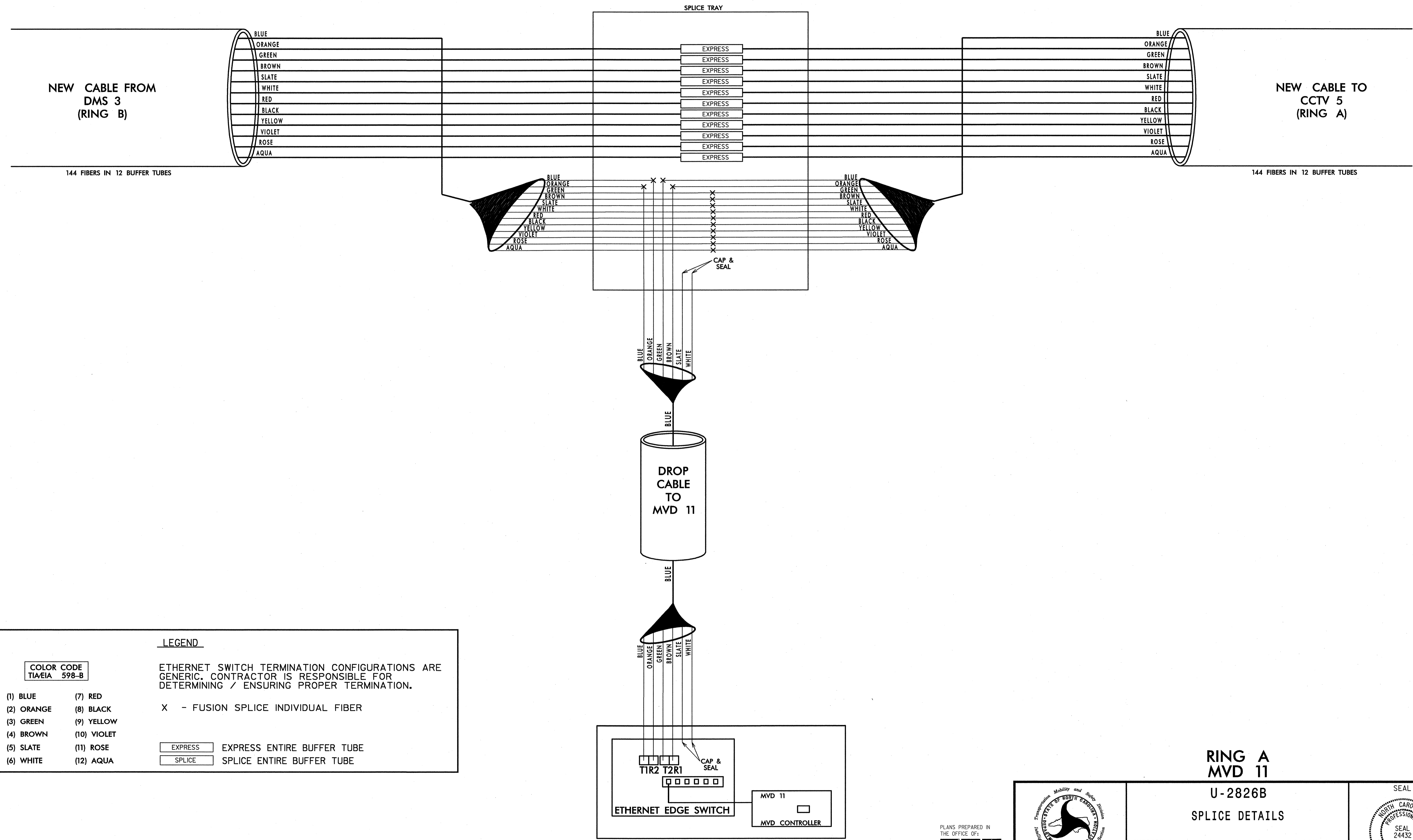

COLOR CODE
TIA/EIA 598-B

| | |
|------------|-------------|
| (1) BLUE | (7) RED |
| (2) ORANGE | (8) BLACK |
| (3) GREEN | (9) YELLOW |
| (4) BROWN | (10) VIOLET |
| (5) SLATE | (11) ROSE |
| (6) WHITE | (12) AQUA |

LEGEND

ETHERNET SWITCH TERMINATION CONFIGURATIONS ARE GENERIC. CONTRACTOR IS RESPONSIBLE FOR DETERMINING / ENSURING PROPER TERMINATION.

X - FUSION SPLICE INDIVIDUAL FIBER

| | |
|--|----------------------------|
| | EXPRESS ENTIRE BUFFER TUBE |
| | SPLICE ENTIRE BUFFER TUBE |

NOTES:
1. FIBER INTERCONNECT CENTER RACKS ARE SCHEMATIC ONLY - ACTUAL EQUIPMENT FORM MAY VARY.

**RING A
MVD 11**

**U-2826B
SPLICE DETAILS**

PLANS PREPARED IN THE OFFICE OF:

Kimley-Horn and Associates, Inc.
P.O. Box 33068
Raleigh N.C. 27636-3068
(919) 677-2000
N.C. License # F-002

| | |
|---|--------------------------|
| DIVISION 9 FORSYTH COUNTY WINSTON SALEM | |
| PLAN DATE: JANUARY 2011 | REVIEWED BY: S. Phillips |
| PREPARED BY: J. Cross | REVIEWED BY: S. Privette |
| SCALE | INIT. DATE |
| 0 | |
| NONE | |

SEAL

SIGNATURE DATE

CADD Filename

k:\val_tproj_11s\01036158-us_52_11s (U-2826B)\plan\SplEnc(SPL28).dgn
 11:48:07 AM
 jerry.cross
 1/25/2011

**SPLICE ENCLOSURE AT CCTV 5
UNIVERSITY PARKWAY
NORTH OF OAK SUMMIT ROAD**

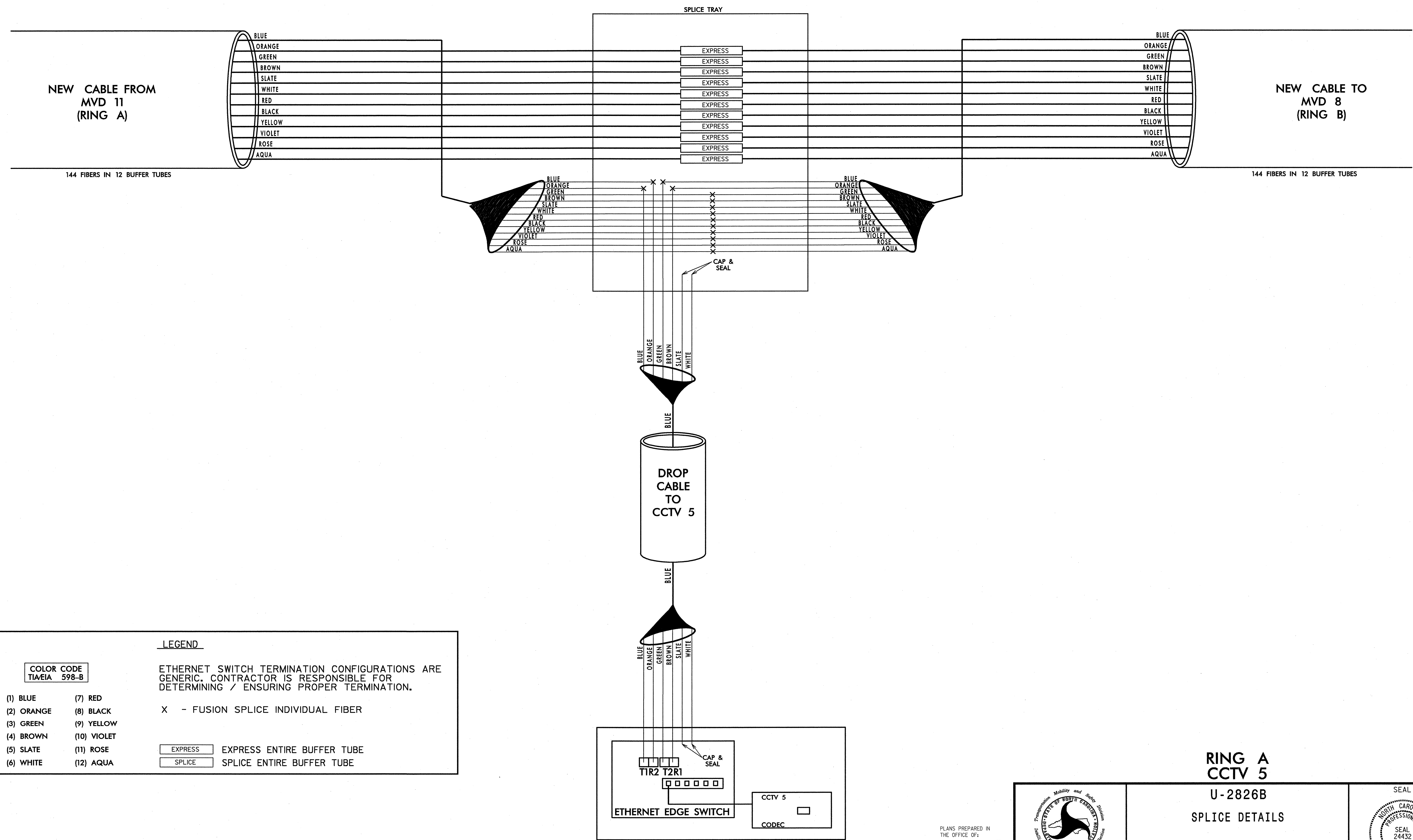

LEGEND

ETHERNET SWITCH TERMINATION CONFIGURATIONS ARE GENERIC. CONTRACTOR IS RESPONSIBLE FOR DETERMINING / ENSURING PROPER TERMINATION.

X - FUSION SPLICE INDIVIDUAL FIBER

| | |
|---------|----------------------------|
| EXPRESS | EXPRESS ENTIRE BUFFER TUBE |
| SPLICE | SPLICE ENTIRE BUFFER TUBE |

COLOR CODE TIA/EIA 598-B

| | |
|------------|-------------|
| (1) BLUE | (7) RED |
| (2) ORANGE | (8) BLACK |
| (3) GREEN | (9) YELLOW |
| (4) BROWN | (10) VIOLET |
| (5) SLATE | (11) ROSE |
| (6) WHITE | (12) AQUA |

NOTES:
1. FIBER INTERCONNECT CENTER RACKS ARE SCHEMATIC ONLY - ACTUAL EQUIPMENT FORM MAY VARY.

**RING A
CCTV 5**

U-2826B

SPLICE DETAILS

PLANS PREPARED IN THE OFFICE OF:
Kimley-Horn and Associates, Inc.
P.O. Box 33068
Raleigh, N.C. 27636-3068
(919) 677-2000
N.C. License # F-0102

750 N. Greenfield Pkwy., Garner, NC 27529

| | |
|---|--------------------------|
| DIVISION 9 FORSYTH COUNTY WINSTON SALEM | |
| PLAN DATE: JANUARY 2011 | REVIEWED BY: S. Phillips |
| PREPARED BY: J. Cross | REVIEWED BY: S. Privette |
| REVISIONS | INIT. DATE |
| | |
| | |

SEAL

1-25-11
DATE

CADD Filename:

1/25/2011 11:48:02 AM jerry_cross k:\val_p\proj_1\101028158-us_52_11s (u-2826B) (plan) (Spl) (csp) SPL29.dgn

**SPLICE ENCLOSURE AT MVD 8
UNIVERSITY PARKWAY
NORTH OF HANES MILL ROAD**

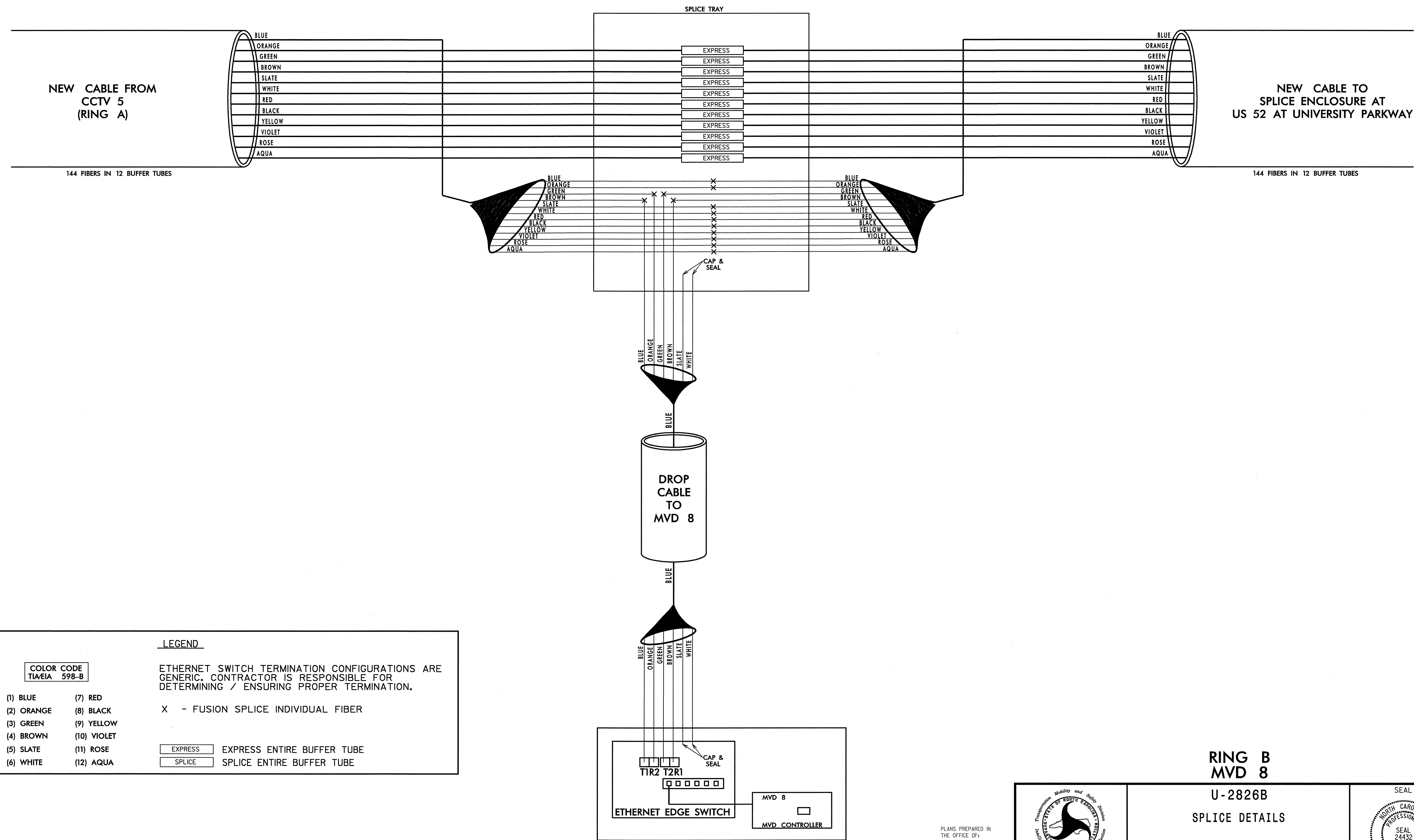

LEGEND

ETHERNET SWITCH TERMINATION CONFIGURATIONS ARE GENERIC. CONTRACTOR IS RESPONSIBLE FOR DETERMINING / ENSURING PROPER TERMINATION.

X - FUSION SPLICE INDIVIDUAL FIBER

| | |
|------------------------------------|-------------|
| COLOR CODE TIA/EIA 598-B | |
| (1) BLUE | (7) RED |
| (2) ORANGE | (8) BLACK |
| (3) GREEN | (9) YELLOW |
| (4) BROWN | (10) VIOLET |
| (5) SLATE | (11) ROSE |
| (6) WHITE | (12) AQUA |

| | |
|---------|----------------------------|
| EXPRESS | EXPRESS ENTIRE BUFFER TUBE |
| SPLICE | SPLICE ENTIRE BUFFER TUBE |

NOTES:
1. FIBER INTERCONNECT CENTER RACKS ARE SCHEMATIC ONLY - ACTUAL EQUIPMENT FORM MAY VARY.

**RING B
MVD 8**

**U-2826B
SPLICE DETAILS**

| | |
|---|--------------------------|
| DIVISION 9 FORSYTH COUNTY WINSTON SALEM | |
| PLAN DATE: JANUARY 2011 | REVIEWED BY: S. Phillips |
| PREPARED BY: J. Cross | REVIEWED BY: S. Privette |
| REVISIONS | INIT. DATE |
| | |

SCALE: NONE

SEAL: NORTH CAROLINA PROFESSIONAL SEAL 24432 ENGINEER STEPHANIE B. PRIVETTE

SIGNATURE: [Signature] DATE: 1-25-11

CAUD FileNumber: [Blank]

PLANS PREPARED IN THE OFFICE OF:
Kimley-Horn and Associates, Inc.
P.O. Box 33068
Raleigh, N.C. 27636-3068
(919) 677-2000
N.C. License # F-002

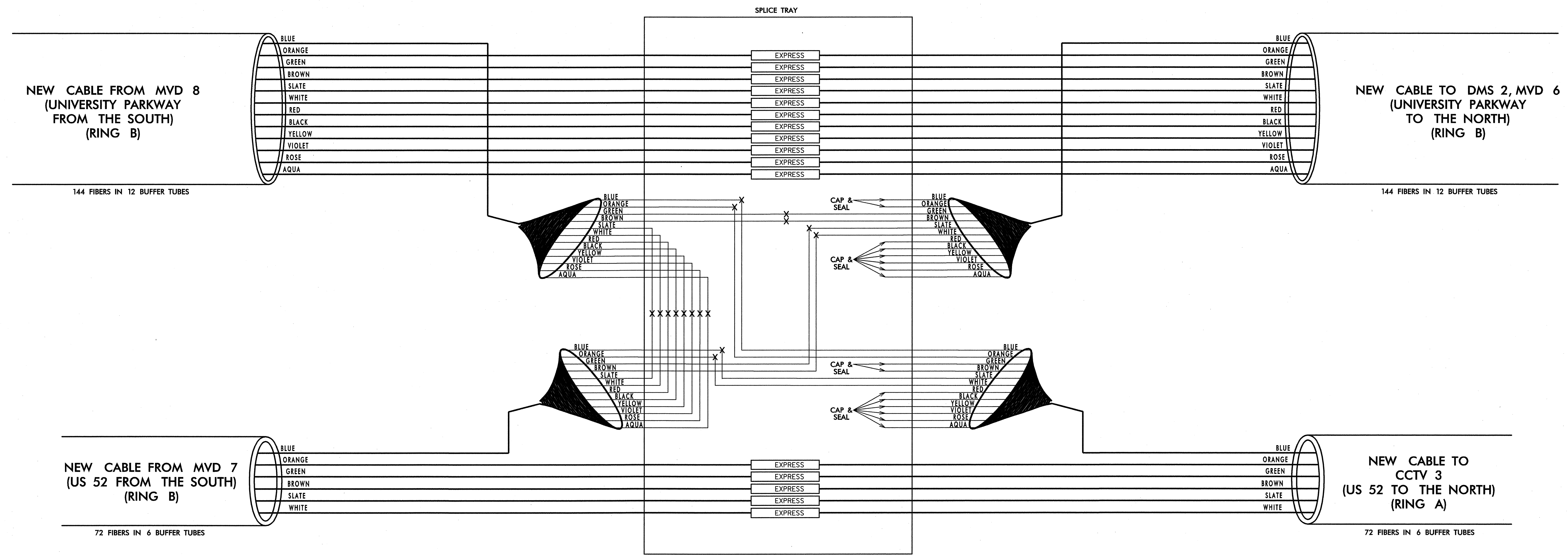

1/25/2011 11:48:03 AM jerry.cross k:\ra1\proj\11s\11088\58-us_52_11s (u-2826B)\plan\splice.dwg

SPLICE ENCLOSURE AT US 52 AT UNIVERSITY PARKWAY INTERCHANGE

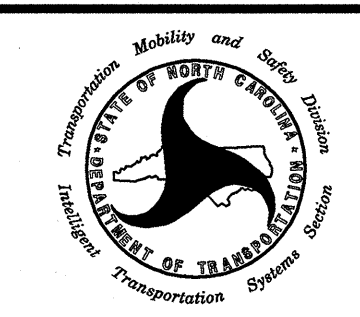

| | | | | | | | | | | | | | | | | | | | |
|---|-----------------------------|--|----------|---------|------------|-----------|-----------|------------|-----------|-------------|-----------|-----------|-----------|-----------|---|---------|----------------------------|--------|---------------------------|
| LEGEND | | | | | | | | | | | | | | | | | | | |
| <table border="1"> <tr> <td colspan="2" style="text-align: center;">COLOR CODE TIA/EIA 598-B</td> </tr> <tr> <td>(1) BLUE</td> <td>(7) RED</td> </tr> <tr> <td>(2) ORANGE</td> <td>(8) BLACK</td> </tr> <tr> <td>(3) GREEN</td> <td>(9) YELLOW</td> </tr> <tr> <td>(4) BROWN</td> <td>(10) VIOLET</td> </tr> <tr> <td>(5) SLATE</td> <td>(11) ROSE</td> </tr> <tr> <td>(6) WHITE</td> <td>(12) AQUA</td> </tr> </table> | COLOR CODE TIA/EIA 598-B | | (1) BLUE | (7) RED | (2) ORANGE | (8) BLACK | (3) GREEN | (9) YELLOW | (4) BROWN | (10) VIOLET | (5) SLATE | (11) ROSE | (6) WHITE | (12) AQUA | <p>ETHERNET SWITCH TERMINATION CONFIGURATIONS ARE GENERIC. CONTRACTOR IS RESPONSIBLE FOR DETERMINING / ENSURING PROPER TERMINATION.</p> <p>X - FUSION SPLICE INDIVIDUAL FIBER</p> <table border="1"> <tr> <td style="text-align: center;">EXPRESS</td> <td>EXPRESS ENTIRE BUFFER TUBE</td> </tr> <tr> <td style="text-align: center;">SPLICE</td> <td>SPLICE ENTIRE BUFFER TUBE</td> </tr> </table> | EXPRESS | EXPRESS ENTIRE BUFFER TUBE | SPLICE | SPLICE ENTIRE BUFFER TUBE |
| COLOR CODE TIA/EIA 598-B | | | | | | | | | | | | | | | | | | | |
| (1) BLUE | (7) RED | | | | | | | | | | | | | | | | | | |
| (2) ORANGE | (8) BLACK | | | | | | | | | | | | | | | | | | |
| (3) GREEN | (9) YELLOW | | | | | | | | | | | | | | | | | | |
| (4) BROWN | (10) VIOLET | | | | | | | | | | | | | | | | | | |
| (5) SLATE | (11) ROSE | | | | | | | | | | | | | | | | | | |
| (6) WHITE | (12) AQUA | | | | | | | | | | | | | | | | | | |
| EXPRESS | EXPRESS ENTIRE BUFFER TUBE | | | | | | | | | | | | | | | | | | |
| SPLICE | SPLICE ENTIRE BUFFER TUBE | | | | | | | | | | | | | | | | | | |

NOTES:
1. FIBER INTERCONNECT CENTER RACKS ARE SCHEMATIC ONLY - ACTUAL EQUIPMENT FORM MAY VARY.

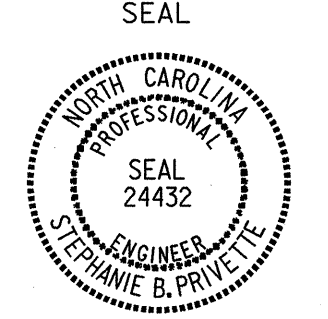
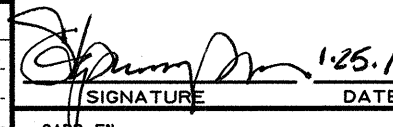
| RING A, RING B | | | | | | | |
|--|--|-------|------|--|--|--|--|
| U-2826B SPLICE DETAILS | | | | | | | |
|  PLANS PREPARED IN THE OFFICE OF:  Kimley-Horn and Associates, Inc. P.O. Box 33068 Raleigh, N.C. 27636-3068 (919) 677-2000 N.C. License # F-0102 | SEAL  NORTH CAROLINA PROFESSIONAL ENGINEER SEAL 24432 STEPHANIE B. PRIVETTE | | | | | | |
| DIVISION 9 FORSYTH COUNTY WINSTON SALEM PLAN DATE: JANUARY 2011 REVIEWED BY: S. Phillips PREPARED BY: J. Cross REVIEWED BY: S. Privette | | | | | | | |
| SCALE 0 NONE | REVISIONS <table border="1"> <tr> <th>INIT.</th> <th>DATE</th> </tr> <tr> <td> </td> <td> </td> </tr> <tr> <td> </td> <td> </td> </tr> </table> | INIT. | DATE | | | | |
| INIT. | DATE | | | | | | |
| | | | | | | | |
| | | | | | | | |
| SIGNATURE:  DATE: 1/25/11 CAD Filename: | | | | | | | |

k:\real\proj_1101038158-us_52_11s (U-2826B)\plan\Splicing\SP31.dgn
 11:45:04 AM
 jerry.cross
 1/25/2011

**SPLICE ENCLOSURE AT CCTV 3
US 52 NORTH OF
UNIVERSITY PARKWAY**

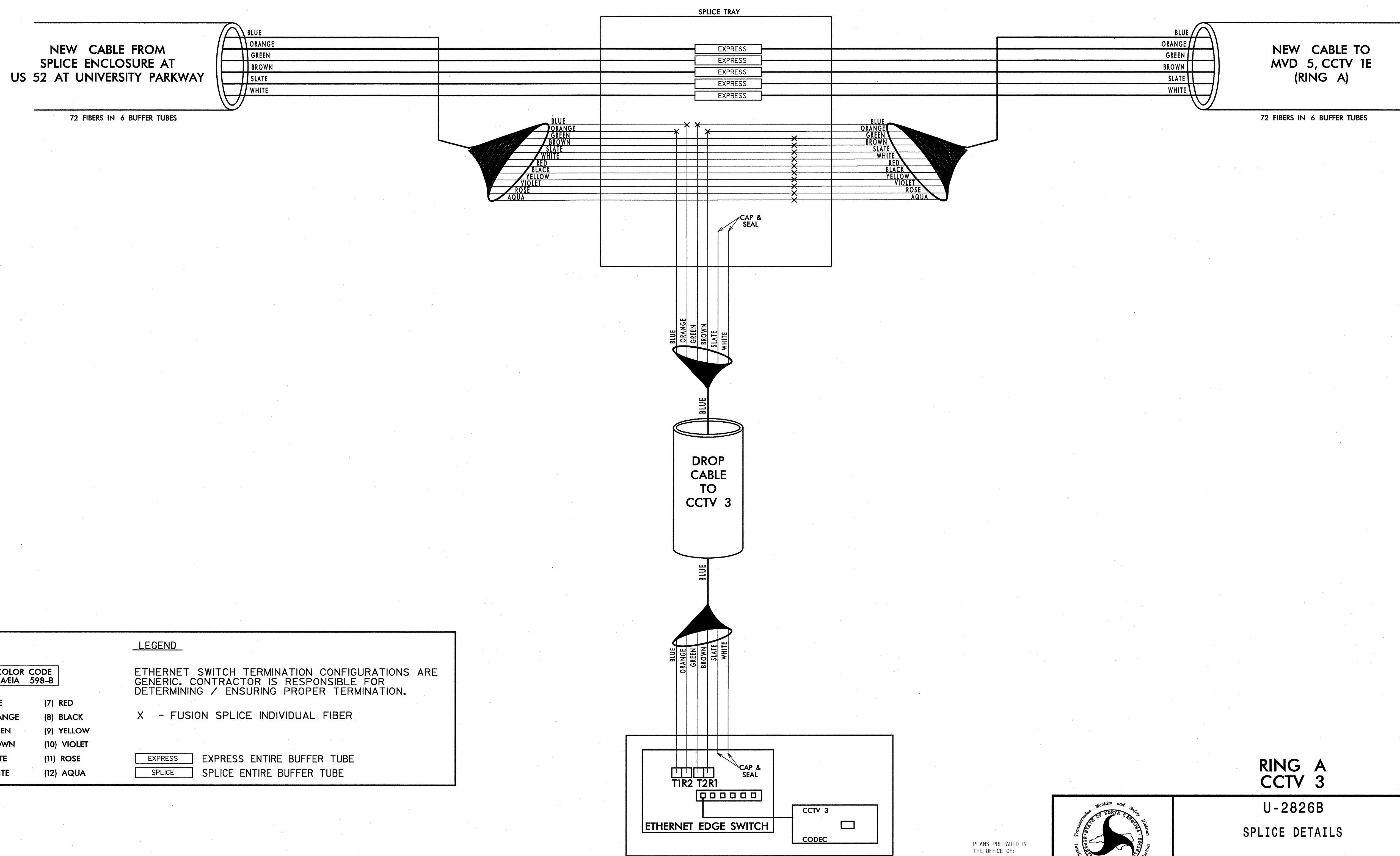

LEGEND

ETHERNET SWITCH TERMINATION CONFIGURATIONS ARE GENERIC. CONTRACTOR IS RESPONSIBLE FOR DETERMINING / ENSURING PROPER TERMINATION.

X - FUSION SPLICE INDIVIDUAL FIBER

| | |
|---------------------------------|-------------|
| COLOR CODE TIA/EIA 598-B | |
| (1) BLUE | (7) RED |
| (2) ORANGE | (8) BLACK |
| (3) GREEN | (9) YELLOW |
| (4) BROWN | (10) VIOLET |
| (5) SLATE | (11) ROSE |
| (6) WHITE | (12) AQUA |

| | |
|---------|----------------------------|
| EXPRESS | EXPRESS ENTIRE BUFFER TUBE |
| SPLICE | SPLICE ENTIRE BUFFER TUBE |

NOTES:
1. FIBER INTERCONNECT CENTER RACKS ARE SCHEMATIC ONLY - ACTUAL EQUIPMENT FORM MAY VARY.

**RING A
CCTV 3**

**U-2826B
SPLICE DETAILS**

PLANS PREPARED IN THE OFFICE OF:
Kimley-Horn and Associates, Inc.
P.O. Box 33068
Raleigh, N.C. 27636-3068
(919) 677-2000
N.C. License # F-0102

750 N. Greenfield Pkwy., Garner, NC 27529

| | |
|---|--------------------------|
| DIVISION 9 FORSYTH COUNTY WINSTON SALEM | |
| PLAN DATE: JANUARY 2011 | REVIEWED BY: S. Phillips |
| PREPARED BY: J. Cross | REVIEWED BY: S. Privette |
| REVISIONS | INIT. DATE |
| | |
| | |

SEAL

1.25.11
DATE

CADD Phenomen

1/25/2011 11:46:05 AM jerry.cross k:\a1\proj_11s\01036158-us_52_11s (u-2826B) (plan) (splice) (SPL32.dgn)

**SPLICE ENCLOSURE AT
MVD 5, CCTV 1E
US 52 SOUTH OF
HANES MILL ROAD**

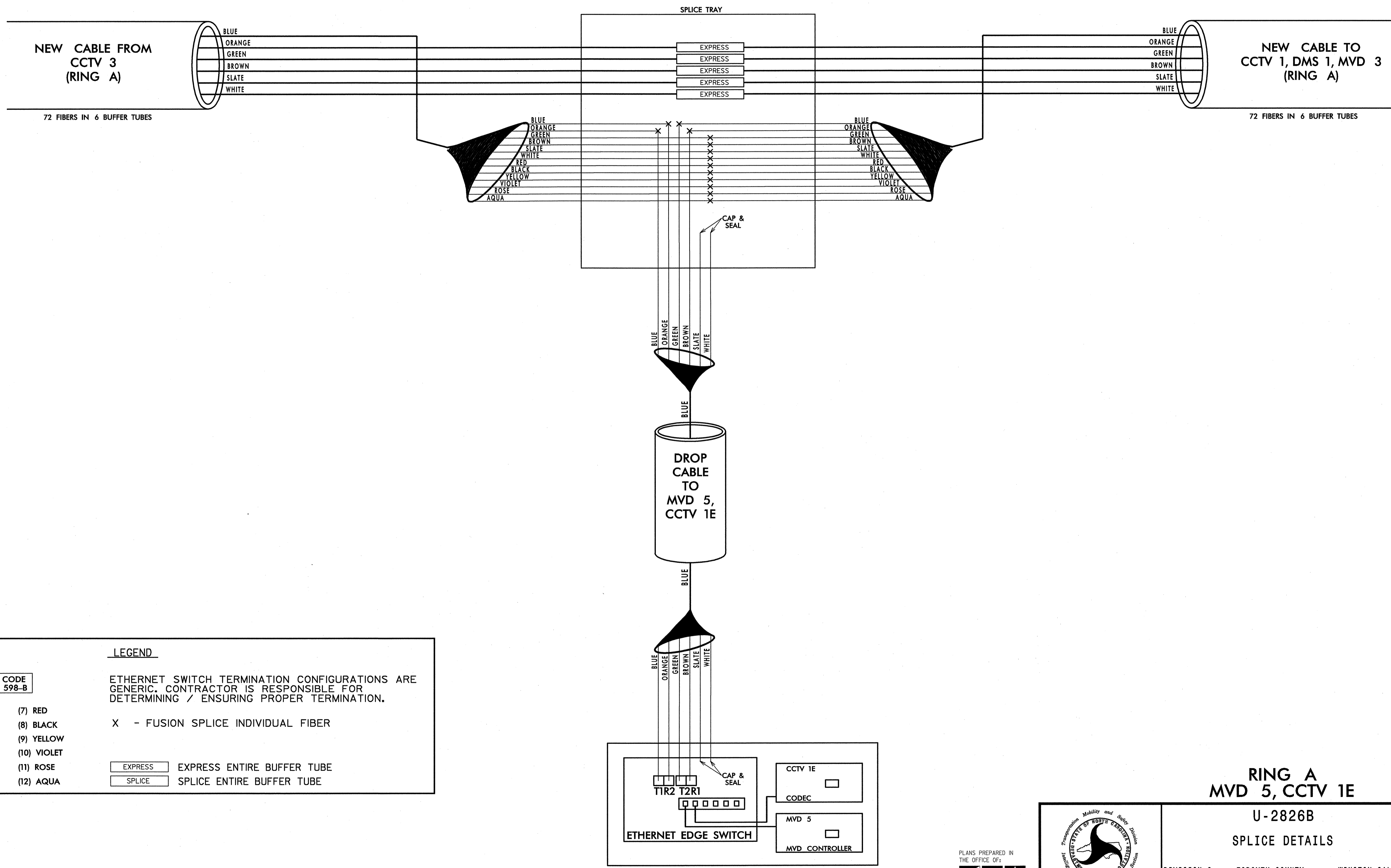

LEGEND

COLOR CODE TIA/EIA 598-B

| | | |
|------------|-------------|--|
| (1) BLUE | (7) RED | ETHERNET SWITCH TERMINATION CONFIGURATIONS ARE GENERIC. CONTRACTOR IS RESPONSIBLE FOR DETERMINING / ENSURING PROPER TERMINATION. |
| (2) ORANGE | (8) BLACK | |
| (3) GREEN | (9) YELLOW | |
| (4) BROWN | (10) VIOLET | |
| (5) SLATE | (11) ROSE | |
| (6) WHITE | (12) AQUA | |

X - FUSION SPLICE INDIVIDUAL FIBER

| | |
|--|----------------------------|
| | EXPRESS ENTIRE BUFFER TUBE |
| | SPLICE ENTIRE BUFFER TUBE |

NOTES:
1. FIBER INTERCONNECT CENTER RACKS ARE SCHEMATIC ONLY - ACTUAL EQUIPMENT FORM MAY VARY.

**RING A
MVD 5, CCTV 1E**

**U-2826B
SPLICE DETAILS**

PLANS PREPARED IN THE OFFICE OF:
Kimley-Horn and Associates, Inc.
P.O. Box 33068
Raleigh N.C. 27636-3068
(919) 677-2000
N.C. License # F-0102

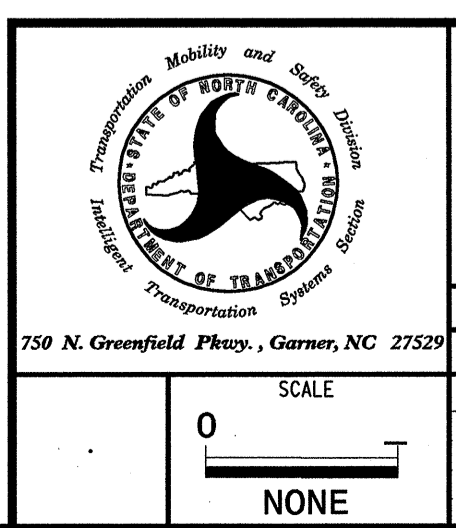

| | |
|---|--------------------------|
| DIVISION 9 FORSYTH COUNTY WINSTON SALEM | |
| PLAN DATE: JANUARY 2011 | REVIEWED BY: S. Phillips |
| PREPARED BY: J. Cross | REVIEWED BY: S. Privette |
| REVISIONS | INIT. DATE |
| | |
| | |
| | |

SEAL

DATE: 1-25-11

CADD Filename: _____

k:\real_tproj_its\0105658-05_p2_1ts (u-2826B)\plan\splicing\SP33.dgn 11:46:09 AM Jerry Cross 1/25/2011

**SPLICE ENCLOSURE AT
CCTV 1, DMS 1, MVD 3
US 52 SOUTH OF
ZIGLAR ROAD**

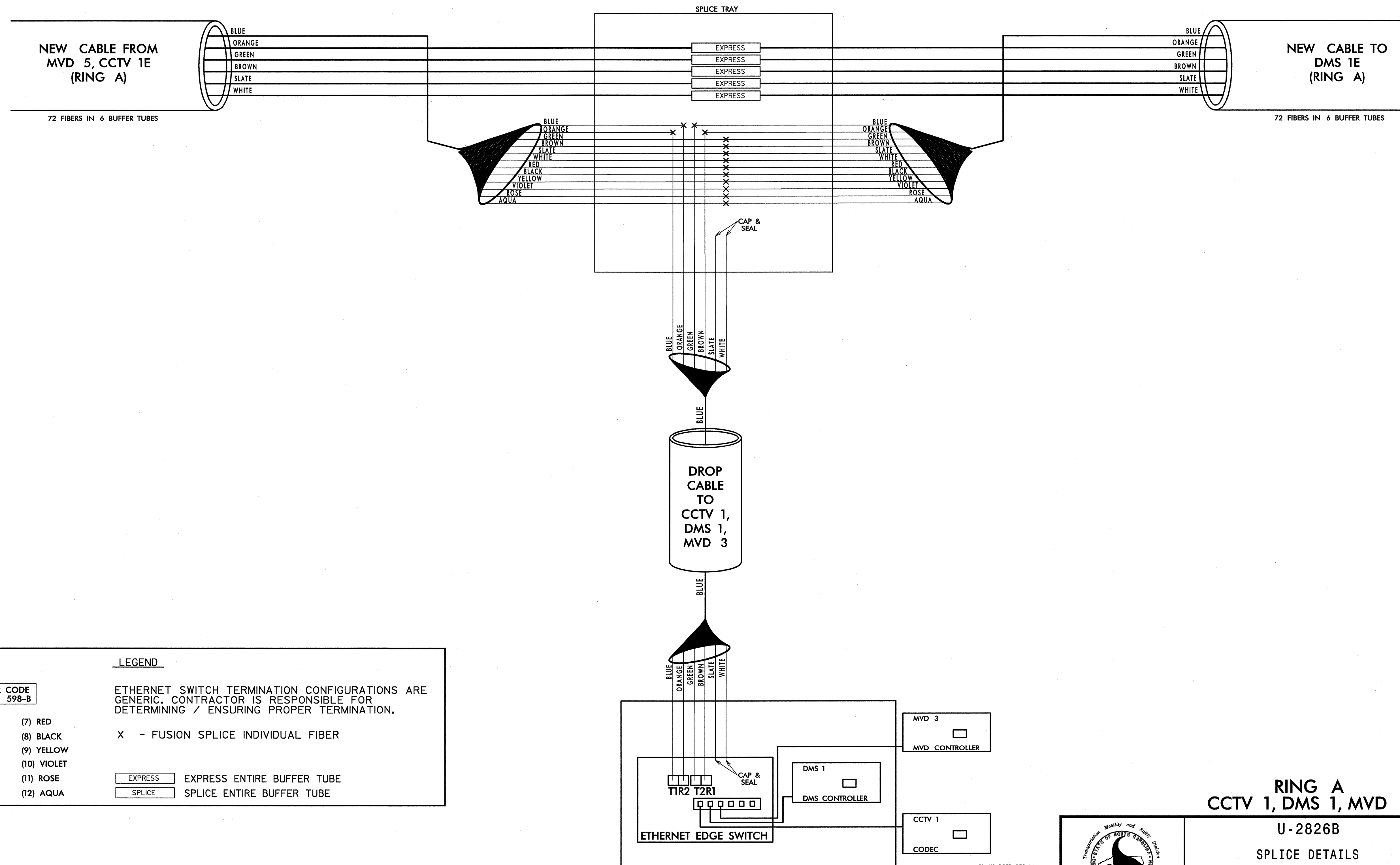

| | | | |
|------------------------------------|-------------|--|----------------------------------|
| COLOR CODE TIA/EIA 598-B | | LEGEND | |
| (1) BLUE | (7) RED | ETHERNET SWITCH TERMINATION CONFIGURATIONS ARE GENERIC. CONTRACTOR IS RESPONSIBLE FOR DETERMINING / ENSURING PROPER TERMINATION. | |
| (2) ORANGE | (8) BLACK | X | - FUSION SPLICE INDIVIDUAL FIBER |
| (3) GREEN | (9) YELLOW | | |
| (4) BROWN | (10) VIOLET | | |
| (5) SLATE | (11) ROSE | EXPRESS | EXPRESS ENTIRE BUFFER TUBE |
| (6) WHITE | (12) AQUA | SPLICE | SPLICE ENTIRE BUFFER TUBE |

NOTES:
1. FIBER INTERCONNECT CENTER RACKS ARE SCHEMATIC ONLY - ACTUAL EQUIPMENT FORM MAY VARY.

**RING A
CCTV 1, DMS 1, MVD 3**

| | | | | |
|---|--|-----------------------------|------------------------------|---|
| | | U-2826B | | |
| | | SPLICE DETAILS | | |
| DIVISION 9 FORSYTH COUNTY WINSTON SALEM PLAN DATE: JANUARY 2011 REVIEWED BY: S. Phillips PREPARED BY: J. Cross REVIEWED BY: S. Privette | | REVISIONS _____ _____ | INIT. DATE _____ _____ | SIGNATURE: <i>Stephanie B. Privette</i> 1-25-11 DATE |
| SCALE: NONE | | CAD Filename: | | |

PLANS PREPARED IN THE OFFICE OF:
Kimley-Horn and Associates, Inc.
P.O. Box 33068
Raleigh, N.C. 27636-3068
(919) 877-2000
N.C. License # F-002

k:\proj\proj_11s\11036158-us_52_11s (u-2826B) (plan) SplSplice.dgn
 11:48:07 AM jerry_cross
 1/25/2011

**SPLICE ENCLOSURE AT DMS 1E
US 52 NORTH OF ZIGLAR ROAD**

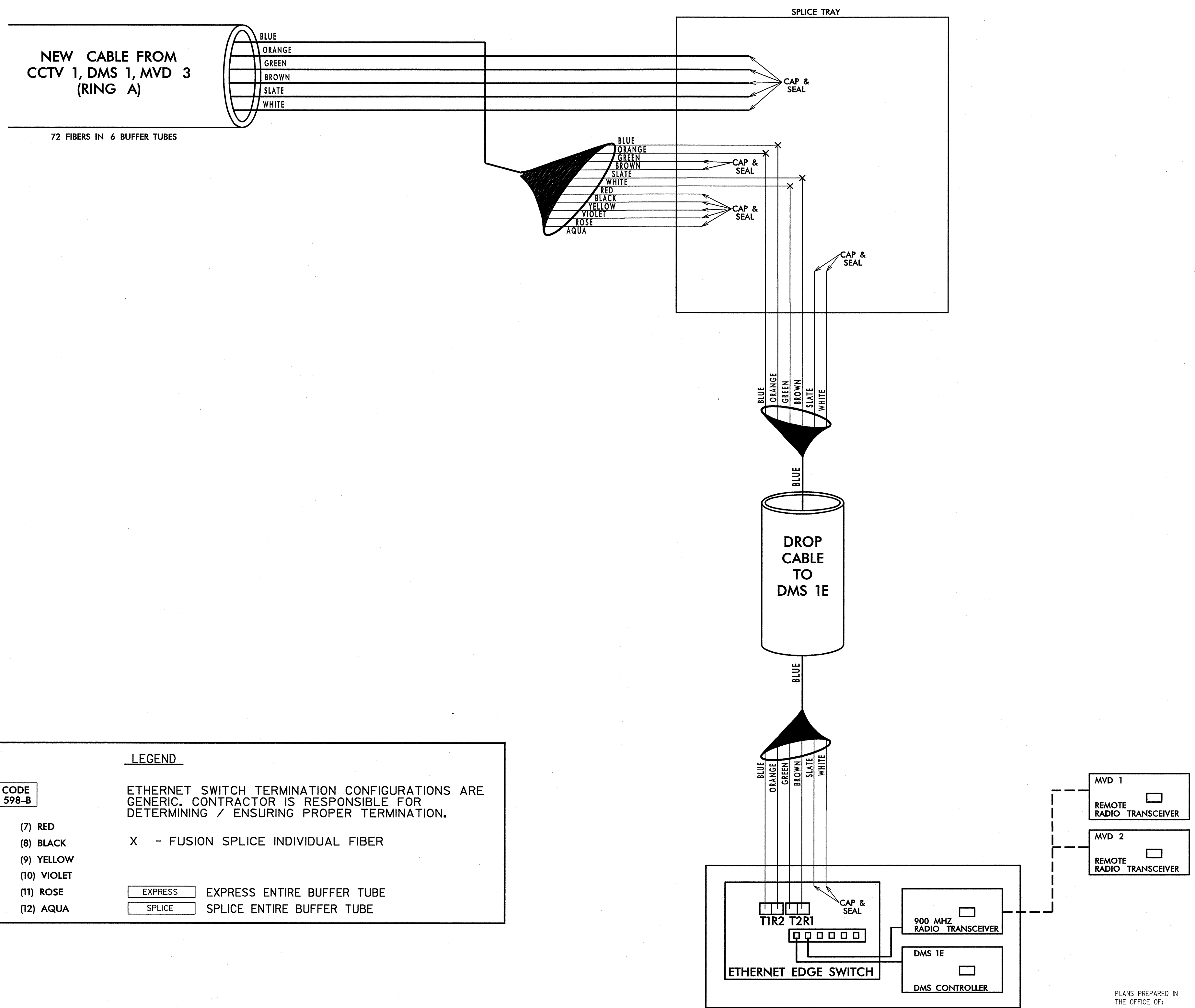

LEGEND

| | | |
|------------------------------------|-------------|--|
| COLOR CODE TIA/EIA 598-B | | ETHERNET SWITCH TERMINATION CONFIGURATIONS ARE GENERIC. CONTRACTOR IS RESPONSIBLE FOR DETERMINING / ENSURING PROPER TERMINATION. |
| (1) BLUE | (7) RED | X - FUSION SPLICE INDIVIDUAL FIBER |
| (2) ORANGE | (8) BLACK | |
| (3) GREEN | (9) YELLOW | |
| (4) BROWN | (10) VIOLET | |
| (5) SLATE | (11) ROSE | EXPRESS ENTIRE BUFFER TUBE |
| (6) WHITE | (12) AQUA | SPLICE ENTIRE BUFFER TUBE |

NOTES:
1. FIBER INTERCONNECT CENTER RACKS ARE SCHEMATIC ONLY - ACTUAL EQUIPMENT FORM MAY VARY.

**RING A
DMS 1E, MVD 1, MVD 2**

| | | | |
|--|---|-------------------------|--|
| | U-2826B | | |
| | SPLICE DETAILS | | |
| | DIVISION 9 FORSYTH COUNTY WINSTON SALEM PLAN DATE: JANUARY 2011 REVIEWED BY: S. Phillips PREPARED BY: J. Cross REVIEWED BY: S. Privette | REVISIONS INIT. DATE | |

PLANS PREPARED IN THE OFFICE OF:
Kimley-Horn and Associates, Inc.
P.O. Box 33068
Raleigh, N.C. 27636-3068
(919) 677-2000
N.C. License # F-0102

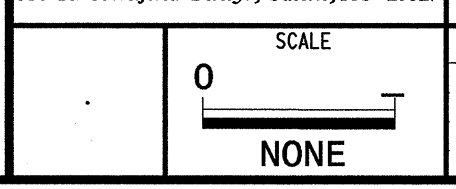

1/25/2011 11:46:09 AM jerry.cross k:\nal_tproj_11s\01036158-us_52_11s (u-2826b)\plan\Splicing\SP35.dgn

**SPLICE ENCLOSURE AT
DMS 2, MVD 6
UNIVERSITY PARKWAY NEAR
UNIVERSITY CENTER DRIVE**

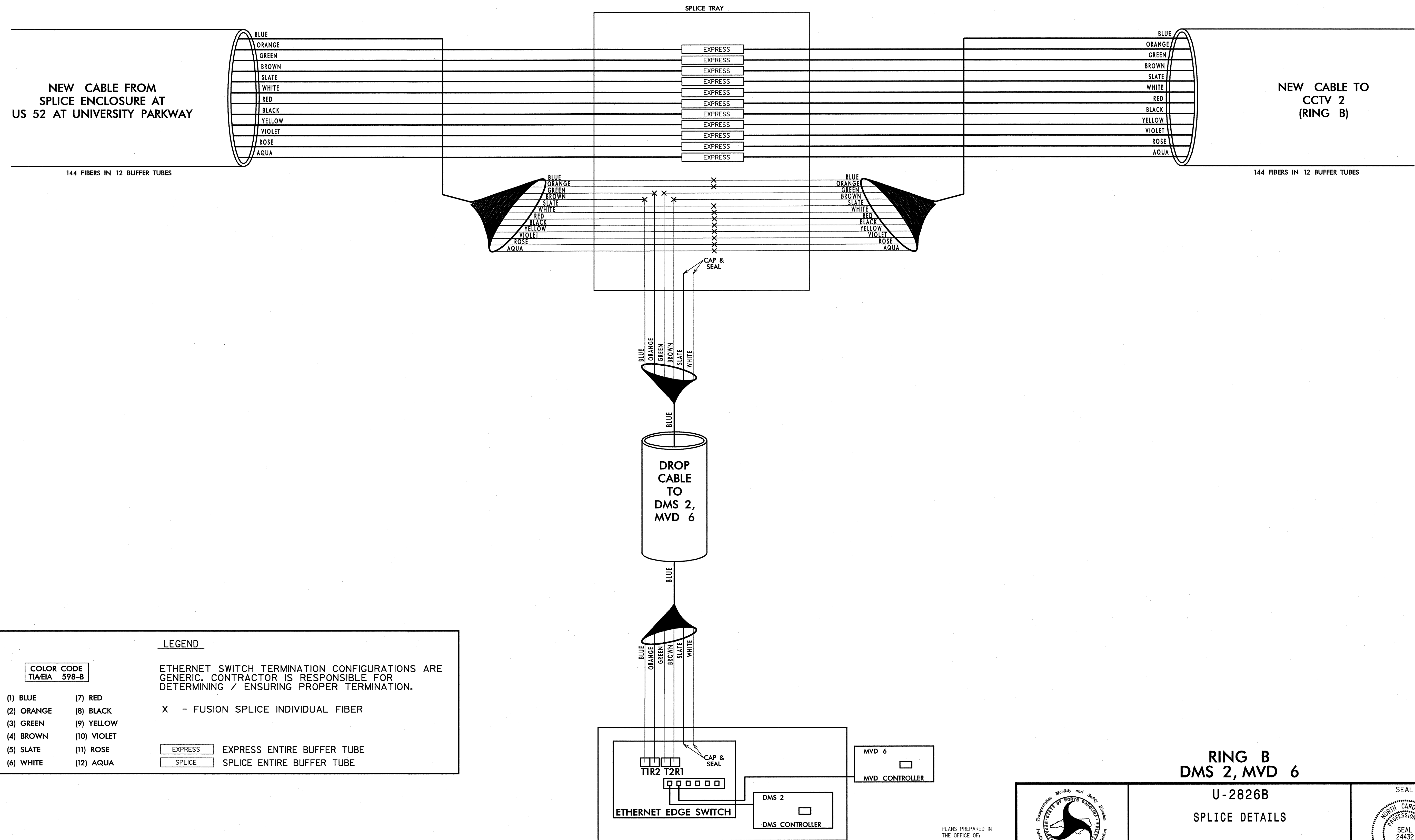

LEGEND

ETHERNET SWITCH TERMINATION CONFIGURATIONS ARE GENERIC. CONTRACTOR IS RESPONSIBLE FOR DETERMINING / ENSURING PROPER TERMINATION.

X - FUSION SPLICE INDIVIDUAL FIBER

| | |
|------------------------------------|-------------|
| COLOR CODE TIA/EIA 598-B | |
| (1) BLUE | (7) RED |
| (2) ORANGE | (8) BLACK |
| (3) GREEN | (9) YELLOW |
| (4) BROWN | (10) VIOLET |
| (5) SLATE | (11) ROSE |
| (6) WHITE | (12) AQUA |

| | |
|---------|----------------------------|
| EXPRESS | EXPRESS ENTIRE BUFFER TUBE |
| SPLICE | SPLICE ENTIRE BUFFER TUBE |

NOTES:
1. FIBER INTERCONNECT CENTER RACKS ARE SCHEMATIC ONLY - ACTUAL EQUIPMENT FORM MAY VARY.

**RING B
DMS 2, MVD 6**

**U-2826B
SPLICE DETAILS**

PLANS PREPARED IN THE OFFICE OF:
Kimley-Horn and Associates, Inc.
P.O. Box 33068
Raleigh, N.C. 27636-3068
(919) 677-2000
N.C. License # F-0102

759 N. Greenfield Pkwy., Garner, NC 27529

| | |
|---|--------------------------|
| DIVISION 9 FORSYTH COUNTY WINSTON SALEM | |
| PLAN DATE: JANUARY 2011 | REVIEWED BY: S. Phillips |
| PREPARED BY: J. Cross | REVIEWED BY: S. Privette |
| SCALE | REVISIONS |
| 0 | INIT. DATE |
| NONE | |

SEAL

1-25-11

CADD: [Signature]

k:\real\proj\1101036158.us_52_11s (u-2826B) (plan) (splice) (SPL36.dgn) 11:48:09 AM jerry_cross 1/25/2011

**SPLICE ENCLOSURE AT CCTV 2
UNIVERSITY PARKWAY
NEAR HANES MILL ROAD**

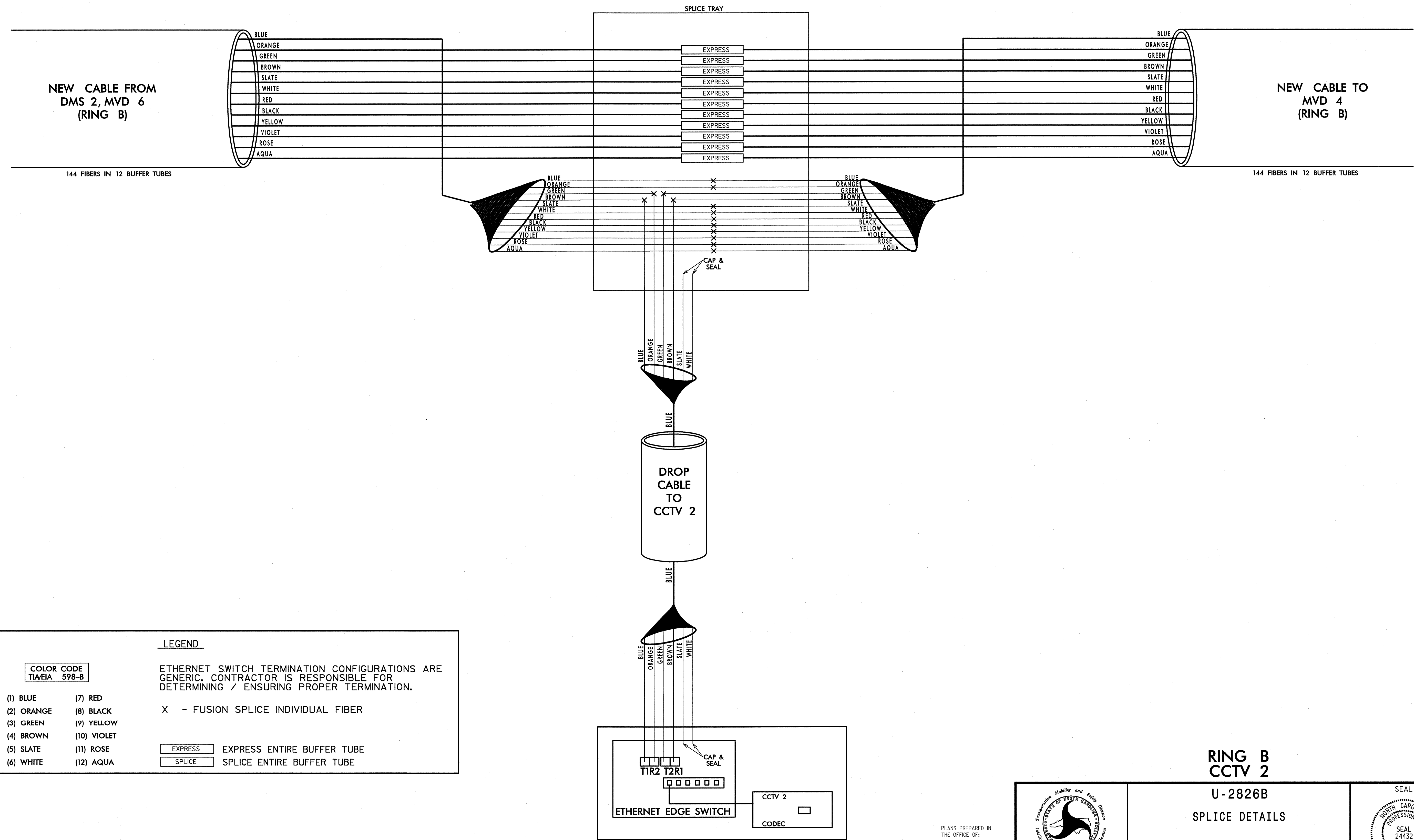

LEGEND

ETHERNET SWITCH TERMINATION CONFIGURATIONS ARE GENERIC. CONTRACTOR IS RESPONSIBLE FOR DETERMINING / ENSURING PROPER TERMINATION.

X - FUSION SPLICE INDIVIDUAL FIBER

| | |
|---------|----------------------------|
| EXPRESS | EXPRESS ENTIRE BUFFER TUBE |
| SPLICE | SPLICE ENTIRE BUFFER TUBE |

COLOR CODE TIA/EIA 598-B

| | |
|------------|-------------|
| (1) BLUE | (7) RED |
| (2) ORANGE | (8) BLACK |
| (3) GREEN | (9) YELLOW |
| (4) BROWN | (10) VIOLET |
| (5) SLATE | (11) ROSE |
| (6) WHITE | (12) AQUA |

NOTES:
1. FIBER INTERCONNECT CENTER RACKS ARE SCHEMATIC ONLY - ACTUAL EQUIPMENT FORM MAY VARY.

**RING B
CCTV 2**

**U-2826B
SPLICE DETAILS**

PLANS PREPARED IN THE OFFICE OF:
Kimley-Horn and Associates, Inc.
P.O. Box 33068
Raleigh, N.C. 27636-3068
(919) 677-2000
N.C. License # F-002

759 N. Greenfield Place, Garner, NC 27529

SCALE: NONE

| | |
|---|--------------------------|
| DIVISION 9 FORSYTH COUNTY WINSTON SALEM | |
| PLAN DATE: JANUARY 2011 | REVIEWED BY: S. Phillips |
| PREPARED BY: J. Cross | REVIEWED BY: S. Privette |
| REVISIONS | INIT. DATE |
| | |

SEAL

SIGNATURE: *Stephanie B. Privette* 1-25-11
DATE

CADD Filename:

1/25/2011 11:48:10 AM jerry_cross k:\rtd\p001_145101086158-us_52_114 (u-2826B) (plan) (splice) (SPL37.dgn)

**SPLICE ENCLOSURE AT MVD 4
UNIVERSITY PARKWAY
NORTH OF CORAL DRIVE**

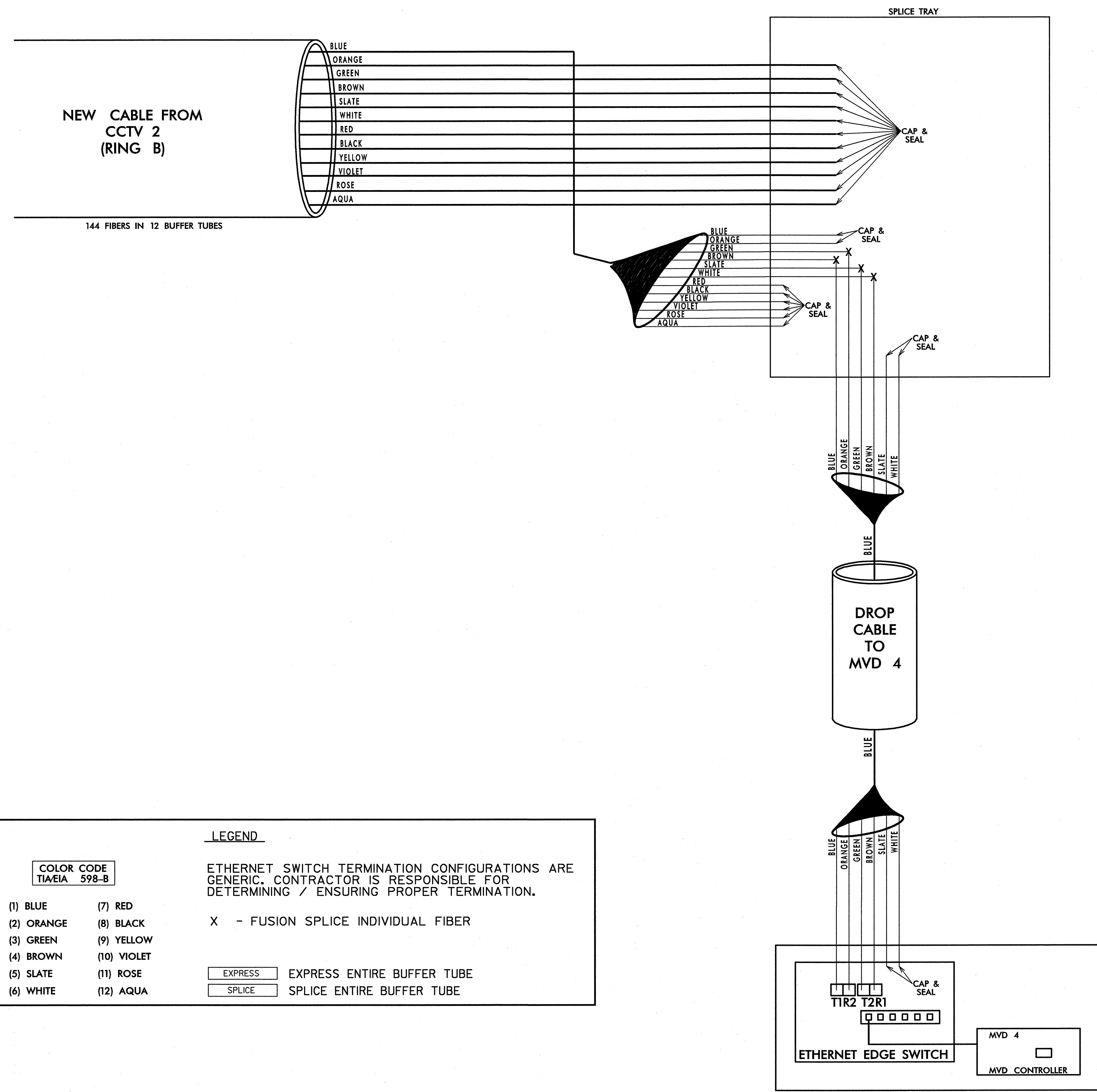

LEGEND

ETHERNET SWITCH TERMINATION CONFIGURATIONS ARE GENERIC. CONTRACTOR IS RESPONSIBLE FOR DETERMINING / ENSURING PROPER TERMINATION.

X - FUSION SPLICE INDIVIDUAL FIBER

| | |
|---------|----------------------------|
| EXPRESS | EXPRESS ENTIRE BUFFER TUBE |
| SPLICE | SPLICE ENTIRE BUFFER TUBE |

COLOR CODE TIA/EIA 598-B

| | |
|------------|-------------|
| (1) BLUE | (7) RED |
| (2) ORANGE | (8) BLACK |
| (3) GREEN | (9) YELLOW |
| (4) BROWN | (10) VIOLET |
| (5) SLATE | (11) ROSE |
| (6) WHITE | (12) AQUA |

NOTES:
1. FIBER INTERCONNECT CENTER RACKS ARE SCHEMATIC ONLY - ACTUAL EQUIPMENT FORM MAY VARY.

**RING B
MVD 4**

**U-2826B
SPLICE DETAILS**

PLANS PREPARED IN THE OFFICE OF:
Kimley-Horn and Associates, Inc.
P.O. Box 33068
Raleigh, N.C. 27636-3068
(919) 677-2000
N.C. License # F-0102

| | | |
|-----------------------|--|--------------------------|
| | DIVISION 9 FORSYTH COUNTY WINSTON SALEM | |
| | PLAN DATE: JANUARY 2011 | REVIEWED BY: S. Phillips |
| PREPARED BY: J. Cross | REVIEWED BY: S. Privette | |
| SCALE: NONE | REVISIONS: | INIT. DATE |
| | 1-25-11 | DATE |

1/25/2011 11:46:11 AM jerry.cross k:\real\proj_1101038156.us_11s (u-2826B)\plan\splice.dwg (SPL38.dgn)

**SPLICE ENCLOSURE AT MVD 7
US 52 SOUTH OF
UNIVERSITY PARKWAY**

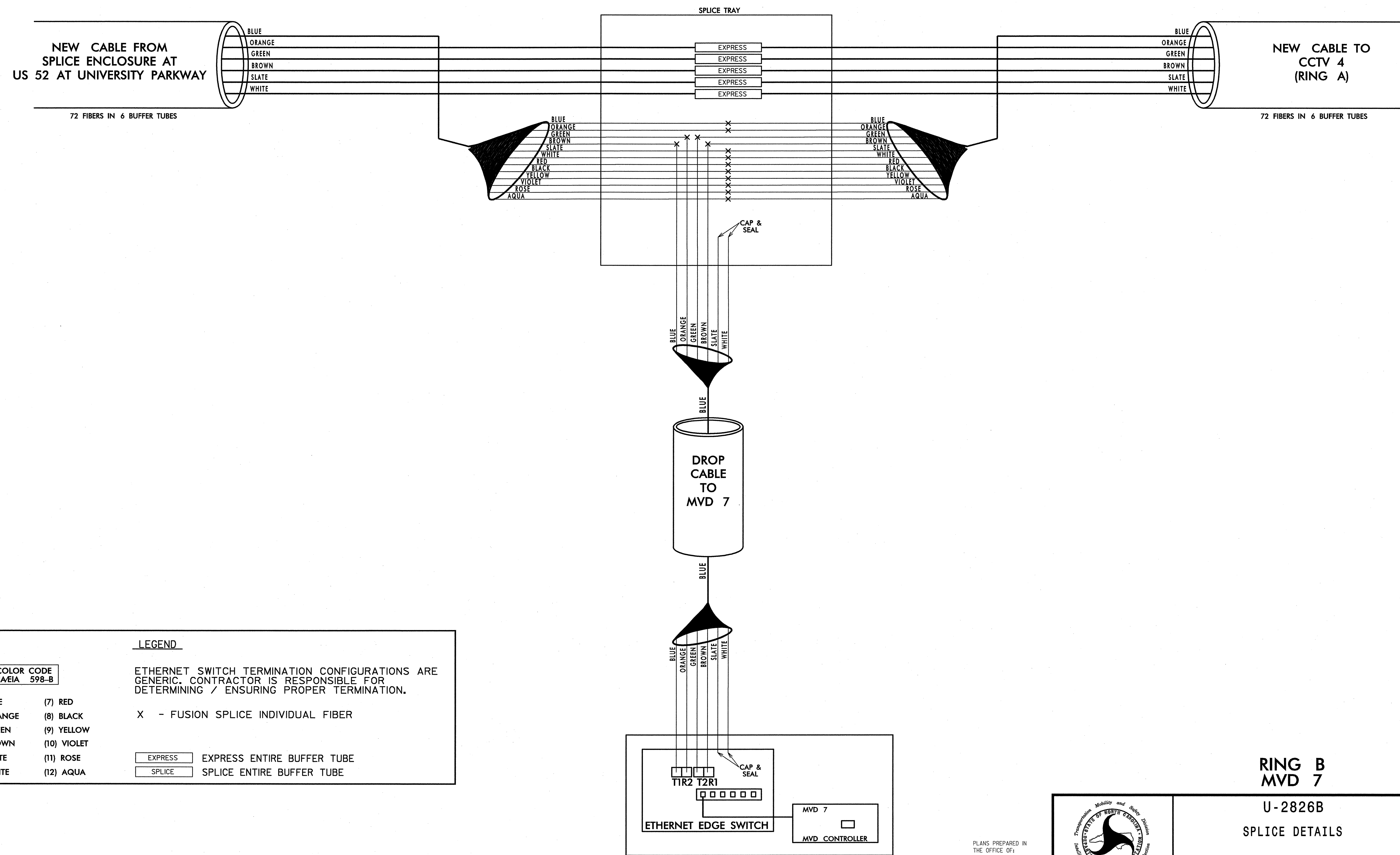

LEGEND

ETHERNET SWITCH TERMINATION CONFIGURATIONS ARE GENERIC. CONTRACTOR IS RESPONSIBLE FOR DETERMINING / ENSURING PROPER TERMINATION.

X - FUSION SPLICE INDIVIDUAL FIBER

| | |
|---------------------------------|-------------|
| COLOR CODE TIA/EIA 598-B | |
| (1) BLUE | (7) RED |
| (2) ORANGE | (8) BLACK |
| (3) GREEN | (9) YELLOW |
| (4) BROWN | (10) VIOLET |
| (5) SLATE | (11) ROSE |
| (6) WHITE | (12) AQUA |

| | |
|---------|----------------------------|
| EXPRESS | EXPRESS ENTIRE BUFFER TUBE |
| SPLICE | SPLICE ENTIRE BUFFER TUBE |

NOTES:
1. FIBER INTERCONNECT CENTER RACKS ARE SCHEMATIC ONLY - ACTUAL EQUIPMENT FORM MAY VARY.

**RING B
MVD 7**

**U-2826B
SPLICE DETAILS**

DIVISION 9 FORSYTH COUNTY WINSTON SALEM

| | |
|-------------------------|--------------------------|
| PLAN DATE: JANUARY 2011 | REVIEWED BY: S. Phillips |
| PREPARED BY: J. Cross | REVIEWED BY: S. Privette |

SCALE: NONE

SEAL: NORTH CAROLINA PROFESSIONAL ENGINEER SEAL 24432 STEPHANIE B. PRIVETTE

SIGNATURE: [Signature] DATE: 1-25-11

CAAD Filename:

PLANS PREPARED IN THE OFFICE OF:
Kimley-Horn and Associates, Inc.
P.O. Box 33068
Raleigh, N.C. 27636-3068
(919) 677-2000
N.C. License # F-0102

1/25/2011 11:48:12 AM jbrty_cross k:\real\proj_1\1038596-us_52_1ts (u-2826b)\plan\Splicing\SP39.dgn

**SPLICE ENCLOSURE AT CCTV 4
US 52
NORTH OF OAK SUMMIT ROAD**

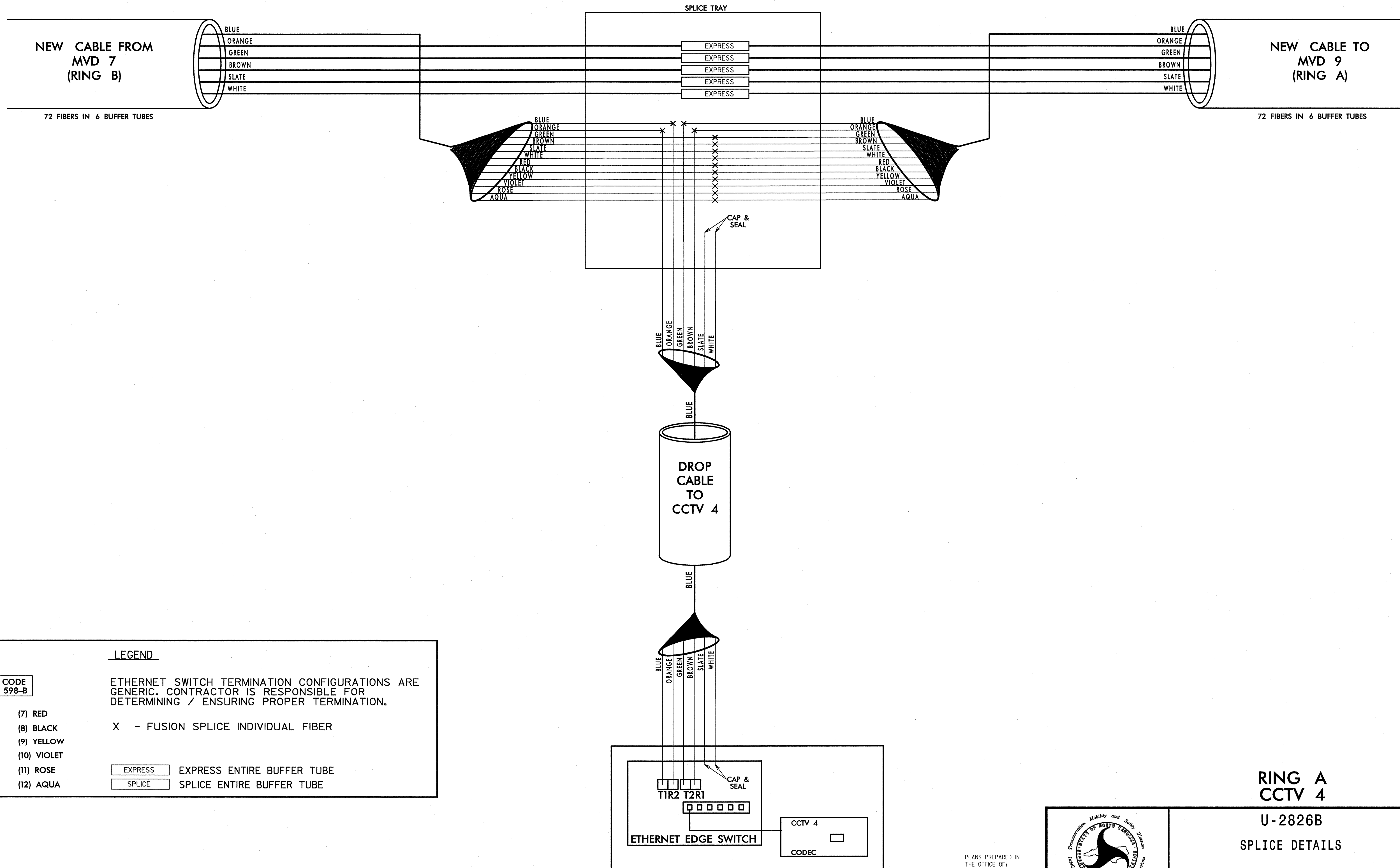

LEGEND

COLOR CODE
TIA/EIA 598-B

| | | |
|------------|-------------|--|
| (1) BLUE | (7) RED | ETHERNET SWITCH TERMINATION CONFIGURATIONS ARE GENERIC. CONTRACTOR IS RESPONSIBLE FOR DETERMINING / ENSURING PROPER TERMINATION. |
| (2) ORANGE | (8) BLACK | |
| (3) GREEN | (9) YELLOW | |
| (4) BROWN | (10) VIOLET | |
| (5) SLATE | (11) ROSE | |
| (6) WHITE | (12) AQUA | |

X - FUSION SPLICE INDIVIDUAL FIBER

| | |
|--|----------------------------|
| | EXPRESS ENTIRE BUFFER TUBE |
| | SPLICE ENTIRE BUFFER TUBE |

NOTES:
1. FIBER INTERCONNECT CENTER RACKS ARE SCHEMATIC ONLY - ACTUAL EQUIPMENT FORM MAY VARY.

**RING A
CCTV 4**

U-2826B

SPLICE DETAILS

PLANS PREPARED IN THE OFFICE OF:
Kimley-Horn and Associates, Inc.
P.O. Box 33068
Raleigh N.C. 27636-3068
(919) 677-2000
N.C. License # F-0102

| | | |
|--|---|-------------------------|
| | DIVISION 9 FORSYTH COUNTY WINSTON SALEM PLAN DATE: JANUARY 2011 REVIEWED BY: S. Phillips PREPARED BY: J. Cross REVIEWED BY: S. Privette | |
| | SCALE 0 NONE | REVISIONS INIT. DATE |

k:\na1_tproj_11a\01080658-us_52_11a (u-2826B)\plan\Spllicing(SPL-40).dgn
 11:48:19 AM Jerry Cross
 1/25/2011

**SPLICE ENCLOSURE AT MVD 9
US 52 SOUTH
OF OAK SUMMIT ROAD**

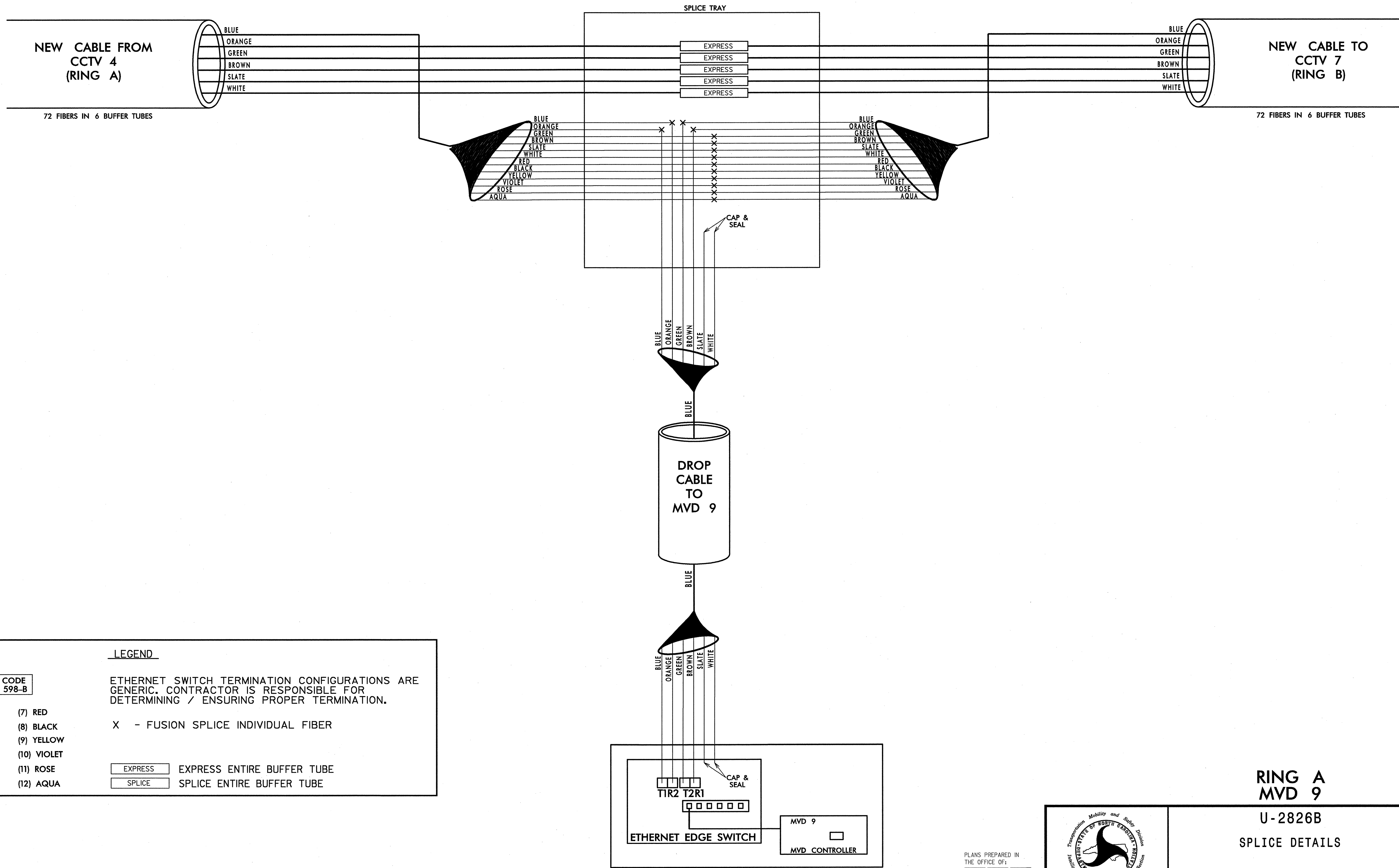

LEGEND

| | | |
|------------------------------------|-------------|--|
| COLOR CODE TIA/EIA 598-B | | ETHERNET SWITCH TERMINATION CONFIGURATIONS ARE GENERIC. CONTRACTOR IS RESPONSIBLE FOR DETERMINING / ENSURING PROPER TERMINATION. |
| (1) BLUE | (7) RED | X - FUSION SPLICE INDIVIDUAL FIBER |
| (2) ORANGE | (8) BLACK | |
| (3) GREEN | (9) YELLOW | |
| (4) BROWN | (10) VIOLET | |
| (5) SLATE | (11) ROSE | EXPRESS ENTIRE BUFFER TUBE |
| (6) WHITE | (12) AQUA | SPLICE ENTIRE BUFFER TUBE |

NOTES:
1. FIBER INTERCONNECT CENTER RACKS ARE SCHEMATIC ONLY - ACTUAL EQUIPMENT FORM MAY VARY.

**RING A
MVD 9**

**U-2826B
SPLICE DETAILS**

PLANS PREPARED IN THE OFFICE OF:
Kimley-Horn and Associates, Inc.
P.O. Box 33068
Raleigh, N.C. 27636-3068
(919) 677-2000
N.C. License # F-0102

750 N. Greenfield Pkwy., Garner, NC 27529

| | |
|---|--------------------------|
| DIVISION 9 FORSYTH COUNTY WINSTON SALEM | |
| PLAN DATE: JANUARY 2011 | REVIEWED BY: S. Phillips |
| PREPARED BY: J. Cross | REVIEWED BY: S. Privette |
| SCALE: NONE | REVISIONS |
| | INIT. DATE |

SEAL

DATE: 1-25-11

1/25/2011 11:48:14 AM jerry.cross k:\real\proj\1101086\58-us_52_11s (u-2826B)\plan\splice.dwg

**SPLICE ENCLOSURE AT CCTV 7
US 52 NORTH OF
GERMANTON ROAD**

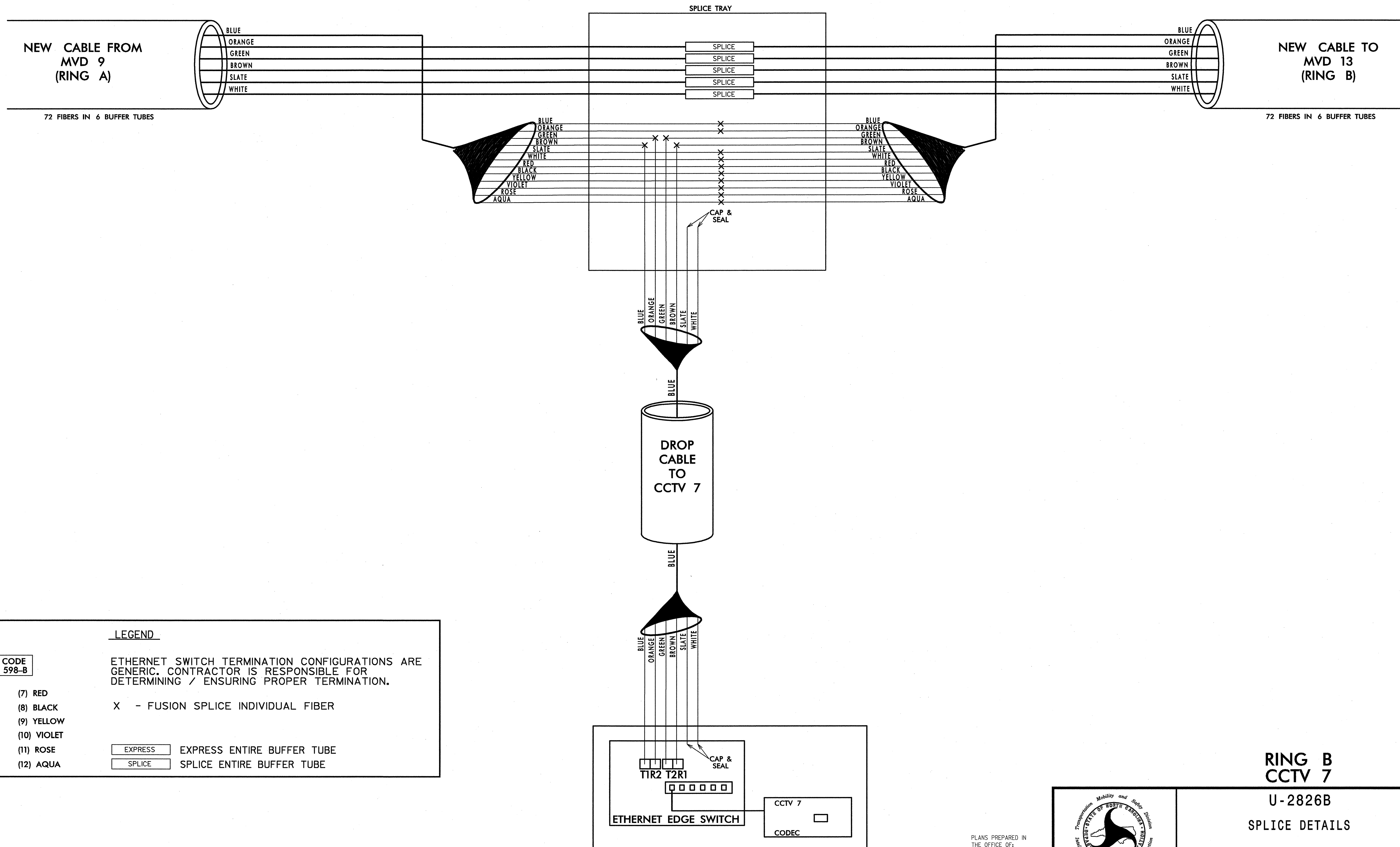

LEGEND

ETHERNET SWITCH TERMINATION CONFIGURATIONS ARE GENERIC. CONTRACTOR IS RESPONSIBLE FOR DETERMINING / ENSURING PROPER TERMINATION.

X - FUSION SPLICE INDIVIDUAL FIBER

| | |
|---------|----------------------------|
| EXPRESS | EXPRESS ENTIRE BUFFER TUBE |
| SPLICE | SPLICE ENTIRE BUFFER TUBE |

COLOR CODE TIA/EIA 598-B

| | |
|------------|-------------|
| (1) BLUE | (7) RED |
| (2) ORANGE | (8) BLACK |
| (3) GREEN | (9) YELLOW |
| (4) BROWN | (10) VIOLET |
| (5) SLATE | (11) ROSE |
| (6) WHITE | (12) AQUA |

NOTES:
1. FIBER INTERCONNECT CENTER RACKS ARE SCHEMATIC ONLY - ACTUAL EQUIPMENT FORM MAY VARY.

**RING B
CCTV 7**

**U-2826B
SPLICE DETAILS**

PLANS PREPARED IN THE OFFICE OF:
Kimley-Horn and Associates, Inc.
P.O. Box 33068
Raleigh, N.C. 27636-3068
(919) 677-2000
N.C. License # F-0102

750 N. Greenfield Pkwy., Garner, NC 27529

| | |
|---|--------------------------|
| DIVISION 9 FORSYTH COUNTY WINSTON SALEM | |
| PLAN DATE: JANUARY 2011 | REVIEWED BY: S. Phillips |
| PREPARED BY: J. Cross | REVIEWED BY: S. Privette |
| SCALE: NONE | REVISIONS |
| INIT. | DATE |

SEAL

1-25-11
DATE

CADD Filename

k:\na\proj_115\011036156-us_52_its (u-2826B)\plan\Splicing\SP42.dgn 11:46:15 AM jbrty.cross 1/25/2011

**SPLICE ENCLOSURE AT MVD 13
US 52 SOUTH OF
GERMANTON ROAD**

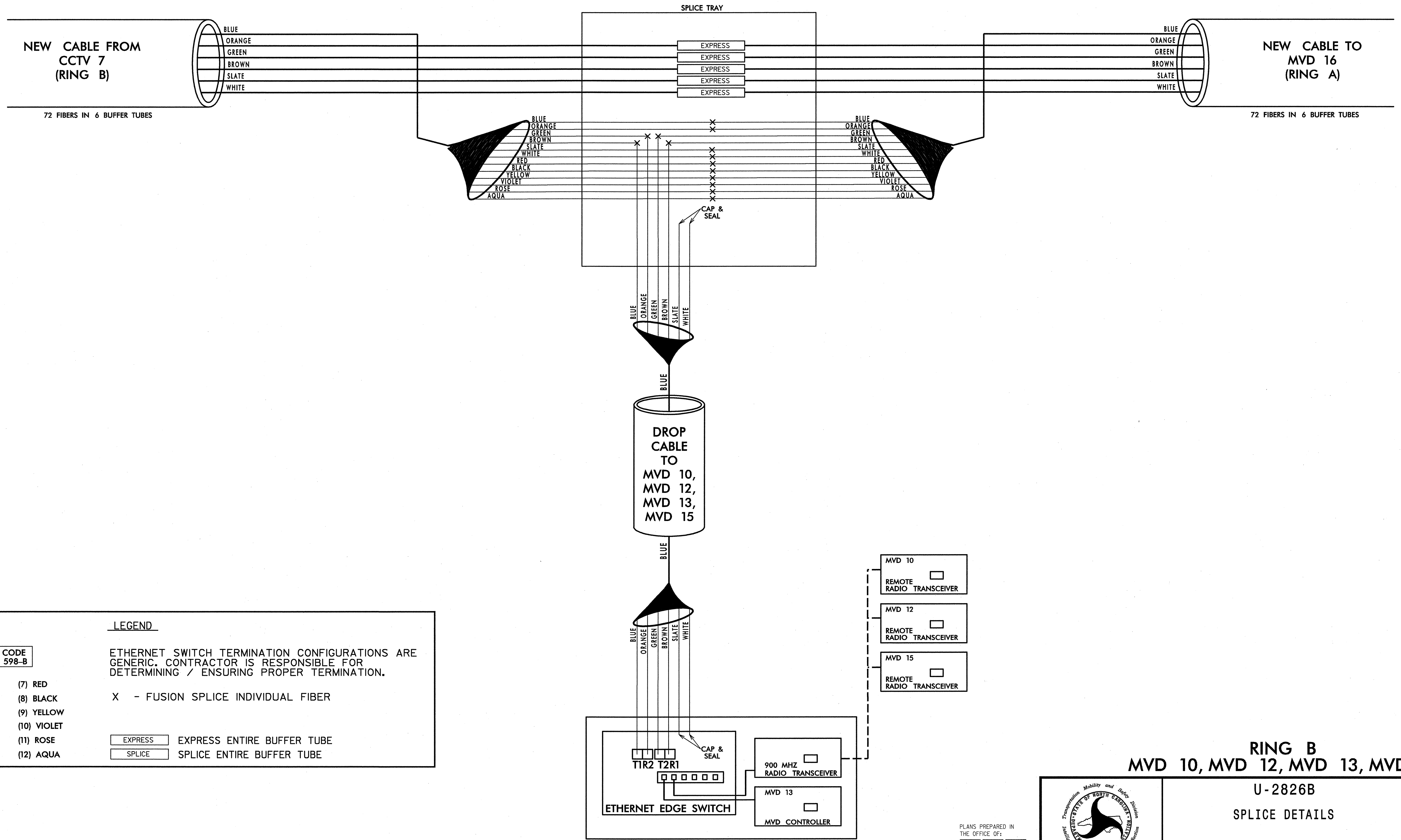

LEGEND

ETHERNET SWITCH TERMINATION CONFIGURATIONS ARE GENERIC. CONTRACTOR IS RESPONSIBLE FOR DETERMINING / ENSURING PROPER TERMINATION.

X - FUSION SPLICE INDIVIDUAL FIBER

| COLOR CODE TIA/EIA 598-B | |
|-----------------------------|-------------|
| (1) BLUE | (7) RED |
| (2) ORANGE | (8) BLACK |
| (3) GREEN | (9) YELLOW |
| (4) BROWN | (10) VIOLET |
| (5) SLATE | (11) ROSE |
| (6) WHITE | (12) AQUA |

| | |
|---------|----------------------------|
| EXPRESS | EXPRESS ENTIRE BUFFER TUBE |
| SPLICE | SPLICE ENTIRE BUFFER TUBE |

NOTES:
1. FIBER INTERCONNECT CENTER RACKS ARE SCHEMATIC ONLY - ACTUAL EQUIPMENT FORM MAY VARY.

**RING B
MVD 10, MVD 12, MVD 13, MVD 15**

**U-2826B
SPLICE DETAILS**

| | |
|---|--------------------------|
| DIVISION 9 FORSYTH COUNTY WINSTON SALEM | |
| PLAN DATE: JANUARY 2011 | REVIEWED BY: S. Phillips |
| PREPARED BY: J. Cross | REVIEWED BY: S. Privette |
| SCALE: NONE | REVISIONS |
| INIT. | DATE |

SEAL
NORTH CAROLINA PROFESSIONAL ENGINEER
SEAL 24432
STEPHANIE B. PRIVETTE

1/25/11
DATE

CADD Filename

PLANS PREPARED IN THE OFFICE OF:
Kimley-Horn and Associates, Inc.
P.O. Box 33068
Raleigh, N.C. 27636-3068
(919) 677-2000
N.C. License # F-002

1/25/2011 11:46:19 AM jerry.cross k:\na\proj\13s\0108858.us_13s (u-2826B)\plan\Splicing\SP43.dgn

**SPLICE ENCLOSURE AT MVD 16
US 52 NORTH OF MOTOR ROAD**

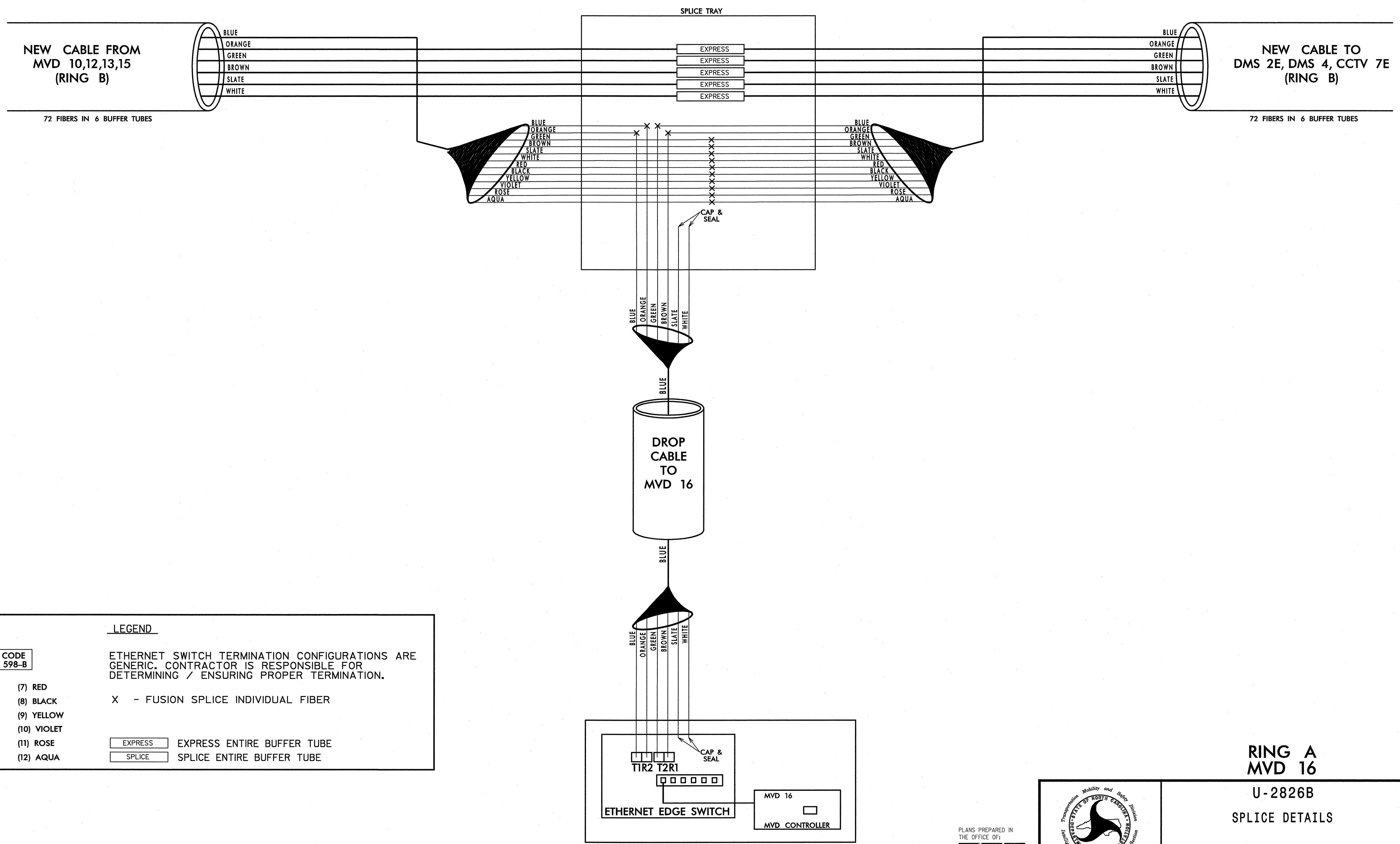

LEGEND

| | | |
|---------------------------------|-------------|--|
| COLOR CODE TIA/EIA 598-B | | ETHERNET SWITCH TERMINATION CONFIGURATIONS ARE GENERIC. CONTRACTOR IS RESPONSIBLE FOR DETERMINING / ENSURING PROPER TERMINATION. |
| (1) BLUE | (7) RED | X - FUSION SPLICE INDIVIDUAL FIBER |
| (2) ORANGE | (8) BLACK | |
| (3) GREEN | (9) YELLOW | |
| (4) BROWN | (10) VIOLET | |
| (5) SLATE | (11) ROSE | EXPRESS ENTIRE BUFFER TUBE |
| (6) WHITE | (12) AQUA | SPLICE ENTIRE BUFFER TUBE |

NOTES:
1. FIBER INTERCONNECT CENTER RACKS ARE SCHEMATIC ONLY - ACTUAL EQUIPMENT FORM MAY VARY.

**RING A
MVD 16**

**U-2826B
SPLICE DETAILS**

PLANS PREPARED IN THE OFFICE OF:

Kimley-Horn and Associates, Inc.
P.O. Box 33068
Raleigh, N.C. 27636-3068
(919) 677-2000
N.C. License # F-0102

| | | | |
|------------|--|--|-------|
| | DIVISION 9 FORSYTH COUNTY WINSTON SALEM | | |
| | PLAN DATE: JANUARY 2011 PREPARED BY: J. Cross | REVIEWED BY: S. Phillips REVIEWED BY: S. Privette | |
| SIGNATURE: | | DATE: 1-25-11 | SEAL: |

k:\nal_tproj_11s\0108158-us_52_11s (u-2826B)\plan\splice\splic44.dgn
 11:48:17 AM
 jerry.cross
 1/25/2011

**SPLICE ENCLOSURE AT
DMS 2E, DMS 4, CCTV 7E
US 52 NEAR MOTOR ROAD**

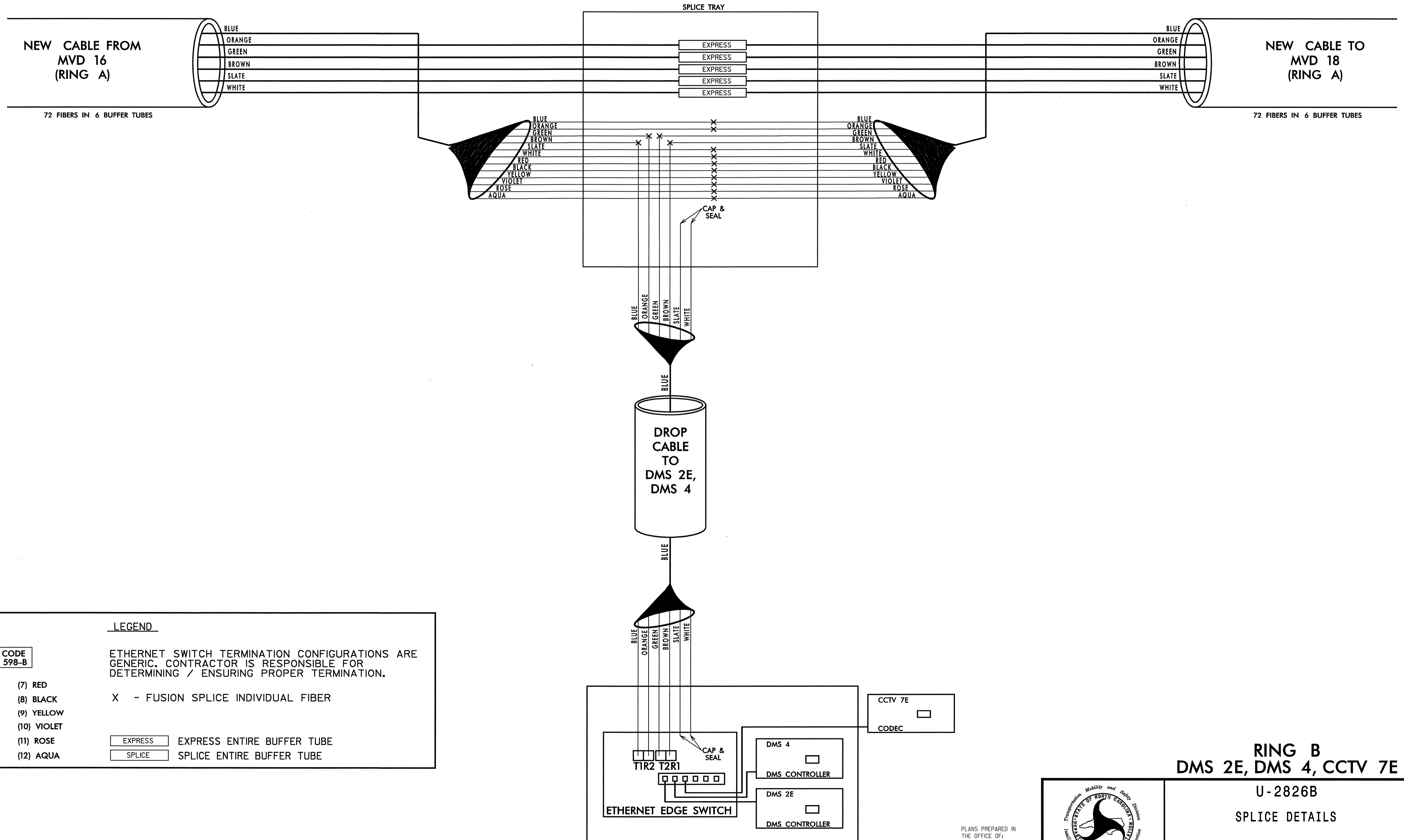

LEGEND

ETHERNET SWITCH TERMINATION CONFIGURATIONS ARE GENERIC. CONTRACTOR IS RESPONSIBLE FOR DETERMINING / ENSURING PROPER TERMINATION.

X - FUSION SPLICE INDIVIDUAL FIBER

| | |
|------------------------------------|-------------|
| COLOR CODE TIA/EIA 598-B | |
| (1) BLUE | (7) RED |
| (2) ORANGE | (8) BLACK |
| (3) GREEN | (9) YELLOW |
| (4) BROWN | (10) VIOLET |
| (5) SLATE | (11) ROSE |
| (6) WHITE | (12) AQUA |

| | |
|--|----------------------------|
| | EXPRESS ENTIRE BUFFER TUBE |
| | SPLICE ENTIRE BUFFER TUBE |

NOTES:
1. FIBER INTERCONNECT CENTER RACKS ARE SCHEMATIC ONLY - ACTUAL EQUIPMENT FORM MAY VARY.

**RING B
DMS 2E, DMS 4, CCTV 7E**

| | | | |
|-------------------------|---|-------|---------|
| | U-2826B SPLICE DETAILS | | |
| | DIVISION 9 FORSYTH COUNTY WINSTON SALEM | | |
| PLAN DATE: JANUARY 2011 | REVIEWED BY: S. Phillips | | 1/25/11 |
| PREPARED BY: J. Cross | REVIEWED BY: S. Privette | | |
| SCALE NONE | REVISIONS | INIT. | DATE |
| CAD: Filername | | | DATE |

PLANS PREPARED IN THE OFFICE OF:

Kimley-Horn and Associates, Inc.
 P.O. Box 33068
 Raleigh, N.C. 27636-3068
 (919) 677-2000
 N.C. License # F-0102

1/25/2011 11:48:18 AM jerry.cross k:\val\proj\145101086158-us_52_its (u-2826B)\plan\Spl1.dwg SPL45.dgn

**SPLICE ENCLOSURE AT MVD 18
US 52 SOUTH OF MOTOR ROAD**

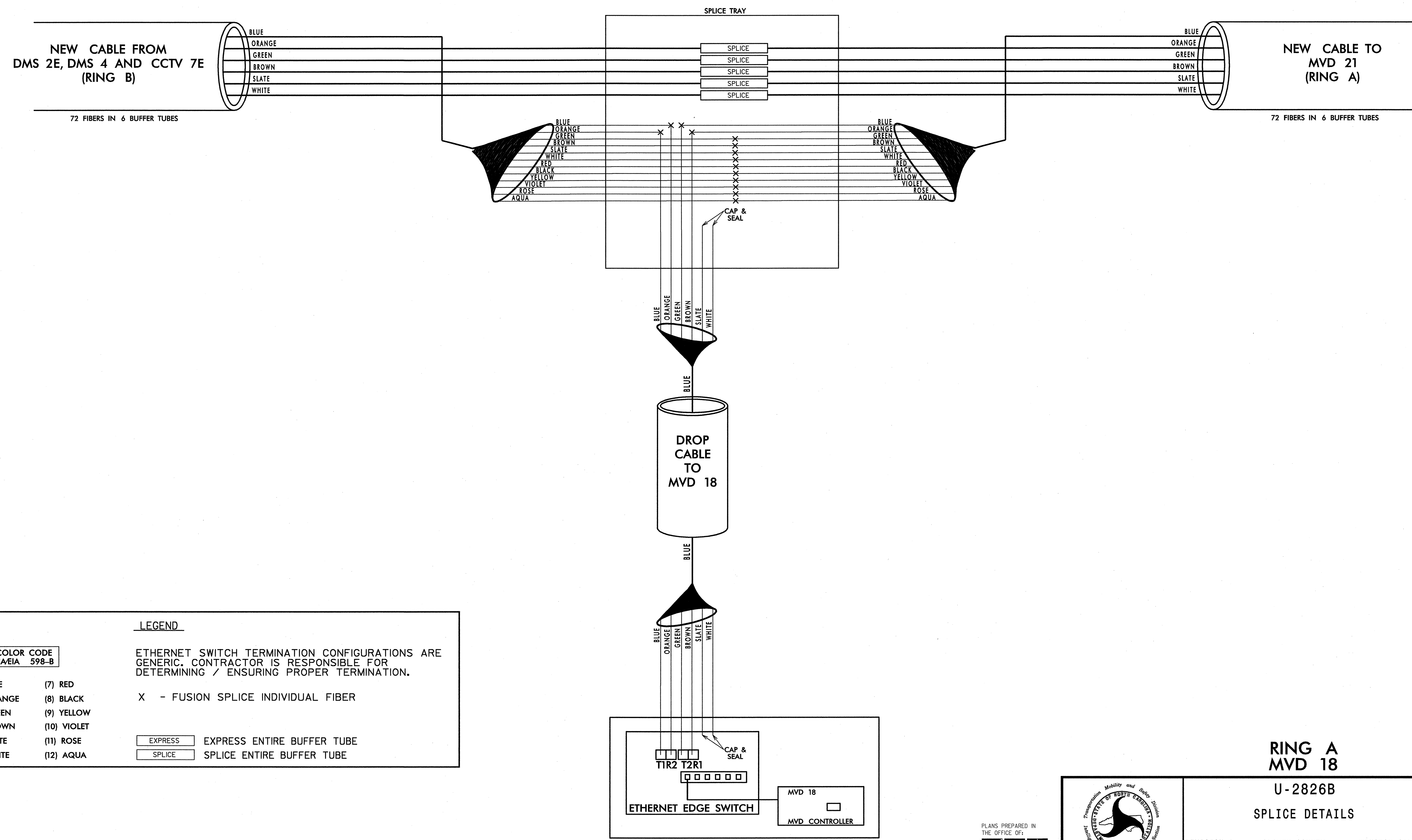

LEGEND

| | | |
|------------------------------------|-------------|--|
| COLOR CODE TIA/EIA 598-B | | ETHERNET SWITCH TERMINATION CONFIGURATIONS ARE GENERIC. CONTRACTOR IS RESPONSIBLE FOR DETERMINING / ENSURING PROPER TERMINATION. |
| (1) BLUE | (7) RED | X - FUSION SPLICE INDIVIDUAL FIBER |
| (2) ORANGE | (8) BLACK | |
| (3) GREEN | (9) YELLOW | |
| (4) BROWN | (10) VIOLET | |
| (5) SLATE | (11) ROSE | EXPRESS ENTIRE BUFFER TUBE |
| (6) WHITE | (12) AQUA | SPLICE ENTIRE BUFFER TUBE |

NOTES:
1. FIBER INTERCONNECT CENTER RACKS ARE SCHEMATIC ONLY - ACTUAL EQUIPMENT FORM MAY VARY.

**RING A
MVD 18**

**U-2826B
SPLICE DETAILS**

PLANS PREPARED IN THE OFFICE OF:

Kimley-Horn and Associates, Inc.
P.O. Box 33068
Raleigh, N.C. 27636-3068
(919) 677-2000
N.C. License # F-0102

| | | |
|-----------------------|---|--|
| | DIVISION 9 FORSYTH COUNTY WINSTON SALEM | |
| | PLAN DATE: JANUARY 2011 | REVIEWED BY: S. Phillips |
| PREPARED BY: J. Cross | REVIEWED BY: S. Privette | SCALE: NONE |
| SIGNATURE: | DATE: 1/25/11 | SEAL: 24432 NORTH CAROLINA PROFESSIONAL ENGINEER STEPHANIE B. PRIVETTE |

1/25/2011 11:48:19 AM jerry.cross k:\real\proj\115\01086158-us_52_115 (u-2826B)\plan\splice.dwg SPL-46.dgn

**SPLICE ENCLOSURE AT MVD 21
UNIVERSITY PARKWAY
SOUTH OF PATTERSON AVENUE**

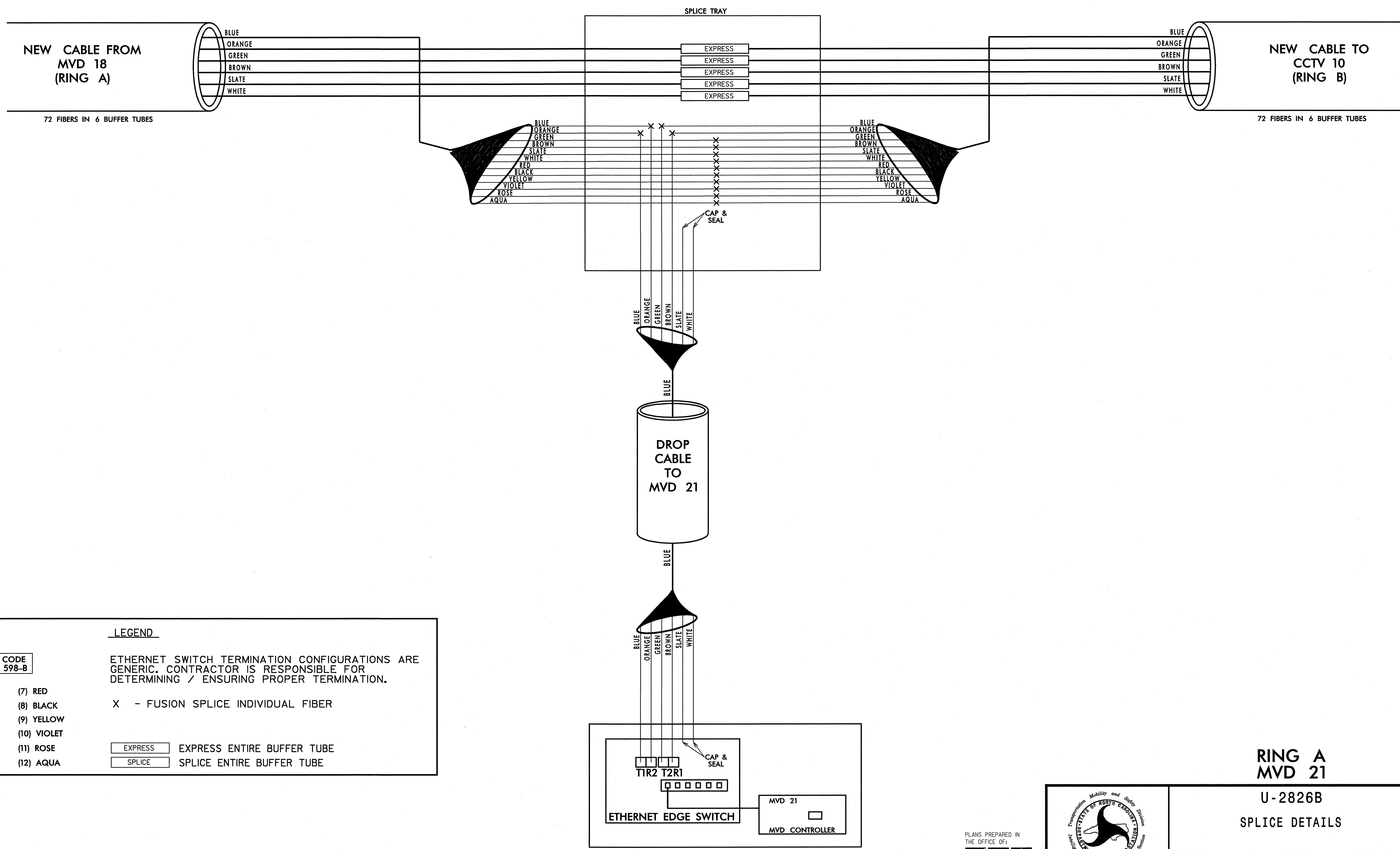

LEGEND

| | | |
|------------------------------------|-------------|--|
| COLOR CODE TIA/EIA 598-B | | ETHERNET SWITCH TERMINATION CONFIGURATIONS ARE GENERIC. CONTRACTOR IS RESPONSIBLE FOR DETERMINING / ENSURING PROPER TERMINATION. |
| (1) BLUE | (7) RED | X - FUSION SPLICE INDIVIDUAL FIBER |
| (2) ORANGE | (8) BLACK | |
| (3) GREEN | (9) YELLOW | |
| (4) BROWN | (10) VIOLET | |
| (5) SLATE | (11) ROSE | EXPRESS ENTIRE BUFFER TUBE |
| (6) WHITE | (12) AQUA | SPLICE ENTIRE BUFFER TUBE |

NOTES:
1. FIBER INTERCONNECT CENTER RACKS ARE SCHEMATIC ONLY - ACTUAL EQUIPMENT FORM MAY VARY.

**RING A
MVD 21**

U-2826B

SPLICE DETAILS

PLANS PREPARED IN THE OFFICE OF:

Kimley-Horn and Associates, Inc.
P.O. Box 33068
Raleigh N.C. 27636-3068
(919) 677-2000
N.C. License # F-0102

| | |
|---|--------------------------|
| DIVISION 9 FORSYTH COUNTY WINSTON SALEM | |
| PLAN DATE: JANUARY 2011 | REVIEWED BY: S. Phillips |
| PREPARED BY: J. Cross | REVIEWED BY: S. Privette |
| REVISIONS | INIT. DATE |
| | |
| | |
| | |

SEAL

SIGNATURE: *Stephanie B. Privette* 1-25-11
DATE: 1-25-11
CADD Filename: _____

SCALE
0
NONE

1/25/2011 11:46:20 AM jerry.cross k:\real_tproj_118\011056188.dwg 52.11s (U-2826B)\plan\Splicing\SP47.dgn

**SPLICE ENCLOSURE AT CCTV 10
UNIVERSITY PARKWAY
SOUTH OF PATTERSON AVENUE**

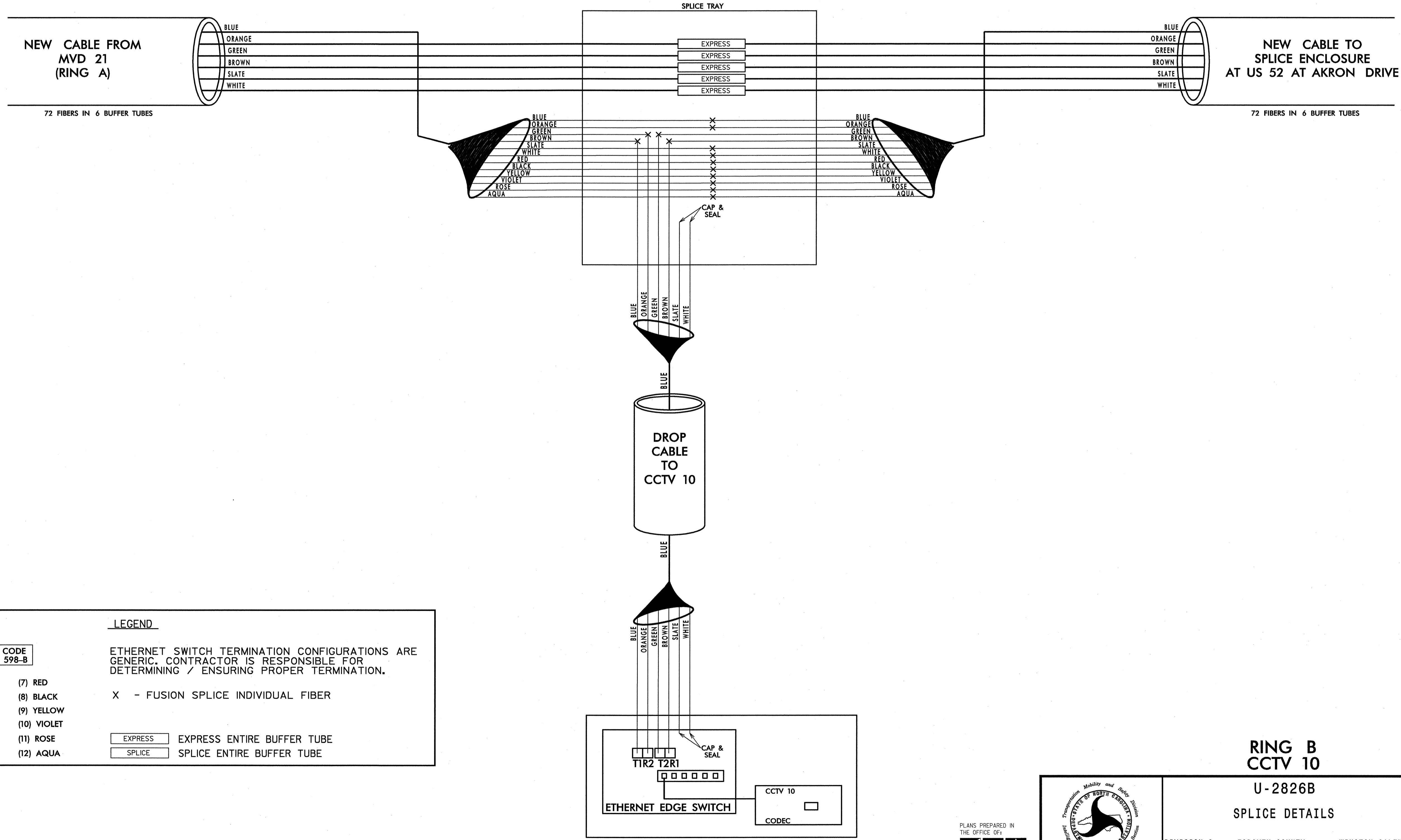

LEGEND

COLOR CODE
TIA/EIA 598-B

| | | |
|------------|-------------|--|
| (1) BLUE | (7) RED | ETHERNET SWITCH TERMINATION CONFIGURATIONS ARE GENERIC. CONTRACTOR IS RESPONSIBLE FOR DETERMINING / ENSURING PROPER TERMINATION. |
| (2) ORANGE | (8) BLACK | |
| (3) GREEN | (9) YELLOW | |
| (4) BROWN | (10) VIOLET | |
| (5) SLATE | (11) ROSE | |
| (6) WHITE | (12) AQUA | |

X - FUSION SPLICE INDIVIDUAL FIBER

| | |
|--|----------------------------|
| | EXPRESS ENTIRE BUFFER TUBE |
| | SPLICE ENTIRE BUFFER TUBE |

NOTES:
1. FIBER INTERCONNECT CENTER RACKS ARE SCHEMATIC ONLY - ACTUAL EQUIPMENT FORM MAY VARY.

**RING B
CCTV 10**

**U-2826B
SPLICE DETAILS**

| | | |
|--------------------|---|--------------------------|
| | DIVISION 9 FORSYTH COUNTY WINSTON SALEM | |
| | PLAN DATE: JANUARY 2011 | REVIEWED BY: S. Phillips |
| | PREPARED BY: J. Cross | REVIEWED BY: S. Privette |
| | REVISIONS | INIT. DATE |
| SCALE 0 NONE | SIGNATURE | DATE 1/25/11 |

PLANS PREPARED IN THE OFFICE OF:
Kimley-Horn and Associates, Inc.
P.O. Box 33068
Raleigh N.C. 27636-3068
(919) 677-2000
N.C. License # F-0102

k:\na1_tproj_115_011056158-us 52_115 (U-2826B)\plan\SP115.dwg SPL-48.dgn
 11:48:27 AM JERRY CROSS
 1/25/2011

SPLICE ENCLOSURE AT US 52 AT AKRON DRIVE

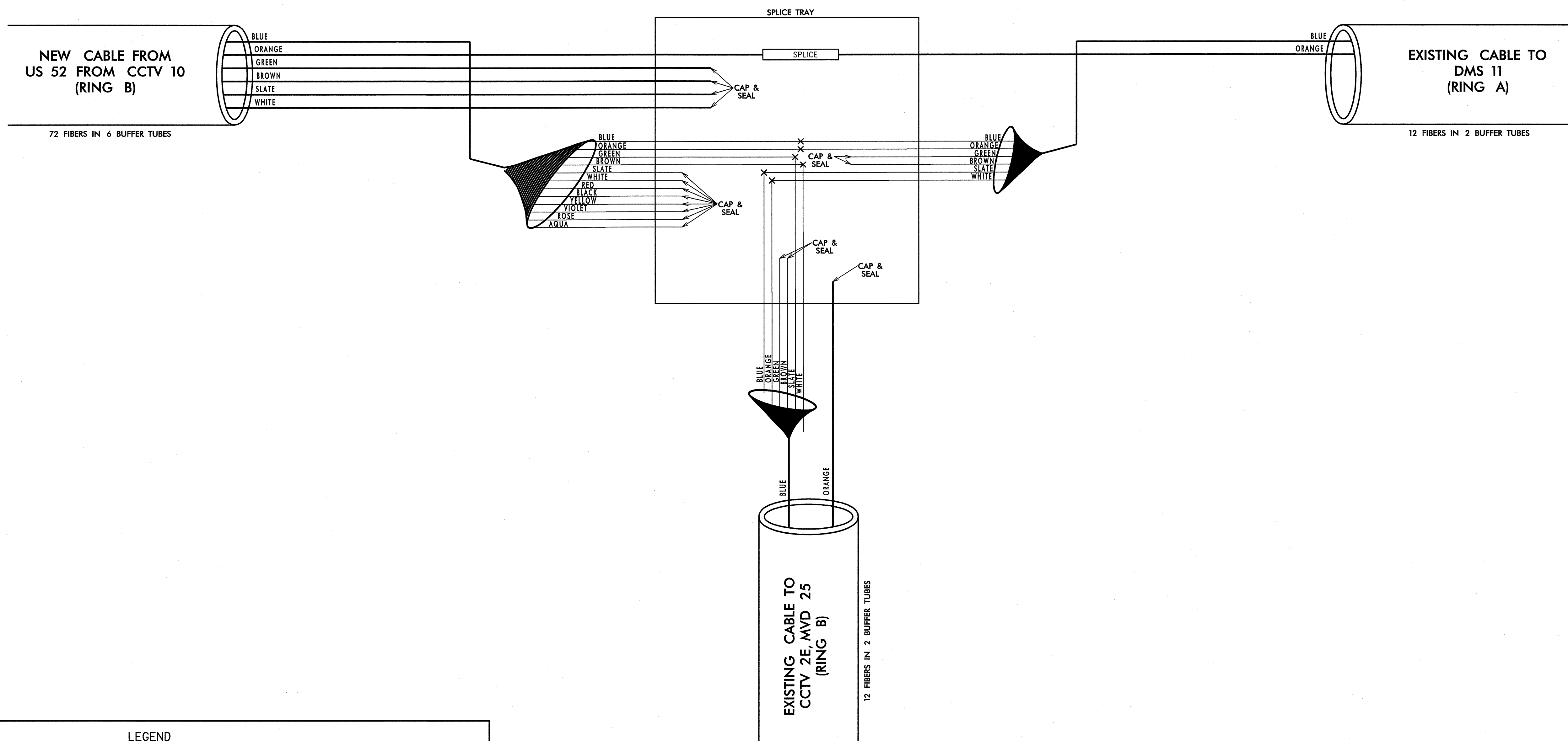

| | | | | | | | | | | | | | | | | | |
|---|----------------------------|------------|--|---------------|--|----------|---------|------------|-----------|-----------|------------|-----------|-------------|-----------|-----------|-----------|-----------|
| LEGEND | | | | | | | | | | | | | | | | | |
| <table border="1"> <tr> <td colspan="2">COLOR CODE</td> </tr> <tr> <td colspan="2">TIA/EIA 598-B</td> </tr> <tr> <td>(1) BLUE</td> <td>(7) RED</td> </tr> <tr> <td>(2) ORANGE</td> <td>(8) BLACK</td> </tr> <tr> <td>(3) GREEN</td> <td>(9) YELLOW</td> </tr> <tr> <td>(4) BROWN</td> <td>(10) VIOLET</td> </tr> <tr> <td>(5) SLATE</td> <td>(11) ROSE</td> </tr> <tr> <td>(6) WHITE</td> <td>(12) AQUA</td> </tr> </table> | | COLOR CODE | | TIA/EIA 598-B | | (1) BLUE | (7) RED | (2) ORANGE | (8) BLACK | (3) GREEN | (9) YELLOW | (4) BROWN | (10) VIOLET | (5) SLATE | (11) ROSE | (6) WHITE | (12) AQUA |
| COLOR CODE | | | | | | | | | | | | | | | | | |
| TIA/EIA 598-B | | | | | | | | | | | | | | | | | |
| (1) BLUE | (7) RED | | | | | | | | | | | | | | | | |
| (2) ORANGE | (8) BLACK | | | | | | | | | | | | | | | | |
| (3) GREEN | (9) YELLOW | | | | | | | | | | | | | | | | |
| (4) BROWN | (10) VIOLET | | | | | | | | | | | | | | | | |
| (5) SLATE | (11) ROSE | | | | | | | | | | | | | | | | |
| (6) WHITE | (12) AQUA | | | | | | | | | | | | | | | | |
| <p>ETHERNET SWITCH TERMINATION CONFIGURATIONS ARE GENERIC. CONTRACTOR IS RESPONSIBLE FOR DETERMINING / ENSURING PROPER TERMINATION.</p> <p>X - FUSION SPLICE INDIVIDUAL FIBER</p> | | | | | | | | | | | | | | | | | |
| EXPRESS | EXPRESS ENTIRE BUFFER TUBE | | | | | | | | | | | | | | | | |
| SPLICE | SPLICE ENTIRE BUFFER TUBE | | | | | | | | | | | | | | | | |

NOTES:
 1. FIBER INTERCONNECT CENTER RACKS ARE SCHEMATIC ONLY - ACTUAL EQUIPMENT FORM MAY VARY.

RING A, RING B

PLANS PREPARED IN THE OFFICE OF:

Kimley-Horn and Associates, Inc.
 P.O. Box 33068
 Raleigh, N.C. 27636-3068
 (919) 677-2000
 N.C. License # F-0102

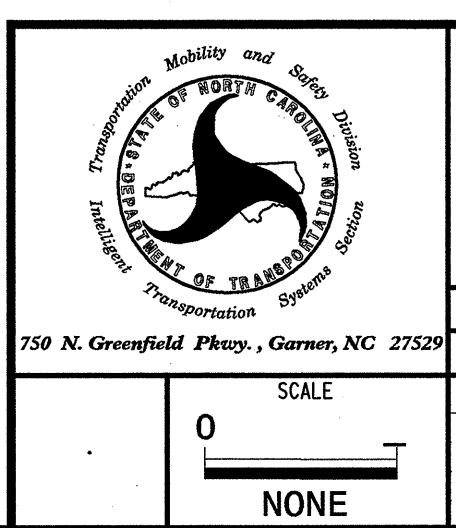

| | |
|---|--------------------------|
| U-2826B | |
| SPLICE DETAILS | |
| DIVISION 9 FORSYTH COUNTY WINSTON SALEM | |
| PLAN DATE: JANUARY 2011 | REVIEWED BY: S. Phillips |
| PREPARED BY: J. Cross | REVIEWED BY: S. Privette |
| REVISIONS | INIT. DATE |
| | |

SEAL

1-25-11
DATE

CADD File name

k:\na1_tproj_118\01060688-us_52_118 (U-2826B)\plan\Splicing\SP-49.dgn
 11:48:22 AM Jerry Cross
 1/25/2011

**SPLICE ENCLOSURE AT
CCTV 2E, MVD 25
US 52 SOUTH OF AKRON DRIVE**

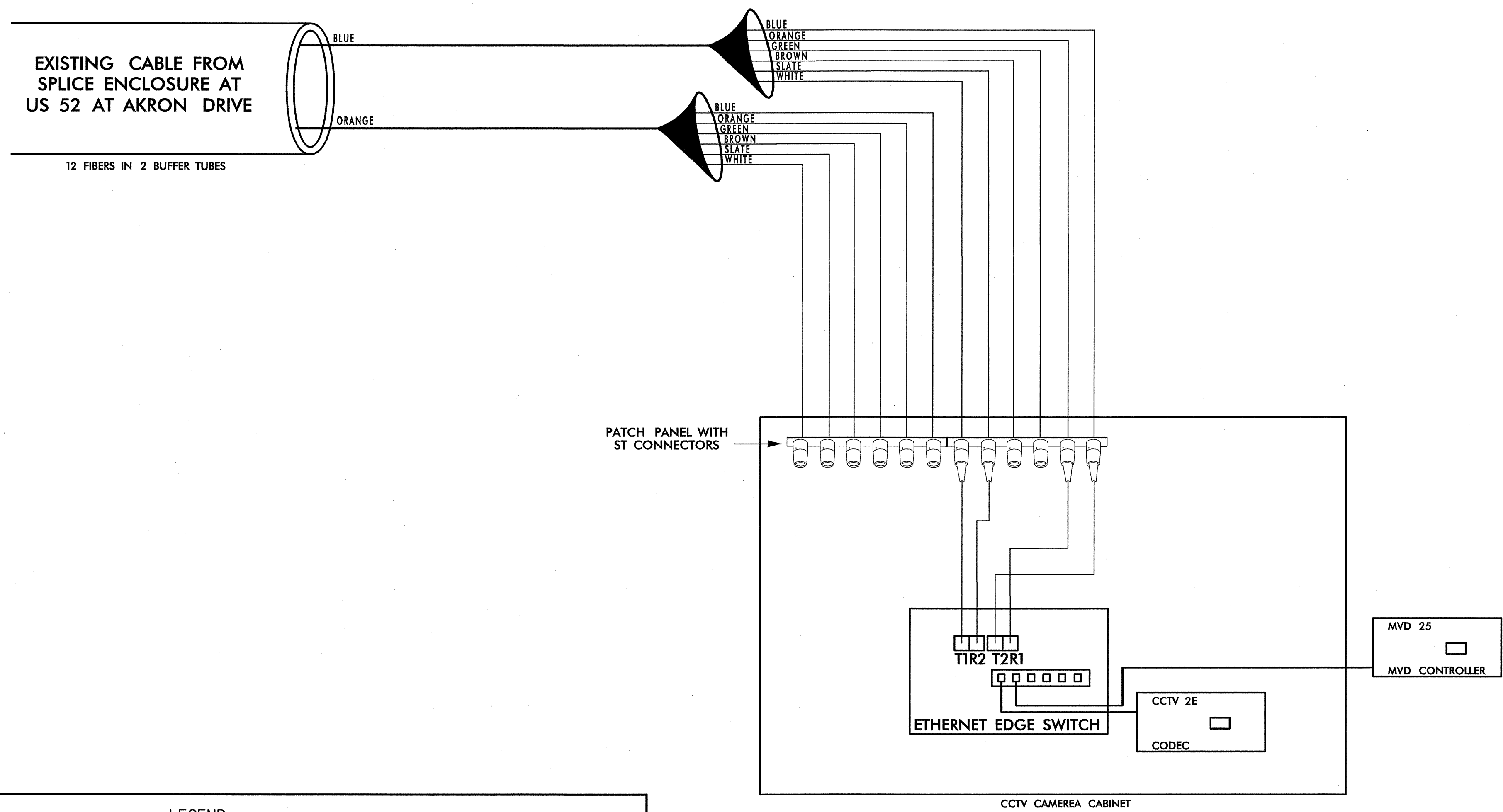

| COLOR CODE TIA/EIA 598-B | | LEGEND | |
|-----------------------------|-------------|--|----------------------------------|
| (1) BLUE | (7) RED | ETHERNET SWITCH TERMINATION CONFIGURATIONS ARE GENERIC. CONTRACTOR IS RESPONSIBLE FOR DETERMINING / ENSURING PROPER TERMINATION. | |
| (2) ORANGE | (8) BLACK | X | - FUSION SPLICE INDIVIDUAL FIBER |
| (3) GREEN | (9) YELLOW | EXPRESS | EXPRESS ENTIRE BUFFER TUBE |
| (4) BROWN | (10) VIOLET | SPLICE | SPLICE ENTIRE BUFFER TUBE |
| (5) SLATE | (11) ROSE | | |
| (6) WHITE | (12) AQUA | | |

NOTES:
1. FIBER INTERCONNECT CENTER RACKS ARE SCHEMATIC ONLY - ACTUAL EQUIPMENT FORM MAY VARY.

**RING B
CCTV 2E, MVD 25**

U-2826B
SPLICE DETAILS

PLANS PREPARED IN THE OFFICE OF:
Kimley-Horn and Associates, Inc.
P.O. Box 33068
Raleigh, N.C. 27636-3068
(919) 677-2000
N.C. License # F-0102

| | |
|---|--------------------------|
| DIVISION 9 FORSYTH COUNTY WINSTON SALEM | |
| PLAN DATE: JANUARY 2011 | REVIEWED BY: S. Phillips |
| PREPARED BY: J. Cross | REVIEWED BY: S. Privette |
| SCALE: NONE | REVISIONS |
| INIT. | DATE |

SEAL

1-25-11

DATE

CADD Filenames

k:\nral_tproj_1ts\0108658-us_52_1ts (U-2826B)\plan\Splicing\SPL50.dgn 11:46:23 AM jerry.cross 1/25/2011

**SPLICE ENCLOSURE AT DMS 11
PATTERSON AVENUE NEAR
AKRON DRIVE**

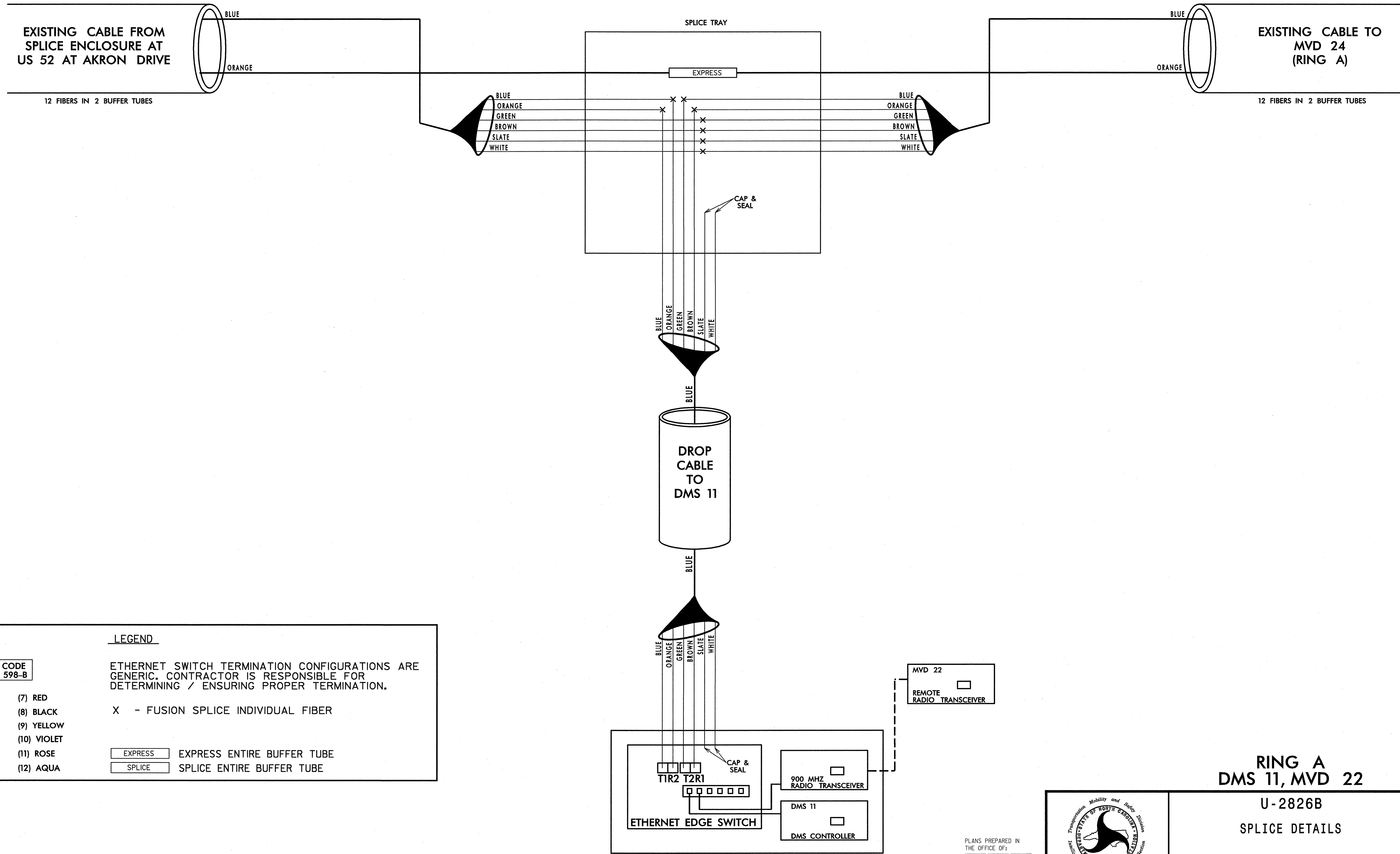

LEGEND

ETHERNET SWITCH TERMINATION CONFIGURATIONS ARE GENERIC. CONTRACTOR IS RESPONSIBLE FOR DETERMINING / ENSURING PROPER TERMINATION.

X - FUSION SPLICE INDIVIDUAL FIBER

| | |
|---------|----------------------------|
| EXPRESS | EXPRESS ENTIRE BUFFER TUBE |
| SPLICE | SPLICE ENTIRE BUFFER TUBE |

COLOR CODE TIA/EIA 598-B

| | |
|------------|-------------|
| (1) BLUE | (7) RED |
| (2) ORANGE | (8) BLACK |
| (3) GREEN | (9) YELLOW |
| (4) BROWN | (10) VIOLET |
| (5) SLATE | (11) ROSE |
| (6) WHITE | (12) AQUA |

NOTES:
1. FIBER INTERCONNECT CENTER RACKS ARE SCHEMATIC ONLY - ACTUAL EQUIPMENT FORM MAY VARY.

**RING A
DMS 11, MVD 22**

**U-2826B
SPLICE DETAILS**

PLANS PREPARED IN THE OFFICE OF:
Kimley-Horn and Associates, Inc.
P.O. Box 33068
Raleigh, N.C. 27636-3068
(919) 677-2000
N.C. License # F-0102

750 N. Greenfield Pkwy., Garner, NC 27529

| | |
|---|--------------------------|
| DIVISION 9 FORSYTH COUNTY WINSTON SALEM | |
| PLAN DATE: JANUARY 2011 | REVIEWED BY: S. Phillips |
| PREPARED BY: J. Cross | REVIEWED BY: S. Privette |
| SCALE | REVISIONS |
| 0 | |
| NONE | |

SEAL

1-26-11
DATE

CADD Filename

1/25/2011 11:46:24 AM jerry.cross k:\na1\proj_135\01\038\598-us_52_1fs (U-2826B)\na1\splicing\SP51.dgn

**SPLICE ENCLOSURE AT MVD 24
PATTERSON AVENUE SOUTH OF
AKRON DRIVE**

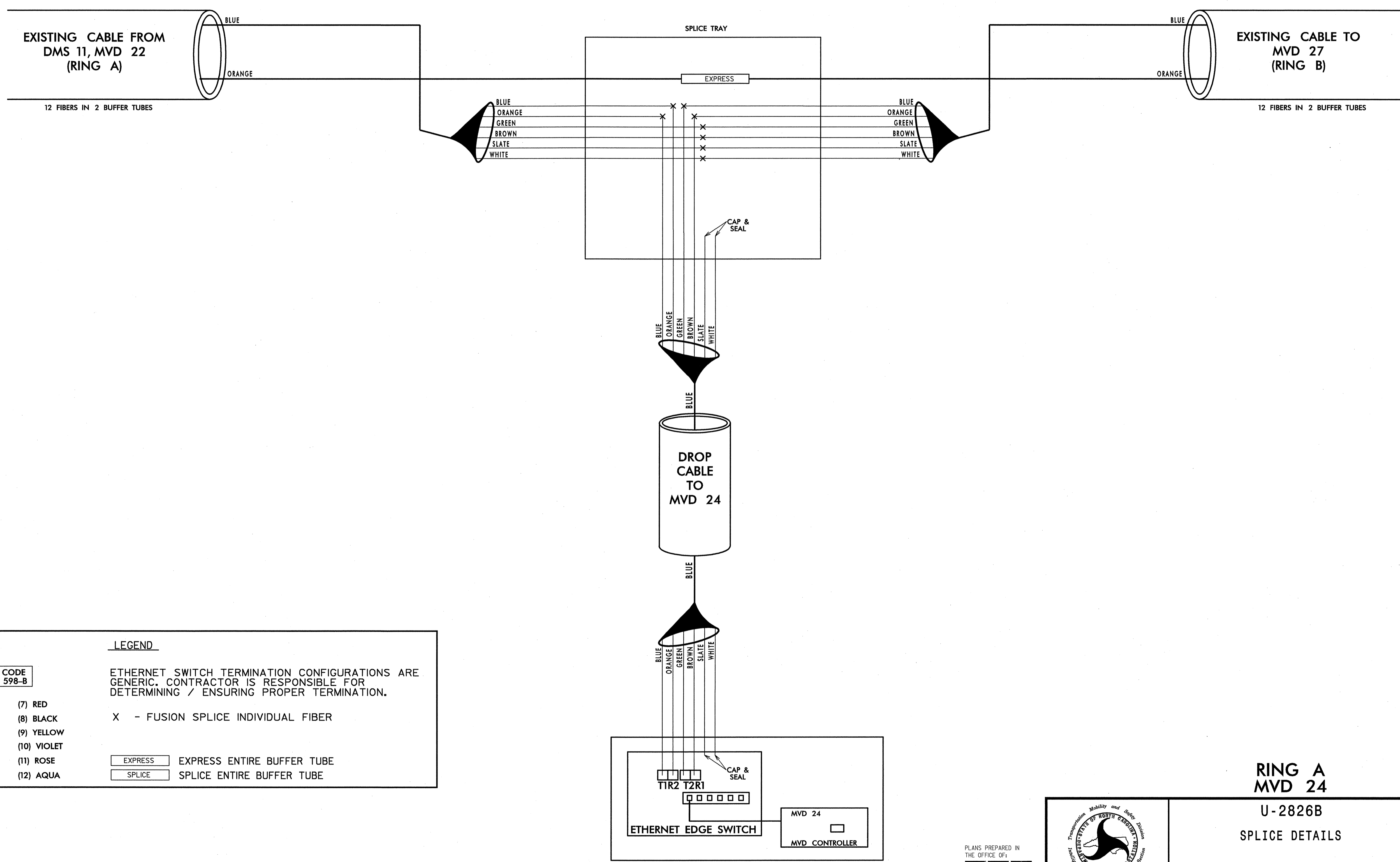

LEGEND

| | | |
|------------------------------------|-------------|--|
| COLOR CODE TIA/EIA 598-B | | ETHERNET SWITCH TERMINATION CONFIGURATIONS ARE GENERIC. CONTRACTOR IS RESPONSIBLE FOR DETERMINING / ENSURING PROPER TERMINATION. |
| (1) BLUE | (7) RED | X - FUSION SPLICE INDIVIDUAL FIBER |
| (2) ORANGE | (8) BLACK | |
| (3) GREEN | (9) YELLOW | |
| (4) BROWN | (10) VIOLET | |
| (5) SLATE | (11) ROSE | EXPRESS ENTIRE BUFFER TUBE |
| (6) WHITE | (12) AQUA | SPLICE ENTIRE BUFFER TUBE |

NOTES:
1. FIBER INTERCONNECT CENTER RACKS ARE SCHEMATIC ONLY - ACTUAL EQUIPMENT FORM MAY VARY.

**RING A
MVD 24**

**U-2826B
SPLICE DETAILS**

PLANS PREPARED IN THE OFFICE OF:

Kimley-Horn and Associates, Inc.
P.O. Box 33068
Raleigh N.C. 27636-3068
(919) 677-2000
N.C. License # F-0102

| | |
|---|--------------------------|
| DIVISION 9 FORSYTH COUNTY WINSTON SALEM | |
| PLAN DATE: JANUARY 2011 | REVIEWED BY: S. Phillips |
| PREPARED BY: J. Cross | REVIEWED BY: S. Privette |
| SCALE | INIT. DATE |
| 0 | |
| NONE | |

SEAL

Stephanie B. Privette
SIGNATURE DATE 1-25-11
CADD Filenames

1/25/2011 11:48:25 AM jerry.cross k:\nal_tproj_11a\0108158-us_52_11a (u-2826B)\plan\splice\splice.dgn

**SPLICE ENCLOSURE AT MVD 27
PATTERSON AVENUE SOUTH OF
AKRON DRIVE**

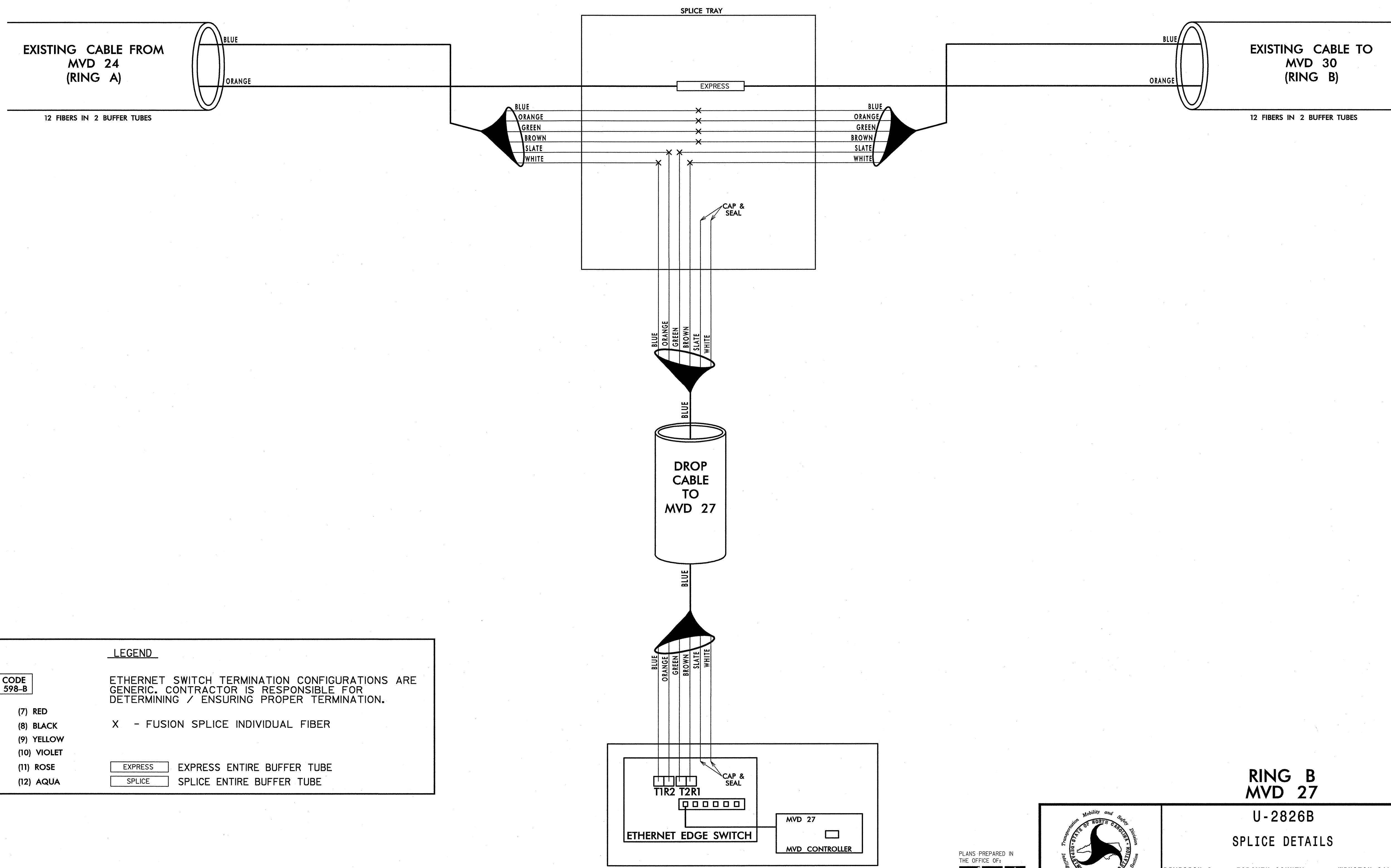

LEGEND

| | | |
|------------------------------------|-------------|--|
| COLOR CODE TIA/EIA 598-B | | ETHERNET SWITCH TERMINATION CONFIGURATIONS ARE GENERIC. CONTRACTOR IS RESPONSIBLE FOR DETERMINING / ENSURING PROPER TERMINATION. |
| (1) BLUE | (7) RED | X - FUSION SPLICE INDIVIDUAL FIBER |
| (2) ORANGE | (8) BLACK | |
| (3) GREEN | (9) YELLOW | |
| (4) BROWN | (10) VIOLET | |
| (5) SLATE | (11) ROSE | EXPRESS ENTIRE BUFFER TUBE |
| (6) WHITE | (12) AQUA | SPLICE ENTIRE BUFFER TUBE |

NOTES:
1. FIBER INTERCONNECT CENTER RACKS ARE SCHEMATIC ONLY - ACTUAL EQUIPMENT FORM MAY VARY.

**RING B
MVD 27**

U-2826B

SPLICE DETAILS

PLANS PREPARED IN THE OFFICE OF:

Kimley-Horn and Associates, Inc.
P.O. Box 33068
Raleigh N.C. 27636-3068
(919) 677-2000
N.C. License # F-0102

| | |
|---|--------------------------|
| DIVISION 9 FORSYTH COUNTY WINSTON SALEM | |
| PLAN DATE: JANUARY 2011 | REVIEWED BY: S. Phillips |
| PREPARED BY: J. Cross | REVIEWED BY: S. Privette |
| SCALE: NONE | INIT. DATE |
| REVISIONS | INIT. DATE |

SEAL

SIGNATURE: *Stephanie B. Privette* DATE: 1-25-11
CADD Filenames

1/25/2011 11:48:28 AM jerry.cross k:\real_time\11058158-us_11s (u-2826B)\plan\Splicing\SPL53.dgn

**SPLICE ENCLOSURE AT MVD 30
PATTERSON AVENUE SOUTH OF
28TH STREET**

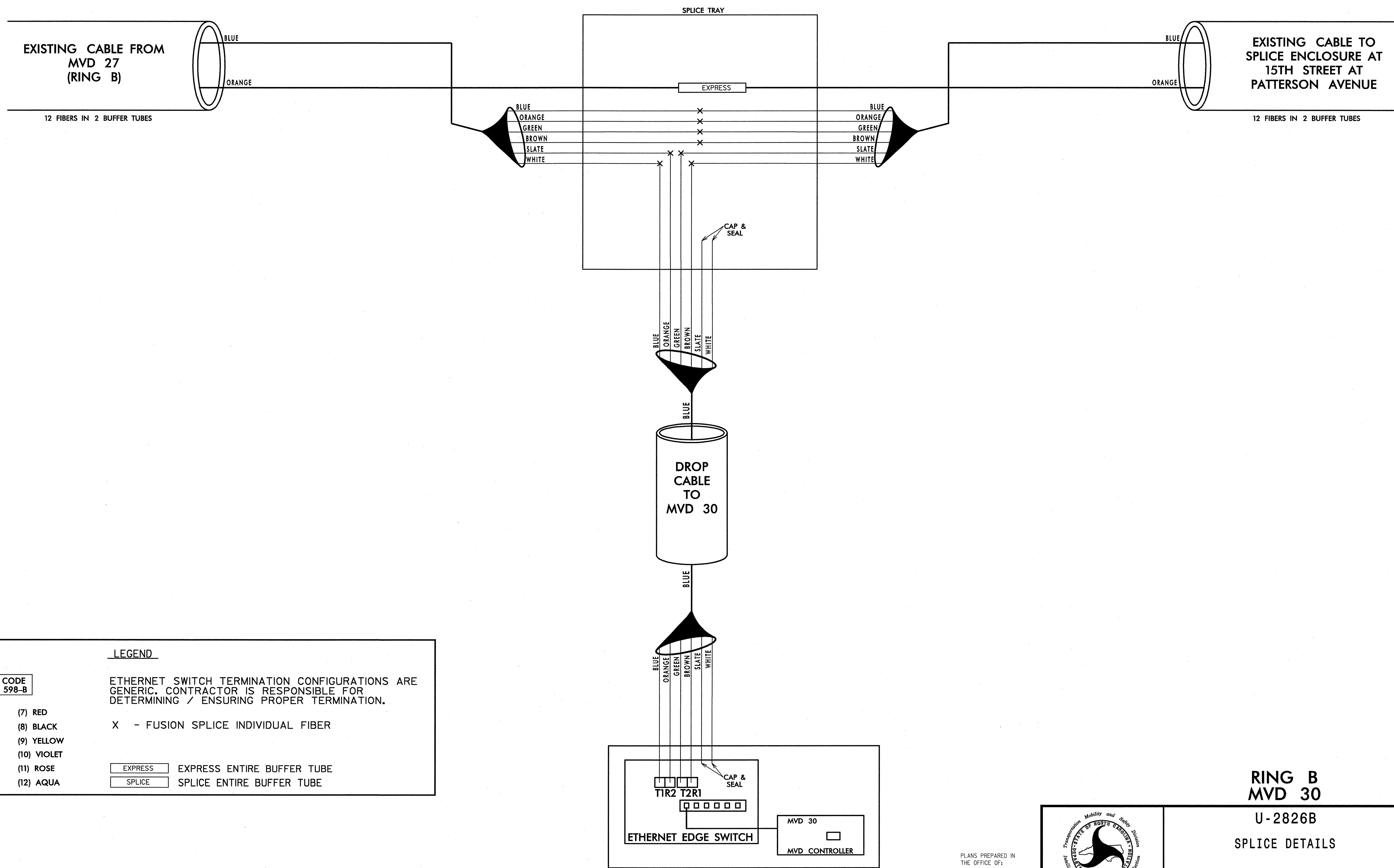

LEGEND

ETHERNET SWITCH TERMINATION CONFIGURATIONS ARE GENERIC. CONTRACTOR IS RESPONSIBLE FOR DETERMINING / ENSURING PROPER TERMINATION.

X - FUSION SPLICE INDIVIDUAL FIBER

| | |
|---------|----------------------------|
| EXPRESS | EXPRESS ENTIRE BUFFER TUBE |
| SPLICE | SPLICE ENTIRE BUFFER TUBE |

COLOR CODE TIA/EIA 598-B

| | |
|------------|-------------|
| (1) BLUE | (7) RED |
| (2) ORANGE | (8) BLACK |
| (3) GREEN | (9) YELLOW |
| (4) BROWN | (10) VIOLET |
| (5) SLATE | (11) ROSE |
| (6) WHITE | (12) AQUA |

NOTES:
1. FIBER INTERCONNECT CENTER RACKS ARE SCHEMATIC ONLY - ACTUAL EQUIPMENT FORM MAY VARY.

**RING B
MVD 30**

**U-2826B
SPLICE DETAILS**

PLANS PREPARED IN THE OFFICE OF:
Kimley-Horn and Associates, Inc.
P.O. Box 33068
Raleigh, N.C. 27636-3068
(919) 677-2000
N.C. License # F-002

750 N. Greenfield Pkwy., Garner, NC 27529

SCALE: NONE

| | |
|---|--------------------------|
| DIVISION 9 FORSYTH COUNTY WINSTON SALEM | |
| PLAN DATE: JANUARY 2011 | REVIEWED BY: S. Phillips |
| PREPARED BY: J. Cross | REVIEWED BY: S. Privette |
| REVISIONS | INIT. DATE |
| | |
| | |

SEAL

1.25.11

CADD Filename

1/25/2011 11:46:27 AM jerry.cross k:\real\proj_1\101036156.us 52_11s (U-2826B)\plan\Spllicing\SPL54.dgn

EXISTING SPLICE ENCLOSURE AT
15th STREET AT
PATTERSON AVENUE

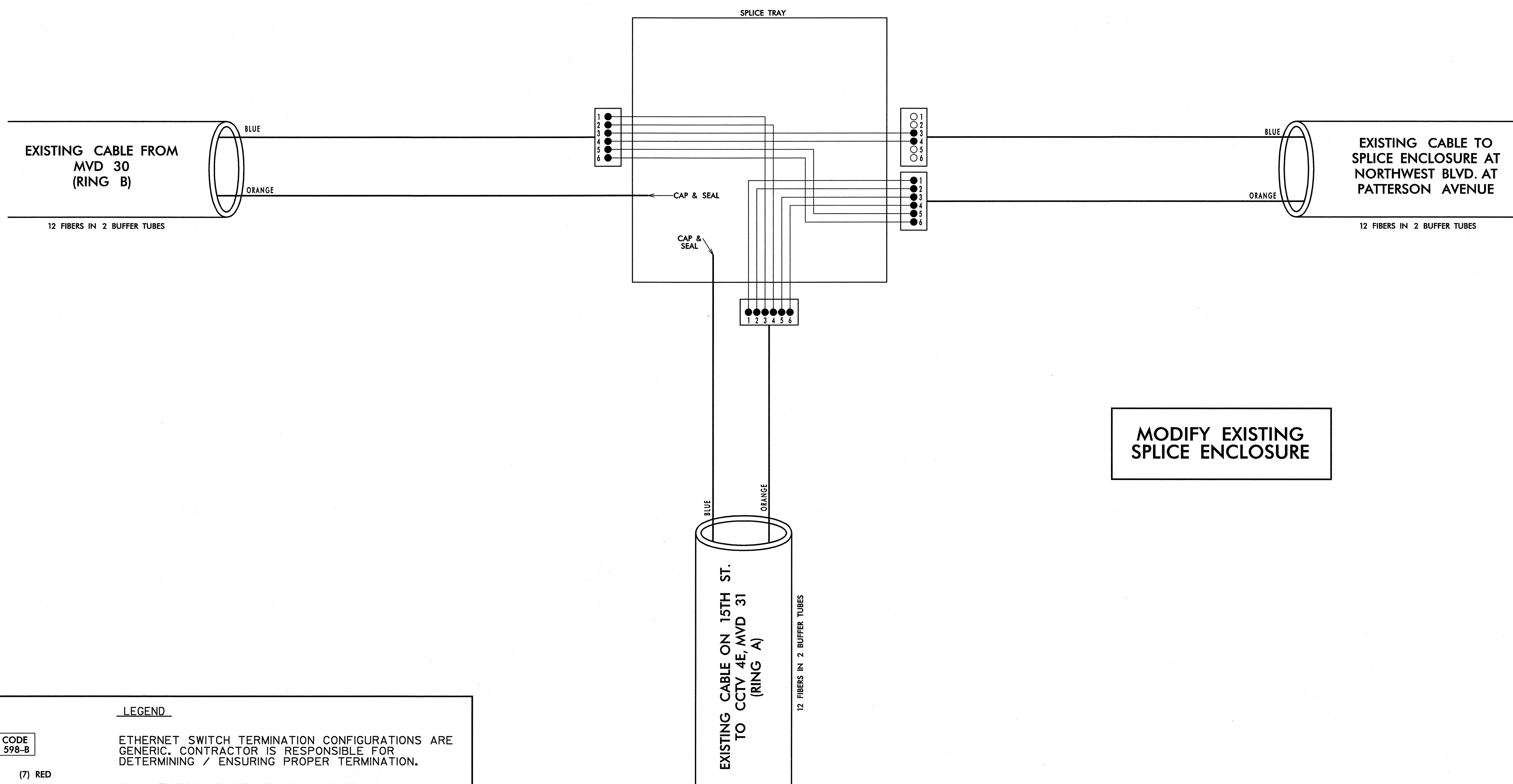

MODIFY EXISTING
SPLICE ENCLOSURE

| COLOR CODE TIA/EIA 598-B | | LEGEND | |
|-----------------------------|-------------|--|----------------------------------|
| (1) BLUE | (7) RED | ETHERNET SWITCH TERMINATION CONFIGURATIONS ARE GENERIC. CONTRACTOR IS RESPONSIBLE FOR DETERMINING / ENSURING PROPER TERMINATION. | |
| (2) ORANGE | (8) BLACK | X | - FUSION SPLICE INDIVIDUAL FIBER |
| (3) GREEN | (9) YELLOW | EXPRESS | EXPRESS ENTIRE BUFFER TUBE |
| (4) BROWN | (10) VIOLET | SPLICE | SPLICE ENTIRE BUFFER TUBE |
| (5) SLATE | (11) ROSE | | |
| (6) WHITE | (12) AQUA | | |

NOTES:
1. FIBER INTERCONNECT CENTER RACKS ARE SCHEMATIC ONLY - ACTUAL EQUIPMENT FORM MAY VARY.

RING A, RING B

PLANS PREPARED IN THE OFFICE OF:
Kimley-Horn and Associates, Inc.
P.O. Box 33068
Raleigh, N.C. 27636-3068
(919) 677-2000
N.C. License # F-0102

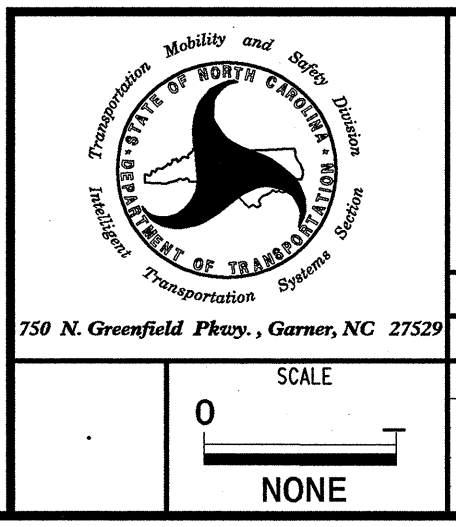

| | | | |
|-------------------------|--------------------------|--|------|
| U-2826B | | SEAL | |
| SPLICE DETAILS | | NORTH CAROLINA PROFESSIONAL SEAL 24432 | |
| DIVISION 9 | FORSYTH COUNTY | WINSTON SALEM | |
| PLAN DATE: JANUARY 2011 | REVIEWED BY: S. Phillips | | |
| PREPARED BY: J. Cross | REVIEWED BY: S. Privette | | |
| SCALE | REVISIONS | INIT. | DATE |
| 0 | | | |
| NONE | | | |

SIGNATURE: *Stephanie B. Privette* 1-26-11
DATE: _____
CAD: Flenner

1/25/2011 11:46:28 AM jerry_cross k:\real\proj_115\011038158.us_82_115 (U-2826B) (Plan) (Spline) (SPL55.dgn)

**SPLICE ENCLOSURE AT
CCTV 4E, MVD 31
US 52 NORTH OF 16TH STREET**

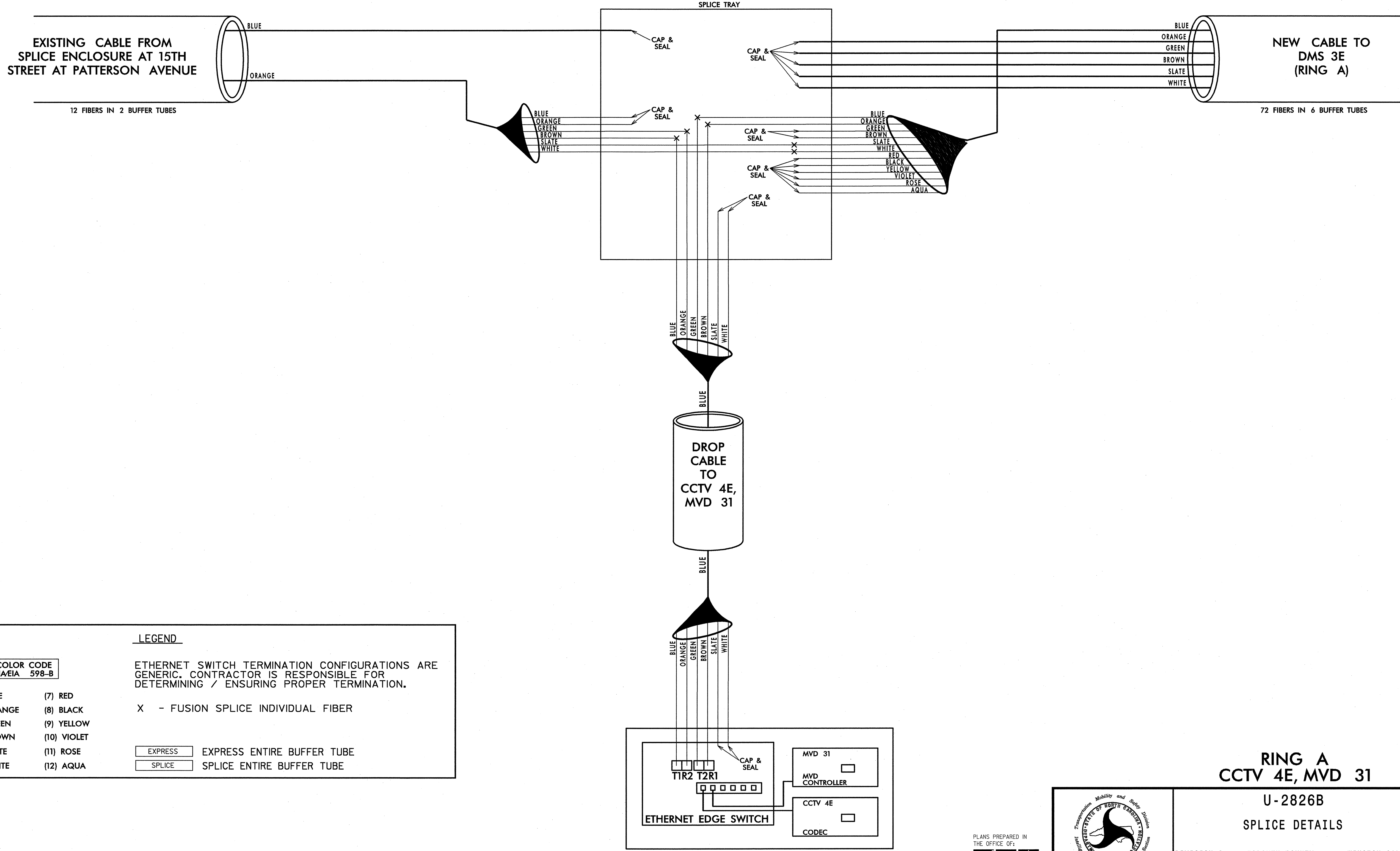

LEGEND

| | | |
|------------------------------------|-------------|--|
| COLOR CODE TIA/EIA 598-B | | ETHERNET SWITCH TERMINATION CONFIGURATIONS ARE GENERIC. CONTRACTOR IS RESPONSIBLE FOR DETERMINING / ENSURING PROPER TERMINATION. |
| (1) BLUE | (7) RED | X - FUSION SPLICE INDIVIDUAL FIBER |
| (2) ORANGE | (8) BLACK | |
| (3) GREEN | (9) YELLOW | |
| (4) BROWN | (10) VIOLET | |
| (5) SLATE | (11) ROSE | EXPRESS ENTIRE BUFFER TUBE |
| (6) WHITE | (12) AQUA | SPLICE ENTIRE BUFFER TUBE |

NOTES:
1. FIBER INTERCONNECT CENTER RACKS ARE SCHEMATIC ONLY - ACTUAL EQUIPMENT FORM MAY VARY.

**RING A
CCTV 4E, MVD 31**

**U-2826B
SPLICE DETAILS**

PLANS PREPARED IN THE OFFICE OF:

Kimley-Horn and Associates, Inc.
P.O. Box 33068
Raleigh N.C. 27636-3068
(919) 677-2000
N.C. License # F-002

750 N. Greenfield Pkwy., Garner, NC 27529

| | |
|---|--------------------------|
| DIVISION 9 FORSYTH COUNTY WINSTON SALEM | |
| PLAN DATE: JANUARY 2011 | REVIEWED BY: S. Phillips |
| PREPARED BY: J. Cross | REVIEWED BY: S. Privette |
| REVISIONS | INIT. DATE |
| | |
| | |

SEAL

SIGNATURE: *Stephanie B. Privette* DATE: 1/25/11
CADD Filename:

1/25/2011 11:48:30 AM jerry.cross k:\real_tproj_11s\0106168-us_02_11s (U-2826B)\plan\Spllicing\SPL56.dgn

**SPLICE ENCLOSURE AT
DMS 3E
US 52 NORTH OF LIBERTY STREET**

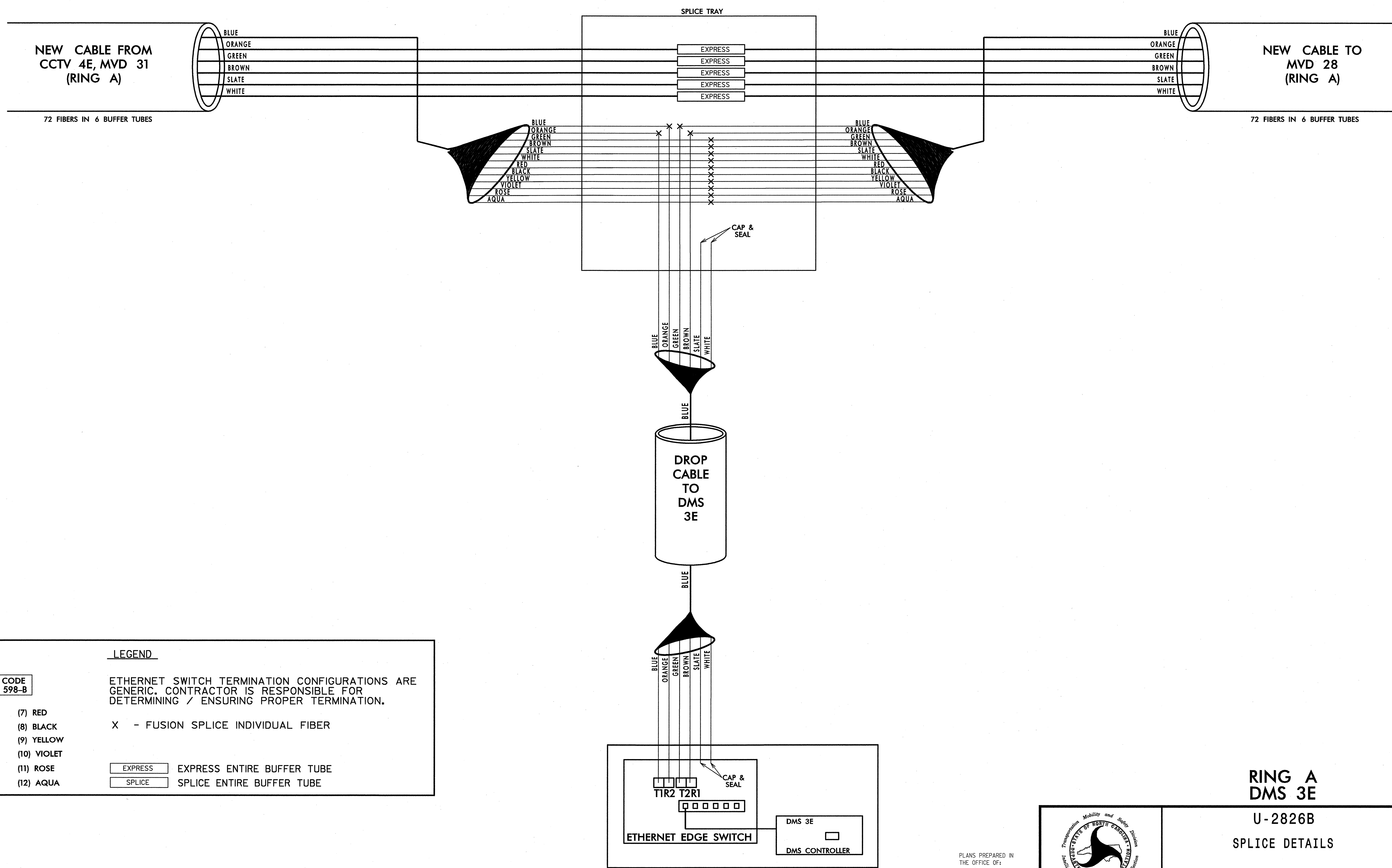

LEGEND

COLOR CODE TIA/EIA 598-B

| | |
|------------|-------------|
| (1) BLUE | (7) RED |
| (2) ORANGE | (8) BLACK |
| (3) GREEN | (9) YELLOW |
| (4) BROWN | (10) VIOLET |
| (5) SLATE | (11) ROSE |
| (6) WHITE | (12) AQUA |

ETHERNET SWITCH TERMINATION CONFIGURATIONS ARE GENERIC. CONTRACTOR IS RESPONSIBLE FOR DETERMINING / ENSURING PROPER TERMINATION.

X - FUSION SPLICE INDIVIDUAL FIBER

EXPRESS - EXPRESS ENTIRE BUFFER TUBE

SPLICE - SPLICE ENTIRE BUFFER TUBE

NOTES:
1. FIBER INTERCONNECT CENTER RACKS ARE SCHEMATIC ONLY - ACTUAL EQUIPMENT FORM MAY VARY.

**RING A
DMS 3E**

**U-2826B
SPLICE DETAILS**

| | |
|---|--------------------------|
| DIVISION 9 FORSYTH COUNTY WINSTON SALEM | |
| PLAN DATE: JANUARY 2011 | REVIEWED BY: S. Phillips |
| PREPARED BY: J. Cross | REVIEWED BY: S. Privette |
| SCALE | REVISIONS |
| 0 | INIT. DATE |
| NONE | |

SEAL
NORTH CAROLINA PROFESSIONAL ENGINEER
SEAL 24432
STEPHANIE B. PRIVETTE

1-25-11
DATE

CADD Filename:

PLANS PREPARED IN THE OFFICE OF:
Kimley-Horn and Associates, Inc.
P.O. Box 33068
Raleigh, N.C. 27636-3068
(919) 677-2000
N.C. License # F-0102

1/25/2011 11:46:31 AM jerry.cross k:\real\proj_1\1038158.us_52_11s (U-2826B)\plan\Splicing\SP57.dgn

**SPLICE ENCLOSURE AT MVD 28
US 52 NORTH OF LIBERTY STREET**

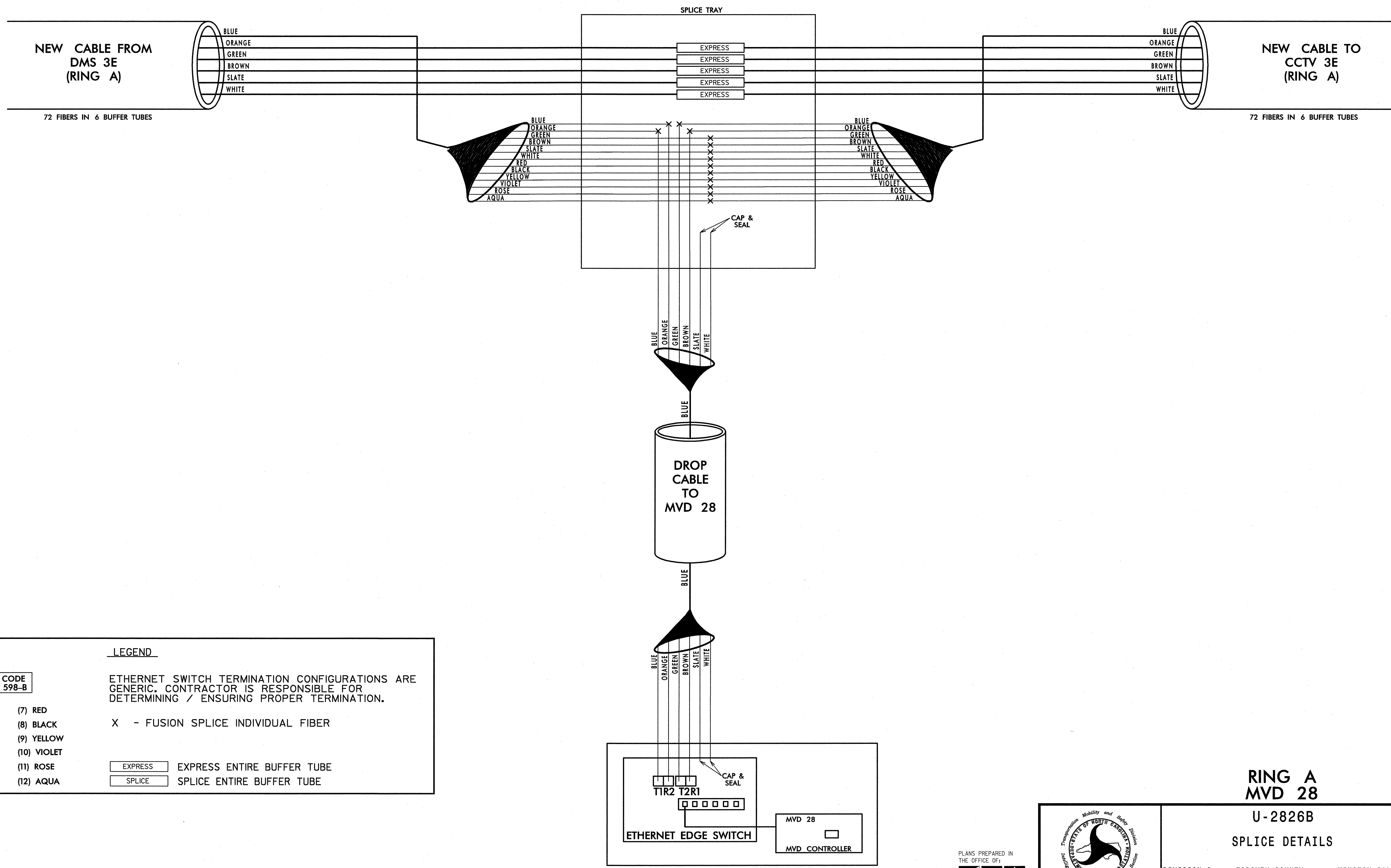

LEGEND

COLOR CODE
TIA/EIA 598-B

| | | |
|------------|-------------|--|
| (1) BLUE | (7) RED | ETHERNET SWITCH TERMINATION CONFIGURATIONS ARE GENERIC. CONTRACTOR IS RESPONSIBLE FOR DETERMINING / ENSURING PROPER TERMINATION. |
| (2) ORANGE | (8) BLACK | |
| (3) GREEN | (9) YELLOW | |
| (4) BROWN | (10) VIOLET | |
| (5) SLATE | (11) ROSE | |
| (6) WHITE | (12) AQUA | |

X - FUSION SPLICE INDIVIDUAL FIBER

EXPRESS - EXPRESS ENTIRE BUFFER TUBE

SPLICE - SPLICE ENTIRE BUFFER TUBE

NOTES:
1. FIBER INTERCONNECT CENTER RACKS ARE SCHEMATIC ONLY - ACTUAL EQUIPMENT FORM MAY VARY.

**RING A
MVD 28**

**U-2826B
SPLICE DETAILS**

PLANS PREPARED IN THE OFFICE OF:
Kimley-Horn and Associates, Inc.
P.O. Box 33068
Raleigh N.C. 27636-3068
(919) 677-2000
N.C. License # F-0102

750 N. Greenfield Place, Garner, NC 27529

| | |
|---|--------------------------|
| DIVISION 9 FORSYTH COUNTY WINSTON SALEM | |
| PLAN DATE: JANUARY 2011 | REVIEWED BY: S. Phillips |
| PREPARED BY: J. Cross | REVIEWED BY: S. Privette |
| REVISIONS | INIT. DATE |
| | |
| | |

SEAL

STEPHANIE B. PRIVETTE
ENGINEER
24432

DATE: 1/25/11
SIGNATURE: [Signature]
CADD Filename: [Blank]

k:\cal_tproj_1\1086158-us 52_11s (u-2826B)\plan\splice.dwg SPL-58.dwg 1/25/2011 11:48:32 AM jerry.cross

**SPLICE ENCLOSURE AT
MVD 26, CCTV 11
US 52 SOUTH OF LIBERTY STREET**

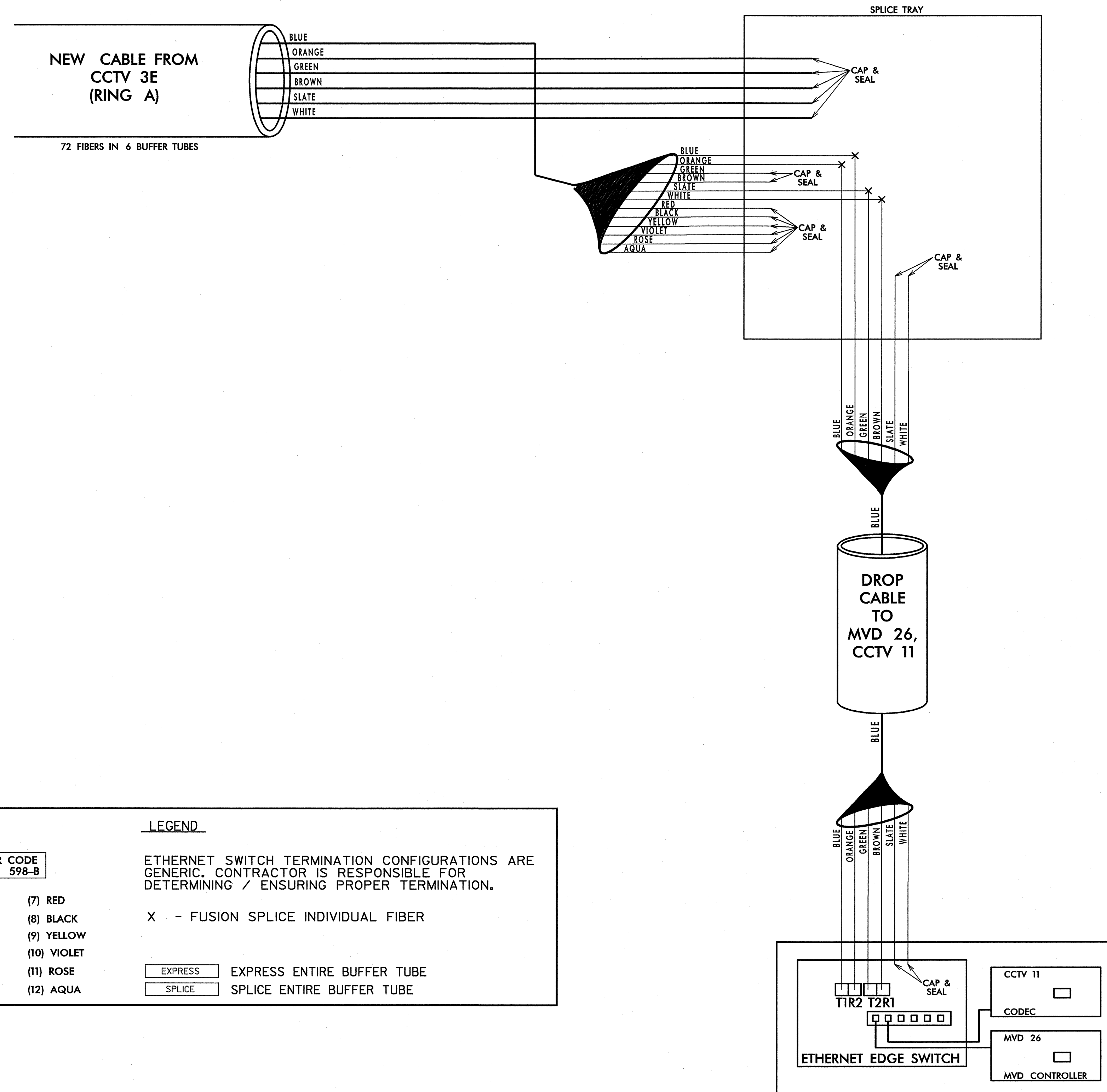

| COLOR CODE TIA/EIA 598-B | | LEGEND | |
|-----------------------------|-------------|--|------------------------------------|
| (1) BLUE | (7) RED | ETHERNET SWITCH TERMINATION CONFIGURATIONS ARE GENERIC. CONTRACTOR IS RESPONSIBLE FOR DETERMINING / ENSURING PROPER TERMINATION. | X - FUSION SPLICE INDIVIDUAL FIBER |
| (2) ORANGE | (8) BLACK | | |
| (3) GREEN | (9) YELLOW | | |
| (4) BROWN | (10) VIOLET | | |
| (5) SLATE | (11) ROSE | | |
| (6) WHITE | (12) AQUA | | |
| | | EXPRESS | EXPRESS ENTIRE BUFFER TUBE |
| | | SPLICE | SPLICE ENTIRE BUFFER TUBE |

NOTES:
1. FIBER INTERCONNECT CENTER RACKS ARE SCHEMATIC ONLY - ACTUAL EQUIPMENT FORM MAY VARY.

**RING A
MVD 26, CCTV 11**

U-2826B

SPLICE DETAILS

PLANS PREPARED IN THE OFFICE OF:

Kimley-Horn and Associates, Inc.
P.O. Box 33068
Raleigh, N.C. 27636-3068
(919) 677-2000
N.C. License # F-002

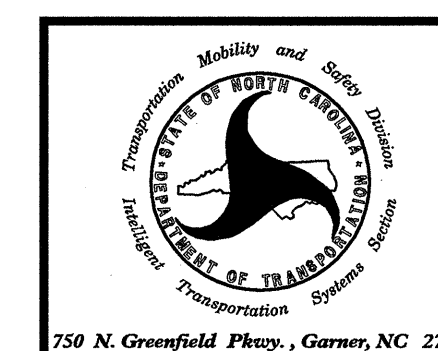

| | |
|---|--------------------------|
| DIVISION 9 FORSYTH COUNTY WINSTON SALEM | |
| PLAN DATE: JANUARY 2011 | REVIEWED BY: S. Phillips |
| PREPARED BY: J. Cross | REVIEWED BY: S. Privette |

| | | |
|-------|---|------|
| SCALE | 0 | NONE |
|-------|---|------|

| | | |
|-----------|-------|------|
| REVISIONS | INIT. | DATE |
| | | |

SEAL
NORTH CAROLINA PROFESSIONAL SEAL 24432

1-25-11
DATE
CADD Filenames

EXISTING SPLICE ENCLOSURE AT PATTERSON AVENUE AT NORTHWEST BLVD.

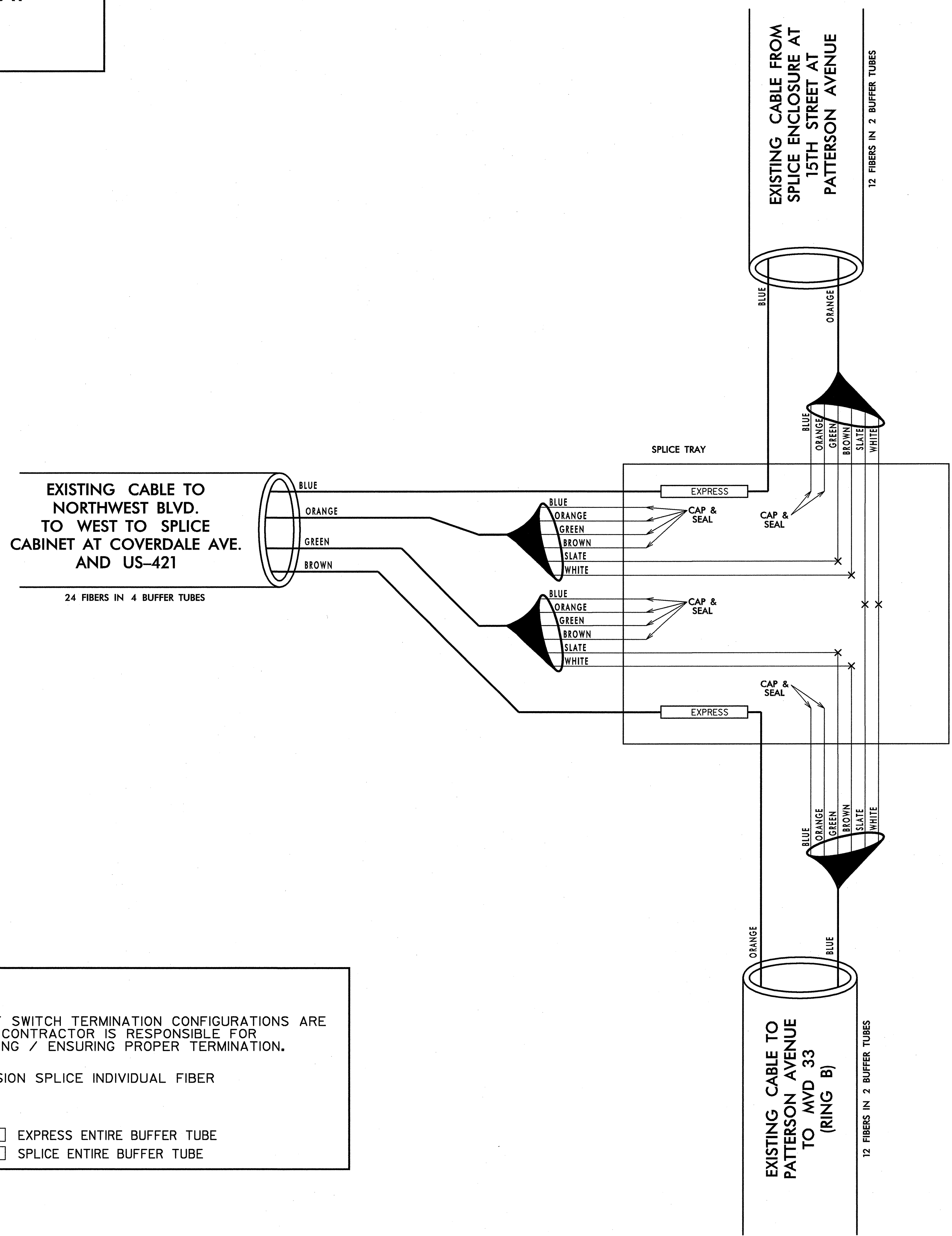

MODIFY EXISTING SPLICE ENCLOSURE

LEGEND

| COLOR CODE TIA/EIA 598-B | | ETHERNET SWITCH TERMINATION CONFIGURATIONS ARE GENERIC. CONTRACTOR IS RESPONSIBLE FOR DETERMINING / ENSURING PROPER TERMINATION. | |
|-----------------------------|-------------|--|----------------------------|
| (1) BLUE | (7) RED | X - FUSION SPLICE INDIVIDUAL FIBER | EXPRESS ENTIRE BUFFER TUBE |
| (2) ORANGE | (8) BLACK | | |
| (3) GREEN | (9) YELLOW | | |
| (4) BROWN | (10) VIOLET | | |
| (5) SLATE | (11) ROSE | | |
| (6) WHITE | (12) AQUA | | |
| EXPRESS | | SPLICE ENTIRE BUFFER TUBE | |

NOTES:
1. FIBER INTERCONNECT CENTER RACKS ARE SCHEMATIC ONLY - ACTUAL EQUIPMENT FORM MAY VARY.

RING A, RING B

U-2826B
SPLICE DETAILS

| | | |
|---|--------------------------|--|
| DIVISION 9 FORSYTH COUNTY WINSTON SALEM | | SEAL NORTH CAROLINA PROFESSIONAL ENGINEER STEPHANIE B. PRIVETTE 24432 |
| PLAN DATE: JANUARY 2011 | REVIEWED BY: S. Phillips | |
| PREPARED BY: J. Cross | REVIEWED BY: S. Privette | SIGNATURE DATE 1/25/11 |
| REVISIONS | INIT. DATE | |

PLANS PREPARED IN THE OFFICE OF:
Kimley-Horn and Associates, Inc.
P.O. Box 33068
Raleigh N.C. 27636-3068
(919) 677-2000
N.C. License # F-0102

750 N. Greenfield Place, Garner, NC 27529

SCALE: NONE

1/25/2011 11:48:35 AM jerry.cross k:\val_tproj_tfs\011086158-us 52.tfs (U-2826B)\plan\Spl1.dwg SPL61.dgn

**SPLICE ENCLOSURE AT MVD 33
PATTERSON AVENUE SOUTH OF
NORTHWEST BLVD.**

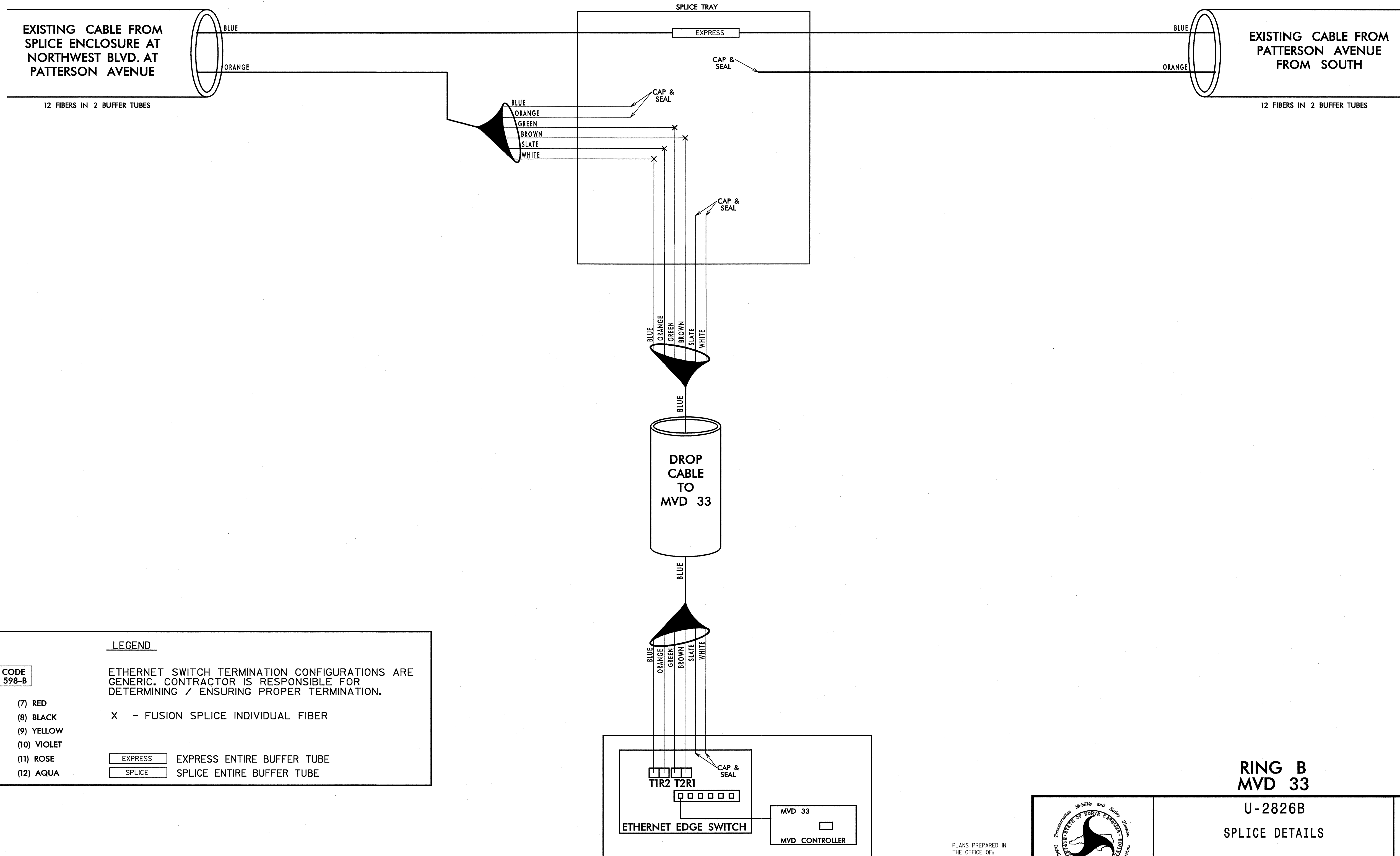

| | | |
|------------------------------------|-------------|--|
| COLOR CODE TIA/EIA 598-B | | LEGEND |
| (1) BLUE | (7) RED | ETHERNET SWITCH TERMINATION CONFIGURATIONS ARE GENERIC. CONTRACTOR IS RESPONSIBLE FOR DETERMINING / ENSURING PROPER TERMINATION. |
| (2) ORANGE | (8) BLACK | |
| (3) GREEN | (9) YELLOW | |
| (4) BROWN | (10) VIOLET | |
| (5) SLATE | (11) ROSE | |
| (6) WHITE | (12) AQUA | |
| | | X - FUSION SPLICE INDIVIDUAL FIBER |
| | | EXPRESS ENTIRE BUFFER TUBE |
| | | SPLICE ENTIRE BUFFER TUBE |

NOTES:
1. FIBER INTERCONNECT CENTER RACKS ARE SCHEMATIC ONLY - ACTUAL EQUIPMENT FORM MAY VARY.

**RING B
MVD 33**

U-2826B
SPLICE DETAILS

PLANS PREPARED IN THE OFFICE OF:
Kimley-Horn and Associates, Inc.
P.O. Box 33068
Raleigh N.C. 27636-3068
(919) 677-2000
N.C. License # F-002

| | | |
|---|---|--------------------------|
| | DIVISION 9 FORSYTH COUNTY WINSTON SALEM | |
| | PLAN DATE: JANUARY 2011 | REVIEWED BY: S. Phillips |
| | PREPARED BY: J. Cross | REVIEWED BY: S. Privette |
| | SCALE: NONE | REVISIONS: |
| SIGNATURE: <i>[Signature]</i> DATE: 1-25-11 | | SEAL: 24432 |

k:\na\trn\11-148-36-AM\11-148-36-AM.dgn
 11-148-36-AM
 jerry.cross
 1/25/2011

SPLICE CABINET AT CLOVERDALE AVENUE AND US-421

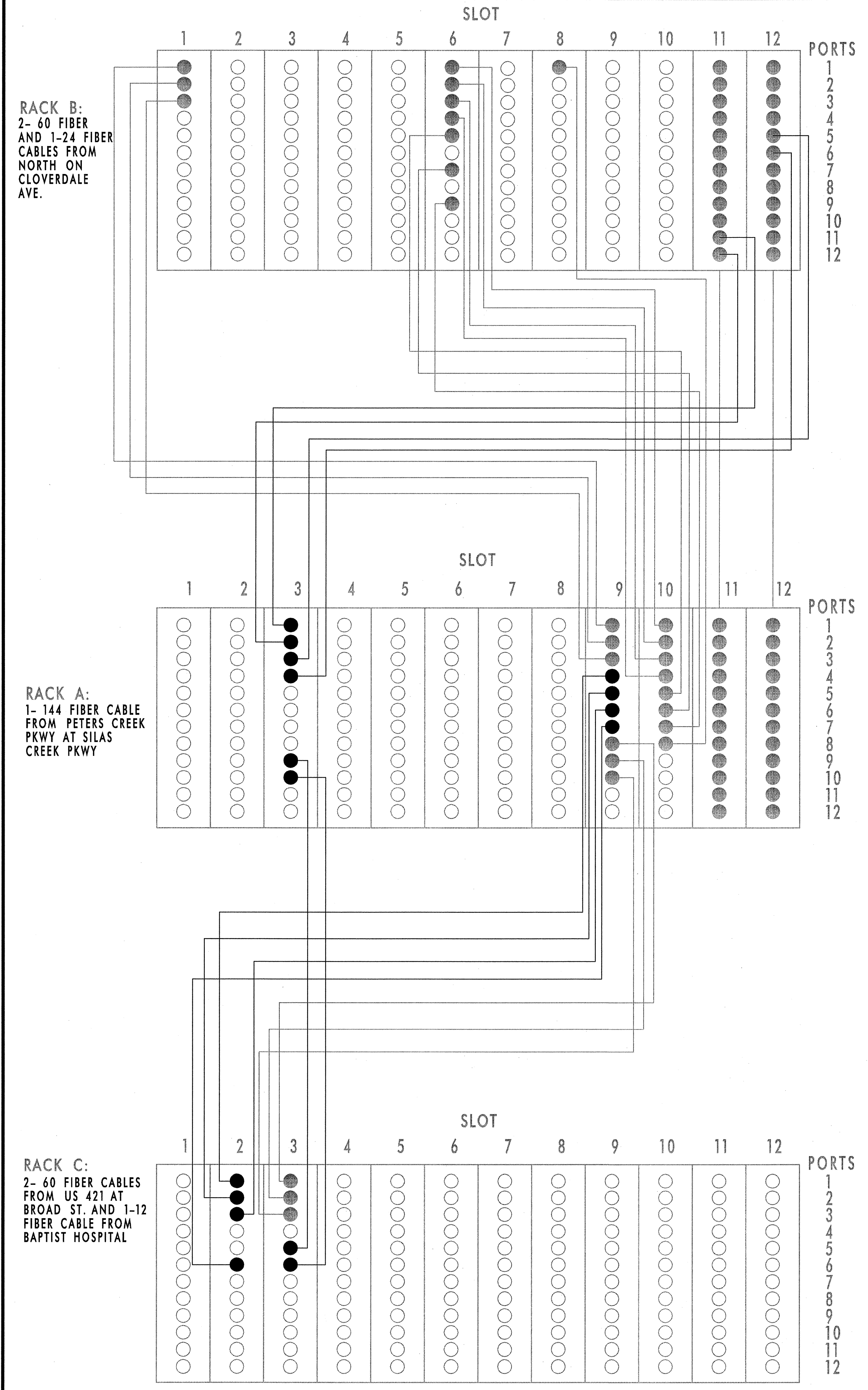

| RACK B | RACK A |
|---|---|
| SLOT 1 PORT 1: PEACE HAVEN RD./US-421 CCTV PORT 2: JONESTOWN RD./US-421 CCTV PORT 3: STRATFORD RD./I-40 BUS CCTV SLOT 6 PORT 1: LEWISVILLE RD./I-40 CCTV PORT 2: JONESTOWN RD./MACGREGOR AT I-40 CCTV PORT 3: JONESTOWN RD./I-40 CCTV PORT 4: I-40 BUS /US-421 MEDIAN WEST OF VINEYARD RD. CCTV PORT 5: STRATFORD RD./I-40 CCTV PORT 6: SPARE PORT 7: SILAS CREEK PKWY /I-40 BUS CCTV PORT 8: SPARE PORT 9: STRATFORD RD./SILAS CREEK PKWY. SLOT 8 PORT 1: WESTVIEW DR/I-40 BUS/US-421 SLOT 11 PORT 1: WSDOT MEDIA CONVERTER PORT 2: STRATFORD SPARE PORT 3: AKRON DR. (CAM 1) PORT 4: WSDOT MEDIA CONVERTER PORT 5: AKRON DR. SPARE PORT 6: 15TH ST. CABINET PORT 7: SPARE TO WSDOT PORT 8: SPARE TO WSDOT PORT 9: 16TH ST. (CAM 2) PORT 10: PORT 11: RING A PORT 12: RING A SLOT 12 PORT 1: VOTMIX FROM WSDOT PORT 2: STRATFORD SPARE PORT 3: 8:1 MUX FROM 3RD ST./MAPLE ST. SPLICE CABINET (US-421 /CEMETARY, GREYHOUND US-421/MLK JR.) PORT 4: VOR DEMUX FROM WSDOT PORT 5: RING B PORT 6: RING B PORT 7: SPARE FROM WSDOT PORT 8: PETERS CREEK /SILAS CREEK (CAM 26) PORT 9: GREYHOUND SPARE PORT 10: 3RD ST./MAPLE ST. SPLICE CABINET PORT 11: PORT 12: | SLOT 3 PORT 1: RING A PORT 2: RING A PORT 3: RING B PORT 4: RING B PORT 5: PORT 6: PORT 7: PORT 8: PORT 9: GREEN ST./I-40 BUS. DMS PORT 10: GREEN ST./I-40 BUS. DMS PORT 11: PORT 12: SLOT 9 PORT 1: PEACE HAVEN RD./US-421 CCTV PORT 2: JONESTOWN RD./US-421 CCTV PORT 3: STRATFORD RD./I-40 BUS CCTV PORT 4: BAPTIST HOSPITAL ANTENNA PORT 5: BAPTIST HOSPITAL ANTENNA PORT 6: BAPTIST HOSPITAL ANTENNA PORT 7: BAPTIST HOSPITAL ANTENNA PORT 8: CHERRY ST./I-40 BUS. CCTV PORT 9: BROAD ST./I-40 BUS. CCTV PORT 10: PETER'S CREEK PKWY/I-40 BUS. CCTV PORT 11: PORT 12: SLOT 10 PORT 1: LEWISVILLE RD./I-40 CCTV PORT 2: JONESTOWN RD./MACGREGOR AT I-40 CCTV PORT 3: JONESTOWN RD./I-40 CCTV PORT 4: I-40 BUS./US 421 MEDIAN WEST OF VINEYARD RD. CCTV PORT 5: STRATFORD RD./I-40 CCTV PORT 6: SILAS CREEK PKWY./I-40 CCTV PORT 7: STRATFORD RD./SILAS CREEK PKWY. PORT 8: WESTVIEW DR./I-40 BUS./US-421 SLOT 11 PORT 1: WSDOT MEDIA CONVERTER PORT 2: STRATFORD RD. SPARE PORT 3: AKRON DR. (CAM 1) PORT 4: WSDOT MEDIA CONVERTER PORT 5: AKRON DR. SPARE PORT 6: 15TH ST. CABINET PORT 7: SPARE TO WSDOT PORT 8: SPARE TO WSDOT PORT 9: 16TH ST. (CAM 2) PORT 10: BURKE MILL (CAM 27) PORT 11: PORT 12: SLOT 12 PORT 1: VORTEX FROM WSDOT PORT 2: STRATFORD RD. SPARE PORT 3: 8:1 MUX FROM 3RD ST./MAPLE ST. SPLICE CABINET (US-421 /CEMETARY RD., GREYHOUND US-421/MLK JR.) PORT 4: VOR DEMUX FROM WSDOT PORT 5: STADIUM DR. SPARE PORT 6: STADIUM DR. SPARE PORT 7: SPARE FROM WSDOT PORT 8: PETER'S CREEK PKWY./SILAS CREEK PKWY. (CAM 26) PORT 9: GREYHOUND SPARE PORT 10: 3RD /MAPLE ST. SPLICE CABINET PORT 11: PORT 12: |

RACK C

| |
|--|
| SLOT 2 PORT 1: BAPTIST HOSPITAL ANTENNA PORT 2: BAPTIST HOSPITAL ANTENNA PORT 3: BAPTIST HOSPITAL ANTENNA PORT 6: BAPTIST HOSPITAL ANTENNA SLOT 3 PORT 1: CHERRY ST./I-40 BUS CCTV PORT 2: BROAD ST./I-40 CCTV PORT 3: PETER'S CREEK PKWY/I-40 BUS CCTV PORT 4: PORT 5: GREEN ST./I-40 BUS. DMS PORT 6: GREEN ST./I-40 BUS. DMS |
|--|

NOTE:
FIBER INTERCONNECT CENTER RACKS ARE SCHEMATIC ONLY - ACTUAL EQUIPMENT FORM FACTOR MAY VARY.

LEGEND

| | |
|------------------------------------|-------------|
| COLOR CODE TIA/EIA 598-B | |
| (1) BLUE | (7) RED |
| (2) ORANGE | (8) BLACK |
| (3) GREEN | (9) YELLOW |
| (4) BROWN | (10) VIOLET |
| (5) SLATE | (11) ROSE |
| (6) WHITE | (12) AQUA |

X - FUSION SPLICE INDIVIDUAL FIBER

| | |
|--|----------------------------|
| | EXPRESS ENTIRE BUFFER TUBE |
| | SPLICE ENTIRE BUFFER TUBE |

k:\na1_tproj_1ts_011056159-us_52_1ts (u-2826B)\plan\splicing\SP163.dgn
 11:48:37 AM jerry.cross
 1/25/2011

PLANS PREPARED IN THE OFFICE OF:

Kimley-Horn and Associates, Inc.
 P.O. Box 33068
 Raleigh N.C. 27636-3068
 (919) 677-2000
 N.C. License # F-0102

| | | | |
|--|---|-------------------------|---|
| | U-2826B SPLICE DETAILS | | |
| | DIVISION 9 FORSYTH COUNTY WINSTON SALEM PLAN DATE: JANUARY 2011 REVIEWED BY: S. Phillips PREPARED BY: J. Cross REVIEWED BY: S. Privette | REVISIONS INIT. DATE | SCALE 0 NONE |
| | SIGNATURE DATE 1-26-11 | | SEAL NORTH CAROLINA PROFESSIONAL ENGINEER SEAL 24432 STEPHANIE B. PRIVETTE |
| | CAD Filenames | | |

SPLICE ENCLOSURE ON CLOVERDALE AVENUE NEAR US-421

EXISTING CABLE FROM SPLICE CABINET AT CLOVERDALE AVENUE AND US-421

144 FIBERS IN 12 BUFFER TUBES

EXISTING CABLE TO DMS 6E (RING C)

144 FIBERS IN 12 BUFFER TUBES

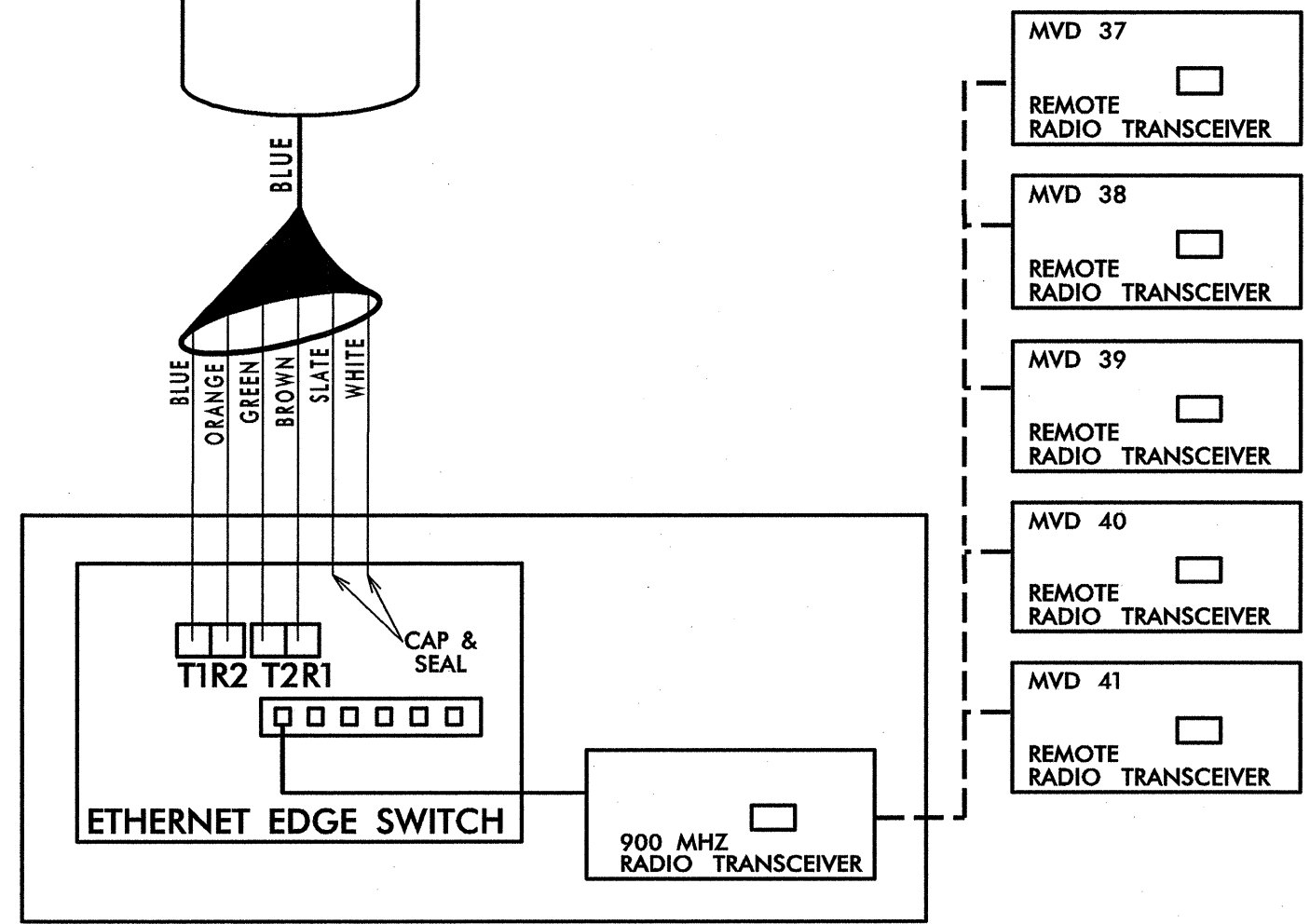
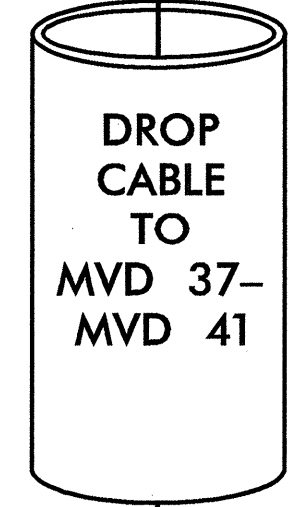
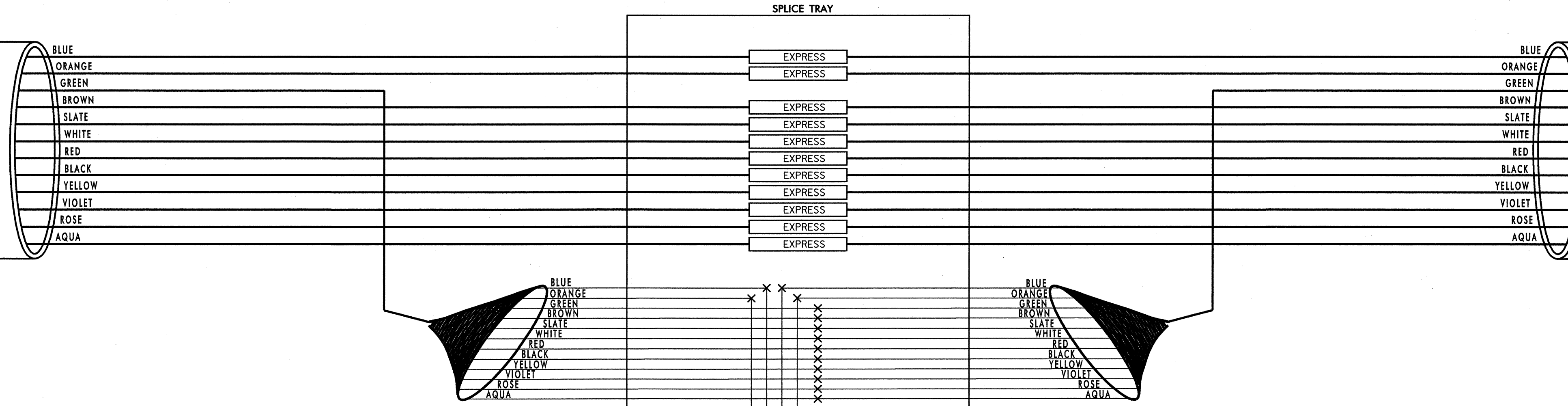

LEGEND

ETHERNET SWITCH TERMINATION CONFIGURATIONS ARE GENERIC. CONTRACTOR IS RESPONSIBLE FOR DETERMINING / ENSURING PROPER TERMINATION.

X - FUSION SPLICE INDIVIDUAL FIBER

| COLOR CODE TIA/EIA 598-B | |
|--------------------------|-------------|
| (1) BLUE | (7) RED |
| (2) ORANGE | (8) BLACK |
| (3) GREEN | (9) YELLOW |
| (4) BROWN | (10) VIOLET |
| (5) SLATE | (11) ROSE |
| (6) WHITE | (12) AQUA |

| | |
|---------|----------------------------|
| EXPRESS | EXPRESS ENTIRE BUFFER TUBE |
| SPLICE | SPLICE ENTIRE BUFFER TUBE |

NOTES:
 1. FIBER INTERCONNECT CENTER RACKS ARE SCHEMATIC ONLY - ACTUAL EQUIPMENT FORM MAY VARY.

**RING A
MVD 37-41**

1/25/2011 11:48:38 AM jerry.cross k:\val_tproj_144\0108158-us 52_144 (U-2826B)\plan\SP1144.dgn

PLANS PREPARED IN THE OFFICE OF:

 Kimley-Horn and Associates, Inc.
 P.O. Box 33068
 Raleigh, N.C. 27636-3068
 (919) 677-2000
 N.C. License # F-002

| | | |
|---|---|---|
| STATE OF NORTH CAROLINA PROFESSIONAL ENGINEER SEAL 24432 STEPHANIE B. PRIVETTE | U-2826B SPLICE DETAILS | |
| | DIVISION 9 FORSYTH COUNTY WINSTON SALEM PLAN DATE: JANUARY 2011 REVIEWED BY: S. Phillips PREPARED BY: J. Cross REVIEWED BY: S. Privette | |
| SCALE 0 NONE | REVISIONS INIT. DATE | SIGNATURE DATE 1-25-11 CAD: Flanders |

**EXISTING SPLICE ENCLOSURE
AT DMS 6E
I-40 NEAR
PETERS CREEK PKWY.**

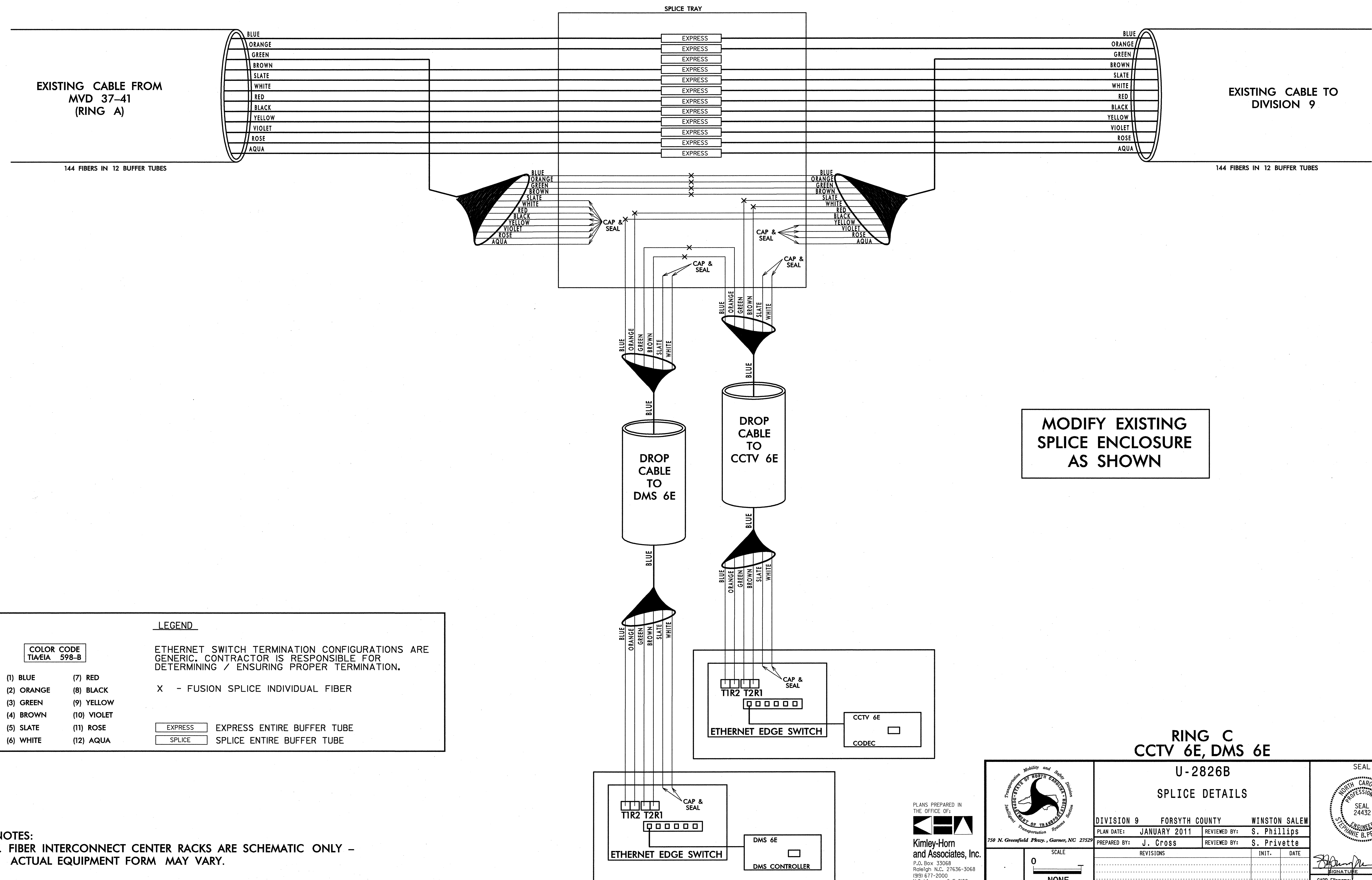

LEGEND

COLOR CODE TIA/EIA 598-B

| | | |
|------------|-------------|--|
| (1) BLUE | (7) RED | ETHERNET SWITCH TERMINATION CONFIGURATIONS ARE GENERIC. CONTRACTOR IS RESPONSIBLE FOR DETERMINING / ENSURING PROPER TERMINATION. X - FUSION SPLICE INDIVIDUAL FIBER |
| (2) ORANGE | (8) BLACK | |
| (3) GREEN | (9) YELLOW | |
| (4) BROWN | (10) VIOLET | |
| (5) SLATE | (11) ROSE | |
| (6) WHITE | (12) AQUA | |

| | |
|--|----------------------------|
| | EXPRESS ENTIRE BUFFER TUBE |
| | SPLICE ENTIRE BUFFER TUBE |

NOTES:
1. FIBER INTERCONNECT CENTER RACKS ARE SCHEMATIC ONLY - ACTUAL EQUIPMENT FORM MAY VARY.

**MODIFY EXISTING
SPLICE ENCLOSURE
AS SHOWN**

**RING C
CCTV 6E, DMS 6E**

| | | |
|------------------------------|--|---------------------------------|
| | <p>U-2826B SPLICE DETAILS</p> | |
| | <p>DIVISION 9 FORSYTH COUNTY WINSTON SALEM</p> | |
| | <p>PLAN DATE: JANUARY 2011</p> | <p>REVIEWED BY: S. Phillips</p> |
| <p>PREPARED BY: J. Cross</p> | <p>REVIEWED BY: S. Privette</p> | <p>SCALE: NONE</p> |
| <p>1/25/2011</p> | <p>11:40:39 AM</p> | <p>1/25/11</p> |

PLANS PREPARED IN THE OFFICE OF:
Kimley-Horn and Associates, Inc.
P.O. Box 33068
Raleigh, N.C. 27636-3068
(919) 677-2000
N.C. License # F-0102

k:\na1_tproj_115101038158-us_52_115 (U-2826B)\na1m\Splicing\SP165.dgn

EXISTING CCTV
ON I-40 BUSINESS
AT BROAD STREET

EXISTING CCTV CABINET
ON I-40 BUS. AT BROAD ST.

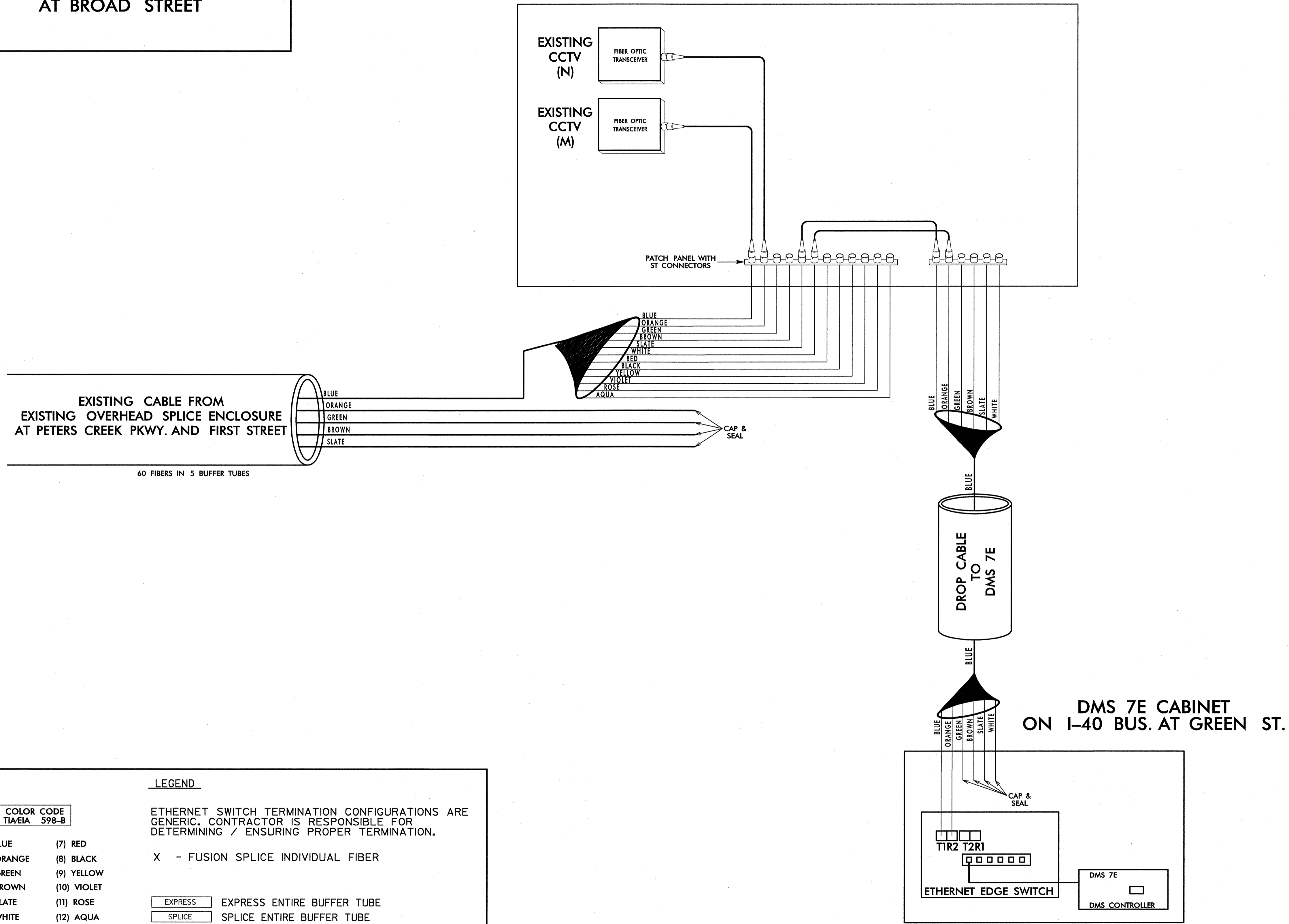

LEGEND

COLOR CODE
TIA/EIA 598-B

| | | |
|------------|-------------|--|
| (1) BLUE | (7) RED | X - FUSION SPLICE INDIVIDUAL FIBER EXPRESS - EXPRESS ENTIRE BUFFER TUBE SPLICE - SPLICE ENTIRE BUFFER TUBE |
| (2) ORANGE | (8) BLACK | |
| (3) GREEN | (9) YELLOW | |
| (4) BROWN | (10) VIOLET | |
| (5) SLATE | (11) ROSE | |
| (6) WHITE | (12) AQUA | |

ETHERNET SWITCH TERMINATION CONFIGURATIONS ARE GENERIC. CONTRACTOR IS RESPONSIBLE FOR DETERMINING / ENSURING PROPER TERMINATION.

NOTES:
1. FIBER INTERCONNECT CENTER RACKS ARE SCHEMATIC ONLY - ACTUAL EQUIPMENT FORM MAY VARY.

PLANS PREPARED IN THE OFFICE OF:
Kimley-Horn and Associates, Inc.
P.O. Box 33068
Raleigh, N.C. 27636-3068
(919) 677-2000
N.C. License # F-0102

750 N. Greenfield Pkwy., Garner, NC 27529

SCALE
0
NONE

| | |
|---|--------------------------|
| U-2826B SPLICE DETAILS | |
| DIVISION 9 FORSYTH COUNTY WINSTON SALEM | |
| PLAN DATE: JANUARY 2011 | REVIEWED BY: S. Phillips |
| PREPARED BY: J. Cross | REVIEWED BY: S. Privette |
| REVISIONS | INIT. DATE |
| | |
| | |

SEAL

SIGNATURE: *Stephanie B. Privette* DATE: 1-25-11
CADD Filename:

1/25/2011 11:48:40 AM jerry_cross k:\pal_broad_11s\01086158-bus 52 11s (U-2826B)\plan\splice.dwg SPL 66.dgn