

STATE OF NORTH CAROLINA
DIVISION OF HIGHWAYS

STATE PROJECT REFERENCE NO. U-5145	SHEET NO. PMP-1
---------------------------------------	--------------------

**PLAN FOR PROPOSED
PAVEMENT MARKING & DELINEATION
CABARRUS COUNTY**

TIP PROJECT: U-5145

WBS 42729.3.1

ROADWAY STANDARD DRAWINGS

THE FOLLOWING ROADWAY STANDARDS AS APPEAR IN "ROADWAY STANDARD DRAWINGS" - PROJECT SERVICES UNIT - N.C. DEPARTMENT OF TRANSPORTATION - RALEIGH, N.C., DATED JULY 2006 ARE APPLICABLE TO THIS PROJECT AND BY REFERENCE HEREBY ARE CONSIDERED A PART OF THESE PLANS:

STD. NO.	TITLE
1205.01	PAVEMENT MARKINGS - LINE TYPES & OFFSETS
1205.02	PAVEMENT MARKINGS - 2 LANE & MULTILANE ROADWAYS
1205.04	PAVEMENT MARKINGS - INTERSECTIONS
1205.05	PAVEMENT MARKINGS - TURN LANES
1205.06	PAVEMENT MARKINGS - THRU LANE DROPS
1205.07	PAVEMENT MARKINGS - PEDESTRIAN CROSSWALKS
1205.08	PAVEMENT MARKINGS - SYMBOLS & WORD MESSAGES
1205.09	PAVEMENT MARKINGS - PAINTED ISLANDS
1205.10	PAVEMENT MARKINGS - SCHOOL AREAS
1205.12	PAVEMENT MARKINGS - BRIDGES
1250.01	PAVEMENT MARKER SPACING
1251.01	RAISED PAVEMENT MARKERS - (PERMANENT)
1261.01	GUARDRAIL & BARRIER DELINEATOR SPACING
1261.02	GUARDRAIL & BARRIER DELINEATOR TYPES
1262.01	GUARDRAIL END DELINEATION
1267.01	FLEXIBLE DELINEATOR INSTALLATION

INDEX OF SHEETS

SHEET NO.	TITLE
PMP-1	LIST OF APPLICABLE ROADWAY STANDARD DRAWINGS, LEGEND, AND INDEX OF SHEETS
PMP-2	GENERAL NOTES, FINAL PAVEMENT MARKING SCHEDULE
PMP 3-6	FINAL PAVEMENT MARKING PLAN DETAIL SHEETS

LEGEND

GENERAL
 DIRECTION OF TRAFFIC FLOW
 NORTH ARROW
 PROPOSED PVMT. EXIST. PVMT.

PAVEMENT MARKINGS
 YELLOW/YELLOW PAVEMENT MARKER
 CRYSTAL/RED PAVEMENT MARKER
 PAVEMENT MARKING SYMBOLS
ONLY PAVEMENT MARKING CHARACTERS

WHEEL CHAIR RAMPS
 WCR-WHEEL CHAIR RAMP 40" FLOOR

N.C.D.O.T. SIGNING & DELINEATION UNIT LIST OF CONTACTS

A.I. ALQUDWAH, P.E. SIGNING & DELINEATION REGIONAL ENGINEER

PLAN PREPARED BY: STANTEC CONSULTING, INC.



Stantec Consulting Services Inc.
801 Jones Franklin Road - Suite 300
Raleigh, NC 27606
Tel. 919.851.6866
Fax. 919.851.7024
www.stantec.com
License No. F-0672

B. L. WATSON, P.E.
TRAFFIC ENGINEER

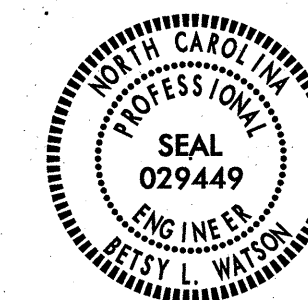

G. KARAGEORGE
TRANSPORTATION DESIGNER

SEAL

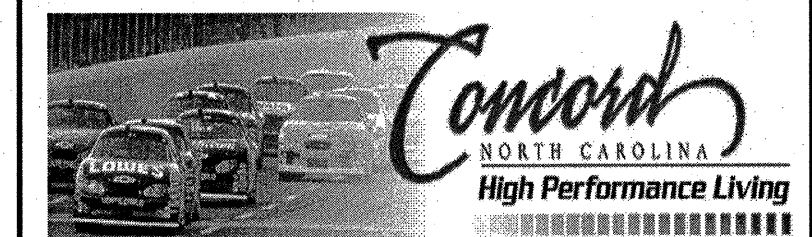
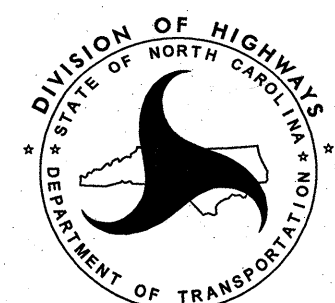

Betsy L. Watson P.E.
SIGNATURE
November 24, 2009
DATE



PROJECT REFERENCE NO. U-5145	SHEET NO. PMP-2
APPROVED: <i>Betsy L. Watson</i>	
DATE: <i>November 24, 2009</i>	
 Stantec <small>Stantec Consulting Services Inc. 801 Jones Franklin Road Suite 300 Raleigh, NC 27606 Tel: (919) 851-6866 Fax: (919) 851-7024 www.stantec.com License No. F-0872</small>	

FINAL PAVEMENT MARKING SCHEDULE

SYMBOL	DESCRIPTION	TOTAL QUANTITY	UNIT	PAY ITEM QUANTITY
PAINT PAVEMENT MARKING LINES, (4")		15,546	LF	
PA	WHITE EDGELINE			5,200
PD	2 FT. WHITE MINISKIP			106
PF	10 FT. YELLOW SKIP			3,400
PI	YELLOW DOUBLE CENTER			6,840
PAINT PAVEMENT MARKING LINES, (24")		300	LF	
P4	WHITE STOPBAR			300
PAINT PAVEMENT MARKING SYMBOLS		12	EA	
QB	RIGHT TURN ARROW			12
THERMOPLASTIC PAVEMENT MARKING LINES, (24", 120 MILS)		1,580	LF	
T2	WHITE STOPBAR			80
T3	WHITE CROSSWALK LINE - 20' WIDTH			1,500
THERMOPLASTIC PAVEMENT MARKING LINES, (4", 90 MILS)		1,000	LF	
TA	WHITE EDGELINE			700
TB	YELLOW EDGELINE			300
THERMOPLASTIC PAVEMENT MARKING LINES, (4", 120 MILS)		5,780	LF	
TC	10 FT. WHITE SKIP			1,775
TD	2 FT. WHITE MINISKIP			355
TE	WHITE SOLID LANE LINE			1,000
TF	10 FT. YELLOW SKIP			150
TH	YELLOW SINGLE CENTER			600
TI	YELLOW DOUBLE CENTER			1,900
THERMOPLASTIC PAVEMENT MARKING LINES, (8", 90 MILS)		135	LF	
TP	WHITE GORELINE			60
TT	YELLOW DIAGONAL			75
THERMOPLASTIC PAVEMENT MARKING SYMBOLS (90 MILS)		32	EA	
UA	LEFT TURN ARROW			11
UB	RIGHT TURN ARROW			9
UC	STRAIGHT ARROW			12
THERMOPLASTIC PAVEMENT MARKING CHARACTERS (120 MILS)		12	EA	
UI	ALPHANUMERIC CHARACTERS			12

GENERAL NOTES

THE FOLLOWING GENERAL NOTES APPLY AT ALL TIMES FOR THE DURATION OF THE CONSTRUCTION PROJECT, EXCEPT WHEN OTHERWISE NOTED IN THE PLAN, OR DIRECTED BY THE ENGINEER.

A) INSTALL PAVEMENT MARKINGS AND PAVEMENT MARKERS ON THE FINAL SURFACE AS FOLLOWS:

ROAD NAME	MARKING	MARKER
MOREHEAD RD.	THERMOPLASTIC	RAISED PERMANENT
RING RD. (Y3/Y4/Y6/Y7)	PAINT (2 APPL.)	NONE
Y5 TO LANDFILL	THERMOPLASTIC	NONE

B) WHERE TWO APPLICATIONS OF PAINT PAVEMENT MARKINGS ARE REQUIRED ON THE FINAL WEARING SURFACE, PLACE THE SECOND APPLICATION OF PAINT UPON SUFFICIENT DRYING TIME OF THE FIRST.



C) TIE PROPOSED PAVEMENT MARKING LINES TO EXISTING PAVEMENT MARKING LINES.

D) REMOVE/REPLACE ANY CONFLICTING/DAMAGED PAVEMENT MARKINGS AND MARKERS.

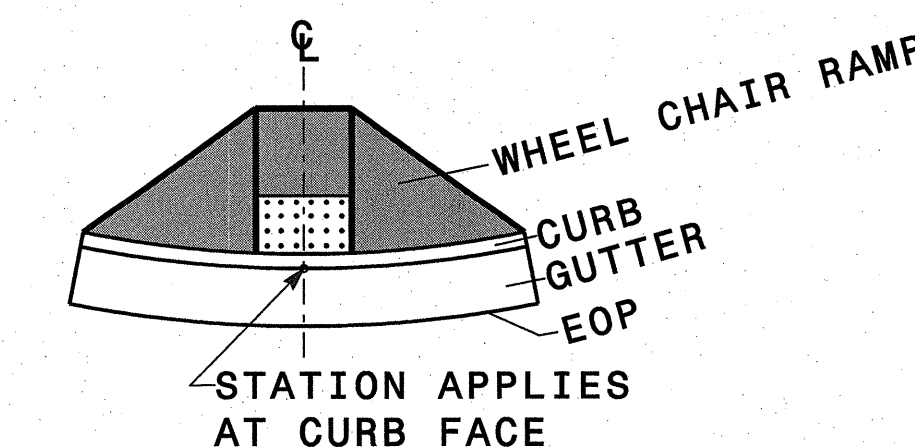
E) STATION SHOWN AT WHEEL CHAIR RAMP LOCATIONS ARE TO FACE OF CURB AT CENTERLINE OF RAMP.



FINAL PAVEMENT MARKING PLAN
 GENERAL NOTES
 FINAL PAVEMENT MARKING SCHEDULE

PROJECT REFERENCE NO. U-5145	SHEET NO. PMP-3
APPROVED: <i>Christy Watson</i>	
DATE: <i>November 24, 2009</i>	
 Stantec <small>Stantec Consulting Services Inc. 801 Jones Franklin Road Suite 300 Raleigh, NC 27606 Tel: (919) 851-6999 Fax: (919) 851-7024 www.stantec.com License No. F-2672</small>	SEAL 

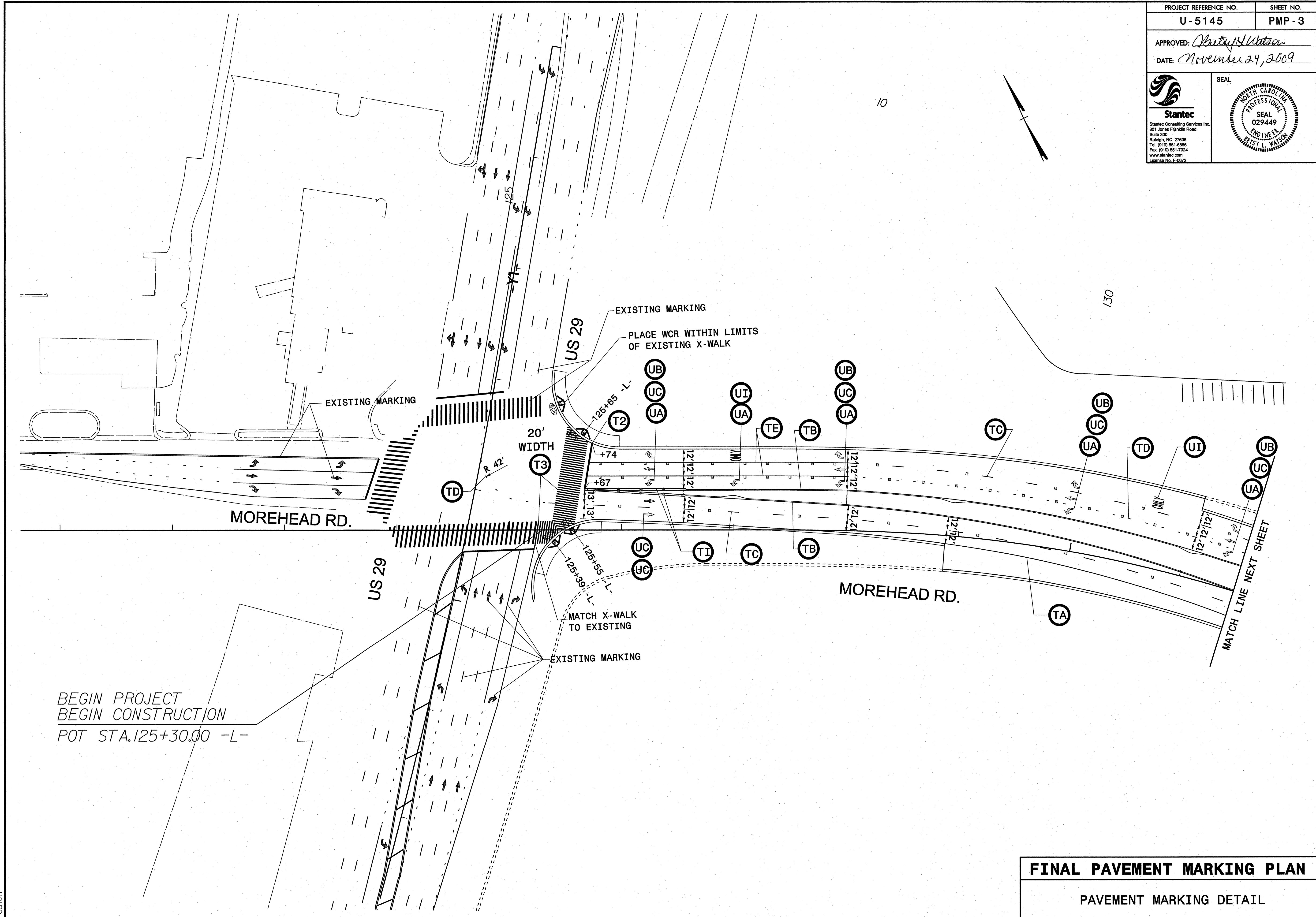

FINAL PAVEMENT MARKING PLAN
PAVEMENT MARKING DETAIL

11/23/2009
us:\traffic\003_morehead\trafficcontrol\pmp\plan_sheets\171000732_Morehead_PMP_psh_03.dgn
Foulen

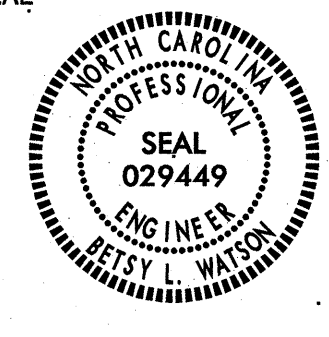
PROJECT REFERENCE NO. U-5145	SHEET NO. PMP-4
APPROVED: <i>Christy Watson</i>	
DATE: <i>November 24, 2009</i>	
 Stantec Stantec Consulting Services Inc. 801 Jones Franklin Road Suite 300 Raleigh, NC 27608 Tel: (919) 851-6888 Fax: (919) 851-7024 www.stantec.com License No. F-2872	SEAL 

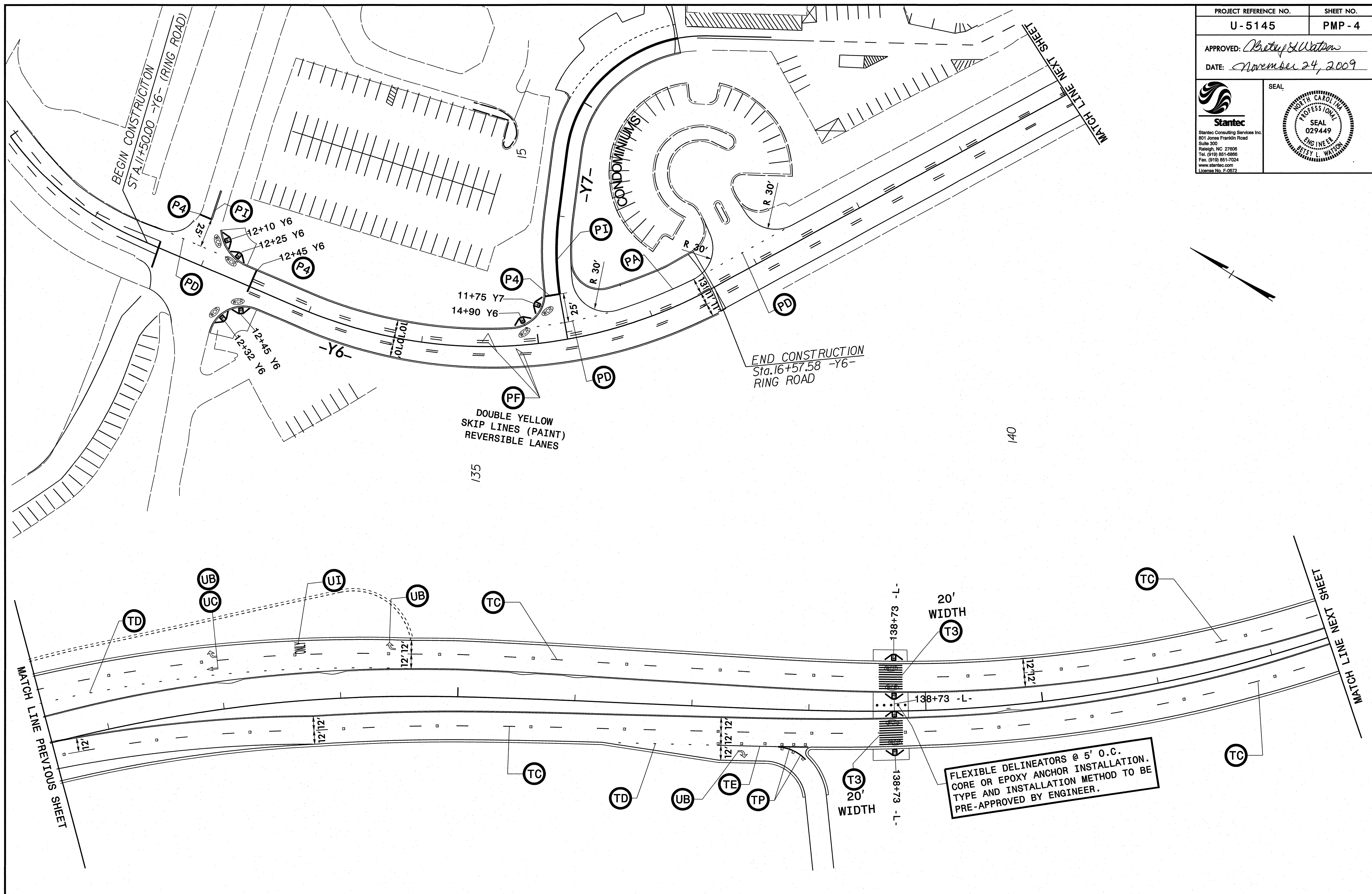

FLEXIBLE DELINEATORS @ 5' O.C.
 CORE OR EPOXY ANCHOR INSTALLATION.
 TYPE AND INSTALLATION METHOD TO BE
 PRE-APPROVED BY ENGINEER.

FINAL PAVEMENT MARKING PLAN
 PAVEMENT MARKING DETAIL

11/23/2009
 us:\traffic\003_morehead\trafficcontrol\pmp\plan_sheets\171000732_Morehead_PMP_psh_04.dgn
 rullen

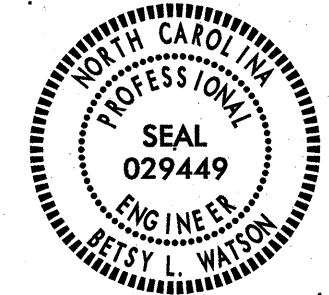
PROJECT REFERENCE NO. U-5145	SHEET NO. PMP-5
APPROVED: <i>Betsy L. Watson</i>	
DATE: <i>November 24, 2009</i>	
 Stantec Stantec Consulting Services Inc. 801 Jones Franklin Road Suite 300 Raleigh, NC 27608 Tel. (919) 851-6996 Fax. (919) 851-7024 www.stantec.com License No. F-0672	SEAL 

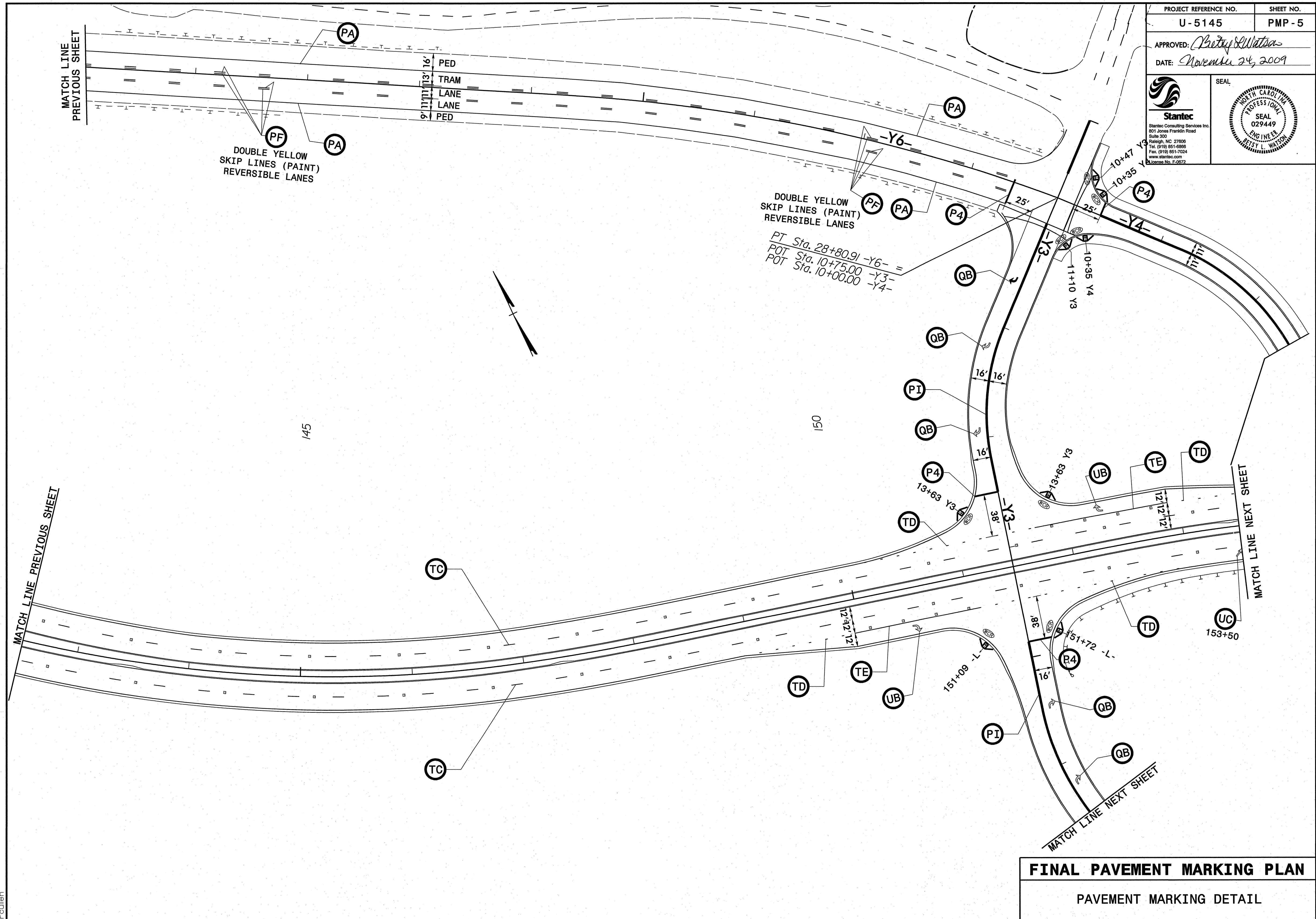

FINAL PAVEMENT MARKING PLAN
 PAVEMENT MARKING DETAIL

11/23/2009
 us:\traffic\003_morehead\trafficcontrol\pmp\plan_sheets\171000732_Morehead_PMP_psh_05.dgn
 reullen

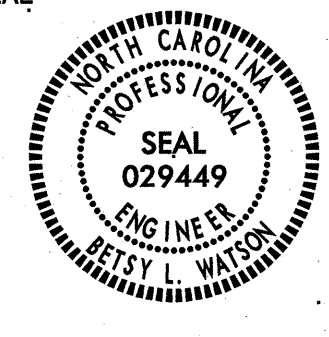
PROJECT REFERENCE NO.	SHEET NO.
U-5145	PMP-6
APPROVED: <i>Cristy Watson</i>	
DATE: November 24, 2009	
 Stantec Stantec Consulting Services Inc. 801 Jones Franklin Road Suite 300 Raleigh, NC 27608 Tel: (919) 851-6999 Fax: (919) 851-7024 www.stantec.com License No. E-2972	SEAL 

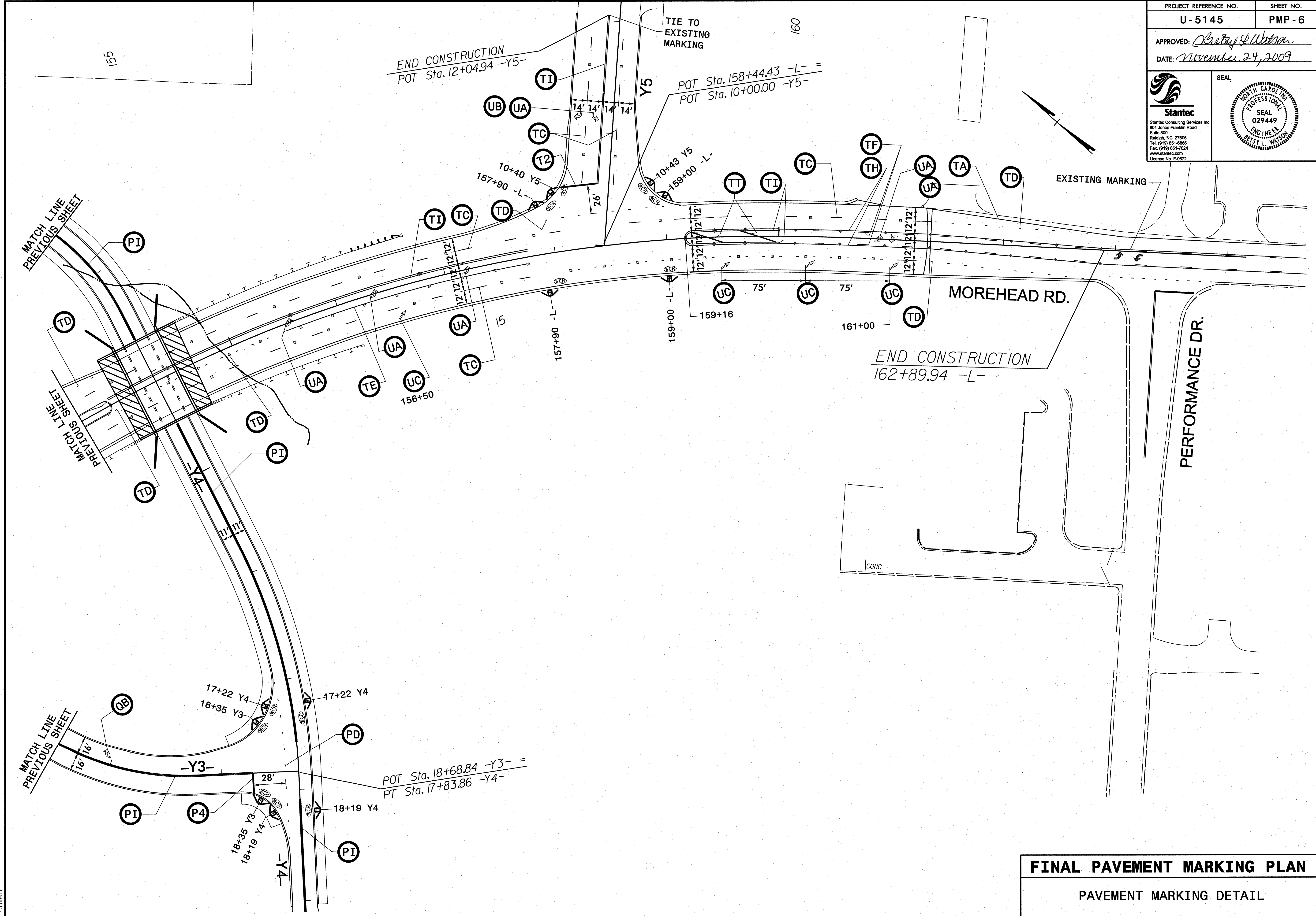

FINAL PAVEMENT MARKING PLAN
PAVEMENT MARKING DETAIL

11/23/2009
 us:\traffic\003_morehead\trafficcontrol\pmp\plan_sheets\171000732_Morehead_PMP_psh_06.dgn
 Reullen