

PROJECT SPECIAL PROVISION

(10-18-95)

Z-1

PERMITS

The Contractor's attention is directed to the following permits, which have been issued to the Department of Transportation by the authority granting the permit.

<u>PERMIT</u>	<u>AUTHORITY GRANTING THE PERMIT</u>
Dredge and Fill and/or Work in Navigable Waters (404)	U. S. Army Corps of Engineers
Water Quality (401)	Division of Environmental Management, DENR State of North Carolina

The Contractor shall comply with all applicable permit conditions during construction of this project. Those conditions marked by * are the responsibility of the department and the Contractor has no responsibility in accomplishing those conditions.

Agents of the permitting authority will periodically inspect the project for adherence to the permits.

The Contractor's attention is also directed to Articles 107-10 and 107-14 of the *Standard Specifications* and the following:

Should the Contractor propose to utilize construction methods (such as temporary structures or fill in waters and/or wetlands for haul roads, work platforms, cofferdams, etc.) not specifically identified in the permit (individual, general, or nationwide) authorizing the project it shall be the Contractor's responsibility to coordinate with the Engineer to determine what, if any, additional permit action is required. The Contractor shall also be responsible for initiating the request for the authorization of such construction method by the permitting agency. The request shall be submitted through the Engineer. The Contractor shall not utilize the construction method until it is approved by the permitting agency. The request normally takes approximately 60 days to process; however, no extensions of time or additional compensation will be granted for delays resulting from the Contractor's request for approval of construction methods not specifically identified in the permit.

Where construction moratoriums are contained in a permit condition which restricts the Contractor's activities to certain times of the year, those moratoriums will apply only to the portions of the work taking place in the waters or wetlands provided that activities outside those areas is done in such a manner as to not affect the waters or wetlands.

U-4401

202

U.S. ARMY CORPS OF ENGINEERS
WILMINGTON DISTRICT

RECEIVED
Division of Highways

Action ID: SAW-2009-1838

County: Mecklenburg

USGS Quad: Harrisburg

OCT 21 2009

GENERAL PERMIT (REGIONAL AND NATIONWIDE) VERIFICATION

Preconstruction
Project Development and
Environmental Analysis Branch

Property Owner / Authorized Agent: NC Department of Transportation, Project Development and Environmental Analysis Branch, Attn: Gregory J. Thorpe, Director

Address: 1548 Mail Service Center
Raleigh, NC 27699-1548

Telephone No.: 919-733-3141

Size and location of property (water body, road name/number, town, etc.): Intersection of SR 2804 (Reedy Creek Road) and SR 2805 (Harrisburg Road) over unnamed tributaries to McKee Creek northeast of Charlotte, TIP No. U-4401.

Description of projects area and activity: Realign the interchange to the north of the existing location and extend an existing 36-inch diameter pipe culvert by 67 feet on an unnamed tributary. Place riprap at the pipe outlet for scour protection. No wetland will be impacted by the proposed work.

Applicable Law: Section 404 (Clean Water Act, 33 USC 1344)
 Section 10 (Rivers and Harbors Act, 33 USC 403)
Authorization: Regional General Permit Number: _____
Nationwide Permit Number: 14

RECEIVED

OCT 26 2009

Chodley

DIVISION OF HIGHWAYS
FEDERAL OFFICE OF NATURAL ENVIRONMENT

Your work is authorized by the above referenced permit provided it is accomplished in strict accordance with the conditions and your submitted plans. Any violation of the attached conditions or deviation from your submitted plans may subject the permittee to a stop work order, a restoration order and/or appropriate legal action.

This verification will remain valid until the expiration date identified below unless the nationwide authorization is modified, suspended or revoked. If, prior to the expiration date identified below, the nationwide permit authorization is reissued and/or modified, this verification will remain valid until the expiration date identified below, provided it complies with all requirements of the modified nationwide permit. If the nationwide permit authorization expires or is suspended, revoked, or is modified, such that the activity would no longer comply with the terms and conditions of the nationwide permit, activities which have commenced (i.e., are under construction) or are under contract to commence in reliance upon the nationwide permit, will remain authorized provided the activity is completed within twelve months of the date of the nationwide permit's expiration, modification or revocation, unless discretionary authority has been exercised on a case-by-case basis to modify, suspend or revoke the authorization.

Activities subject to Section 404 (as indicated above) may also require an individual Section 401 Water Quality Certification. You should contact the NC Division of Water Quality (telephone (919) 733-1786) to determine Section 401 requirements.

For activities occurring within the twenty coastal counties subject to regulation under the Coastal Area Management Act (CAMA), prior to beginning work you must contact the N.C. Division of Coastal Management.

This Department of the Army verification does not relieve the permittee of the responsibility to obtain any other required Federal, State or local approvals/permits.

If there are any questions regarding this verification, any of the conditions of the Permit, or the Corps of Engineers regulatory program, please contact Steven Lund at telephone 828-271-7980.

Corps Regulatory Official: Steven Lund *SWZ*

Date Issued: October 19, 2009

Expiration Date of Verification: October 19, 2011

The Wilmington District is committed to providing the highest level of support to the public. To help us ensure we continue to do so, please complete the attached customer Satisfaction Survey or visit <http://www.saw.usace.army.mil/WETLANDS/index.html> to complete the survey online.

Determination of Jurisdiction:

- Based on preliminary information, there appear to be waters of the US including wetlands within the above described project area. This preliminary determination is not an appealable action under the Regulatory Program Administrative Appeal Process (Reference 33 CFR Part 331).
- There are Navigable Waters of the United States within the above described project area subject to the permit requirements of Section 10 of the Rivers and Harbors Act and Section 404 of the Clean Water Act. Unless there is a change in the law or our published regulations, this determination may be relied upon for a period not to exceed five years from the date of this notification.
- There are waters of the US and/or wetlands within the above described project area subject to the permit requirements of Section 404 of the Clean Water Act (CWA)(33 USC § 1344). Unless there is a change in the law or our published regulations, this determination may be relied upon for a period not to exceed five years from the date of this notification.
- The jurisdictional areas within the above described project area have been identified under a previous action. Please reference jurisdictional determination issued _____. Action ID _____

Basis of Jurisdictional Determination: McKee Creek is a perennial stream (RPW) flowing to the Rocky River, a traditionally navigable water (TNW).

Appeals Information (This information applies only to approved jurisdictional determinations.)

Attached to this verification is an approved jurisdictional determination. If you are not in agreement with that approved jurisdictional determination, you can make an administrative appeal under 33 CFR 331. Enclosed you will find a Notification of Appeal Process (NAP) fact sheet and request for appeal (RFA) form. If you request to appeal this determination you must submit a completed RFA form to the following address:

District Engineer, Wilmington Regulatory Division
Attn: Steven W. Lund, Project Manager
Asheville Regulatory Field Office
151 Patton Avenue, Room 208
Asheville, North Carolina 28801-5006

In order for an RFA to be accepted by the Corps, the Corps must determine that it is complete, that it meets the criteria for appeal under 33 CFR part 331.5, and that it has been received by the District Office within 60 days of the date of the NAP. Should you decide to submit an RFA form, it must be received at the above address by a date 60 days from the date of this permit.

****It is not necessary to submit an RFA form to the District Office if you do not object to the determination in this correspondence.****

Corps Regulatory Official: Steven Lund *SWL*

Date: October 19, 2009

SURVEY PLATS, FIELD SKETCH, WETLAND DELINEATION FORMS, PROJECT PLANS, ETC., MUST BE ATTACHED TO THE FILE COPY OF THIS FORM, IF REQUIRED OR AVAILABLE.

Copy Furnished: N/A

Action ID Number: SAW-2009-1838

County: Mecklenburg

Permittee: NC Department of Transportation, Attn: Gregory S. Thorpe
NW 14, Realign Interchange SR 2804/SR 2805, TIP U-4401

Date Permit Issued: October 19, 2009

Project Manager: Lund

* Upon completion of the activity authorized by this permit and any mitigation required by the permit, sign this certification and return it to the following address:

US ARMY CORPS OF ENGINEERS
WILMINGTON DISTRICT
ASHEVILLE REGULATORY FIELD OFFICE
151 PATTON AVENUE, ROOM 208
ASHEVILLE, NORTH CAROLINA 28801-5006

Please note that your permitted activity is subject to a compliance inspection by a U. S. Army Corps of Engineers representative. If you fail to comply with this permit you are subject to permit suspension, modification, or revocation.

I hereby certify that the work authorized by the above referenced permit has been completed in accordance with the terms and condition of the said permit, and required mitigation was completed in accordance with the permit conditions.

Signature of Permittee

Date

NOTIFICATION OF ADMINISTRATIVE APPEAL OPTIONS AND PROCESS AND REQUEST FOR APPEAL

Applicant: NC Dept. of Transportation File Number: 2009-1838 Date: October 19, 2009

Attached is: See Section below

<input type="checkbox"/>	INITIAL PROFFERED PERMIT (Standard Permit or Letter of permission)	A
<input type="checkbox"/>	PROFFERED PERMIT (Standard Permit or Letter of permission)	B
<input type="checkbox"/>	PERMIT DENIAL	C
<input checked="" type="checkbox"/>	APPROVED JURISDICTIONAL DETERMINATION	D
<input type="checkbox"/>	PRELIMINARY JURISDICTIONAL DETERMINATION	E

SECTION I-- The following identifies your rights and options regarding an administrative appeal of the above decision. Additional information may be found at <http://www.usace.army.mil/inet/functions/cw/cecwo/reg> or Corps regulations at 33 CFR Part 331.

A: INITIAL PROFFERED PERMIT: You may accept or object to the permit.

- **ACCEPT:** If you received a Standard Permit, you may sign the permit document and return it to the district engineer for final authorization. If you received a Letter of Permission (LOP), you may accept the LOP and your work is authorized. Your signature on the Standard Permit or acceptance of the LOP means that you accept the permit in its entirety, and waive all rights to appeal the permit, including its terms and conditions, and approved jurisdictional determinations associated with the permit.
- **OBJECT:** If you object to the permit (Standard or LOP) because of certain terms and conditions therein, you may request that the permit be modified accordingly. You must complete Section II of this form and return the form to the district engineer. Your objections must be received by the district engineer within 60 days of the date of this notice, or you will forfeit your right to appeal the permit in the future. Upon receipt of your letter, the district engineer will evaluate your objections and may: (a) modify the permit to address all of your concerns, (b) modify the permit to address some of your objections, or (c) not modify the permit having determined that the permit should be issued as previously written. After evaluating your objections, the district engineer will send you a proffered permit for your reconsideration, as indicated in Section B below.

B: PROFFERED PERMIT: You may accept or appeal the permit

- **ACCEPT:** If you received a Standard Permit, you may sign the permit document and return it to the district engineer for final authorization. If you received a Letter of Permission (LOP), you may accept the LOP and your work is authorized. Your signature on the Standard Permit or acceptance of the LOP means that you accept the permit in its entirety, and waive all rights to appeal the permit, including its terms and conditions, and approved jurisdictional determinations associated with the permit.
- **APPEAL:** If you choose to decline the proffered permit (Standard or LOP) because of certain terms and conditions therein, you may appeal the declined permit under the Corps of Engineers Administrative Appeal Process by completing Section II of this form and sending the form to the division engineer. This form must be received by the division engineer within 60 days of the date of this notice.

C: PERMIT DENIAL: You may appeal the denial of a permit under the Corps of Engineers Administrative Appeal Process by completing Section II of this form and sending the form to the division engineer. This form must be received by the division engineer within 60 days of the date of this notice.

D: APPROVED JURISDICTIONAL DETERMINATION: You may accept or appeal the approved JD or provide new information.

- **ACCEPT:** You do not need to notify the Corps to accept an approved JD. Failure to notify the Corps within 60 days of the date of this notice, means that you accept the approved JD in its entirety, and waive all rights to appeal the approved JD.
- **APPEAL:** If you disagree with the approved JD, you may appeal the approved JD under the Corps of Engineers Administrative Appeal Process by completing Section II of this form and sending the form to the division engineer. This form must be received by the division engineer within 60 days of the date of this notice.

E: PRELIMINARY JURISDICTIONAL DETERMINATION: You do not need to respond to the Corps regarding the preliminary JD. The Preliminary JD is not appealable. If you wish, you may request an approved JD (which may be appealed), by contacting the Corps district for further instruction. Also you may provide new information for further consideration by the Corps to reevaluate the JD.

SECTION II - REQUEST FOR APPEAL or OBJECTIONS TO AN INITIAL PROFFERED PERMIT

REASONS FOR APPEAL OR OBJECTIONS: (Describe your reasons for appealing the decision or your objections to an initial proffered permit in clear concise statements. You may attach additional information to this form to clarify where your reasons or objections are addressed in the administrative record.)

ADDITIONAL INFORMATION: The appeal is limited to a review of the administrative record, the Corps memorandum for the record of the appeal conference or meeting, and any supplemental information that the review officer has determined is needed to clarify the administrative record. Neither the appellant nor the Corps may add new information or analyses to the record. However, you may provide additional information to clarify the location of information that is already in the administrative record.

POINT OF CONTACT FOR QUESTIONS OR INFORMATION:

<p>If you have questions regarding this decision and/or the appeal process you may contact: Mr. Steven Lund, Project Manager CESA-W-RG-A US Army Corps of Engineers, Wilmington District 151 Patton Avenue, Room 208 Asheville, North Carolina 28801-5006</p>	<p>If you only have questions regarding the appeal process you may also contact:</p>
--	--

RIGHT OF ENTRY: Your signature below grants the right of entry to Corps of Engineers personnel, and any government consultants, to conduct investigations of the project site during the course of the appeal process. You will be provided a 15 day notice of any site investigation, and will have the opportunity to participate in all site investigations.

<p>_____ Signature of appellant or agent.</p>	<p>Date:</p>	<p>Telephone number:</p>
--	--------------	--------------------------

DIVISION ENGINEER:
Commander
U.S. Army Engineer Division, South Atlantic
60 Forsyth Street, Room 9M15
Atlanta, Georgia 30303-3490

**NATIONWIDE PERMIT 14
DEPARTMENT OF THE ARMY
CORPS OF ENGINEERS
FINAL NOTICE OF ISSUANCE AND MODIFICATION OF NATIONWIDE PERMITS
FEDERAL REGISTER
AUTHORIZED MARCH 19, 2007**

Linear Transportation Projects. Activities required for the construction, expansion, modification, or improvement of linear transportation projects (e.g., roads, highways, railways, trails, airport runways, and taxiways) in waters of the United States. For linear transportation projects in non-tidal waters, the discharge cannot cause the loss of greater than 1/2-acre of waters of the United States. For linear transportation projects in tidal waters, the discharge cannot cause the loss of greater than 1/3-acre of waters of the United States. Any stream channel modification, including bank stabilization, is limited to the minimum necessary to construct or protect the linear transportation project; such modifications must be in the immediate vicinity of the project.

This NWP also authorizes temporary structures, fills, and work necessary to construct the linear transportation project. Appropriate measures must be taken to maintain normal downstream flows and minimize flooding to the maximum extent practicable, when temporary structures, work, and discharges, including cofferdams, are necessary for construction activities, access fills, or dewatering of construction sites. Temporary fills must consist of materials, and be placed in a manner, that will not be eroded by expected high flows. Temporary fills must be removed in their entirety and the affected areas returned to pre-construction elevations. The areas affected by temporary fills must be revegetated, as appropriate.

This NWP cannot be used to authorize non-linear features commonly associated with transportation projects, such as vehicle maintenance or storage buildings, parking lots, train stations, or aircraft hangars.

* **Notification:** The permittee must submit a pre-construction notification to the district engineer prior to commencing the activity if: (1) the loss of waters of the United States exceeds 1/10 acre; or (2) there is a discharge in a special aquatic site, including wetlands. (See general condition 27.) (Sections 10 and 404)

Note: Some discharges for the construction of farm roads or forest roads, or temporary roads for moving mining equipment, may qualify for an exemption under Section 404(f) of the Clean Water Act (see 33 CFR 323.4).

NATIONWIDE PERMIT CONDITIONS

The following General Conditions must be followed in order for any authorization by a NWP to be valid:

1. **Navigation.** (a) No activity may cause more than a minimal adverse effect on navigation.
(b) Any safety lights and signals prescribed by the U.S. Coast Guard, through regulations or otherwise, must be installed and maintained at the permittee's expense on authorized facilities in navigable waters of the United States.
(c) The permittee understands and agrees that, if future operations by the United States require the removal, relocation, or other alteration, of the structure or work herein authorized, or if, in the opinion of the Secretary of the Army or his authorized representative, said structure or work shall cause unreasonable obstruction to the free navigation of the navigable waters, the permittee will be required, upon due notice from the Corps of Engineers, to remove, relocate, or alter the structural work or obstructions caused thereby, without expense to the United States. No claim shall be made against the United States on account of any such removal or alteration.
2. **Aquatic Life Movements.** No activity may substantially disrupt the necessary life cycle movements of those species of aquatic life indigenous to the waterbody, including those species that normally migrate through the area, unless the activity's primary purpose is to impound water. Culverts placed in streams must be installed to maintain low flow conditions.
3. **Spawning Areas.** Activities in spawning areas during spawning seasons must be avoided to the maximum extent practicable. Activities that result in the physical destruction (e.g., through excavation, fill, or downstream smothering by substantial turbidity) of an important spawning area are not authorized.
4. **Migratory Bird Breeding Areas.** Activities in waters of the United States that serve as breeding areas for migratory birds must be avoided to the maximum extent practicable.
5. **Shellfish Beds.** No activity may occur in areas of concentrated shellfish populations, unless the activity is directly related to a shellfish harvesting activity authorized by NWPs 4 and 48.
6. **Suitable Material.** No activity may use unsuitable material (e.g., trash, debris, car bodies, asphalt, etc.). Material used for construction or discharged must be free from toxic pollutants in toxic amounts (see Section 307 of the Clean Water Act).
7. **Water Supply Intakes.** No activity may occur in the proximity of a public water supply intake, except where the activity is for the repair or improvement of public water supply intake structures or adjacent bank stabilization.
8. **Adverse Effects From Impoundments.** If the activity creates an impoundment of water, adverse effects to the aquatic system due to accelerating the passage of water, and/or restricting its flow must be minimized to the maximum extent practicable.

9. Management of Water Flows. To the maximum extent practicable, the pre-construction course, condition, capacity, and location of open waters must be maintained for each activity, including stream channelization and storm water management activities, except as provided below. The activity must be constructed to withstand expected high flows. The activity must not restrict or impede the passage of normal or high flows, unless the primary purpose of the activity is to impound water or manage high flows. The activity may alter the pre-construction course, condition, capacity, and location of open waters if it benefits the aquatic environment (e.g., stream restoration or relocation activities).

10. Fills Within 100-Year Floodplains. The activity must comply with applicable FEMA-approved state or local floodplain management requirements.

11. Equipment. Heavy equipment working in wetlands or mudflats must be placed on mats, or other measures must be taken to minimize soil disturbance.

12. Soil Erosion and Sediment Controls. Appropriate soil erosion and sediment controls must be used and maintained in effective operating condition during construction, and all exposed soil and other fills, as well as any work below the ordinary high water mark or high tide line, must be permanently stabilized at the earliest practicable date. Permittees are encouraged to perform work within waters of the United States during periods of low-flow or no-flow.

13. Removal of Temporary Fills. Temporary fills must be removed in their entirety and the affected areas returned to pre-construction elevations. The affected areas must be revegetated, as appropriate.

14. Proper Maintenance. Any authorized structure or fill shall be properly maintained, including maintenance to ensure public safety.

15. Wild and Scenic Rivers. No activity may occur in a component of the National Wild and Scenic River System, or in a river officially designated by Congress as a "study river" for possible inclusion in the system while the river is in an official study status, unless the appropriate Federal agency with direct management responsibility for such river, has determined in writing that the proposed activity will not adversely affect the Wild and Scenic River designation or study status. Information on Wild and Scenic Rivers may be obtained from the appropriate Federal land management agency in the area (e.g., National Park Service, U.S. Forest Service, Bureau of Land Management, U.S. Fish and Wildlife Service).

16. Tribal Rights. No activity or its operation may impair reserved tribal rights, including, but not limited to, reserved water rights and treaty fishing and hunting rights.

17. Endangered Species. (a) No activity is authorized under any NWP which is likely to jeopardize the continued existence of a threatened or endangered species or a species proposed for such designation, as identified under the Federal Endangered Species Act (ESA), or which will destroy or adversely modify the critical habitat of such species. No activity is authorized

under any NWP which “may affect” a listed species or critical habitat, unless Section 7 consultation addressing the effects of the proposed activity has been completed.

(b) Federal agencies should follow their own procedures for complying with the requirements of the ESA. Federal permittees must provide the district engineer with the appropriate documentation to demonstrate compliance with those requirements.

* (c) Non-federal permittees shall notify the district engineer if any listed species or designated critical habitat might be affected or is in the vicinity of the project, or if the project is located in designated critical habitat, and shall not begin work on the activity until notified by the district engineer that the requirements of the ESA have been satisfied and that the activity is authorized. For activities that might affect Federally-listed endangered or threatened species or designated critical habitat, the pre-construction notification must include the name(s) of the endangered or threatened species that may be affected by the proposed work or that utilize the designated critical habitat that may be affected by the proposed work. The district engineer will determine whether the proposed activity “may affect” or will have “no effect” to listed species and designated critical habitat and will notify the non-Federal applicant of the Corps’ determination within 45 days of receipt of a complete pre-construction notification. In cases where the non-Federal applicant has identified listed species or critical habitat that might be affected or is in the vicinity of the project, and has so notified the Corps, the applicant shall not begin work until the Corps has provided notification the proposed activities will have “no effect” on listed species or critical habitat, or until Section 7 consultation has been completed.

(d) As a result of formal or informal consultation with the FWS or NMFS the district engineer may add species-specific regional endangered species conditions to the NWPs.

(e) Authorization of an activity by a NWP does not authorize the “take” of a threatened or endangered species as defined under the ESA. In the absence of separate authorization (e.g., an ESA Section 10 Permit, a Biological Opinion with “incidental take” provisions, etc.) from the U.S. FWS or the NMFS, both lethal and non-lethal “takes” of protected species are in violation of the ESA. Information on the location of threatened and endangered species and their critical habitat can be obtained directly from the offices of the U.S. FWS and NMFS or their world wide Web pages at <http://www.fws.gov/> and <http://www.noaa.gov/fisheries.html> respectively.

18. Historic Properties. (a) In cases where the district engineer determines that the activity may affect properties listed, or eligible for listing, in the National Register of Historic Places, the activity is not authorized, until the requirements of Section 106 of the National Historic Preservation Act (NHPA) have been satisfied.

(b) Federal permittees should follow their own procedures for complying with the requirements of Section 106 of the National Historic Preservation Act. Federal permittees must provide the district engineer with the appropriate documentation to demonstrate compliance with those requirements.

* (c) Non-federal permittees must submit a pre-construction notification to the district engineer if the authorized activity may have the potential to cause effects to any historic properties listed, determined to be eligible for listing on, or potentially eligible for listing on the National Register of Historic Places, including previously unidentified properties. For such activities, the pre-construction notification must state which historic properties may be affected by the proposed work or include a vicinity map indicating the location of the historic properties or the potential for the presence of historic properties. Assistance regarding information on the location of or potential for the presence of historic resources can be sought from the State

Historic Preservation Officer or Tribal Historic Preservation Officer, as appropriate, and the National Register of Historic Places (see 33 CFR 330.4(g)). The district engineer shall make a reasonable and good faith effort to carry out appropriate identification efforts, which may include background research, consultation, oral history interviews, sample field investigation, and field survey. Based on the information submitted and these efforts, the district engineer shall determine whether the proposed activity has the potential to cause an effect on the historic properties. Where the non-Federal applicant has identified historic properties which the activity may have the potential to cause effects and so notified the Corps, the non-Federal applicant shall not begin the activity until notified by the district engineer either that the activity has no potential to cause effects or that consultation under Section 106 of the NHPA has been completed.

(d) The district engineer will notify the prospective permittee within 45 days of receipt of a complete pre-construction notification whether NHPA Section 106 consultation is required. Section 106 consultation is not required when the Corps determines that the activity does not have the potential to cause effects on historic properties (see 36 CFR 800.3(a)). If NHPA section 106 consultation is required and will occur, the district engineer will notify the non-Federal applicant that he or she cannot begin work until Section 106 consultation is completed.

(e) Prospective permittees should be aware that section 110k of the NHPA (16 U.S.C. 470h-2(k)) prevents the Corps from granting a permit or other assistance to an applicant who, with intent to avoid the requirements of Section 106 of the NHPA, has intentionally significantly adversely affected a historic property to which the permit would relate, or having legal power to prevent it, allowed such significant adverse effect to occur, unless the Corps, after consultation with the Advisory Council on Historic Preservation (ACHP), determines that circumstances justify granting such assistance despite the adverse effect created or permitted by the applicant. If circumstances justify granting the assistance, the Corps is required to notify the ACHP and provide documentation specifying the circumstances, explaining the degree of damage to the integrity of any historic properties affected, and proposed mitigation. This documentation must include any views obtained from the applicant, SHPO/THPO, appropriate Indian tribes if the undertaking occurs on or affects historic properties on tribal lands or affects properties of interest to those tribes, and other parties known to have a legitimate interest in the impacts to the permitted activity on historic properties.

19. Designated Critical Resource Waters. Critical resource waters include, NOAA-designated marine sanctuaries, National Estuarine Research Reserves, state natural heritage sites, and outstanding national resource waters or other waters officially designated by a state as having particular environmental or ecological significance and identified by the district engineer after notice and opportunity for public comment. The district engineer may also designate additional critical resource waters after notice and opportunity for comment.

(a) Discharges of dredged or fill material into waters of the United States are not authorized by NWP 7, 12, 14, 16, 17, 21, 29, 31, 35, 39, 40, 42, 43, 44, 49, and 50 for any activity within, or directly affecting, critical resource waters, including wetlands adjacent to such waters.

(b) For NWP 3, 8, 10, 13, 15, 18, 19, 22, 23, 25, 27, 28, 30, 33, 34, 36, 37, and 38, notification is required in accordance with general condition 27, for any activity proposed in the designated critical resource waters including wetlands adjacent to those waters. The district engineer may authorize activities under these NWPs only after it is determined that the impacts to the critical resource waters will be no more than minimal.

20. Mitigation. The district engineer will consider the following factors when determining appropriate and practicable mitigation necessary to ensure that adverse effects on the aquatic environment are minimal:

(a) The activity must be designed and constructed to avoid and minimize adverse effects, both temporary and permanent, to waters of the United States to the maximum extent practicable at the project site (i.e., on site).

(b) Mitigation in all its forms (avoiding, minimizing, rectifying, reducing, or compensating) will be required to the extent necessary to ensure that the adverse effects to the aquatic environment are minimal.

(c) Compensatory mitigation at a minimum one-for-one ratio will be required for all wetland losses that exceed 1/10 acre and require pre-construction notification, unless the district engineer determines in writing that some other form of mitigation would be more environmentally appropriate and provides a project-specific waiver of this requirement. For wetland losses of 1/10 acre or less that require pre-construction notification, the district engineer may determine on a case-by-case basis that compensatory mitigation is required to ensure that the activity results in minimal adverse effects on the aquatic environment. Since the likelihood of success is greater and the impacts to potentially valuable uplands are reduced, wetland restoration should be the first compensatory mitigation option considered.

(d) For losses of streams or other open waters that require pre-construction notification, the district engineer may require compensatory mitigation, such as stream restoration, to ensure that the activity results in minimal adverse effects on the aquatic environment.

(e) Compensatory mitigation will not be used to increase the acreage losses allowed by the acreage limits of the NWPs. For example, if an NWP has an acreage limit of 1/2 acre, it cannot be used to authorize any project resulting in the loss of greater than 1/2 acre of waters of the United States, even if compensatory mitigation is provided that replaces or restores some of the lost waters. However, compensatory mitigation can and should be used, as necessary, to ensure that a project already meeting the established acreage limits also satisfies the minimal impact requirement associated with the NWPs.

(f) Compensatory mitigation plans for projects in or near streams or other open waters will normally include a requirement for the establishment, maintenance, and legal protection (e.g., conservation easements) of riparian areas next to open waters. In some cases, riparian areas may be the only compensatory mitigation required. Riparian areas should consist of native species. The width of the required riparian area will address documented water quality or aquatic habitat loss concerns. Normally, the riparian area will be 25 to 50 feet wide on each side of the stream, but the district engineer may require slightly wider riparian areas to address documented water quality or habitat loss concerns. Where both wetlands and open waters exist on the project site, the district engineer will determine the appropriate compensatory mitigation (e.g., riparian areas and/or wetlands compensation) based on what is best for the aquatic environment on a watershed basis. In cases where riparian areas are determined to be the most appropriate form of compensatory mitigation, the district engineer may waive or reduce the requirement to provide wetland compensatory mitigation for wetland losses.

(g) Permittees may propose the use of mitigation banks, in-lieu fee arrangements or separate activity-specific compensatory mitigation. In all cases, the mitigation provisions will specify the party responsible for accomplishing and/or complying with the mitigation plan.

(h) Where certain functions and services of waters of the United States are permanently adversely affected, such as the conversion of a forested or scrub-shrub wetland to a herbaceous wetland in a permanently maintained utility line right-of-way, mitigation may be required to reduce the adverse effects of the project to the minimal level.

21. Water Quality. Where States and authorized Tribes, or EPA where applicable, have not previously certified compliance of an NWP with CWA Section 401, individual 401 Water Quality Certification must be obtained or waived (see 33 CFR 330.4(c)). The district engineer or State or Tribe may require additional water quality management measures to ensure that the authorized activity does not result in more than minimal degradation of water quality.

22. Coastal Zone Management. In coastal states where an NWP has not previously received a state coastal zone management consistency concurrence, an individual state coastal zone management consistency concurrence must be obtained, or a presumption of concurrence must occur (see 33 CFR 330.4(d)). The district engineer or a State may require additional measures to ensure that the authorized activity is consistent with state coastal zone management requirements.

23. Regional and Case-By-Case Conditions. The activity must comply with any regional conditions that may have been added by the Division Engineer (see 33 CFR 330.4(e)) and with any case specific conditions added by the Corps or by the state, Indian Tribe, or U.S. EPA in its section 401 Water Quality Certification, or by the state in its Coastal Zone Management Act consistency determination.

24. Use of Multiple Nationwide Permits. The use of more than one NWP for a single and complete project is prohibited, except when the acreage loss of waters of the United States authorized by the NWPs does not exceed the acreage limit of the NWP with the highest specified acreage limit. For example, if a road crossing over tidal waters is constructed under NWP 14, with associated bank stabilization authorized by NWP 13, the maximum acreage loss of waters of the United States for the total project cannot exceed 1/3-acre.

25. Transfer of Nationwide Permit Verifications. If the permittee sells the property associated with a nationwide permit verification, the permittee may transfer the nationwide permit verification to the new owner by submitting a letter to the appropriate Corps district office to validate the transfer. A copy of the nationwide permit verification must be attached to the letter, and the letter must contain the following statement and signature:
“When the structures or work authorized by this nationwide permit are still in existence at the time the property is transferred, the terms and conditions of this nationwide permit, including any special conditions, will continue to be binding on the new owner(s) of the property. To validate

the transfer of this nationwide permit and the associated liabilities associated with compliance with its terms and conditions, have the transferee sign and date below.”

(Transferee)

(Date)

* 26. Compliance Certification. Each permittee who received an NWP verification from the Corps must submit a signed certification regarding the completed work and any required mitigation. The certification form must be forwarded by the Corps with the NWP verification letter and will include:

- (a) A statement that the authorized work was done in accordance with the NWP authorization, including any general or specific conditions;
- (b) A statement that any required mitigation was completed in accordance with the permit conditions; and
- (c) The signature of the permittee certifying the completion of the work and mitigation.

* 27. Pre-Construction Notification. (a) Timing. Where required by the terms of the NWP, the prospective permittee must notify the district engineer by submitting a pre-construction notification (PCN) as early as possible. The district engineer must determine if the PCN is complete within 30 calendar days of the date of receipt and, as a general rule, will request additional information necessary to make the PCN complete only once. However, if the prospective permittee does not provide all of the requested information, then the district engineer will notify the prospective permittee that the PCN is still incomplete and the PCN review process will not commence until all of the requested information has been received by the district engineer. The prospective permittee shall not begin the activity until either:

- (1) He or she is notified in writing by the district engineer that the activity may proceed under the NWP with any special conditions imposed by the district or division engineer; or
- (2) Forty-five calendar days have passed from the district engineer's receipt of the complete PCN and the prospective permittee has not received written notice from the district or division engineer. However, if the permittee was required to notify the Corps pursuant to general condition 17 that listed species or critical habitat might be affected or in the vicinity of the project, or to notify the Corps pursuant to general condition 18 that the activity may have the potential to cause effects to historic properties, the permittee cannot begin the activity until receiving written notification from the Corps that is “no effect” on listed species or “no potential to cause effects” on historic properties, or that any consultation required under Section 7 of the Endangered Species Act (see 33 CFR 330.4(f)) and/or Section 106 of the National Historic Preservation (see 33 CFR 330.4(g)) is completed. Also, work cannot begin under NWPs 21, 49, or 50 until the permittee has received written approval from the Corps. If the proposed activity requires a written waiver to exceed specified limits of an NWP, the permittee cannot begin the activity until the district engineer issues the waiver. If the district or division engineer notifies the permittee in writing that an individual permit is required within 45 calendar days of receipt of a complete PCN, the permittee cannot begin the activity until an individual permit has been obtained.

Subsequently, the permittee's right to proceed under the NWP may be modified, suspended, or revoked only in accordance with the procedure set forth in 33 CFR 330.5(d)(2).

(b) Contents of Pre-Construction Notification: The PCN must be in writing and include the following information:

(1) Name, address and telephone numbers of the prospective permittee;

(2) Location of the proposed project;

(3) A description of the proposed project; the project's purpose; direct and indirect adverse environmental effects the project would cause; any other NWP(s), regional general permit(s), or individual permit(s) used or intended to be used to authorize any part of the proposed project or any related activity. The description should be sufficiently detailed to allow the district engineer to determine that the adverse effects of the project will be minimal and to determine the need for compensatory mitigation. Sketches should be provided when necessary to show that the activity complies with the terms of the NWP. (Sketches usually clarify the project and when provided result in a quicker decision.);

(4) The PCN must include a delineation of special aquatic sites and other waters of the United States on the project site. Wetland delineations must be prepared in accordance with the current method required by the Corps. The permittee may ask the Corps to delineate the special aquatic sites and other waters of the United States, but there may be a delay if the Corps does the delineation, especially if the project site is large or contains many waters of the United States. Furthermore, the 45 day period will not start until the delineation has been submitted to or completed by the Corps, where appropriate;

(5) If the proposed activity will result in the loss of greater than 1/10 acre of wetlands and a PCN is required, the prospective permittee must submit a statement describing how the mitigation requirement will be satisfied. As an alternative, the prospective permittee may submit a conceptual or detailed mitigation plan.

(6) If any listed species or designated critical habitat might be affected or is in the vicinity of the project, or if the project is located in designated critical habitat, for non-Federal applicants the PCN must include the name(s) of those endangered or threatened species that might be affected by the proposed work or utilize the designated critical habitat that may be affected by the proposed work. Federal applicants must provide documentation demonstrating compliance with the Endangered Species Act; and

(7) For an activity that may affect a historic property listed on, determined to be eligible for listing on, or potentially eligible for listing on, the National Register of Historic Places, for non-Federal applicants the PCN must state which historic property may be affected by the proposed work or include a vicinity map indicating the location of the historic property. Federal applicants must provide documentation demonstrating compliance with Section 106 of the National Historic Preservation Act.

(c) Form of Pre-Construction Notification: The standard individual permit application form (Form ENG 4345) may be used, but the completed application form must clearly indicate that it is a PCN and must include all of the information required in paragraphs (b)(1) through (7) of this general condition. A letter containing the required information may also be used.

(d) Agency Coordination: (1) The district engineer will consider any comments from Federal and state agencies concerning the proposed activity's compliance with the terms and conditions of the NWPs and the need for mitigation to reduce the project's adverse environmental effects to a minimal level.

(2) For all NWP 48 activities requiring pre-construction notification and for other NWP activities requiring pre-construction notification to the district engineer that result in the loss of greater than 1/2-acre of waters of the United States, the district engineer will immediately provide (e.g., via facsimile transmission, overnight mail, or other expeditious manner) a copy of the PCN to the appropriate Federal or state offices (U.S. FWS, state natural resource or water quality agency, EPA, State Historic Preservation Officer (SHPO) or Tribal Historic Preservation Office (THPO), and, if appropriate, the NMFS). With the exception of NWP 37, these agencies will then have 10 calendar days from the date the material is transmitted to telephone or fax the district engineer notice that they intend to provide substantive, site-specific comments. If so contacted by an agency, the district engineer will wait an additional 15 calendar days before making a decision on the pre-construction notification. The district engineer will fully consider agency comments received within the specified time frame, but will provide no response to the resource agency, except as provided below. The district engineer will indicate in the administrative record associated with each pre-construction notification that the resource agencies' concerns were considered. For NWP 37, the emergency watershed protection and rehabilitation activity may proceed immediately in cases where there is an unacceptable hazard to life or a significant loss of property or economic hardship will occur. The district engineer will consider any comments received to decide whether the NWP 37 authorization should be modified, suspended, or revoked in accordance with the procedures at 33 CFR 330.5.

(3) In cases of where the prospective permittee is not a Federal agency, the district engineer will provide a response to NMFS within 30 calendar days of receipt of any Essential Fish Habitat conservation recommendations, as required by Section 305(b)(4)(B) of the Magnuson-Stevens Fishery Conservation and Management Act.

(4) Applicants are encouraged to provide the Corps multiple copies of pre-construction notifications to expedite agency coordination.

(5) For NWP 48 activities that require reporting, the district engineer will provide a copy of each report within 10 calendar days of receipt to the appropriate regional office of the NMFS.

(e) District Engineer's Decision: In reviewing the PCN for the proposed activity, the district engineer will determine whether the activity authorized by the NWP will result in more than minimal individual or cumulative adverse environmental effects or may be contrary to the public interest. If the proposed activity requires a PCN and will result in a loss of greater than 1/10 acre of wetlands, the prospective permittee should submit a mitigation proposal with the PCN. Applicants may also propose compensatory mitigation for projects with smaller impacts. The district engineer will consider any proposed compensatory mitigation the applicant has included in the proposal in determining whether the net adverse environmental effects to the aquatic environment of the proposed work are minimal. The compensatory mitigation proposal may be either conceptual or detailed. If the district engineer determines that the activity complies with the terms and conditions of the NWP and that the adverse effects on the aquatic environment are minimal, after considering mitigation, the district engineer will notify the permittee and include any conditions the district engineer deems necessary. The district engineer must approve any compensatory mitigation proposal before the permittee commences work. If the prospective permittee elects to submit a compensatory mitigation plan with the PCN, the district engineer will expeditiously review the proposed compensatory mitigation plan. The district engineer must review the plan within 45 calendar days of receiving a complete PCN and determine whether the proposed mitigation would ensure no more than minimal adverse effects on the aquatic environment. If the net adverse effects of the project on the aquatic environment

(after consideration of the compensatory mitigation proposal) are determined by the district engineer to be minimal, the district engineer will provide a timely written response to the applicant. The response will state that the project can proceed under the terms and conditions of the NWP.

If the district engineer determines that the adverse effects of the proposed work are more than minimal, then the district engineer will notify the applicant either: (1) That the project does not qualify for authorization under the NWP and instruct the applicant on the procedures to seek authorization under an individual permit; (2) that the project is authorized under the NWP subject to the applicant's submission of a mitigation plan that would reduce the adverse effects on the aquatic environment to the minimal level; or (3) that the project is authorized under the NWP with specific modifications or conditions. Where the district engineer determines that mitigation is required to ensure no more than minimal adverse effects occur to the aquatic environment, the activity will be authorized within the 45-day PCN period. The authorization will include the necessary conceptual or specific mitigation or a requirement that the applicant submit a mitigation plan that would reduce the adverse effects on the aquatic environment to the minimal level. When mitigation is required, no work in waters of the United States may occur until the district engineer has approved a specific mitigation plan.

28. Single and Complete Project. The activity must be a single and complete project. The same NWP cannot be used more than once for the same single and complete project.

FURTHER INFORMATION

1. District Engineers have authority to determine if an activity complies with the terms and conditions of an NWP.
2. NWPs do not obviate the need to obtain other federal, state, or local permits, approvals, or authorizations required by law.
3. NWPs do not grant any property rights or exclusive privileges.
4. NWPs do not authorize any injury to the property or rights of others.
5. NWPs do not authorize interference with any existing or proposed Federal project.

DEFINITIONS

Best management practices (BMPs): Policies, practices, procedures, or structures implemented to mitigate the adverse environmental effects on surface water quality resulting from development. BMPs are categorized as structural or non-structural.

Compensatory mitigation: The restoration, establishment (creation), enhancement, or preservation of aquatic resources for the purpose of compensating for unavoidable adverse impacts which remain after all appropriate and practicable avoidance and minimization has been achieved.

Currently serviceable: Useable as is or with some maintenance, but not so degraded as to essentially require reconstruction.

Discharge: The term "discharge" means any discharge of dredged or fill material.

Enhancement: The manipulation of the physical, chemical, or biological characteristics of an aquatic resource to heighten, intensify, or improve a specific aquatic resource function(s). Enhancement results in the gain of selected aquatic resource function(s), but may also lead to a

decline in other aquatic resource function(s). Enhancement does not result in a gain in aquatic resource area.

Ephemeral stream: An ephemeral stream has flowing water only during, and for a short duration after, precipitation events in a typical year. Ephemeral stream beds are located above the water table year-round. Groundwater is not a source of water for the stream. Runoff from rainfall is the primary source of water for stream flow.

Establishment (creation): The manipulation of the physical, chemical, or biological characteristics present to develop an aquatic resource that did not previously exist at an upland site. Establishment results in a gain in aquatic resource area.

Historic Property: Any prehistoric or historic district, site (including archaeological site), building, structure, or other object included in, or eligible for inclusion in, the National Register of Historic Places maintained by the Secretary of the Interior. This term includes artifacts, records, and remains that are related to and located within such properties. The term includes properties of traditional religious and cultural importance to an Indian tribe or Native Hawaiian organization and that meet the National Register criteria (36 CFR part 60).

Independent utility: A test to determine what constitutes a single and complete project in the Corps regulatory program. A project is considered to have independent utility if it would be constructed absent the construction of other projects in the project area. Portions of a multi-phase project that depend upon other phases of the project do not have independent utility. Phases of a project that would be constructed even if the other phases were not built can be considered as separate single and complete projects with independent utility.

Intermittent stream: An intermittent stream has flowing water during certain times of the year, when groundwater provides water for stream flow. During dry periods, intermittent streams may not have flowing water. Runoff from rainfall is a supplemental source of water for stream flow.

Loss of waters of the United States: Waters of the United States that are permanently adversely affected by filling, flooding, excavation, or drainage because of the regulated activity. Permanent adverse effects include permanent discharges of dredged or fill material that change an aquatic area to dry land, increase the bottom elevation of a waterbody, or change the use of a waterbody. The acreage of loss of waters of the United States is a threshold measurement of the impact to jurisdictional waters for determining whether a project may qualify for an NWP; it is not a net threshold that is calculated after considering compensatory mitigation that may be used to offset losses of aquatic functions and services. The loss of stream bed includes the linear feet of stream bed that is filled or excavated. Waters of the United States temporarily filled, flooded, excavated, or drained, but restored to pre-construction contours and elevations after construction, are not included in the measurement of loss of waters of the United States. Impacts resulting from activities eligible for exemptions under Section 404(f) of the Clean Water Act are not considered when calculating the loss of waters of the United States.

Non-tidal wetland: A non-tidal wetland is a wetland that is not subject to the ebb and flow of tidal waters. The definition of a wetland can be found at 33 CFR 328.3(b). Non-tidal wetlands contiguous to tidal waters are located landward of the high tide line (i.e., spring high tide line).

Open water: For purposes of the NWPs, an open water is any area that in a year with normal patterns of precipitation has water flowing or standing above ground to the extent that an ordinary high water mark can be determined. Aquatic vegetation within the area of standing or

flowing water is either non-emergent, sparse, or absent. Vegetated shallows are considered to be open waters. Examples of “open waters” include rivers, streams, lakes, and ponds.

Ordinary High Water Mark: An ordinary high water mark is a line on the shore established by the fluctuations of water and indicated by physical characteristics, or by other appropriate means that consider the characteristics of the surrounding areas (see 33 CFR 328.3(e)).

Perennial stream: A perennial stream has flowing water year-round during a typical year. The water table is located above the stream bed for most of the year. Groundwater is the primary source of water for stream flow. Runoff from rainfall is a supplemental source of water for stream flow.

Practicable: Available and capable of being done after taking into consideration cost, existing technology, and logistics in light of overall project purposes.

Pre-construction notification: A request submitted by the project proponent to the Corps for confirmation that a particular activity is authorized by nationwide permit. The request may be a permit application, letter, or similar document that includes information about the proposed work and its anticipated environmental effects. Pre-construction notification may be required by the terms and conditions of a nationwide permit, or by regional conditions. A pre-construction notification may be voluntarily submitted in cases where pre-construction notification is not required and the project proponent wants confirmation that the activity is authorized by nationwide permit.

Preservation: The removal of a threat to, or preventing the decline of, aquatic resources by an action in or near those aquatic resources. This term includes activities commonly associated with the protection and maintenance of aquatic resources through the implementation of appropriate legal and physical mechanisms. Preservation does not result in a gain of aquatic resource area or functions.

Re-establishment: The manipulation of the physical, chemical, or biological characteristics of a site with the goal of returning natural/historic functions to a former aquatic resource. Re-establishment results in rebuilding a former aquatic resource and results in a gain in aquatic resource area.

Rehabilitation: The manipulation of the physical, chemical, or biological characteristics of a site with the goal of repairing natural/historic functions to a degraded aquatic resource. Rehabilitation results in a gain in aquatic resource function, but does not result in a gain in aquatic resource area.

Restoration: The manipulation of the physical, chemical, or biological characteristics of a site with the goal of returning natural/historic functions to a former or degraded aquatic resource. For the purpose of tracking net gains in aquatic resource area, restoration is divided into two categories: re-establishment and rehabilitation.

Riffle and pool complex: Riffle and pool complexes are special aquatic sites under the 404(b)(1) Guidelines. Riffle and pool complexes sometimes characterize steep gradient sections of streams. Such stream sections are recognizable by their hydraulic characteristics. The rapid movement of water over a coarse substrate in riffles results in a rough flow, a turbulent surface, and high dissolved oxygen levels in the water. Pools are deeper areas associated with riffles. A slower stream velocity, a streaming flow, a smooth surface, and a finer substrate characterize pools.

Riparian areas: Riparian areas are lands adjacent to streams, lakes, and estuarine-marine shorelines. Riparian areas are transitional between terrestrial and aquatic ecosystems, through

which surface and subsurface hydrology connects waterbodies with their adjacent uplands. Riparian areas provide a variety of ecological functions and services and help improve or maintain local water quality. (See general condition 20.)

Shellfish seeding: The placement of shellfish seed and/or suitable substrate to increase shellfish production. Shellfish seed consists of immature individual shellfish or individual shellfish attached to shells or shell fragments (i.e., spat on shell). Suitable substrate may consist of shellfish shells, shell fragments, or other appropriate materials placed into waters for shellfish habitat.

Single and complete project: The term “single and complete project” is defined at 33 CFR 330.2(i) as the total project proposed or accomplished by one owner/developer or partnership or other association of owners/developers. A single and complete project must have independent utility (see definition). For linear projects, a “single and complete project” is all crossings of a single water of the United States (i.e., a single waterbody) at a specific location. For linear projects crossing a single waterbody several times at separate and distant locations, each crossing is considered a single and complete project. However, individual channels in a braided stream or river, or individual arms of a large, irregularly shaped wetland or lake, etc., are not separate waterbodies, and crossings of such features cannot be considered separately.

Stormwater management: Stormwater management is the mechanism for controlling stormwater runoff for the purposes of reducing downstream erosion, water quality degradation, and flooding and mitigating the adverse effects of changes in land use on the aquatic environment.

Stormwater management facilities: Stormwater management facilities are those facilities, including but not limited to, stormwater retention and detention ponds and best management practices, which retain water for a period of time to control runoff and/or improve the quality (i.e., by reducing the concentration of nutrients, sediments, hazardous substances and other pollutants) of stormwater runoff.

Stream bed: The substrate of the stream channel between the ordinary high water marks. The substrate may be bedrock or inorganic particles that range in size from clay to boulders. Wetlands contiguous to the stream bed, but outside of the ordinary high water marks, are not considered part of the stream bed.

Stream channelization: The manipulation of a stream’s course, condition, capacity, or location that causes more than minimal interruption of normal stream processes. A channelized stream remains a water of the United States.

Structure: An object that is arranged in a definite pattern of organization. Examples of structures include, without limitation, any pier, boat dock, boat ramp, wharf, dolphin, weir, boom, breakwater, bulkhead, revetment, riprap, jetty, artificial island, artificial reef, permanent mooring structure, power transmission line, permanently moored floating vessel, piling, aid to navigation, or any other manmade obstacle or obstruction.

Tidal wetland: A tidal wetland is a wetland (i.e., water of the United States) that is inundated by tidal waters. The definitions of a wetland and tidal waters can be found at 33 CFR 328.3(b) and 33 CFR 328.3(f), respectively. Tidal waters rise and fall in a predictable and measurable rhythm or cycle due to the gravitational pulls of the moon and sun. Tidal waters end where the rise and fall of the water surface can no longer be practically measured in a predictable rhythm due to masking by other waters, wind, or other effects. Tidal wetlands are located channelward of the high tide line, which is defined at 33 CFR 328.3(d).

Vegetated shallows: Vegetated shallows are special aquatic sites under the 404(b)(1) Guidelines. They are areas that are permanently inundated and under normal circumstances have rooted aquatic vegetation, such as seagrasses in marine and estuarine systems and a variety of vascular rooted plants in freshwater systems.

Waterbody: For purposes of the NWPs, a waterbody is a jurisdictional water of the United States that, during a year with normal patterns of precipitation, has water flowing or standing above ground to the extent that an ordinary high water mark (OHWM) or other indicators of jurisdiction can be determined, as well as any wetland area (see 33 CFR 328.3(b)). If a jurisdictional wetland is adjacent--meaning bordering, contiguous, or neighboring--to a jurisdictional waterbody displaying an OHWM or other indicators of jurisdiction, that waterbody and its adjacent wetlands are considered together as a single aquatic unit (see 33 CFR 328.4(c)(2)). Examples of "waterbodies" include streams, rivers, lakes, ponds, and wetlands.

REGIONAL CONDITIONS FOR NATIONWIDE PERMITS IN THE WILMINGTON DISTRICT

1.0 Excluded Waters

The Corps has identified waters that will be excluded from the use of all NWP's during certain timeframes. These waters are:

1.1. Anadromous Fish Spawning Areas

Waters of the United States identified by either the North Carolina Division of Marine Fisheries (NCDMF) or the North Carolina Wildlife Resources Commission (NCWRC) as anadromous fish spawning areas are excluded during the period between February 15 and June 30, without prior written approval from NCDMF or NCWRC and the Corps.

1.2. Trout Waters Moratorium

Waters of the United States in the twenty-five designated trout counties of North Carolina are excluded during the period between October 15 and April 15 without prior written approval from the NCWRC. (see Section I. b. 7. for a list of the twenty-five trout counties).

1.3. Sturgeon Spawning Areas

Waters of the United States designated as sturgeon spawning areas are excluded during the period between February 1 and June 30, without prior written approval from the National Marine Fisheries Service (NMFS).

*** 2.0 Waters Requiring Additional Notification**

The Corps has identified waters that will be subject to additional notification requirements for activities authorized by all NWP's. These waters are:

*** 2.1. Western NC Counties that Drain to Designated Critical Habitat**

Waters of the U.S. that requires a Pre-Construction Notification pursuant to General Condition 27 (PCN) and located in the sixteen counties listed below, applicants must provide a copy of the PCN to the US Fish and Wildlife Service, 160 Zillicoa Street, Asheville, North Carolina 28805. This PCN must be sent concurrently to the US Fish and Wildlife Service and the Corps Asheville Regulatory Field Office. Please see General Condition 17 for specific notification requirements related to Federally Endangered Species and the following website for information on the location of designated critical habitat.

Counties with tributaries that drain to designated critical habitat that require notification to the Asheville US Fish and Wildlife Service: Avery, Cherokee, Forsyth, Graham, Haywood,

Henderson, Jackson, Macon Mecklenburg, Mitchell, Stokes, Surry, Swain, Transylvania, Union and Yancey.

Website and office addresses for Endangered Species Act Information:

The Wilmington District has developed the following website for applicants which provide guidelines on how to review linked websites and maps in order to fulfill NWP general condition 17 requirements.

<http://www.saw.usace.army.mil/wetlands/ESA>

Applicants who do not have internet access may contact the appropriate US Fish and Wildlife Service offices or the US Army Corps of Engineers office listed below.

US Fish and Wildlife Service
Asheville Field Office
160 Zillicoa Street
Asheville, NC 28801
Telephone: (828) 258-3939

Asheville US Fish and Wildlife Service Office counties: All counties west of and including Anson, Stanly, Davidson, Forsyth and Stokes Counties

US Fish and Wildlife Service
Raleigh Field Office
Post Office Box 33726
Raleigh, NC 27636-3726
Telephone: (919) 856-4520

Raleigh US Fish and Wildlife Service Office counties: all counties east of and including Richmond, Montgomery, Randolph, Guilford, and Rockingham Counties.

*** 2.2. Special Designation Waters**

Prior to the use of any NWP in any of the following North Carolina identified waters and contiguous wetlands, applicants must comply with Nationwide Permit General Condition 27 (PCN). The North Carolina waters and contiguous wetlands that require additional notification requirements are:

“Outstanding Resource Waters” (ORW) and “High Quality Waters” (HQW) (as designated by the North Carolina Environmental Management Commission), or
“Inland Primary Nursery Areas” (IPNA) (as designated by the North Carolina Wildlife Resources Commission), or “Contiguous Wetlands” (as defined by the North Carolina Environmental Management Commission), or “Primary Nursery Areas” (PNA) (as designated by the North Carolina Marine Fisheries Commission).

*** 2.3. Coastal Area Management Act (CAMA) Areas of Environmental Concern**

Non-Federal applicants for any NWP in a designated “Area of Environmental Concern” (AEC) in the twenty (20) counties of Eastern North Carolina covered by the North Carolina Coastal Area Management Act (CAMA), must also obtain the required CAMA permit. Construction activities for non-Federal projects may not commence until a copy of the approved CAMA permit is furnished to the appropriate Wilmington District Regulatory Field Office (Wilmington Field Office – P.O. Box 1890, Wilmington, NC 28402 or Washington Field Office – P.O. Box 1000, Washington, NC 27889).

*** 2.4. Barrier Islands**

Prior to the use of any NWP on a barrier island of North Carolina, applicants must comply with Nationwide Permit General Condition 27 (PCN).

*** 2.5. Mountain or Piedmont Bogs**

Prior to the use of any NWP in a “Mountain or Piedmont Bog” of North Carolina, applicants shall comply with Nationwide Permit General Condition 27 (PCN).

Note: The following wetland community types identified in the N.C. Natural Heritage Program document, “Classification of Natural communities of North Carolina (Michael P. Schafale and Alan S. Weakley, 1990), are subject to this regional condition.

Mountain Bogs	Piedmont Bogs
Swamp Forest-Bog Complex	Upland depression Swamp Forest
Swamp Forest-Bog Complex (Spruce Subtype)	
Southern Appalachian Bog (Northern Subtype)	
Southern Appalachian Bog (Southern Subtype)	
Southern Appalachian Fen	

*** 2.6. Animal Waste Facilities**

Prior to use of any NWP for construction of animal waste facilities in waters of the US, including wetlands, applicants shall comply with Nationwide Permit General Condition 27 (PCN).

*** 2.7. Trout Waters**

Prior to any discharge of dredge or fill material into streams or waterbodies within the twenty-five (25) designated trout counties of North Carolina, the applicant shall comply with

Nationwide Permit General Condition 27 (PCN). The applicant shall also provide a copy of the notification to the appropriate NCWRC office to facilitate the determination of any potential impacts to designated Trout Waters. Notification to the Corps of Engineers will include a statement with the name of the NCWRC biologist contacted, the date of the notification, the location of work, a delineation of wetlands, a discussion of alternatives to working in the mountain trout waters, why alternatives were not selected, and a plan to provide compensatory mitigation for all unavoidable adverse impacts to mountain trout waters.

NCWRC and NC Trout Counties

Mr. Ron Linville			
Western Piedmont Region Coordinator	Alleghany	Caldwell	Watauga
3855 Idlewild Road	Ashe	Mitchell	Wilkes
Kernersville, NC 27284-9180	Avery	Stokes	
Telephone: (336) 769-9453	Burke	Surry	

Mr. Dave McHenry			
Mountain Region Coordinator	Buncombe	Henderson	Polk
20830 Great Smoky Mtn. Expressway	Cherokee	Jackson	Rutherford
Waynesville, NC 28786	Clay	Macon	Swain
Telephone: (828) 452-2546	Graham	Madison	Transylvania
Fax: (828) 452-7772	Haywood	McDowell	Yancey

3.0 List of Corps Regional Conditions for All Nationwide Permits

The following conditions apply to all Nationwide Permits in the Wilmington District:

3.1. Limitation of Loss of Perennial Stream Bed

NWPs may not be used for activities that may result in the loss or degradation of greater than 300 total linear feet of perennial streams. The NWPs may not be used for activities that may result in the loss or degradation of greater than 300 total linear feet of ephemeral and intermittent streams that exhibit important aquatic function(s)* Loss of stream includes the linear feet of stream bed that is filled, excavated, or flooded by the proposed activity. The District Commander can waive the 300 linear foot limit for ephemeral and intermittent streams on a case-by-case basis if he determines that the proposed activity will result in minimal individual and cumulative adverse impacts to the aquatic environment. Waivers for the loss of ephemeral and intermittent streams must be in writing. This waiver only applies to the 300 linear feet threshold for NWPs. Mitigation may still be required for impacts to ephemeral and intermittent streams, on a case-by-case basis, depending on the impacts to the aquatic environment of the proposed project. [*Note: The Corps uses the Stream Quality Assessment Worksheet, located with Permit Information on the Regulatory Program Web Site, to aid in the determination of aquatic function within the intermittent stream channel.]

3.2. Mitigation for Loss of Stream Bed Exceeding 150 Feet.

For any NWP that results in a loss of more than 150 linear feet of perennial and/or ephemeral/intermittent stream, the applicant shall provide a mitigation proposal to compensate for the loss of aquatic function associated with the proposed activity. For stream losses less than 150 linear feet, that require a PCN, the District Commander may determine, on a case-by-case basis that compensatory mitigation is required to ensure that the activity results in minimal adverse effect on the aquatic environment.

3.3. Pre-construction Notification for Loss of Streambed Exceeding 150 Feet.

Prior to use of any NWP for any activity which impacts more than 150 total linear feet of perennial stream or ephemeral/ intermittent stream, the applicant must comply with Nationwide Permit General Condition 27 (PCN). This applies to NWPs that do not have specific notification requirements. If a NWP has specific notification requirements, the requirements of the NWP should be followed.

3.4. Restriction on Use of Live Concrete

For all NWPs which allow the use of concrete as a building material, measures will be taken to prevent live or fresh concrete, including bags of uncured concrete, from coming into contact with waters of the state until the concrete has hardened.

3.5. Requirements for Using Riprap for Bank Stabilization

For all NWPs that allow for the use of riprap material for bank stabilization, the following measures shall be applied:

3.5.1. Filter cloth must be placed underneath the riprap as an additional requirement of its use in North Carolina waters.

3.5.2. The placement of riprap shall be limited to the areas depicted on submitted work plan drawings.

3.5.3. The riprap material shall be clean and free from loose dirt or any pollutant except in trace quantities that would not have an adverse environmental effect.

3.5.4. It shall be of a size sufficient to prevent its movement from the authorized alignment by natural forces under normal conditions.

3.5.5. The riprap material shall consist of clean rock or masonry material such as, but not limited to, granite, marl, or broken concrete.

3.5.6. A waiver from the specifications in this Regional Condition may be requested in writing. The waiver will only be issued if it can be demonstrated that the impacts of complying with this Regional condition would result in greater adverse impacts to the aquatic environment.

3.6. Safe Passage Requirements for Culvert Placement

For all NWP's that involve the construction/installation of culverts, measures will be included in the construction/installation that will promote the safe passage of fish and other aquatic organisms. The dimension, pattern, and profile of the stream above and below a pipe or culvert should not be modified by widening the stream channel or by reducing the depth of the stream in connection with the construction activity. The width, height, and gradient of a proposed opening should be such as to pass the average historical low flow and spring flow without adversely altering flow velocity. Spring flow should be determined from gage data, if available. In the absence of such data, bankfull flow can be used as a comparable level.

In the twenty (20) counties of North Carolina designated as coastal counties by the Coastal Area Management Act (CAMA): All pipe and culvert bottoms shall be buried at least one foot below normal bed elevation when they are placed within the Public Trust Area of Environmental Concern (AEC) and/or the Estuarine Waters AEC as designated by CAMA, and/or all streams appearing as blue lines on United States Geological Survey (USGS) quad sheets.

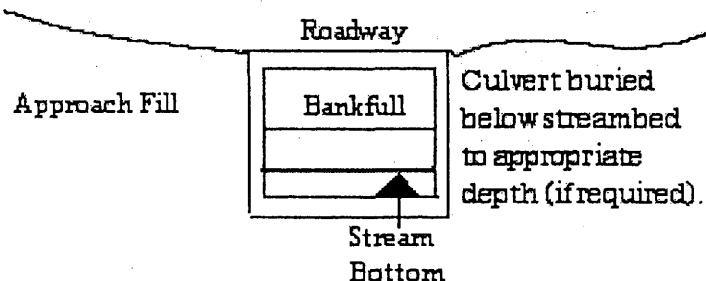

In all other counties: Culverts greater than 48 inches in diameter will be buried at least one foot below the bed of the stream. Culverts 48 inches in diameter or less shall be buried or placed on the stream bed as practicable and appropriate to maintain aquatic passage, and every effort shall be made to maintain the existing channel slope. The bottom of the culvert must be placed at a depth below the natural stream bottom to provide for passage during drought or low flow conditions.

Destabilizing the channel and head cutting upstream should be considered in the placement of the culvert.

A waiver from the depth specifications in this condition may be requested in writing. The waiver will be issued if it can be demonstrated that the proposal would result in the least impacts to the aquatic environment.

All counties: Culverts placed in wetlands do not have to be buried.

3.7. Notification to NCDENR Shellfish Sanitation Section

Applicants shall notify the NCDENR Shellfish Sanitation Section prior to dredging in or removing sediment from an area closed to shell fishing where the effluent may be released to an area open for shell fishing or swimming in order to avoid contamination from the disposal area and cause a temporary shellfish closure to be made. Such notification shall also be provided to the appropriate Corps of Engineers Regulatory Field Office. Any disposal of sand to the ocean beach should occur between November 1 and April 30 when recreational usage is low. Only clean sand should be used and no dredged sand from closed shell fishing areas may be used. If beach disposal were to occur at times other than stated above or if sand from a closed shell fishing area is to be used, a swimming advisory shall be posted, and a press release shall be issued.

3.8. Preservation of Submerged Aquatic Vegetation

Adverse impacts to Submerged Aquatic Vegetation (SAV) are not authorized by any NWP within any of the twenty coastal counties defined by North Carolina's Coastal Area Management Act of 1974 (CAMA).

4.0 Additional Regional Conditions Applicable to Specific Nationwide Permits

The following regional conditions are required for NWP #14 - Linear Transportation Crossings:

4.1. Natural Channel Design

Applicants shall employ natural channel design (see definition below) to the maximum extent practicable for stream relocations. In the event it is not practicable to employ natural channel design, any stream relocation shall be considered a permanent impact and the applicant shall provide a mitigation plan to compensate for the loss of aquatic function associated with the proposed activity.

Natural Channel Design: A geomorphologic approach to stream restoration based on an understanding of valley type, general watershed conditions, dimension, pattern, profile, hydrology and sediment transport of natural, stable channels (reference condition) and applying this understanding to the reconstruction of a stable channel.

4.2. Maintenance of Bank-full Flows

Bank-full flows (or less) shall be accommodated through maintenance of the existing bank-full channel cross sectional area. Additional culverts at such crossings shall be allowed only to receive flows exceeding bank-full.

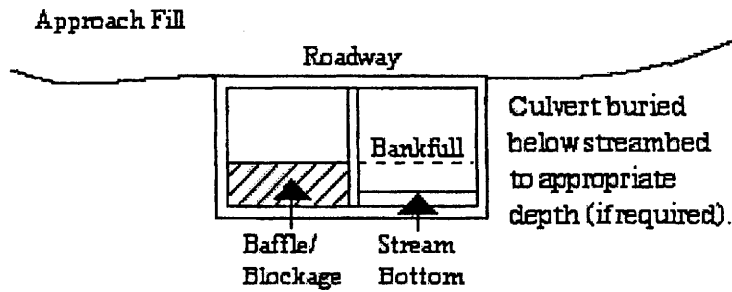

4.3. Maintenance of Floodplain Elevation

Where adjacent floodplain is available, flows exceeding bank-full should be accommodated by installing culverts at the floodplain elevation.

4.4. Prohibition to Create Upland from Waters of the US

This NWP authorizes only upland to upland crossings and cannot be used in combination with Nationwide Permit 18 to create upland within waters of the United States, including wetlands.

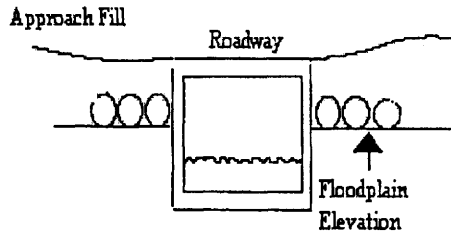

4.5. Tidal Water Restrictions

This NWP cannot be used for private projects located in tidal waters or tidal wetlands.

NC DIVISION OF WATER QUALITY - GENERAL CERTIFICATION CONDITIONS

For the most recent General Certification conditions, call the NC Division of Water Quality, Wetlands/401 Certification Unit at (919) 733-1786 or access the following website:
<http://h2o.enr.state.nc.us/ncwetlands/certs.html>

NC DIVISION OF COASTAL MANAGEMENT - STATE CONSISTENCY

In a letter dated May 7, 2007, the North Carolina Division of Coastal Management found this NWP consistent with the North Carolina Coastal Zone Management Program. Updates on CAMA Consistency for NC can be found on the NC DCM web site at:
<http://dcm2.enr.state.nc.us/Permits/consist.htm>

EASTERN BAND OF THE CHEROKEE INDIANS TRIBAL WATER QUALITY CERTIFICATIONS

In a letter dated May 8, 2007, US EPA, on behalf of the Eastern Band of Cherokee Indians, provided Tribal General Conditions for Nationwide Permits on Cherokee Indian Reservation. These Tribal General Conditions are located on the Corps website at:
<http://www.saw.usace.army.mil/WETLANDS/NWP2007/EBCI-certs.html>

Citations:

2007 Nationwide Permits Public Notice for Final Issue Date: March 15, 2007

Correction Notice for Nationwide Permits, Federal Register / Vol. 72, No. 88 / Tuesday, May 8, 2007 / Notices p.26082

2007 SAW Regional Conditions – Authorized June 1, 2007

This and other information can be found on the Corps web site at:
<http://www.saw.usace.army.mil/WETLANDS/NWP2007/nationwide-permits.html>

231



North Carolina Department of Environment and Natural Resources
Division of Water Quality

Beverly Eaves Perdue
Governor

Coleen H. Sullins
Director

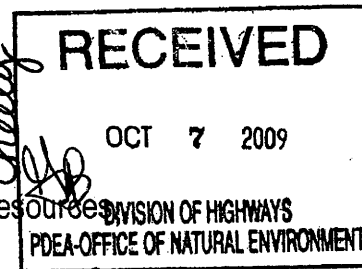

Dee Freeman
Secretary

RECEIVED
Division of Highways

October 5, 2009

DWQ# 09-0963

OCT 07 2009

Mecklenburg County

Preconstruction
Project Development and
Environmental Analysis Branch

Dr. Greg Thorpe, Ph.D., Manager
Project Development and Environmental Analysis Branch
North Carolina Department of Transportation
1598 Mail Service Center
Raleigh, North Carolina, 27699-1548

**APPROVAL of 401 Water Quality Certification with Additional Conditions, Proposed Intersection
Realignment of State Road 2804 (Reedy Creek Road) and State Road 2805 (Harrisburg Road),
Mecklenburg County, State Project No. 9.8109822), WBS Element 36771.1.2, TIP No. U-4401**

Dear Dr. Thorpe:

You have our approval, in accordance with the attached conditions and those listed below, to permanently impact 67 linear feet (lf) (culvert extension) and to temporarily impact 12 lf (construction activities) of an unnamed tributary to McKee Creek, an intermittent stream, as described in your application received by the Division of Water Quality (DWQ) on September 3, 2009. The location of the project is State Road 2804 (Reedy Creek Road) and State Road 2805 (Harrisburg Road) in Mecklenburg County. After reviewing your application, we have determined that this project is covered by Water Quality General Certification Numbers 3704. Please note that you should get any other federal, state or local permits before proceeding with your project, including those required by (but not limited to) Sediment and Erosion Control, Non-Discharge, and Water Supply Watershed regulations. This approval will expire with the associated 404 permit unless otherwise specified in the Water Quality Certification.

This approval is valid solely for the purpose and design that you described in your application (unless modified below). Should your project change, you must notify the DWQ in writing and you may be required to submit a new application. If the property is sold, the new owner must be given a copy of this Certification and approval letter and is thereby responsible for complying with all conditions. If total wetland fills for this project (now or in the future) exceed one acre, or if total impacts to streams (now or in the future) exceed 150 linear feet, compensatory mitigation may be required as described in 15A NCAC 2H.0506 (h)(6) and (7). For this approval to remain valid, you must adhere to the conditions listed in the attached certification and those listed below:

1. Placement of culverts and other structures in waters, streams and wetlands must be below the elevation of the streambed by one (1) foot for all culverts with a diameter greater than 48 inches, and 20 percent of the culvert diameter for culverts having a diameter less than 48 inches, to allow for low flow passage of water and aquatic life, as well as prevent headcutting of the streams. The design and placement of culverts and other structures including temporary erosion control measures shall be installed in such a manner that the original stream profiles are not altered (i.e., the depth of the channel must not be reduced by a widening of the streambed).

Mooreville Regional Office
Location: 610 East Center Ave., Suite 301 Mooreville, NC 28115
Phone: (704) 663-1699 \ Fax: (704) 663-6040 \ Customer Service: 1-877-623-6748
Internet: www.ncwaterquality.org

An Equal Opportunity \ Affirmative Action Employer - 50% Recycled/10% Post Consumer paper

One
North Carolina
Naturally

Dr. Gregory Thorpe, Ph.D.
Page Two

Existing stream dimensions (including pattern and profile) are to be maintained above and below locations of each culvert. The applicant may be required to provide evidence that the equilibrium has been maintained, if requested in writing by the DWQ. If this condition is unable to be met due to bedrock or other limiting features encountered during construction, please contact the DWQ for guidance on how to proceed and to determine whether or not a modification to this certification will be required.

2. The use of riprap above the normal high water mark shall be minimized. Any riprap placed for stream stabilization shall be placed in stream channels in such a manner that it does not impede aquatic life passage.
3. All portions of the proposed project draining to 303(d) listed watersheds that are impaired due to turbidity shall be designed, constructed, and operated with sediment and erosion control measures that meet Design Standards in Sensitive Watersheds [15A NCAC 4B .0124]. However, due to the size of the project, NC DOT shall not be required to meet 15A NCAC 4B .0124(a) regarding the maximum amount of uncovered acres.
4. The slope of the proposed culvert was not provided in the Pre-Construction Notification application. Based on the site visit, it appears that the slope may be substantial enough to cause scour at the outlet end of the culvert. NCDOT is advised that if stream destabilization occurs due to a steep slope on the culvert (exceeding 3-4%), DWQ may require corrective actions to ensure stream stability.
5. Heavy equipment shall be operated from the banks rather than in the stream channel in order minimize sedimentation and reduce the introduction of other pollutants into the stream.
6. No rock, sand or other materials shall be dredged from the stream channel except where authorized by this certification.
7. Temporary dewatering sites must be restored to pre-existing conditions unless more natural geomorphic conditions can be provided.
8. If concrete is used during construction, a dry work area should be maintained to prevent direct contact between curing concrete and stream water. Water that inadvertently contacts uncured concrete should not be discharged to surface waters due to the potential for elevated pH and possible aquatic life and fish kills.
9. All work in or adjacent to stream waters shall be conducted in a dry work area. Approved BMP measures from the most current version of the NCDOT Construction and Maintenance Activities manual such as sandbags, rock berms, cofferdams and other diversion structures shall be used to prevent excavation in flowing water.
10. The dimension, pattern and profile of the stream above and below the crossing should not be modified. Disturbed floodplains and streams should be restored to natural geomorphic conditions.
11. All mechanized equipment operated near surface waters must be regularly inspected and maintained to prevent contamination of stream waters from fuels, lubricants, hydraulic fluids, or other toxic materials.
12. All fill slopes located in jurisdictional wetlands shall be placed at slopes no flatter than 3:1, unless otherwise authorized by this certification.
13. Discharging hydroseed mixtures and washing out hydroseeders and other equipment in or adjacent to surface waters is prohibited.

14. A copy of this Water Quality Certification shall be posted on the construction site at all times. In addition, the Water Quality Certification and all subsequent modifications, if any, shall be maintained with the Division Engineer and the on-site project manager.
15. Native riparian vegetation must be re-established within the construction limits of the project by the end of the growing season following completion of construction.
16. Sediment and erosion control measures shall not be placed in wetlands or waters to the maximum extent practicable. If placement of sediment and erosion control devices in wetlands and waters is unavoidable, they shall be removed and the natural grade restored within 30 days after the Division of Land Resources has released the project.
17. Erosion and sediment control practices must be in full compliance with all specifications governing the proper design, installation and operation and maintenance of such Best Management Practices in order to protect surface waters standards:
 - a. The erosion and sediment control measures for the project must be designed, installed, operated, and maintained in accordance with the most recent version of the *North Carolina Sediment and Erosion Control Planning and Design Manual*.
 - b. The design, installation, operation, and maintenance of the sediment and erosion control measures must be such that they equal, or exceed, the requirements specified in the most recent version of the *North Carolina Sediment and Erosion Control Manual*. The devices shall be maintained on all construction sites, borrow sites, and waste pile (spoil) projects, including contractor-owned or leased borrow pits associated with the project.
 - c. For borrow pit sites, the erosion and sediment control measures must be designed, installed, operated, and maintained in accordance with the most recent version of the *North Carolina Surface Mining Manual*.
 - d. The reclamation measures and implementation must comply with the reclamation in accordance with the requirements of the Sedimentation Pollution Control Act.
18. The Permittee shall ensure that the final design drawings adhere to the certification and to the drawings submitted for approval.
19. The outside buffer, wetland or water boundary located within the construction corridor approved by this certification shall be clearly marked by highly visible fencing prior to any land disturbing activities. Impacts to areas within the fencing are prohibited unless otherwise authorized by this certification.
20. The Permittee shall report any violations of this certification to the Division of Water Quality within 24 hours of discovery.
21. The North Carolina Department of Transportation (NCDOT) and its contractors and/or agents shall not excavate, fill or perform mechanized land clearing at any time in the construction or maintenance of this project within waters and/or wetlands, except as authorized by this Certification, or any modification to this Certification (e.g., no work shall occur outside of the footprint of the plans provided). In addition, there shall be no excavation from or waste disposal into jurisdictional wetlands or waters associated with this Certification without appropriate modification. If this occurs, compensatory mitigation may be required since it is a direct impact from road construction activities.

Dr. Gregory Thorpe, Ph.D.
Page Four

- * 22. Upon completion of the project, the NCDOT Division Engineer shall complete and return the enclosed "Certificate of Completion" form to notify DWQ when all work included in the 401 Certification has been completed. Please include photographs upstream and downstream of the structure to document correct installation.
23. Continuing Compliance. NCDOT shall conduct its activities in a manner so as not to contravene any state water quality standard [including any requirements for compliance with section 303(d) of the Clean Water Act] and any other appropriate requirements of state and federal law. If DWQ determines that such standards or laws are not being met (including the failure to sustain a designated or achieved use) or that state or federal law is being violated, or that further conditions are necessary to assure compliance, DWQ may reevaluate and modify this certification to include conditions appropriate to assure compliance with such standards and requirements in accordance with 15 A NCAC 2H.0507(d). Before codifying the certification, DWQ shall notify NCDOT and the USACE, provide public notice in accordance with 15A NCAC 2H.0503, and provide opportunity for public hearing in accordance with 15A NCAC 2H.0504. Any new or revised conditions shall be provided to NCDOT in writing, shall be provided to the USACE for reference in any permit issued pursuant to Section 404 of the Clean Water Act, and shall also become conditions of the 404 Permit for the project.

If you do not accept any of the conditions of this Certification, you may ask for an adjudicatory hearing. You must act within 60 days of the date that you receive this letter. To ask for a hearing, send a written petition that conforms to Chapter 150B of the North Carolina General Statutes to the Office of Administrative Hearings, 6714 Mail Service Center, Raleigh, N.C. 27699-6714. This Certification and its conditions are final and binding unless you ask for a hearing.

This letter completes the review by the Division of Water Quality under Section 401 of the Clean Water Act. If you have any questions, please telephone Polly Lespinasse in the Mooresville Regional Office at 704-663-1699.

Sincerely,



for Coleen H. Sullins

Attachments

cc: Steve Lund, USACE Asheville Field Office
Sonia Gregory, DWQ Wetlands Unit
File Copy

Water Quality Certification N^o. 3704

GENERAL CERTIFICATION FOR PROJECTS ELIGIBLE FOR U.S. ARMY CORPS OF ENGINEERS NATIONWIDE PERMIT NUMBER 14 (LINEAR TRANSPORTATION PROJECTS) AND REGIONAL GENERAL PERMIT 198200031 (WORK ASSOCIATED WITH BRIDGE CONSTRUCTION, MAINTENANCE OR REPAIR CONDUCTED BY NCDOT OR OTHER GOVERNMENT AGENCIES) AND RIPARIAN AREA PROTECTION RULES (BUFFER RULES)

Water Quality Certification Number 3704 is issued in conformity with the requirements of Section 401, Public Laws 92-500 and 95-217 of the United States and subject to the North Carolina Division of Water Quality (DWQ) Regulations in 15A NCAC 2H, Section .0500 and 15A NCAC 2B .0200 for the discharge of fill material to waters and adjacent wetland areas or to wetland areas that are not a part of the surface tributary system to interstate waters or navigable waters of the United States (as described in 33 CFR 330 Appendix A (B) (14) of the Corps of Engineers regulations (Nationwide Permit No. 14 and Regional General Permit 198200031) and for the Riparian Area Protection Rules (Buffer Rules) in 15A NCAC 2B .0200.

The State of North Carolina certifies that the specified category of activity will not violate applicable portions of Sections 301, 302, 303, 306 and 307 of the Public Laws 92-500 and 95-217 if conducted in accordance with the conditions hereinafter set forth.

- * Any proposed fill or modification of wetlands and/or waters, including streams, under this General Certification requires application to, and written approval from the Division of Water Quality (the "Division") except for the single family lot exemption described below.

Application and written approval is *not required* for construction of a driveway to a single family lot as long as the driveway involves *less than 25 feet* of temporary and/or permanent stream channel impacts, including any in-stream stabilization needed for the crossing. This activity must meet all of the Conditions of Certification listed below. If any of these Conditions cannot be met, **or if the activity is associated with or in response to a Notice of Violation from the Division of Water Quality or the NC Division of Land Resources, then written approval from the Division is required.**

- * In accordance with North Carolina General Statute Section 143-215.3D(e), written approval for a 401 Water Quality General Certification must include the appropriate fee. If a project also requires a CAMA Permit, one payment to both agencies shall be submitted and will be the higher of the two fees.

Conditions of Certification:

1. No Impacts Beyond those Authorized in the Written Approval or Beyond the Threshold for Use of this Certification

No waste, spoil, solids, or fill of any kind shall occur in wetlands, waters, or riparian areas beyond the footprint of the impacts authorized in the written approval or beyond the thresholds for use of this Certification, including incidental impacts. All construction activities, including the design, installation, operation, and maintenance of sediment and erosion control Best Management Practices, shall be performed so that no violations of state water quality standards, statutes, or rules occur.

2. Standard Erosion and Sediment Control Practices

Erosion and sediment control practices must be in full compliance with all specifications governing the proper design, installation and operation and maintenance of such Best Management Practices:

236
Water Quality Certification N^o. 3704

- a. Design, installation, operation, and maintenance of the sediment and erosion control measures must be such that they equal, or exceed, the requirements specified in the most recent version of the *North Carolina Sediment and Erosion Control Manual*. The devices shall be maintained on all construction sites, borrow sites, and waste pile (spoil) projects, including contractor-owned or leased borrow pits associated with the project.
 - b. For borrow pit sites, the erosion and sediment control measures must be designed, installed, operated, and maintained in accordance with the most recent version of the *North Carolina Surface Mining Manual*.
 - c. Reclamation measures and implementation must comply with the reclamation in accordance with the requirements of the Sedimentation Pollution Control Act and the Mining Act of 1971.
 - d. Sufficient materials required for stabilization and/or repair of erosion control measures and stormwater routing and treatment shall be on site at all times, except for publicly funded linear transportation projects when materials can be accessed offsite in a timely manner.
 - e. If the project occurs in waters or watersheds classified as Primary Nursery Areas (PNA's), Trout (Tr), SA, WS-I, WS-II, High Quality (HQW), or Outstanding Resource (ORW) waters, then the sediment and erosion control requirements contained within *Design Standards in Sensitive Watersheds* (15A NCAC 04B .0124) supercede all other sediment and erosion control requirements.
3. No Sediment and Erosion Control Measures in Wetlands or Waters

Sediment and erosion control measures should not be placed in wetlands or waters outside of the permitted impact areas without prior approval by the Division. If placement of sediment and erosion control devices in wetlands and waters is unavoidable, design and placement of temporary erosion control measures shall not be conducted in a manner that may result in dis-equilibrium of wetlands or stream beds or banks, adjacent to or upstream and down stream of the above structures. All sediment and erosion control devices shall be removed and the natural grade restored within two (2) months of the date that the Division of Land Resources or locally delegated program has released the project.

4. Construction Stormwater Permit NCG010000

Upon the approval of an Erosion and Sedimentation Control Plan issued by the Division of Land Resources (DLR) or a DLR delegated local erosion and sedimentation control program, an NPDES General stormwater permit (NCG010000) administered by the Division is automatically issued to the project. This General Permit allows stormwater to be discharged during land disturbing construction activities as stipulated by conditions in the permit. If your project is covered by this permit [applicable to construction projects that disturb one (1) or more acres], full compliance with permit conditions including the sedimentation control plan, self-monitoring, record keeping and reporting requirements are required. A copy of this permit and monitoring report forms may be found at http://h2o.enr.state.nc.us/su/Forms_Documents.htm.

The North Carolina Department of Transportation (NCDOT) shall be required to be in full compliance with the conditions related to construction activities within the most recent version of their individual NPDES (NCS000250) stormwater permit.

Water Quality Certification N°. 3704

5. Work in the Dry

All work in or adjacent to stream waters shall be conducted in a dry work area. Approved best management practices from the most current version of the NC Sediment and Erosion Control Manual, or the NC DOT Construction and Maintenance Activities Manual, such as sandbags, rock berms, cofferdams, and other diversion structures shall be used to minimize excavation in flowing water. Exceptions to this condition require submittal to, and approval by, the Division of Water Quality.

6. Construction Moratoriums and Coordination

If activities must occur during periods of high biological activity (i.e. sea turtle or bird nesting), then biological monitoring may be required at the request of other state or federal agencies and coordinated with these activities. This condition can be waived through written concurrence on a case-by-case basis upon reasonable justification.

All moratoriums on construction activities established by the NC Wildlife Resources Commission (WRC), US Fish and Wildlife Service (USFWS), NC Division of Marine Fisheries (DMF), or National Marine Fisheries Service (NMFS) to lessen impacts on trout, anadromous fish, larval/post-larval fishes and crustaceans, or other aquatic species of concern shall be implemented. This condition can be waived through written concurrence on a case-by-case basis upon reasonable justification.

Work within the twenty-five (25) designated trout counties or identified state or federal endangered or threatened species habitat shall be coordinated with the appropriate WRC, USFWS, NMFS, and/or DMF personnel.

7. Riparian Area Protection (Buffer) Rules

Activities located in the protected 50-foot wide riparian areas (whether jurisdictional wetlands or not), within the Neuse, Tar-Pamlico, Catawba, or Randleman (or any other basin with buffer rules), shall be limited to "uses" identified within and constructed in accordance with 15A NCAC 2B .0233, .0259, .0250 and .0243, and shall be located, designed, constructed, and maintained to have minimal disturbance to protect water quality to the maximum extent practicable through the use of best management practices. All buffer rule requirements, including diffuse flow requirements, must be met.

8. Water Supply Watershed Buffers

The 100-foot wide vegetative buffer (high-density development) or the 30-foot wide vegetative buffer (low density development) shall be maintained adjacent to all perennial waters except for allowances as provided in the Water Supply Watershed Protection Rules [15A NCAC 2B .0212 through .0215].

9. If concrete is used during the construction, then a dry work area should be maintained to prevent direct contact between curing concrete and stream water. Water that inadvertently contacts uncured concrete should not be discharged to surface waters due to the potential for elevated pH and possible aquatic life/fish kills.

* 10. Compensatory Mitigation

In accordance with 15A NCAC 2H .0506 (h), compensatory mitigation may be required for losses of 150 linear feet or more of streams and/or one (1) acre or more of wetlands. For linear, public transportation projects, impacts equal to or exceeding 150 linear feet per stream may require mitigation.

Water Quality Certification N^o. 3704

In watersheds classified as: ORW, HQW, Tr, WS-I, and WS-II, compensatory stream mitigation may be required at a 1:1 ratio for not only perennial but also intermittent stream impacts equal to or exceeding 150 feet, unless the project is a linear, publicly-funded transportation project, which has a 150-foot per-stream impact allowance. Buffer mitigation may be required for any project with Buffer Rules in effect at the time of application for buffer impacts resulting from activities classified as "Allowable with Mitigation" within the Buffer Rules or require a variance under the Buffer Rules.

A determination of buffer, wetland and stream mitigation requirements shall be made by the Division for any application to use this Certification. Design and monitoring protocols shall follow the US Army Corps of Engineers Wilmington District *Stream Mitigation Guidelines* (April 2003), or its subsequent updates. Compensatory mitigation plans shall be submitted for written Division approval as required in those protocols. Alternatively, the Division will accept payment into an in-lieu fee program or credit purchase from a mitigation bank.

* Finally, the mitigation plan must be implemented and/or constructed before any permanent building or structure on site is occupied. In the case of public road projects, the mitigation plan must be implemented before the road is opened to the public whenever practical or at the earliest reasonable time during the construction of the project. Proof of payment to an in-lieu fee program or mitigation bank must be provided to the Division to satisfy this requirement.

11. For all activities requiring re-alignment of streams, a stream relocation plan must be included for written Division approval. Relocated stream designs should include the same dimensions, patterns and profiles as the existing channel (or a stable reference reach if the existing channel is unstable), to the maximum extent practical. The new channel should be constructed in the dry and water shall not be turned into the new channel until the banks are stabilized. Vegetation used for permanent bank stabilization shall be limited to native woody species, and should include establishment of a 30-foot wide wooded and an adjacent 20-foot wide vegetated buffer on both sides of the relocated channel to the maximum extent practical. A transitional phase incorporating appropriate erosion control matting materials and seedling establishment is allowable. Rip-rap, A-Jacks, concrete, gabions or other hard structures may be allowed if it is necessary to maintain the physical integrity of the stream, however, the applicant must provide written justification and any calculations used to determine the extent of rip-rap coverage. Please note that if the stream relocation is conducted as a stream restoration as defined in the US Army Corps of Engineers Wilmington District, April 2003 *Stream Mitigation Guidelines*, the restored length can be used as compensatory mitigation for the impacts resulting from the relocation.

12. Stormwater Management Plan Requirements

- A. For applicants other than the North Carolina Department of Transportation, a Stormwater Management Plan in accordance with the version of *Stormwater Management Plan (SMP) Requirements for Applicants other than the North Carolina Department of Transportation* posted on the Division web site at the time of application shall be provided for any project that meets both of the following two criteria:
 - i. Requires this 401 Water Quality Certification, (regardless of whether written authorization is required by the Division), AND

Water Quality Certification N^o. 3704

- ii. Contains one or more drainage areas that are anticipated to have impervious surface cover of equal to or greater than 24 percent. When drainage areas are difficult to delineate or when a pocket of high density exists within a drainage area, the Division shall use best professional judgment to apply the SMP requirement as appropriate. Use of this Certification to construct a private driveway to one single-family residential lot will not trigger the stormwater management plan requirement.

B. For the North Carolina Department of Transportation, compliance with NCDOT's Individual NPDES permit NCS000250 shall serve to satisfy this condition.

13. If this Water Quality Certification is used to access building sites, all lots owned by the applicant must be buildable without additional fill. For road construction purposes, this General Water Quality Certification shall only be utilized from natural high ground to natural high ground.

14. Placement of Culverts and Other Structures in Waters and Wetlands

The application must include construction plans with cross-sectional details in order to indicate that the current stability of the stream will be maintained or enhanced (i.e., not result in head cuts).

Culverts required for this project shall be designed and installed in such a manner that the original stream profiles are not altered and allow for aquatic life movement during low flows. Existing stream dimensions (including the cross section dimensions, pattern, and longitudinal profile) must be maintained above and below locations of each culvert. Placement of culverts and other structures in waters, streams, and wetlands must be placed below the elevation of the streambed by one foot for all culverts with a diameter greater than 48 inches, and 20 percent of the culvert diameter for culverts having a diameter less than or equal to 48 inches, to allow low flow passage of water and aquatic life unless otherwise justified and approved by the Division

Installation of culverts in wetlands must ensure continuity of water movement and be designed to adequately accommodate high water or flood conditions. Additionally, when roadways, causeways or other fill projects are constructed across FEMA-designated floodways or wetlands, openings such as culverts or bridges must be provided to maintain the natural hydrology of the system as well as prevent constriction of the floodway that may result in destabilization of streams or wetlands.

Any rip rap required for normal pipe burial and stabilization shall be buried such that the original stream elevation is restored and maintained.

The establishment of native, woody vegetation and other soft stream bank stabilization techniques must be used where practicable instead of rip-rap or other bank hardening methods.

15. Additional site-specific conditions may be added to the written approval in order to ensure compliance with all applicable water quality and effluent standards.

- * 16. If an environmental document is required under the National or State Environmental Policy Act (NEPA or SEPA), then this General Certification is not valid until a Finding of No Significant Impact (FONSI) or Record of Decision (ROD) is issued by the State Clearinghouse.

Water Quality Certification N^o. 3704

17. Deed notifications or similar mechanisms shall be placed on all retained jurisdictional wetlands, waters and protective buffers in order to assure compliance for future wetland, water and buffer impact. These mechanisms shall be put in place at the time of recording of the property, or of individual lots, whichever is appropriate. A sample deed notification can be downloaded from the 401/Wetlands Unit web site at <http://h2o.enr.state.nc.us/ncwetlands>. The text of the sample deed notification may be modified as appropriate to suit to a specific project.

* 18. Certificate of Completion

When written authorization is required for use of this certification, upon completion of all permitted impacts included within the approval and any subsequent modifications, the applicant shall be required to return the certificate of completion attached to the approval. One copy of the certificate shall be sent to the DWQ Central Office in Raleigh at 1650 Mail Service Center, Raleigh, NC, 27699-1650.

19. This General Certification shall expire three (3) years from the date of issuance of the written approval from the Division or on the same day as the expiration date of the corresponding Nationwide Permit 14 or Regional General Permit 198200031. In accordance with General Statute 136-44.7B, certifications issued to the NCDOT shall expire only upon expiration of the federal 404 Permit. The conditions in effect on the date of issuance of Certification for a specific project shall remain in effect for the life of the project, regardless of the expiration date of this Certification. If the construction process for approved activities will overlap the expiration and renewal date of the corresponding 404 Permit and the Corps allows for continued use of the 404 Permit, then the General Certification shall also remain in effect without requiring re-application and re-approval to use this Certification for the specific impacts already approved.

20. The applicant/permittee and their authorized agents shall conduct all activities in a manner consistent with State water quality standards (including any requirements resulting from compliance with §303(d) of the Clean Water Act), and any other appropriate requirements of State and Federal Law. If the Division determines that such standards or laws are not being met, including failure to sustain a designated or achieved use, or that State or Federal law is being violated, or that further conditions are necessary to assure compliance, then the Division may reevaluate and modify this General Water Quality Certification.

Non-compliance with or violation of the conditions herein set forth by a specific fill project may result in revocation of this Certification for the project and may also result in criminal and/or civil penalties.

The Director of the North Carolina Division of Water Quality may require submission of a formal application for Individual Certification for any project in this category of activity, if it is determined that the project is likely to have a significant adverse effect upon water quality including state or federally listed endangered or threatened aquatic species or degrade the waters so that existing uses of the wetland or downstream waters are precluded.

Public hearings may be held for specific applications or group of applications prior to a Certification decision if deemed in the public's best interest by the Director of the North Carolina Division of Water Quality.

241

Water Quality Certification N°. 3704

Effective date: November 1, 2007

DIVISION OF WATER QUALITY

By

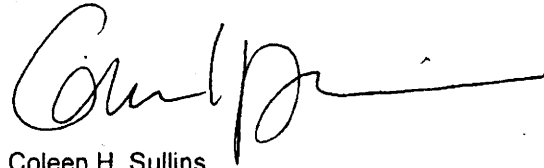
A handwritten signature in black ink, appearing to read 'Coleen H. Sullins', with a long horizontal line extending to the right.

Coleen H. Sullins

Director

History Note: Water Quality Certification Number 3704 replaces Water Quality Certification Number 2177 issued on November 5, 1987; Water Quality Certification Number 2666 issued on January 21, 1992; Water Quality Certification Number 2732 issued on May 1, 1992; Water Quality Certification Number 3103 issued on February 11, 1997; Water Quality Certification Number 3289 issued on June 1, 2000; Water Quality Certification Number 3375 issued March 18, 2002, Water Quality Certification Number 3404 issued March 2003 and Water Quality Certification Number 3627 issued March 2007. This WQC is rescinded when the Corps of Engineers re-authorizes Nationwide Permit 14 or Regional General Permit 198200031 or when deemed appropriate by the Director of the Division of Water Quality.

STATE OF NORTH CAROLINA
DIVISION OF HIGHWAYS

MECKLENBURG COUNTY

LOCATION: SR 2804 (REEDY CREEK RD.) AND
SR 2805 (HARRISBURG RD.); INTERSECTION
REALIGNMENT
TYPE OF WORK: GRADING, PAVING, DRAINAGE AND SIGNAL
WETLANDS SURFACE WATER IMPACTS

See Sheet 1-A For Index of Streets
See Sheet 1-B For Conventional Symbols

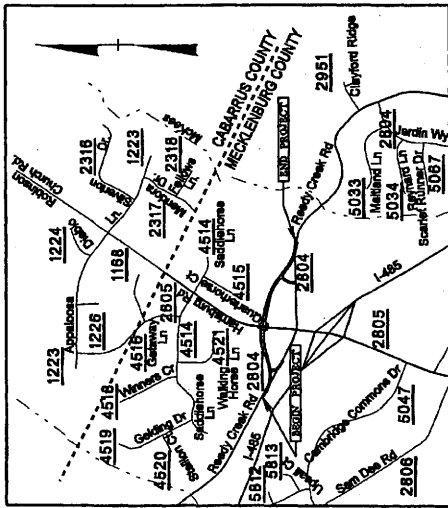

VICINITY MAP

NO. PROJECT	U-4401
NO. SHEET	1
DATE	
DESIGNED BY	P.E. RWT/UTL
CHECKED BY	P.E. RWT/UTL
DATE	
APPROVED BY	
DATE	

242

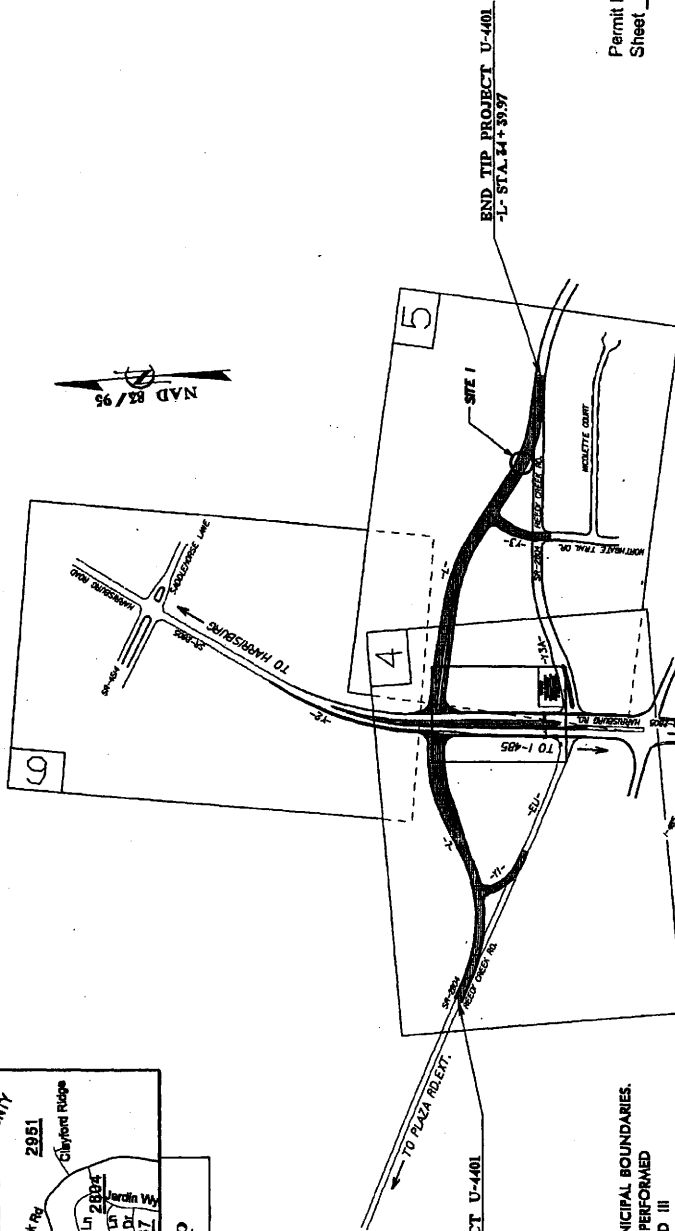

Permit Drawing
Sheet 1 of 1

NOTES: 1.) THIS PROJECT IS NOT WITHIN ANY MUNICIPAL BOUNDARIES.
2.) CLEARING ON THIS PROJECT SHALL BE PERFORMED TO THE LIMITS ESTABLISHED BY METHOD III

DIVISION OF HIGHWAYS
STATE OF NORTH CAROLINA

HYDRAULICS ENGINEER

PROJECT ENGINEER
ROADWAY DESIGN ENGINEER
PRELIMINARY PLANS
DO NOT USE FOR CONSTRUCTION

Prepared in the Office of
DIVISION OF HIGHWAYS
1000 BIRCH BLVD., S.W.
RALEIGH, NC 27615

RIGHT OF WAY DATE:
NOT AUTHORIZED

DESIGNED BY:
ROGER D. THOMAS, P.E.
PROJECT ENGINEER

DATE:
JANUARY 19, 2010

APPROVED BY:
MICHAEL W. LITTLE, P.E.
PROJECT DESIGN ENGINEER

PROJECT LENGTH

LENGTH ROADWAY TIP PROJECT U-4401 = 0.462 MI.
TOTAL LENGTH OF TIP PROJECT U-4401 = 0.462 MI.

DESIGN DATA

ADT 2007 = 12,500
ADT 2030 = 21,400
DHW = 12 %
D = 55 %
T = 3 %
V = 40 MPH
FUNC. CLASS. = LOCAL
* TRST 1% DUAL 2%

GRAPHIC SCALES

50' 25' 0' 100'
PLANS

50' 25' 0' 100'
PROFILE (HORIZONTAL)

10' 5' 0' 10' 20'
PROFILE (VERTICAL)

TIP PROJECT: U-4401

CONTRACT:

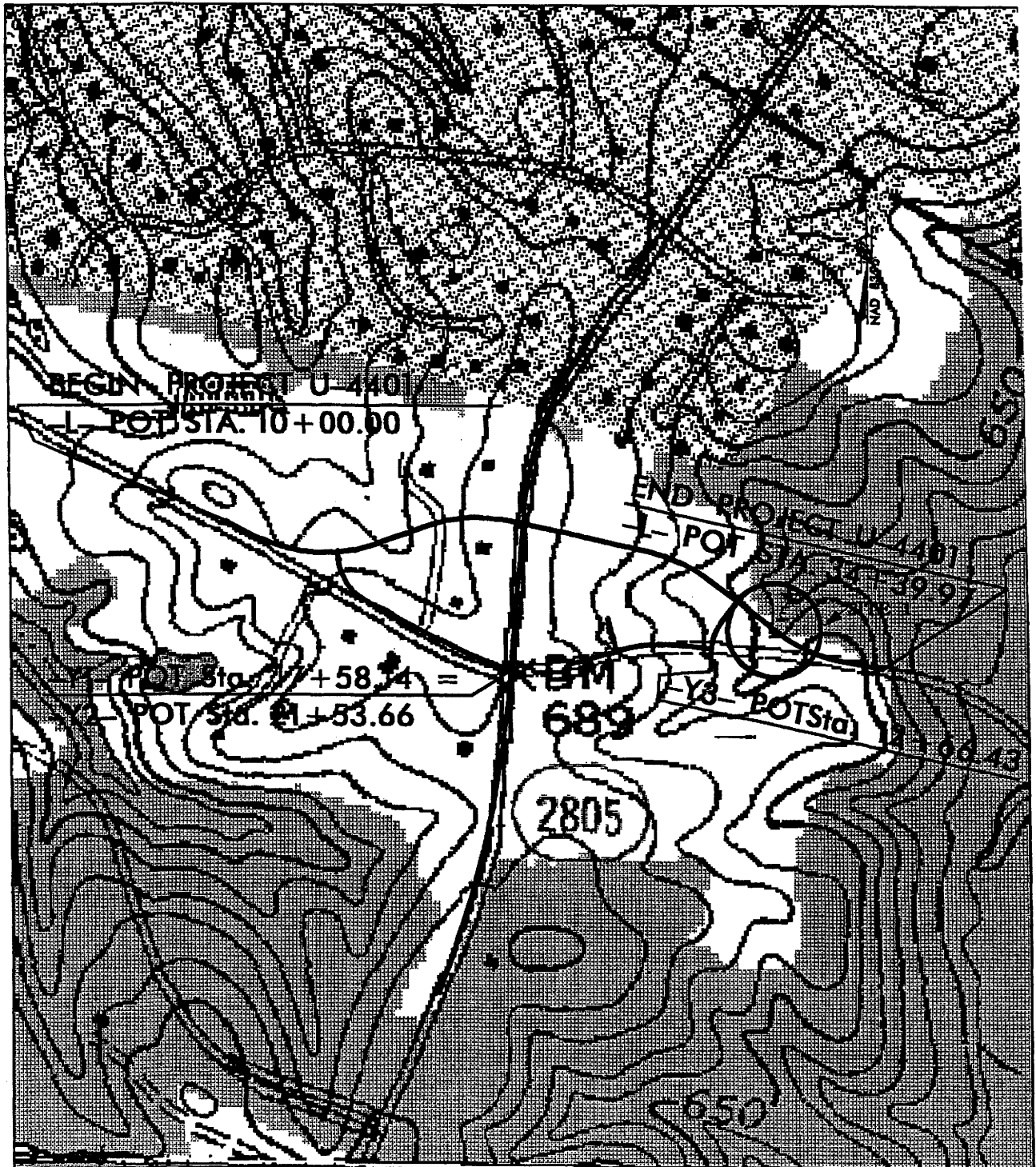

PLAN VIEW

1" = 2400 FT.

Permit Drawing
Sheet 2 of 7

NCDOT

DIVISION OF HIGHWAYS
MECKLENBURG COUNTY
PROJECT: 36774.1.1 (U-4401)

SR 2804 (REEDY CREEK RD)
and SR 2805 (HARRISBURG RD)
INTERSECTION REALIGNMENT
SURFACE WATER IMPACTS

WETLAND PERMIT IMPACT SUMMARY

Site No.	Station (From/To)	Structure Size / Type	WETLAND IMPACTS						SURFACE WATER IMPACTS			
			Permanent Fill In Wetlands (ac)	Temp. Fill In Wetlands (ac)	Excavation in Wetlands (ac)	Mechanized Clearing in Wetlands (ac)	Hand Clearing in Wetlands (ac)	Permanent SW Impacts (ac)	Temp. SW Impacts (ac)	Existing Channel Impacts Permanent (ft)	Existing Channel Impacts Temp. (ft)	Natural Stream Design (ft)
1	-L- Sta. 30+00- 30+23 Lt.	36" CSP						0.01	<0.01	67	12	
TOTALS:								0.01	0.00	67	12	

Permit Drawing
Sheet 4 of 7

NC DEPARTMENT OF TRANSPORTATION
DIVISION OF HIGHWAYS
MECKLENBURG COUNTY
WBS - 36774.1.1 (U-440.1)
5/27/2009

ATN Revised 3/3/05

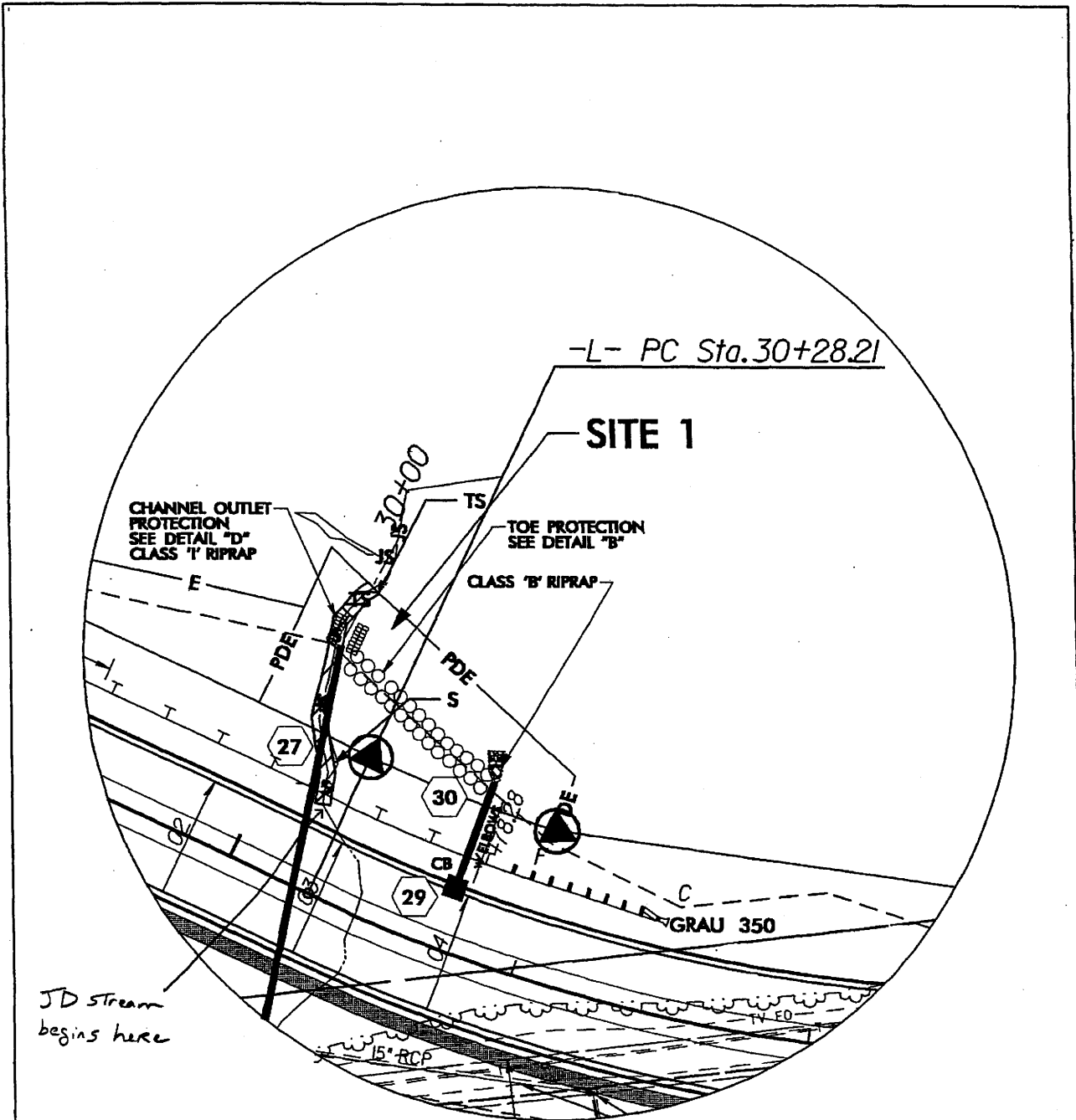

Permit Drawing
Sheet 5 of 7

PLAN VIEW ENLARGEMENT, SITE 1

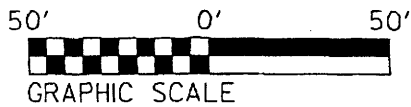

NCDOT
 DIVISION OF HIGHWAYS
 MECKLENBURG COUNTY
 PROJECT: 36774.1.1 (U-440)
 SR 2804 (REEDY CREEK RD)
 and SR 2805 (HARRISBURG RD)
 INTERSECTION REALIGNMENT
 WETLAND/SURFACE WATER IMPACTS

SHEET OF 05 / 26 / 09

PROJECT REFERENCE NO.	U-440
SHEET NO.	5
BY	HYDRAULICS ENGINEER
CHECKED BY	HYDRAULICS ENGINEER
DATE	11/23/07

BRADFELD FARMS HOMEOWNERS ASSOCIATION, INC. 10000 PO BOX 247

PERMITTING & PLAN REVIEW

BRUCE MCALLISTER
WELISSA MCALLISTER
DATE FOR PERMITS

MARY L. LIEVA
HELEN D. HORN
DATE FOR PERMITS

MICHAEL SCOTT BENNETT
STACY L. BENNETT
DATE FOR PERMITS

ELIJAH STEWART
DATE FOR PERMITS

MARIA R. SOUBLET
DATE FOR PERMITS

MICHAEL D. SEASH
VALERIE D. SEASH
DATE FOR PERMITS

ROBERT J. MERITHEW
HONORA MERITHEW
DATE FOR PERMITS

CHRISTOPHER CAMPBELL
HARRIET D. STEELE
DATE FOR PERMITS

DENNIS M. BALLAS
DATE FOR PERMITS

WILLIAM JR. BROWN JR.
LATASHA L. BROWN
DATE FOR PERMITS

RYAN A. BARRIS
ANASHA Y. BARRIS
DATE FOR PERMITS

BRADFELD FARMS HOMEOWNERS ASSOCIATION, INC. 10000 PO BOX 247

-1- CURVE DATA
P/SW 34+62.23
Δ = 27.37 27.37 (U7)
D = 27.37 27.37
L = 14.44
R = 500.00
SE = SEE PLANS

-2- CURVE DATA
P/SW 34+62.23
Δ = 27.37 27.37 (U7)
D = 27.37 27.37
L = 14.44
R = 500.00
SE = SEE PLANS

-3- CURVE DATA
P/SW 34+62.23
Δ = 27.37 27.37 (U7)
D = 27.37 27.37
L = 14.44
R = 500.00
SE = SEE PLANS

-4- CURVE DATA
P/SW 34+62.23
Δ = 27.37 27.37 (U7)
D = 27.37 27.37
L = 14.44
R = 500.00
SE = SEE PLANS

-5- ENLARGEMENT
SEE ENLARGEMENT

-6- ENLARGEMENT
SEE ENLARGEMENT

-7- ENLARGEMENT
SEE ENLARGEMENT

-8- ENLARGEMENT
SEE ENLARGEMENT

-9- ENLARGEMENT
SEE ENLARGEMENT

-10- ENLARGEMENT
SEE ENLARGEMENT

-11- CURVE DATA
P/SW 34+62.23
Δ = 27.37 27.37 (U7)
D = 27.37 27.37
L = 14.44
R = 500.00
SE = SEE PLANS

-12- CURVE DATA
P/SW 34+62.23
Δ = 27.37 27.37 (U7)
D = 27.37 27.37
L = 14.44
R = 500.00
SE = SEE PLANS

-13- CURVE DATA
P/SW 34+62.23
Δ = 27.37 27.37 (U7)
D = 27.37 27.37
L = 14.44
R = 500.00
SE = SEE PLANS

-14- CURVE DATA
P/SW 34+62.23
Δ = 27.37 27.37 (U7)
D = 27.37 27.37
L = 14.44
R = 500.00
SE = SEE PLANS

-15- CURVE DATA
P/SW 34+62.23
Δ = 27.37 27.37 (U7)
D = 27.37 27.37
L = 14.44
R = 500.00
SE = SEE PLANS

-16- CURVE DATA
P/SW 34+62.23
Δ = 27.37 27.37 (U7)
D = 27.37 27.37
L = 14.44
R = 500.00
SE = SEE PLANS

-17- CURVE DATA
P/SW 34+62.23
Δ = 27.37 27.37 (U7)
D = 27.37 27.37
L = 14.44
R = 500.00
SE = SEE PLANS

-18- CURVE DATA
P/SW 34+62.23
Δ = 27.37 27.37 (U7)
D = 27.37 27.37
L = 14.44
R = 500.00
SE = SEE PLANS

-19- CURVE DATA
P/SW 34+62.23
Δ = 27.37 27.37 (U7)
D = 27.37 27.37
L = 14.44
R = 500.00
SE = SEE PLANS

-20- CURVE DATA
P/SW 34+62.23
Δ = 27.37 27.37 (U7)
D = 27.37 27.37
L = 14.44
R = 500.00
SE = SEE PLANS

-21- CURVE DATA
P/SW 34+62.23
Δ = 27.37 27.37 (U7)
D = 27.37 27.37
L = 14.44
R = 500.00
SE = SEE PLANS

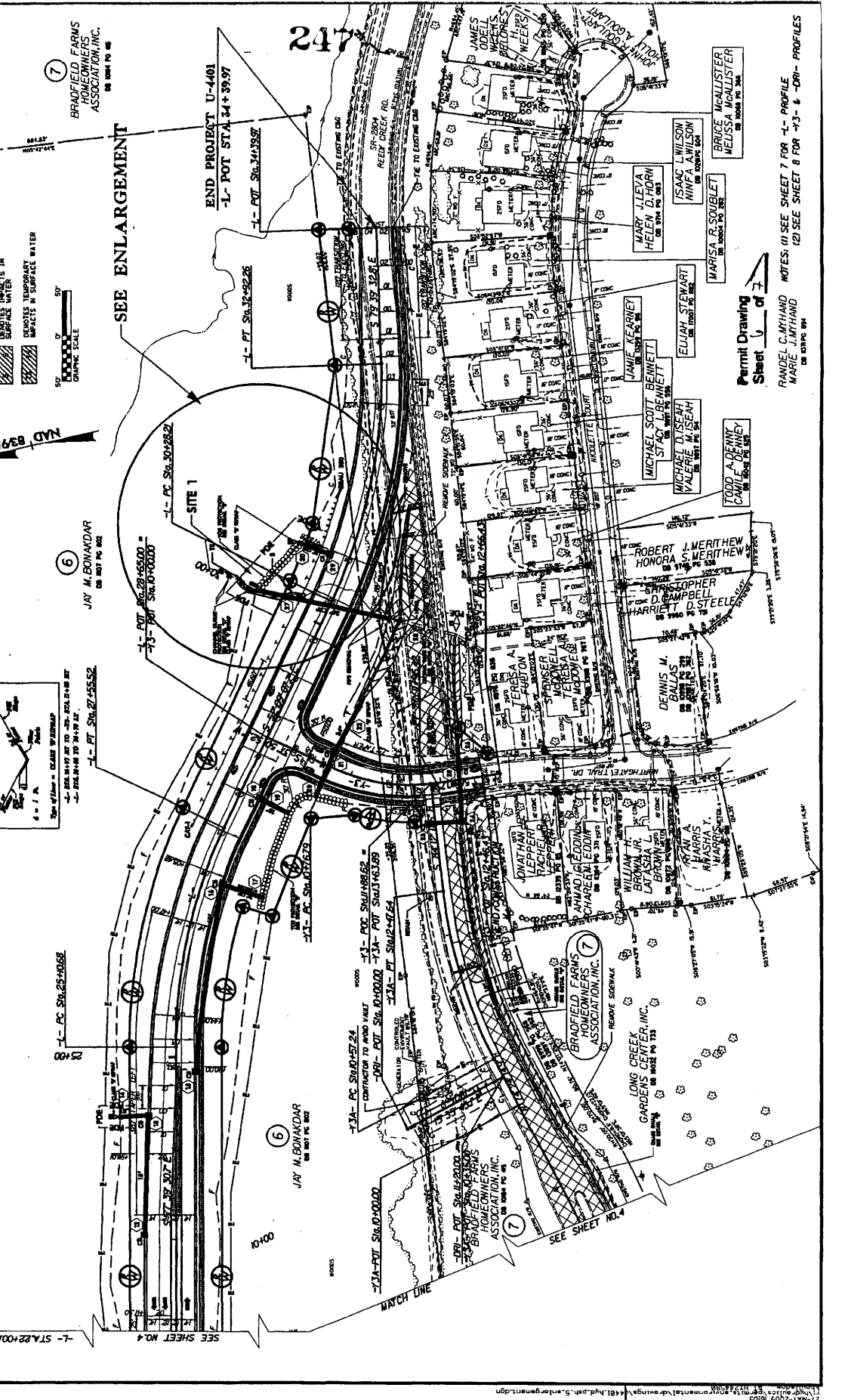

BRADFELD FARMS HOMEOWNERS ASSOCIATION, INC.
10000 PO BOX 247

LONG CREEK GARDENS CENTER, INC.
10000 PO BOX 247

PERMIT DRAWING
Sheet 5 of 7

NOTES: (1) SEE SHEET 7 FOR -1- PROFILE
(2) SEE SHEET 8 FOR -13- & -19- PROFILES

BRUCE MCALLISTER
WELISSA MCALLISTER
DATE FOR PERMITS

MARY L. LIEVA
HELEN D. HORN
DATE FOR PERMITS

MICHAEL SCOTT BENNETT
STACY L. BENNETT
DATE FOR PERMITS

ELIJAH STEWART
DATE FOR PERMITS

MARIA R. SOUBLET
DATE FOR PERMITS

MICHAEL D. SEASH
VALERIE D. SEASH
DATE FOR PERMITS

ROBERT J. MERITHEW
HONORA MERITHEW
DATE FOR PERMITS

CHRISTOPHER CAMPBELL
HARRIET D. STEELE
DATE FOR PERMITS

DENNIS M. BALLAS
DATE FOR PERMITS

WILLIAM JR. BROWN JR.
LATASHA L. BROWN
DATE FOR PERMITS

RYAN A. BARRIS
ANASHA Y. BARRIS
DATE FOR PERMITS

BRADFELD FARMS HOMEOWNERS ASSOCIATION, INC. 10000 PO BOX 247

R/W REV - PARCEL 7 - REDUCE PDE TO ADD SIGN - NWL - 5/30/08

REVISIONS

21-Nov-2009 06:55
11-Nov-2009 11:11
11-Nov-2009 11:11

PROJECT REFERENCE NO.	5
PROJECT NO.	U-440
DATE	11/15/2009
BY	WYOMING ENGINEERS
CHECKED BY	WYOMING ENGINEERS
SCALE	AS SHOWN

2-1 CURVE DATA
 P/S/C 11/37.5/4
 $\Delta = 33.59$ 17' (LT)
 $\Delta = 27.27$ 27' (RT)
 $\Delta = 27.27$ 27' (RT)
 T = 60.56
 R = 500.00
 SE = SEE PLANS

2-2 CURVE DATA
 P/S/C 11/37.5/4
 $\Delta = 33.59$ 17' (LT)
 $\Delta = 27.27$ 27' (RT)
 $\Delta = 27.27$ 27' (RT)
 T = 60.56
 R = 500.00
 SE = SEE PLANS

2-3 CURVE DATA
 P/S/C 11/37.5/4
 $\Delta = 33.59$ 17' (LT)
 $\Delta = 27.27$ 27' (RT)
 $\Delta = 27.27$ 27' (RT)
 T = 60.56
 R = 500.00
 SE = SEE PLANS

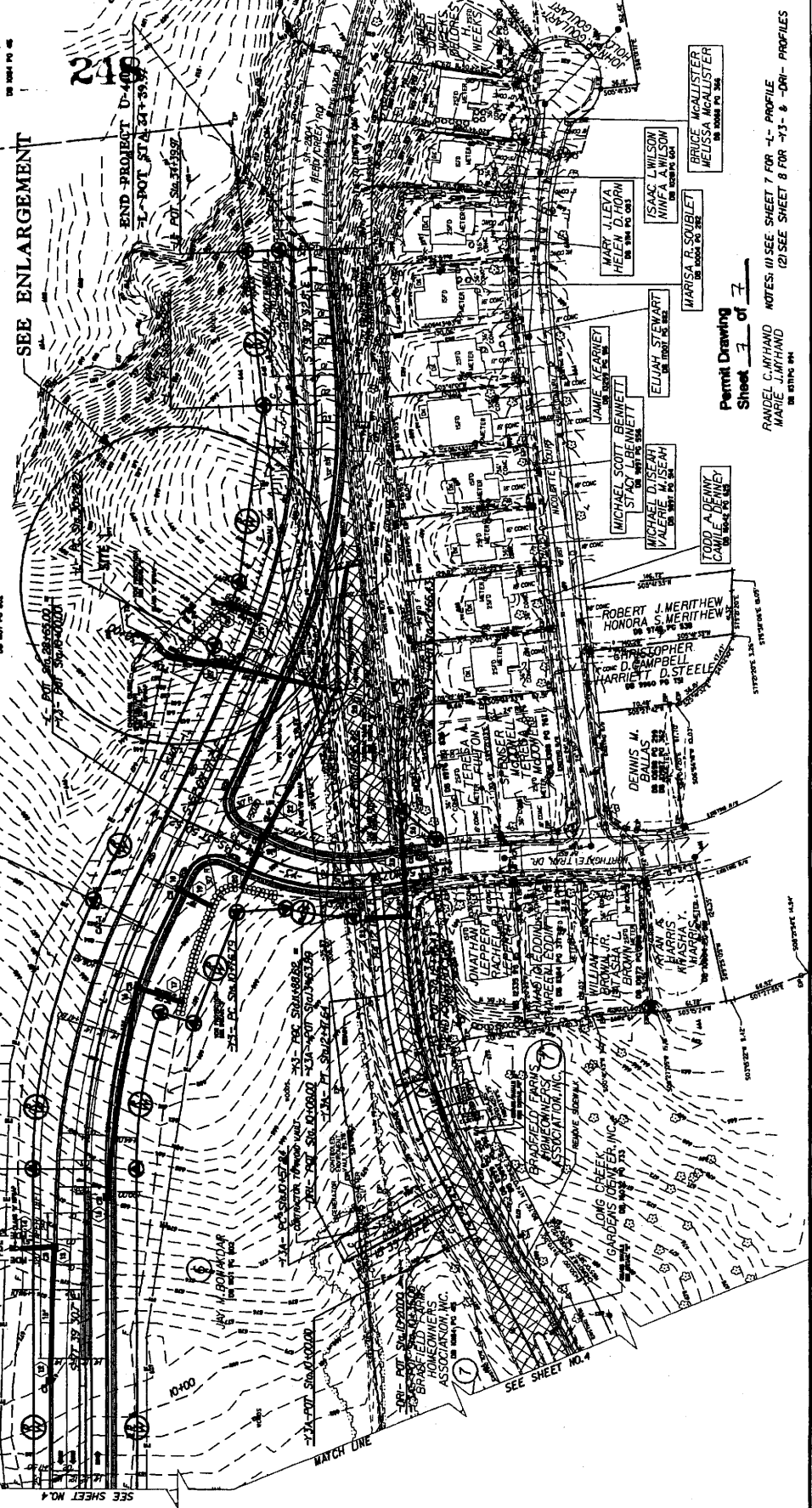
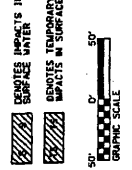

Permit Drawing
 Sheet 3 of 7
 NOTES: (1) SEE SHEET 7 FOR "L" PROFILE
 (2) SEE SHEET 8 FOR "S" & "DRI" PROFILES
 RANDOL C. ARTHAND
 MARIE J. ARTHAND
 IN CHARGE

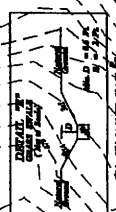
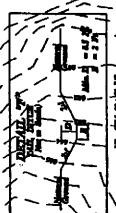
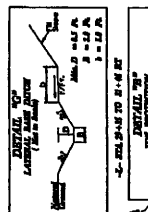

STORMWATER MANAGEMENT PLAN

U-4401, WBS No.: 367741.1

Date: 07/07/09

Mecklenburg County

Hydraulics Project Manager: Andrew Nottingham, PE

ROADWAY DESCRIPTION

The project involves realignment of SR 2804 (Reedy Creek Road) & SR 2805 (Harrisburg Road). The project's purpose is to realign the existing intersection away from the new I-485 interchange, which will reduce the accident potential conflict with the interchange and the intersection. Curb and gutter is used along the relocated portion of Reedy Creek Road that is currently a curb and gutter roadway. The remainder of the project is a shoulder section with grass slopes and ditches.

ENVIRONMENTAL DESCRIPTION AND IMPACTS

The project is located in the Yadkin River Basin. A small jurisdictional stream is the only impacted feature in this realignment. The stream drains to McKee Creek, which is classified as class C and is on the 2006 303d list for impaired biological integrity due to sedimentation. Stream impacts are due to the realignment of the intersection and will consist of removing a portion of the existing pipe and installing a 36" CSP on new location.

BEST MANAGEMENT PRACTICES

Best Management Practices (BMPs) and measures will be used on the project to reduce storm water impacts to the receiving streams due to erosion and runoff. Grassed swales were used along -Y3A- to aid in pollutant removal through vegetative filtration and infiltration. Drainage systems were designed to outlet away from surface waters to allow time for infiltration in ditches or natural areas. Rip rap is used in ditches and at pipe outlets where warranted to prevent erosion and sedimentation.

Grass swale locations:

- -Y3A- Station 8+50 to -Y3A- Station 13+26 Rt. (length = 416 feet.)

**U.S. ARMY CORPS OF ENGINEERS
WILMINGTON DISTRICT**

Action ID: SAW-2009-01562County: MecklenburgUSGS Quad: Mint Hill

GENERAL PERMIT (REGIONAL AND NATIONWIDE) VERIFICATION

Property Owner / Authorized Agent: NC Department of Transportation, Project Development and Environmental Analysis Branch, Attn: Gregory J. Thorpe, Director

Address: 1548 Mail Service Center
Raleigh, NC 27699-1548

Telephone No.: 919-733-3141

Size and location of property (water body, road name/number, town, etc.): Bridge No. 177 on SR 2804 (Reedy Creek Road) over Reedy Creek east of Charlotte, TIP No. B-4580.

Description of projects area and activity: Replace the existing 70-foot long bridge with a new 110-foot long bridge at the existing alignment. Construct a temporary rock causeway (0.02 acres) on the west bank of the creek to facilitate bridge construction. Stabilize 60 linear feet of stream bank under the bridge with rock riprap. Construct a rock outfall on an existing roadside ditch. Permanent project impacts total 68 linear feet of perennial channel and 0.01 acres of wetland. Traffic will be rerouted to an offsite detour during construction.

Applicable Law: Section 404 (Clean Water Act, 33 USC 1344)
 Section 10 (Rivers and Harbors Act, 33 USC 403)

Authorization: Regional General Permit Number: _____
Nationwide Permit Numbers: 13, 23, 33

Your work is authorized by the above referenced permit provided it is accomplished in strict accordance with the attached conditions and your submitted plans. Any violation of the attached conditions or deviation from your submitted plans may subject the permittee to a stop work order, a restoration order and/or appropriate legal action.

This verification will remain valid until the expiration date identified below unless the nationwide authorization is modified, suspended or revoked. If, prior to the expiration date identified below, the nationwide permit authorization is reissued and/or modified, this verification will remain valid until the expiration date identified below, provided it complies with all requirements of the modified nationwide permit. If the nationwide permit authorization expires or is suspended, revoked, or is modified, such that the activity would no longer comply with the terms and conditions of the nationwide permit, activities which have commenced (i.e., are under construction) or are under contract to commence in reliance upon the nationwide permit, will remain authorized provided the activity is completed within twelve months of the date of the nationwide permit's expiration, modification or revocation, unless discretionary authority has been exercised on a case-by-case basis to modify, suspend or revoke the authorization.

Activities subject to Section 404 (as indicated above) may also require an individual Section 401 Water Quality Certification. You should contact the NC Division of Water Quality (telephone (919) 733-1786) to determine Section 401 requirements.

For activities occurring within the twenty coastal counties subject to regulation under the Coastal Area Management Act (CAMA), prior to beginning work you must contact the N.C. Division of Coastal Management.

This Department of the Army verification does not relieve the permittee of the responsibility to obtain any other required Federal, State or local approvals/permits.

If there are any questions regarding this verification, any of the conditions of the Permit, or the Corps of Engineers regulatory program, please contact Steven Lund at telephone 828-271-7980.

Corps Regulatory Official: Steven Lund *SWZ*Date Issued: August 26, 2009Expiration Date of Verification: August 26, 2011

The Wilmington District is committed to providing the highest level of support to the public. To help us ensure we continue to do so, please complete the attached customer Satisfaction Survey or visit <http://www.saw.usace.army.mil/WETLANDS/index.html> to complete the survey online.

Determination of Jurisdiction:

- Based on preliminary information, there appear to be waters of the US including wetlands within the above described project area. This preliminary determination is not an appealable action under the Regulatory Program Administrative Appeal Process (Reference 33 CFR Part 331).
- There are Navigable Waters of the United States within the above described project area subject to the permit requirements of Section 10 of the Rivers and Harbors Act and Section 404 of the Clean Water Act. Unless there is a change in the law or our published regulations, this determination may be relied upon for a period not to exceed five years from the date of this notification.
- X There are waters of the US and/or wetlands within the above described project area subject to the permit requirements of Section 404 of the Clean Water Act (CWA)(33 USC § 1344). Unless there is a change in the law or our published regulations, this determination may be relied upon for a period not to exceed five years from the date of this notification.
- The jurisdictional areas within the above described project area have been identified under a previous action. Please reference jurisdictional determination issued _____. Action ID _____

Basis of Jurisdictional Determination: Reedy Creek is a perennial stream (RPW) flowing to the Rocky River, a traditionally navigable water (TNW).

Appeals Information (This information applies only to approved jurisdictional determinations.)

Attached to this verification is an approved jurisdictional determination. If you are not in agreement with that approved jurisdictional determination, you can make an administrative appeal under 33 CFR 331. Enclosed you will find a Notification of Appeal Process (NAP) fact sheet and request for appeal (RFA) form. If you request to appeal this determination you must submit a completed RFA form to the following address:

District Engineer, Wilmington Regulatory Division
Attn: Steven W. Lund, Project Manager
Asheville Regulatory Field Office
151 Patton Avenue, Room 208
Asheville, North Carolina 28801-5006

In order for an RFA to be accepted by the Corps, the Corps must determine that it is complete, that it meets the criteria for appeal under 33 CFR part 331.5, and that it has been received by the District Office within 60 days of the date of the NAP. Should you decide to submit an RFA form, it must be received at the above address by a date 60 days from the date of this permit.

It is not necessary to submit an RFA form to the District Office if you do not object to the determination in this correspondence.

Corps Regulatory Official: Steven Lund

Date August 26, 2009

SWL

SURVEY PLATS, FIELD SKETCH, WETLAND DELINEATION FORMS, PROJECT PLANS, ETC., MUST BE ATTACHED TO THE FILE COPY OF THIS FORM, IF REQUIRED OR AVAILABLE.

Copy Furnished: N/A

Action ID Number: SAW-2009-01562

County: Mecklenburg

Permittee: NC Department of Transportation, Attn: Gregory S. Thorpe
NW 13, 23, 33, Bridge No. 177 on SR 2804, TIP B-4580

Date Permit Issued: August 26, 2009

Project Manager: Lund

* Upon completion of the activity authorized by this permit and any mitigation required by the permit, sign this certification and return it to the following address:

US ARMY CORPS OF ENGINEERS
WILMINGTON DISTRICT
ASHEVILLE REGULATORY FIELD OFFICE
151 PATTON AVENUE, ROOM 208
ASHEVILLE, NORTH CAROLINA 28801-5006

Please note that your permitted activity is subject to a compliance inspection by a U. S. Army Corps of Engineers representative. If you fail to comply with this permit you are subject to permit suspension, modification, or revocation.

I hereby certify that the work authorized by the above referenced permit has been completed in accordance with the terms and condition of the said permit, and required mitigation was completed in accordance with the permit conditions.

Signature of Permittee

Date

NOTIFICATION OF ADMINISTRATIVE APPEAL OPTIONS AND PROCESS AND REQUIREMENTS FOR APPEAL

Applicant: NC Dept. of Transportation	File Number: 2009-01562	Date: August 26, 2009
Attached is:		See Section below
<input type="checkbox"/>	INITIAL PROFFERED PERMIT (Standard Permit or Letter of permission)	A
<input type="checkbox"/>	PROFFERED PERMIT (Standard Permit or Letter of permission)	B
<input type="checkbox"/>	PERMIT DENIAL	C
<input checked="" type="checkbox"/>	APPROVED JURISDICTIONAL DETERMINATION	D
<input type="checkbox"/>	PRELIMINARY JURISDICTIONAL DETERMINATION	E

SECTION I - The following identifies your rights and options regarding an administrative appeal of the above decision. Additional information may be found at [http://www.usace.army.mil/ineo/functions/cw/ceowo/reg/or/Corps regulations at 33 CFR Part 331](http://www.usace.army.mil/ineo/functions/cw/ceowo/reg/or/Corps%20regulations%20at%2033%20CFR%20Part%20331).

- A: INITIAL PROFFERED PERMIT:** You may accept or object to the permit.
- **ACCEPT:** If you received a Standard Permit, you may sign the permit document and return it to the district engineer for final authorization. If you received a Letter of Permission (LOP), you may accept the LOP and your work is authorized. Your signature on the Standard Permit or acceptance of the LOP means that you accept the permit in its entirety, and waive all rights to appeal the permit, including its terms and conditions, and approved jurisdictional determinations associated with the permit.
 - **OBJECT:** If you object to the permit (Standard or LOP) because of certain terms and conditions therein, you may request that the permit be modified accordingly. You must complete Section II of this form and return the form to the district engineer. Your objections must be received by the district engineer within 60 days of the date of this notice, or you will forfeit your right to appeal the permit in the future. Upon receipt of your letter, the district engineer will evaluate your objections and may: (a) modify the permit to address all of your concerns, (b) modify the permit to address some of your objections, or (c) not modify the permit having determined that the permit should be issued as previously written. After evaluating your objections, the district engineer will send you a proffered permit for your reconsideration, as indicated in Section B below.
- B: PROFFERED PERMIT:** You may accept or appeal the permit
- **ACCEPT:** If you received a Standard Permit, you may sign the permit document and return it to the district engineer for final authorization. If you received a Letter of Permission (LOP), you may accept the LOP and your work is authorized. Your signature on the Standard Permit or acceptance of the LOP means that you accept the permit in its entirety, and waive all rights to appeal the permit, including its terms and conditions, and approved jurisdictional determinations associated with the permit.
 - **APPEAL:** If you choose to decline the proffered permit (Standard or LOP) because of certain terms and conditions therein, you may appeal the declined permit under the Corps of Engineers Administrative Appeal Process by completing Section II of this form and sending the form to the division engineer. This form must be received by the division engineer within 60 days of the date of this notice.
- C: PERMIT DENIAL:** You may appeal the denial of a permit under the Corps of Engineers Administrative Appeal Process by completing Section II of this form and sending the form to the division engineer. This form must be received by the division engineer within 60 days of the date of this notice.
- D: APPROVED JURISDICTIONAL DETERMINATION:** You may accept or appeal the approved JD or provide new information.
- **ACCEPT:** You do not need to notify the Corps to accept an approved JD. Failure to notify the Corps within 60 days of the date of this notice, means that you accept the approved JD in its entirety, and waive all rights to appeal the approved JD.
 - **APPEAL:** If you disagree with the approved JD, you may appeal the approved JD under the Corps of Engineers Administrative Appeal Process by completing Section II of this form and sending the form to the division engineer. This form must be received by the division engineer within 60 days of the date of this notice.

E: PRELIMINARY JURISDICTIONAL DETERMINATION: You do not need to respond to the Corps regarding the preliminary JD. The Preliminary JD is not appealable. If you wish, you may request an approved JD (which may be appealed), by contacting the Corps district for further instruction. Also you may provide new information for further consideration by the Corps to reevaluate the JD.

SECTION II - REQUEST FOR APPEAL or OBJECTIONS TO AN INITIAL PROFFERED PERMIT

REASONS FOR APPEAL OR OBJECTIONS: (Describe your reasons for appealing the decision or your objections to an initial proffered permit in clear concise statements. You may attach additional information to this form to clarify where your reasons or objections are addressed in the administrative record.)

ADDITIONAL INFORMATION: The appeal is limited to a review of the administrative record, the Corps memorandum for the record of the appeal conference or meeting, and any supplemental information that the review officer has determined is needed to clarify the administrative record. Neither the appellant nor the Corps may add new information or analyses to the record. However, you may provide additional information to clarify the location of information that is already in the administrative record.

POINT OF CONTACT FOR QUESTIONS OR INFORMATION:

If you have questions regarding this decision and/or the appeal process you may contact:
 Mr. Steven Lund, Project Manager
 CESA-W-RG-A
 US Army Corps of Engineers, Wilmington District
 151 Patton Avenue, Room 208
 Asheville, North Carolina 28801-5006

If you only have questions regarding the appeal process you may also contact:

RIGHT OF ENTRY: Your signature below grants the right of entry to Corps of Engineers personnel, and any government consultants, to conduct investigations of the project site during the course of the appeal process. You will be provided a 15 day notice of any site investigation, and will have the opportunity to participate in all site investigations.

_____ Signature of appellant or agent.	Date:	Telephone number:
---	-------	-------------------

DIVISION ENGINEER:
 Commander
 U.S. Army Engineer Division, South Atlantic
 60 Forsyth Street, Room 9M15
 Atlanta, Georgia 30303-3490



North Carolina Department of Environment and Natural Resources
Division of Water Quality

Beverly Eaves Perdue
 Governor

Coleen H. Sullins
 Director

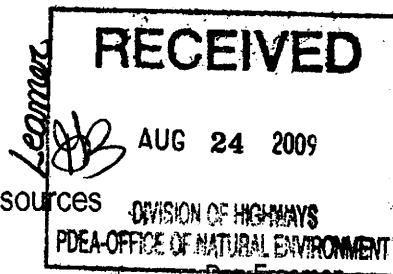

Dee Freeman
 Secretary

RECEIVED
 Division of Highways

August 19, 2009
 DWQ# 09-0821
 Mecklenburg County

AUG 24 2009

Preconstruction
 Project Development and
 Environmental Analysis Branch

Dr. Greg Thorpe, Ph.D., Manager
 Project Development and Environmental Analysis Branch
 North Carolina Department of Transportation
 1598 Mail Service Center
 Raleigh, North Carolina, 27699-1548

APPROVAL of 401 Water Quality Certification with Additional Conditions, Replacement of Bridge No. 177 Over Reedy Creek on State Road 2804 (Reedy Creek Road), Mecklenburg County, Federal Aid Project No. BRZ-2804(2), WBS Element 33782.1.1, TIP No. B-4580

Dear Dr. Thorpe:

You have our approval, in accordance with the attached conditions and those listed below, to permanently impact 68 linear feet (lf), to temporarily impact 60 lf of streams and to permanently impact 0.01 acres of wetlands as described in the table below:

Station No.	Stream Name/ Stream Type	Type of Impact	Amount of Stream Impact (linear feet)	Wetland Type/ Amount of Wetland Impact (acres)
32+80-L-LT	Reedy Creek/ Perennial	Permanent Riprap	8 lf	N/A
32+96/33+13-L-RT	N/A	Permanent Riprap	N/A	Riverine/0.01
33+14/33+41-L-	Reedy Creek/ Perennial	Permanent Riprap	60 lf	N/A
32+95/33+23-L-	Reedy Creek/ Perennial	Temporary Causeway	60 lf	N/A

Stream and wetland impacts are associated with the replacement of Bridge No. 177, as described in your application received by the Division of Water Quality (DWQ) on July 30, 2009. After reviewing your application, we have determined that this project is covered by Water Quality General Certification Numbers 3688, 3689 and 3701.

Mooresville Regional Office
 Location: 610 East Center Ave., Suite 301 Mooresville, NC 28115
 Phone: (704) 663-1699 \ Fax: (704) 663-6040 \ Customer Service: 1-877-623-6748
 Internet: www.ncwaterquality.org

An Equal Opportunity \ Affirmative Action Employer - 50% Recycled/10% Post Consumer paper



Please note that you should get any other federal, state or local permits before proceeding with your project, including those required by (but not limited to) Sediment and Erosion Control, Non-Discharge, and Water Supply Watershed regulations. This approval will expire with the associated 404 permit unless otherwise specified in the Water Quality Certification. This approval is valid solely for the purpose and design that you described in your application (unless modified below). Should your project change, you must notify the DWQ in writing and you may be required to submit a new application.

If the property is sold, the new owner must be given a copy of this Certification and approval letter and is thereby responsible for complying with all conditions. If total wetland fills for this project (now or in the future) exceed one acre, or if total impacts to streams (now or in the future) exceed 150 linear feet, compensatory mitigation may be required as described in 15A NCAC 2H.0506 (h)(6) and (7). For this approval to remain valid, you must adhere to the conditions listed in the attached certification and those listed below:

1. The use of riprap above the normal high water mark shall be minimized. Any riprap placed for stream stabilization shall be placed in stream channels in such a manner that it does not impede aquatic life passage.
2. The post construction removal of any temporary bridge structures must return the project site to its preconstruction contours and elevations. The impacted areas shall be revegetated with appropriate native species.
3. Strict adherence to the most recent version of NCDOT's Best Management Practices for Bridge Demolition and Removal approved by the US Army Corps of Engineers is a condition of the 401 Water Quality Certification.
4. Bridge deck drains shall not discharge directly into the stream. Stormwater shall be directed across the bridge and pre-treated through site appropriate means (grassed swales, pre-formed scour holes, vegetated buffers, etc.) before entering the stream. *Please refer to the most current version of Stormwater Best Management Practices.*
5. Bridge piles and bents shall be constructed using driven piles (hammer or vibratory) or drilled shaft construction methods. More specifically, jetting or other methods of pile driving are prohibited without prior written approval from NCDWQ first.
6. No drill slurry or water that has been in contact with uncured concrete shall be allowed to enter surface waters. This water shall be captured, treated and disposed of properly.
7. All pile driving or drilling activities shall be enclosed in turbidity curtains unless otherwise approved by NCDWQ in this certification.
8. All bridge construction shall be performed from the existing bridge, temporary work bridges, temporary causeways, or floating or sunken barges. If work conditions require barges, they shall be floated into position and then sunk. The barges shall not be sunk and then dragged into position. Under no circumstances should barges be dragged along the bottom of the surface water.
9. Heavy equipment shall be operated from the banks rather than in the stream channel in order minimize sedimentation and reduce the introduction of other pollutants into the stream.
10. No rock, sand or other materials shall be dredged from the stream channel except where authorized by this certification.
11. Temporary dewatering sites must be restored to pre-existing conditions unless more natural geomorphic conditions can be provided.
12. If concrete is used during construction, a dry work area should be maintained to prevent direct contact between curing concrete and stream water. Water that inadvertently contacts uncured concrete should not be discharged to surface waters due to the potential for elevated pH and possible aquatic life and fish kills.
13. All work in or adjacent to stream waters shall be conducted in a dry work area. Approved BMP measures from the most current version of the NCDOT Construction and Maintenance Activities manual such as sandbags, rock berms, cofferdams and other diversion structures shall be used to prevent excavation in flowing water.

Please note that you should get any other federal, state or local permits before proceeding with your project, including those required by (but not limited to) Sediment and Erosion Control, Non-Discharge, and Water Supply Watershed regulations. This approval will expire with the associated 404 permit unless otherwise specified in the Water Quality Certification. This approval is valid solely for the purpose and design that you described in your application (unless modified below). Should your project change, you must notify the DWQ in writing and you may be required to submit a new application.

If the property is sold, the new owner must be given a copy of this Certification and approval letter and is thereby responsible for complying with all conditions. If total wetland fills for this project (now or in the future) exceed one acre, or if total impacts to streams (now or in the future) exceed 150 linear feet, compensatory mitigation may be required as described in 15A NCAC 2H.0506 (h)(6) and (7). For this approval to remain valid, you must adhere to the conditions listed in the attached certification and those listed below:

1. The use of riprap above the normal high water mark shall be minimized. Any riprap placed for stream stabilization shall be placed in stream channels in such a manner that it does not impede aquatic life passage.
2. The post construction removal of any temporary bridge structures must return the project site to its preconstruction contours and elevations. The impacted areas shall be revegetated with appropriate native species.
3. Strict adherence to the most recent version of NCDOT's Best Management Practices for Bridge Demolition and Removal approved by the US Army Corps of Engineers is a condition of the 401 Water Quality Certification.
4. Bridge deck drains shall not discharge directly into the stream. Stormwater shall be directed across the bridge and pre-treated through site appropriate means (grassed swales, pre-formed scour holes, vegetated buffers, etc.) before entering the stream. *Please refer to the most current version of Stormwater Best Management Practices.*
5. Bridge piles and bents shall be constructed using driven piles (hammer or vibratory) or drilled shaft construction methods. More specifically, jetting or other methods of pile driving are prohibited without prior written approval from NCDWQ first.
6. No drill slurry or water that has been in contact with uncured concrete shall be allowed to enter surface waters. This water shall be captured, treated and disposed of properly.
7. All pile driving or drilling activities shall be enclosed in turbidity curtains unless otherwise approved by NCDWQ in this certification.
8. All bridge construction shall be performed from the existing bridge, temporary work bridges, temporary causeways, or floating or sunken barges. If work conditions require barges, they shall be floated into position and then sunk. The barges shall not be sunk and then dragged into position. Under no circumstances should barges be dragged along the bottom of the surface water.
9. Heavy equipment shall be operated from the banks rather than in the stream channel in order minimize sedimentation and reduce the introduction of other pollutants into the stream.
10. No rock, sand or other materials shall be dredged from the stream channel except where authorized by this certification.
11. Temporary dewatering sites must be restored to pre-existing conditions unless more natural geomorphic conditions can be provided.
12. If concrete is used during construction, a dry work area should be maintained to prevent direct contact between curing concrete and stream water. Water that inadvertently contacts uncured concrete should not be discharged to surface waters due to the potential for elevated pH and possible aquatic life and fish kills.
13. All work in or adjacent to stream waters shall be conducted in a dry work area. Approved BMP measures from the most current version of the NCDOT Construction and Maintenance Activities manual such as sandbags, rock berms, cofferdams and other diversion structures shall be used to prevent excavation in flowing water.

Dr. Gregory J. Thorpe
Page Three

14. The dimension, pattern and profile of the stream above and below the crossing should not be modified. Disturbed floodplains and streams should be restored to natural geomorphic conditions.
15. All mechanized equipment operated near surface waters must be regularly inspected and maintained to prevent contamination of stream waters from fuels, lubricants, hydraulic fluids, or other toxic materials.
16. All fill slopes located in jurisdictional wetlands shall be placed at slopes no flatter than 3:1, unless otherwise authorized by this certification.
17. Discharging hydroseed mixtures and washing out hydroseeders and other equipment in or adjacent to surface waters is prohibited.
18. A copy of this Water Quality Certification shall be posted on the construction site at all times. In addition, the Water Quality Certification and all subsequent modifications, if any, shall be maintained with the Division Engineer and the on-site project manager.
19. Native riparian vegetation must be re-established within the construction limits of the project by the end of the growing season following completion of construction.
20. Sediment and erosion control measures shall not be placed in wetlands or waters to the maximum extent practicable. If placement of sediment and erosion control devices in wetlands and waters is unavoidable, they shall be removed and the natural grade restored within 30 days after the Division of Land Resources has released the project.
21. Erosion and sediment control practices must be in full compliance with all specifications governing the proper design, installation and operation and maintenance of such Best Management Practices in order to protect surface waters standards:
 - a. The erosion and sediment control measures for the project must be designed, installed, operated, and maintained in accordance with the most recent version of the *North Carolina Sediment and Erosion Control Planning and Design Manual*.
 - b. The design, installation, operation, and maintenance of the sediment and erosion control measures must be such that they equal, or exceed, the requirements specified in the most recent version of the *North Carolina Sediment and Erosion Control Manual*. The devices shall be maintained on all construction sites, borrow sites, and waste pile (spoil) projects, including contractor-owned or leased borrow pits associated with the project.
 - c. For borrow pit sites, the erosion and sediment control measures must be designed, installed, operated, and maintained in accordance with the most recent version of the *North Carolina Surface Mining Manual*.
 - d. The reclamation measures and implementation must comply with the reclamation in accordance with the requirements of the Sedimentation Pollution Control Act.
22. The Permittee shall ensure that the final design drawings adhere to the certification and to the drawings submitted for approval.
23. The outside buffer, wetland or water boundary located within the construction corridor approved by this certification shall be clearly marked by highly visible fencing prior to any land disturbing activities. Impacts to areas within the fencing are prohibited unless otherwise authorized by this certification.
24. The Permittee shall report any violations of this certification to the Division of Water Quality within 24 hours of discovery.
25. The North Carolina Department of Transportation (NCDOT) and its contractors and/or agents shall not excavate, fill or perform mechanized land clearing at any time in the construction or maintenance of this project within waters and/or wetlands, except as authorized by this Certification, or any modification to this Certification (e.g., no work shall occur outside of the footprint of the plans provided). In addition, there shall be no excavation from or waste disposal into jurisdictional wetlands or waters associated with this Certification without appropriate modification. If this occurs, compensatory mitigation may be required since it is a direct impact from road construction activities.

Dr. Gregory J. Thorpe
Page Four

- *26. Upon completion of the project, the NCDOT Division Engineer shall complete and return the enclosed "Certificate of Completion" form to notify DWQ when all work included in the 401 Certification has been completed. Please include photographs upstream and downstream of the structure to document correct installation.
27. Continuing Compliance. NCDOT shall conduct its activities in a manner so as not to contravene any state water quality standard [including any requirements for compliance with section 303(d) of the Clean Water Act] and any other appropriate requirements of state and federal law. If DWQ determines that such standards or laws are not being met (including the failure to sustain a designated or achieved use) or that state or federal law is being violated, or that further conditions are necessary to assure compliance, DWQ may reevaluate and modify this certification to include conditions appropriate to assure compliance with such standards and requirements in accordance with 15 A NCAC 2H.0507(d). Before codifying the certification, DWQ shall notify NCDOT and the USACE, provide public notice in accordance with 15A NCAC 2H.0503, and provide opportunity for public hearing in accordance with 15A NCAC 2H.0504. Any new or revised conditions shall be provided to NCDOT in writing, shall be provided to the USACE for reference in any permit issued pursuant to Section 404 of the Clean Water Act, and shall also become conditions of the 404 Permit for the project.

If you do not accept any of the conditions of this Certification, you may ask for an adjudicatory hearing. You must act within 60 days of the date that you receive this letter. To ask for a hearing, send a written petition that conforms to Chapter 150B of the North Carolina General Statutes to the Office of Administrative Hearings, 6714 Mail Service Center, Raleigh, N.C. 27699-6714. This Certification and its conditions are final and binding unless you ask for a hearing.

This letter completes the review by the Division of Water Quality under Section 401 of the Clean Water Act. If you have any questions, please telephone Polly Lespinasse in the Mooresville Regional Office at 704-663-1699.

Sincerely,

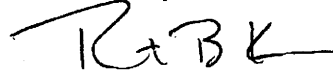

for Coleen H. Sullins

Attachments

cc: Steve Lund, USACE Asheville Field Office
Sonia Gregory, DWQ Wetlands Unit
File Copy

Water Quality Certification N^o. 3688

**GENERAL CERTIFICATION FOR PROJECTS ELIGIBLE
FOR U.S. ARMY CORPS OF ENGINEERS NATIONWIDE PERMIT NUMBER 33
(TEMPORARY CONSTRUCTION, ACCESS AND DEWATERING)
AND RIPARIAN AREA PROTECTION RULES (BUFFER RULES)**

Water Quality Certification Number 3688 is issued in conformity with the requirements of Section 401, Public Laws 92-500 and 95-217 of the United States and subject to the North Carolina Division of Water Quality Regulations in 15A NCAC 2H, Section .0500 and 15A NCAC 2B .0200 for the discharge of fill material to waters and wetland areas as described in 33 CFR 330 Appendix A (B) (33) and for the Riparian Area Protection Rules (Buffer Rules) in 15A NCAC 2B .0200. The category of activities shall include any fill activity for temporary construction, access and de-watering.

The State of North Carolina certifies that the specified category of activity will not violate appropriate portions of Sections 301, 302, 303, 306 and 307 of the Public Laws 92-500 and 95-217 if conducted in accordance with the conditions hereinafter set forth.

Activities covered by this General Certification *do not* require written approval from the Division of Water Quality (the "Division") as long as they comply with the Conditions listed below. **If any of these Conditions cannot be met, or if the activity is associated with or in response to a Notice of Violation from the Division of Water Quality or the NC Division of Land Resources, then written approval from the Division is required. Activities that are located within river basins with Riparian Area Protection Rules (Buffer Rules) require written approval unless listed in the as "Exempt" within the riparian rules.**

- * In accordance with North Carolina General Statute Section 143-215.3D(e), any requirement for written approval for a 401 Water Quality Certification must include the appropriate fee. If a project also requires a CAMA Permit, then one payment to both agencies shall be submitted and will be the higher of the two fees.

Conditions of Certification:

1. No Impacts Beyond those authorized by this Certification

No waste, spoil, solids, or fill of any kind shall occur in wetlands, waters, or riparian areas beyond the thresholds authorized by this Certification, including incidental impacts. All construction activities, including the design, installation, operation, and maintenance of sediment and erosion control Best Management Practices, shall be performed so that no violations of state water quality standards, statutes, or rules occur.

2. Standard Erosion and Sediment Control Practices

Erosion and sediment control practices shall be in full compliance with all specifications governing the proper design, installation and operation and maintenance of such Best Management Practices:

- a. Design, installation, operation, and maintenance of the sediment and erosion control measures must be such that they equal, or exceed, the requirements specified in the most recent version of the *North Carolina Sediment and Erosion Control Manual*. The devices shall be maintained on all construction sites, borrow sites, and waste pile (spoil) projects, including contractor-owned or leased borrow pits associated with the project.
- b. For borrow pit sites, the erosion and sediment control measures must be designed, installed, operated, and maintained in accordance with the most recent version of the *North Carolina Surface Mining Manual*.

Water Quality Certification N^o. 3688

- c. Reclamation measures and implementation must comply with the reclamation in accordance with the requirements of the Sedimentation Pollution Control Act and the Mining Act of 1971.
 - d. Sufficient materials required for stabilization and/or repair of erosion control measures and stormwater routing and treatment shall be on site at all times, except for publicly funded linear transportation projects when materials can be accessed offsite in a timely manner.
 - e. If the project occurs in waters or watersheds classified as Primary Nursery Areas (PNAs), Trout (Tr), SA, WS-I, WS-II, High Quality (HQW), or Outstanding Resource (ORW) waters, then the sediment and erosion control requirements contained within *Design Standards in Sensitive Watersheds* (15A NCAC 04B .0124) supercede all other sediment and erosion control requirements.
3. No Sediment and Erosion Control Measures in Wetlands or Waters

Sediment and erosion control measures should not be placed in wetlands or waters outside of the permitted impact areas without prior written approval from the Division. If placement of sediment and erosion control devices in wetlands and waters is unavoidable, then the design and placement of temporary erosion control measures shall not be conducted in a manner that may result in dis-equilibrium of wetlands or stream beds or banks, adjacent to or upstream and down stream of the above structures. All sediment and erosion control devices shall be removed and the natural grade restored within two (2) months of the date that the Division of Land Resources or locally delegated program has released the project.

4. Construction Stormwater Permit NCG010000

Upon the approval of an Erosion and Sedimentation Control Plan issued by the Division of Land Resources (DLR) or a DLR delegated local erosion and sedimentation control program, an NPDES General stormwater permit (NCG010000) administered by the Division is automatically issued to the project. This General Permit allows stormwater to be discharged during land disturbing construction activities as stipulated by conditions in the permit. If your project is covered by this permit [applicable to construction projects that disturb one (1) or more acres], full compliance with permit conditions including the sedimentation control plan, self-monitoring, record keeping and reporting requirements are required. A copy of this permit and monitoring report forms may be found at http://h2o.enr.state.nc.us/su/Forms_Documents.htm.

NCDOT shall be required to be in full compliance with the conditions related to construction activities within the most recent version of their individual NPDES (NCS000250) stormwater permit.

5. Construction Moratoriums and Coordination

All moratoriums on construction activities established by the NC Wildlife Resources Commission (WRC), US Fish and Wildlife Service (USFWS), NC Division of Marine Fisheries (DMF), or National Marine Fisheries Service (NMFS) to lessen impacts on trout, anadromous fish, larval/post-larval fishes and crustaceans, or other aquatic species of concern must be obeyed. This condition can be waived through written concurrence on a case by case basis upon reasonable justification.

Work within the twenty-five (25) designated trout counties or identified state or federal endangered or threatened species habitat shall be coordinated with the appropriate WRC, USFWS, NMFS, and/or DMF personnel.

Water Quality Certification N^o. 3688

6. Riparian Area Protection (Buffer) Rules

Activities located in the protected 50-foot wide riparian areas (whether jurisdictional wetlands or not) within the Neuse, Tar-Pamlico, Randleman and Catawba River Basins (or any other basin with buffer rules), shall be limited to "uses" identified within and constructed in accordance with 15A NCAC 2B .0233, .0259, .0250, and .0243, and shall be located, designed, constructed, and maintained to have minimal disturbance to protect water quality to the maximum extent practicable through the use of best management practices. All buffer rule requirements, including diffuse flow requirements, shall be met.

7. Water Supply Watershed Buffers

The 100-foot wide (high-density development) or the 30-foot wide vegetative buffer (all other development) shall be maintained adjacent to all perennial waters except for allowances as provided in the Water Supply Watershed Protection Rules [15A NCAC 2B .0212 through .0215].

- * 8. If an environmental document is required under NEPA or SEPA, then this General Certification is not valid until a Finding of No Significant Impact (FONSI) or Record of Decision (ROD) is issued by the State Clearinghouse.

9. Placement of culverts and other structures in waters, streams, and wetlands

The application must include construction plans with cross-sectional details in order to indicate that the current stability of the stream will be maintained or enhanced (i.e., not result in head cuts).

Culverts required for this project shall be designed and installed in such a manner that the original stream profiles are not altered and allow for aquatic life movement during low flows. Existing stream dimensions (including the cross section dimensions, pattern, and longitudinal profile) must be maintained above and below locations of each culvert. Placement of culverts and other structures in waters, streams, and wetlands must be placed below the elevation of the streambed by one foot for all culverts with a diameter greater than 48 inches, and 20 percent of the culvert diameter for culverts having a diameter less than 48 inches, to allow low flow passage of water and aquatic life, unless otherwise justified and approved by the Division

Installation of culverts in wetlands must ensure continuity of water movement and be designed to adequately accommodate high water or flood conditions. Additionally, when roadways, causeways or other fill projects are constructed across FEMA-designated floodways or wetlands, openings such as culverts or bridges must be provided to maintain the natural hydrology of the system as well as prevent constriction of the floodway that may result in destabilization of streams or wetlands.

Any rip rap required for normal pipe burial and stabilization shall be buried such that the original stream elevation is restored and maintained.

The establishment of native, woody vegetation and other soft stream bank stabilization techniques must be used where practicable instead of rip-rap or other bank hardening methods.

Water Quality Certification N^o. 3688

10. Work in the Dry

All work in or adjacent to stream waters shall be conducted in a dry work area. Approved best management practices from the most current version of the NC Sediment and Erosion Control Manual, or the NC DOT Construction and Maintenance Activities Manual, such as sandbags, rock berms, cofferdams, and other diversion structures shall be used to minimize excavation in flowing water. Channel realignments shall be constructed by excavating the new channel from downstream to upstream before connecting it to the existing channel. Exceptions to this condition require submittal to, and approval by, the Division of Water Quality.

11. If concrete is used during the construction, then a dry work area should be maintained to prevent direct contact between curing concrete and stream water. Water that inadvertently contacts uncured concrete should not be discharged to surface waters due to the potential for elevated pH and possible aquatic life/fish kills.

12. Temporary Fills

All temporary fill and culverts shall be removed and the impacted area returned to the original grade, including each stream's original cross sectional dimensions, planform pattern, and longitudinal bed and bed profile after construction is complete or within two (2) months of the establishment of the crossing, whichever is sooner, and the various sites shall be stabilized with natural woody vegetation (except for the maintenance areas of permanent utility crossings) and restored to prevent erosion. If the crossings are not completely removed and restored as described above within the specified time above, then written approval from the Division must be obtained to modify this condition.

13. Pipes shall be installed under the road or causeway in all streams to carry at least the 25-year storm event as outlined in the most recent edition of the *North Carolina Sediment and Erosion Control Planning and Design Manual* or the *North Carolina Surface Mining Manual* so as not to restrict stream flow during use of this General Certification.
14. For projects requiring written approval, additional site-specific conditions may be added to the cover letter in order to ensure compliance with all applicable water quality and effluent standards.

* 15. Certificate of Completion

When written authorization is required for use of this certification, upon completion of all permitted impacts included within the approval and any subsequent modifications, the applicant shall be required to return the certificate of completion attached to the approval. One copy of the certificate shall be sent to the DWQ Central Office in Raleigh at 1650 Mail Service Center, Raleigh, NC, 27699-1650.

16. This General Certification shall expire three (3) years from the date of issuance of the written approval or on the same day as the expiration date of these corresponding Nationwide and Regional General Permits. In accordance with General Statute 136-44.7B, certifications issued to the NCDOT shall expire only upon expiration of the federal 404 Permit. The conditions in effect on the date of issuance of Certification for a specific project shall remain in effect for the life of the project, regardless of the expiration date of this Certification. If the construction process for approved activities will overlap the expiration and renewal date of the corresponding 404 Permit and the Corps allows for continued use of the 404 Permit, then the General Certification shall also remain in effect without requiring re-application and re-approval to use this Certification for the specific impacts already approved.

Water Quality Certification N^o. 3688

17. The applicant/permittee and their authorized agents shall conduct all activities in a manner consistent with State water quality standards (including any requirements resulting from compliance with §303(d) of the Clean Water Act), and any other appropriate requirements of State and Federal Law. If the Division determines that such standards or laws are not being met, including failure to sustain a designated or achieved use, or that State or Federal law is being violated, or that further conditions are necessary to assure compliance, then the Division may reevaluate and modify this General Water Quality Certification.

Non-compliance with or violation of the conditions herein set forth by a specific fill project shall result in revocation of this General Certification for the project and may result in criminal and/or civil penalties.

The Director of the North Carolina Division of Water Quality may require submission of a formal application for individual certification for any project in this category of activity if it is determined that the project is likely to have a significant adverse effect upon water quality, including state or federally listed endangered or threatened aquatic species, or degrade the waters so that existing uses of the wetland, stream or downstream waters are precluded.

Public hearings may be held for specific applications or group of applications prior to a Certification decision if deemed in the public's best interest by the Director of the North Carolina Division of Water Quality.

Effective date: November 1, 2007

DIVISION OF WATER QUALITY

By



Coleen H. Sullins

Director

History Note: Water Quality Certification Number 3388 replaces Water Quality Certification Number 2727 issued on May 1, 1992, Certification Number 3114 issued on February 11, 1997, Certification Number 3366 issued March 18, 2002, and Certification Number 3634 issued March, 2007. This General Certification is rescinded when the Corps of Engineers reauthorize Nationwide Permit 33 or when deemed appropriate by the Director of the Division of Water Quality.

Water Quality Certification N^o. 3689

265

GENERAL CERTIFICATION FOR STREAM RESTORATION, ENHANCEMENT AND STABILIZATION PROJECTS AND WETLAND AND RIPARIAN RESTORATION AND CREATION ACTIVITIES INCLUDING THOSE ELIGIBLE FOR U.S. ARMY CORPS OF ENGINEERS NATIONWIDE PERMIT NUMBERS 13 (BANK STABILIZATION) AND 27 (WETLAND AND RIPARIAN RESTORATION AND CREATION), AND REGIONAL PERMIT 197800080 (BULKHEADS AND RIPRAP) AND RIPARIAN AREA PROTECTION RULES (BUFFER RULES)

Water Quality Certification Number 3689 is issued in conformity with the requirements of Section 401, Public Laws 92-500 and 95-217 of the United States and subject to the North Carolina Division of Water Quality Regulations in 15A NCAC 2H .0500 and 15A NCAC 2B .0200 for the discharge of fill material to waters as described in 33 CFR 330 Appendix A (B) (13) and (27) of the Corps of Engineers regulations (i.e., Nationwide Permit Numbers 13 and 27) and Regional Permit 197800080. The category of activities shall include stream bank stabilization or stream restoration activity as long as impacts to waters or significant wetlands are minimized; wetland and riparian restoration or creation; and the construction and maintenance of bulkheads on non-Federal Energy Regulatory Commission (FERC) lakes.

The State of North Carolina certifies that the specified category of activity will not violate applicable portions of Sections 301, 302, 303, 306 and 307 of the Public Laws 92-500 and 95-217 if conducted in accordance with the conditions set forth.

- * All proposed fill or modification of wetlands and/or waters, including streams and streambanks, under this General Certification requires application to, and written approval from the Division of Water Quality (the "Division"), regardless of the purpose of the restoration, enhancement, stabilization, or creation activity.

Bank Stabilization projects qualifying for Nationwide Permit 13 for erosion protection of up to 500 feet of stream banks to protect property are exempt from the requirement for written approval.

- * Any impacts to riparian buffers associated with this work in the Neuse, Tar-Pamlico, Randleman and Catawba River Basins (or any other basins with Riparian Area Protection Rules [Buffer Rules] in effect at the time of application [in accordance with 15A NCAC 2B .0200]) will require written approval, *unless* the activities are listed as "EXEMPT" from these Rules.

- * In accordance with North Carolina General Statute Section 143-215.3D(e), written approval for a 401 Water Quality General Certification must include the appropriate fee. If a project also requires a CAMA Permit, then one payment to both agencies shall be submitted and will be the higher of the two fees.

Conditions of Certification:

1. Activities shall meet the definitions, design, and monitoring protocols specified within the US Army Corps of Engineers Wilmington District *Regulatory Guidance Letter* (RGL02-02) and the *Stream Mitigation Guidelines* (April 2003) or any subsequent updates to these documents.
2. No waste, spoil, solids, or fill of any kind shall occur in wetlands, waters, or riparian areas beyond the footprint of the impacts depicted in the Pre-construction Notification and/or those authorized by this Certification, including incidental impacts. All construction activities, including the design, installation, operation, and maintenance of sediment and erosion control

266
Water Quality Certification N°. 3689

Best Management Practices, shall be performed so that no violations of state water quality standards, statutes, or rules occur.

3. Standard Erosion and Sediment Control Practices

Erosion and sediment control practices must be in full compliance with all specifications governing the proper design, installation and operation and maintenance of such Best Management Practices:

- a. Design, installation, operation, and maintenance of the sediment and erosion control measures must be such that they equal, or exceed, the requirements specified in the most recent version of the *North Carolina Sediment and Erosion Control Manual*. The devices shall be maintained on all construction sites, borrow sites, and waste pile (spoil) projects, including contractor-owned or leased borrow pits associated with the project.
- b. For borrow pit sites, the erosion and sediment control measures must be designed, installed, operated, and maintained in accordance with the most recent version of the *North Carolina Surface Mining Manual*.
- c. Reclamation measures and implementation must comply with the requirements of the Sedimentation Pollution Control Act and the Mining Act of 1971.
- d. Sufficient materials required for stabilization and/or repair of erosion control measures and stormwater routing and treatment shall be on site at all times, except for publicly funded linear transportation projects when materials can be accessed offsite in a timely manner..
- e. If the project occurs in waters or watersheds classified as Primary Nursery Areas (PNA's), Trout (Tr), SA, WS-I, WS-II, High Quality (HQW), or Outstanding Resource (ORW) waters, then the sediment and erosion control requirements contained within *Design Standards in Sensitive Watersheds* (15A NCAC 04B .0124) supercede all other sediment and erosion control requirements.

4. No Sediment and Erosion Control Measures in Wetlands or Waters

Sediment and erosion control measures should not be placed in wetlands or waters outside of the permitted impact areas without prior approval by the Division. If placement of sediment and erosion control devices in wetlands and waters is unavoidable, design and placement of temporary erosion control measures shall not be conducted in a manner that may result in dis-equilibrium of wetlands or stream beds or banks, adjacent to or upstream and down stream of the above structures. All sediment and erosion control devices shall be removed and the natural grade restored within two (2) months of the date that the Division of Land Resources or locally delegated program has released the project.

5. Construction Stormwater Permit NCG010000

Upon the approval of an Erosion and Sedimentation Control Plan issued by the Division of Land Resources (DLR) or a DLR delegated local erosion and sedimentation control program, an NPDES General stormwater permit (NCG010000) administered by the Division is automatically issued to the project. This General Permit allows stormwater to be discharged during land disturbing construction activities as stipulated by conditions in the permit. If your project is covered by this permit [applicable to construction projects that disturb one (1) or more acres], full compliance with permit conditions including the sedimentation control plan, self-monitoring, record keeping and reporting requirements are required. A copy of this permit and monitoring report forms may be found at http://h2o.enr.state.nc.us/su/Forms_Documents.htm.

The North Carolina Department of Transportation (NCDOT) shall be required to be in full compliance with the conditions related to construction activities within the most recent version of their individual NPDES (NCS000250) stormwater permit.

Water Quality Certification N°. 3689

267

6. Construction Moratoriums and Coordination

If activities must occur during periods of high biological activity (i.e. sea turtle or bird nesting), then biological monitoring may be required at the request of other state or federal agencies and coordinated with these activities. This condition can be waived through written concurrence on a case by case basis upon reasonable justification.

All moratoriums on construction activities established by the NC Wildlife Resources Commission (WRC), US Fish and Wildlife Service (USFWS), NC Division of Marine Fisheries (DMF), or National Marine Fisheries Service (NMFS) to lessen impacts on trout, anadromous fish, larval/post-larval fishes and crustaceans, or other aquatic species of concern shall be implemented. This condition can be waived through written concurrence on a case by case basis upon reasonable justification.

Work within the twenty-five (25) designated trout counties or identified state or federal endangered or threatened species habitat shall be coordinated with the appropriate WRC, USFWS, NMFS, and/or DMF personnel.

NC Wildlife Resources Commission will not object to construction of Natural Resources Conservation Service (NRCS) 'urgent and compelling' sites during the spawning period provided these projects are, to the extent appropriate and practical, constructed by:

- a. Using flow diversion structures such as sandbags;
- b. Placing large-size rock toes and filter cloth backing for stabilization sites before backfilling; and
- c. Excavating new channel alignments in dry areas.

Construction at non-'urgent and compelling' sites shall not occur during the spawning period to minimize the potential adverse effects of multiple construction activities on trout or anadromous fish resources in this stream.

7. Work in the Dry

All work in or adjacent to stream waters shall be conducted in a dry work area. Approved best management practices from the most current version of the NC Sediment and Erosion Control Manual, or the NC DOT Construction and Maintenance Activities Manual, such as sandbags, rock berms, cofferdams, and other diversion structures shall be used to minimize excavation in flowing water. Exceptions to this condition require submittal to, and approval by, the Division.

8. Riparian Area Protection (Buffer) Rules

Activities located in the protected 50-foot wide riparian areas (whether jurisdictional wetlands or not) within the Neuse, Tar-Pamlico, Randleman, Catawba (or any other basin with buffer rules), shall be limited to "uses" identified within and constructed in accordance with 15A NCAC 2B .0233, .0259, .0250 and .0243, and shall be located, designed, constructed, and maintained to have minimal disturbance to protect water quality to the maximum extent practicable through the use of best management practices. All buffer rule requirements, including diffuse flow requirements, must be met.

9. Water Supply Watershed Buffers

The 100-foot wide (high-density development) or the 30-foot wide vegetative buffer (all other development) must be maintained adjacent to all perennial waters except for allowances as

Water Quality Certification N°. 3689

268

provided in the Water Supply Watershed Protection Rules [15A NCAC 2B .0212 through .0215].

10. If concrete is used during the construction, then a dry work area should be maintained to prevent direct contact between curing concrete and stream water. Water that inadvertently contacts uncured concrete should not be discharged to surface waters due to the potential for elevated pH and possible aquatic life/fish kills.
11. Any rip-rap shall be of such a size and density so as not to be able to be carried off by wave or current action and consist of clean rock or masonry material free of debris or toxic pollutants. Rip-rap shall not be installed in the streambed except in specific areas required for velocity control and to ensure structural integrity of bank stabilization measures. If rip-rap is to be installed within the streambed, the amount and location must be approved in writing by the Division of Land Resources and Division of Water Quality. However, rock vanes, wing deflectors, and similar structures for grade control and bank protection are acceptable.
- * 12. If an environmental document is required under NEPA or SEPA, then this General Certification is not valid until a Finding of No Significant Impact or Record of Decision is issued by the State Clearinghouse.
13. Additional site-specific conditions may be added to the written approval attached to this Certification in order to ensure compliance with all applicable water quality and effluent standards.
14. This Certification shall expire three (3) years from the date of the approval letter from DWQ or on the same day as the corresponding Nationwide Permit. In accordance with General Statute 136-44.7B, certifications issued to the NCDOT shall expire only upon expiration of the federal 404 Permit. The conditions in effect on the date of issuance of Certification for a specific project shall remain in effect for the life of the project, regardless of the expiration date of this Certification. If the construction process for approved activities will overlap the expiration and renewal date of the corresponding 404 Permit and the Corps allows for continued use of the 404 Permit, then the General Certification shall also remain in effect without requiring re-application and re-approval to use this Certification for the specific impacts already approved.
15. The applicant/permittee and their authorized agents shall conduct all activities in a manner consistent with State water quality standards (including any requirements resulting from compliance with §303(d) of the Clean Water Act), and any other appropriate requirements of State and Federal Law. If the Division determines that such standards or laws are not being met, including failure to sustain a designated or achieved use, or that State or Federal law is being violated, or that further conditions are necessary to assure compliance, then the Division may reevaluate and modify this General Water Quality Certification.
- * 16. Certificate of Completion

When written authorization is required for use of this certification, upon completion of all permitted impacts included within the approval and any subsequent modifications, the applicant shall be required to return the certificate of completion attached to the approval. One copy of the certificate shall be sent to the DWQ Central Office in Raleigh at 1650 Mail Service Center, Raleigh, NC, 27699-1650.

Non-compliance with or violation of the conditions herein set forth by a specific project shall result in revocation of this Certification for the project and may also result in criminal and/or civil penalties.

Water Quality Certification N°. 3689

269

The Director of the North Carolina Division of Water Quality may require submission of a formal application for Individual Certification for any project in this category of activity if it is determined that the project is likely to have a significant adverse effect upon water quality including state or federally listed endangered or threatened aquatic species or degrade the waters so that existing uses of the wetland or downstream waters are precluded.

Public hearings may be held for specific applications or group of applications prior to a Certification decision if deemed in the public's best interest by the Director of the North Carolina Division of Water Quality.

Effective date:

November 1, 2007

DIVISION OF WATER QUALITY

By



Coleen H. Sullins

Director

History Note: Water Quality Certification Number 3689 replaces Water Quality Certification (WQC) Number 3399 issued March 2003, Water Quality Certification (WQC) Number 3495 issued December 31, 2004, and Water Quality Certification (WQC) Number 3626 issued March 2007. This WQC is rescinded when the Corps of Engineers reauthorizes Nationwide Permits 13 or 27 or Regional Permit 197800080 or when deemed appropriate by the Director of the Division of Water Quality.

Water Quality Certification N^o. 3701 270

GENERAL CERTIFICATION FOR PROJECTS ELIGIBLE FOR U.S. ARMY CORPS OF ENGINEERS NATIONWIDE PERMIT NUMBER 23 (APPROVED CATEGORICAL EXCLUSIONS) AND RIPARIAN AREA PROTECTION RULES (BUFFER RULES)

Water Quality Certification Number 3701 is issued in conformity with the requirements of Section 401, Public Laws 92-500 and 95-217 of the United States and subject to the North Carolina Division of Water Quality Regulations in 15A NCAC 2H, Section .0500 and 15A NCAC 2B .0200 for the discharge of fill material to waters and wetland areas as described in 33 CFR 330 Appendix A (B) (23) and for the Riparian Area Protection Rules (Buffer Rules) in 15A NCAC 2B .0200. The category of activities shall include only Federally-approved Categorical Exclusion projects.

The State of North Carolina certifies that the specified category of activity will not violate applicable portions of Sections 301, 302, 303, 306 and 307 of the Public Laws 92-500 and 95-217 if conducted in accordance with the conditions hereinafter set forth.

- * Any proposed fill or substantial modification of wetlands or waters (including streams) under this General Certification requires notification to the Division of Water Quality (the "Division"). Two (2) copies shall be submitted to the Division at the time of notification in accordance with 15A NCAC 2H .0501(a).

If any one (1) of the Conditions of Certification cannot be met, or, if the activities meet any one (1) of the following thresholds, then require *written approval* from the Division of Water Quality (the "Division") is required:

- I. Stream and/or buffer impacts:
 - a. Stream impacts equal or greater than 40 linear feet.
 - b. Any impacts to streams and/or buffers in the Neuse, Tar-Pamlico, Randleman and Catawba River Basins (or any other basins with Riparian Area Protection Rules [Buffer Rules] in effect at the time of application [in accordance with 15A NCAC 2B .0200]), *unless* the activities are listed as "EXEMPT" from these Rules.
- II. Impacts to waters of equal to or greater than one-third (1/3) of an acre.
- III. Wetland impacts:
 - a. Equal to or greater than one-third (1/3) acre East of Interstate-95.
 - b. Equal to or greater than one-tenth (1/10) acre West of Interstate-95.
 - c. Any impacts to wetlands adjacent to waters designated as: ORW, SA, WS-I, WS-II, or Trout, or wetlands contiguous to waters designated as a North Carolina or National Wild and Scenic River.
 - d. Any impacts to coastal wetlands [15A NCAC 7H .0205], or Unique Wetlands (UWL) [15A NCAC 2H .0506].
- IV. If the activity is associated with or in response to a Notice of Violation or an enforcement action initiated by the Division and/or the Division of Land Resources.
- V. Projects with any impacts to streams, wetlands, and/or waters that have received a Notice of Violation from the Division and/or Division of Land Resources.

- * In accordance with North Carolina General Statute Section 143-215.3D(e), any requirement for written approval for a 401 Water Quality Certification must include the appropriate fee. If a project also requires a CAMA Permit, then one payment to both agencies shall be submitted and will be the higher of the two fees.

Water Quality Certification N°. 3701

271

Conditions of Certification:

1. No Impacts Beyond those Authorized in the Written Approval or Beyond the Thresholds for use of This Certification

No waste, spoil, solids, or fill of any kind shall occur in wetlands, waters, or riparian areas beyond the footprint of the impacts authorized in the written approval or beyond the thresholds allowed for use of this General Certification, including incidental impacts. All construction activities, including the design, installation, operation, and maintenance of sediment and erosion control Best Management Practices, shall be performed so that no violations of state water quality standards, statutes, or rules occur.

2. Standard Erosion and Sediment Control Practices

Erosion and sediment control practices must be in full compliance with all specifications governing the proper design, installation and operation and maintenance of such Best Management Practices:

- a. Design, installation, operation, and maintenance of the sediment and erosion control measures must be such that they equal, or exceed, the requirements specified in the most recent version of the *North Carolina Sediment and Erosion Control Manual*. The devices shall be maintained on all construction sites, borrow sites, and waste pile (spoil) projects, including contractor-owned or leased borrow pits associated with the project.
- b. For borrow pit sites, the erosion and sediment control measures must be designed, installed, operated, and maintained in accordance with the most recent version of the *North Carolina Surface Mining Manual*.
- c. Reclamation measures and implementation must comply with the reclamation in accordance with the requirements of the Sedimentation Pollution Control Act and the Mining Act of 1971.
- d. Sufficient materials required for stabilization and/or repair of erosion control measures and stormwater routing and treatment shall be on site at all times, except for publicly funded linear transportation projects when materials can be accessed offsite in a timely manner.
- e. If the project occurs in waters or watersheds classified as Primary Nursery Areas (PNA's), Trout (Tr), SA, WS-I, WS-II, High Quality (HQW), or Outstanding Resource (ORW) waters, then the sediment and erosion control requirements contained within *Design Standards in Sensitive Watersheds* (15A NCAC 04B .0124) supercede all other sediment and erosion control requirements.

3. No Sediment and Erosion Control Measures in Wetlands or Waters

Sediment and erosion control measures should not be placed in wetlands or waters outside of the permitted impact areas without prior written approval by the Division. If placement of sediment and erosion control devices in wetlands and waters is unavoidable, design and placement of temporary erosion control measures shall not be conducted in a manner that may result in dis-equilibrium of wetlands or stream beds or banks, adjacent to or upstream and down stream of the above structures. All sediment and erosion control devices shall be removed and the natural grade restored within two (2) months of the date that the Division of Land Resources or locally delegated program has released the project.

Water Quality Certification N°. 3701

272

4. Construction Stormwater Permit NCG010000

Upon the approval of an Erosion and Sedimentation Control Plan issued by the Division of Land Resources (DLR) or a DLR delegated local erosion and sedimentation control program, an NPDES General stormwater permit (NCG010000) administered by the Division is automatically issued to the project. This General Permit allows stormwater to be discharged during land disturbing construction activities as stipulated by conditions in the permit. If your project is covered by this permit [applicable to construction projects that disturb one (1) or more acres], full compliance with permit conditions including the sedimentation control plan, self-monitoring, record keeping and reporting requirements are required. A copy of this permit and monitoring report forms may be found at http://h2o.enr.state.nc.us/su/Forms_Documents.htm.

NCDOT shall be required to be in full compliance with the conditions related to construction activities within the most recent version of their individual NPDES (NCS000250) stormwater permit.

5. Construction Moratoriums and Coordination

If activities must occur during periods of high biological activity (i.e. sea turtle or bird nesting), then biological monitoring may be required at the request of other state or federal agencies and coordinated with these activities. This condition can be waived through written concurrence on a case-by-case basis upon reasonable justification.

All moratoriums on construction activities established by the NC Wildlife Resources Commission (WRC), US Fish and Wildlife Service (USFWS), NC Division of Marine Fisheries (DMF), or National Marine Fisheries Service (NMFS) to lessen impacts on trout, anadromous fish, larval/post-larval fishes and crustaceans, or other aquatic species of concern must be obeyed. This condition can be waived through written concurrence on a case-by-case basis upon reasonable justification.

Work within the twenty-five (25) designated trout counties or identified state or federal endangered or threatened species habitat shall be coordinated with the appropriate WRC, USFWS, NMFS, and/or DMF personnel.

6. If concrete is used during the construction, then a dry work area should be maintained to prevent direct contact between curing concrete and stream water. Water that inadvertently contacts uncured concrete should not be discharged to surface waters due to the potential for elevated pH and possible aquatic life/fish kills.

7. Riparian Area Protection (Buffer) Rules

Activities located in the protected 50-foot wide riparian areas (whether jurisdictional wetlands or not) within the Neuse, Tar-Pamlico, Randleman, or Catawba River Basins (or any other basin with buffer rules), shall be limited to "uses" identified within and constructed in accordance with 15A NCAC 2B .0233, .0259, .0250, and .0243, and shall be located, designed, constructed, and maintained to have minimal disturbance to protect water quality to the maximum extent practicable through the use of best management practices. All riparian area protection rule requirements, including diffuse flow requirements, must be met.

Water Quality Certification N°. 3701

273

8. Water Supply Watershed Buffers

The 100-foot wide (high-density development) or the 30-foot wide vegetative buffer (all other development) shall be maintained adjacent to all perennial waters except for allowances as provided in the Water Supply Watershed Protection Rules [15A NCAC 2B .0212 through .0215].

9. Work in the Dry

All work in or adjacent to stream waters shall be conducted in a dry work area. Approved best management practices from the most current version of the NC Sediment and Erosion Control Manual, or the NC DOT Construction and Maintenance Activities Manual, such as sandbags, rock berms, cofferdams, and other diversion structures shall be used to minimize excavation in flowing water. Channel realignments shall be constructed by excavating the new channel from downstream to upstream before connecting it to the existing channel. Exceptions to this condition require submittal to, and approval by, the Division of Water Quality.

10. For all activities requiring re-alignment of streams, a stream relocation plan must be included for written Division approval. Relocated stream designs should include the same dimensions, patterns and profiles as the existing channel (or a stable reference reach if the existing channel is unstable), to the maximum extent practical. The new channel should be constructed in the dry and water shall not be turned into the new channel until the banks are stabilized. Vegetation used for permanent bank stabilization shall be limited to native woody species, and should include establishment of a 30-foot wide wooded and an adjacent 20-foot wide vegetated buffer on both sides of the relocated channel to the maximum extent practical. A transitional phase incorporating appropriate erosion control matting materials and seedling establishment is allowable. Rip-rap, A-Jacks, concrete, gabions or other hard structures may be allowed if it is necessary to maintain the physical integrity of the stream, but the applicant must provide written justification and any calculations used to determine the extent of rip-rap coverage. Please note that if the stream relocation is conducted as a stream restoration as defined in the US Army Corps of Engineers Wilmington District, April 2003 *Stream Mitigation Guidelines* (or its subsequent updates), the restored length can be used as compensatory mitigation for the impacts resulting from the relocation.

11. Placement of Culverts and Other Structures in Waters and Wetlands

The application must include construction plans with cross-sectional details in order to indicate that the current stability of the stream will be maintained or enhanced (i.e., not result in head cuts).

Culverts required for this project shall be designed and installed in such a manner that the original stream profiles are not altered and allow for aquatic life movement during low flows. Existing stream dimensions (including the cross section dimensions, pattern, and longitudinal profile) must be maintained above and below locations of each culvert. Placement of culverts and other structures in waters, streams, and wetlands must be placed below the elevation of the streambed by one foot for all culverts with a diameter greater than 48 inches, and 20 percent of the culvert diameter for culverts having a diameter less than 48 inches, to allow low flow passage of water and aquatic life unless otherwise justified and approved by the Division.

Installation of culverts in wetlands must ensure continuity of water movement and be designed to adequately accommodate high water or flood conditions. Additionally, when roadways, causeways or other fill projects are constructed across FEMA-designated floodways or wetlands, openings such as culverts or bridges must be provided to maintain

Water Quality Certification N^o. 3701

274

the natural hydrology of the system as well as prevent constriction of the floodway that may result in destabilization of streams or wetlands.

Any rip rap required for normal pipe burial and stabilization shall be buried such that the original stream elevation is restored and maintained.

The establishment of native, woody vegetation and other soft stream bank stabilization techniques must be used where practicable instead of rip-rap or other bank hardening methods.

12. Compensatory Mitigation

In accordance with 15A NCAC 2H .0506 (h), compensatory mitigation maybe required for losses of 150 linear feet or more of streams and/or one (1) acre or more of wetlands. For linear, public transportation projects, impacts equal to or exceeding 150 lines feet per stream may require mitigation.

In watersheds classified as: ORW, HQW, Tr, WS-I, and WS-II, compensatory stream mitigation may be required at a 1:1 ratio for not only perennial but also intermittent stream impacts equal to or exceeding 150 feet and that require application and written approval from the Division, unless the project is a linear, publicly-funded transportation project, which has a 150-foot per-stream impact allowance.

Buffer mitigation may be required for any project with Buffer Rules in effect at the time of application for buffer impacts resulting from activities classified as "allowable with mitigation" within the Buffer Rules or require a variance under the Buffer Rules.

A determination of buffer, wetland and stream mitigation requirements shall be made for any General Certification for this Nationwide Permit.

When compensatory mitigation is required for a project, the mitigation plans must be approved by the Division, in writing, before the impacts approved by this Certification occur. The most current design and monitoring protocols from the Division shall be followed and written plans submitted for the Division approval as required in those protocols. Alternately, the Division will accept payment into an in-lieu fee program or mitigation bank. Before any permanent building or structure on site is occupied, the mitigation plan must be implemented and/or constructed or proof of payment to a mitigation bank or in-lieu fee program must be provided to the Division. In the case of public road projects, the mitigation plan must be implemented, before the road is opened to the traveling public whenever practical or at the earliest reasonable time during the construction of the project

- * 13. If an environmental document is required under NEPA or SEPA, then this General Certification is not valid until a Finding of No Significant Impact (FONSI) or Record of Decision (ROD) is issued by the State Clearinghouse.
- 14. For activities requiring written approval, additional site-specific conditions may be added to the cover letter projects in order to ensure compliance with all applicable water quality and effluent standards.
- * 15. Certificate of Completion

When written authorization is required for use of this certification, upon completion of all permitted impacts included within the approval and any subsequent modifications, the applicant shall be required to return the certificate of completion attached to the approval. One copy of the certificate shall be sent to the DWQ Central Office in Raleigh at 1650 Mail Service Center, Raleigh, NC, 27699-1650.

Water Quality Certification N^o. 3701

275

16. This General Certification shall expire three (3) years from the date of issuance of the written approval or on the same day as the expiration date of the corresponding Nationwide and Regional General Permits. In accordance with General Statute 136-44.7B, certifications issued to the NCDOT shall expire only upon expiration of the federal 404 Permit. The conditions in effect on the date of issuance of Certification for a specific project shall remain in effect for the life of the project, regardless of the expiration date of this Certification. If the construction process for approved activities will overlap the expiration and renewal date of the corresponding 404 Permit and the Corps allows for continued use of the 404 Permit, then the General Certification shall also remain in effect without requiring re-application and re-approval to use this Certification for the specific impacts already approved.
17. The applicant/permittee and their authorized agents shall conduct all activities in a manner consistent with State water quality standards (including any requirements resulting from compliance with §303(d) of the Clean Water Act), and any other appropriate requirements of State and Federal Law. If the Division determines that such standards or laws are not being met, including failure to sustain a designated or achieved use, or that State or Federal law is being violated, or that further conditions are necessary to assure compliance, then the Division may reevaluate and modify this General Water Quality Certification.

Non-compliance with or violation of the conditions herein set forth by a specific fill project shall result in revocation of this General Certification for the project and may result in criminal and/or civil penalties.

The Director of the North Carolina Division of Water Quality may require submission of a formal application for individual certification for any project in this category of activity, if it is determined that the project is likely to have a significant adverse effect upon water quality including state or federally listed endangered or threatened aquatic species or degrade the waters so that existing uses of the wetland, stream or downstream waters are precluded.

Public hearings may be held for specific applications or group of applications prior to a Certification decision if deemed in the public's best interest by the Director of the North Carolina Division of Water Quality.

Effective date: November 1, 2007

DIVISION OF WATER QUALITY

By

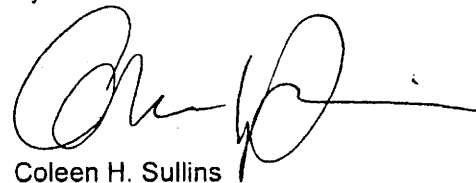

Coleen H. Sullins

Director

History Note: Water Quality Certification (WQC) Number 3701 replaces Water Quality Certification Number 2670 issued on January 21, 1992, WQC Number 2734 issued on May 1 1993, WQC Number 3107 issued on February 11, 1997, WQC Certification Number 3361 issued March 18, 2002, WQC Certification Number 3403 issued March 2003, and WQC Number 3632 issued March 2007. This General Certification is rescinded when the Corps of Engineers re-authorizes Nationwide Permit 23 or when deemed appropriate by the Director of the DWQ.

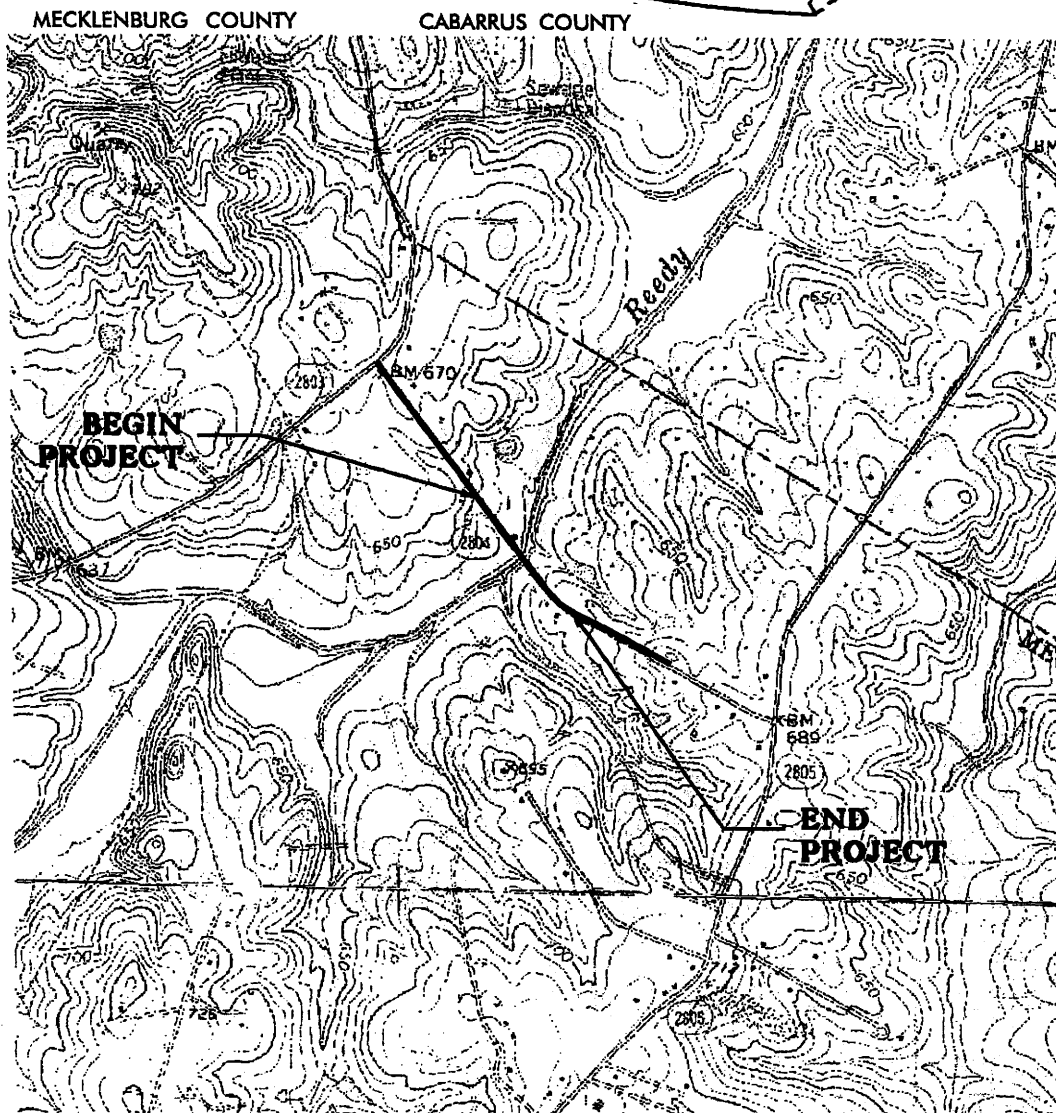
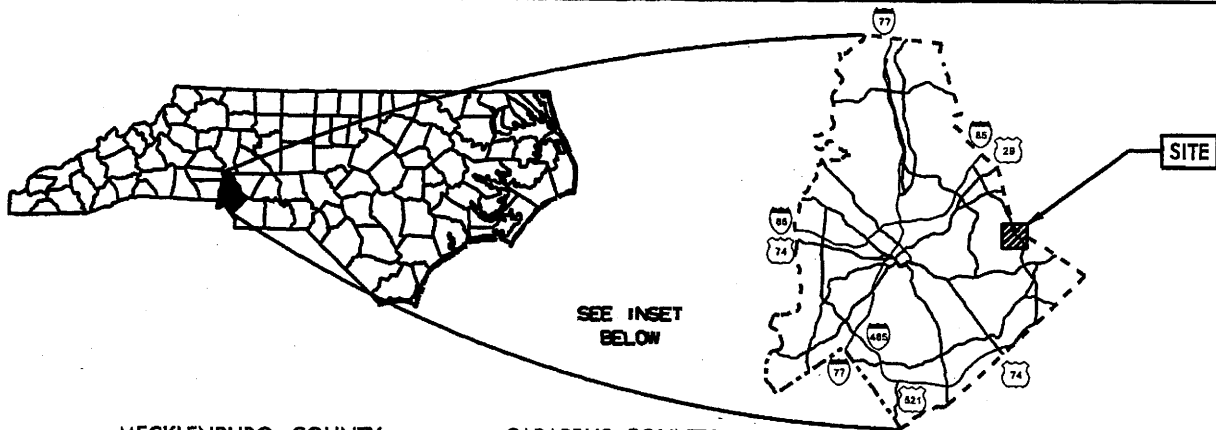

Permit Drawing
Sheet 1 of 8

**WETLAND/STREAM
IMPACTS**

**N.C. DEPT. OF TRANSPORTATION
DIVISION OF HIGHWAYS**
 MECKLENBURG COUNTY
 PROJECT: 33782.1.1 (B-4580)
 BRIDGE NO. 177
 OVER REEDY CREEK
 ON SR 2804 (REEDY CREEK ROAD)
 SHEET ___ OF ___ 05/08/09

WORKPAD DETAIL (NOT TO SCALE)

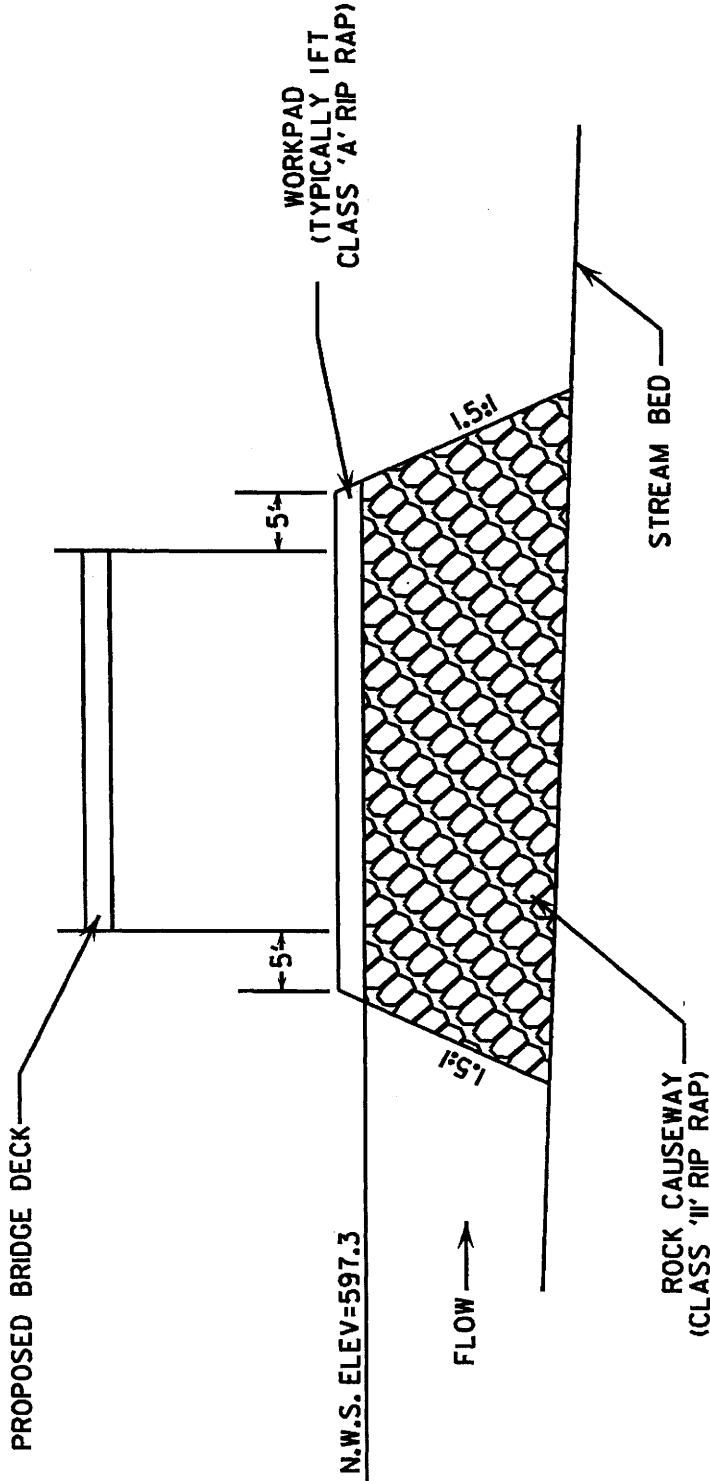

QUANTITIES OF ESTIMATES

VOLUME OF CLASS II RIP RAP= 60 yds³
 AREA OF CLASS II RIP RAP= 0.017 ac
 Estimate 90 Tons Class 'II' Rip Rap
 Estimate 40 Tons Class 'A' Rip Rap

N.C. DEPT. OF TRANSPORTATION
 DIVISION OF HIGHWAYS
 MECKLENBURG COUNTY

PROJECT: 33782.1.1 (B-4580)
 BRIDGE NO. 177

OVER REEDY CREEK
 ON SR 2804 (REEDY CREEK ROAD)

SHEET ___ OF ___ 5/8/09

WETLAND PERMIT IMPACT SUMMARY														
Site No.	Station (From/To)	Structure Size / Type	WETLAND IMPACTS					SURFACE WATER IMPACTS						
			Permanent Fill In Wetlands (ac)	Temp. Fill In Wetlands (ac)	Excavation in Wetlands (ac)	Mechanized Clearing in Wetlands (ac)	Hand Clearing in Wetlands (ac)	Permanent SW impacts (ac)	Temp. SW impacts (ac)	Existing Channel Impacts Permanent (ft)	Existing Channel Impacts Temp. (ft)	Natural Stream Design (ft)		
	32+80-L-LT	RIP RAP										8		
	32+96/33+13-L-RT	RIP RAP	<.01											
	33+14/33+41-L-	BANK STABILIZATION										60		
	32+95/33+23-L-	TEMP. WORKPAD								0.020			60	
TOTALS:			<.01							0.020		68	60	

STREAM IMPACTS DUE TO PIERS= _____ SQ FT

Permit Drawing
Sheet 3 of 2

NC DEPARTMENT OF TRANSPORTATION
DIVISION OF HIGHWAYS
MECKLENBURG COUNTY
33782.1.1 (b-4580)

SHEET

PROPERTY OWNERS
NAMES AND ADDRESSES

PARCEL NO.	NAMES	ADDRESSES
3	JOHN W. AND JOYCE McCOLLUM TEMPLETON	8400 REEDY CREEK RD CHARLOTTE, NC 28215
	NCDOT	716 WEST MAIN STREET ALBEMARLE, NC 28001

Permit Drawing
 Sheet 4 of 8

NCDOT
 DIVISION OF HIGHWAYS
 MECKLENBURG COUNTY
 PROJECT: 33782.1.1 (B-4580)
 BRIDGE NO. 177
 OVER REEDY CREEK
 ON SR 2804
 (REEDY CREEK ROAD)
 SHEET OF 05/08/09

STATE PROJECT NUMBER	B-4580
PROJECT NAME	BRIDGE NO. 177 OVER REEDY CREEK ON SR 2804 (REEDY CREEK ROAD)
DATE	1
SCALE	AS SHOWN
DESIGNER	WANG ENGINEERING COMPANY, INC.
CHECKED BY	CLIFTON T. REGISTER, P.E.
DATE CHECKED	APRIL 17, 2009
APPROVED BY	SCOTT L. KENNEDY, PROJECT DESIGN ENGINEER
DATE APPROVED	APRIL 20, 2010



STATE OF NORTH CAROLINA
DIVISION OF HIGHWAYS
MECKLENBURG COUNTY

LOCATION: BRIDGE NO. 177 OVER REEDY CREEK ON SR 2804 (REEDY CREEK ROAD)

TYPE OF WORK: GRADING, DRAINAGE, STRUCTURE, AND PAVING

WETLAND/STREAM
IMPACTS

R/W PLANS

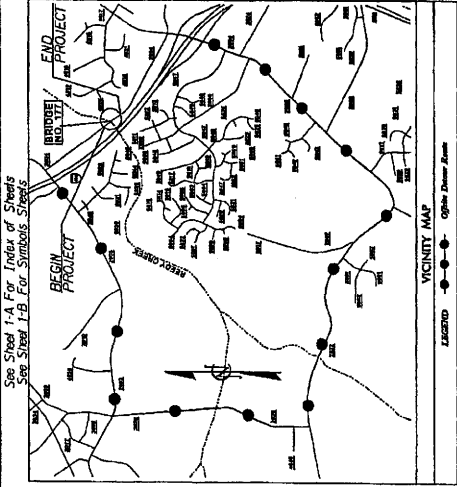

VICINITY MAP
LEGEND: ● Official District Route

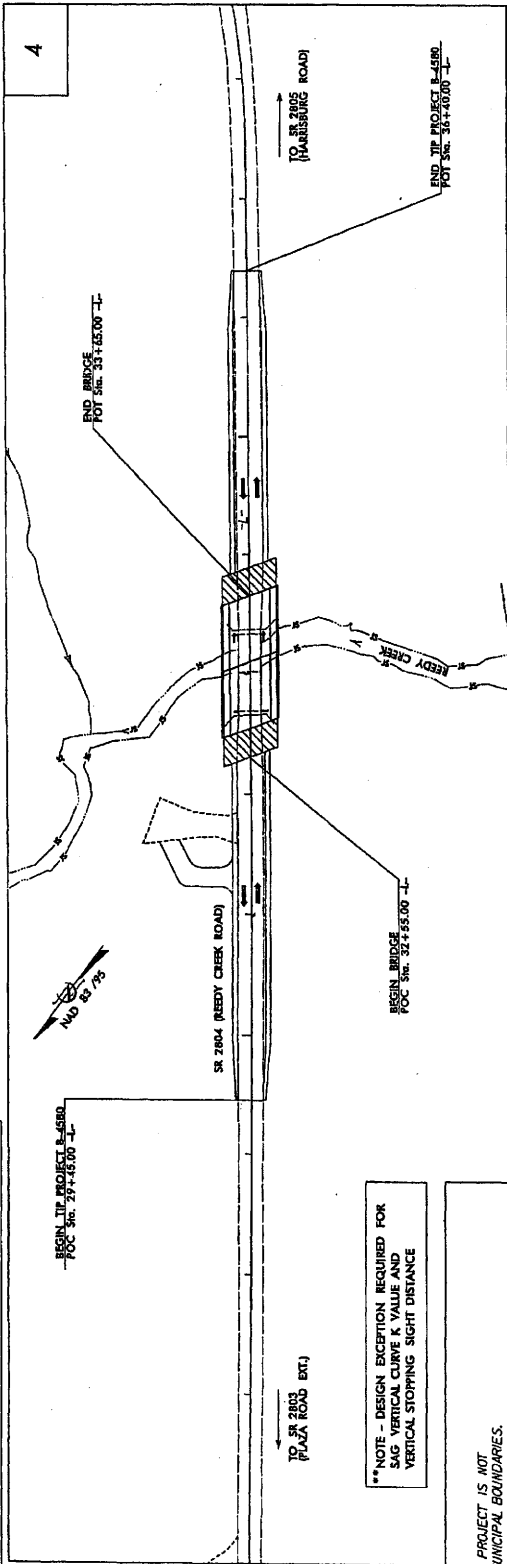

END PROJECT B-4580
POC Sta. 29+45.00 ±

END BRIDGE
POC Sta. 33+55.00 ±

BEGIN BRIDGE
POC Sta. 32+55.00 ±

END TIP PROJECT B-4580
POC Sta. 36+60.00 ±

**NOTE - DESIGN EXCEPTION REQUIRED FOR
SAG VERTICAL CURVE K VALUE AND
VERTICAL STOPPING SIGHT DISTANCE

THIS PROJECT IS NOT
WITHIN MUNICIPAL BOUNDARIES.

PROJECT CONTRACT: DOUG T. RYAN, P.E., PROJECT ENGINEER - ROADWAY DESIGN

CLEARING ON THIS PROJECT SHALL BE ESTABLISHED BY METHOD III

GRAPHIC SCALES	DESIGN DATA
50 25 0 50 100 PLANS	ADT 2010 = 6,300
50 25 0 50 100 PROFILE (HORIZONTAL)	ADT 2030 = 10,000
10 5 0 10 20 PROFILE (VERTICAL)	DHV = 12 %
	D = 55 %
	T = 3 %
	* * V = 50 MPH
	FUNC. CLASS = RURAL LOCAL
	* TST 1 % DUAL 2 %

PROJECT LENGTH	
LENGTH ROADWAY TIP PROJECT B-4580	= 0.111 mi.
LENGTH STRUCTURE TIP PROJECT B-4580	= 0.021 mi.
TOTAL LENGTH TIP PROJECT B-4580	= 0.132 mi.

WANG ENGINEERING COMPANY, INC.
FOR NORTH CAROLINA DEPARTMENT OF TRANSPORTATION
RIGHT OF WAY DATE: APRIL 17, 2009
LETTING DATE: APRIL 20, 2010
CLIFTON T. REGISTER, P.E.
PROJECT DESIGNER
SCOTT L. KENNEDY
PROJECT DESIGN ENGINEER

DIVISION OF HIGHWAYS
STATE OF NORTH CAROLINA

STAFF ENGINEER DESIGN ENGINEER P.E.

TIP PROJECT: B-4580

CONTRACT:

PRELIMINARY PLANS
DO NOT USE FOR CONSTRUCTION

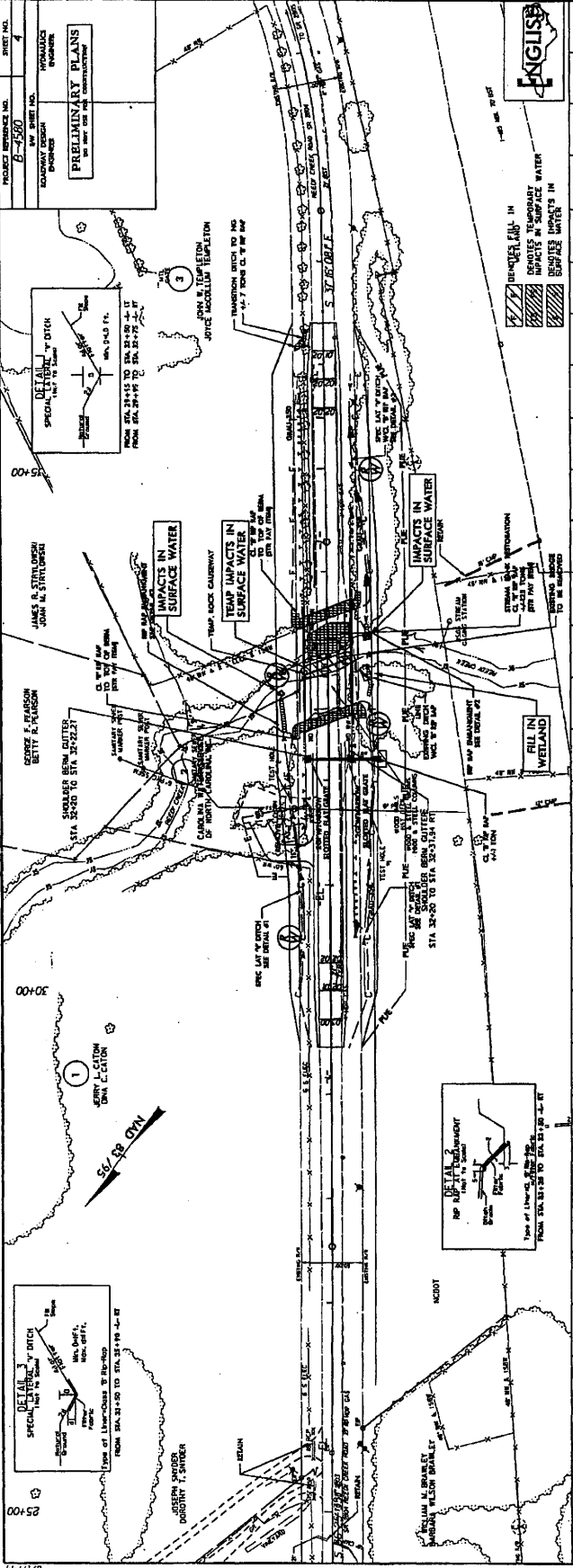

PROJECT NUMBER	8-2500
DATE	10/2/82
DESIGNER	W. J. HARRIS
CHECKER	J. HARRIS
APPROVED	J. HARRIS
PRELIMINARY PLANS	
NO PART OF THIS DRAWING IS TO BE REPRODUCED OR TRANSMITTED IN ANY FORM OR BY ANY MEANS WITHOUT THE WRITTEN PERMISSION OF THE ENGINEER.	

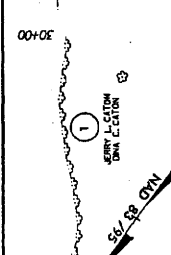
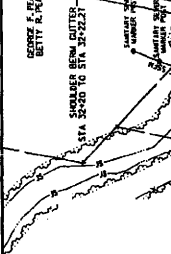
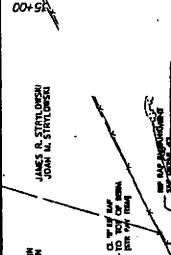
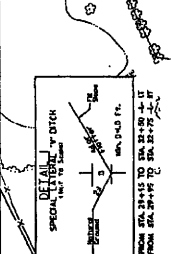

ELEVATION	STATION	STRUCTURE PLAN
650	39	SEE STRUCTURE PLANS S-1 THRU S-5
640	38	
630	37	
620	36	
610	35	
600	34	
590	33	
580	32	
570	31	
560	30	
550	29	
540	28	
530	27	
520	26	
510	25	
500	24	
490	23	
480	22	
470	21	
460	20	
450	19	
440	18	
430	17	
420	16	
410	15	
400	14	
390	13	
380	12	
370	11	
360	10	
350	9	
340	8	
330	7	
320	6	
310	5	
300	4	
290	3	
280	2	
270	1	
260	0	
250	-1	
240	-2	
230	-3	
220	-4	
210	-5	
200	-6	
190	-7	
180	-8	
170	-9	
160	-10	
150	-11	
140	-12	
130	-13	
120	-14	
110	-15	
100	-16	
90	-17	
80	-18	
70	-19	
60	-20	
50	-21	
40	-22	
30	-23	
20	-24	
10	-25	
0	-26	
-10	-27	
-20	-28	
-30	-29	
-40	-30	
-50	-31	
-60	-32	
-70	-33	
-80	-34	
-90	-35	
-100	-36	
-110	-37	
-120	-38	
-130	-39	
-140	-40	
-150	-41	
-160	-42	
-170	-43	
-180	-44	
-190	-45	
-200	-46	
-210	-47	
-220	-48	
-230	-49	
-240	-50	
-250	-51	
-260	-52	
-270	-53	
-280	-54	
-290	-55	
-300	-56	
-310	-57	
-320	-58	
-330	-59	
-340	-60	
-350	-61	
-360	-62	
-370	-63	
-380	-64	
-390	-65	
-400	-66	
-410	-67	
-420	-68	
-430	-69	
-440	-70	
-450	-71	
-460	-72	
-470	-73	
-480	-74	
-490	-75	
-500	-76	
-510	-77	
-520	-78	
-530	-79	
-540	-80	
-550	-81	
-560	-82	
-570	-83	
-580	-84	
-590	-85	
-600	-86	
-610	-87	
-620	-88	
-630	-89	
-640	-90	
-650	-91	
-660	-92	
-670	-93	
-680	-94	
-690	-95	
-700	-96	
-710	-97	
-720	-98	
-730	-99	
-740	-100	
-750	-101	
-760	-102	
-770	-103	
-780	-104	
-790	-105	
-800	-106	
-810	-107	
-820	-108	
-830	-109	
-840	-110	
-850	-111	
-860	-112	
-870	-113	
-880	-114	
-890	-115	
-900	-116	
-910	-117	
-920	-118	
-930	-119	
-940	-120	
-950	-121	
-960	-122	
-970	-123	
-980	-124	
-990	-125	
-1000	-126	

BRIDGE HYDRAULIC DATA	
DESIGN DISCHARGE	= 4700 CFS
DESIGN FREQUENCY	= 25 YR
DESIGN ELEVATION	= 5150 CFS
BASE DISCHARGE	= 5150 CFS
BASE FREQUENCY	= 100 YR
BASE ELEVATION	= 623'
OVERTOPPING DISCHARGE	= 5950 CFS
OVERTOPPING FREQUENCY	= 100 YR
OVERTOPPING ELEVATION	= 6200'
DATE OF SURVEY	= 10/10/82
W.S. ELEVATION AT DATE OF SURVEY	= 597.30'

* NOTE - DESIGN EXCEPTION REQUIRED FOR SAG VERTICAL CURVE X VALUE AND VERTICAL STOPPING SIGHT DISTANCE

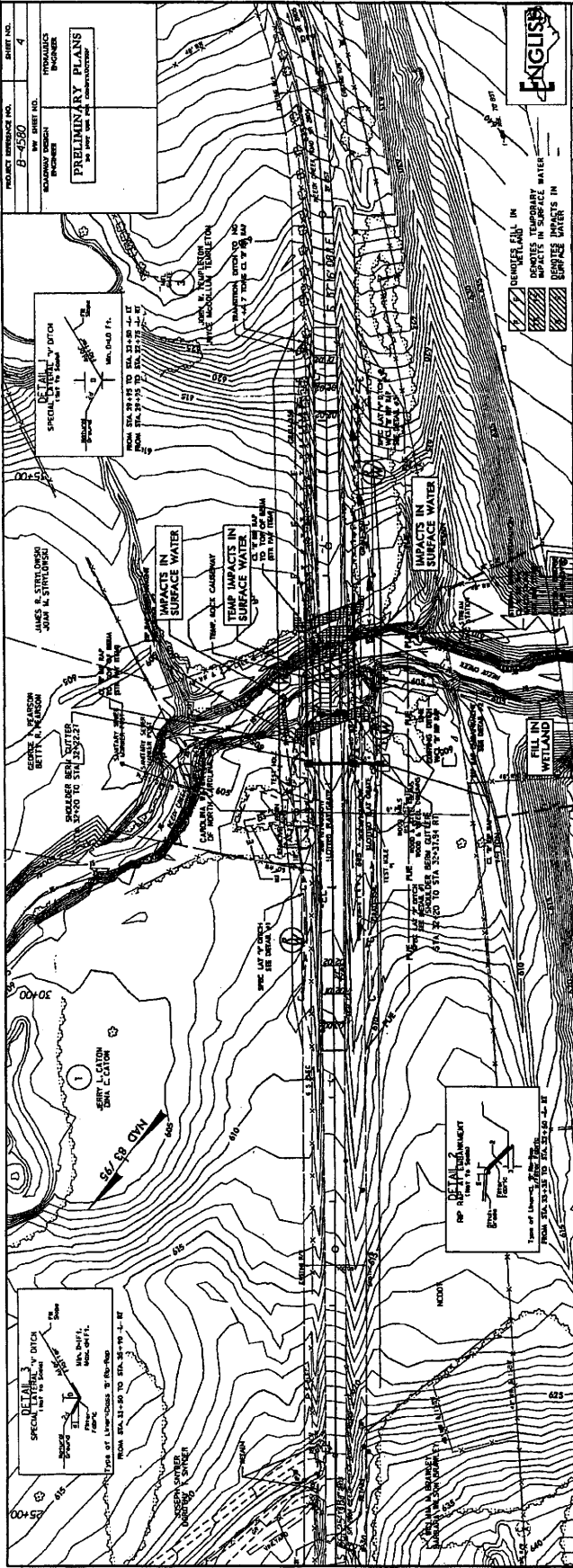

Elevation	Stationing	Notes
650	39	SEE STRUCTURE PLANS S-1 THRU S-
640	38	
630	37	
620	36	
610	35	
600	34	
590	33	
580	32	
570	31	
560	30	

BRIDGE HYDRAULIC DATA

DESIGN DISCHARGE	= 4700 CFS
DESIGN FREQ	= 25 YR
DESIGN HW ELEVATION	= 61.57
BASE DISCHARGE	= 2700 CFS
DESIGN FREQ	= 10 YR
BASE HW ELEVATION	= 62.31
OVERTOPPING DISCHARGE	= 9550 CFS
OVERTOPPING FREQ	= 25 YR
OVERTOPPING HW ELEVATION	= 64.07
DATE OF SURVEY	= 10/10/07
AT DATE OF SURVEY	= 597.30'

* NOTE - DESIGN EXCEPTION REQUIRED FOR SAG VERTICAL CURVE K VALUE AND VERTICAL STOPPING SIGHT DISTANCE

PROJECT NUMBER NO. B-4580
 SHEET NO. 4
 PREPARED BY: HYDRAULICS ENGINEER
 CHECKED BY: CIVIL ENGINEER
 DATE: 10/10/07

DETAIL 3
 SPECIALTY DITCH
 FROM STA. 31+00 TO STA. 31+10
 1:1 SLOPE
 10' MIN. WIDTH

DETAIL 4
 SPECIALTY DITCH
 FROM STA. 32+00 TO STA. 32+10
 1:1 SLOPE
 10' MIN. WIDTH

DETAIL 5
 SPECIALTY DITCH
 FROM STA. 33+00 TO STA. 33+10
 1:1 SLOPE
 10' MIN. WIDTH

DETAIL 6
 SPECIALTY DITCH
 FROM STA. 34+00 TO STA. 34+10
 1:1 SLOPE
 10' MIN. WIDTH

DETAIL 7
 SPECIALTY DITCH
 FROM STA. 35+00 TO STA. 35+10
 1:1 SLOPE
 10' MIN. WIDTH

DETAIL 8
 SPECIALTY DITCH
 FROM STA. 36+00 TO STA. 36+10
 1:1 SLOPE
 10' MIN. WIDTH

