

APPENDIX D.1C: FIELD DATA SHEETS - APPROACH BENTS

Field Sheet Notation Legend	
CK/CR	Crack (width noted in inches)
CS/RS	Corrosion/rust stain
CS AGG	Corrosion stain at exposed aggregate
DIA	Diaphragm
DIAG	Diagonal
DL	Delamination
EF	Efflorescence
ER	Exposed rebar
ERx2	2 exposed bars
ES	Exposed prestressing strand
ESx2	2 exposed strands
HL CK	Hairline crack
HVY	Heavy
PTH	Patch
SP	Spall
SR	Shotcrete repair
-0.XXX V	Half-cell potential measurement in volts
XXX μ s	Ultrasonic pulse velocity measurement in micro seconds

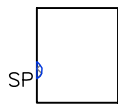

West Elevation

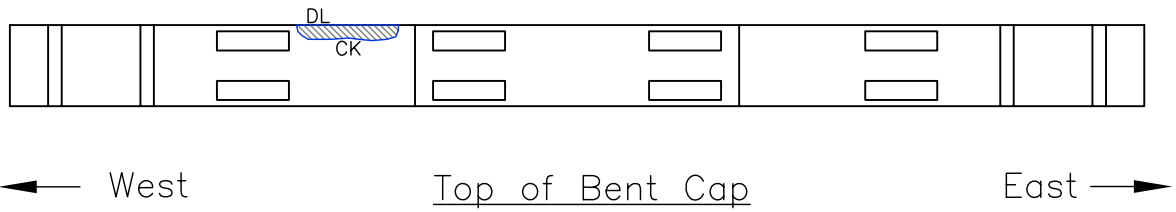

East Elevation

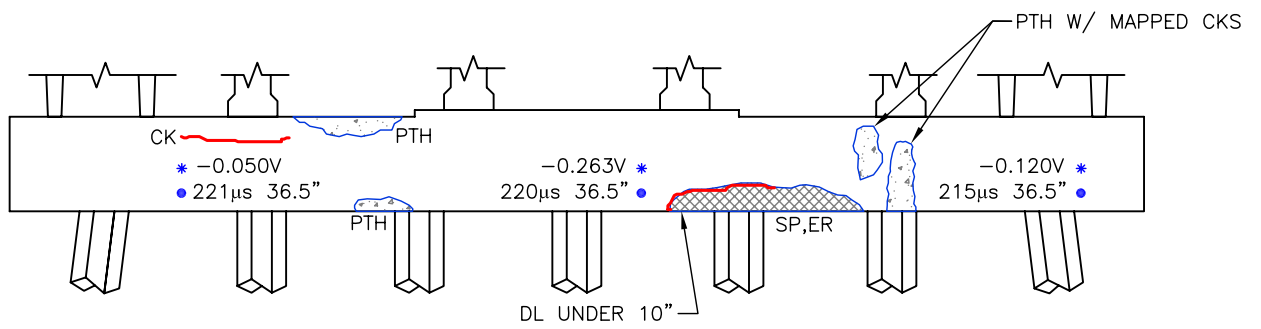
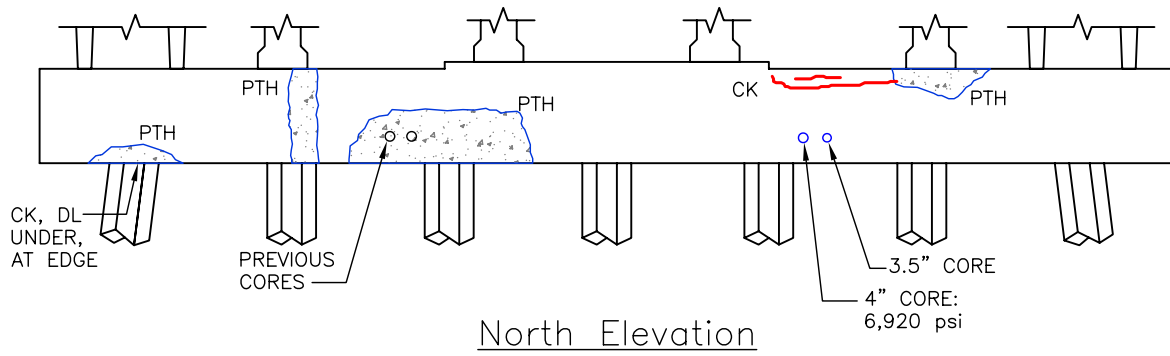

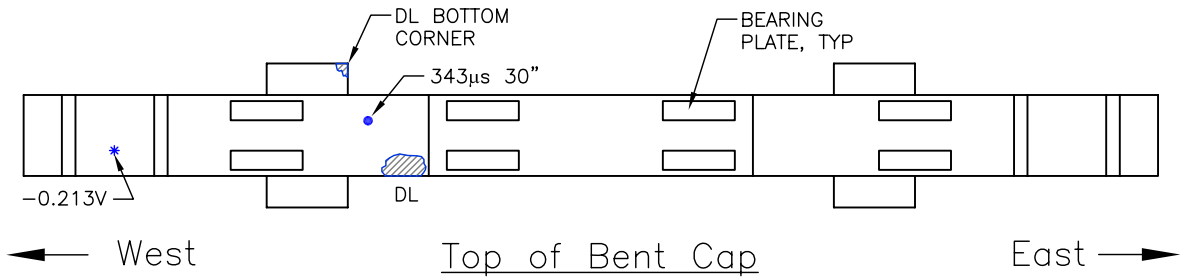

West Elevation

East Elevation

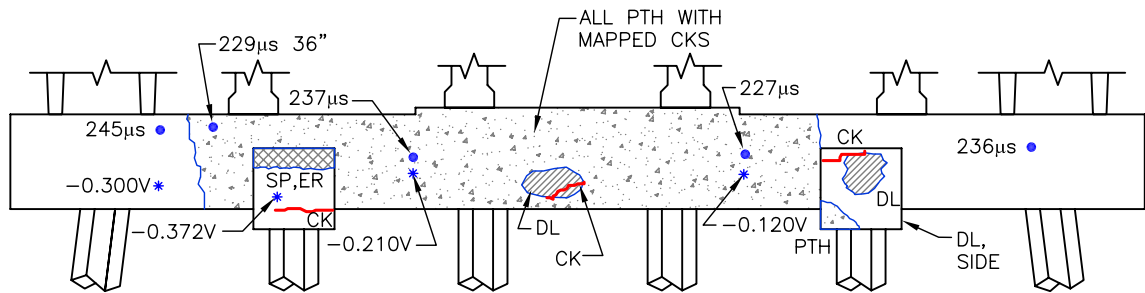

North Elevation

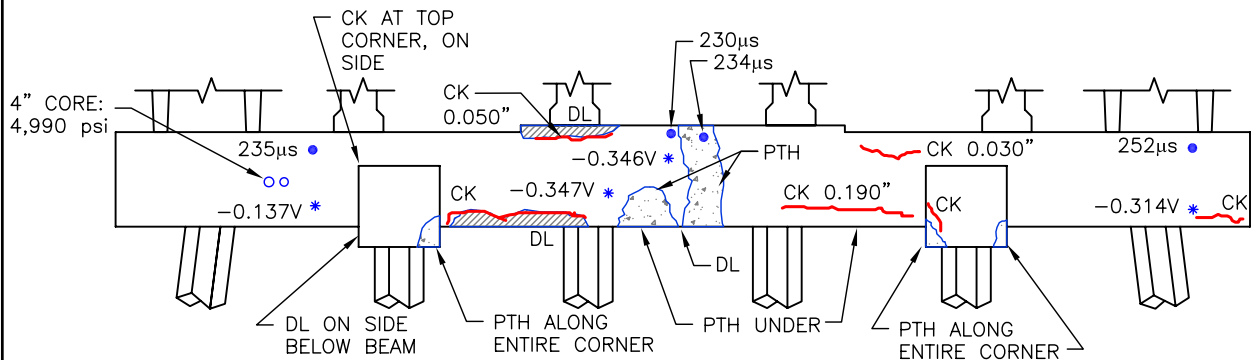

South Elevation

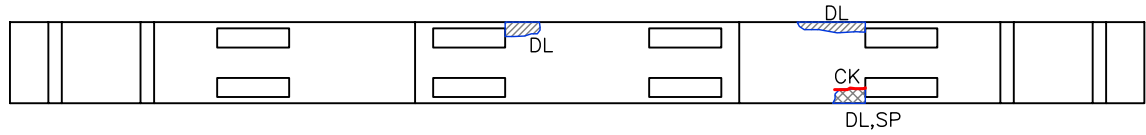

← West

Top of Bent Cap

East →

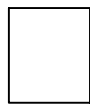

West Elevation



East Elevation

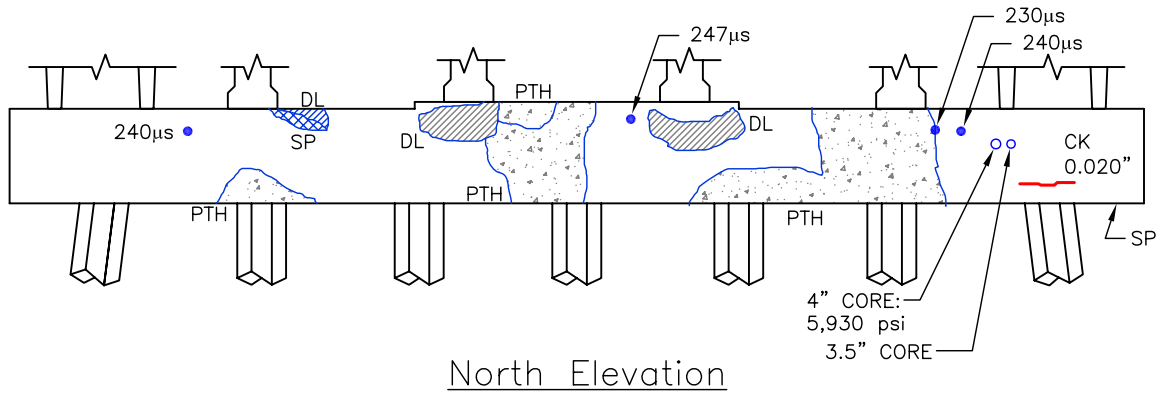

North Elevation

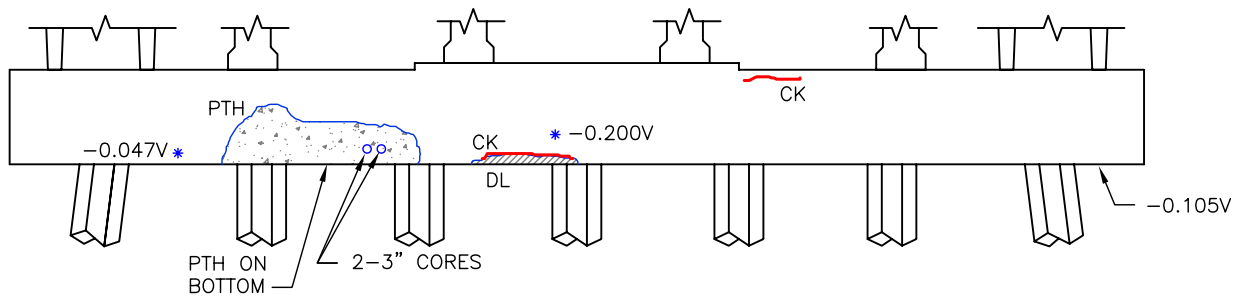

South Elevation

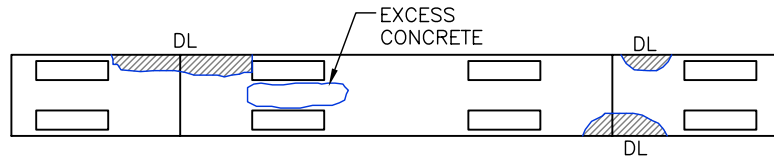

West ← Top of Bent Cap → East

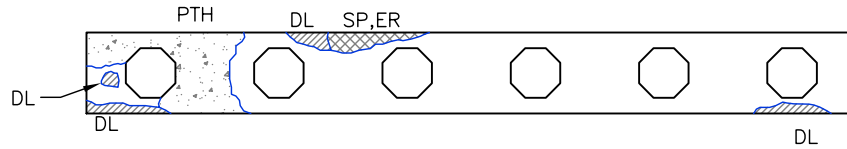

West ← Soffit of Bent Cap → East

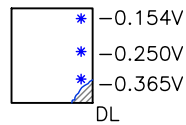

West Elevation

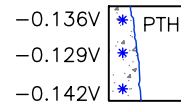

East Elevation

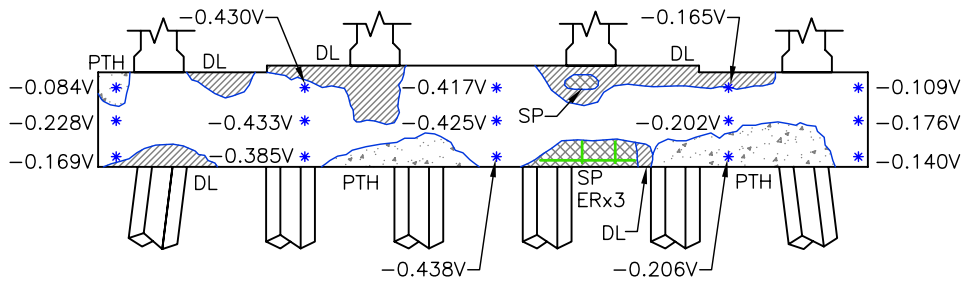

North Elevation

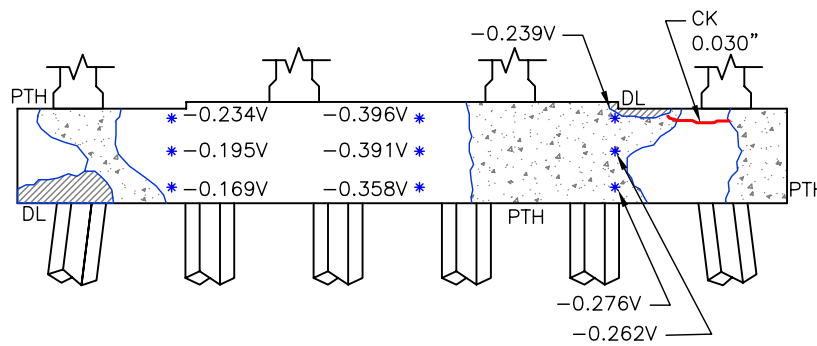

South Elevation

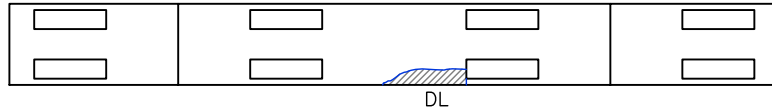

West ← Top of Bent Cap → East

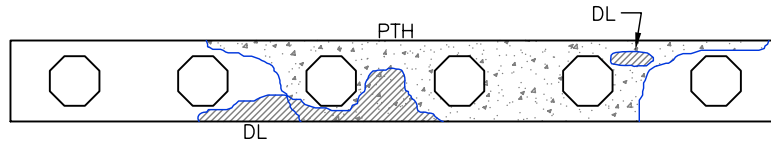

West ← Soffit of Bent Cap → East

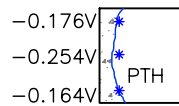

West Elevation

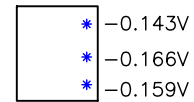

East Elevation

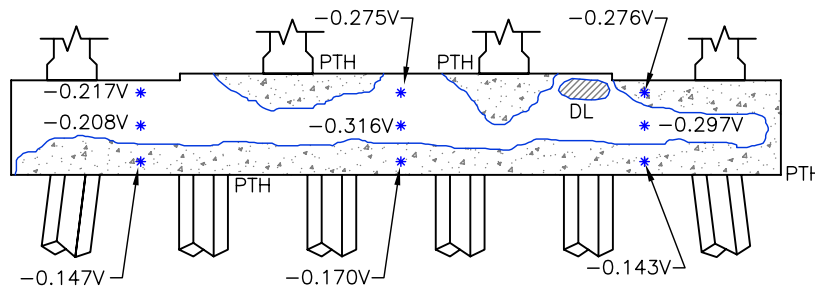

North Elevation

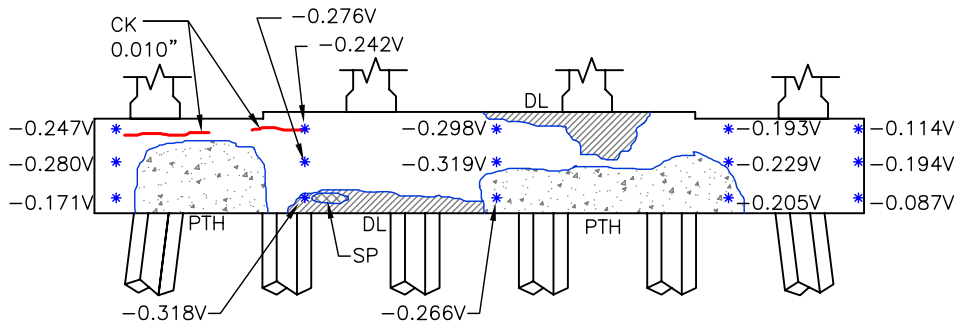

South Elevation

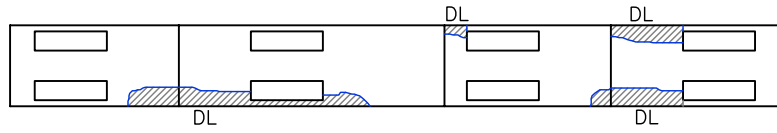

← West Top of Bent Cap East →

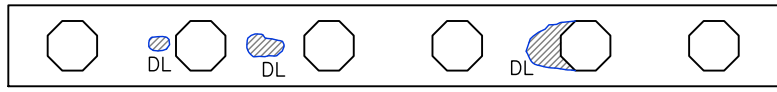

← West Soffit of Bent Cap East →

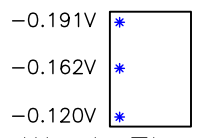

West Elevation

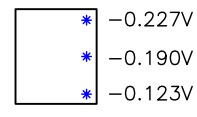

East Elevation

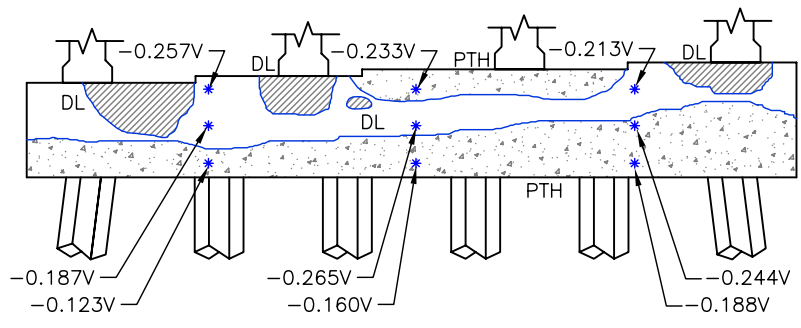

North Elevation

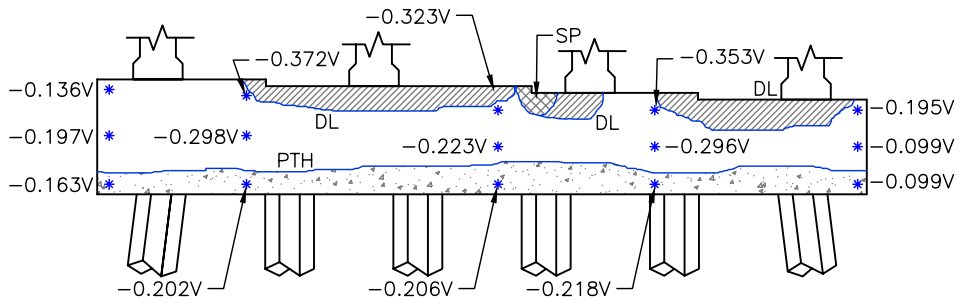

South Elevation

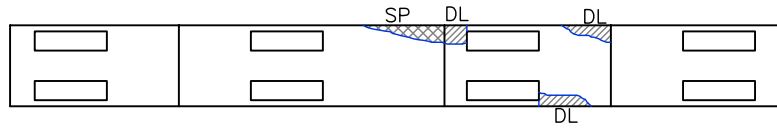

← West

Top of Bent Cap

East →

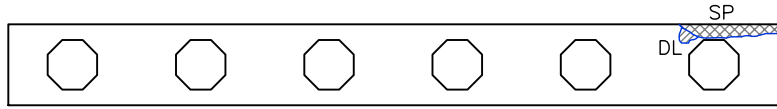

← West

Soffit of Bent Cap

East →

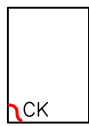

West Elevation



East Elevation

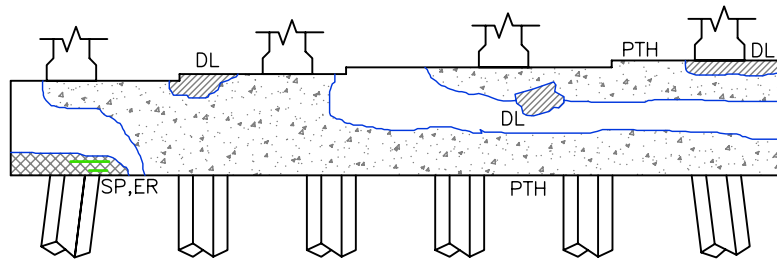

North Elevation

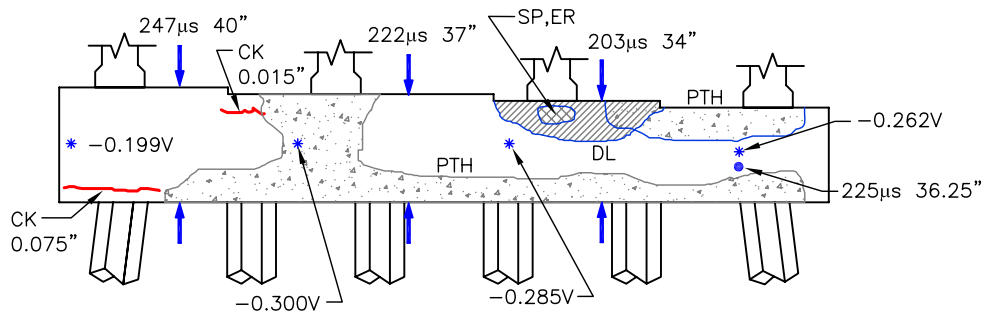

South Elevation

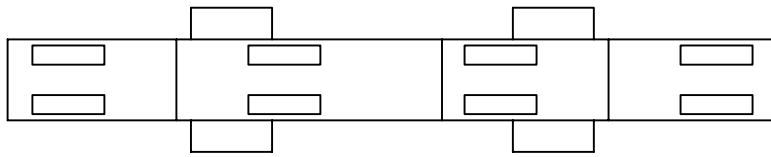

← West

Top of Bent Cap

East →

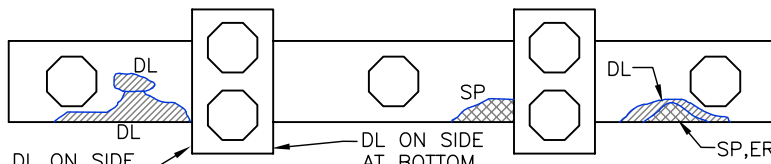

← West

Soffit of Bent Cap

East →

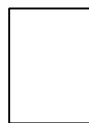

West Elevation



East Elevation

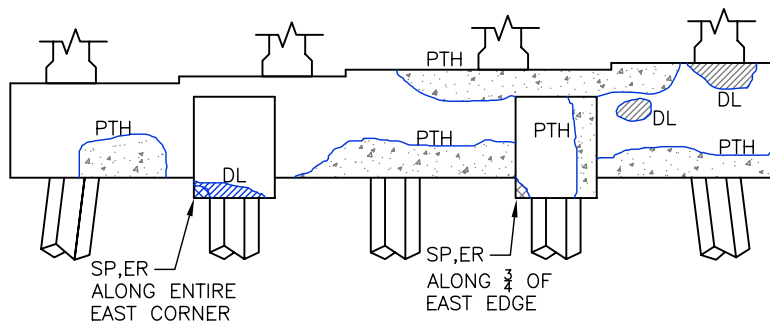

North Elevation

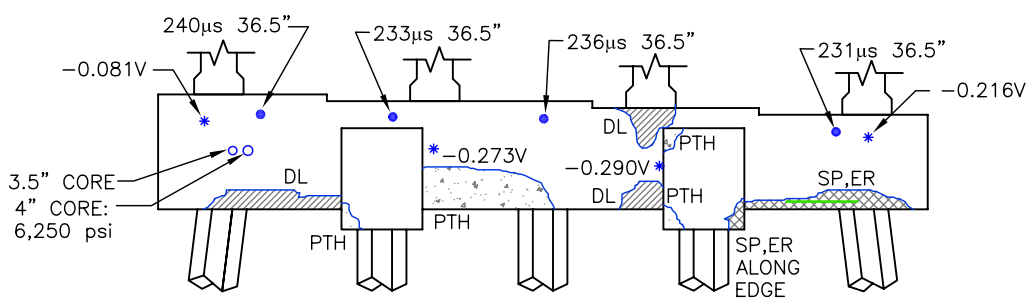

South Elevation

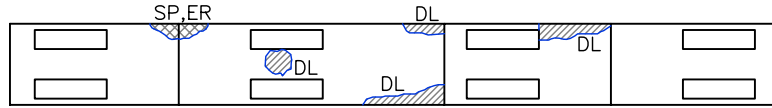

← West

Top of Bent Cap

East →



West Elevation



East Elevation

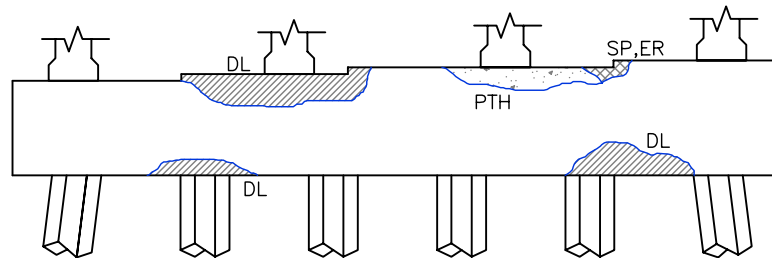

North Elevation

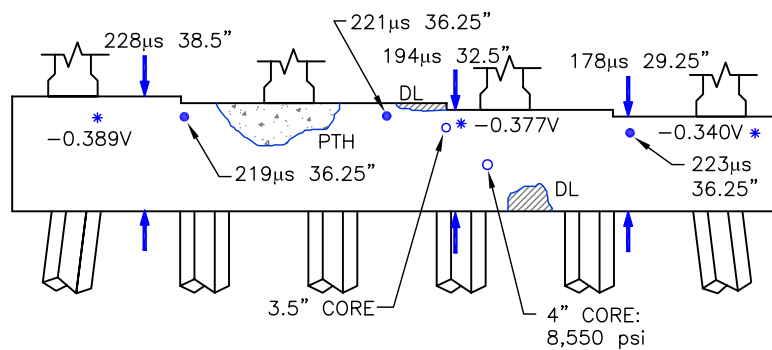

South Elevation



← West

Top of Bent Cap

East →

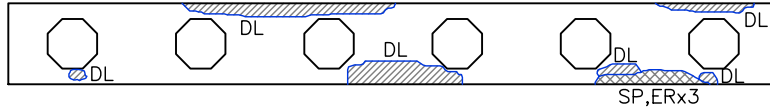

← West

Soffit of Bent Cap

East →



West Elevation



East Elevation

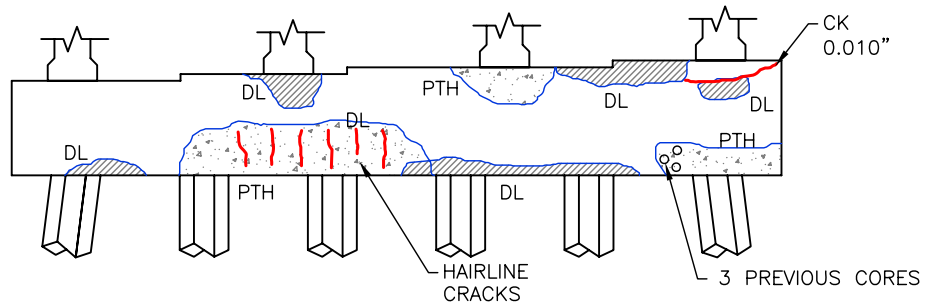

North Elevation

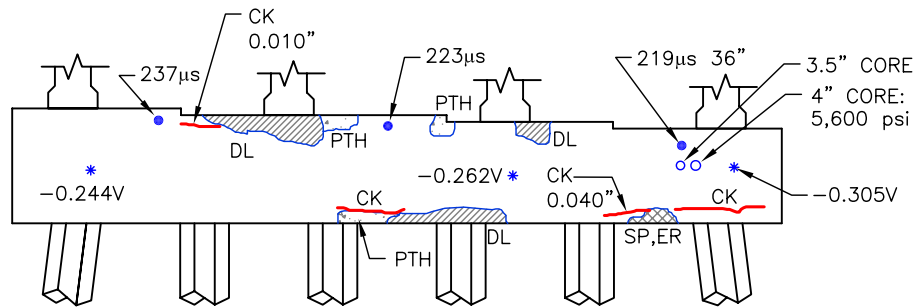

South Elevation

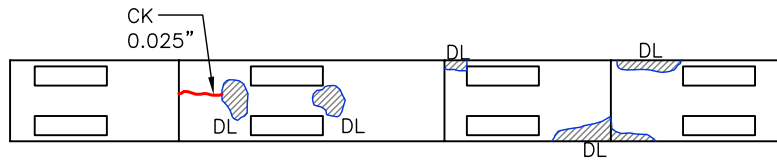

← West

Top of Bent Cap

East →

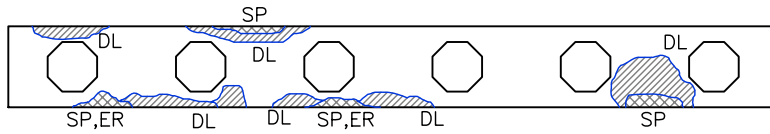

← West

Soffit of Bent Cap

East →



West Elevation



East Elevation

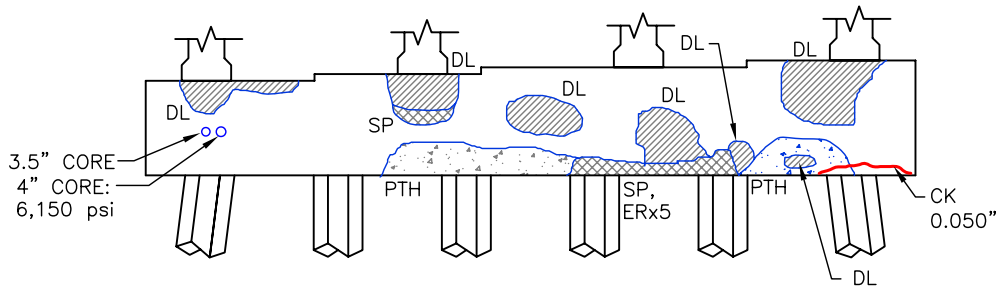

North Elevation

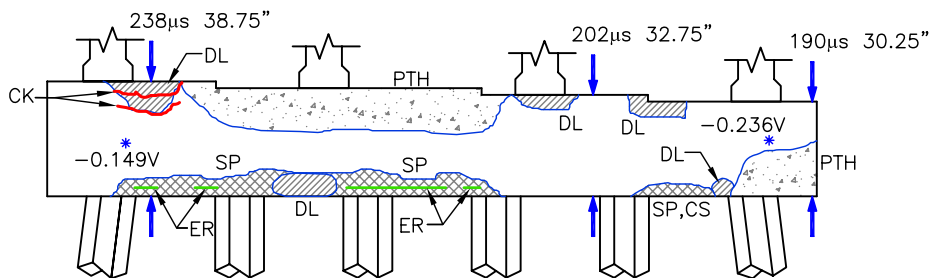

South Elevation

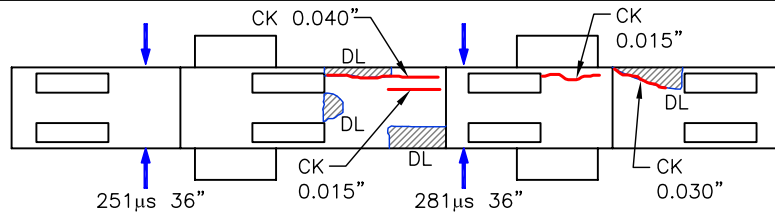

← West Top of Bent Cap East →

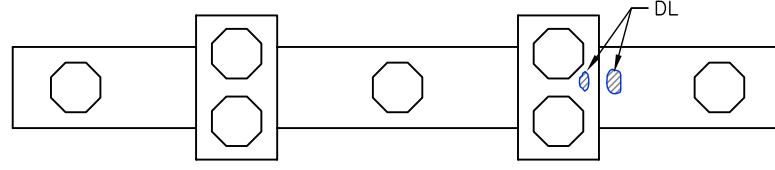

← West Soffit of Bent Cap East →



West Elevation East Elevation

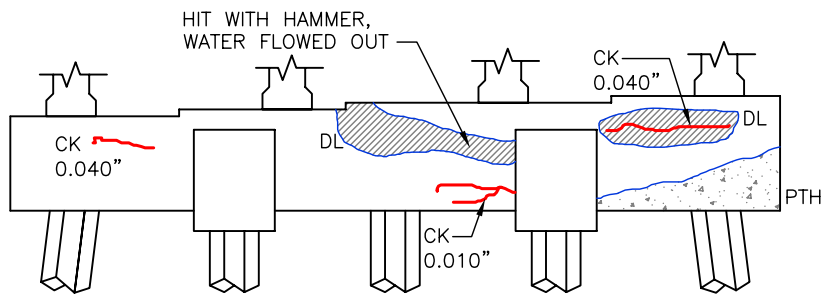

North Elevation

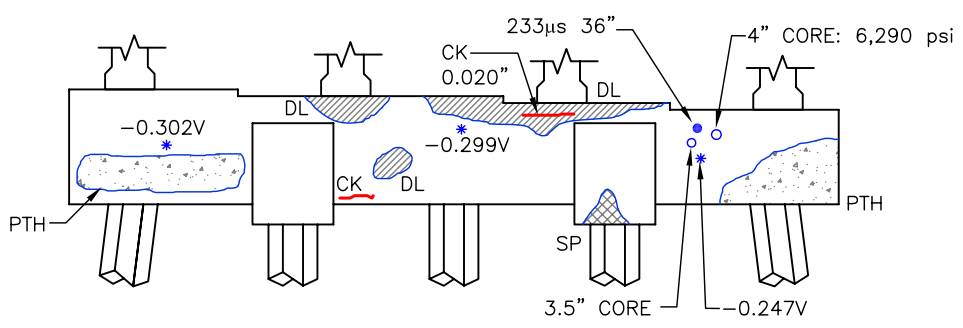

South Elevation

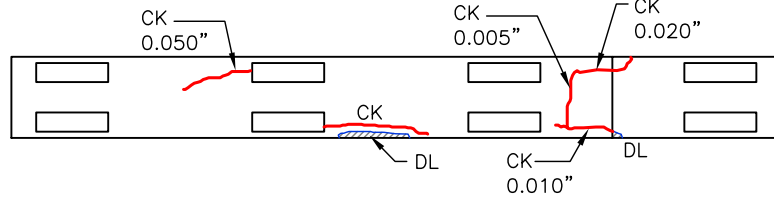

← West

Top of Bent Cap

East →

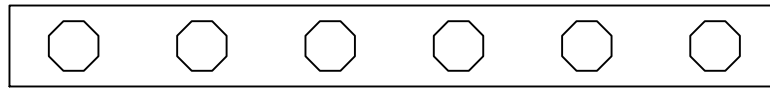

← West

Soffit of Bent Cap

East →



West Elevation

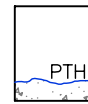

East Elevation

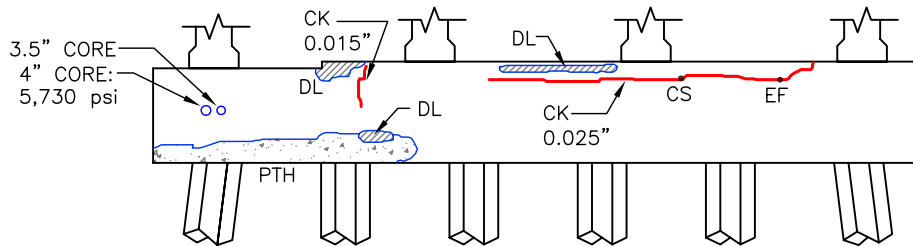

North Elevation

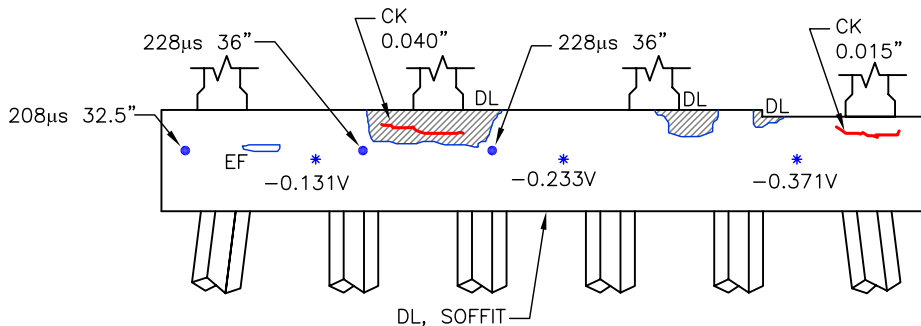

South Elevation

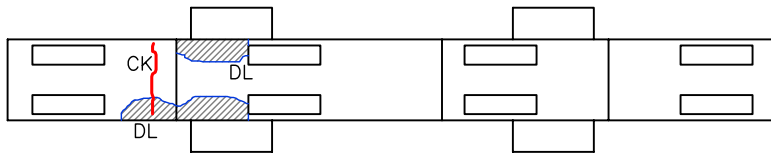

← West

Top of Bent Cap

East →

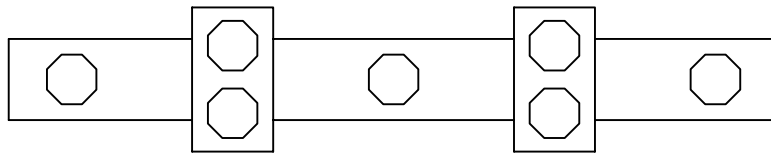

← West

Soffit of Bent Cap

East →

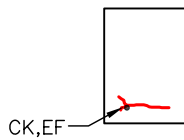

West Elevation



East Elevation

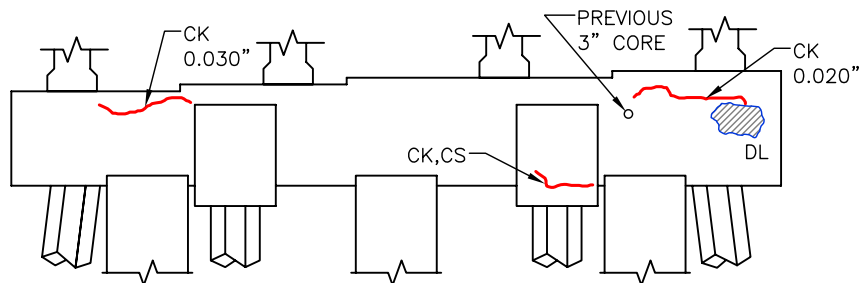

North Elevation

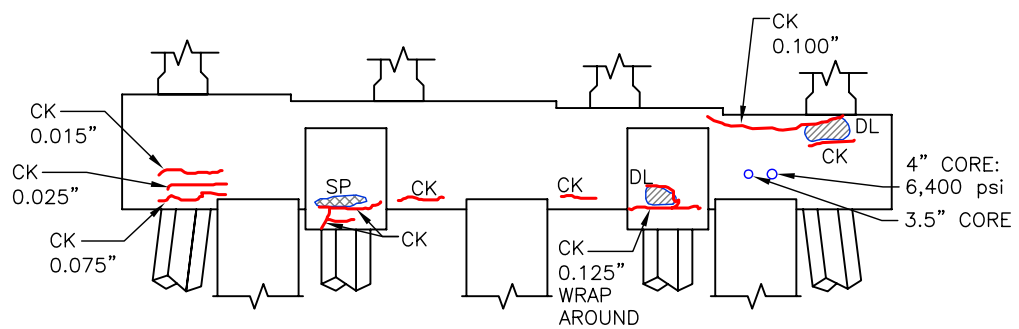

South Elevation

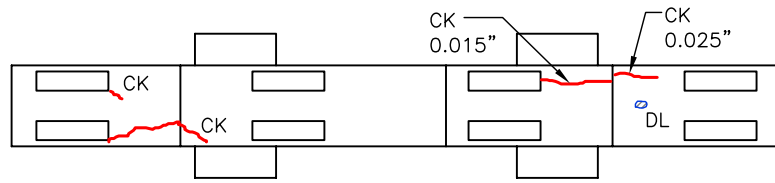

West ← Top of Bent Cap → East

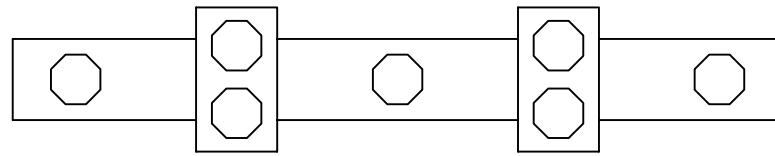

West ← Soffit of Bent Cap → East

West Elevation

East Elevation

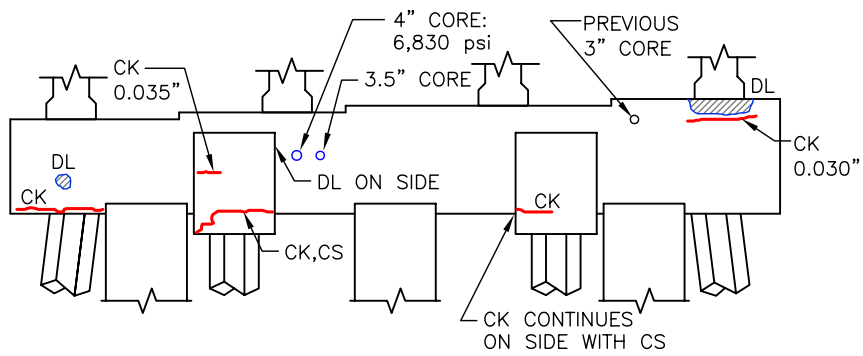

North Elevation

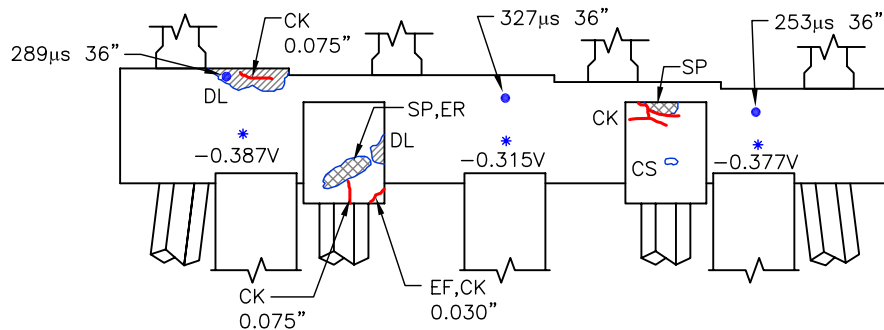

South Elevation

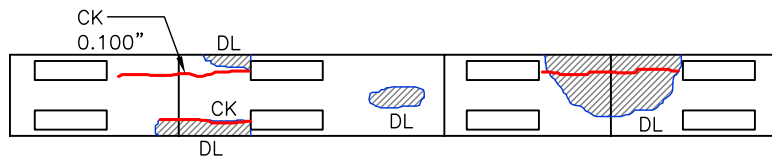

← West

Top of Bent Cap

East →

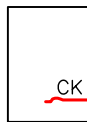

West Elevation



East Elevation

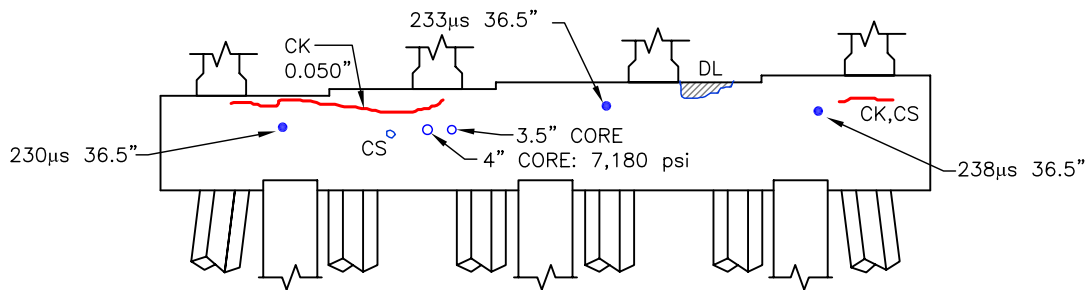

North Elevation

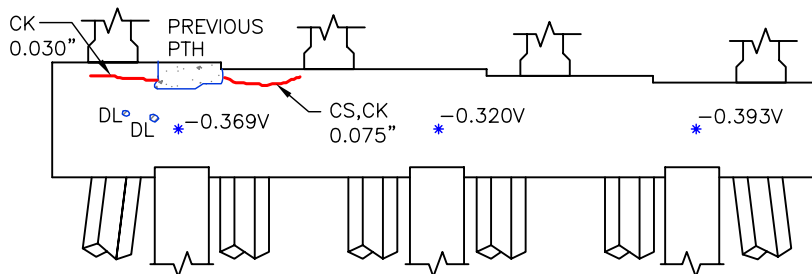

South Elevation

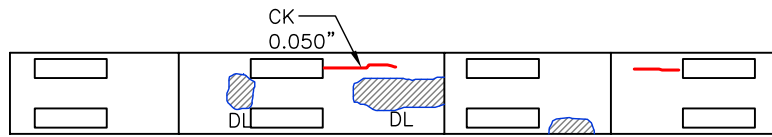

← West

Top of Bent Cap

East →

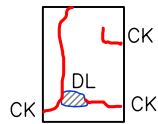

West Elevation

East Elevation

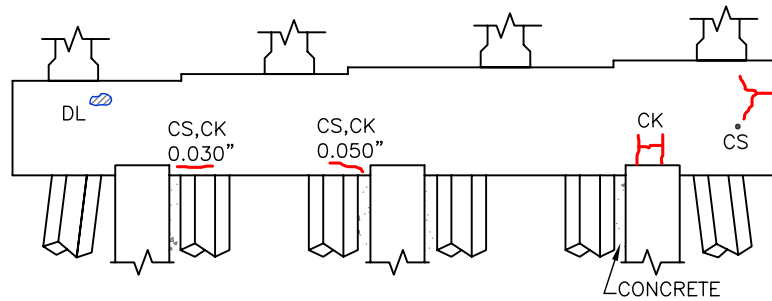

North Elevation

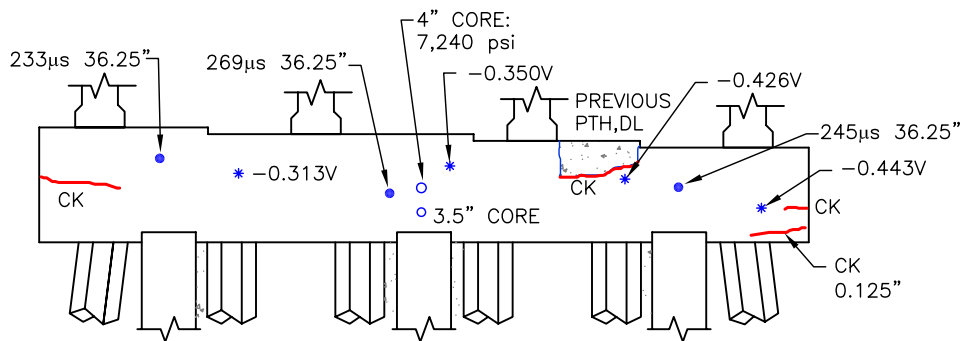

South Elevation

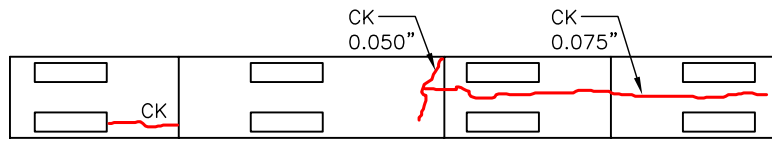

← West

Top of Bent Cap

East →

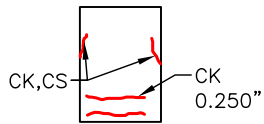

West Elevation

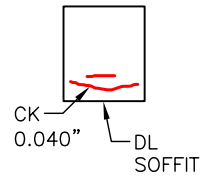

East Elevation

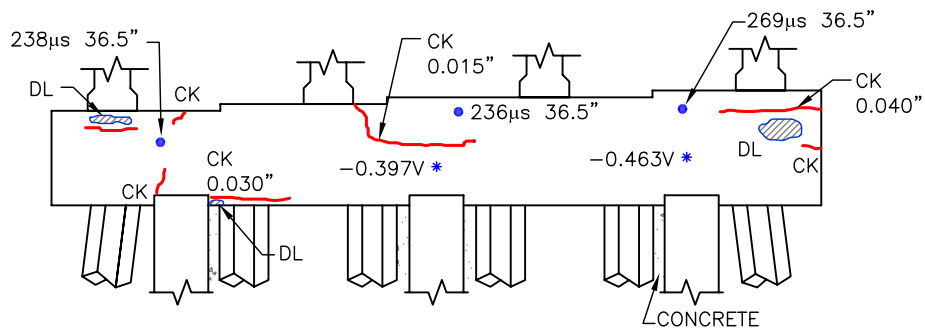

North Elevation

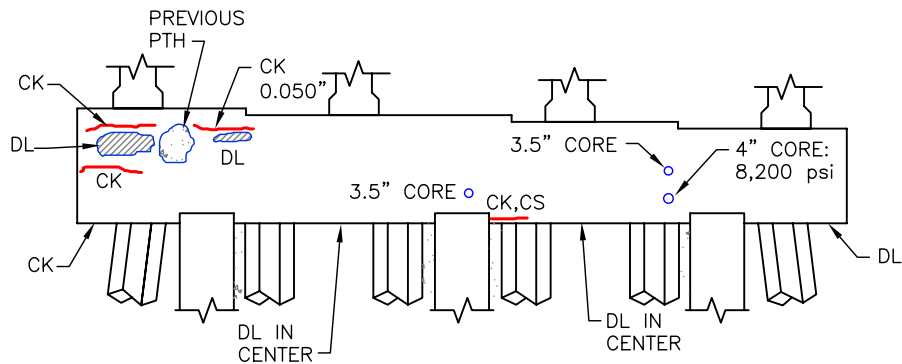

South Elevation

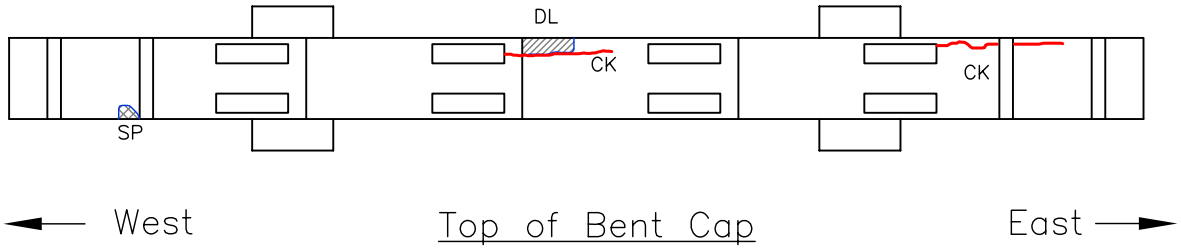

West Elevation

East Elevation

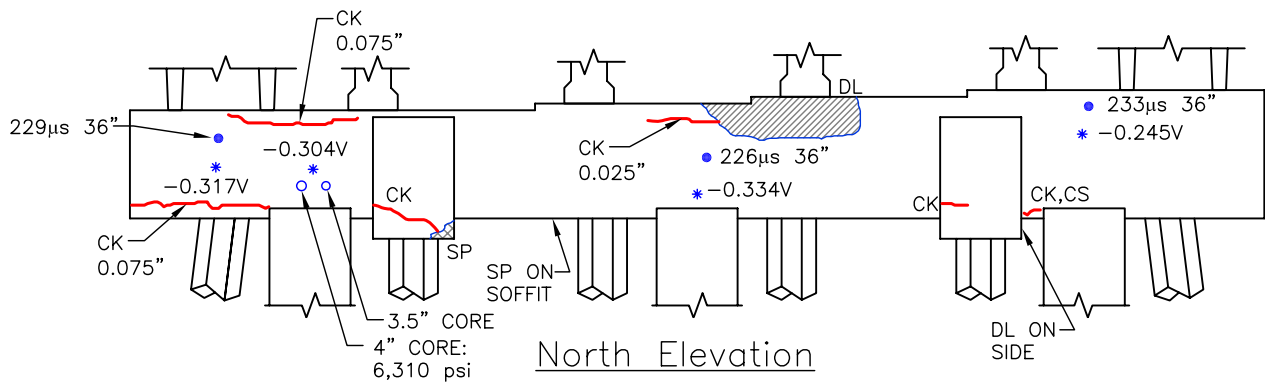

South Elevation

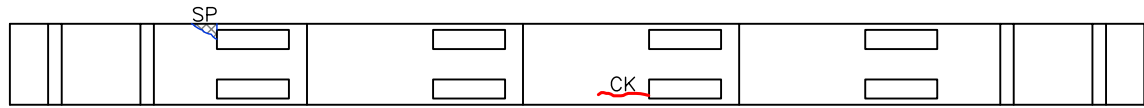

← West

Top of Bent Cap

East →

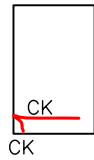

West Elevation



East Elevation

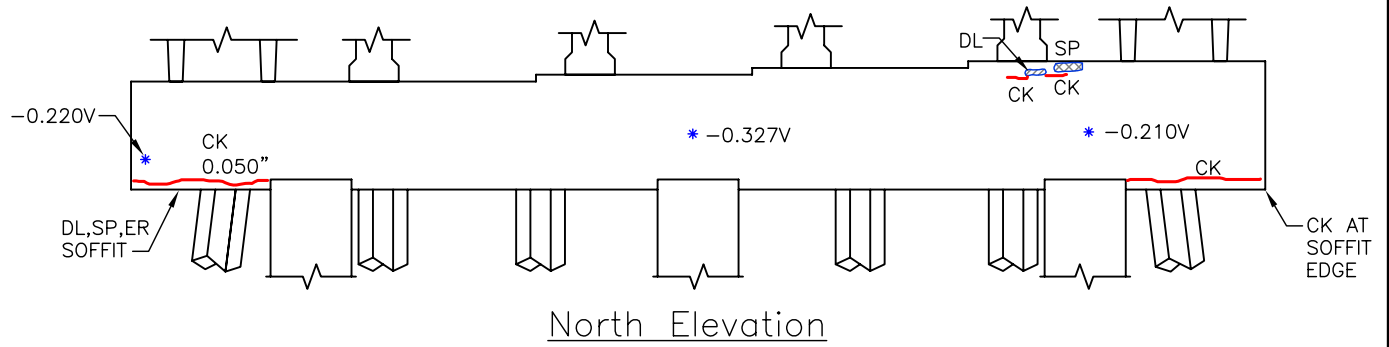

North Elevation

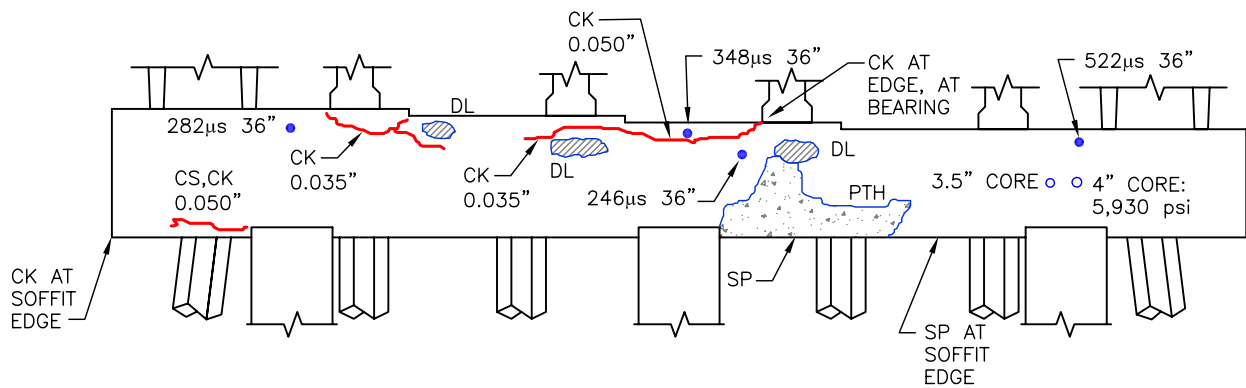

South Elevation

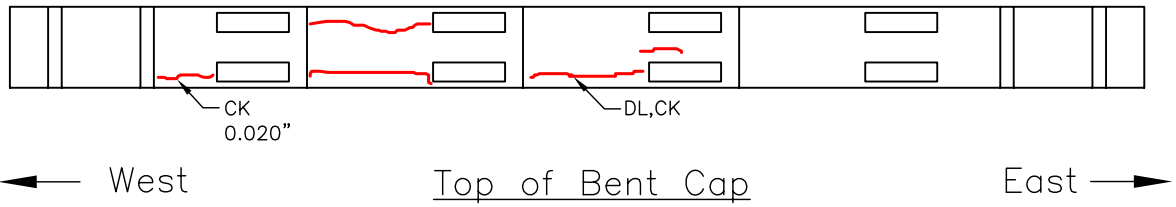

West Elevation

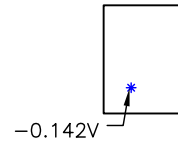

East Elevation

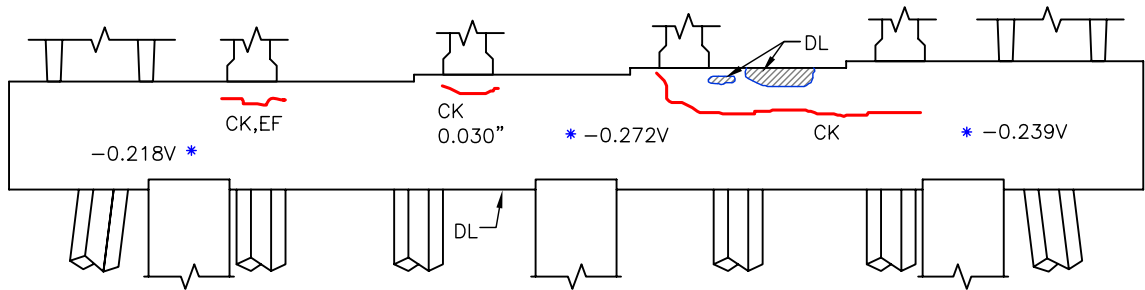

North Elevation

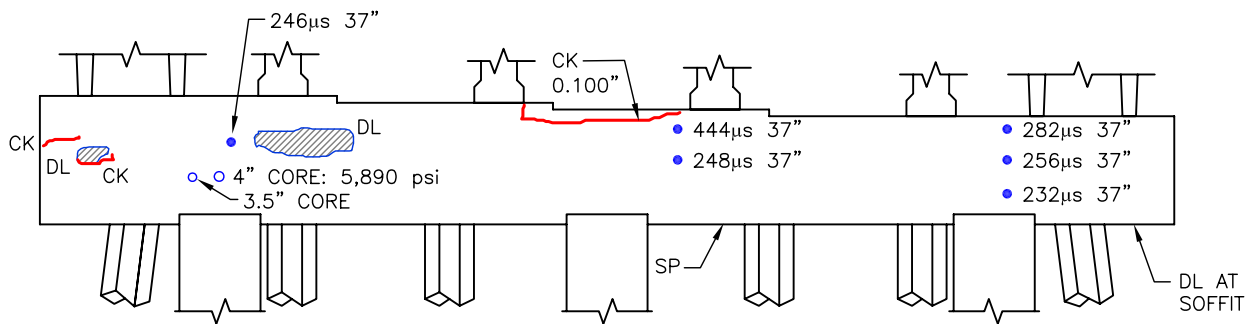

South Elevation



← West

Top of Bent Cap

East →

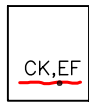

West Elevation

East Elevation

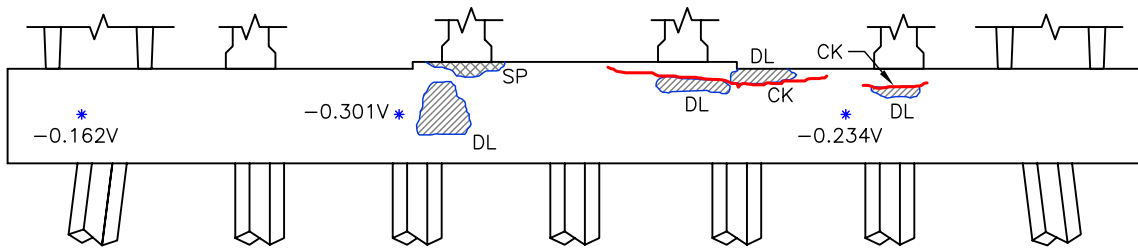

North Elevation

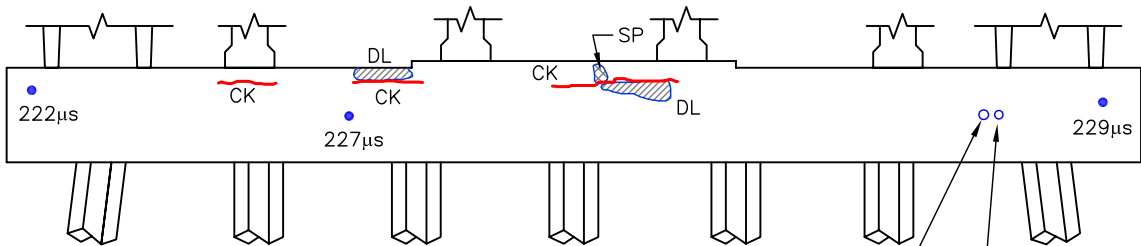

South Elevation

4" CORE:
6,080 psi

3.5" CORE