

BENT #100

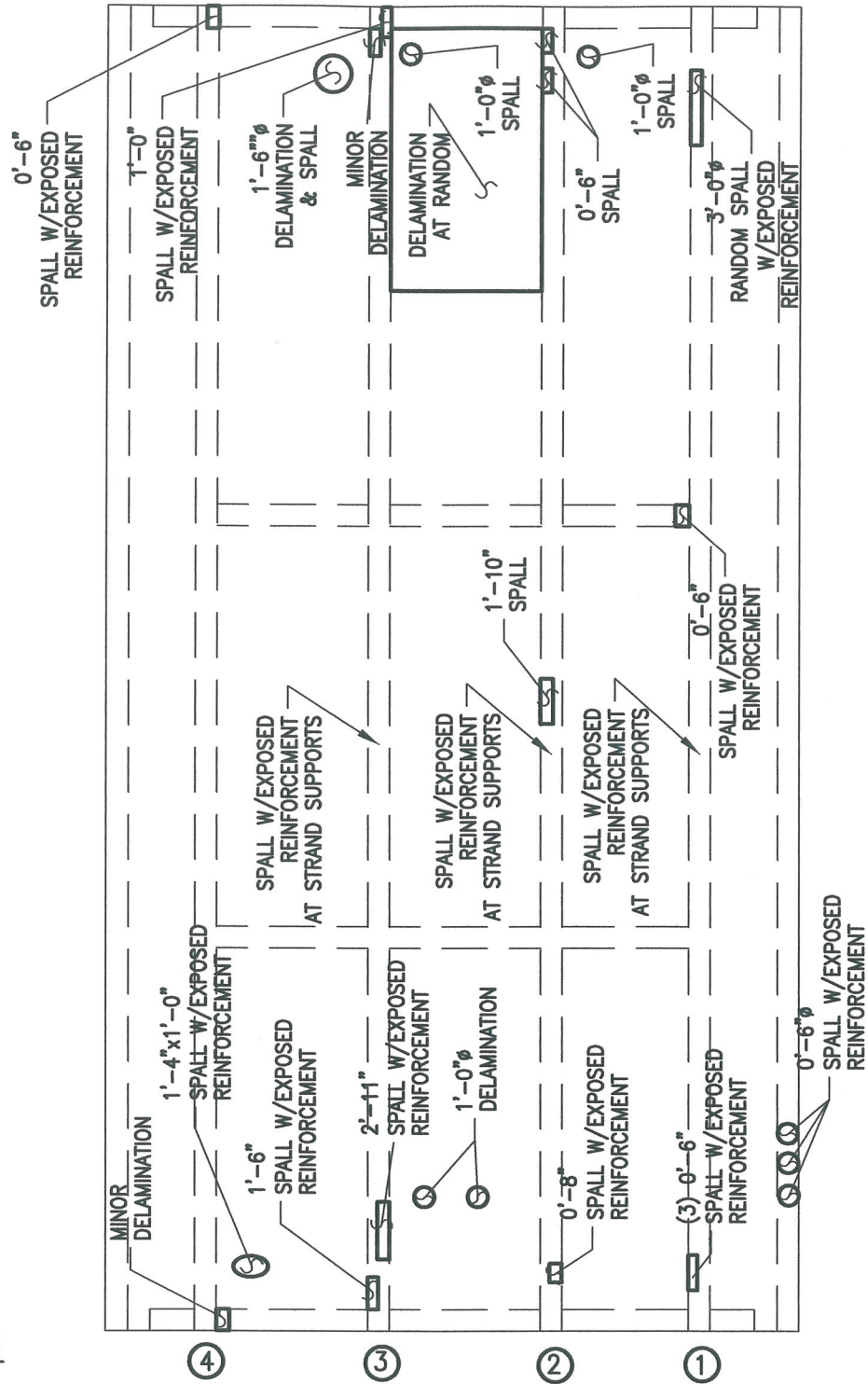

BENT #101

PLAN OF DECK UNDERSIDE



ALPHA & OMEGA GROUP
 CIVIL & STRUCTURAL ENGINEERS

4911 Green Road Suite 107 Raleigh, NC 27616
 Phone 919 981 0310 Fax 919 981 0451
 Email info@aogroup.com www.aogroup.com

BRIDGE NO:	270011		
COUNTY:	DARE		
PREPARED BY:	OHS	CHECKED BY:	TGZ
SCALE:	NTS		
DATE:	6/20/06	SHT	697 OF 1347

BENT # 101

10'-8"x1'-0"
SPALL W/EXPOSED
REINFORCEMENT

2'-10"x3'-6"
DELAMINATION

0'-10"x1'-4"
SPALL W/EXPOSED
REINFORCEMENT

2'-10" SPALL
W/EXPOSED
REINFORCEMENT

8" ϕ DELAMINATION

3'-2"x2'-10"
SPALL W/EXPOSED
REINFORCEMENT

0'-10"x1'-4"
DELAMINATION

MINOR SPALL

CLOGGED DRAIN

4'-0" SPALL W/
JOINT SEPARATION

MINOR SPALL

BENT # 102

PLAN OF DECK SURFACE



ALPHA & OMEGA GROUP
CIVIL & STRUCTURAL ENGINEERS

4911 Green Road Suite 107 Raleigh, NC 27616
Phone 919 981 0310 Fax 919 981 0451
Email info@aogroup.com www.aogroup.com

BRIDGE NO: 270011

COUNTY: DARE

PREPARED BY: ACS CHECKED BY: TGZ

SCALE: NTS

DATE: 6/20/06 SHT 702 OF 1347

BENT #101

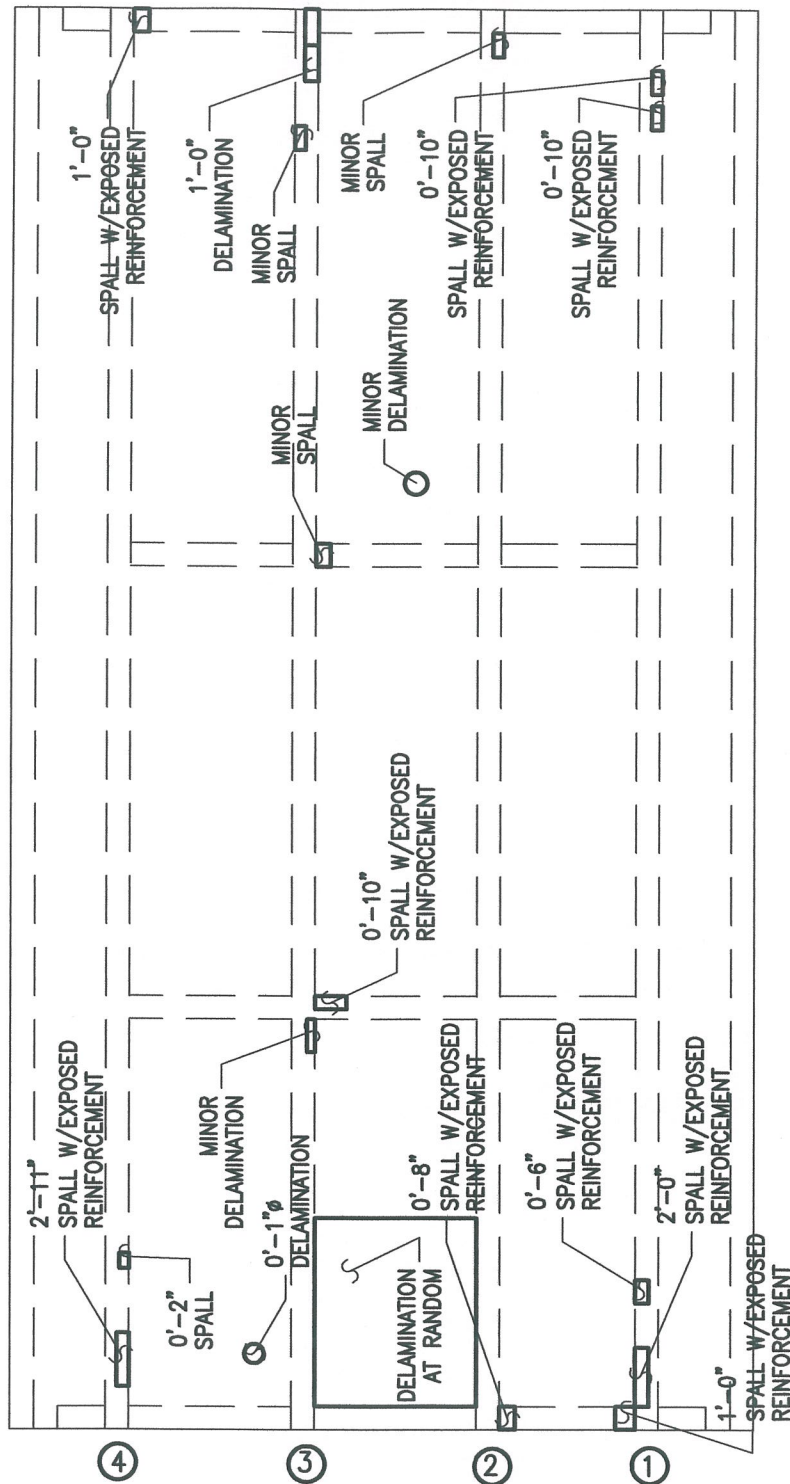

BENT #102

PLAN OF DECK UNDERSIDE



ALPHA & OMEGA GROUP
 CIVIL & STRUCTURAL ENGINEERS

4911 Green Road Suite 107 Raleigh, NC 27616
 Phone 919 981 0310 Fax 919 981 0451
 Email info@aogroup.com www.aogroup.com

BRIDGE NO:	270011		
COUNTY:	DARE		
PREPARED BY:	OHS	CHECKED BY:	TGZ
SCALE:	NTS		
DATE:	6/20/06	SHT	703 OF 1347

BENT # 102

BENT # 103

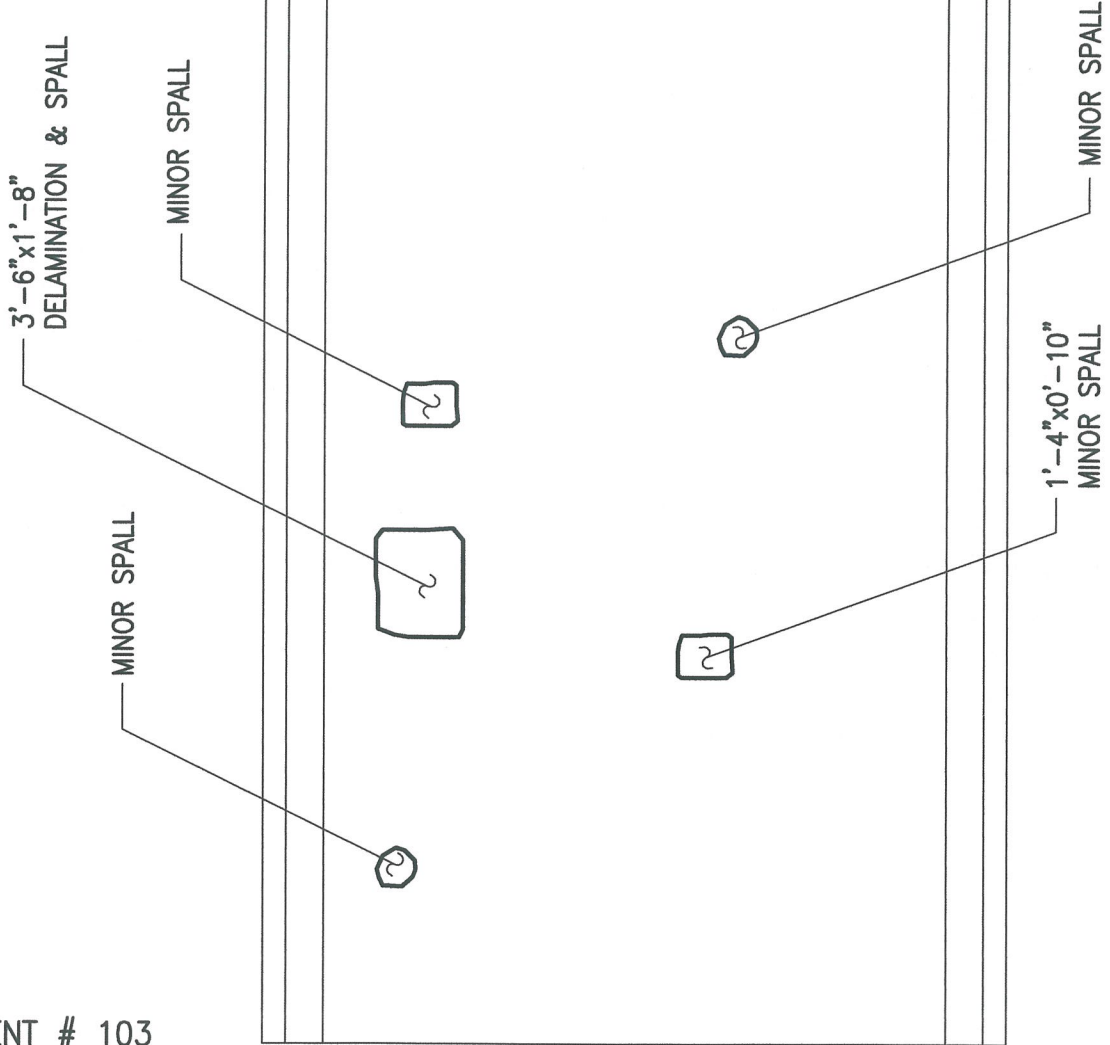

PLAN OF DECK SURFACE



ALPHA & OMEGA GROUP
CIVIL & STRUCTURAL ENGINEERS

4911 Green Road Suite 107 Raleigh, NC 27616
Phone 919 981 0310 Fax 919 981 0451
Email info@aogroup.com www.aogroup.com

BRIDGE NO: 270011

COUNTY: DARE

PREPARED BY: ACS CHECKED BY: TGZ

SCALE: NTS

DATE: 6/20/06 SHT 708 OF 1347

BENT #102

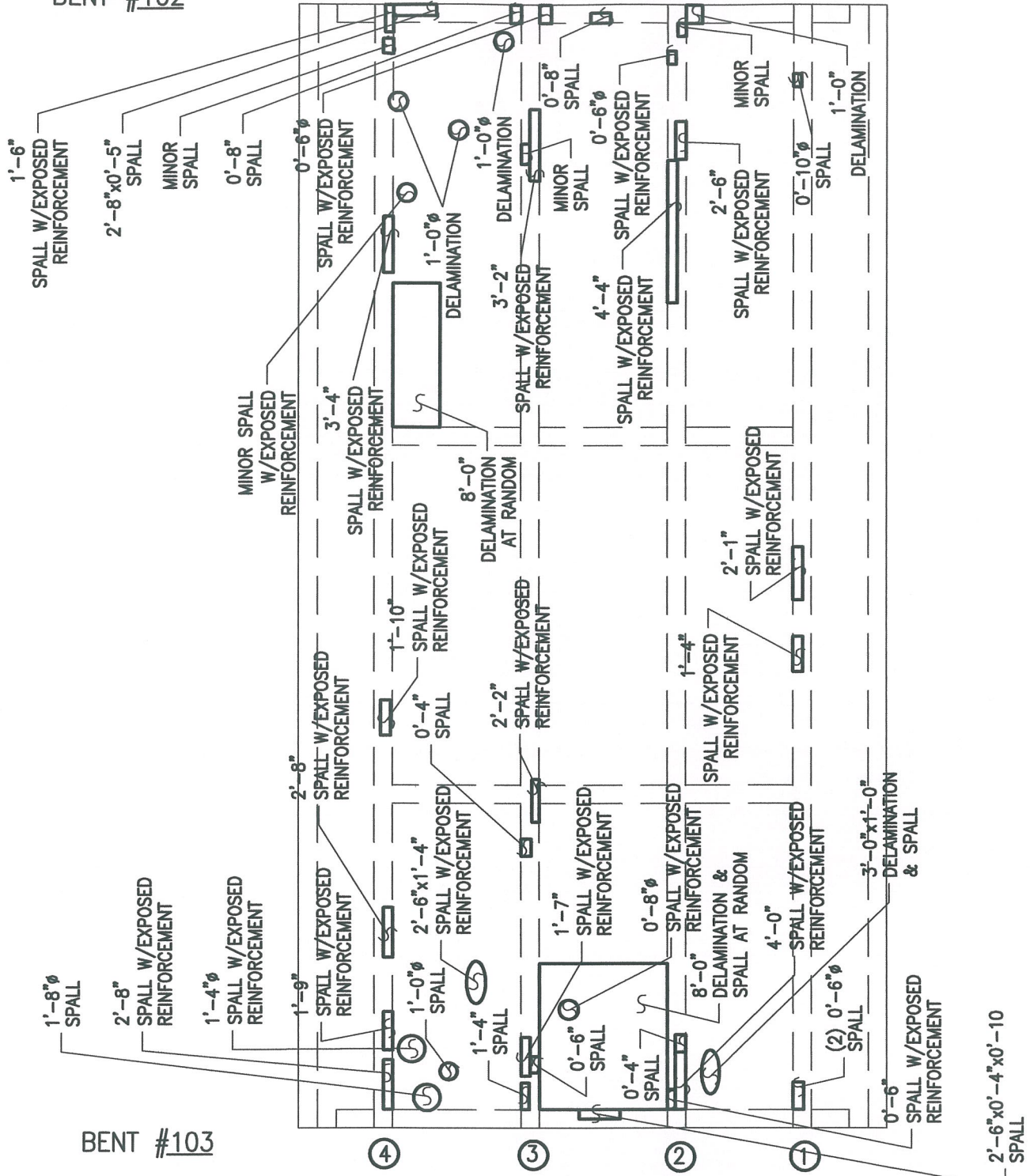

PLAN OF DECK UNDERSIDE



ALPHA & OMEGA GROUP
 CIVIL & STRUCTURAL ENGINEERS

4911 Green Road Suite 107 Raleigh, NC 27616
 Phone 919 981 0310 Fax 919 981 0451
 Email info@aogroup.com www.aogroup.com

BRIDGE NO: 270011

COUNTY: DARE

PREPARED BY: OHS CHECKED BY: TGZ

SCALE: NTS

DATE: 6/20/06 SHT 79 OF 1347

BENT # 103

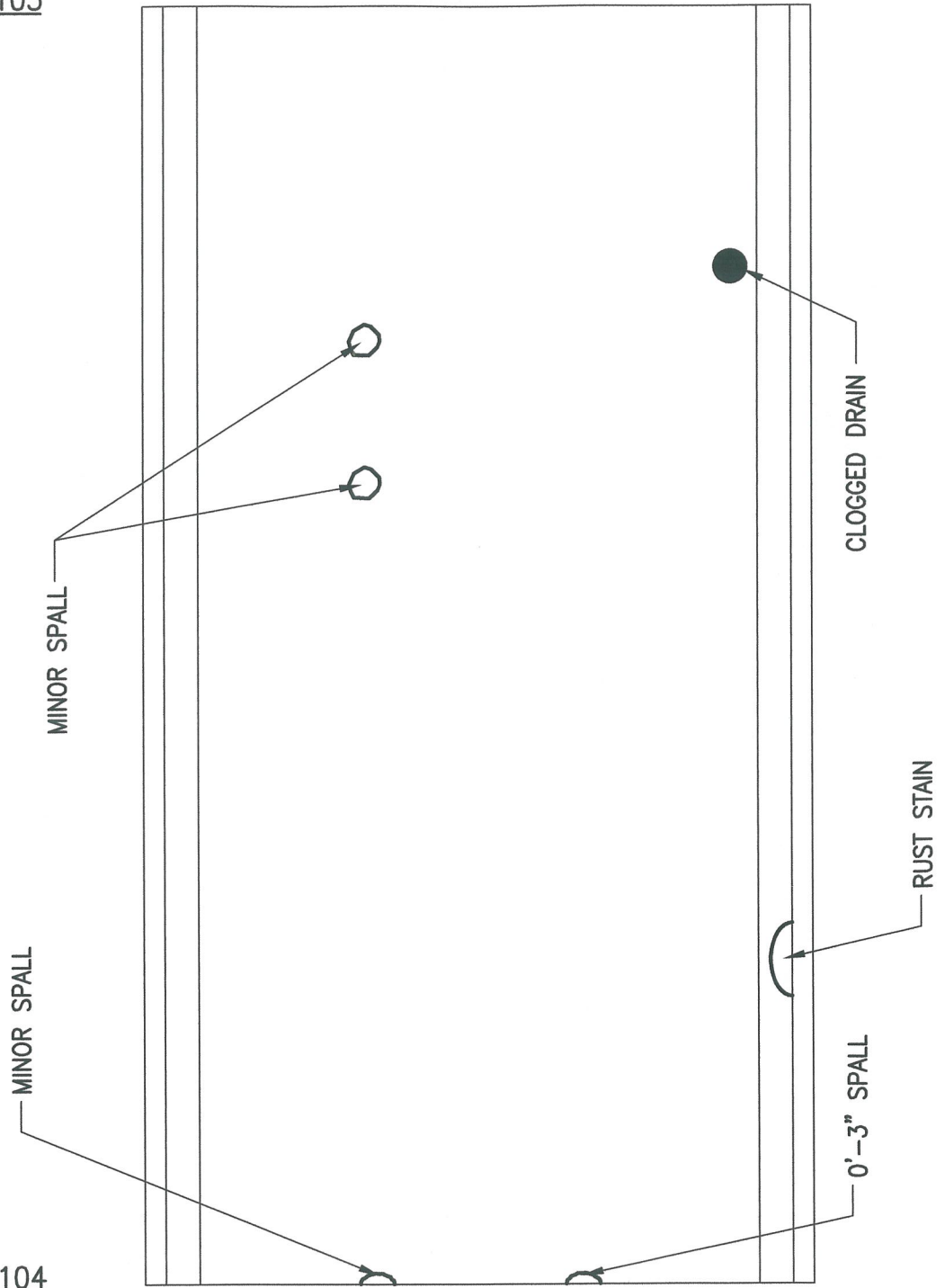

BENT # 104

PLAN OF DECK SURFACE



ALPHA & OMEGA GROUP
CIVIL & STRUCTURAL ENGINEERS

4911 Green Road Suite 107 Raleigh, NC 27616
Phone 919 981 0310 Fax 919 981 0451
Email info@aogroup.com www.aogroup.com

BRIDGE NO:	270011		
COUNTY:	DARE		
PREPARED BY:	ACS	CHECKED BY:	TGZ
SCALE:	NTS		
DATE:	6/20/06	SHT 714 OF	347

BENT #103

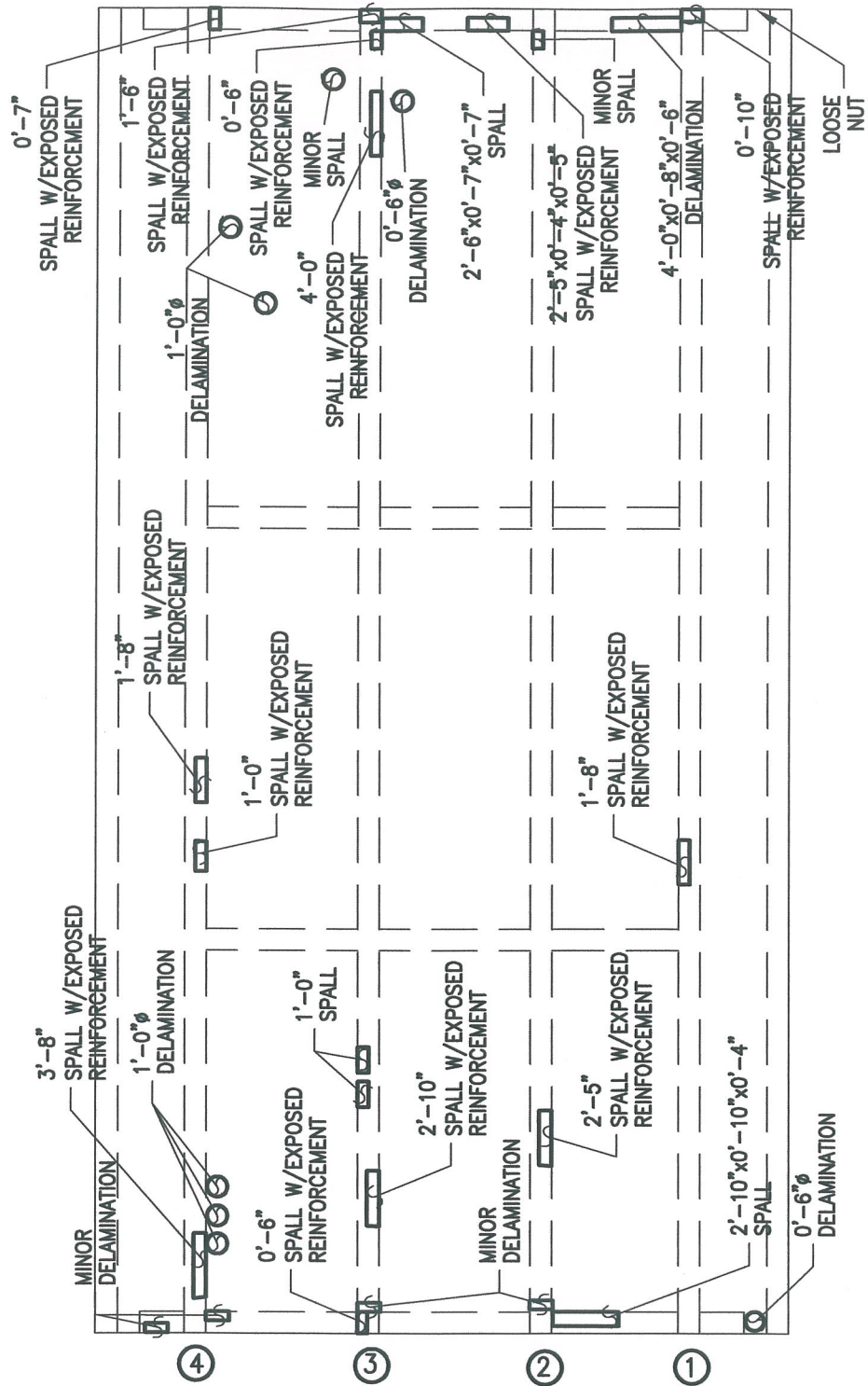

BENT #104

PLAN OF DECK UNDERSIDE



ALPHA & OMEGA GROUP
 CIVIL & STRUCTURAL ENGINEERS

4911 Green Road Suite 107 Raleigh, NC 27616
 Phone 919 981 0310 Fax 919 981 0451
 Email info@aogroup.com www.aogroup.com

BRIDGE NO:	270011
COUNTY:	DARE
PREPARED BY:	OHS
CHECKED BY:	TGZ
SCALE:	NTS
DATE:	6/20/06
	SHT 715 OF 1347

BENT # 104

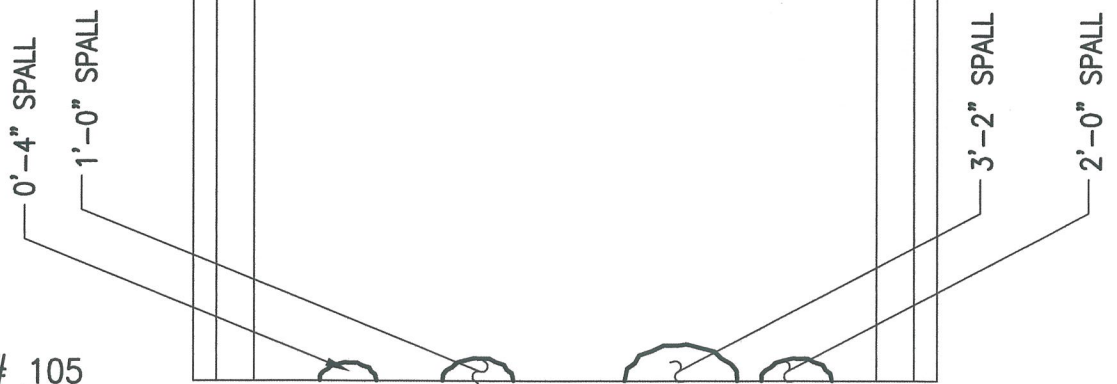

BENT # 105

PLAN OF DECK SURFACE



ALPHA & OMEGA GROUP
CIVIL & STRUCTURAL ENGINEERS

4911 Green Road Suite 107 Raleigh, NC 27616
Phone 919 981 0310 Fax 919 981 0451
Email info@aogroup.com www.aogroup.com

BRIDGE NO: 270011

COUNTY: DARE

PREPARED BY: ACS CHECKED BY: TGZ

SCALE: NTS

DATE: 6/20/06 SHT 720 OF 1347

BENT #104

BENT #105

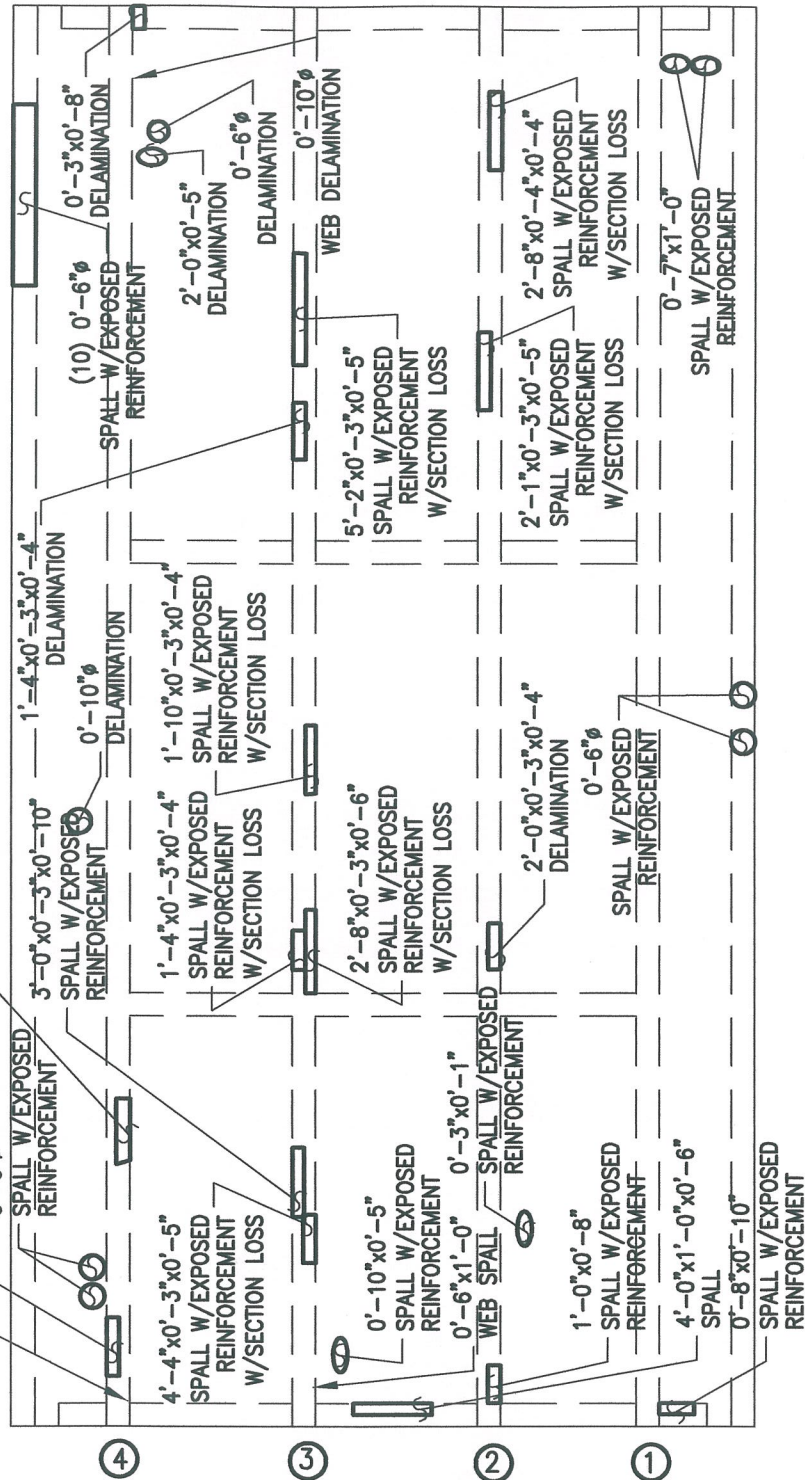

PLAN OF DECK UNDERSIDE



ALPHA & OMEGA GROUP
 CIVIL & STRUCTURAL ENGINEERS

4911 Green Road Suite 107 Raleigh, NC 27616
 Phone 919 981 0310 Fax 919 981 0451
 Email info@aogroup.com www.aogroup.com

BRIDGE NO:	270011
COUNTY:	DARE
PREPARED BY:	OHS
CHECKED BY:	TGZ
SCALE:	NTS
DATE:	6/20/06
	SHT 72 OF 1347

BENT # 105

BENT # 106

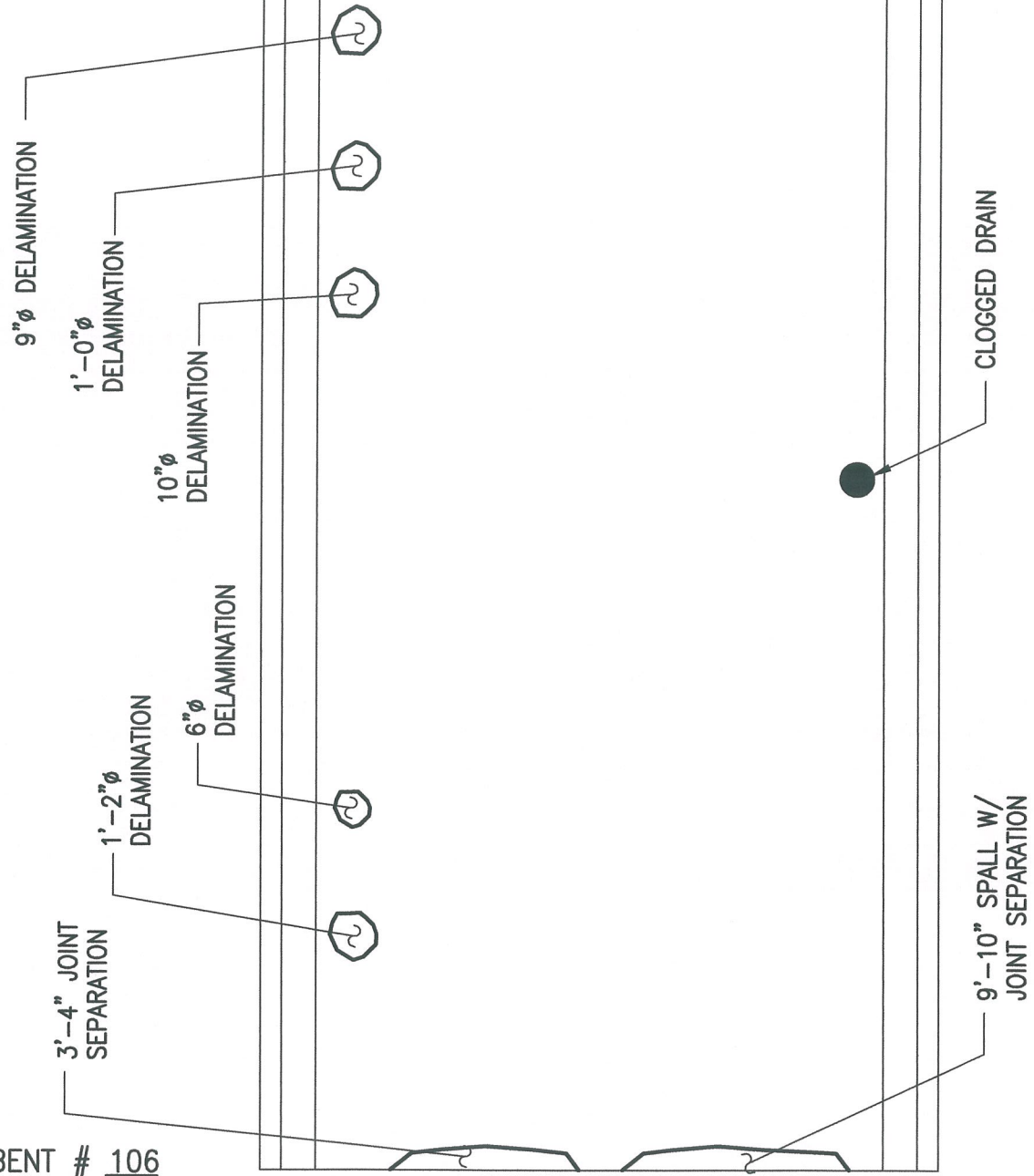

PLAN OF DECK SURFACE



ALPHA & OMEGA GROUP
 CIVIL & STRUCTURAL ENGINEERS

4911 Green Road Suite 107 Raleigh, NC 27616
 Phone 919 981 0310 Fax 919 981 0451
 Email info@aogroup.com www.aogroup.com

BRIDGE NO:	270011		
COUNTY:	DARE		
PREPARED BY:	ACS	CHECKED BY:	TGZ
SCALE:	NTS		
DATE:	6/20/06	SHT	726 OF 1347

BENT #105

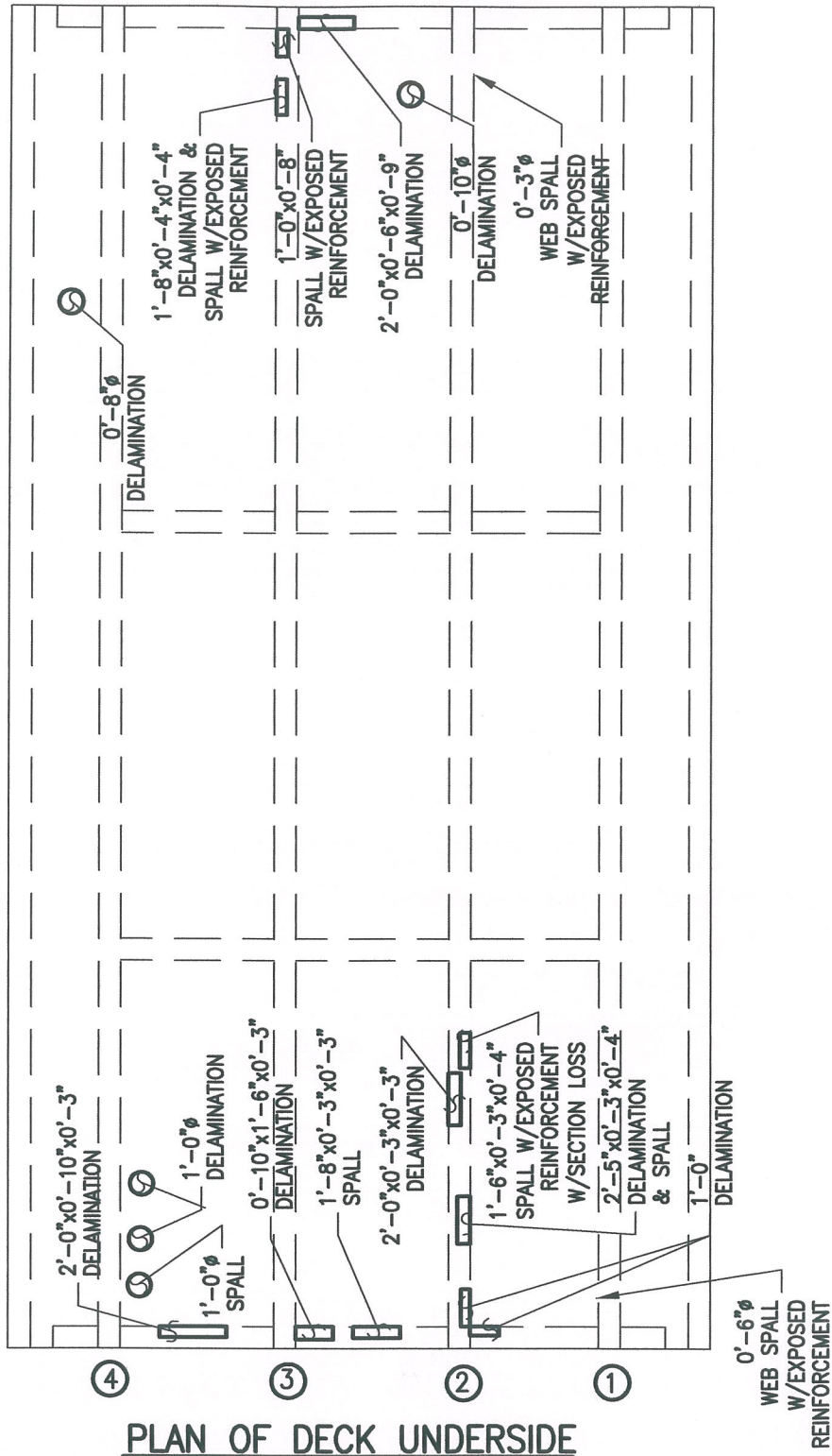

BENT #106

PLAN OF DECK UNDERSIDE



ALPHA & OMEGA GROUP
 CIVIL & STRUCTURAL ENGINEERS

4911 Green Road Suite 107 Raleigh, NC 27616
 Phone 919 981 0310 Fax 919 981 0451
 Email info@aogroup.com www.aogroup.com

BRIDGE NO: 270011

COUNTY: DARE

PREPARED BY: OHS CHECKED BY: TGZ

SCALE: NTS

DATE: 6/20/06 SHT 227 OF 347

BENT # 106

BENT # 107

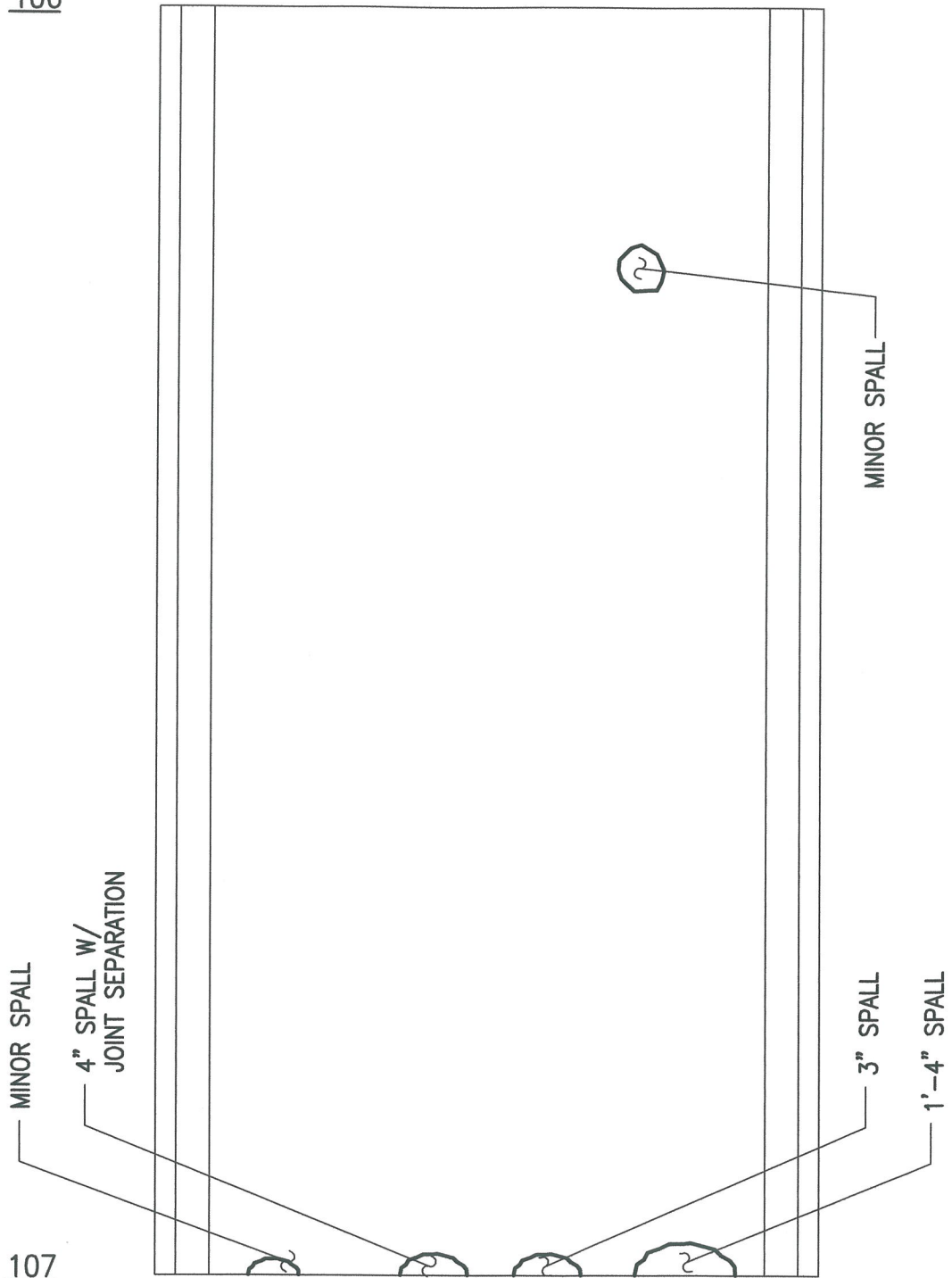

PLAN OF DECK SURFACE



ALPHA & OMEGA GROUP
CIVIL & STRUCTURAL ENGINEERS

4911 Green Road Suite 107 Raleigh, NC 27616
Phone 919 981 0310 Fax 919 981 0451
Email info@aogroup.com www.aogroup.com

BRIDGE NO: 270011

COUNTY: DARE

PREPARED BY: ACS CHECKED BY: TGZ

SCALE: NTS

DATE: 6/20/06 SHT 731 OF 1347

BENT #106

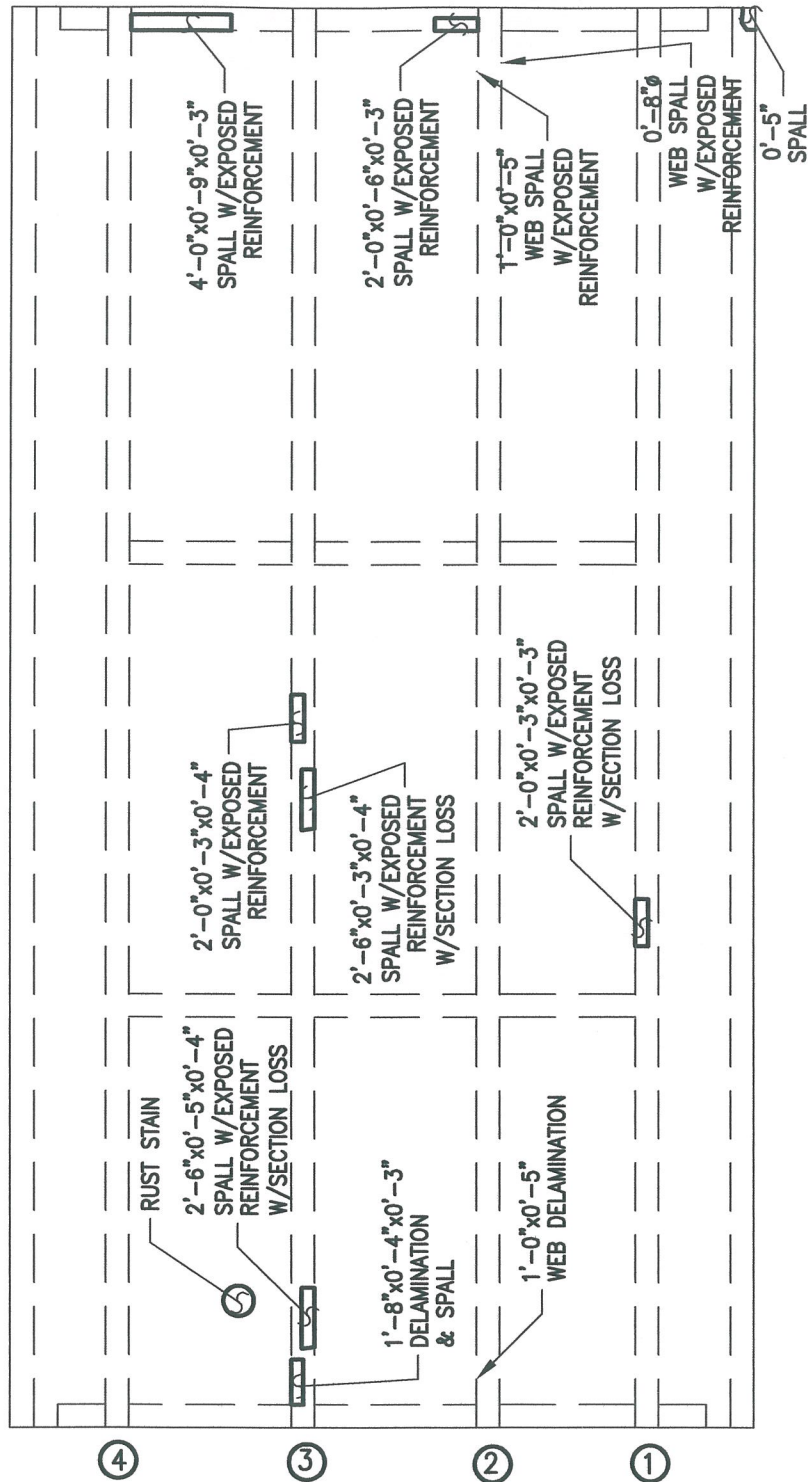

BENT #107

PLAN OF DECK UNDERSIDE



ALPHA & OMEGA GROUP
 CIVIL & STRUCTURAL ENGINEERS

4911 Green Road Suite 107 Raleigh, NC 27616
 Phone 919 981 0310 Fax 919 981 0451
 Email info@aogroup.com www.aogroup.com

BRIDGE NO:	270011		
COUNTY:	DARE		
PREPARED BY:	OHS	CHECKED BY:	TGZ
SCALE:	NTS		
DATE:	6/20/06	SHT	732 OF 1347

BENT # 107

BENT # 108

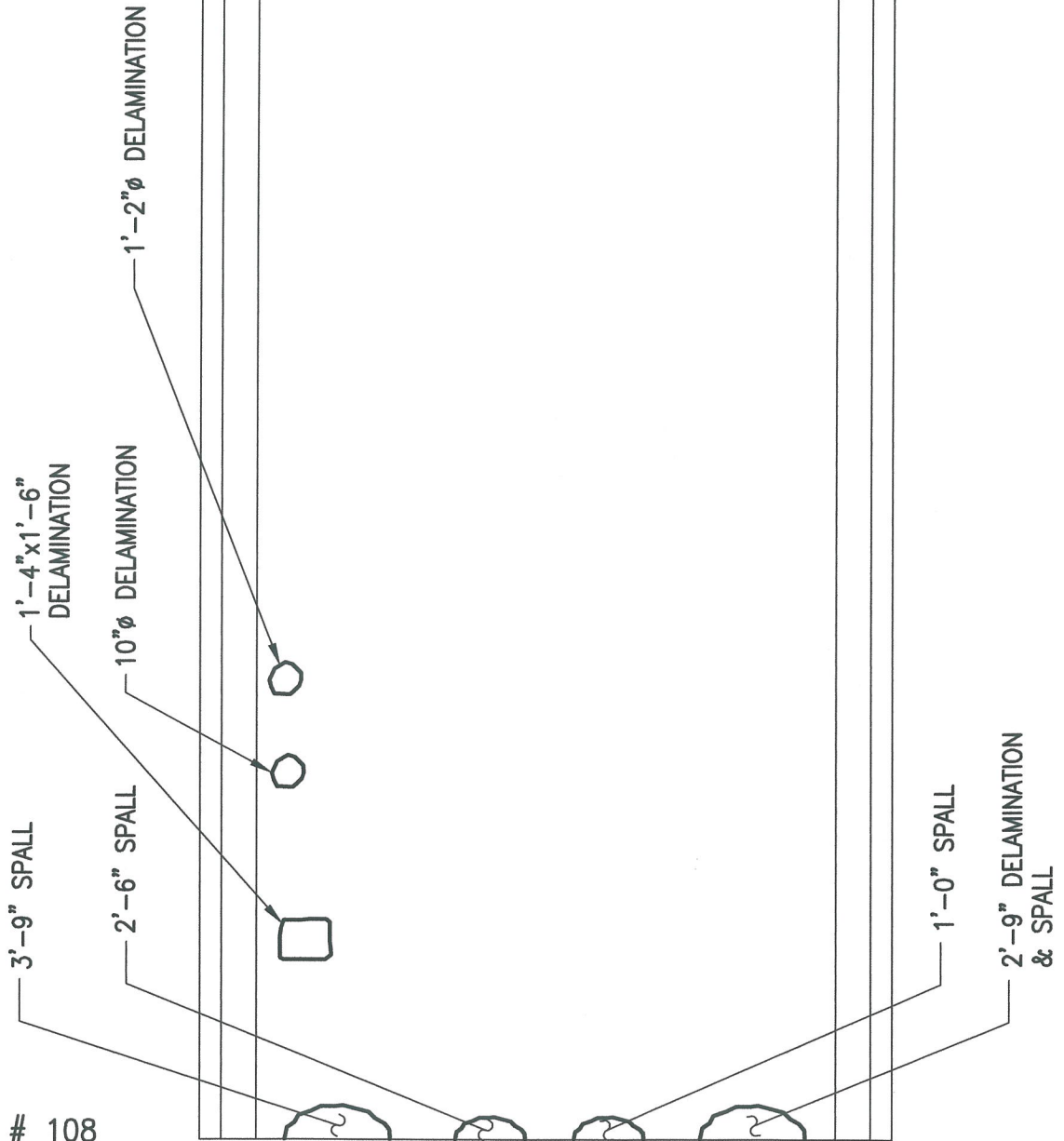

PLAN OF DECK SURFACE



ALPHA & OMEGA GROUP
CIVIL & STRUCTURAL ENGINEERS

4911 Green Road Suite 107 Raleigh, NC 27616
Phone 919 981 0310 Fax 919 981 0451
Email info@aogroup.com www.aogroup.com

BRIDGE NO: 270011

COUNTY: DARE

PREPARED BY: ACS CHECKED BY: TGZ

SCALE: NTS

DATE: 6/20/06 SHT 737 OF 1347

BENT #107

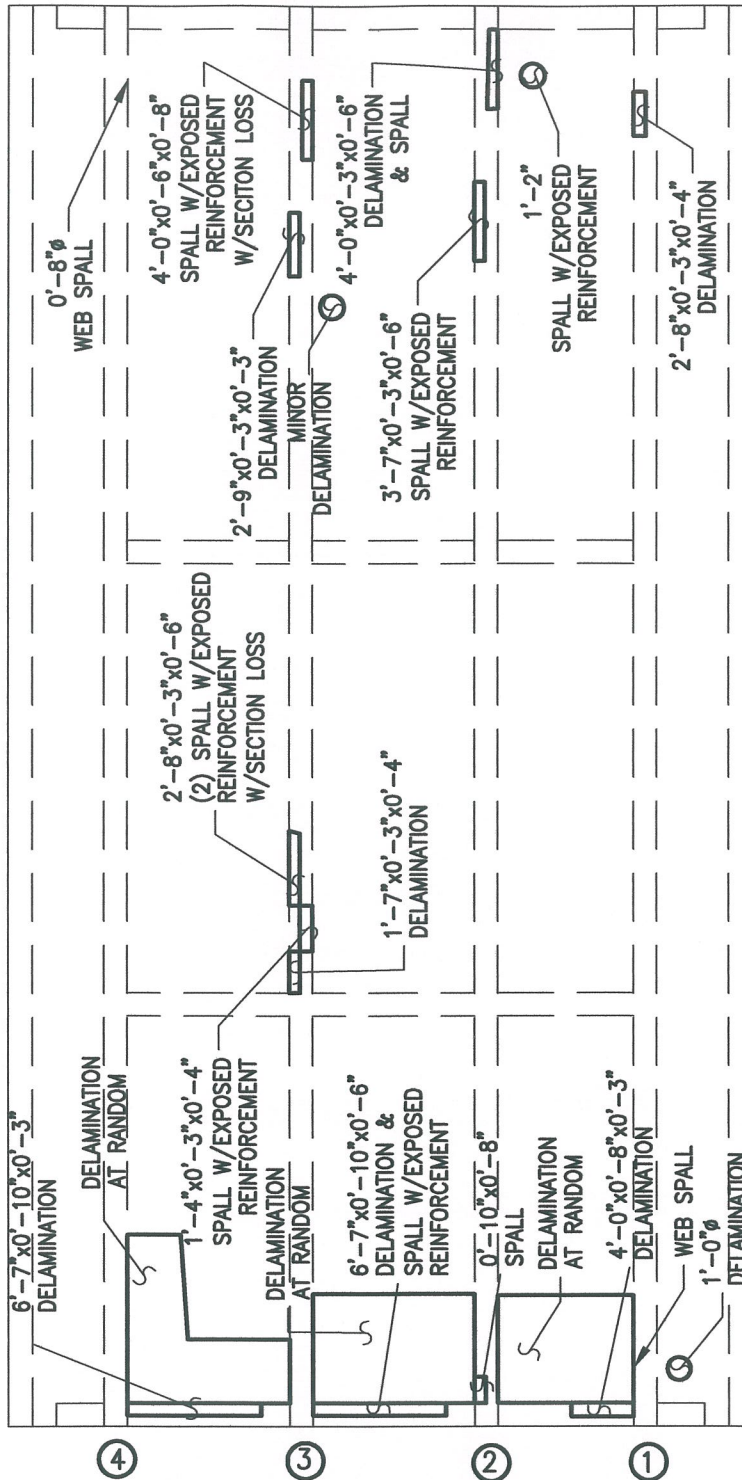

BENT #108

PLAN OF DECK UNDERSIDE



ALPHA & OMEGA GROUP
 CIVIL & STRUCTURAL ENGINEERS

4911 Green Road Suite 107 Raleigh, NC 27616
 Phone 919 981 0310 Fax 919 981 0451
 Email info@aogroup.com www.aogroup.com

BRIDGE NO:	270011		
COUNTY:	DARE		
PREPARED BY:	OHS	CHECKED BY:	TGZ
SCALE:	NTS		
DATE:	6/20/06	SHT	138 OF 1347

BENT # 108

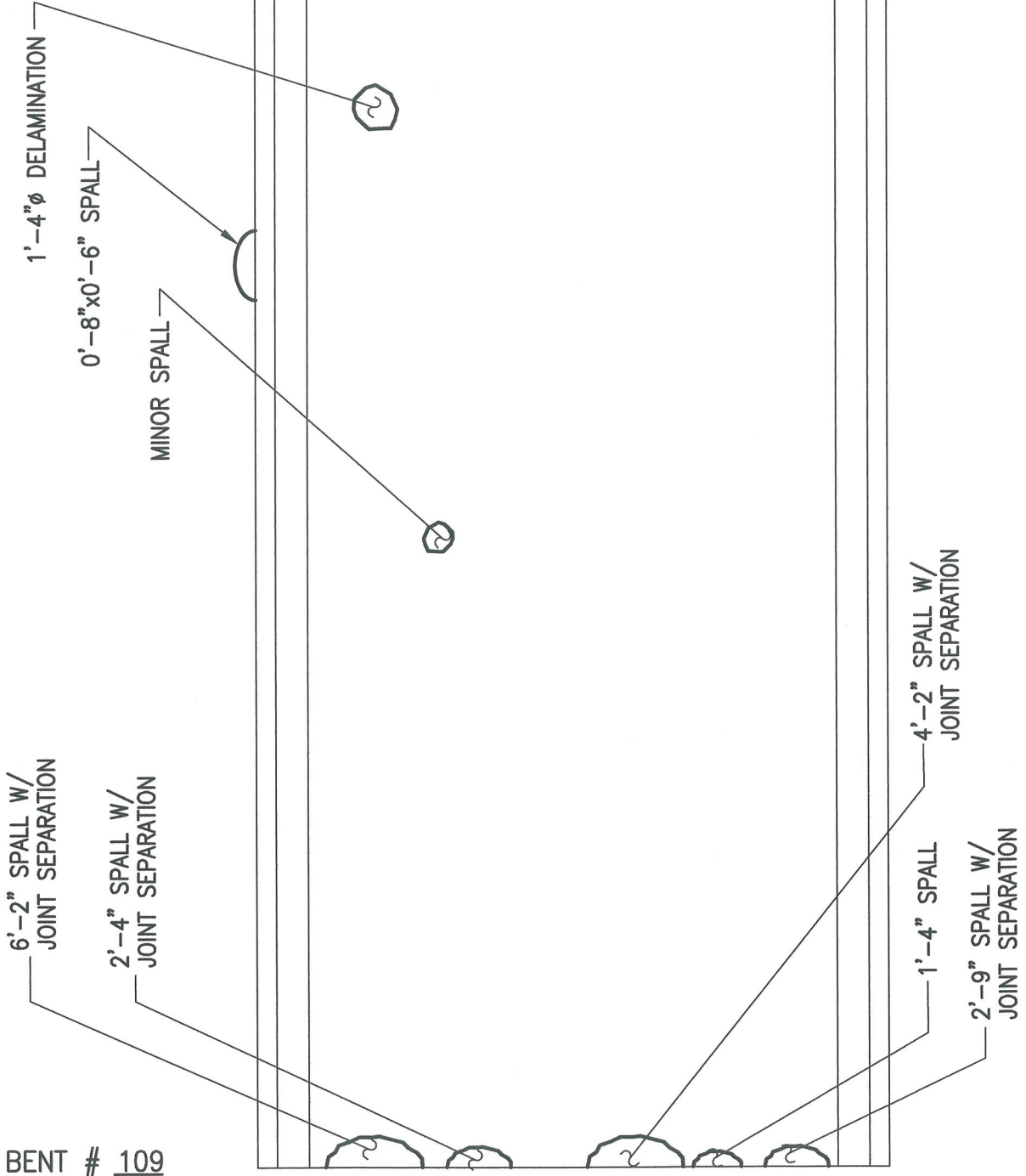

BENT # 109

PLAN OF DECK SURFACE



ALPHA & OMEGA GROUP
 CIVIL & STRUCTURAL ENGINEERS

4911 Green Road Suite 107 Raleigh, NC 27616
 Phone 919 981 0310 Fax 919 981 0451
 Email info@aogroup.com www.aogroup.com

BRIDGE NO: 270011

COUNTY: DARE

PREPARED BY: ACS CHECKED BY: TGZ

SCALE: NTS

DATE: 6/20/06 SHT 743 OF 1347

BENT #108

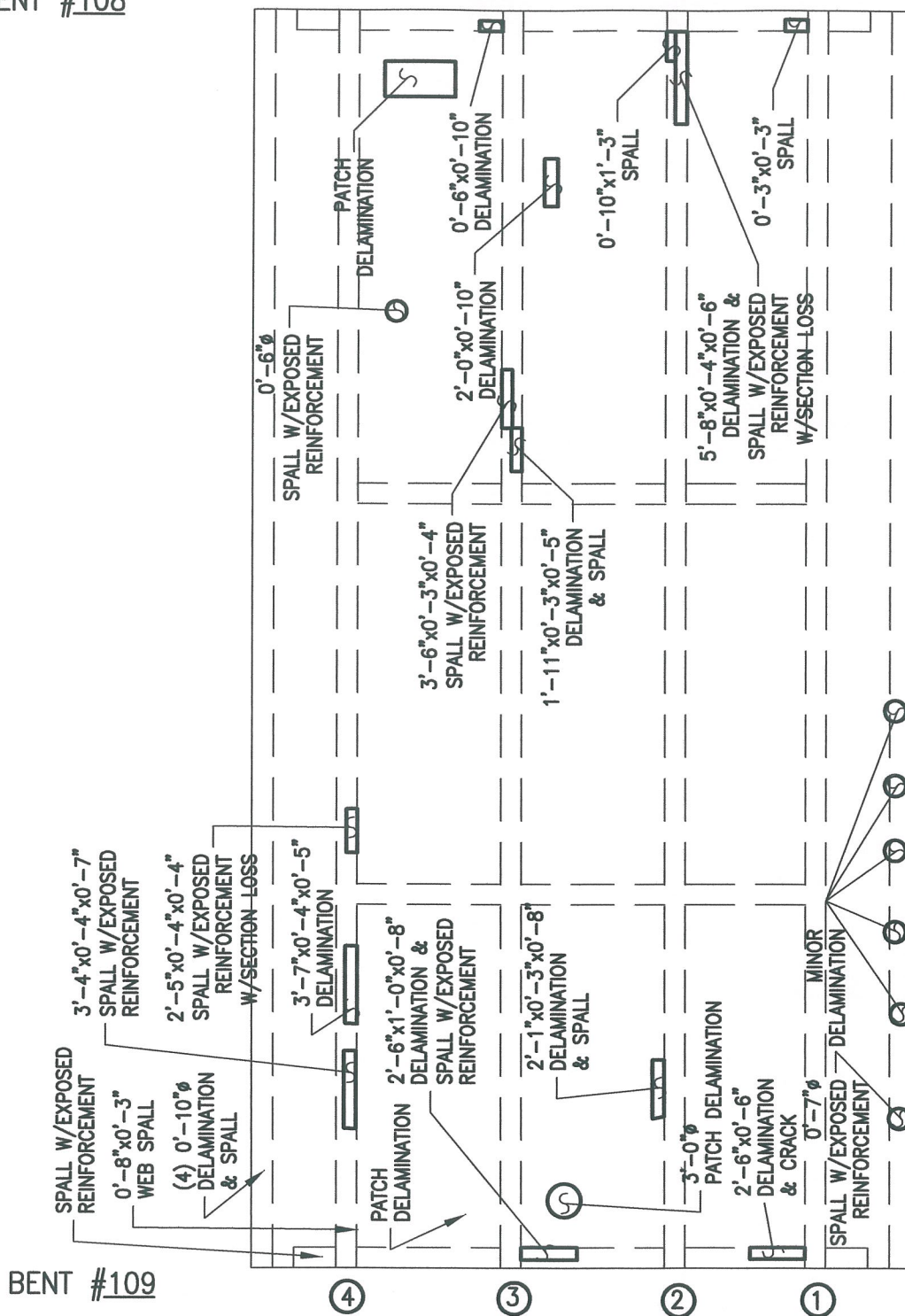

PLAN OF DECK UNDERSIDE



ALPHA & OMEGA GROUP
 CIVIL & STRUCTURAL ENGINEERS
 4911 Green Road Suite 107 Raleigh, NC 27616
 Phone 919 981 0310 Fax 919 981 0451
 Email info@aogroup.com www.aogroup.com

BRIDGE NO:	270011		
COUNTY:	DARE		
PREPARED BY:	OHS	CHECKED BY:	TGZ
SCALE:	NTS		
DATE:	6/20/06	SHT 744 OF 1347	

BENT # 109

0'-5" SPALL W/
JOINT SEPARATION

8'-0" SPALL W/
JOINT SEPARATION

3'-7" SPALL W/
JOINT SEPARATION

CLOGGED DRAIN

CRACKED
RAIL POST

3'-2" SPALL W/
JOINT SEPARATION

2'-0" SPALL W/
JOINT SEPARATION

3'-8" SPALL W/
JOINT SEPARATION

BENT # 110

PLAN OF DECK SURFACE



ALPHA & OMEGA GROUP
CIVIL & STRUCTURAL ENGINEERS

4911 Green Road Suite 107 Raleigh, NC 27616
Phone 919 981 0310 Fax 919 981 0451
Email info@aogroup.com www.aogroup.com

BRIDGE NO:	270011
COUNTY:	DARE
PREPARED BY:	ACS
CHECKED BY:	TGZ
SCALE:	NTS
DATE:	6/20/06
	SHT 749 OF 1347

BENT #109

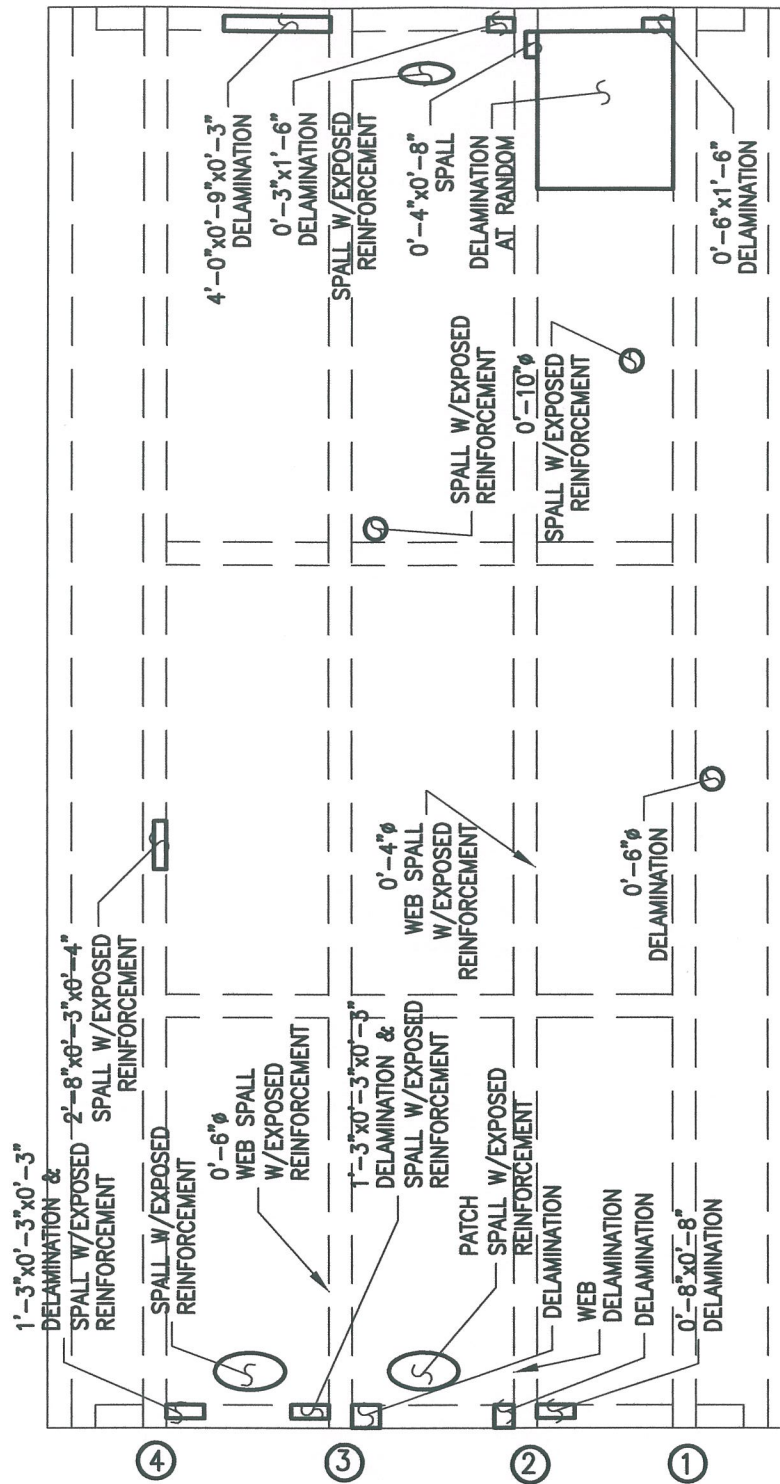

BENT #110

PLAN OF DECK UNDERSIDE



ALPHA & OMEGA GROUP
 CIVIL & STRUCTURAL ENGINEERS

4911 Green Road Suite 107 Raleigh, NC 27616
 Phone 919 981 0310 Fax 919 981 0451
 Email info@aogroup.com www.aogroup.com

BRIDGE NO: 270011

COUNTY: DARE

PREPARED BY: OHS CHECKED BY: TGZ

SCALE: NTS

DATE: 6/20/06 SHT 750 OF 1347

BENT # 110

BENT # 111

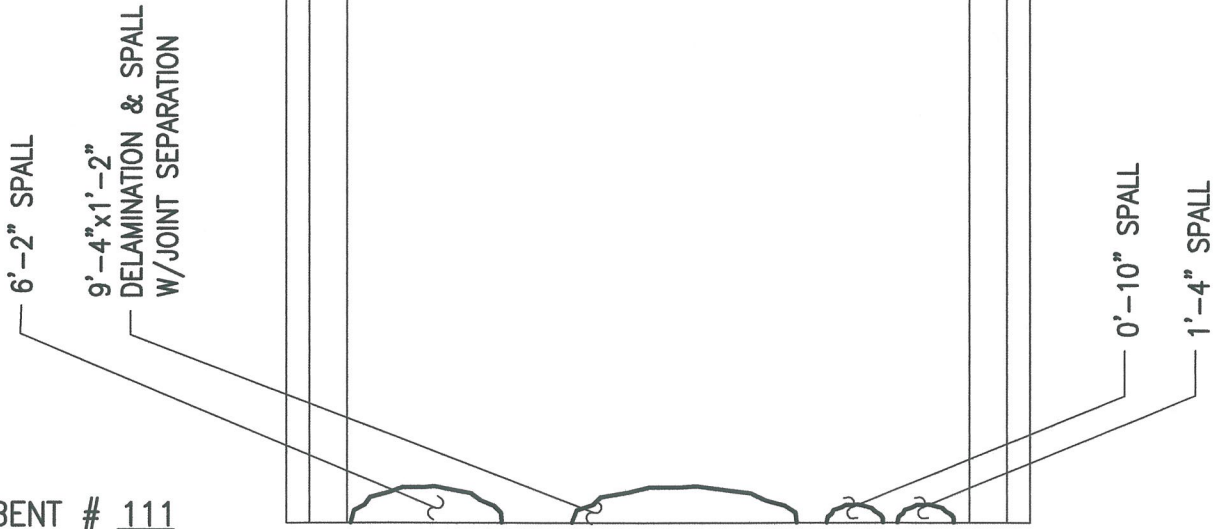

PLAN OF DECK SURFACE



ALPHA & OMEGA GROUP
CIVIL & STRUCTURAL ENGINEERS

4911 Green Road Suite 107 Raleigh, NC 27616
Phone 919 981 0310 Fax 919 981 0451
Email info@aogroup.com www.aogroup.com

BRIDGE NO:	270011		
COUNTY:	DARE		
PREPARED BY:	ACS	CHECKED BY:	TGZ
SCALE:	NTS		
DATE:	6/20/06	SHT	755 OF 1347

BENT #110

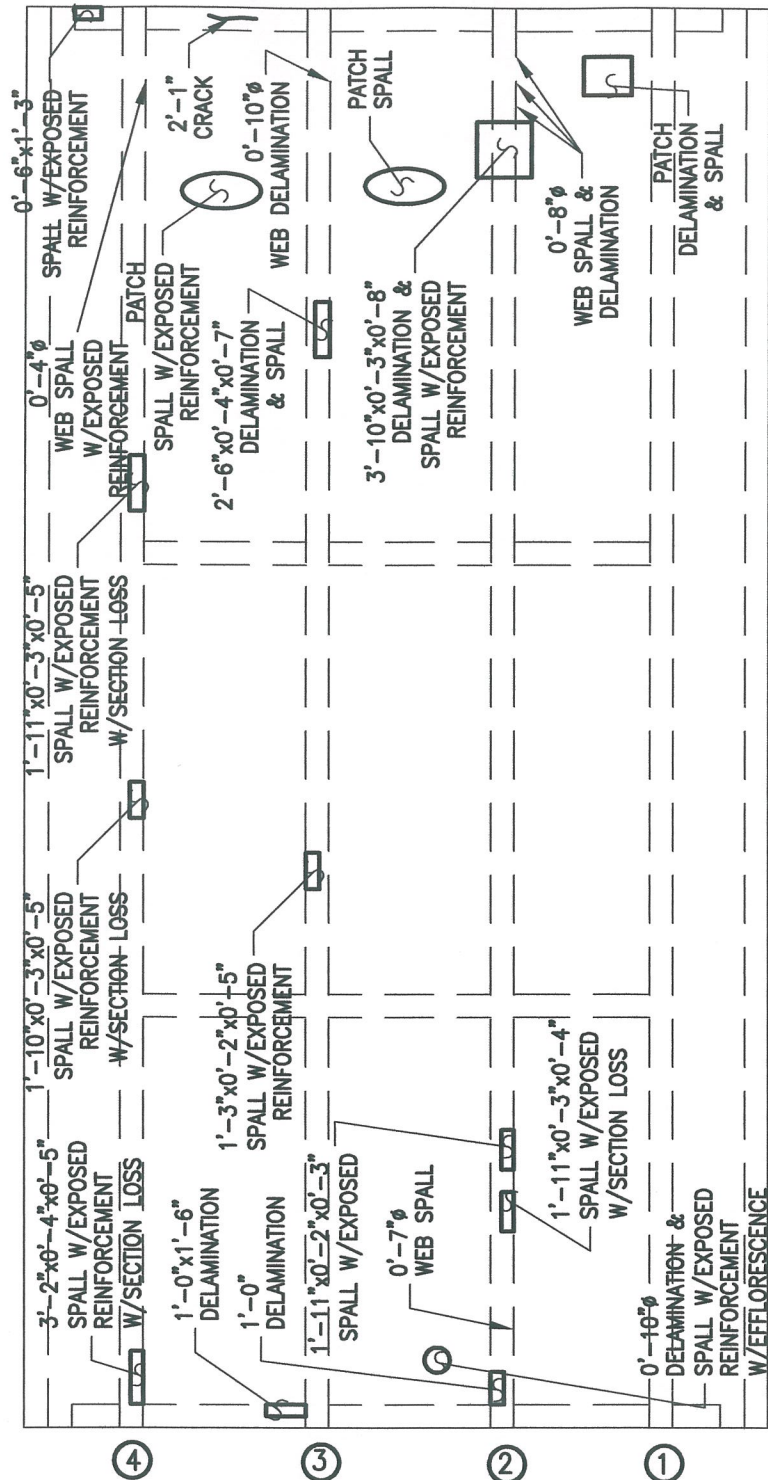

BENT #111

PLAN OF DECK UNDERSIDE



ALPHA & OMEGA GROUP
 CIVIL & STRUCTURAL ENGINEERS

4911 Green Road Suite 107 Raleigh, NC 27616
 Phone 919 981 0310 Fax 919 981 0451
 Email info@aogroup.com www.aogroup.com

BRIDGE NO:	270011		
COUNTY:	DARE		
PREPARED BY:	OHS	CHECKED BY:	TGZ
SCALE:	NTS		
DATE:	6/20/06	SHT	786 OF 1347

BENT # 111

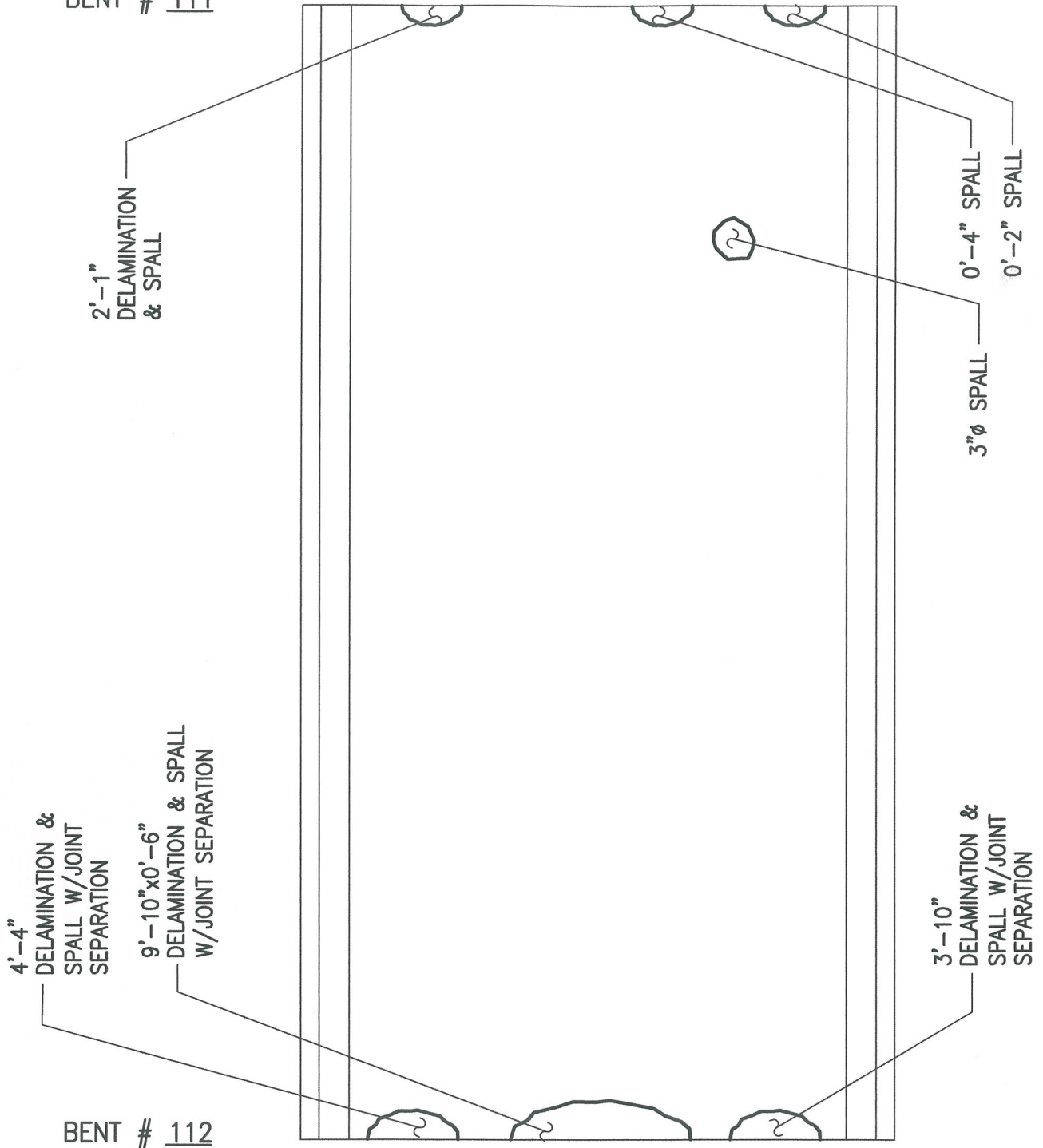

BENT # 112

PLAN OF DECK SURFACE



ALPHA & OMEGA GROUP
 CIVIL & STRUCTURAL ENGINEERS

4911 Green Road Suite 107 Raleigh, NC 27616
 Phone 919 981 0310 Fax 919 981 0451
 Email info@aogroup.com www.aogroup.com

BRIDGE NO:	270011		
COUNTY:	DARE		
PREPARED BY:	ACS	CHECKED BY:	TGZ
SCALE:	NTS		
DATE:	6/20/06	SHT	761 OF 1347

BENT #111

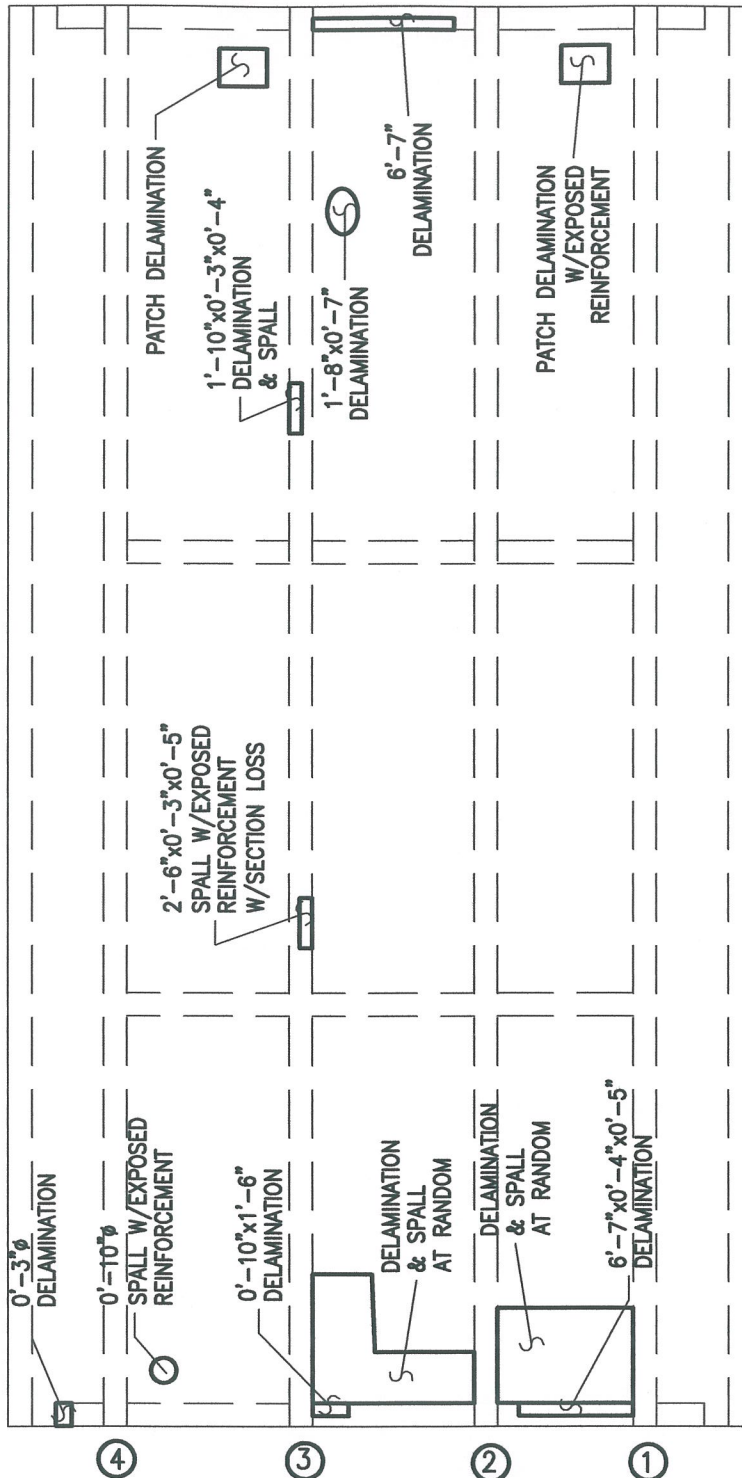

BENT #112

PLAN OF DECK UNDERSIDE



ALPHA & OMEGA GROUP
 CIVIL & STRUCTURAL ENGINEERS

4911 Green Road Suite 107 Raleigh, NC 27616
 Phone 919 981 0310 Fax 919 981 0451
 Email info@aogroup.com www.aogroup.com

BRIDGE NO: 270011

COUNTY: DARE

PREPARED BY: OHS CHECKED BY: TGZ

SCALE: NTS

DATE: 6/20/06 SHT 762 OF 1347

BENT # 112

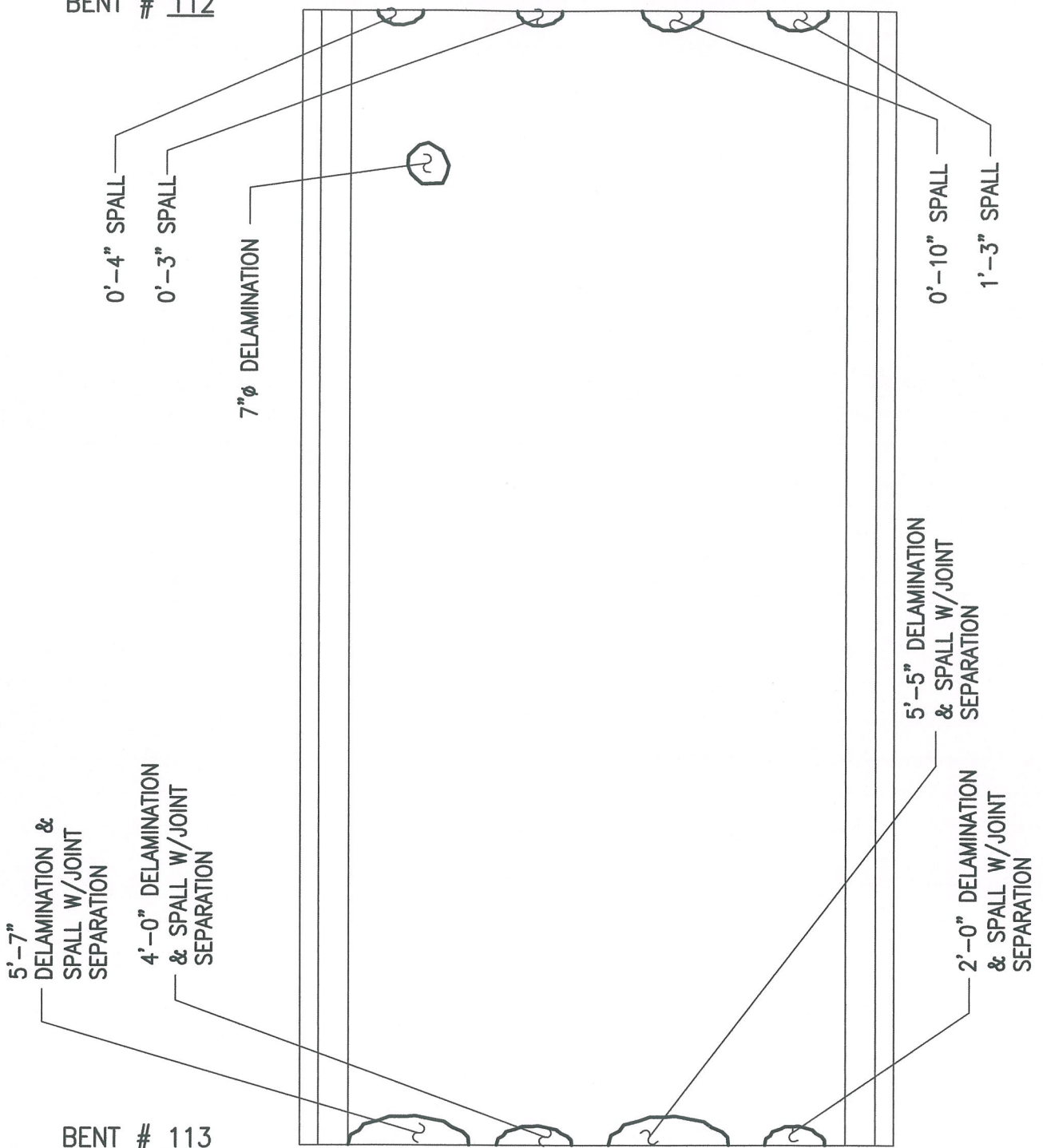

BENT # 113

PLAN OF DECK SURFACE



ALPHA & OMEGA GROUP
 CIVIL & STRUCTURAL ENGINEERS

4911 Green Road Suite 107 Raleigh, NC 27616
 Phone 919 981 0310 Fax 919 981 0451
 Email info@aogroup.com www.aogroup.com

BRIDGE NO:	270011		
COUNTY:	DARE		
PREPARED BY:	ACS	CHECKED BY:	TGZ
SCALE:	NTS		
DATE:	6/20/06	SHT	767 OF 1347

BENT #112

BENT #113

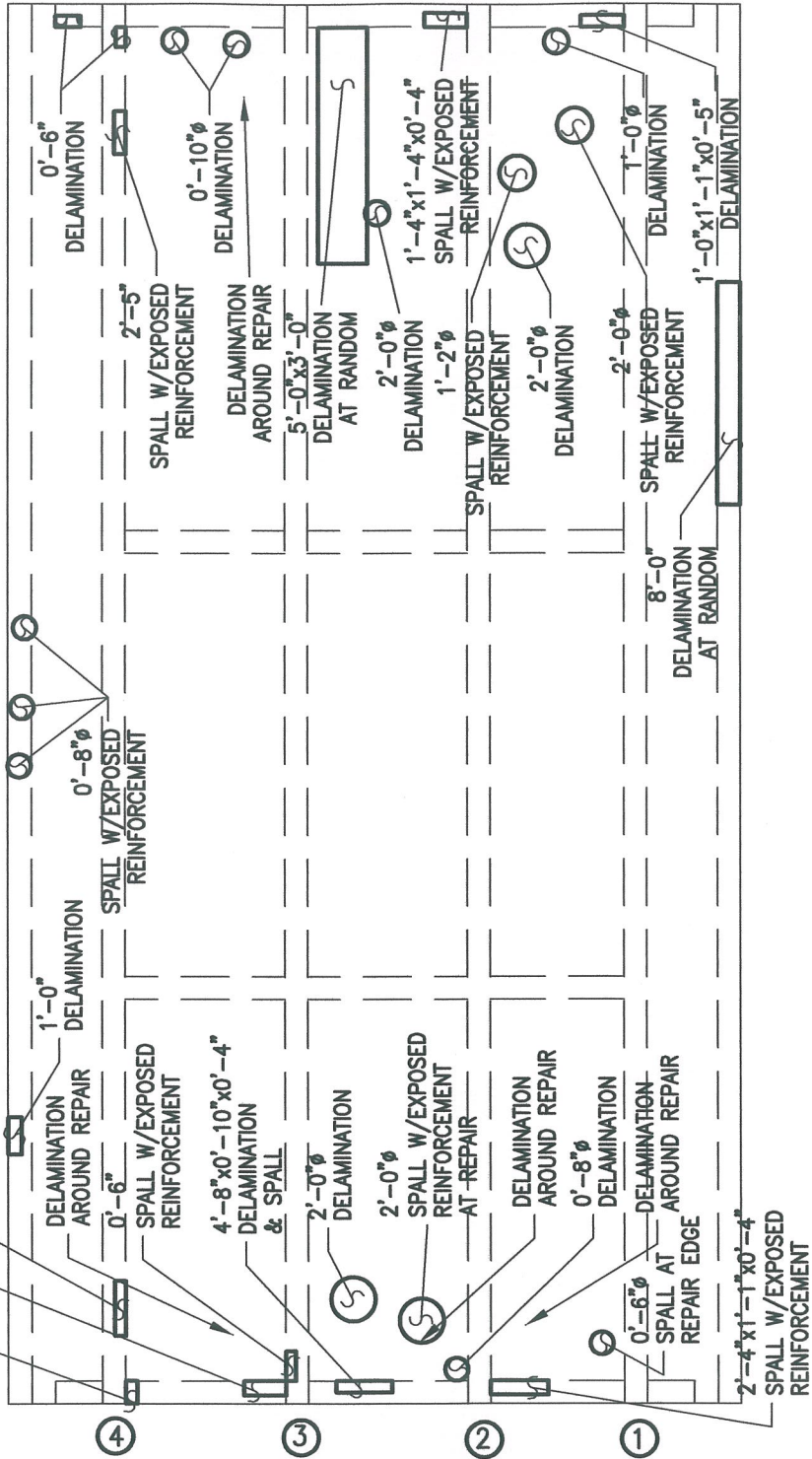

PLAN OF DECK UNDERSIDE



ALPHA & OMEGA GROUP
 CIVIL & STRUCTURAL ENGINEERS

4911 Green Road Suite 107 Raleigh, NC 27616
 Phone 919 981 0310 Fax 919 981 0451
 Email info@aogroup.com www.aogroup.com

BRIDGE NO:	270011		
COUNTY:	DARE		
PREPARED BY:	OHS	CHECKED BY:	TGZ
SCALE:	NTS		
DATE:	6/20/06	SHT	768 OF 1347

BENT # 113

BENT # 114

13'-0" SPALL W/
JOINT SEPARATION

3'-11" SPALL W/
JOINT SEPARATION

2'-11" SPALL W/
JOINT SEPARATION

MINOR SPALL

0'-10" DELAMINATION

PLAN OF DECK SURFACE



ALPHA & OMEGA GROUP
CIVIL & STRUCTURAL ENGINEERS

4911 Green Road Suite 107 Raleigh, NC 27616
Phone 919 981 0310 Fax 919 981 0451
Email info@aogroup.com www.aogroup.com

BRIDGE NO: 270011

COUNTY: DARE

PREPARED BY: ACS CHECKED BY: TGZ

SCALE: NTS

DATE: 6/20/06 SHT 773 OF 1347

BENT #113

BENT #114

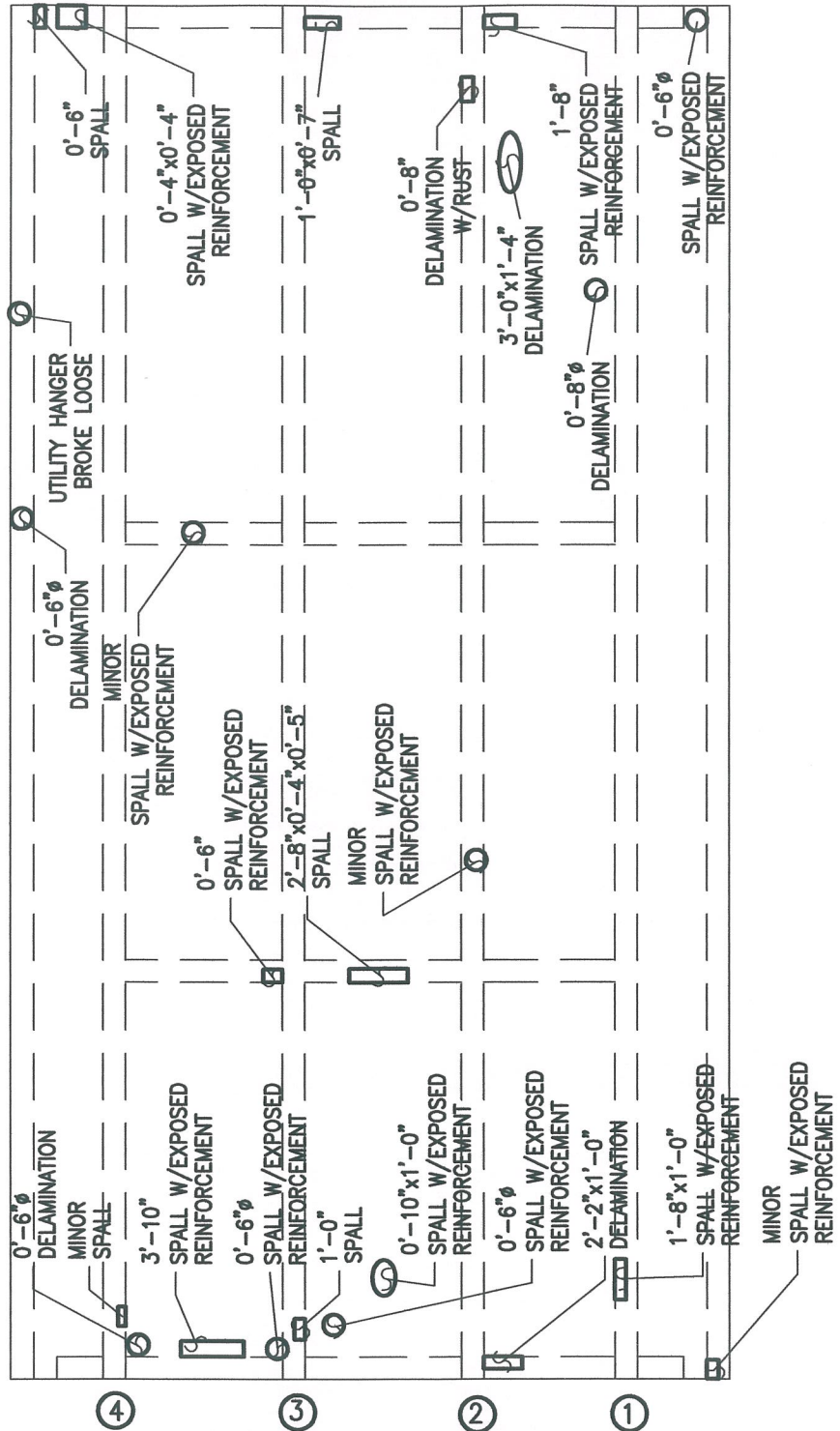

PLAN OF DECK UNDERSIDE



ALPHA & OMEGA GROUP
 CIVIL & STRUCTURAL ENGINEERS

4911 Green Road Suite 107 Raleigh, NC 27616
 Phone 919 981 0310 Fax 919 981 0451
 Email info@aogroup.com www.aogroup.com

BRIDGE NO:	270011		
COUNTY:	DARE		
PREPARED BY:	OHS	CHECKED BY:	TGZ
SCALE:	NTS		
DATE:	6/20/06	SHT	774 OF 1347

BENT # 114

4'-8" DELAMINATION
& SPALL W/JOINT
SEPARATION

5'-0" DELAMINATION
& SPALL W/JOINT
SEPARATION

1'-0" \emptyset DELAMINATION

2'-10" DELAMINATION
& SPALL W/JOINT
SEPARATION

1'-0" DELAMINATION &
SPALL W/JOINT
SEPARATION

BENT # 115

PLAN OF DECK SURFACE



ALPHA & OMEGA GROUP
CIVIL & STRUCTURAL ENGINEERS

4911 Green Road Suite 107 Raleigh, NC 27616
Phone 919 981 0310 Fax 919 981 0451
Email info@aogroup.com www.aogroup.com

BRIDGE NO: 270011

COUNTY: DARE

PREPARED BY: ACS CHECKED BY: TGZ

SCALE: NTS

DATE: 6/20/06 SHT 779 OF 1347

BENT #114

BENT #115

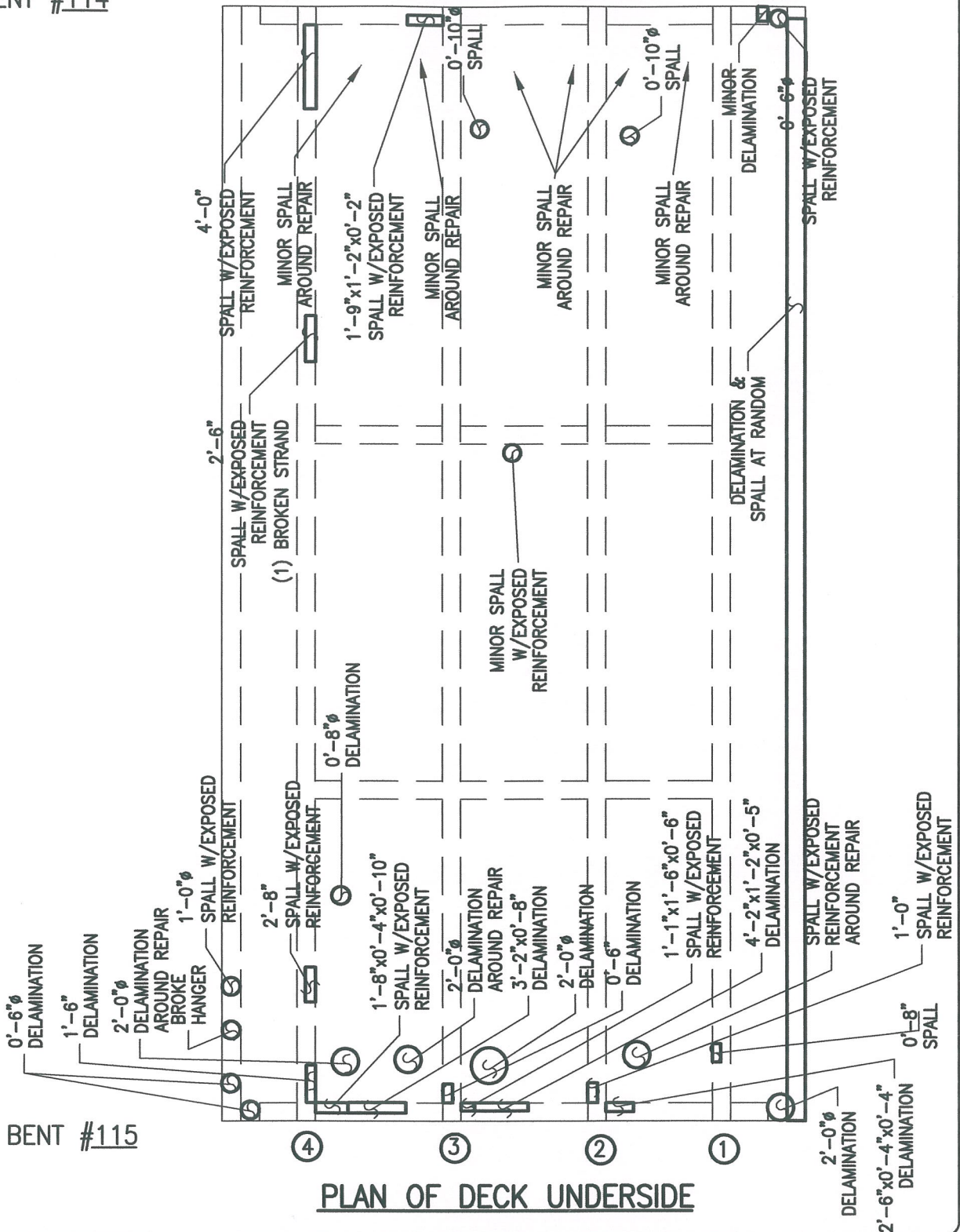

PLAN OF DECK UNDERSIDE



ALPHA & OMEGA GROUP
 CIVIL & STRUCTURAL ENGINEERS

4911 Green Road Suite 107 Raleigh, NC 27616
 Phone 919 981 0310 Fax 919 981 0451
 Email info@aogroup.com www.aogroup.com

BRIDGE NO: 270011

COUNTY: DARE

PREPARED BY: OHS CHECKED BY: TGZ

SCALE: NTS

DATE: 6/20/06 SHT 780 OF 1347

BENT # 115

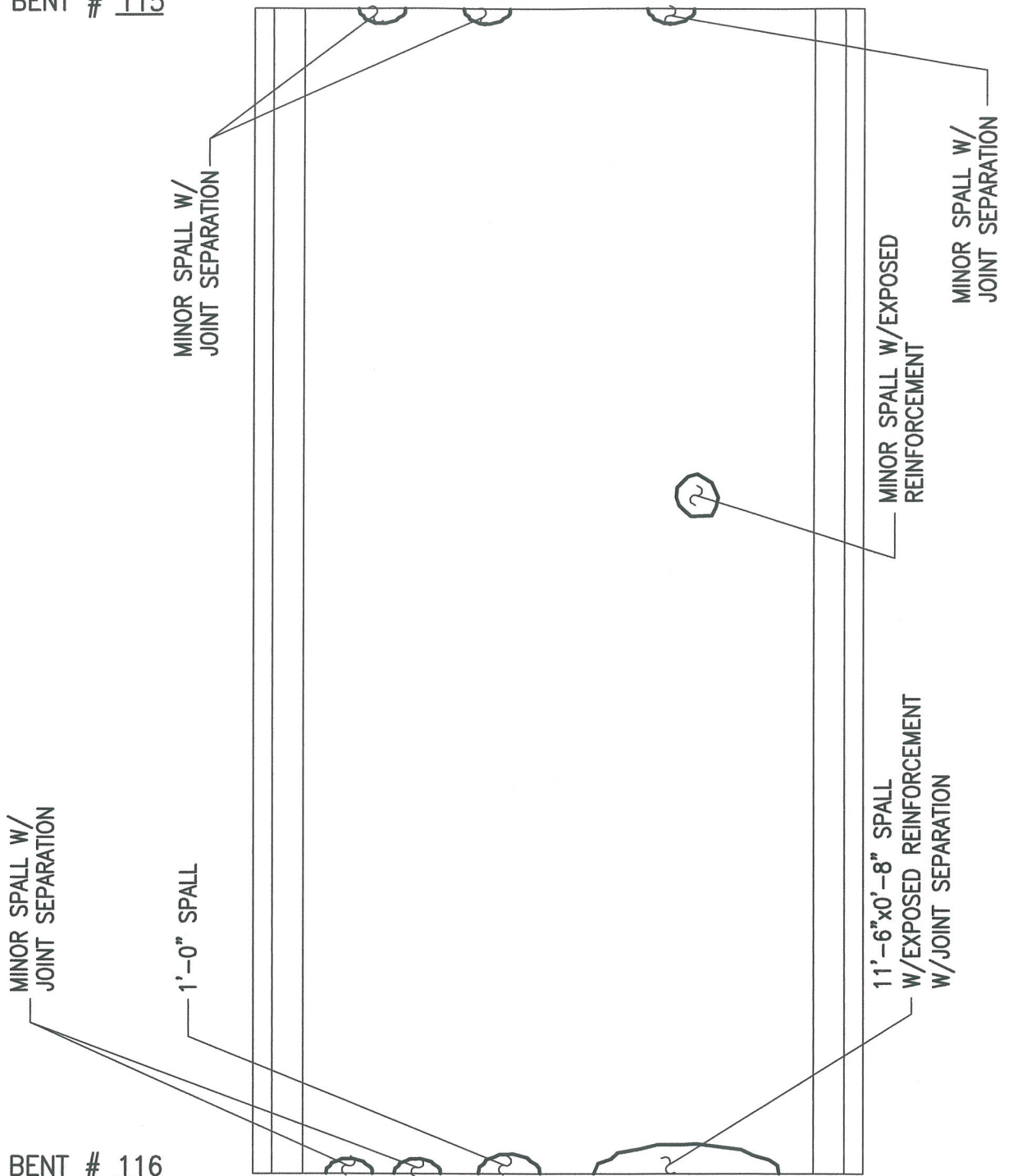

BENT # 116

PLAN OF DECK SURFACE



ALPHA & OMEGA GROUP
CIVIL & STRUCTURAL ENGINEERS

4911 Green Road Suite 107 Raleigh, NC 27616
Phone 919 981 0310 Fax 919 981 0451
Email info@aogroup.com www.aogroup.com

BRIDGE NO:	270011		
COUNTY:	DARE		
PREPARED BY:	ACS	CHECKED BY:	TGZ
SCALE:	NTS		
DATE:	6/20/06	SHT 765 OF 1347	

BENT #115

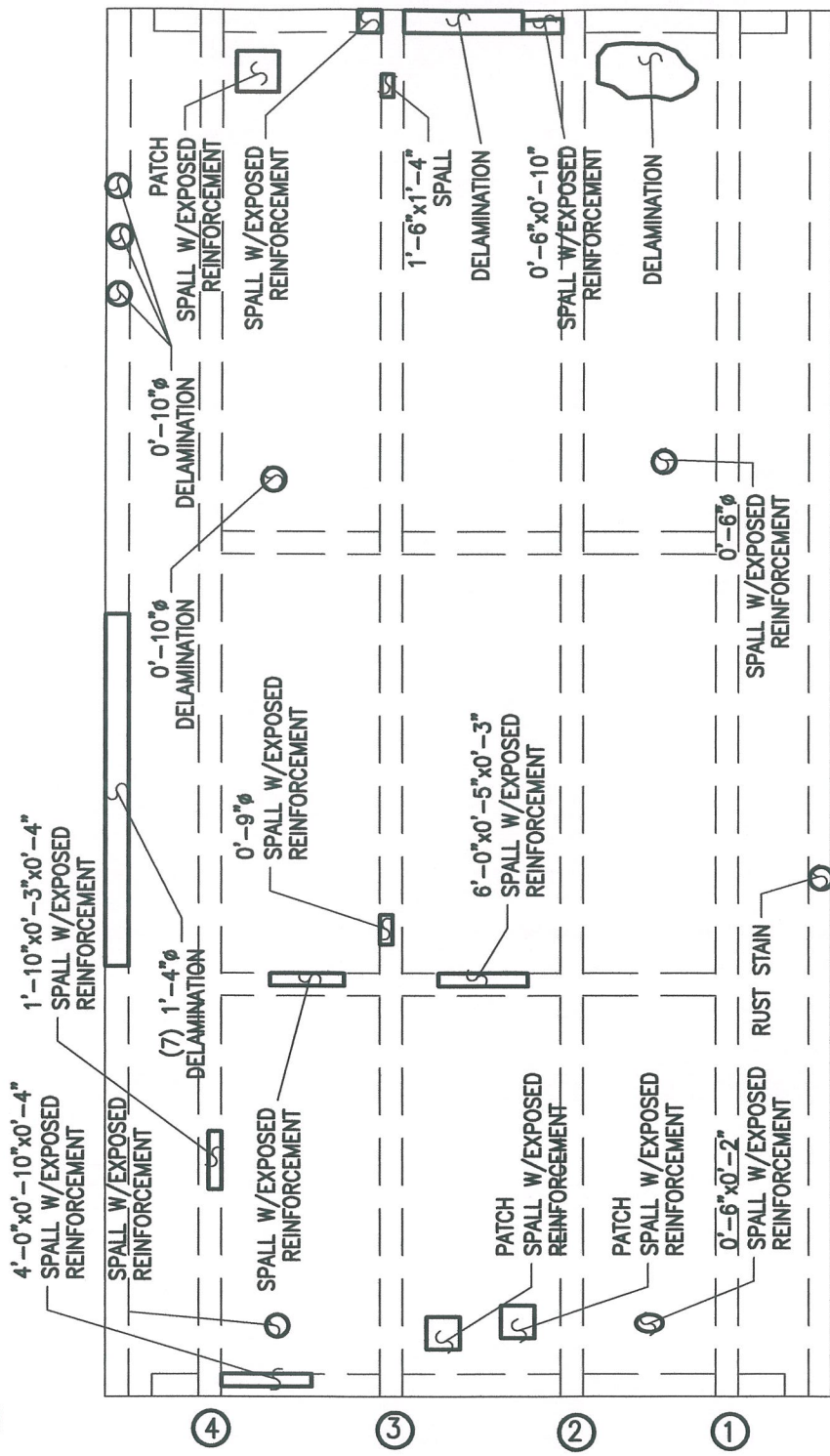

BENT #116

PLAN OF DECK UNDERSIDE



ALPHA & OMEGA GROUP
 CIVIL & STRUCTURAL ENGINEERS

4911 Green Road Suite 107 Raleigh, NC 27616
 Phone 919 981 0310 Fax 919 981 0451
 Email info@aogroup.com www.aogroup.com

BRIDGE NO:	270011
COUNTY:	DARE
PREPARED BY:	OHS
CHECKED BY:	TGZ
SCALE:	NTS
DATE:	6/20/06
	SHT 786 OF 1347

BENT # 116

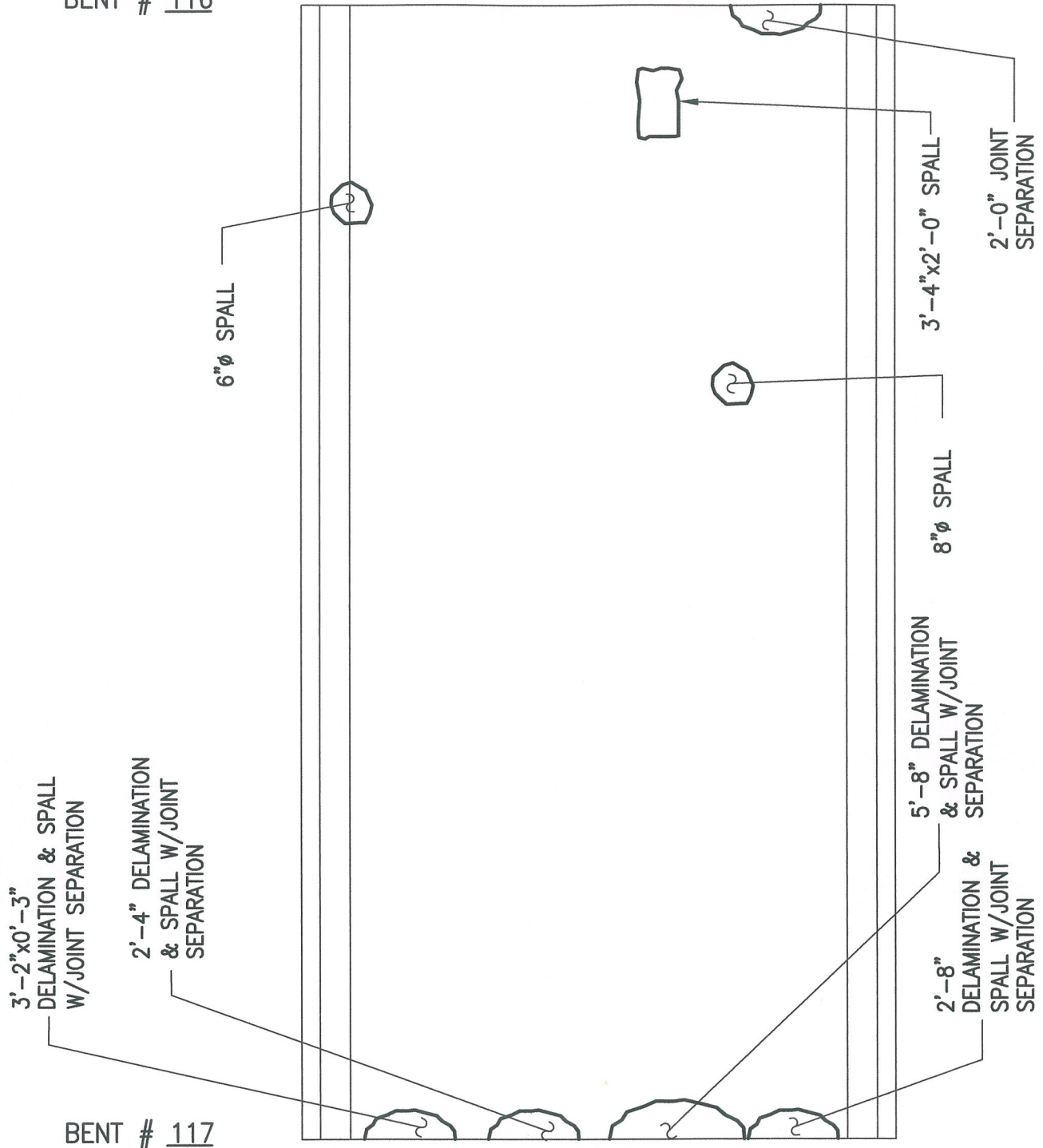

BENT # 117

PLAN OF DECK SURFACE



ALPHA & OMEGA GROUP
CIVIL & STRUCTURAL ENGINEERS

4911 Green Road Suite 107 Raleigh, NC 27616
Phone 919 981 0310 Fax 919 981 0451
Email info@aogroup.com www.aogroup.com

BRIDGE NO: 270011

COUNTY: DARE

PREPARED BY: ACS CHECKED BY: TGZ

SCALE: NTS

DATE: 6/20/06 SHT 791 OF 1347

BENT #116

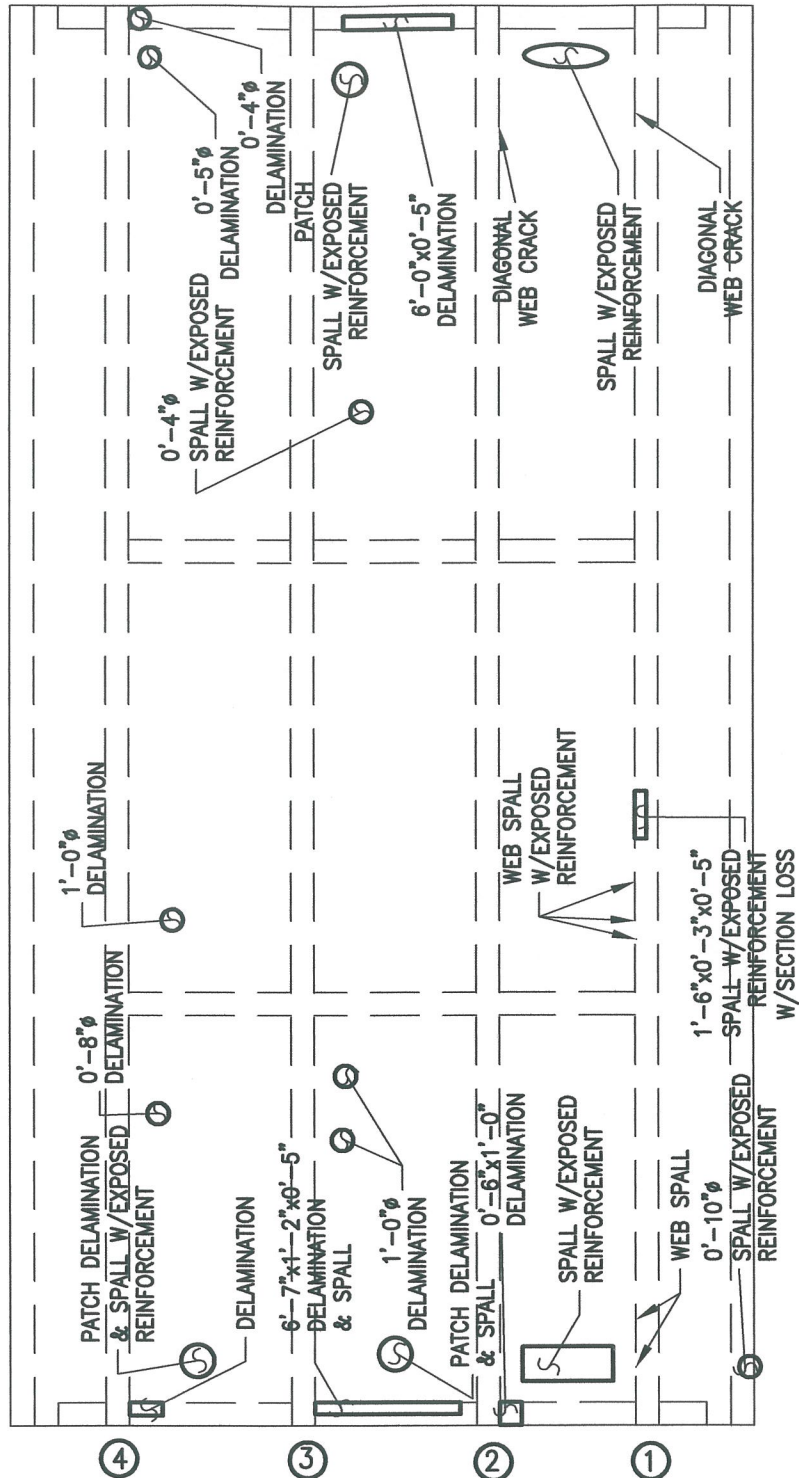

BENT #117

PLAN OF DECK UNDERSIDE



ALPHA & OMEGA GROUP
 CIVIL & STRUCTURAL ENGINEERS

4911 Green Road Suite 107 Raleigh, NC 27616
 Phone 919 981 0310 Fax 919 981 0451
 Email info@aogroup.com www.aogroup.com

BRIDGE NO: 270011

COUNTY: DARE

PREPARED BY: OHS CHECKED BY: TGZ

SCALE: NTS

DATE: 6/20/06 SHT 792 OF 1347

BENT # 117

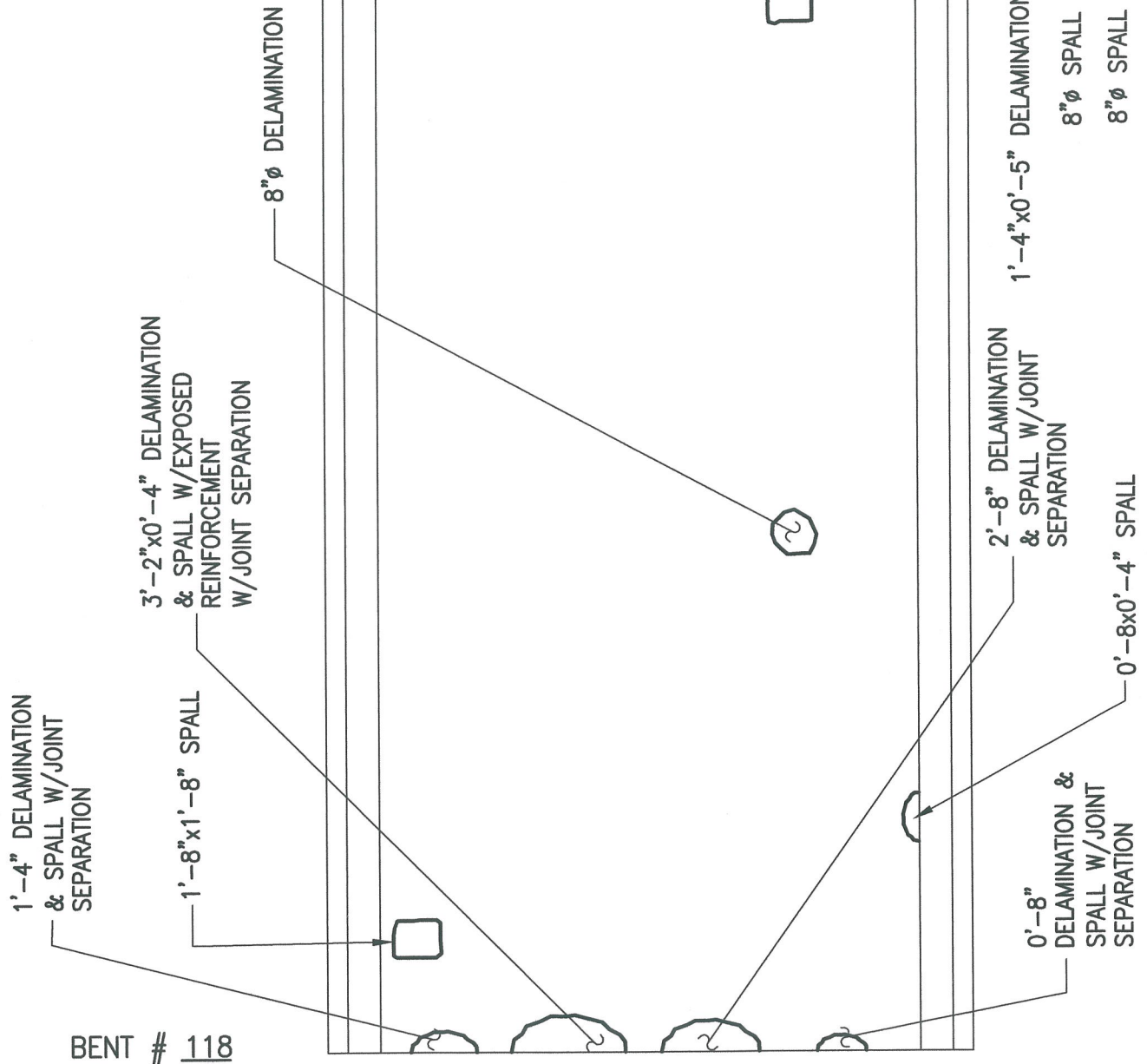

BENT # 118

PLAN OF DECK SURFACE



ALPHA & OMEGA GROUP
CIVIL & STRUCTURAL ENGINEERS

4911 Green Road Suite 107 Raleigh, NC 27616
Phone 919 981 0310 Fax 919 981 0451
Email info@aogroup.com www.aogroup.com

BRIDGE NO: 270011

COUNTY: DARE

PREPARED BY: ACS CHECKED BY: TGZ

SCALE: NTS

DATE: 6/20/06 SHT 717 OF 1347

BENT #117

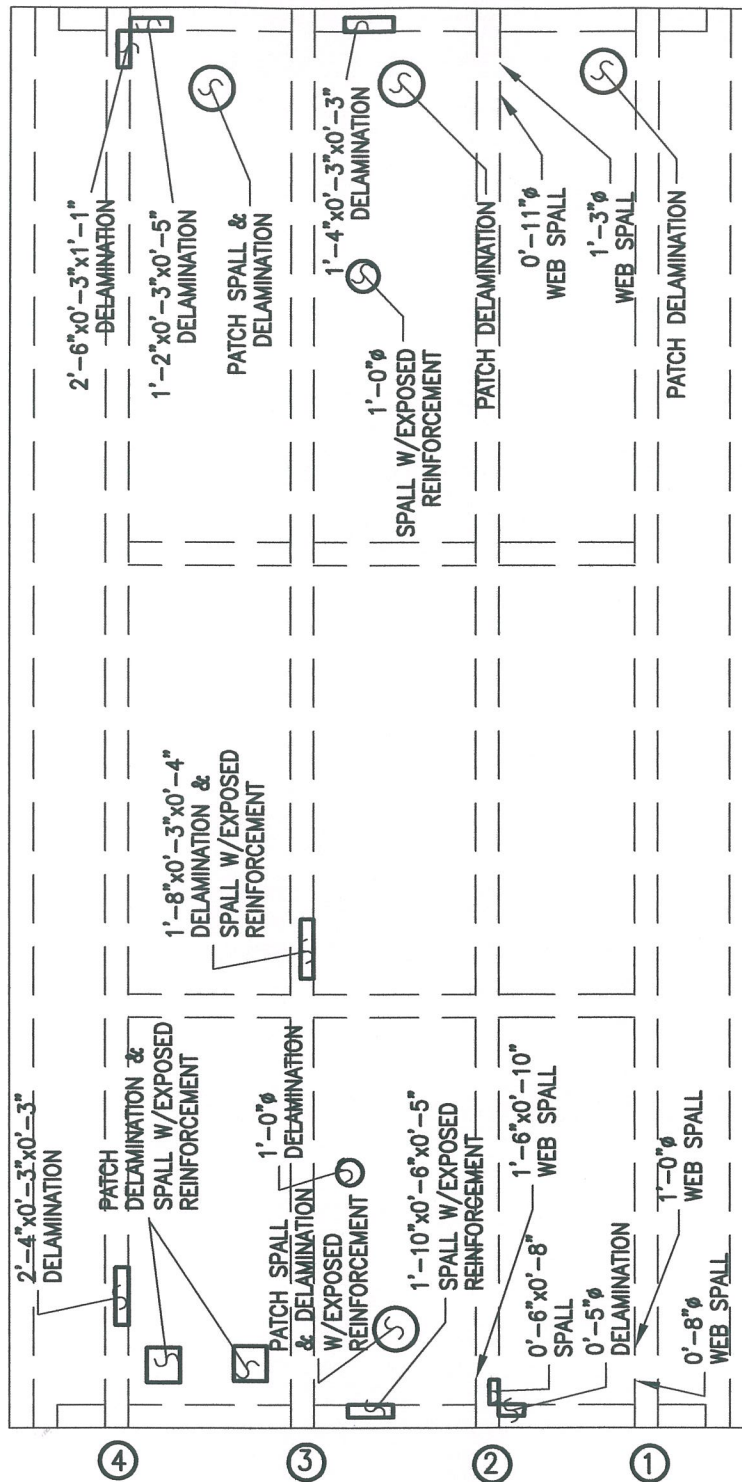

BENT #118

PLAN OF DECK UNDERSIDE



ALPHA & OMEGA GROUP
 CIVIL & STRUCTURAL ENGINEERS

4911 Green Road Suite 107 Raleigh, NC 27616
 Phone 919 981 0310 Fax 919 981 0451
 Email info@aogroup.com www.aogroup.com

BRIDGE NO:	270011
COUNTY:	DARE
PREPARED BY:	OHS
CHECKED BY:	TGZ
SCALE:	NTS
DATE:	6/20/06
	SHT 798 OF 1347

BENT # 118

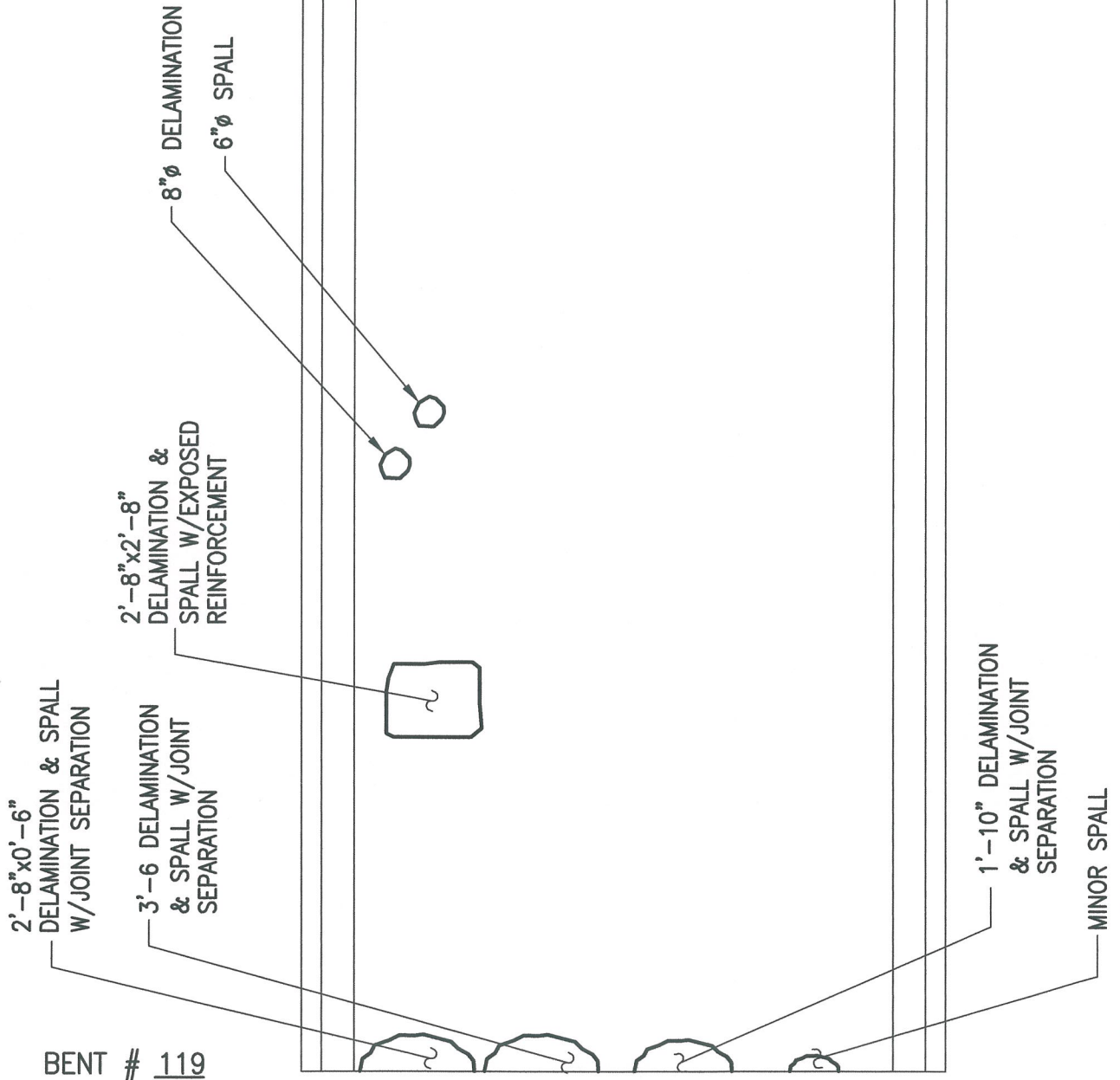

BENT # 119

PLAN OF DECK SURFACE



ALPHA & OMEGA GROUP
CIVIL & STRUCTURAL ENGINEERS

4911 Green Road Suite 107 Raleigh, NC 27616
Phone 919 981 0310 Fax 919 981 0451
Email info@aogroup.com www.aogroup.com

BRIDGE NO: 270011

COUNTY: DARE

PREPARED BY: ACS CHECKED BY: TGZ

SCALE: NTS

DATE: 6/20/06 SHT 803 OF 1347

BENT #118

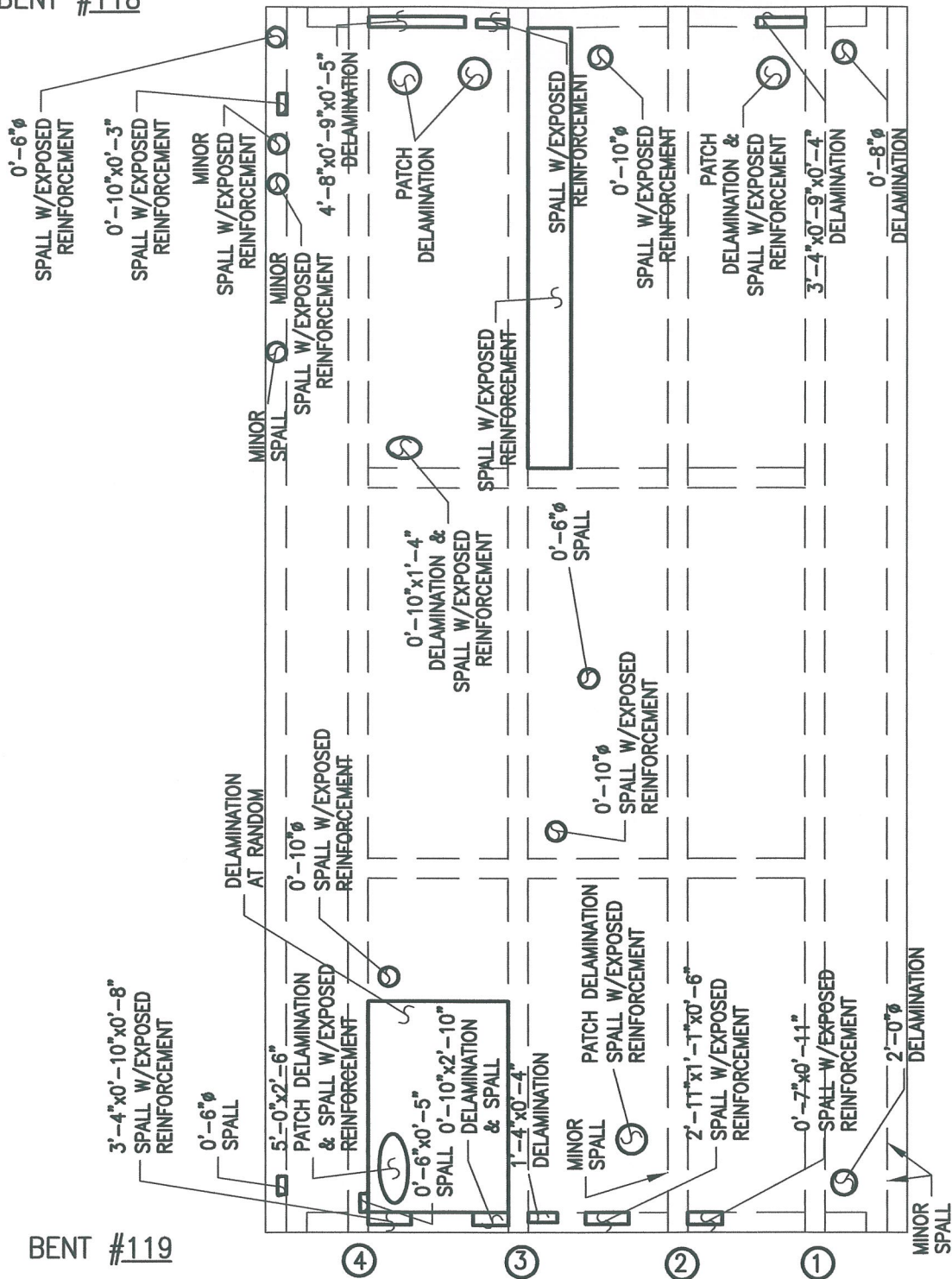

PLAN OF DECK UNDERSIDE



ALPHA & OMEGA GROUP
 CIVIL & STRUCTURAL ENGINEERS

4911 Green Road Suite 107 Raleigh, NC 27616
 Phone 919 981 0310 Fax 919 981 0451
 Email info@aogroup.com www.aogroup.com

BRIDGE NO: 270011

COUNTY: DARE

PREPARED BY: OHS CHECKED BY: TGZ

SCALE: NTS

DATE: 6/20/06 SHT 804 OF 1347

BENT # 119

4'-0" x 0'-6"
DELAMINATION &
SPALL W/JOINT
SEPARATION

3'-0" DELAMINATION
& SPALL W/JOINT
SEPARATION

0'-4" DELAMINATION
& SPALL W/JOINT
SEPARATION

0'-3" DELAMINATION
& SPALL W/JOINT
SEPARATION

BENT # 120

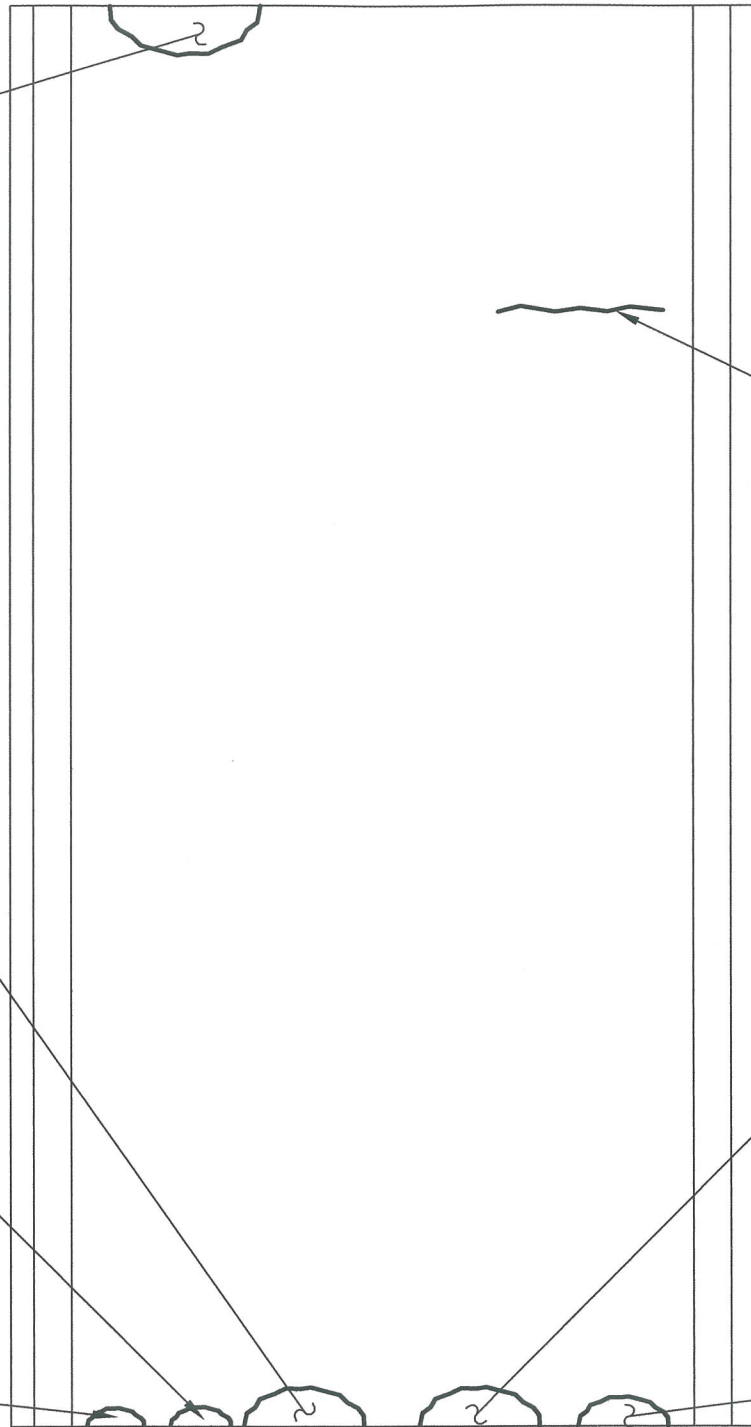

7'-0" CRACK

3'-0" DELAMINATION
& SPALL W/JOINT
SEPARATION

2'-2" DELAMINATION
& SPALL W/JOINT
SEPARATION

PLAN OF DECK SURFACE



ALPHA & OMEGA GROUP
CIVIL & STRUCTURAL ENGINEERS

4911 Green Road Suite 107 Raleigh, NC 27616
Phone 919 981 0310 Fax 919 981 0451
Email info@aogroup.com www.aogroup.com

BRIDGE NO: 270011

COUNTY: DARE

PREPARED BY: ACS CHECKED BY: TGZ

SCALE: NTS

DATE: 6/20/06 SHT 609 OF 1347

BENT #119

BENT #120

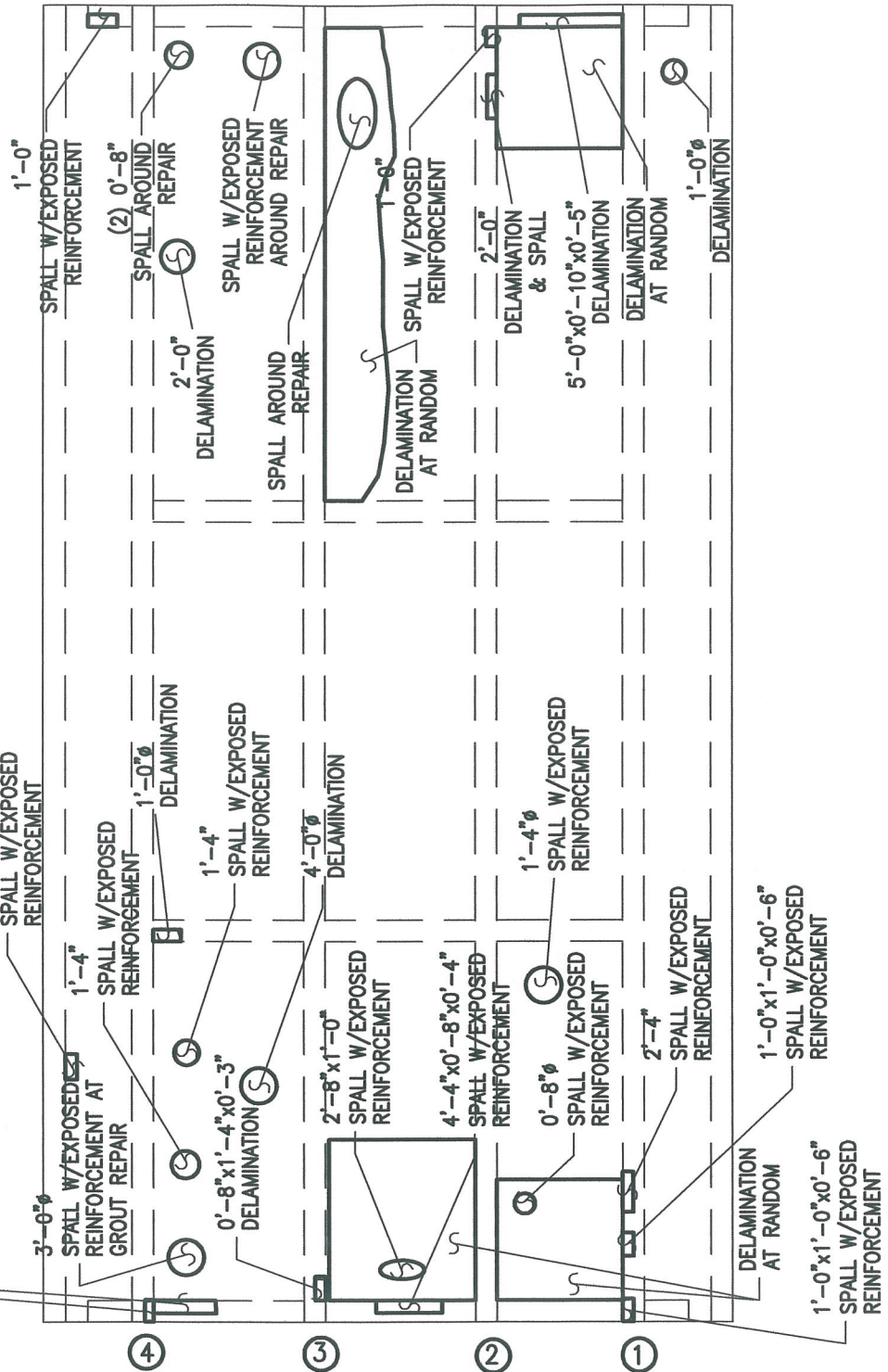

PLAN OF DECK UNDERSIDE



ALPHA & OMEGA GROUP
 CIVIL & STRUCTURAL ENGINEERS

4911 Green Road Suite 107 Raleigh, NC 27616
 Phone 919 981 0310 Fax 919 981 0451
 Email info@aogroup.com www.aogroup.com

BRIDGE NO: 270011

COUNTY: DARE

PREPARED BY: OHS CHECKED BY: TGZ

SCALE: NTS

DATE: 6/20/06 SHT 10 OF 347

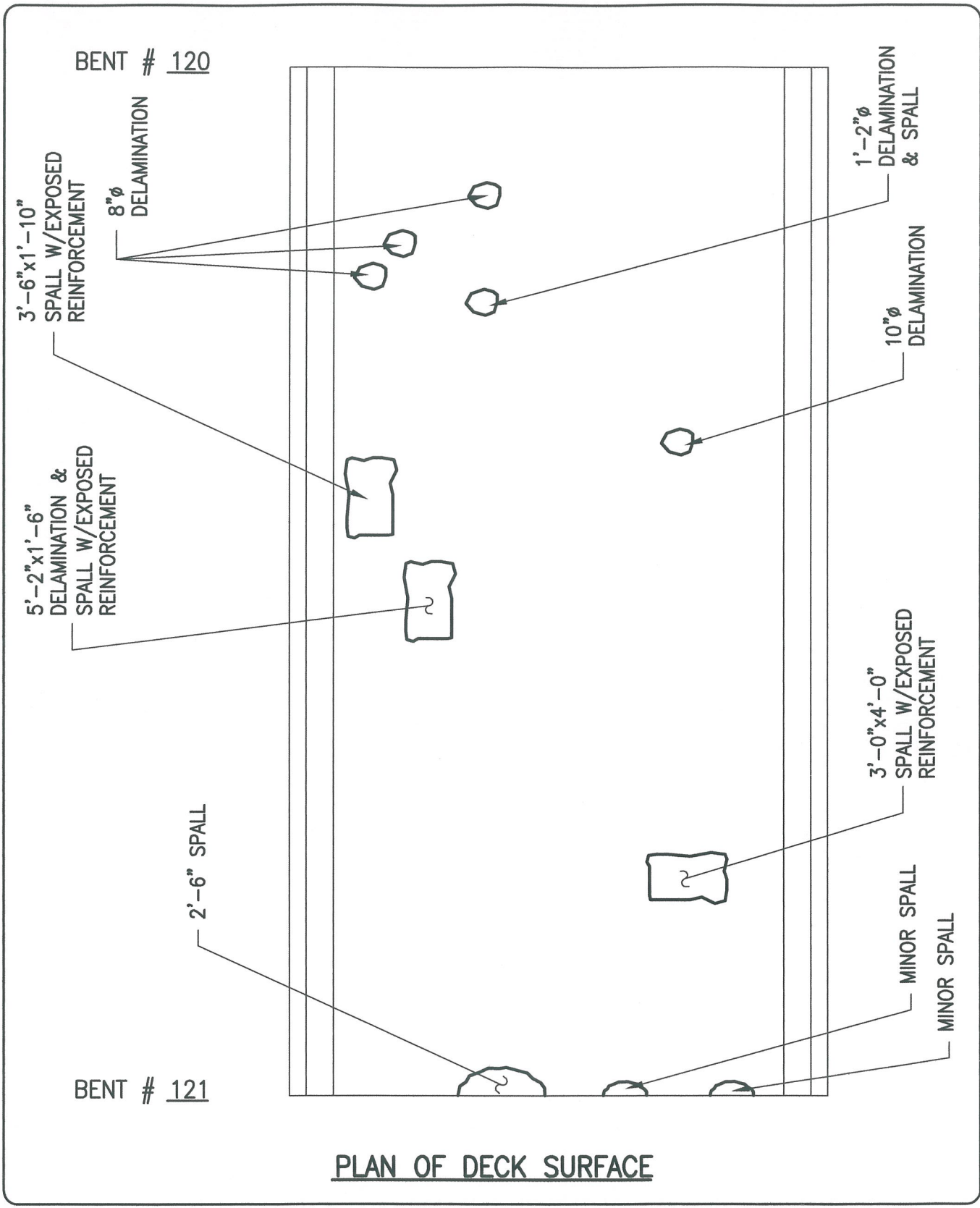

PLAN OF DECK SURFACE



ALPHA & OMEGA GROUP
 CIVIL & STRUCTURAL ENGINEERS
 4911 Green Road Suite 107 Raleigh, NC 27616
 Phone 919 981 0310 Fax 919 981 0451
 Email info@aogroup.com www.aogroup.com

BRIDGE NO:	270011		
COUNTY:	DARE		
PREPARED BY:	ACS	CHECKED BY:	TGZ
SCALE:	NTS		
DATE:	6/20/06	SHT	415 OF 1347

BENT #120

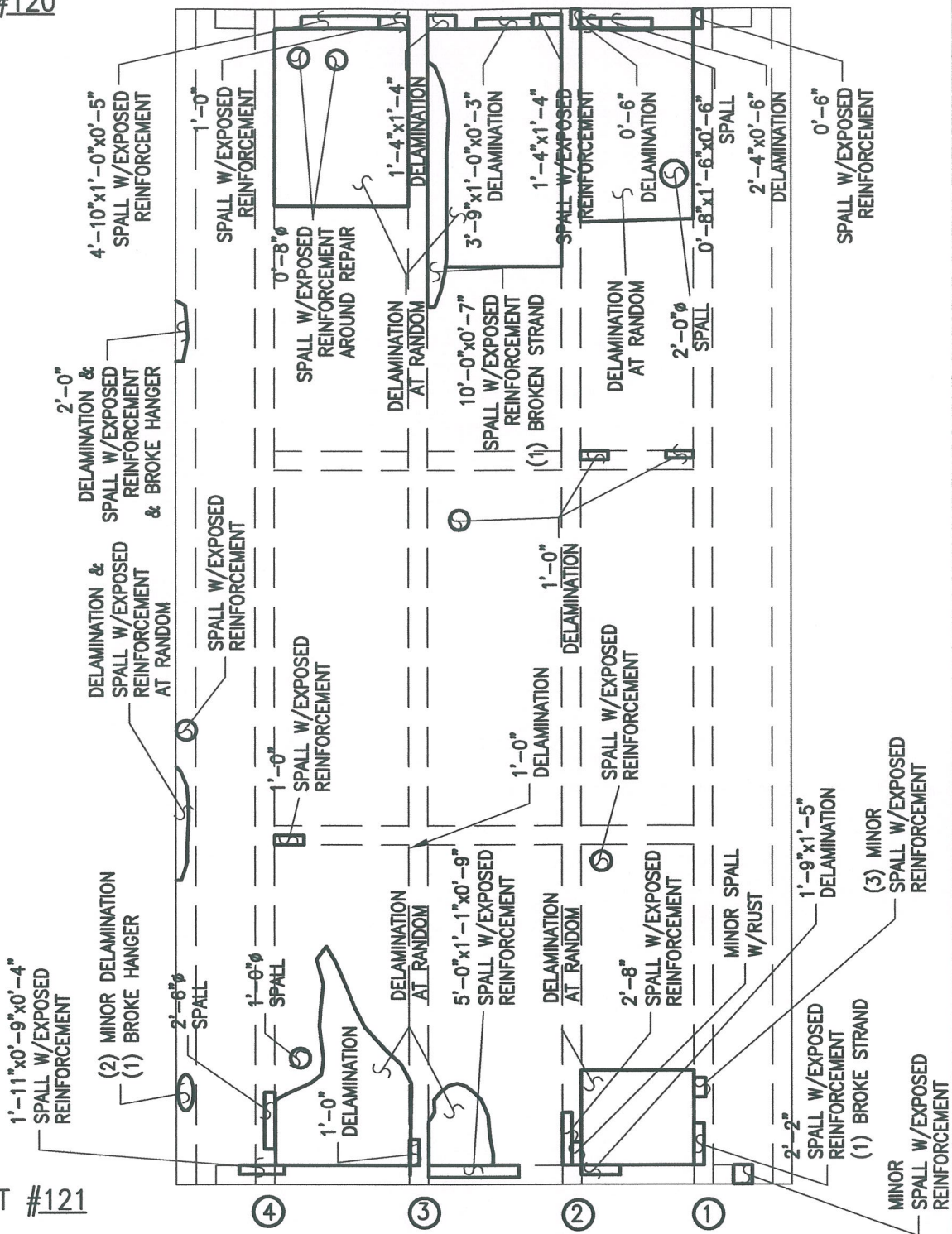

PLAN OF DECK UNDERSIDE

ALPHA & OMEGA GROUP
 CIVIL & STRUCTURAL ENGINEERS
 4911 Green Road Suite 107 Raleigh, NC 27616
 Phone 919 981 0310 Fax 919 981 0451
 Email info@aogroup.com www.aogroup.com

BRIDGE NO:	270011		
COUNTY:	DARE		
PREPARED BY:	OHS	CHECKED BY:	TGZ
SCALE:	NTS		
DATE:	6/20/06	SHT	816 OF 1347

BENT # 121

2'-0" DELAMINATION

MINOR SPALL

0'-8" x 1'-8" DELAMINATION

6" ϕ SPALL

10" DELAMINATION

MINOR SPALL

BENT # 122

PLAN OF DECK SURFACE



ALPHA & OMEGA GROUP
CIVIL & STRUCTURAL ENGINEERS

4911 Green Road Suite 107 Raleigh, NC 27616
Phone 919 981 0310 Fax 919 981 0451
Email info@aogroup.com www.aogroup.com

BRIDGE NO: 270011

COUNTY: DARE

PREPARED BY: ACS CHECKED BY: TGZ

SCALE: NTS

DATE: 6/20/06 SHT 821 OF 1347

BENT #121

BENT #122

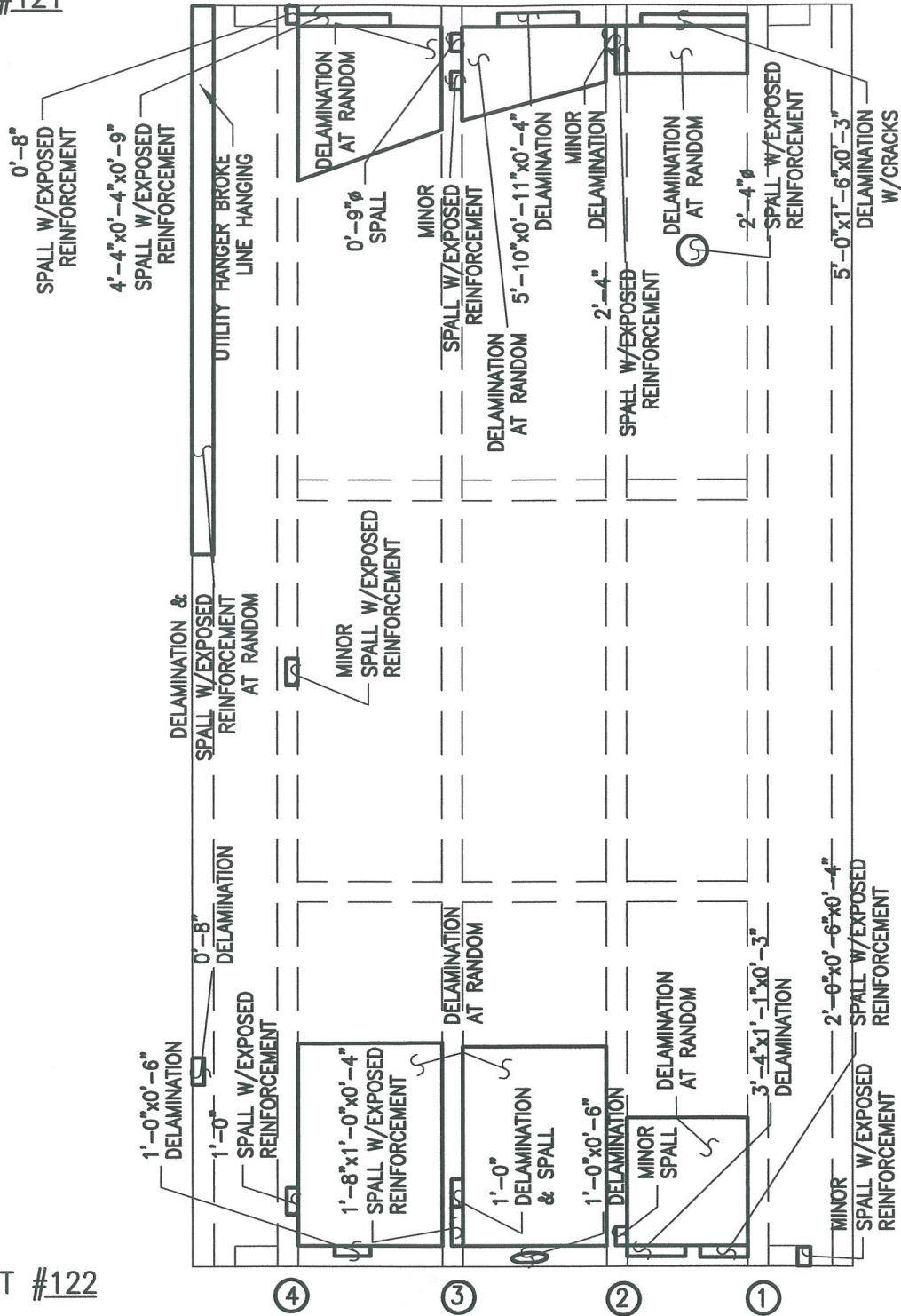

PLAN OF DECK UNDERSIDE



ALPHA & OMEGA GROUP
 CIVIL & STRUCTURAL ENGINEERS

4911 Green Road Suite 107 Raleigh, NC 27616
 Phone 919 981 0310 Fax 919 981 0451
 Email info@aogroup.com www.aogroup.com

BRIDGE NO: 270011

COUNTY: DARE

PREPARED BY: OHS CHECKED BY: TGZ

SCALE: NTS

DATE: 6/20/06 SHT 22 OF 1347

BENT # 122

BENT # 123

SURFACE SCALING

MINOR SPALL

2'-4" SPALL W/
JOINT SEPARATION

8" SPALL
W/EXPOSED
REINFORCEMENT

4" SPALL W/EXPOSED
REINFORCEMENT

PLAN OF DECK SURFACE



ALPHA & OMEGA GROUP
 CIVIL & STRUCTURAL ENGINEERS
 4911 Green Road Suite 107 Raleigh, NC 27616
 Phone 919 981 0310 Fax 919 981 0451
 Email info@aogroup.com www.aogroup.com

BRIDGE NO:	270011		
COUNTY:	DARE		
PREPARED BY:	ACS	CHECKED BY:	TGZ
SCALE:	NTS		
DATE:	6/20/06	SHT	627 OF 1347

BENT #122

BENT #123

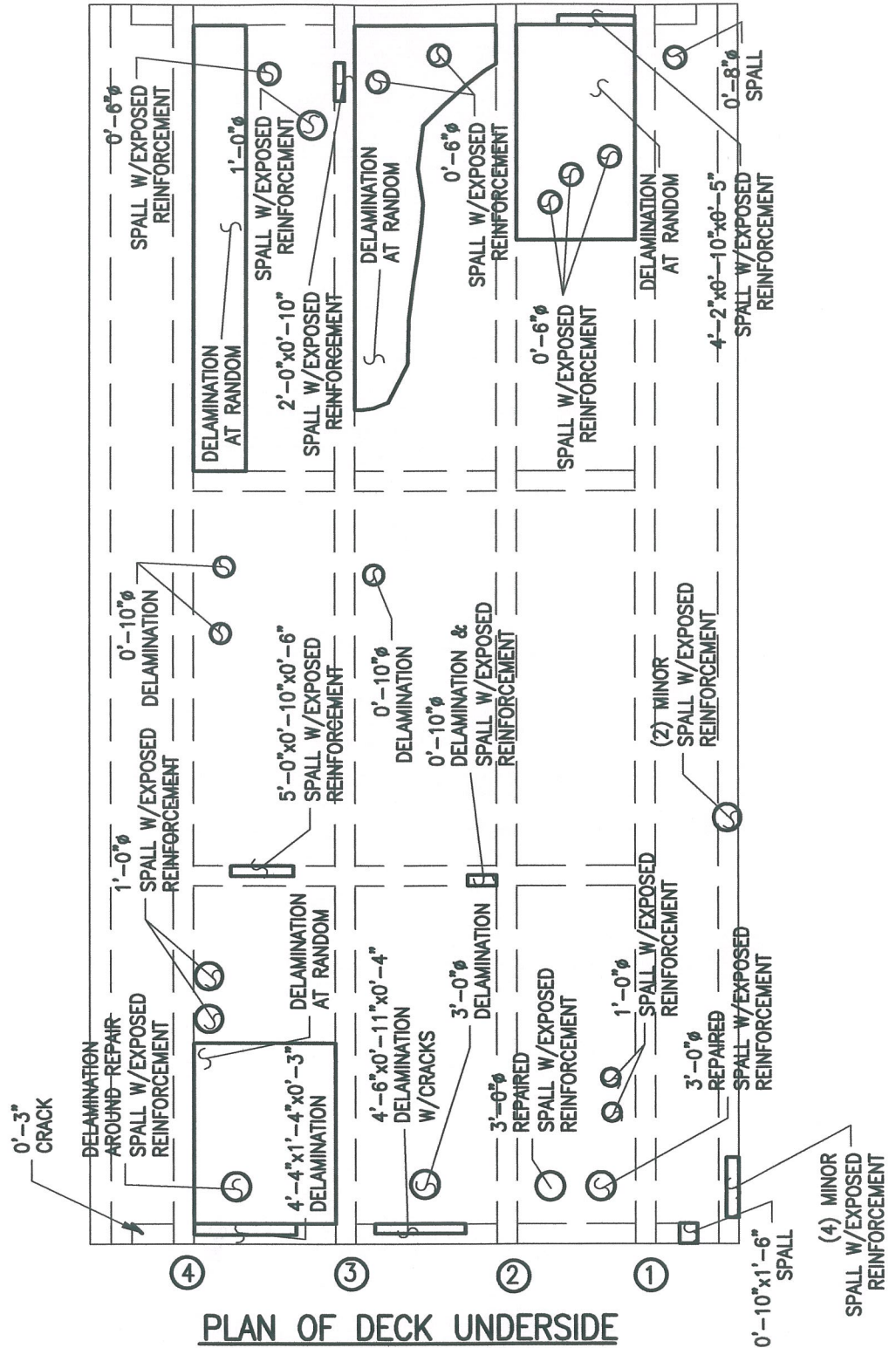

PLAN OF DECK UNDERSIDE



ALPHA & OMEGA GROUP
 CIVIL & STRUCTURAL ENGINEERS

4911 Green Road Suite 107 Raleigh, NC 27616
 Phone 919 981 0310 Fax 919 981 0451
 Email info@aogroup.com www.aogroup.com

BRIDGE NO: 270011

COUNTY: DARE

PREPARED BY: OHS CHECKED BY: TGZ

SCALE: NTS

DATE: 6/20/06 SHT 828 OF 1347

BENT # 123

7'-6" EXPANSION
JOINT MATERIAL
MISSING

CRACK IN ASPHALT
PAVEMENT

4'-0"x0'-8" SPALL

BENT # 124

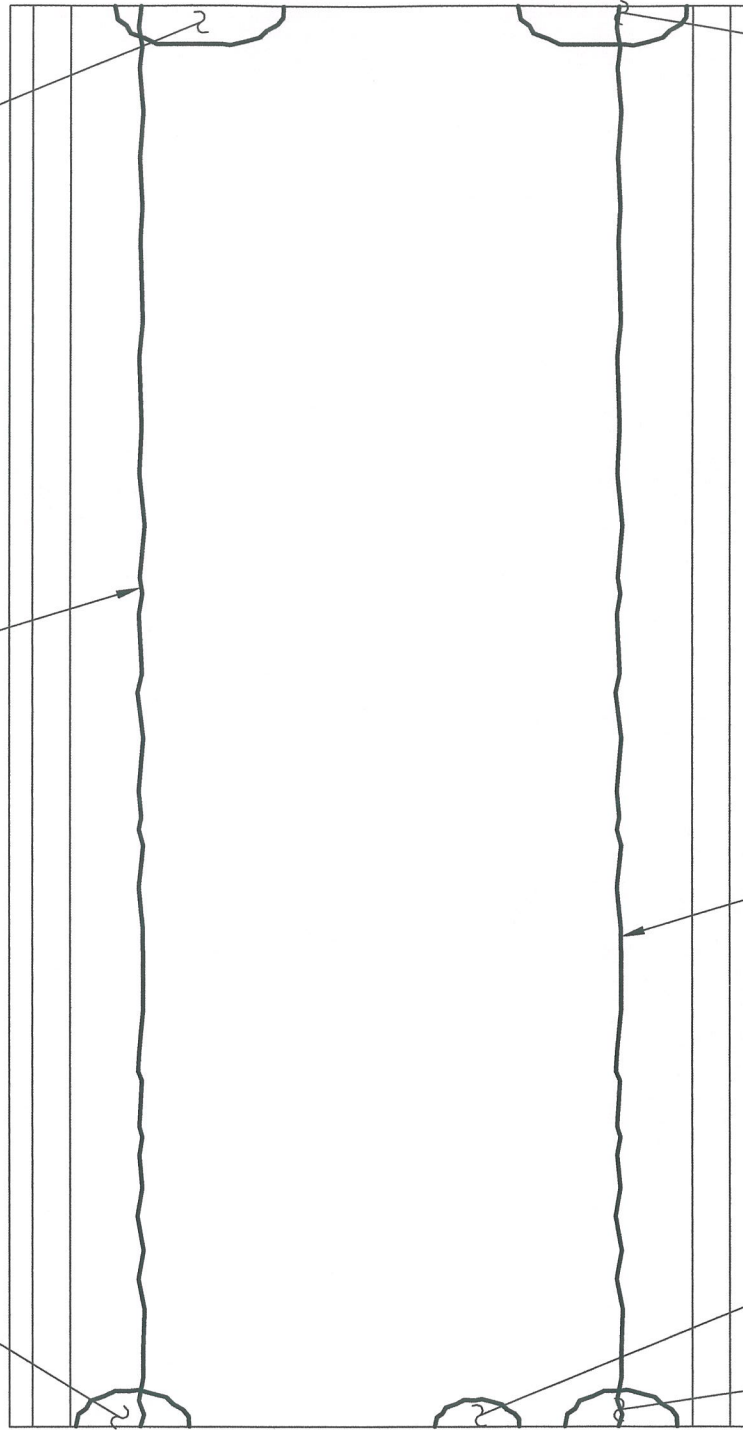

5'-10"x0'-6"
EXPANSION JOINT
MATERIAL MISSING

CRACK IN ASPHALT
PAVEMENT

1'-8"x0'-6" SPALL

3'-4"x0'-10" SPALL

PLAN OF DECK SURFACE



ALPHA & OMEGA GROUP
CIVIL & STRUCTURAL ENGINEERS

4911 Green Road Suite 107 Raleigh, NC 27616
Phone 919 981 0310 Fax 919 981 0451
Email info@aogroup.com www.aogroup.com

BRIDGE NO:	270011		
COUNTY:	DARE		
PREPARED BY:	ACS	CHECKED BY:	TGZ
SCALE:	NTS		
DATE:	6/20/06	SHT	633 OF 1347

BENT #123

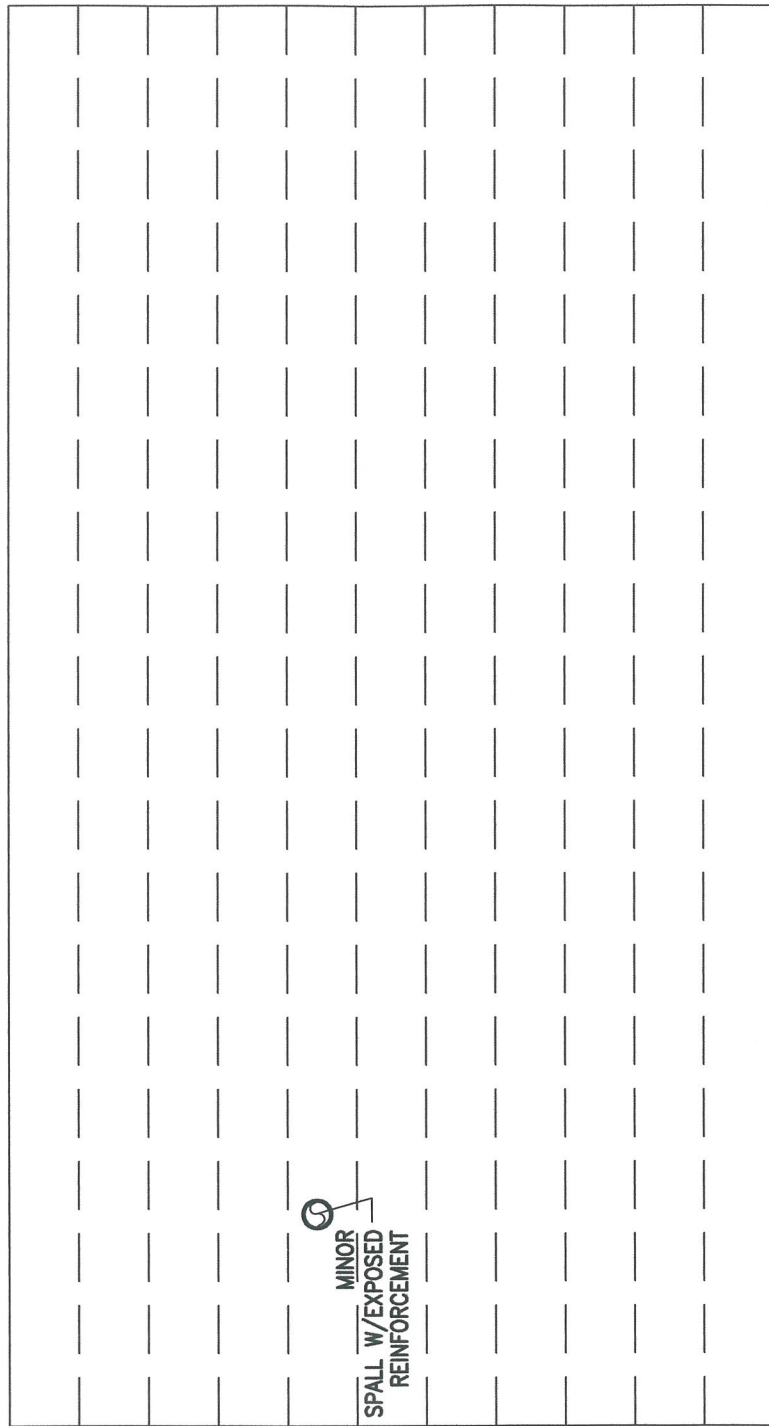

BENT #124

PLAN OF DECK UNDERSIDE-CORED SLAB



ALPHA & OMEGA GROUP
 CIVIL & STRUCTURAL ENGINEERS

4911 Green Road Suite 107 Raleigh, NC 27616
 Phone 919 981 0310 Fax 919 981 0451
 Email info@aogroup.com www.aogroup.com

BRIDGE NO: 270011

COUNTY: DARE

PREPARED BY: OHS CHECKED BY: TGZ

SCALE: NTS

DATE: 6/20/06 SHT 34 OF 1347

BENT # 124

15'-0" RUT IN ASPHALT
CONCRETE PAVEMENT

CRACK IN ASPHALT
PAVEMENT

5'-0"x1'-8" SPALL

2'-6"x0'-6"x0'-4"
SPALL ON TOP
OF PARAPET

(2) CRACK IN
ASPHALT PAVEMENT

CRACK AT
EXPANSION JOINT

4'-0"x0'-10" SPALL

BENT # 125

PLAN OF DECK SURFACE



ALPHA & OMEGA GROUP
CIVIL & STRUCTURAL ENGINEERS

4911 Green Road Suite 107 Raleigh, NC 27616
Phone 919 981 0310 Fax 919 981 0451
Email info@aogroup.com www.aogroup.com

BRIDGE NO: 270011

COUNTY: DARE

PREPARED BY: ACS CHECKED BY: TGZ

SCALE: NTS

DATE: 6/20/06 SHT 36 OF 1347

BENT #124

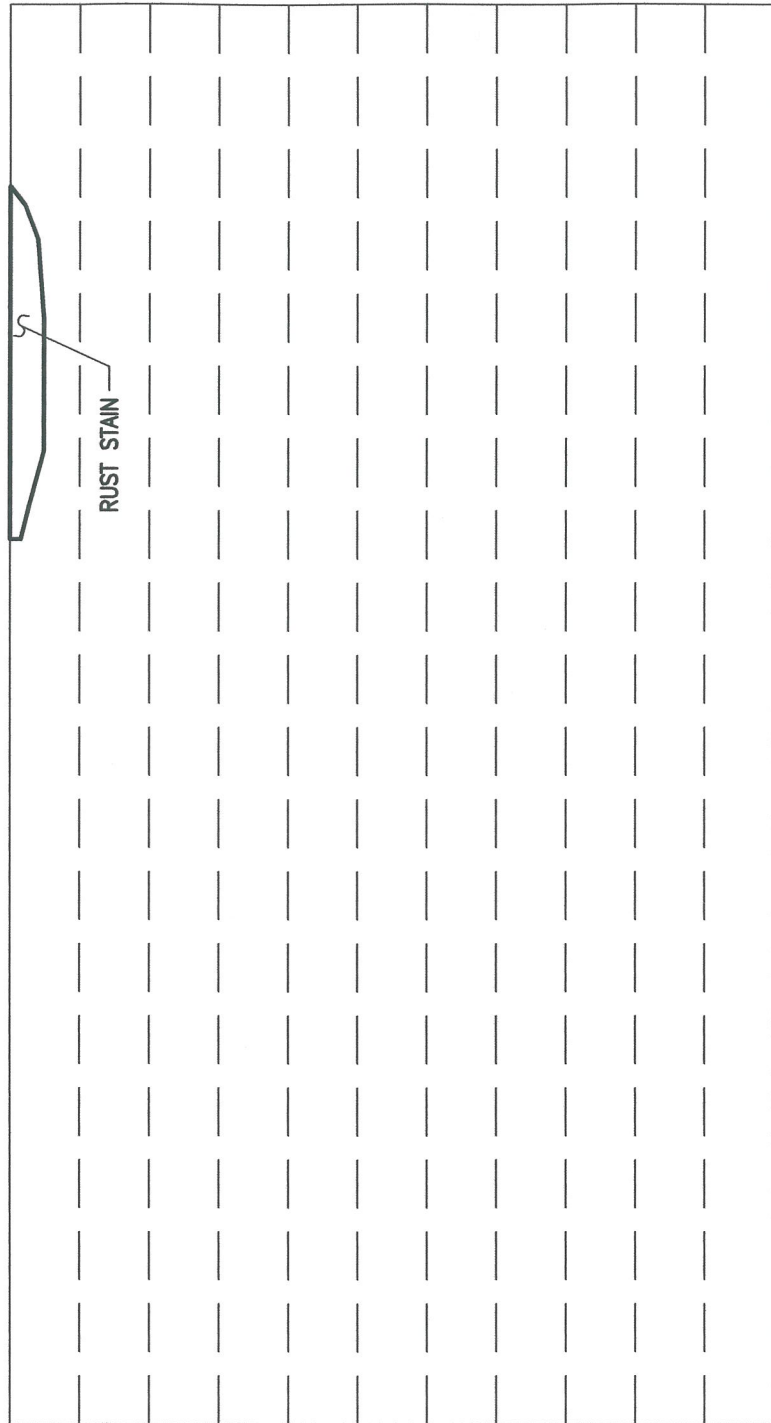

BENT #125

PLAN OF DECK UNDERSIDE-CORED SLAB



ALPHA & OMEGA GROUP
CIVIL & STRUCTURAL ENGINEERS

4911 Green Road Suite 107 Raleigh, NC 27616
Phone 919 981 0310 Fax 919 981 0451
Email info@aogroup.com www.aogroup.com

BRIDGE NO:	270011		
COUNTY:	DARE		
PREPARED BY:	OHS	CHECKED BY:	TGZ
SCALE:	NTS		
DATE:	6/20/06	SHT	39 OF 1347

BENT # 125

CRACK IN ASPHALT PAVEMENT

CRACK IN ASPHALT PAVEMENT

CRACK AT EXPANSION JOINT

0'-8" x 0'-6" SPALL

3'-10" x 1'-0" SPALL

BENT # 126

PLAN OF DECK SURFACE



ALPHA & OMEGA GROUP
CIVIL & STRUCTURAL ENGINEERS

4911 Green Road Suite 107 Raleigh, NC 27616
Phone 919 981 0310 Fax 919 981 0451
Email info@aogroup.com www.aogroup.com

BRIDGE NO: 270011

COUNTY: DARE

PREPARED BY: ACS CHECKED BY: TGZ

SCALE: NTS

DATE: 6/20/06 SHT 43 OF 1347

BENT #125

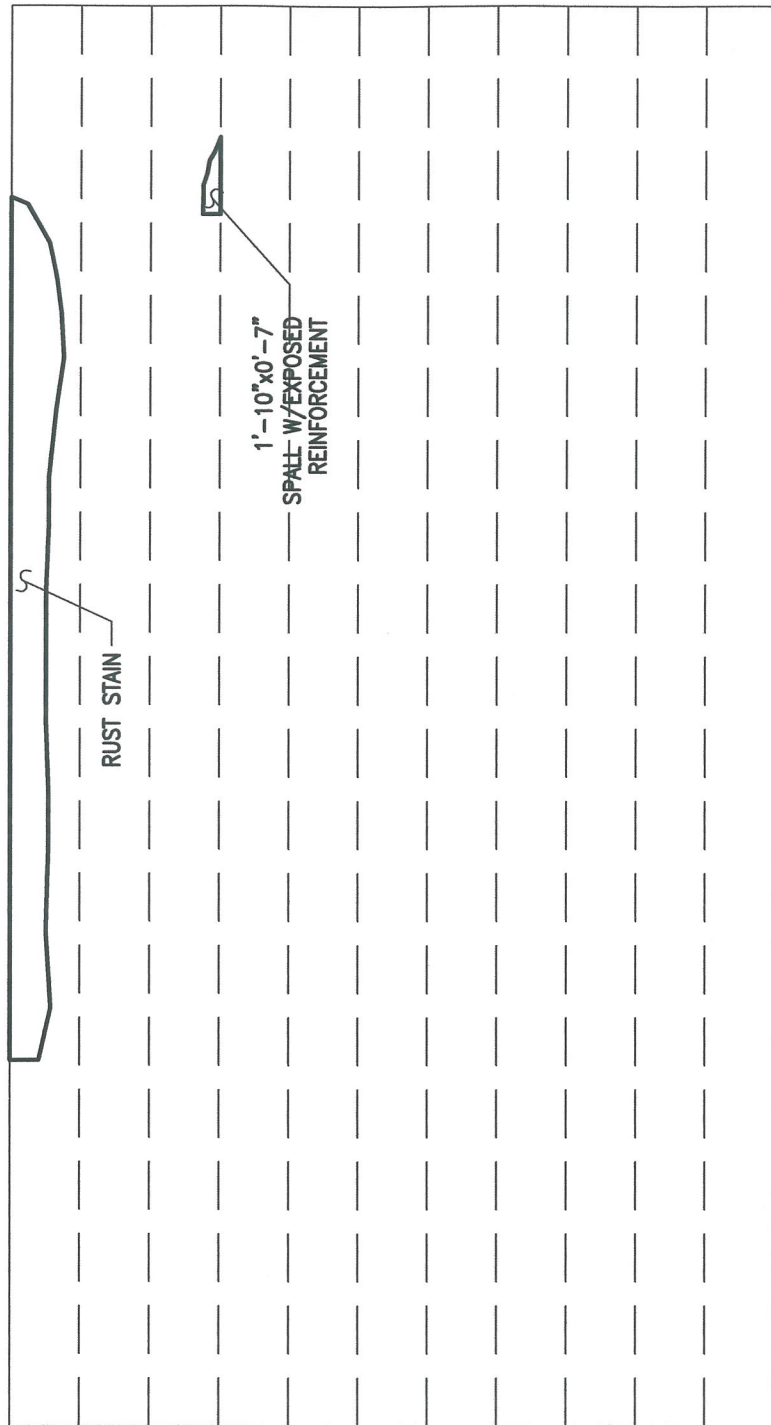

BENT #126

PLAN OF DECK UNDERSIDE-CORED SLAB



ALPHA & OMEGA GROUP
CIVIL & STRUCTURAL ENGINEERS

4911 Green Road Suite 107 Raleigh, NC 27616
Phone 919 981 0310 Fax 919 981 0451
Email info@aogroup.com www.aogroup.com

BRIDGE NO:	270011		
COUNTY:	DARE		
PREPARED BY:	OHS	CHECKED BY:	TGZ
SCALE:	NTS		
DATE:	6/20/06	SHT 644 OF 1347	

BENT # 126

CRACK IN ASPHALT
PAVEMENT

CRACK IN ASPHALT
PAVEMENT

2'-6"x0'-10" SPALL

CRACK AT
EXPANSION JOINT

3'-8"x0'-8" SPALL

BENT # 127

PLAN OF DECK SURFACE



ALPHA & OMEGA GROUP
CIVIL & STRUCTURAL ENGINEERS

4911 Green Road Suite 107 Raleigh, NC 27616
Phone 919 981 0310 Fax 919 981 0451
Email info@aogroup.com www.aogroup.com

BRIDGE NO:	270011		
COUNTY:	DARE		
PREPARED BY:	ACS	CHECKED BY:	TGZ
SCALE:	NTS		
DATE:	6/20/06	SHT	848 OF 1347

BENT #126

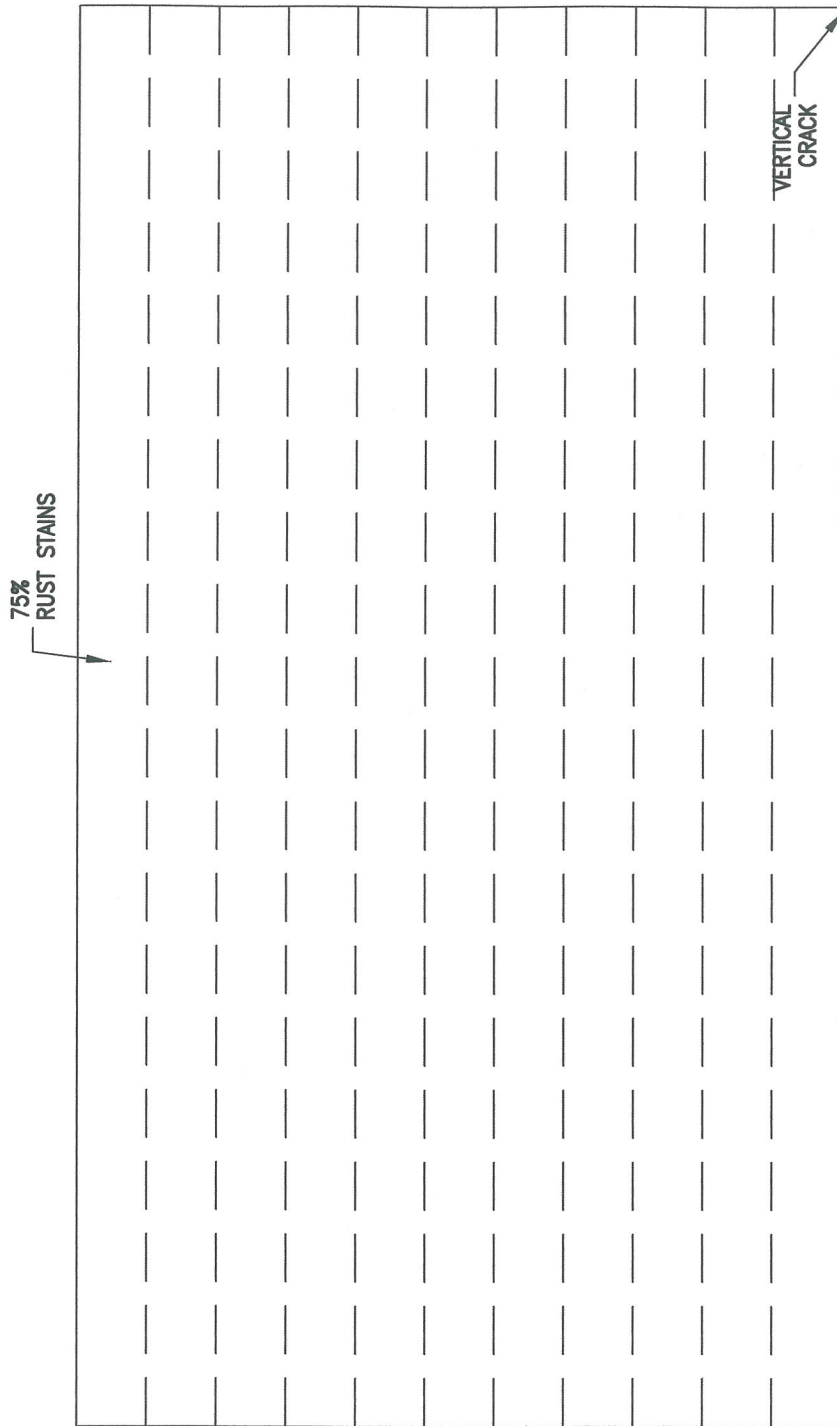

BENT #127

PLAN OF DECK UNDERSIDE-CORED SLAB



ALPHA & OMEGA GROUP
CIVIL & STRUCTURAL ENGINEERS

4911 Green Road Suite 107 Raleigh, NC 27616
Phone 919 981 0310 Fax 919 981 0451
Email info@aogroup.com www.aogroup.com

BRIDGE NO:	270011		
COUNTY:	DARE		
PREPARED BY:	OHS	CHECKED BY:	TGZ
SCALE:	NTS		
DATE:	6/20/06	SHT 449	OF 1347

BENT # 127

CRACK IN ASPHALT
PAVEMENT

CRACK IN ASPHALT
PAVEMENT

3'-6" x 1'-0" SPALL

CRACK AT
EXPANSION JOINT
3'-2" x 0'-9" SPALL

BENT # 128

PLAN OF DECK SURFACE



ALPHA & OMEGA GROUP
CIVIL & STRUCTURAL ENGINEERS

4911 Green Road Suite 107 Raleigh, NC 27616
Phone 919 981 0310 Fax 919 981 0451
Email info@aogroup.com www.aogroup.com

BRIDGE NO: 270011

COUNTY: DARE

PREPARED BY: ACS CHECKED BY: TGZ

SCALE: NTS

DATE: 6/20/06 SHT 654 OF 1347

BENT #127

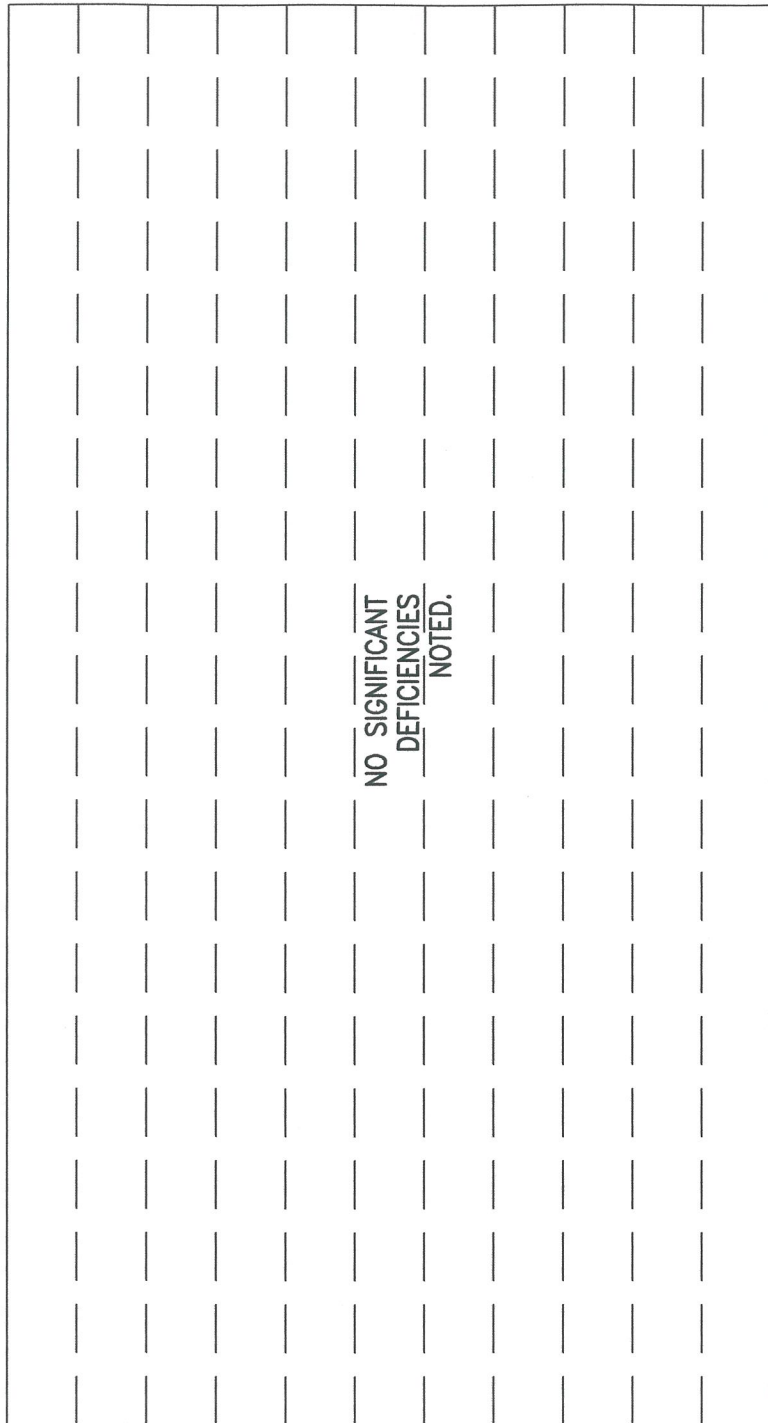

NO SIGNIFICANT
DEFICIENCIES
NOTED.

BENT #128

PLAN OF DECK UNDERSIDE-CORED SLAB



ALPHA & OMEGA GROUP
CIVIL & STRUCTURAL ENGINEERS

4911 Green Road Suite 107 Raleigh, NC 27616
Phone 919 981 0310 Fax 919 981 0451
Email info@aogroup.com www.aogroup.com

BRIDGE NO: 270011

COUNTY: DARE

PREPARED BY: OHS CHECKED BY: TGZ

SCALE: NTS

DATE: 6/20/06 SHT 855 OF 1347

BENT # 128

3'-6"x0'-11" SPALL

CRACK AT JOINT

2'-0"x0'-8" SPALL

CRACK IN ASPHALT
PAVEMENT

CRACK IN ASPHALT
PAVEMENT

BENT # 128A

PLAN OF DECK SURFACE



ALPHA & OMEGA GROUP
CIVIL & STRUCTURAL ENGINEERS

4911 Green Road Suite 107 Raleigh, NC 27616
Phone 919 981 0310 Fax 919 981 0451
Email info@aogroup.com www.aogroup.com

BRIDGE NO: 270011

COUNTY: DARE

PREPARED BY: ACS CHECKED BY: TGZ

SCALE: NTS

DATE: 6/20/06 SHT 69 OF 1347

BENT #128

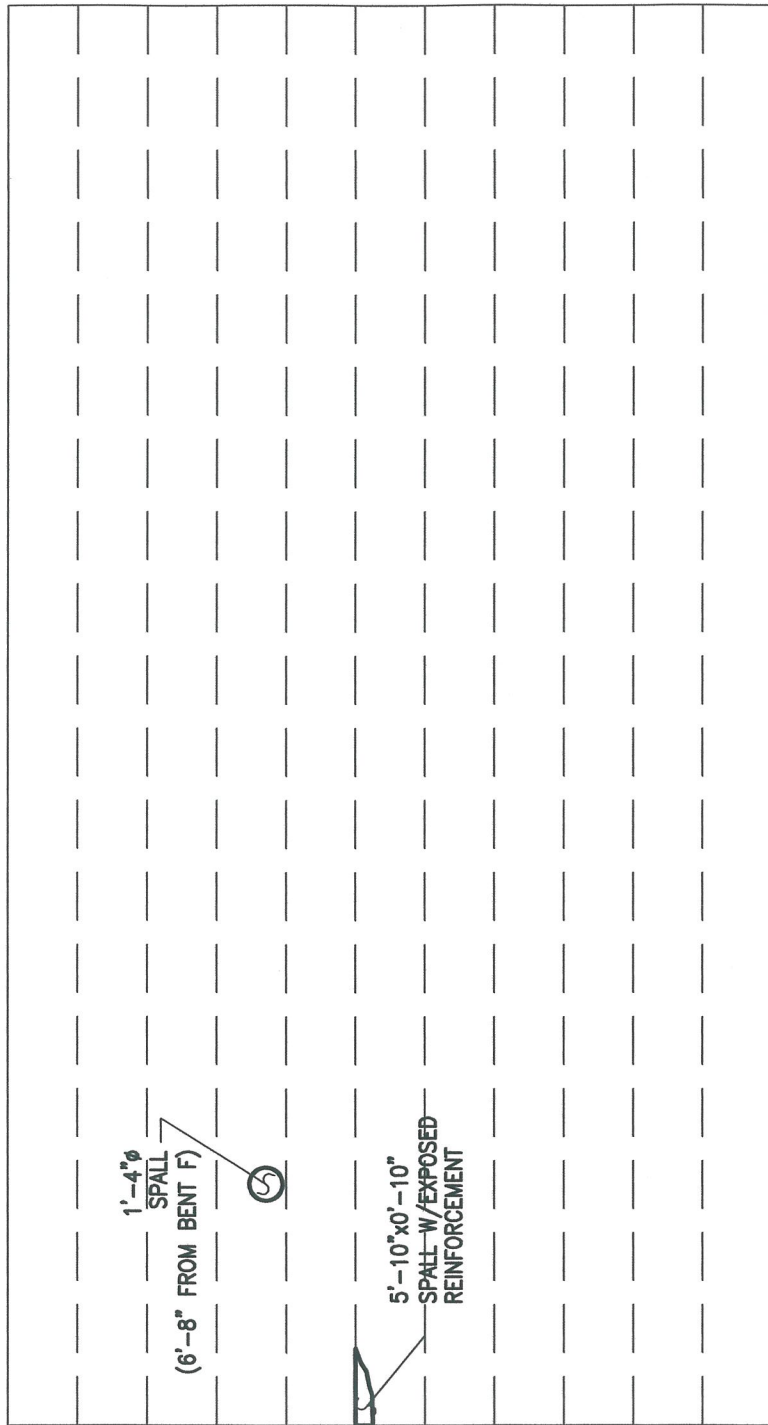

BENT #128A

PLAN OF DECK UNDERSIDE-CORED SLAB



ALPHA & OMEGA GROUP
CIVIL & STRUCTURAL ENGINEERS

4911 Green Road Suite 107 Raleigh, NC 27616
Phone 919 981 0310 Fax 919 981 0451
Email info@aogroup.com www.aogroup.com

BRIDGE NO:	270011		
COUNTY:	DARE		
PREPARED BY:	OHS	CHECKED BY:	TGZ
SCALE:	NTS		
DATE:	6/20/06	SHT	660 OF 1347

BENT # 128A

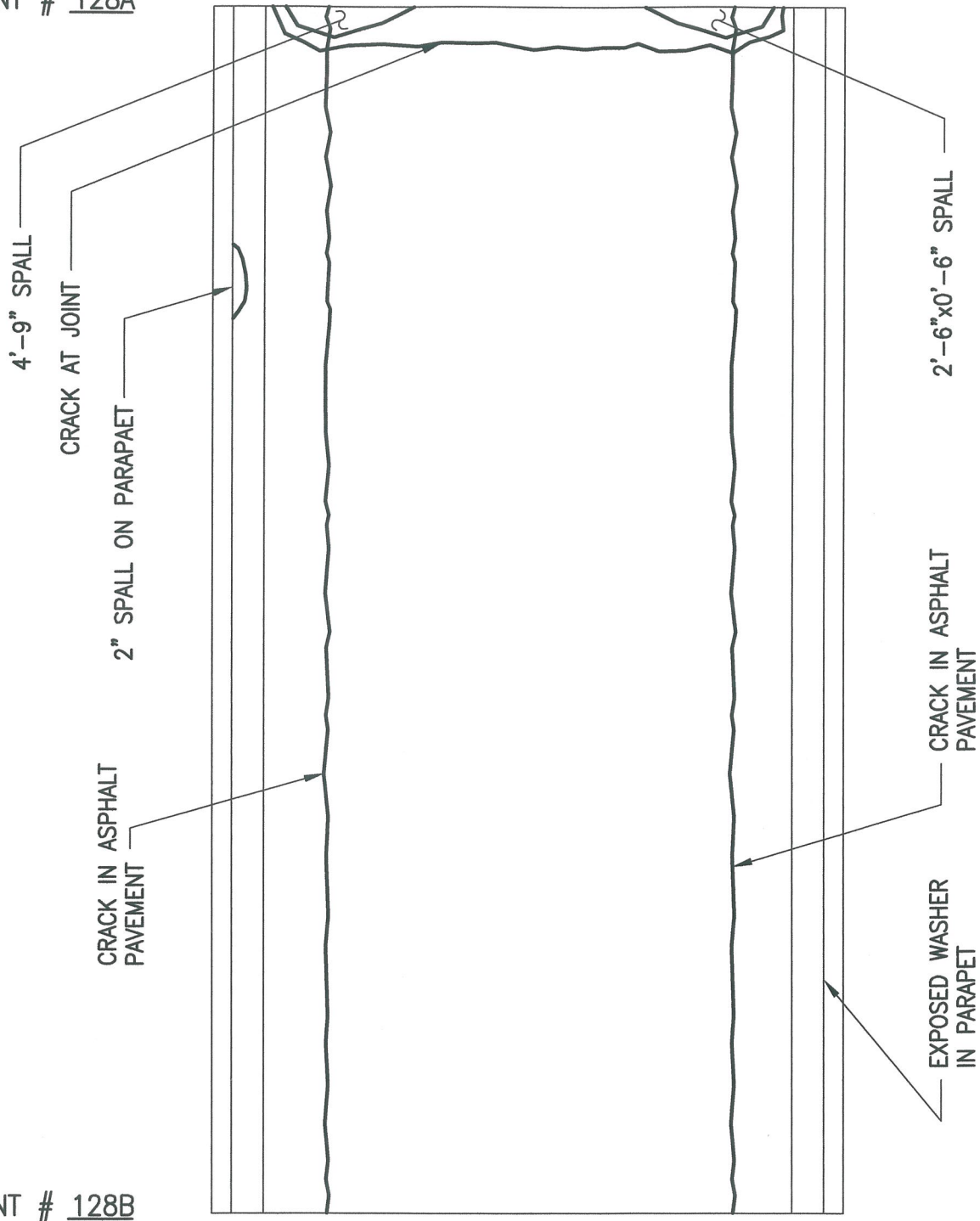

BENT # 128B

PLAN OF DECK SURFACE



ALPHA & OMEGA GROUP
CIVIL & STRUCTURAL ENGINEERS

4911 Green Road Suite 107 Raleigh, NC 27616
Phone 919 981 0310 Fax 919 981 0451
Email info@aogroup.com www.aogroup.com

BRIDGE NO:	270011		
COUNTY:	DARE		
PREPARED BY:	ACS	CHECKED BY:	TGZ
SCALE:	NTS		
DATE:	6/20/06	SHT	864 OF 1347

BENT #128A

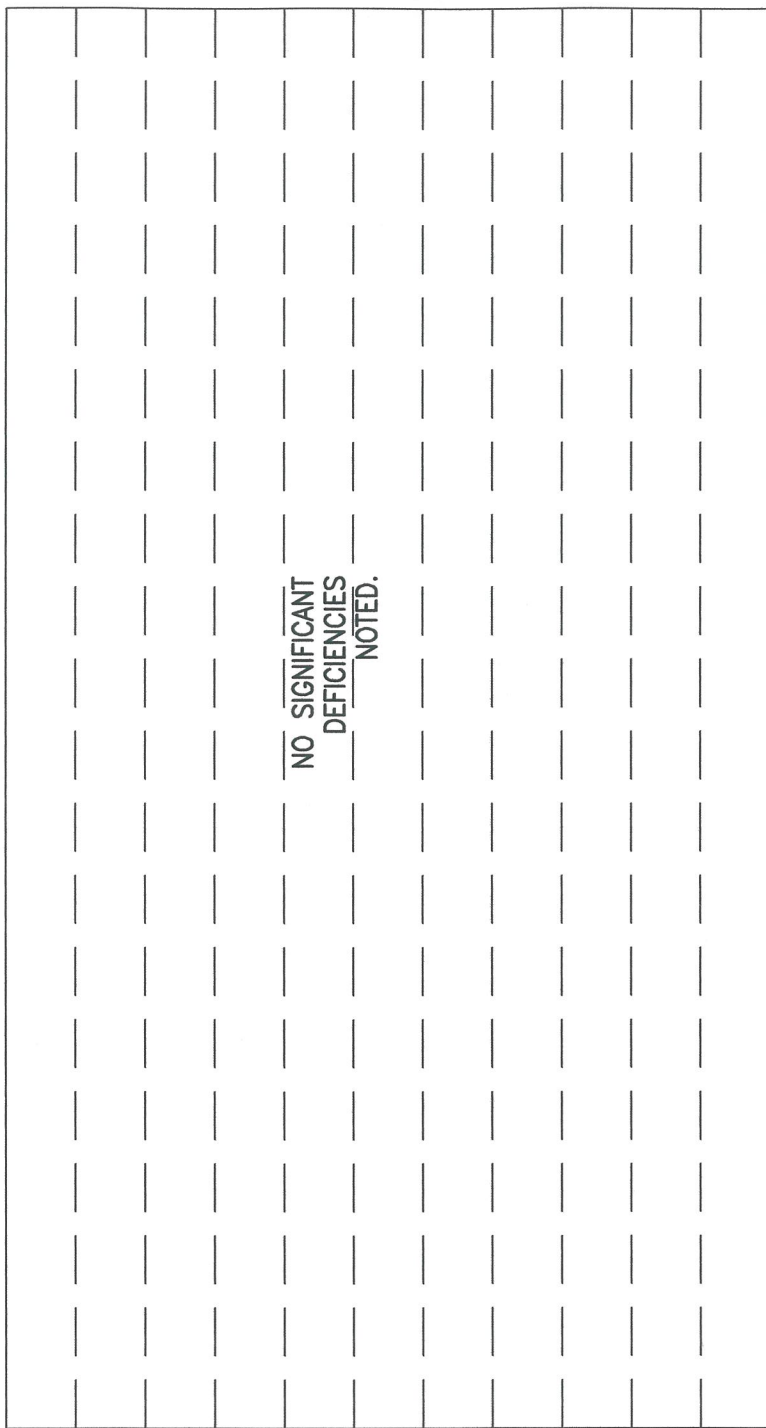

NO SIGNIFICANT
DEFICIENCIES
NOTED.

BENT #128B

PLAN OF DECK UNDERSIDE--CORED SLAB



ALPHA & OMEGA GROUP
CIVIL & STRUCTURAL ENGINEERS

4911 Green Road Suite 107 Raleigh, NC 27616
Phone 919 981 0310 Fax 919 981 0451
Email info@aogroup.com www.aogroup.com

BRIDGE NO: 270011

COUNTY: DARE

PREPARED BY: OHS CHECKED BY: TGZ

SCALE: NTS

DATE: 6/20/06 SHT 86 OF 1347

BENT # 128B

CRACK AT JOINT

0'-6" SPALL

CRACK IN ASPHALT PAVEMENT

6'-0" SPALL

4'-0" SPALL

4'-6" SPALL

CRACK IN ASPHALT PAVEMENT

4'-10" SPALL

BENT # 129

PLAN OF DECK SURFACE



ALPHA & OMEGA GROUP
CIVIL & STRUCTURAL ENGINEERS

4911 Green Road Suite 107 Raleigh, NC 27616
Phone 919 981 0310 Fax 919 981 0451
Email info@aogroup.com www.aogroup.com

BRIDGE NO: 270011

COUNTY: DARE

PREPARED BY: ACS CHECKED BY: TGZ

SCALE: NTS

DATE: 6/20/06 SHT 669 OF 1347

BENT #128B

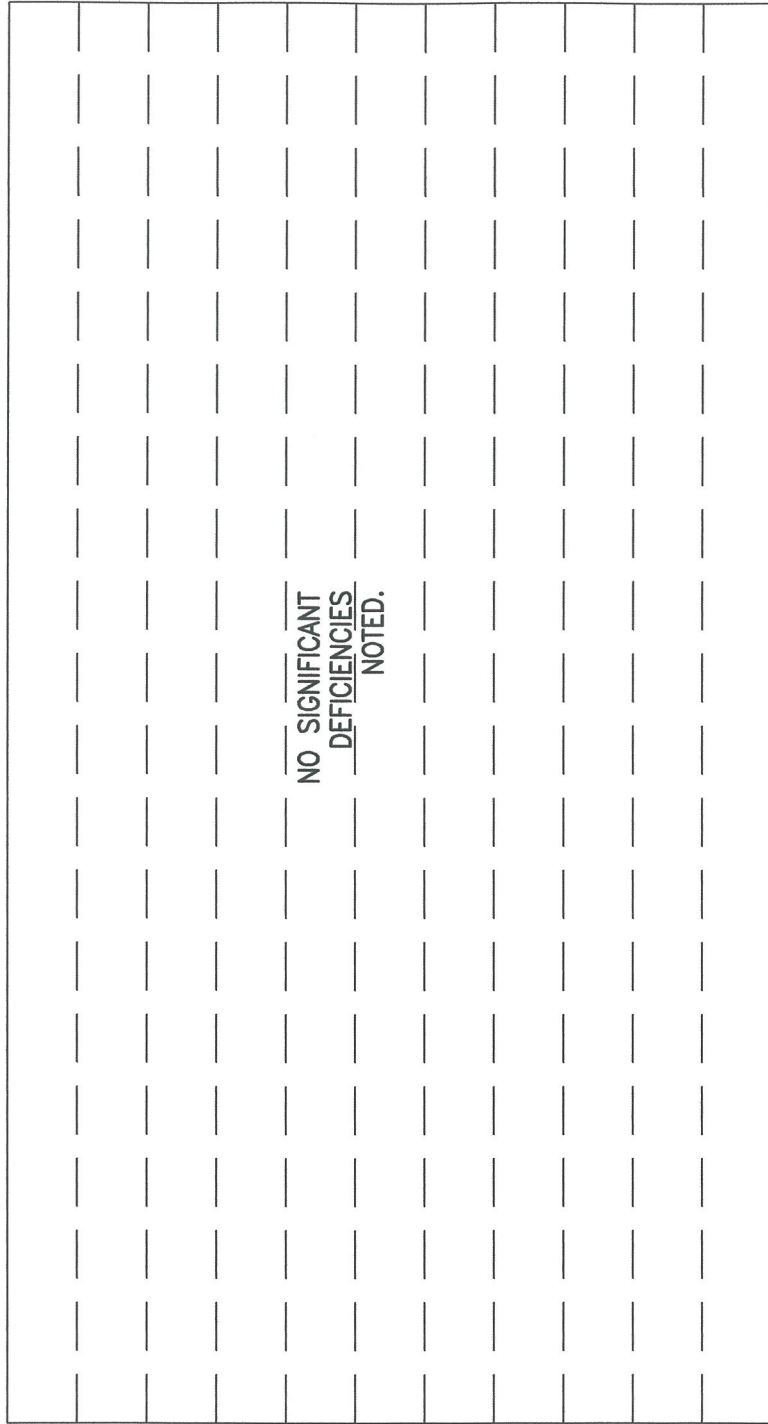

BENT #129

PLAN OF DECK UNDERSIDE—CORED SLAB



ALPHA & OMEGA GROUP
CIVIL & STRUCTURAL ENGINEERS

4911 Green Road Suite 107 Raleigh, NC 27616
Phone 919 981 0310 Fax 919 981 0451
Email info@aogroup.com www.aogroup.com

BRIDGE NO:	270011	
COUNTY:	DARE	
PREPARED BY:	OHS	CHECKED BY: TGZ
SCALE:	NTS	
DATE:	6/26/06	SHT 870 OF 1347