

TIP PROJECT: B-0682

CONTRACT: C201616

STATE OF NORTH CAROLINA
DIVISION OF HIGHWAYS

T.I.P. NO.	SHEET NO.
B-0682	UC-1

UTILITY CONSTRUCTION PLANS BRUNSWICK COUNTY

**LOCATION: BRIDGE No. 198 OVER THE INTERCOASTAL WATERWAY
AND APPROACHES ON SR 1172 AT SUNSET BEACH**

TYPE OF WORK: UTILITIES RELOCATION

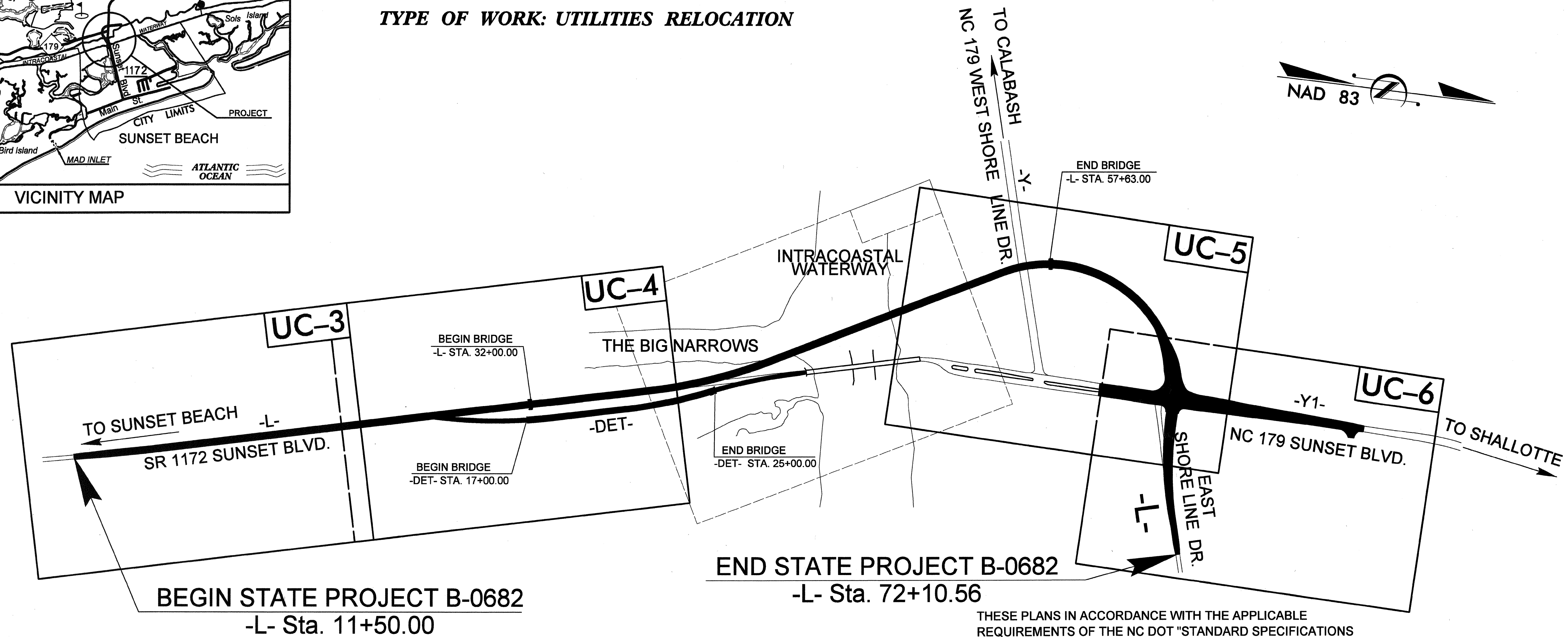
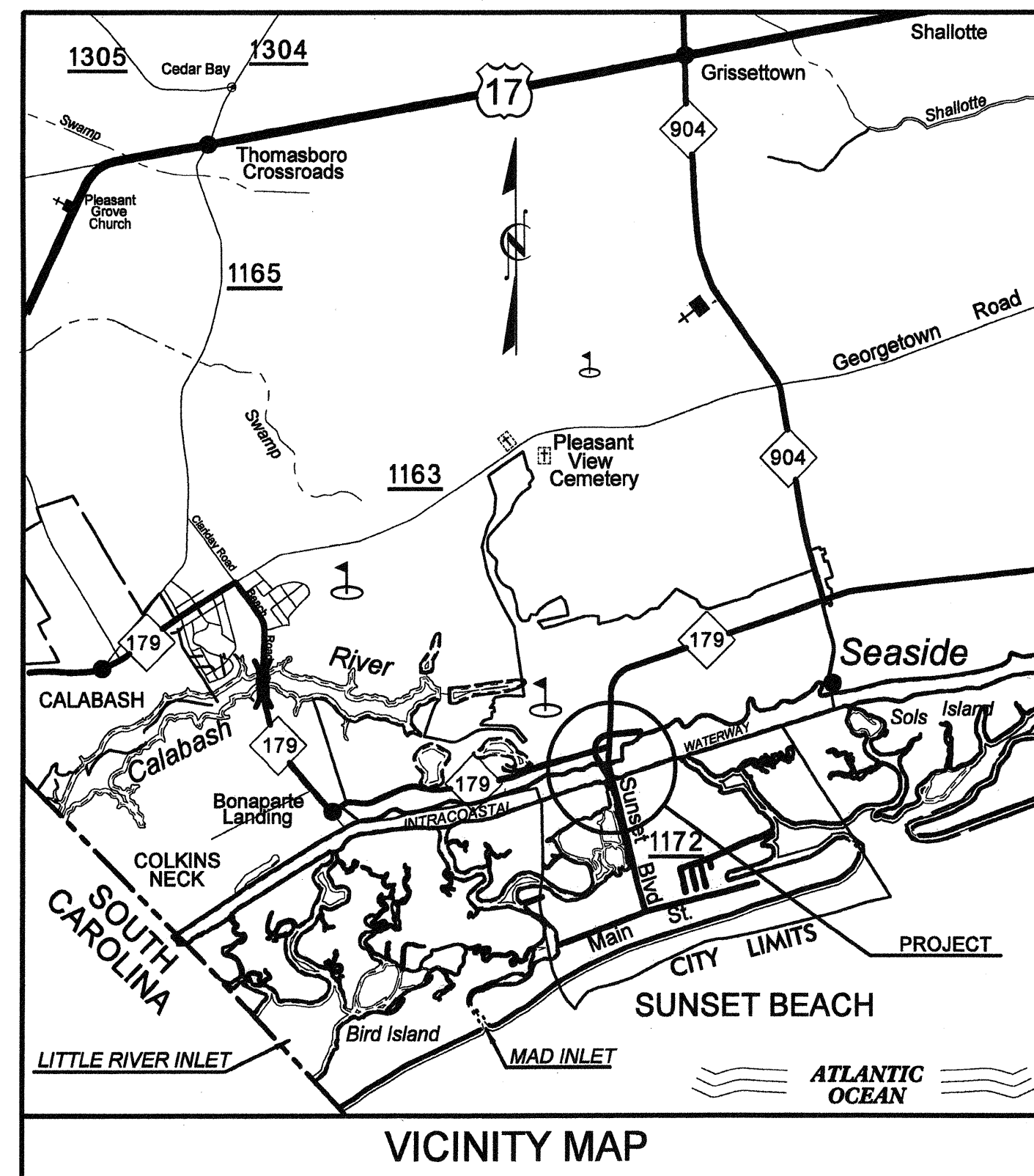

THESE PLANS IN ACCORDANCE WITH THE APPLICABLE REQUIREMENTS OF THE NC DOT "STANDARD SPECIFICATIONS FOR ROADS AND STRUCTURES" DATED JULY 2006. THIS PROJECT IS WITHIN THE LIMITS OF SUNSET BEACH

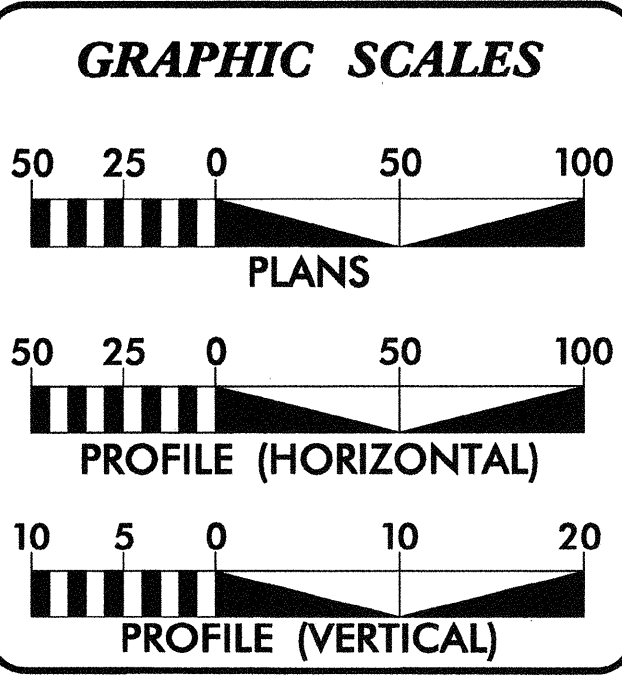

INDEX OF SHEETS

SHEET NO.	DESCRIPTION
UC-1	TITLE SHEET
UC-3 thru UC-6	UTILITY CONSTRUCTION PLAN SHEET(S)
UC-7 thru UC-8	PROFILE SHEET(S)
UC-9	DETAIL SHEET(S)

WATER AND SEWER OWNERS ON PROJECT

(1) TOWN OF SUNSET BEACH (WATER)

EarthTech
A Tyco International Ltd. Company
701 Corporate Center Drive, Suite 475
Raleigh, NC 27607
(919) 854-6200 - (919) 854-6259 (FAX)

FOR:
DIVISION OF HIGHWAYS
PROJECT SERVICES
UTILITY SECTION

1591 MAIL SERVICES CENTER
RALEIGH NC 27699-1591
PHONE (919) 250-4128
FAX (919) 250-4119

Roger Worthington, P.E. UTILITIES SECTION ENGINEER
James S. McKee, P.E. UTILITIES SQUAD LEADER PROJECT ENGINEER
Earth Tech UTILITIES PROJECT DESIGNER

USER: 9076w/misen
DATE: 5/21/2007
TIME: 2:56:30 PM
DGN: 10682.dwg

Note: Not to Scale

*S.U.E. = Subsurface Utility Engineering











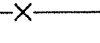

STATE OF NORTH CAROLINA
DIVISION OF HIGHWAYS

CONVENTIONAL PLAN SHEET SYMBOLS











PROJECT REFERENCE NO. B-0682	SHEET NO. UC-02

UTILITY CONSTRUCTION

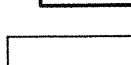
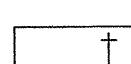

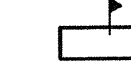

BOUNDARIES AND PROPERTY:

State Line	_____
County Line	_____
Township Line	_____
City Line	_____
Reservation Line	_____
Property Line	_____
Existing Iron Pin	_____ 
Property Corner	_____ 
Property Monument	_____ 
Parcel/Sequence Number	_____ 
Existing Fence Line	_____ 
Proposed Woven Wire Fence	_____ 
Proposed Chain Link Fence	_____ 
Proposed Barbed Wire Fence	_____ 
Existing Wetland Boundary	_____ 
Proposed Wetland Boundary	_____ 
Existing High Quality Wetland Boundary	_____ 
Existing Endangered Animal Boundary	_____ 
Existing Endangered Plant Boundary	_____ 



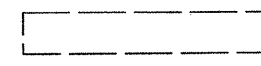
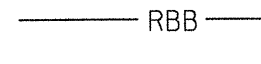
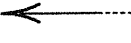
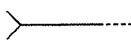

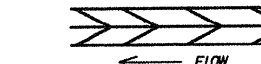
BUILDINGS AND OTHER CULTURE:

Gas Pump Vent or UG Tank Cap	_____ 
Sign	_____ 
Well	_____ 
Small Mine	_____ 
Foundation	_____ 
Area Outline	_____ 
Cemetery	_____ 
Building	_____ 
School	_____ 
Church	_____ 
Dam	_____ 





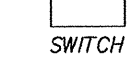
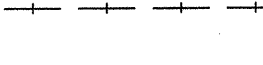







HYDROLOGY:

Stream or Body of Water	_____
Hydro, Pool or Reservoir	_____ 
River Basin Buffer	_____ 
Flow Arrow	_____ 
Disappearing Stream	_____ 
Spring	_____ 
Swamp Marsh	_____ 
Proposed Lateral, Tail, Head Ditch	_____ 
False Sump	_____ 







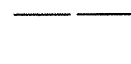

RAILROADS:

Standard Gauge	_____ 
RR Signal Milepost	_____ 
Switch	_____ 
RR Abandoned	_____ 
RR Dismantled	_____ 





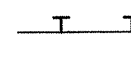
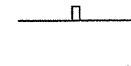
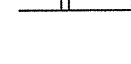
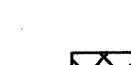

RIGHT OF WAY:

Baseline Control Point	_____ 
Existing Right of Way Marker	_____ 
Existing Right of Way Line	_____ 
Proposed Right of Way Line	_____ 
Proposed Right of Way Line with Iron Pin and Cap Marker	_____ 
Proposed Right of Way Line with Concrete or Granite Marker	_____ 
Existing Control of Access	_____ 
Proposed Control of Access	_____ 
Existing Easement Line	_____ 
Proposed Temporary Construction Easement	_____ 
Proposed Temporary Drainage Easement	_____ 
Proposed Permanent Drainage Easement	_____ 
Proposed Permanent Utility Easement	_____ 



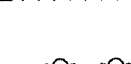

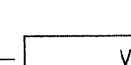
ROADS AND RELATED FEATURES:

Existing Edge of Pavement	_____ 
Existing Curb	_____ 
Proposed Slope Stakes Cut	_____ 
Proposed Slope Stakes Fill	_____ 
Proposed Wheel Chair Ramp	_____ 
Curb Cut for Future Wheel Chair Ramp	_____ 
Existing Metal Guardrail	_____ 
Proposed Guardrail	_____ 
Existing Cable Guiderail	_____ 
Proposed Cable Guiderail	_____ 
Equality Symbol	_____ 
Pavement Removal	_____ 



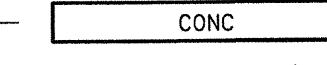
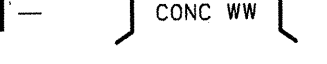
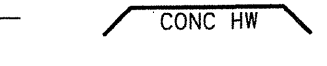
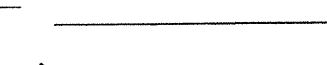
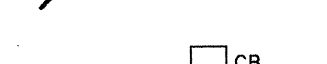

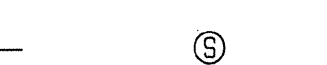
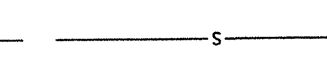





VEGETATION:

Single Tree	_____ 
Single Shrub	_____ 
Hedge	_____ 
Woods Line	_____ 
Orchard	_____ 
Vineyard	_____ 





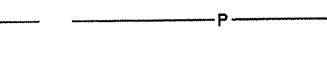
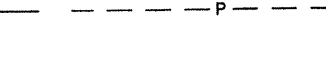





EXISTING STRUCTURES:

MAJOR:	
Bridge, Tunnel or Box Culvert	_____ 
Bridge Wing Wall, Head Wall and End Wall	_____ 
MINOR:	
Head and End Wall	_____ 
Pipe Culvert	_____ 
Footbridge	_____ 
Drainage Box: Catch Basin, DI or JB	_____ 
Paved Ditch Gutter	_____ 
Storm Sewer Manhole	_____ 
Storm Sewer	_____ 



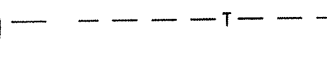
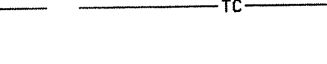



UTILITIES:

POWER:	
Existing Power Pole	_____ 
Proposed Power Pole	_____ 
Existing Joint Use Pole	_____ 
Proposed Joint Use Pole	_____ 
Power Manhole	_____ 
Power Line Tower	_____ 
Power Transformer	_____ 
UG Power Cable Hand Hole	_____ 
H-Frame Pole	_____ 
Recorded UG Power Line	_____ 
Designated UG Power Line (S.U.E.*)	_____ 

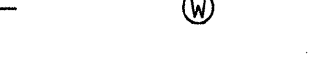

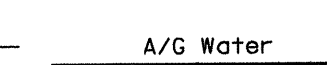

TELEPHONE:

Existing Telephone Pole	_____ 
Proposed Telephone Pole	_____ 
Telephone Manhole	_____ 
Telephone Booth	_____ 
Telephone Pedestal	_____ 
Telephone Cell Tower	_____ 
UG Telephone Cable Hand Hole	_____ 
Recorded UG Telephone Cable	_____ 
Designated UG Telephone Cable (S.U.E.*)	_____ 
Recorded UG Telephone Conduit	_____ 
Designated UG Telephone Conduit (S.U.E.*)	_____ 
Recorded UG Fiber Optics Cable	_____ 
Designated UG Fiber Optics Cable (S.U.E.*)	_____ 



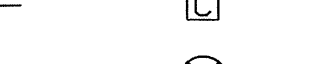
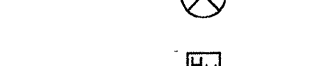

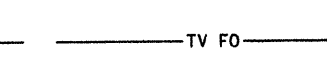
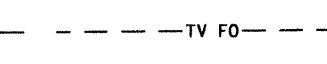
WATER:

Water Manhole	_____ 
Water Meter	_____ 
Water Valve	_____ 
Water Hydrant	_____ 
Recorded UG Water Line	_____ 
Designated UG Water Line (S.U.E.*)	_____ 
Above Ground Water Line	_____ 





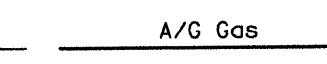

TV:

TV Satellite Dish	_____ 
TV Pedestal	_____ 
TV Tower	_____ 
UG TV Cable Hand Hole	_____ 
Recorded UG TV Cable	_____ 
Designated UG TV Cable (S.U.E.*)	_____ 
Recorded UG Fiber Optic Cable	_____ 
Designated UG Fiber Optic Cable (S.U.E.*)	_____ 











GAS:

Gas Valve	_____ 
Gas Meter	_____ 
Recorded UG Gas Line	_____ 
Designated UG Gas Line (S.U.E.*)	_____ 
Above Ground Gas Line	_____ 

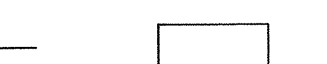
SANITARY SEWER:

Sanitary Sewer Manhole	_____ 
Sanitary Sewer Cleanout	_____ 
UG Sanitary Sewer Line	_____ 
Above Ground Sanitary Sewer	_____ 
Recorded SS Forced Main Line	_____ 
Designated SS Forced Main Line (S.U.E.*)	_____ 

MISCELLANEOUS:

Utility Pole	_____ 
Utility Pole with Base	_____ 
Utility Located Object	_____ 
Utility Traffic Signal Box	_____ 
Utility Unknown UG Line	_____ 
UG Tank; Water, Gas, Oil	_____ 
A/G Tank; Water, Gas, Oil	_____ 
UG Test Hole (S.U.E.*)	_____ 
Abandoned According to Utility Records	_____ 
End of Information	_____ 

ALL WATER LINES
OWNED BY THE TOWN
OF SUNSET BEACH

PROJECT REFERENCE NO. B-0682	SHEET NO. UC-03
SCALE: 25 0 50	
LARRY W. MITCHELL ENGINEER SEAL 023965	

UTILITY CONSTRUCTION

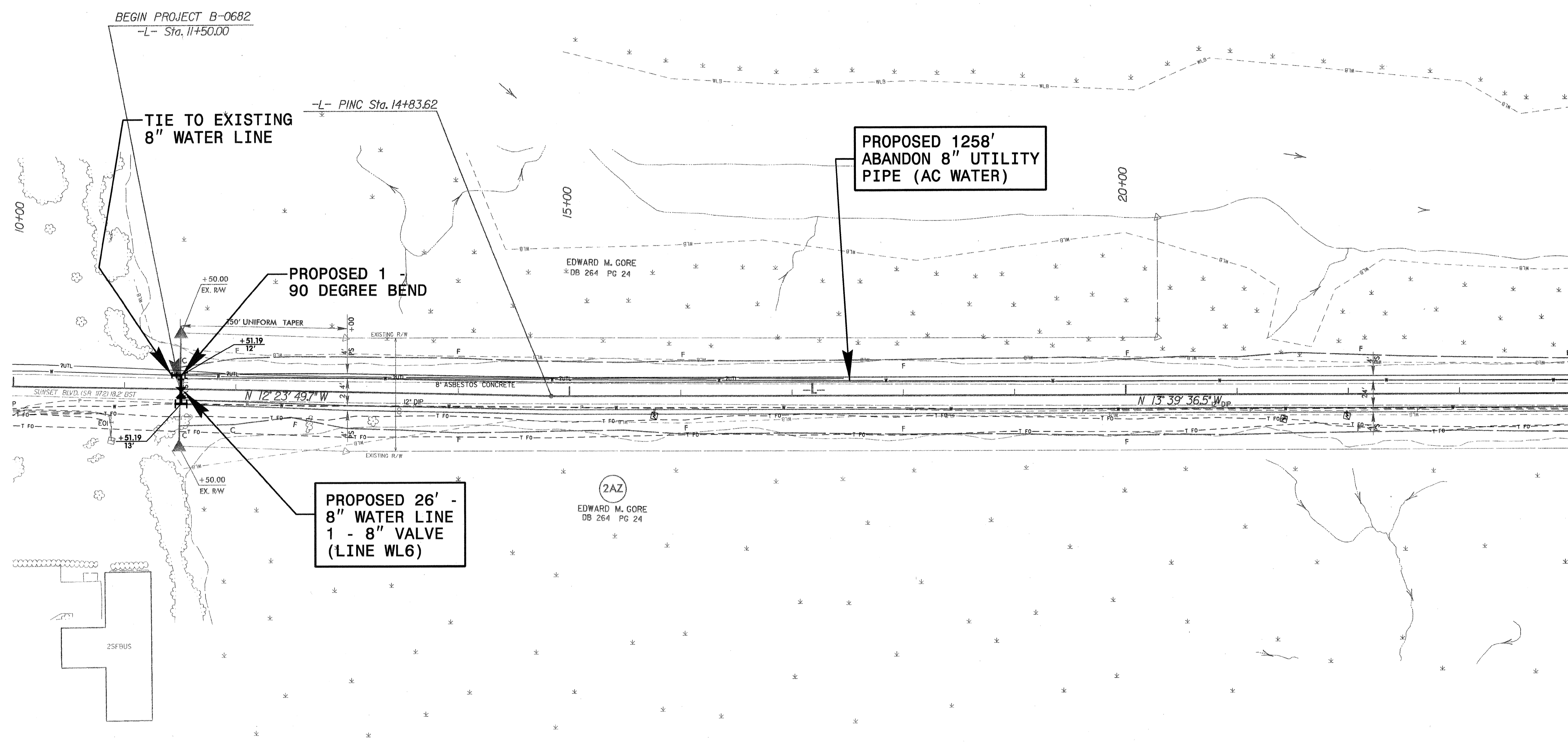
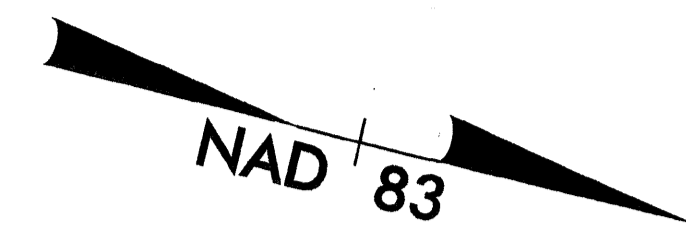

MATCHLINE -L- STA 24+00 SEE SHEET UC-04

USER: garyj/mason
DATE: 5/23/2007
TIME: 2:47:48 PM
DWG: D0682_UC03.dwg

Prepared by:

A Tyco International Ltd. Company
701 Corporate Center Drive, Suite 475
Raleigh, NC 27607
(919) 854-6200 - (919) 854-6259(fax)

ALL WATER LINES
OWNED BY THE TOWN
OF SUNSET BEACH

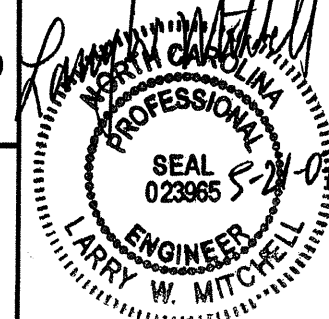
PROJECT REFERENCE NO. B-0682	SHEET NO. UC-04
SCALE: 25 0 50	
	

UTILITY CONSTRUCTION

-L-
PI Sta 40+10.40
= 14° 00' 31.7" (LT)
D = 2° 30' 00.0"
L = 560.35'
T = 281.58'
R = 2,291.83'
SE = 03

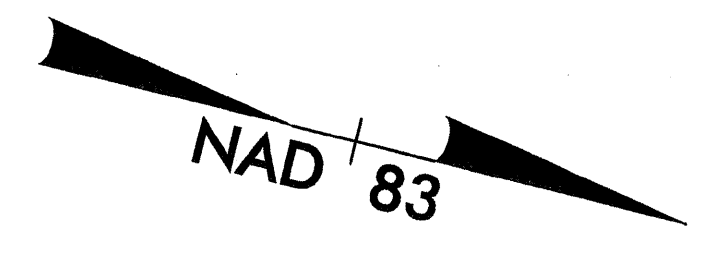

MATCHLINE -L- STA 24+00 SEE SHEET UC-03

MATCHLINE -L- STA 38+00

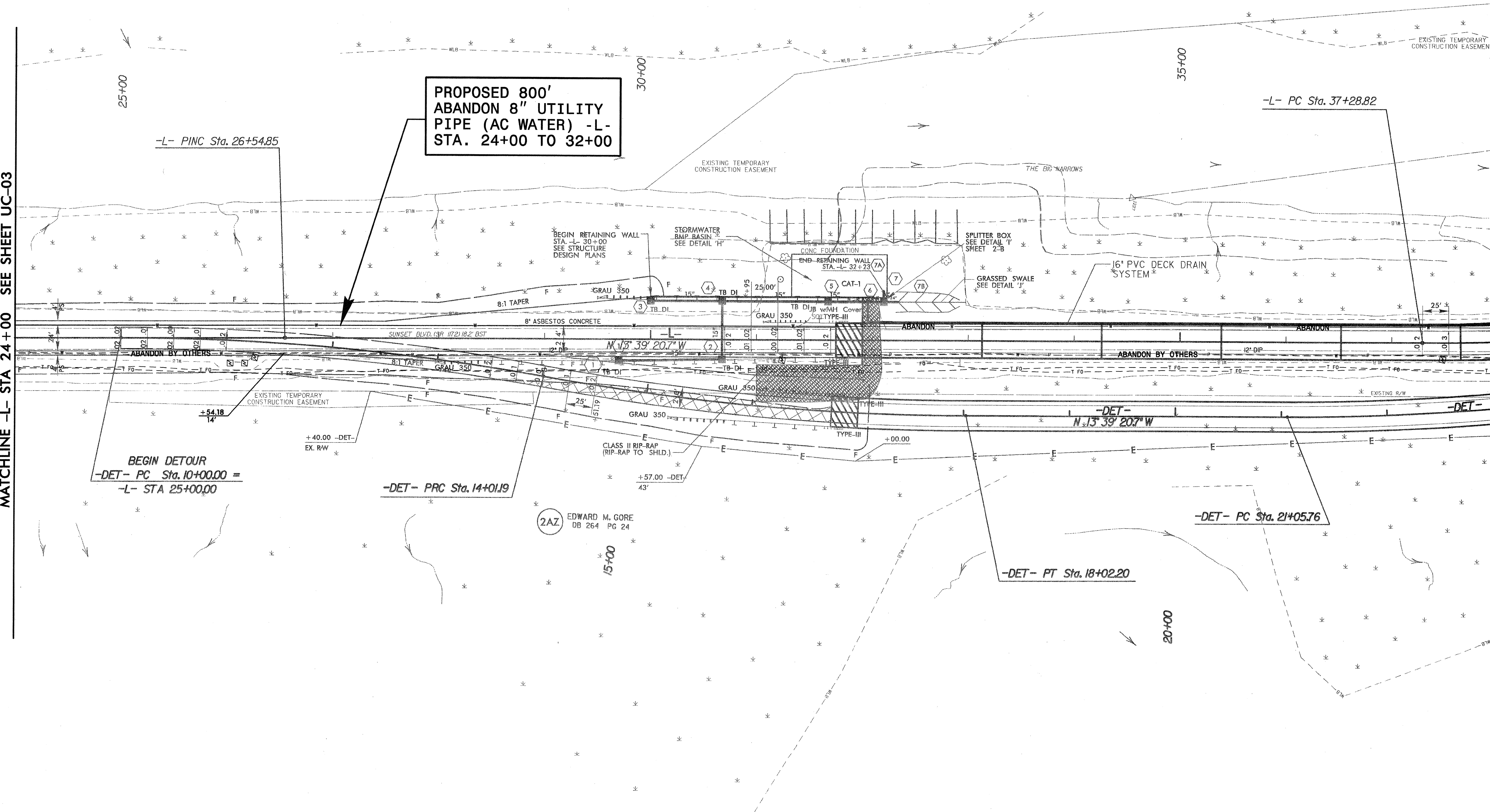

**PROPOSED 800'
ABANDON 8" UTILITY
PIPE (AC WATER) -L-
STA. 24+00 TO 32+00**

BEGIN DETOUR
-DET- PC Sta. 10+00.00 =
-L- STA 25+00.00

-DET- PRC Sta. 14+01.19

-DET- PC Sta. 21+05.76

-DET- PT Sta. 18+02.20

2AZ EDWARD M. GORE
DB 264 PG 24

USER: gmy/swinson
DATE: 5/29/2007
TIME: 2:00:09 PM
JOB: 000222.uc04.dgn

Prepared by:

 A Tyco International Ltd. Company
 701 Corporate Center Drive, Suite 475
 Raleigh, NC 27607
 (919) 854-6200 - (919) 854-6259(fax)

ALL WATER LINES
OWNED BY THE TOWN
OF SUNSET BEACH

PROJECT REFERENCE NO. B-0682	SHEET NO. UC-05
SCALE: 0 25 50	

UTILITY CONSTRUCTION

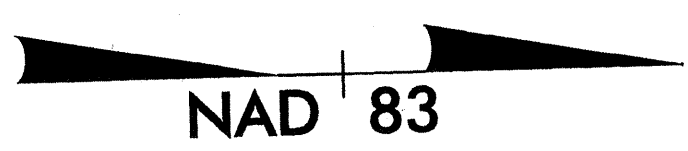
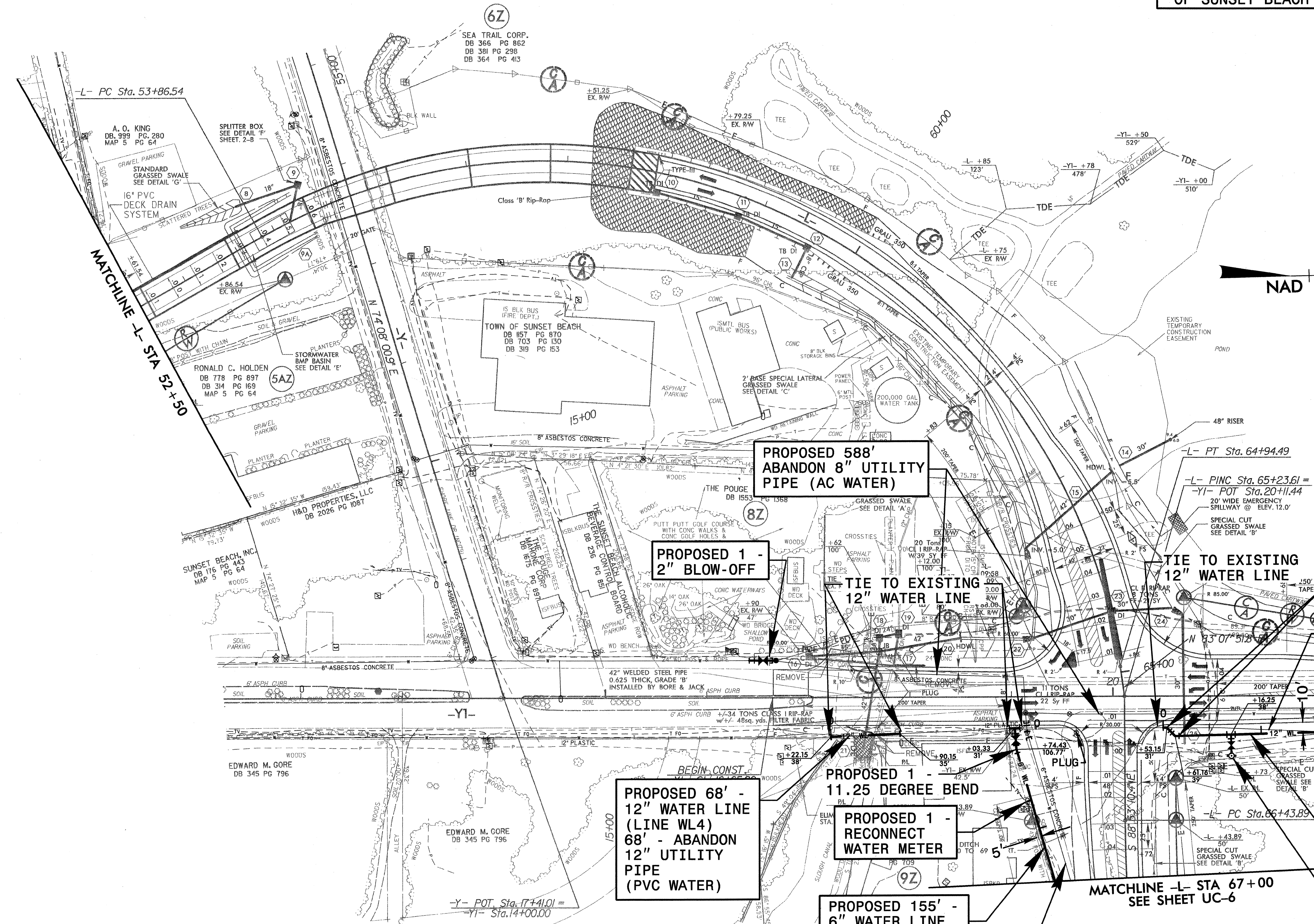

PROPOSED 588'
ABANDON 8" UTILITY
PIPE (AC WATER)

PROPOSED 1 -
2" BLOW-OFF

TIE TO EXISTING
12" WATER LINE

TIE TO EXISTING
12" WATER LINE

PROPOSED 2 -
45 DEGREE BENDS

PROPOSED 148'
ABANDON 12" UTILITY
PIPE (PVC WATER)

PROPOSED 68' -
12" WATER LINE
(LINE WL4)
68' - ABANDON
12" UTILITY
PIPE
(PVC WATER)

PROPOSED 1 -
11.25 DEGREE BEND
PROPOSED 1 -
RECONNECT
WATER METER

PROPOSED 150' -
12" WATER LINE
(LINE WL5)

PROPOSED
1 - RELOCATE FIRE
HYDRANT (FROM -Y1-
STA. 19+64, 38' RT.)

PROPOSED 155' -
6" WATER LINE
1 - 6" VALVE
(LINE WL3)

PROPOSED 155'
ABANDON 6" UTILITY
PIPE (AC WATER)

Prepared by:

A Tyco International Ltd. Company
701 Corporate Center Drive, Suite 475
Raleigh, NC 27607
(919) 854-6200 - (919) 854-6259(fax)

11/25/09 10:57 AM
 DATE: 11/25/09
 TIME: 10:57 AM
 DSN: 000000000000

ALL WATER LINES OWNED BY THE TOWN OF SUNSET BEACH

PROJECT REFERENCE NO. B-0682	SHEET NO. UC-06
SCALE: 25 0 50	
UTILITY CONSTRUCTION	

NAD 83

SEA TRAIL CORP.
DB 366 PG 862
DB 381 PG 298
DB 364 PG 413

PROPOSED 645' - 12" WATER LINE
1 - 12" VALVE
(LINE WL5)

PROPOSED 655' ABANDON 8" UTILITY PIPE (AC WATER)

PROPOSED 54' ABANDON 6" UTILITY PIPE (AC WATER)

PROPOSED 18' - 8" WATER LINE
1 - 8" VALVE

TIE TO EXISTING 8" WATER LINE

TIE TO EXISTING 12" WATER LINE
POT Sta. 30+76.03

PROPOSED 640' ABANDON 12" UTILITY PIPE (PVC WATER)

PROPOSED 48' - 6" WATER LINE
1 - 6" VALVE

PROPOSED 10' - 12" WATER LINE
1 - 12" VALVE

TIE TO EXISTING 6" WATER LINE

MATCHLINE -L- STA 67+00 SEE SHEET UC-5

CAROLINA DREAM GOLF, L.L.C.
DB 1532 PG 1379

PROPOSED 528' - 6" WATER LINE
1 - 6" VALVE
(LINE WL3)

PROPOSED 545' ABANDON 6" UTILITY PIPE (AC WATER)

PROPOSED 8' - 6" WATER LINE
1 - 6" VALVE

PROPOSED 1 - 8" VALVE

PROPOSED 1 - 8" x 45 DEGREE BEND

PROPOSED 1 - 12" x 8" REDUCER

TIE TO EXISTING 8" WATER LINE

PROPOSED 1 - 12" x 12" TEE

PROPOSED 1 - 12" VALVE

PROPOSED 2 - 22 1/2 DEGREE BENDS

TIE TO EXISTING 12" WATER LINE

TIE TO EXISTING 6" WATER LINE

PROPOSED 2 - 12" x 45 DEGREE BENDS

Prepared by:

EarthTech
A Tyco International Ltd. Company
701 Corporate Center Drive, Suite 475
Raleigh, NC 27607
(919) 854-6200 - (919) 854-6259(fax)

USER: gpy/whs
DATE: 5/21/2007
TIME: 15:52:57 PM
DGN: B0682_UC06.dgn

UTILITY CONSTRUCTION

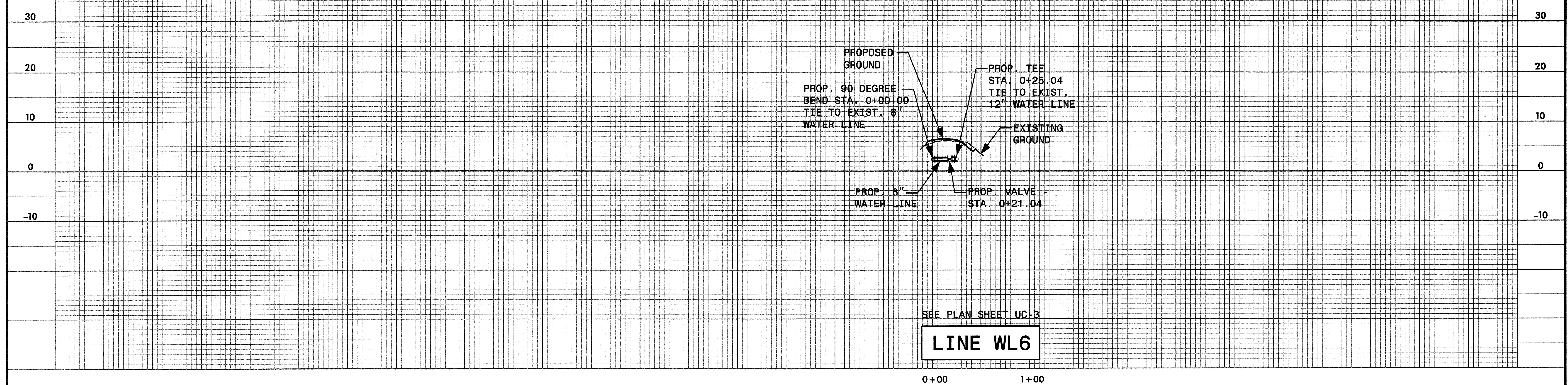

SEE PLAN SHEET UC-3

LINE WL6

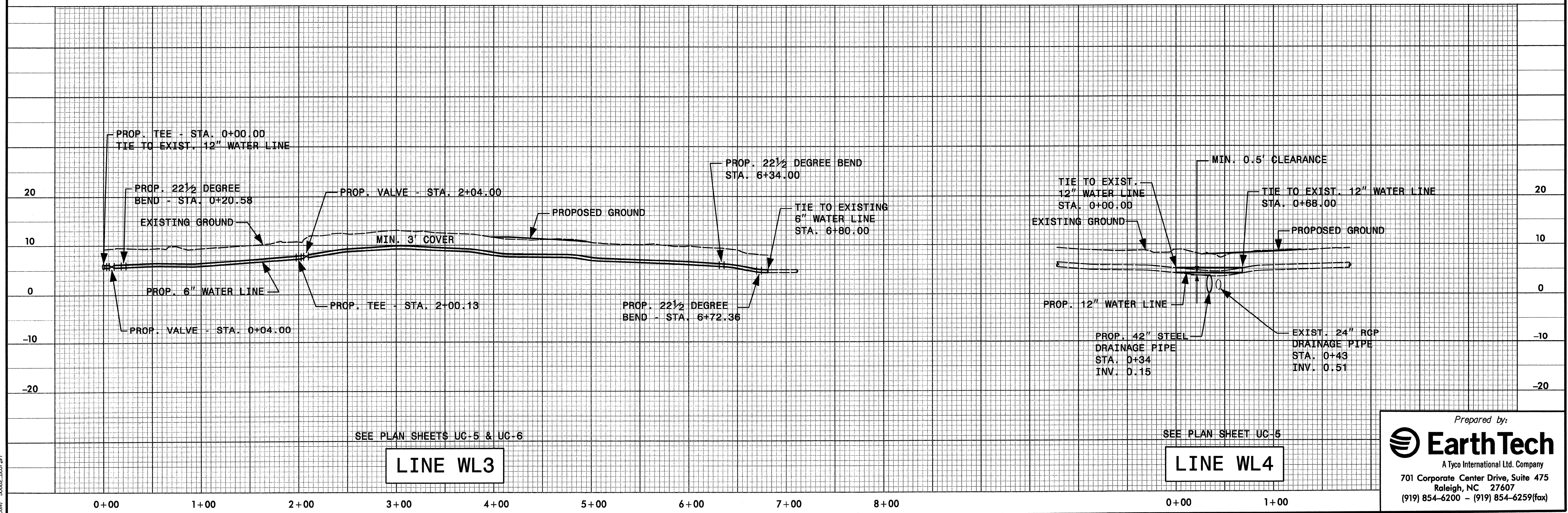

SEE PLAN SHEETS UC-5 & UC-6

LINE WL3

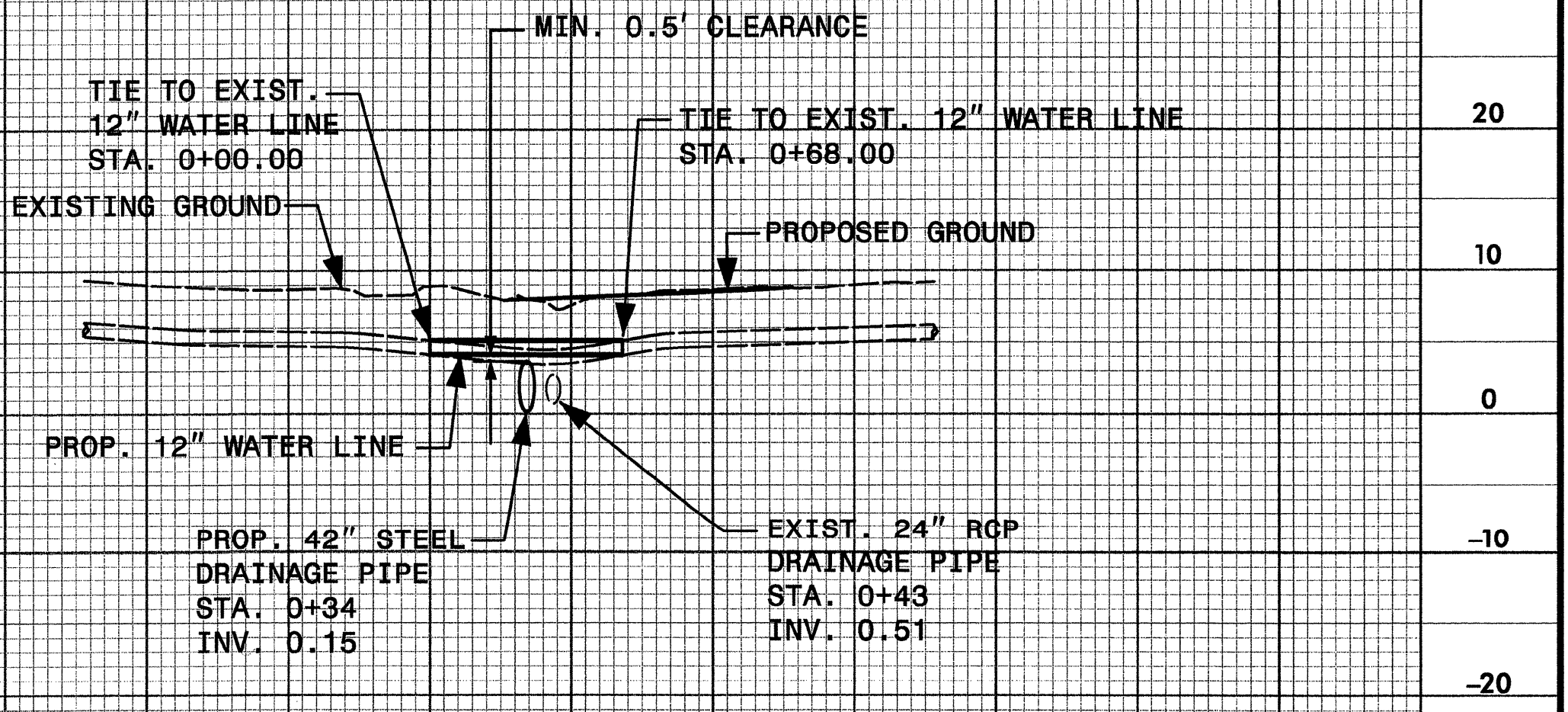

SEE PLAN SHEET UC-5

LINE WL4

USER: cwp/whm
 DATE: 5/20/2007
 TIME: 10:42 PM
 DGN: B0682_UC07.dwg

UTILITY CONSTRUCTION

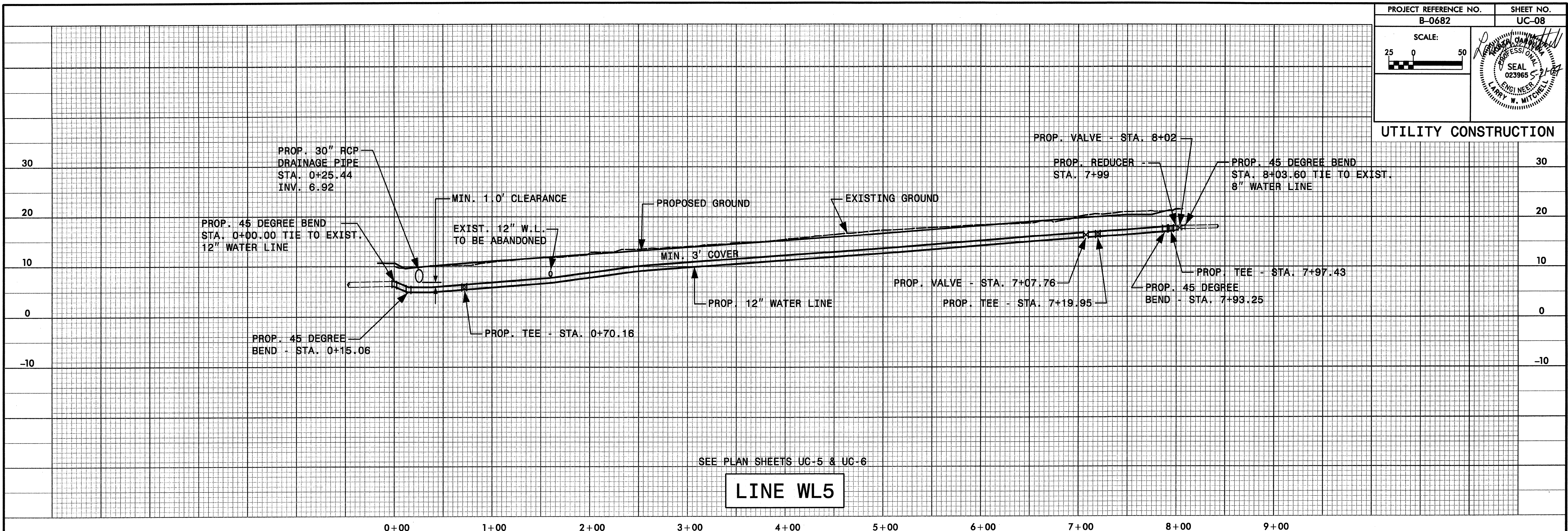

SEE PLAN SHEETS UC-5 & UC-6

LINE WL5

0+00 1+00 2+00 3+00 4+00 5+00 6+00 7+00 8+00 9+00

USER: garyjohnson
DATE: 5/21/2007
TIME: 10:58:58 PM
JOB: 10682_UC08.rvt

MAXIMUM TRENCH WIDTH AT TOP OF PIPE			
NOMINAL PIPE SIZE (inches)	TRENCH WIDTH (inches)	NOMINAL PIPE SIZE (inches)	TRENCH WIDTH (inches)
4	28	20	44
6	30	24	48
8	32	30	54
10	34	36	60
12	36	42	66
14	38	48	72
16	40	54	78
18	42		

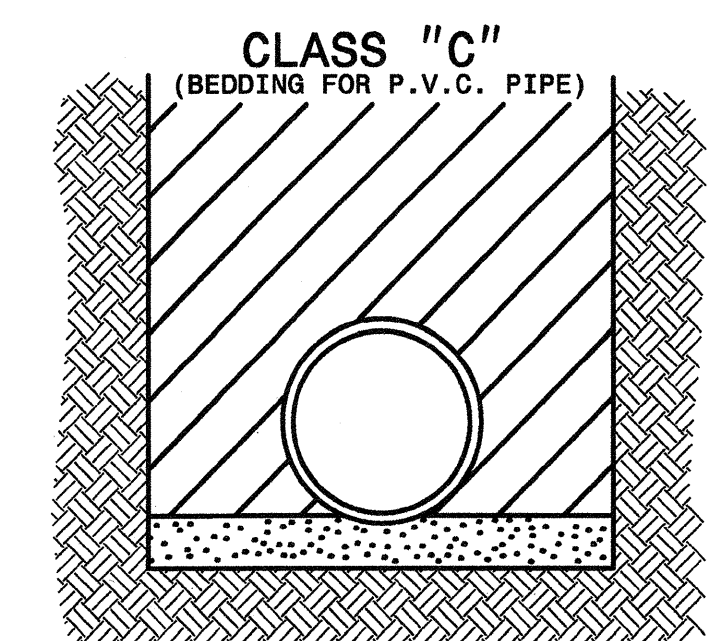
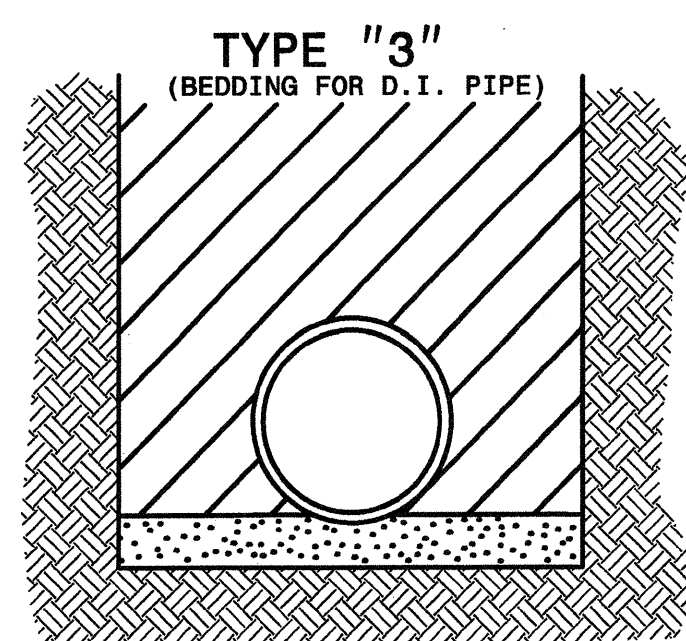

PIPE BEDDED IN 4" MINIMUM LOOSE SOIL. TRENCH BACKFILLED IN LOOSE 6" LAYERS COMPACTED TO TOP OF TRENCH USING LOCAL EXCAVATED MATERIAL IF APPROVED BY THE ENGINEER, OR SELECT MATERIAL. ALL MATERIAL SHALL BE FREE OF ROCKS, FOREIGN MATERIAL, AND FROZEN EARTH. COMPACTION SHALL BE TO APPROX. 95% DENSITY IN ACCORDANCE WITH AASHTO T-99 AS MODIFIED BY THE DEPARTMENT OF TRANSPORTATION.

PIPE BEDDED IN LOOSE MATERIAL, LIGHTLY TAMPED WITH A MINIMUM OF 6" UNDER PIPE. TRENCH BACKFILLED IN LOOSE 6" LAYERS COMPACTED TO TOP OF TRENCH USING LOCAL EXCAVATED MATERIAL, IF APPROVED BY THE ENGINEER, OR SELECT MATERIAL. ALL MATERIAL SHALL BE FREE OF ROCKS, FOREIGN MATERIAL, AND FROZEN EARTH. COMPACTION SHALL BE TO APPROX. 95% DENSITY IN ACCORDANCE WITH AASHTO T-99 AS MODIFIED BY THE DEPARTMENT OF TRANSPORTATION.

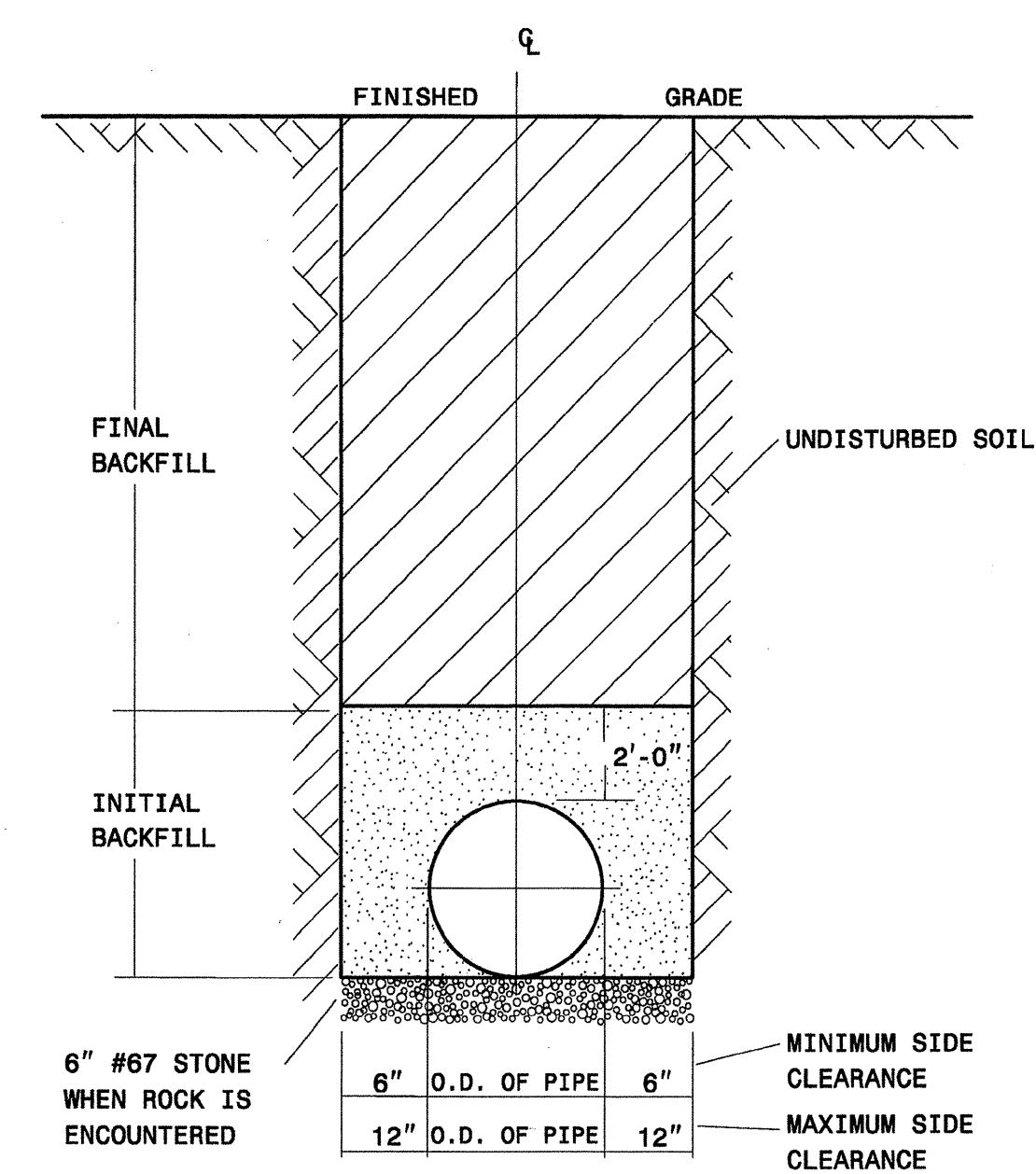

TRENCH & BACKFILL DETAIL

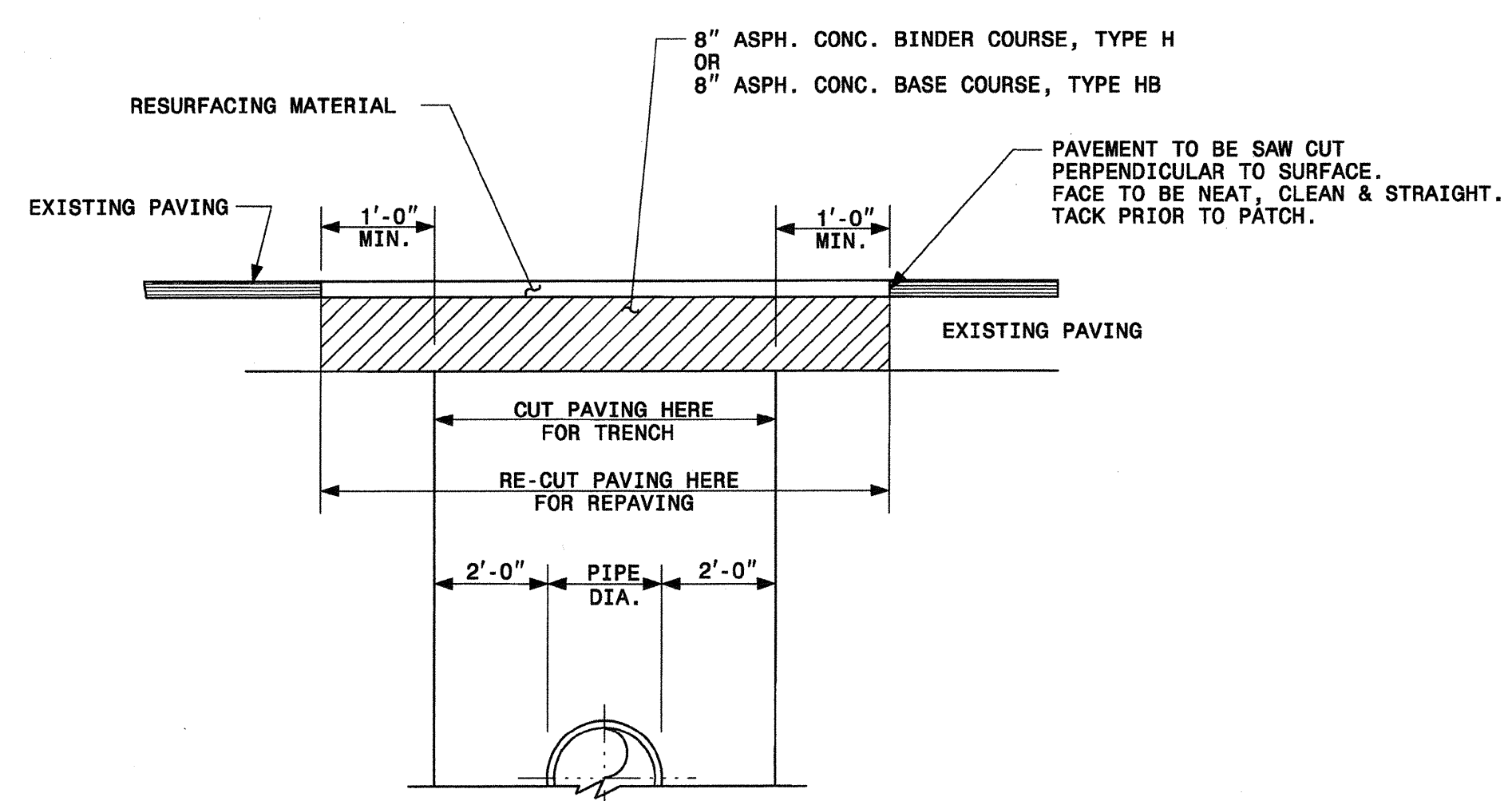
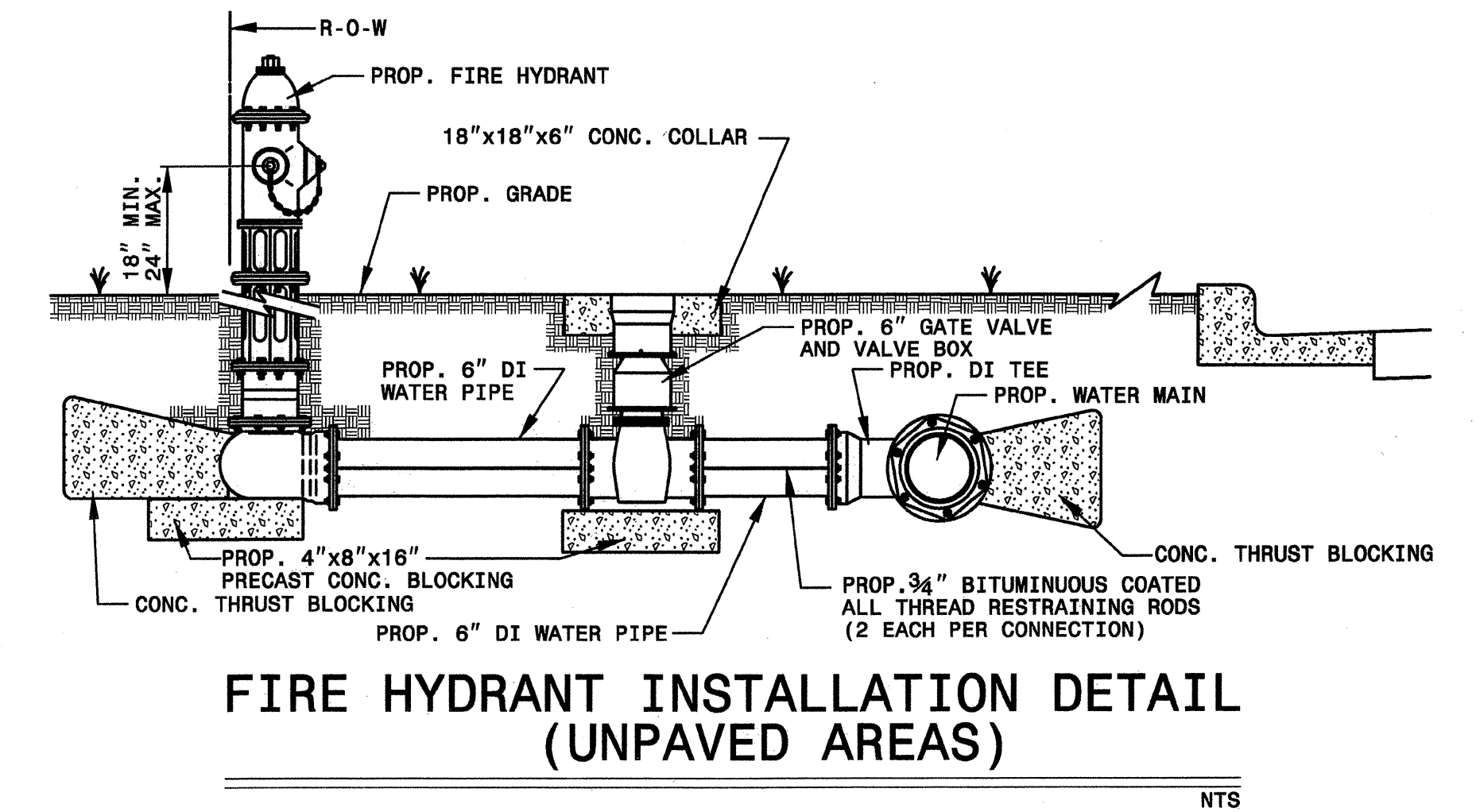
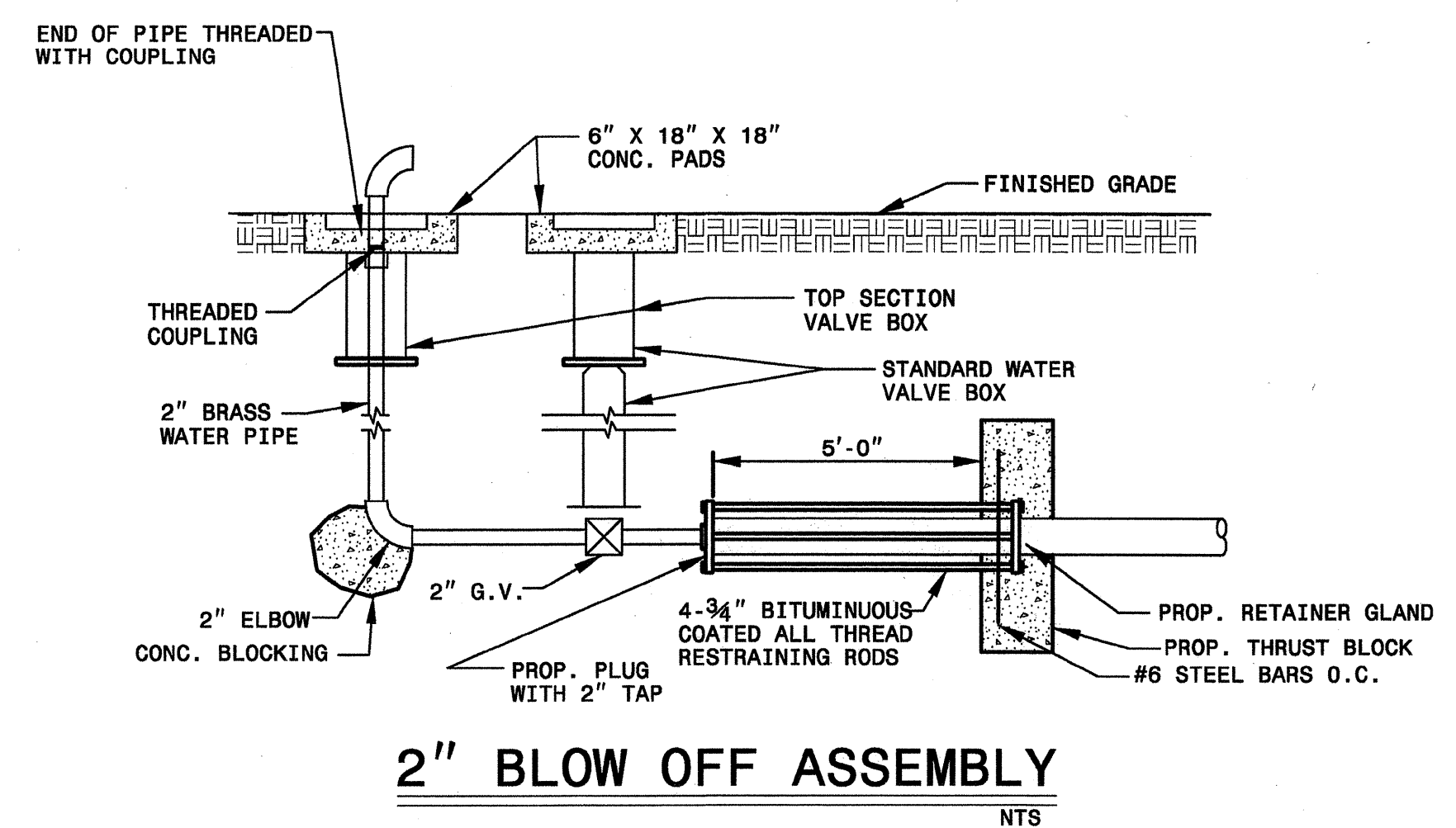

NOTE:
 IF ENGINEER APPROVED, THEN THE BACKFILL (AGGREGATE BASE COURSE OR SUITABLE SUBGRADE) SHALL BE MADE IN 6" LAYERS AND SHALL BE COMPACTED TO AT LEAST 95% OF STANDARD DENSITY (AASHTO METHOD T-99). EACH LAYER MUST BE THOROUGHLY TAMPED BY A MECHANICAL TAMP BEFORE THE NEXT LAYER IS PLACED. ALL ASPHALT PAVEMENT REPLACED SHALL BE IN ACCORDANCE WITH THE MOST CURRENT N.C.D.O.T. STANDARD SPECIFICATIONS. BASE COURSE DENSITY SHALL BE 100%.

SAW CUT AND PATCH METHOD
 UTILITY UNDER EXISTING ASPHALT STREETS

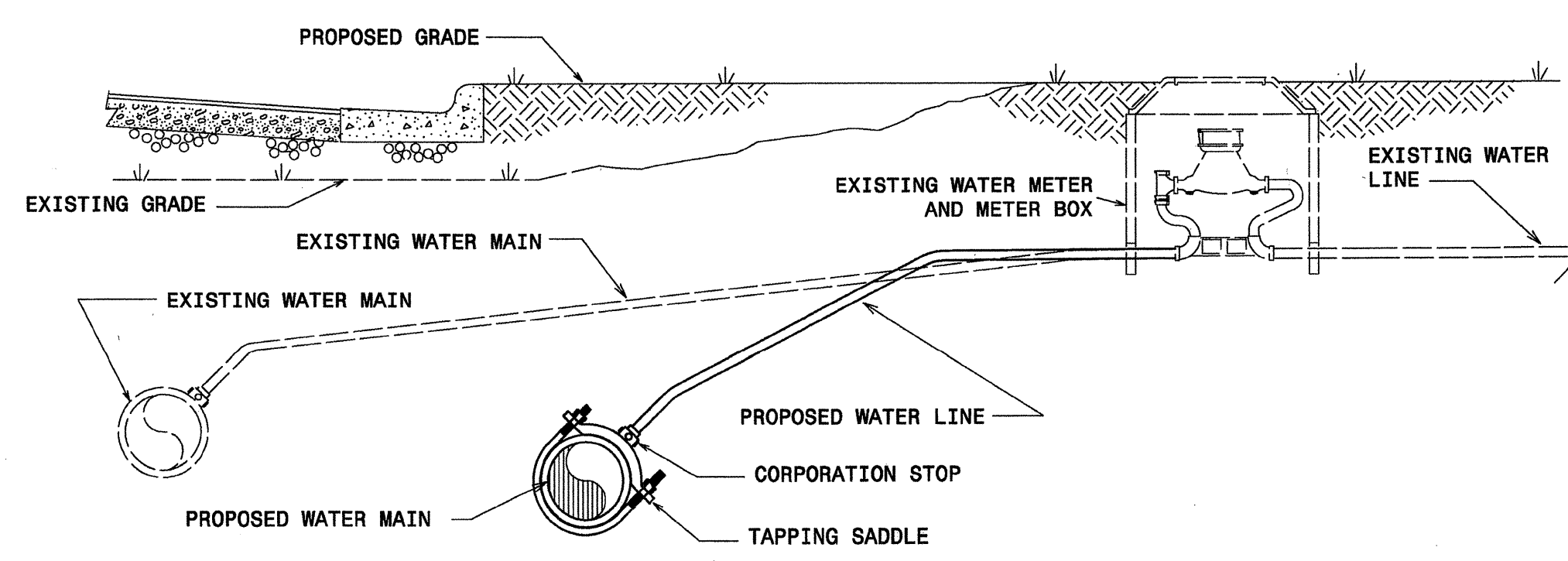

- NOTES:
1. THE NEW WATER SERVICE LINE SHALL BE OF THE SAME TYPE AND GRADE AS THE EXISTING WATER SERVICE LINE UNLESS OTHERWISE SHOWN ON THE PLANS OR DIRECTED BY THE ENGINEER.
 2. THE NEW WATER SERVICE LINE SHALL BE INSTALLED WITH A MINIMUM OF 3' COVER BELOW FINISHED GRADE.

RECONNECT EXISTING WATER METER DETAIL

Prepared by:
EarthTech
 A Tyco International Ltd. Company
 701 Corporate Center Drive, Suite 475
 Raleigh, NC 27607
 (919) 854-6200 - (919) 854-6259(fax)

TIP PROJECT: B-0682

CONTRACT: C201616

STATE OF NORTH CAROLINA
DIVISION OF HIGHWAYS

T.I.P. NO.	SHEET NO.
B-0682	UO-1

UTILITY BY OTHERS PLANS BRUNSWICK COUNTY

LOCATION: BRIDGE No. 198 OVER THE INTERCOASTAL WATERWAY
AND APPROACHES ON SR 1172 AT SUNSET BEACH

TYPE OF WORK: UTILITIES RELOCATION

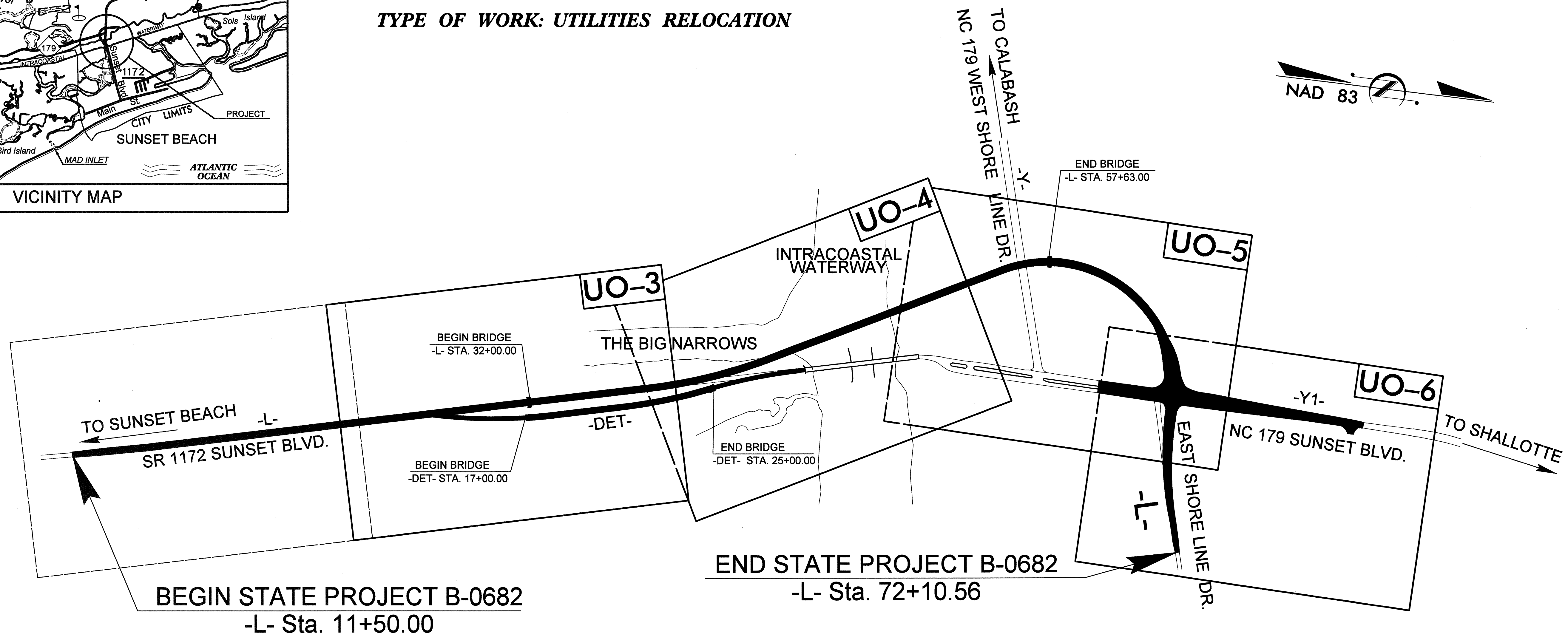
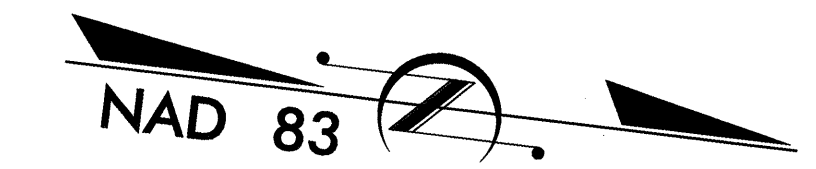
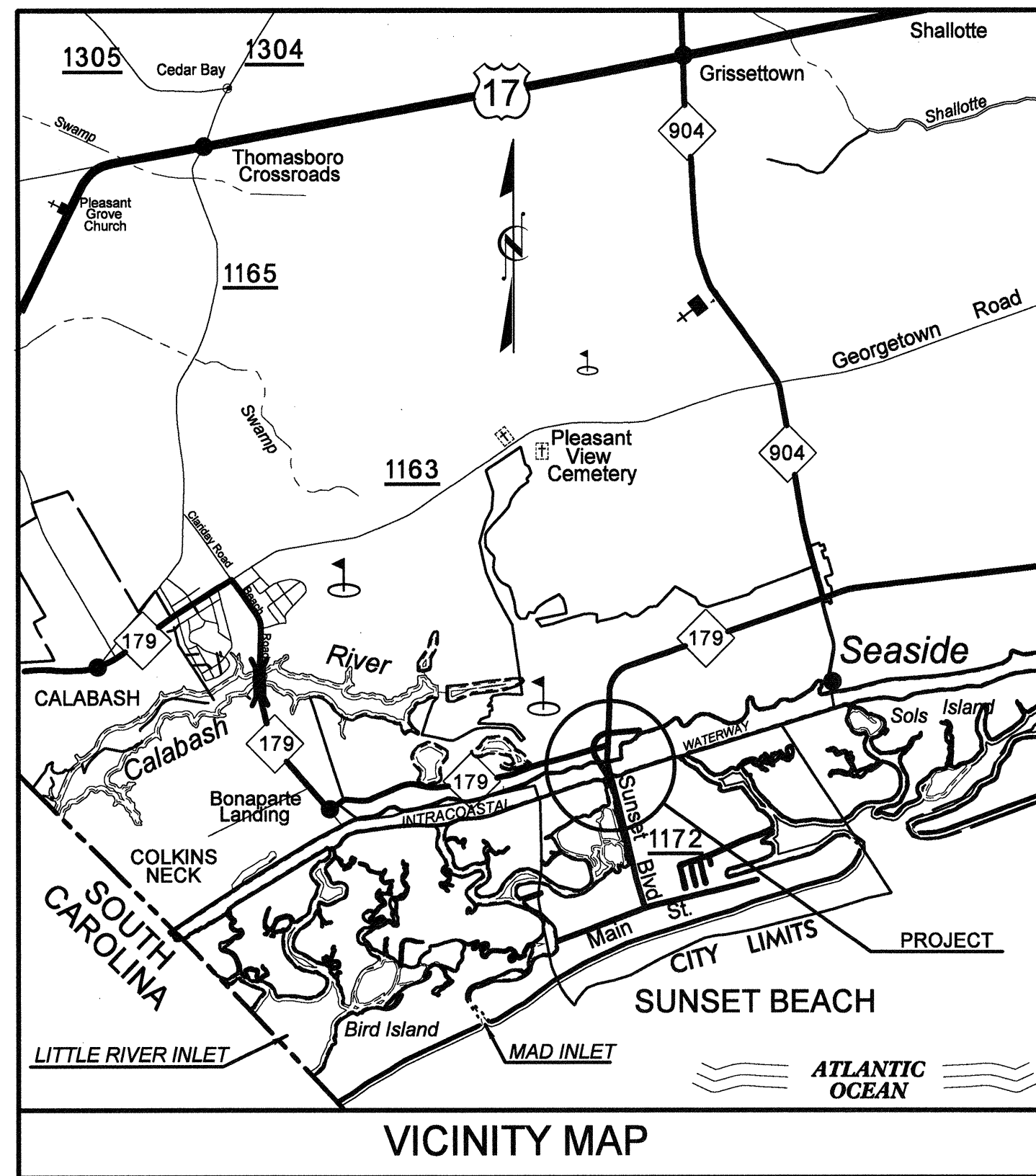

THIS PROJECT IS WITHIN THE LIMITS OF SUNSET BEACH

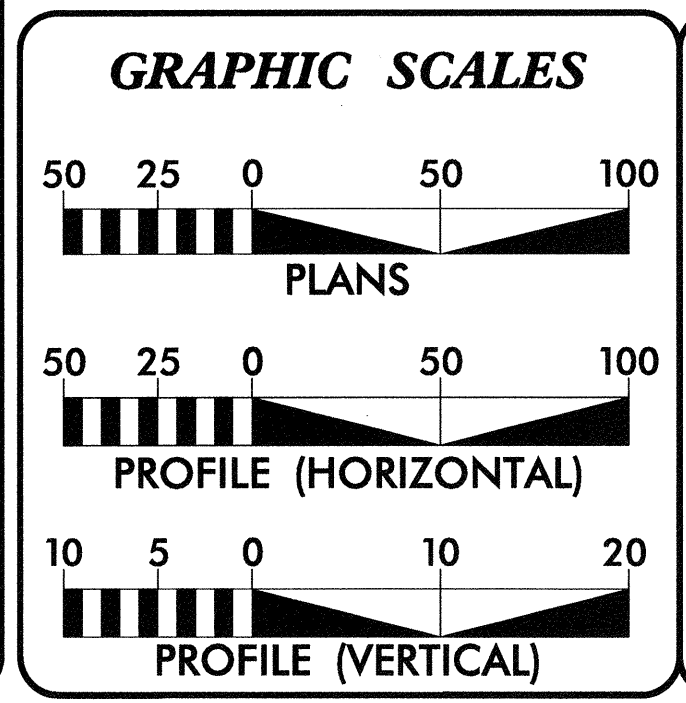

INDEX OF SHEETS	
SHEET NO.	DESCRIPTION
UO-1	TITLE SHEET
UO-3 thru UO-6	UTILITY BY OTHERS PLAN SHEETS
UO-7	UTILITY BY OTHERS PROFILE SHEET

UTILITY OWNERS ON PROJECT
(1) BRUNSWICK ELECTRIC MEMBERSHIP CORPORATION - ELECTRIC DISTRIBUTION
(2) ATLANTIC TELEPHONE MEMBERSHIP CORPORATION - TELEPHONE
(3) TOWN OF SUNSET BEACH - WATER

USER: gary.smithson
DATE: 5/21/2007
TIME: 3:02:02 PM
DWG: B0682_U01.dgn

Note: Not to Scale

*S.U.E. = Subsurface Utility Engineering













STATE OF NORTH CAROLINA
DIVISION OF HIGHWAYS

CONVENTIONAL PLAN SHEET SYMBOLS











PROJECT REFERENCE NO. B-0682	SHEET NO. UO-2

UTILITIES BY OTHERS









BOUNDARIES AND PROPERTY:

State Line	_____
County Line	_____
Township Line	_____
City Line	_____
Reservation Line	_____
Property Line	_____
Existing Iron Pin	_____ 
Property Corner	_____ 
Property Monument	_____ 
Parcel/Sequence Number	_____ 
Existing Fence Line	_____ 
Proposed Woven Wire Fence	_____ 
Proposed Chain Link Fence	_____ 
Proposed Barbed Wire Fence	_____ 
Existing Wetland Boundary	_____ 
Proposed Wetland Boundary	_____ 
Existing High Quality Wetland Boundary	_____ 
Existing Endangered Animal Boundary	_____ 
Existing Endangered Plant Boundary	_____ 



BUILDINGS AND OTHER CULTURE:

Gas Pump Vent or U/G Tank Cap	_____ 
Sign	_____ 
Well	_____ 
Small Mine	_____ 
Foundation	_____ 
Area Outline	_____ 
Cemetery	_____ 
Building	_____ 
School	_____ 
Church	_____ 
Dam	_____ 





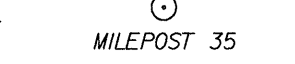
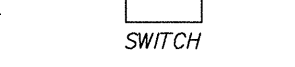



HYDROLOGY:

Stream or Body of Water	_____
Hydro, Pool or Reservoir	_____ 
River Basin Buffer	_____ 
Flow Arrow	_____ 
Disappearing Stream	_____ 
Spring	_____ 
Swamp Marsh	_____ 
Proposed Lateral, Tail, Head Ditch	_____ 
False Sump	_____ 



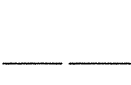
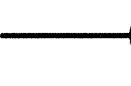

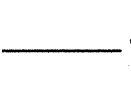
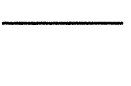

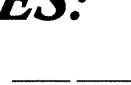
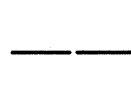

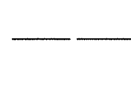

RAILROADS:

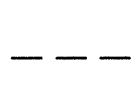
Standard Gauge	_____ 
RR Signal Milepost	_____ 
Switch	_____ 
RR Abandoned	_____ 
RR Dismantled	_____ 

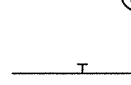
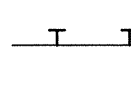
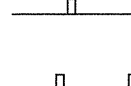



RIGHT OF WAY:

Baseline Control Point	_____ 
Existing Right of Way Marker	_____ 
Existing Right of Way Line	_____ 
Proposed Right of Way Line	_____ 
Proposed Right of Way Line with Iron Pin and Cap Marker	_____ 
Proposed Right of Way Line with Concrete or Granite Marker	_____ 
Existing Control of Access	_____ 
Proposed Control of Access	_____ 
Existing Easement Line	_____ 
Proposed Temporary Construction Easement	_____ 
Proposed Temporary Drainage Easement	_____ 
Proposed Permanent Drainage Easement	_____ 
Proposed Permanent Utility Easement	_____ 



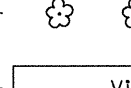

ROADS AND RELATED FEATURES:

Existing Edge of Pavement	_____ 
Existing Curb	_____ 
Proposed Slope Stakes Cut	_____ 
Proposed Slope Stakes Fill	_____ 
Proposed Wheel Chair Ramp	_____ 
Curb Cut for Future Wheel Chair Ramp	_____ 
Existing Metal Guardrail	_____ 
Proposed Guardrail	_____ 
Existing Cable Guiderail	_____ 
Proposed Cable Guiderail	_____ 
Equality Symbol	_____ 
Pavement Removal	_____ 



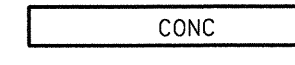
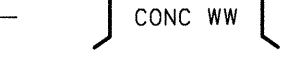
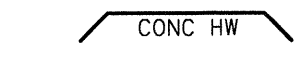
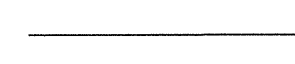
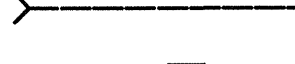
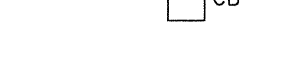







VEGETATION:

Single Tree	_____ 
Single Shrub	_____ 
Hedge	_____ 
Woods Line	_____ 
Orchard	_____ 
Vineyard	_____ 













EXISTING STRUCTURES:

MAJOR:	
Bridge, Tunnel or Box Culvert	_____ 
Bridge Wing Wall, Head Wall and End Wall	_____ 
MINOR:	
Head and End Wall	_____ 
Pipe Culvert	_____ 
Footbridge	_____ 
Drainage Box: Catch Basin, DI or JB	_____ 
Paved Ditch Gutter	_____ 
Storm Sewer Manhole	_____ 
Storm Sewer	_____ 





UTILITIES:

POWER:	
Existing Power Pole	_____ 
Proposed Power Pole	_____ 
Existing Joint Use Pole	_____ 
Proposed Joint Use Pole	_____ 
Power Manhole	_____ 
Power Line Tower	_____ 
Power Transformer	_____ 
U/G Power Cable Hand Hole	_____ 
H-Frame Pole	_____ 
Recorded U/G Power Line	_____ 
Designated U/G Power Line (S.U.E.*)	_____ 





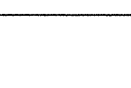
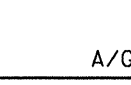



TELEPHONE:

Existing Telephone Pole	_____ 
Proposed Telephone Pole	_____ 
Telephone Manhole	_____ 
Telephone Booth	_____ 
Telephone Pedestal	_____ 
Telephone Cell Tower	_____ 
U/G Telephone Cable Hand Hole	_____ 
Recorded U/G Telephone Cable	_____ 
Designated U/G Telephone Cable (S.U.E.*)	_____ 
Recorded U/G Telephone Conduit	_____ 
Designated U/G Telephone Conduit (S.U.E.*)	_____ 
Recorded U/G Fiber Optics Cable	_____ 
Designated U/G Fiber Optics Cable (S.U.E.*)	_____

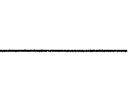

WATER:

Water Manhole	_____ 
Water Meter	_____ 
Water Valve	_____ 
Water Hydrant	_____ 
Recorded U/G Water Line	_____ 
Designated U/G Water Line (S.U.E.*)	_____ 
Above Ground Water Line	_____ 



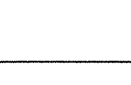
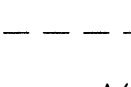

TV:

TV Satellite Dish	_____ 
TV Pedestal	_____ 
TV Tower	_____ 
U/G TV Cable Hand Hole	_____ 
Recorded U/G TV Cable	_____ 
Designated U/G TV Cable (S.U.E.*)	_____ 
Recorded U/G Fiber Optic Cable	_____ 
Designated U/G Fiber Optic Cable (S.U.E.*)	_____ 



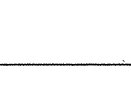
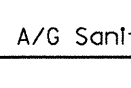





GAS:

Gas Valve	_____ 
Gas Meter	_____ 
Recorded U/G Gas Line	_____ 
Designated U/G Gas Line (S.U.E.*)	_____ 
Above Ground Gas Line	_____ 

SANITARY SEWER:

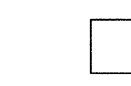
Sanitary Sewer Manhole	_____ 
Sanitary Sewer Cleanout	_____ 
U/G Sanitary Sewer Line	_____ 
Above Ground Sanitary Sewer	_____ 
Recorded SS Forced Main Line	_____ 
Designated SS Forced Main Line (S.U.E.*)	_____ 

MISCELLANEOUS:

Utility Pole	_____ 
Utility Pole with Base	_____ 
Utility Located Object	_____ 
Utility Traffic Signal Box	_____ 
Utility Unknown U/G Line	_____ 
U/G Tank; Water, Gas, Oil	_____ 
A/G Tank; Water, Gas, Oil	_____ 
U/G Test Hole (S.U.E.*)	_____ 
Abandoned According to Utility Records	_____ AATUR
End of Information	_____ E.O.I.

NOTE:
ALL PROPOSED UTILITY WORK
SHOWN ON THIS SHEET WILL
BE DONE BY OTHERS

-L-
PI Sta 40+10.40
= 14° 00' 31.7" (LT)
D = 2° 30' 00.0"
L = 560.35'
T = 281.58'
R = 2,291.83'
SE = 03

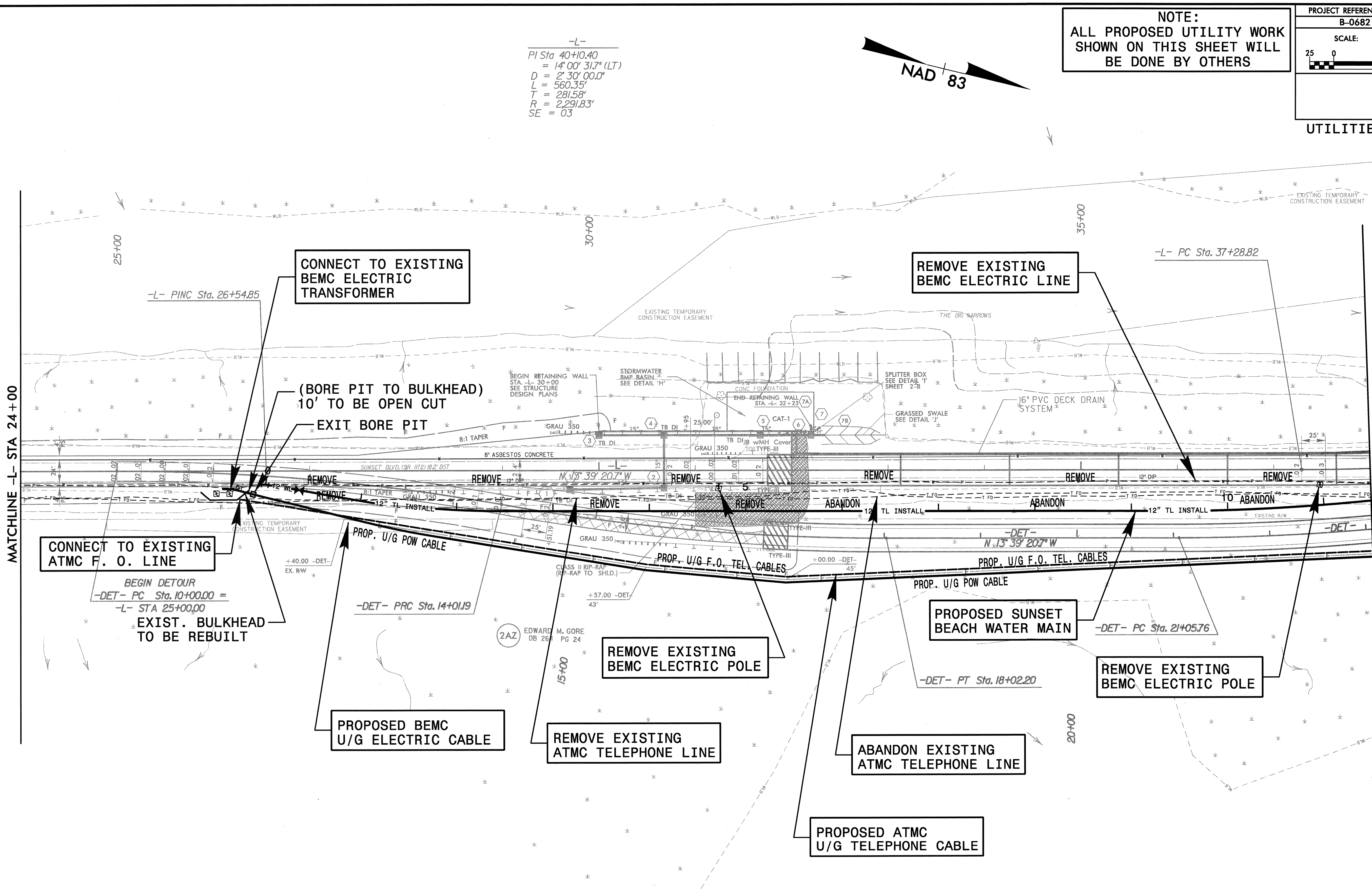
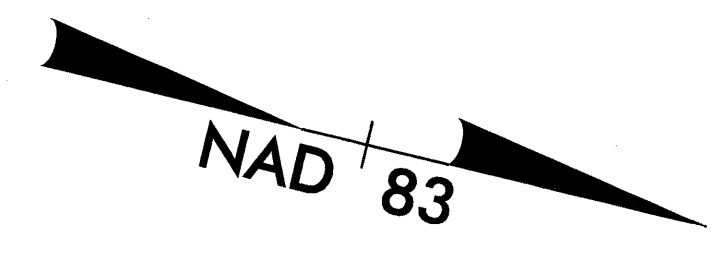

CONNECT TO EXISTING
ATMC F. O. LINE

BEGIN DETOUR
-DET- PC Sta. 10+00.00 =
-L- STA 25+00.00
EXIST. BULKHEAD
TO BE REBUILT

CONNECT TO EXISTING
BEMC ELECTRIC
TRANSFORMER

(BORE PIT TO BULKHEAD)
10' TO BE OPEN CUT
EXIT BORE PIT

PROPOSED BEMC
U/G ELECTRIC CABLE

REMOVE EXISTING
ATMC TELEPHONE LINE

REMOVE EXISTING
BEMC ELECTRIC POLE

PROPOSED ATMC
U/G TELEPHONE CABLE

ABANDON EXISTING
ATMC TELEPHONE LINE

PROPOSED SUNSET
BEACH WATER MAIN

REMOVE EXISTING
BEMC ELECTRIC POLE

REMOVE EXISTING
BEMC ELECTRIC LINE

NOTE:
POWER AND TELEPHONE CABLES THIS SHEET
TO BE INSTALLED BY DIRECTIONAL DRILLING

NOTE:
ALL PROPOSED UTILITY WORK
SHOWN ON THIS SHEET WILL
BE DONE BY OTHERS

UTILITIES BY OTHERS

-L-
PI Sta 40+10.40
= 14° 00' 31.7" (LT)
D = 2' 30' 00.0"
L = 560.35'
T = 281.58'
R = 2,291.83'
SE = 03

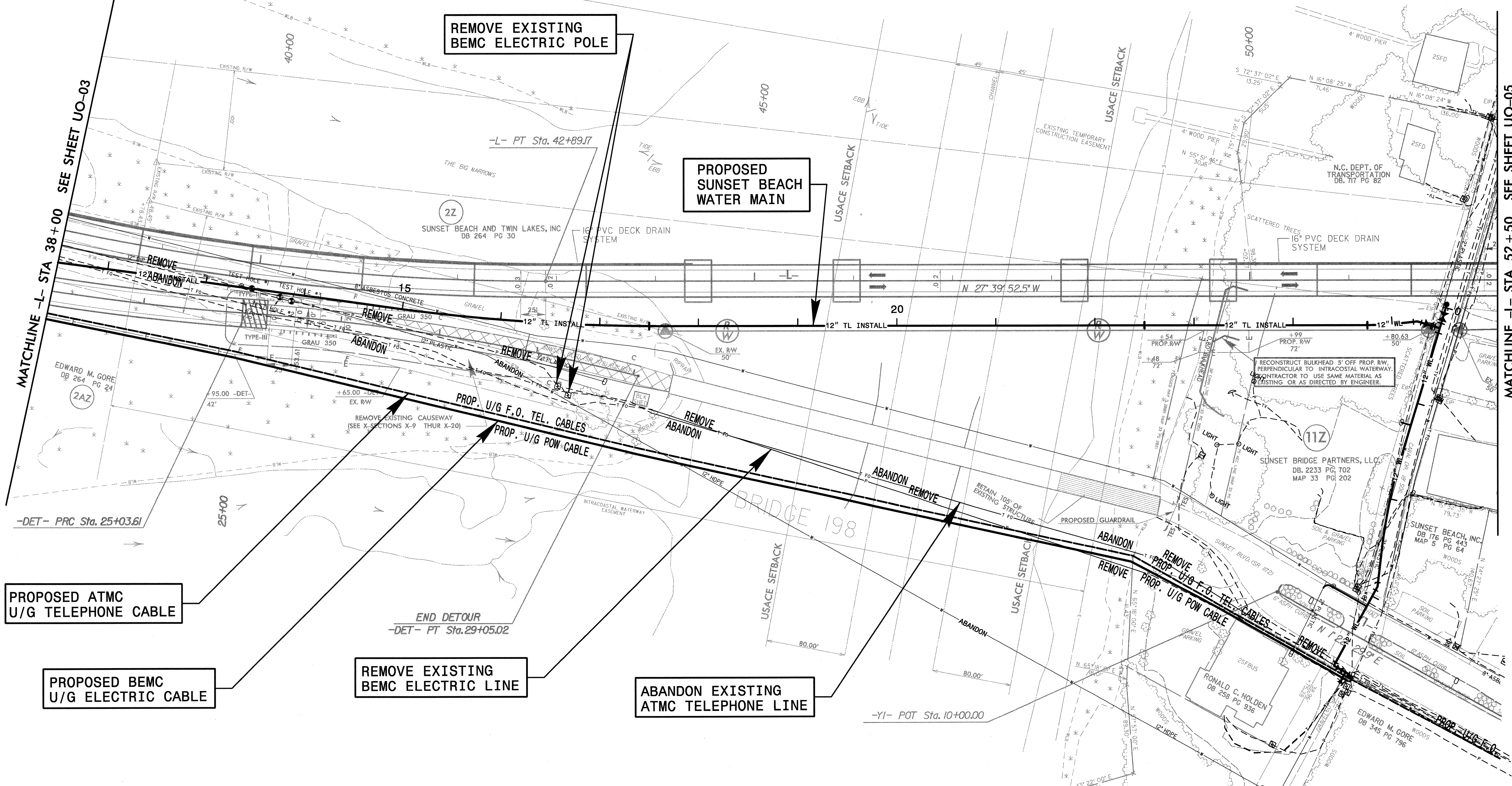
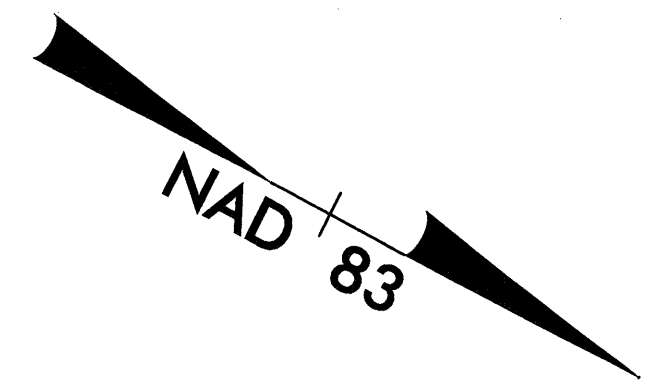

MATCHLINE -L- STA 38+00 SEE SHEET UO-03

MATCHLINE -L- STA 52+50 SEE SHEET UO-05

PROPOSED ATMC
U/G TELEPHONE CABLE

PROPOSED BEMC
U/G ELECTRIC CABLE

REMOVE EXISTING
BEMC ELECTRIC LINE

ABANDON EXISTING
ATMC TELEPHONE LINE

NOTE:
POWER AND TELEPHONE CABLES IN WETLANDS THIS
SHEET TO BE INSTALLED BY DIRECTIONAL DRILLING

NOTE:
ALL PROPOSED UTILITY WORK
SHOWN ON THIS SHEET WILL
BE DONE BY OTHERS

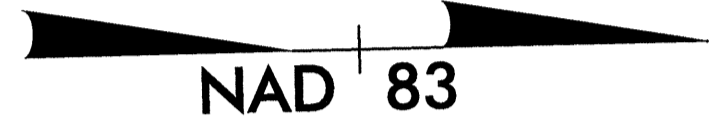
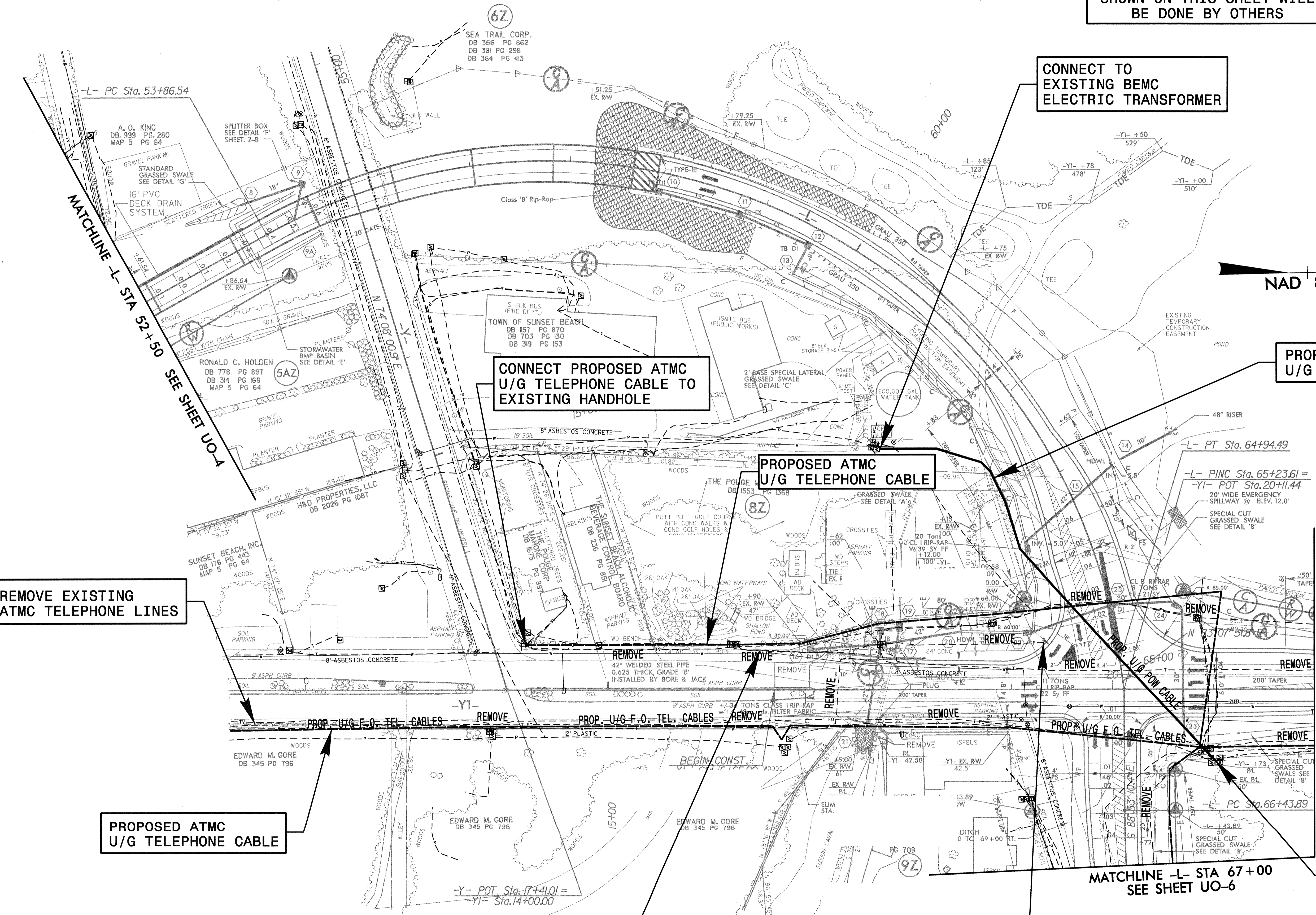

USER: gary.watson
DATE: 5/21/2007
TIME: 2:59:36 PM
JOB: 0682_uo05.dgn

NOTE:
ALL PROPOSED UTILITY WORK
SHOWN ON THIS SHEET WILL
BE DONE BY OTHERS

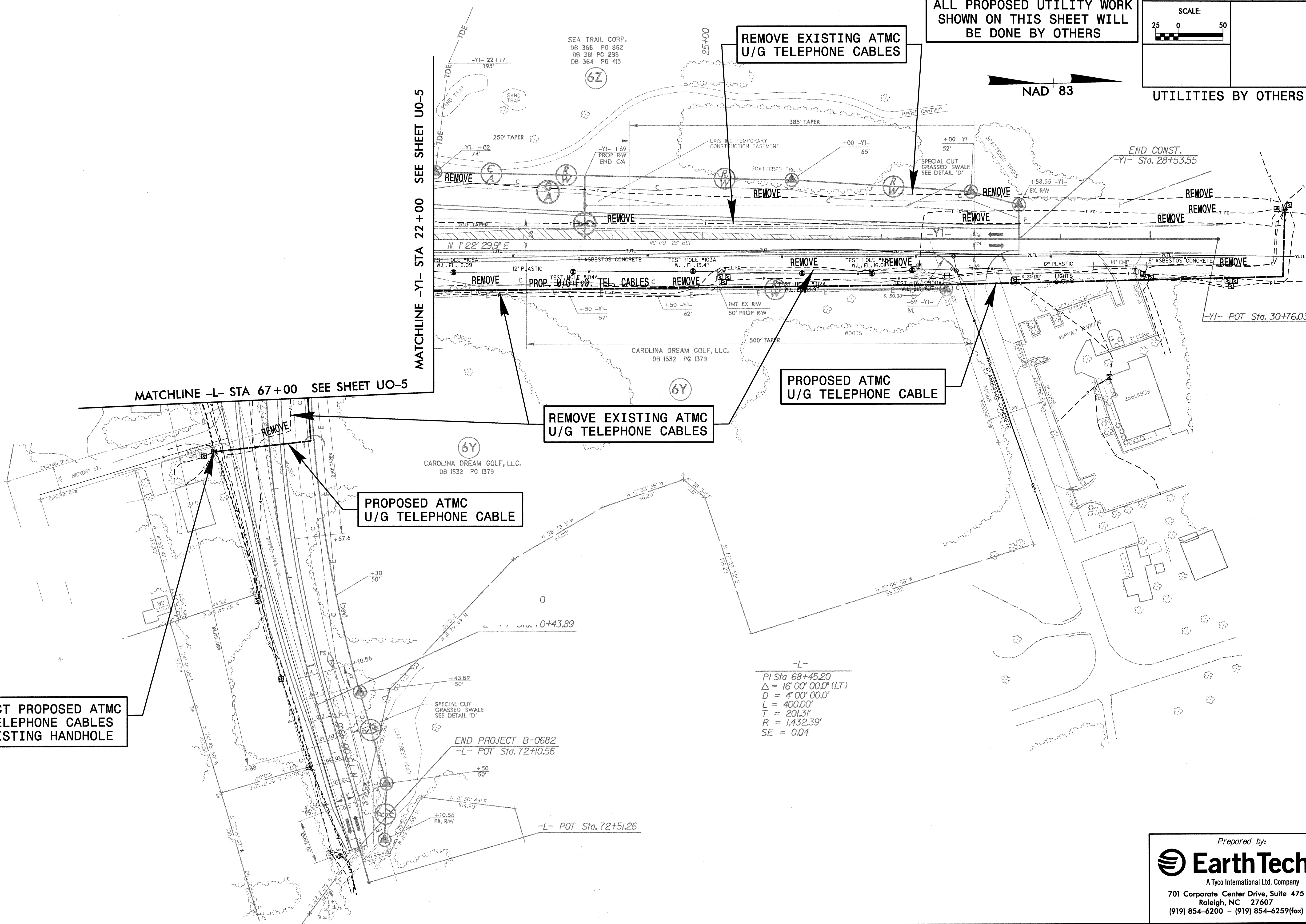
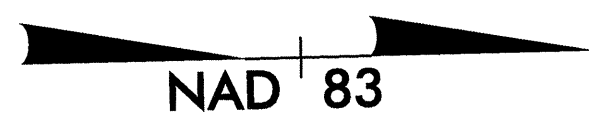

REMOVE EXISTING ATMC
U/G TELEPHONE CABLES

REMOVE EXISTING ATMC
U/G TELEPHONE CABLES

PROPOSED ATMC
U/G TELEPHONE CABLE

PROPOSED ATMC
U/G TELEPHONE CABLE

CONNECT PROPOSED ATMC
U/G TELEPHONE CABLES
TO EXISTING HANDHOLE

MATCHLINE -YI- STA 22+00 SEE SHEET UO-5

MATCHLINE -L- STA 67+00 SEE SHEET UO-5

-L-
PI Sta 68+45.20
 $\Delta = 16^{\circ} 00' 00.0''$ (LT)
 $D = 4^{\circ} 00' 00.0''$
 $L = 400.00'$
 $T = 201.31'$
 $R = 1,432.39'$
 $SE = 0.04$

END PROJECT B-0682
-L- POT Sta. 72+10.56

-L- POT Sta. 72+51.26

USER: gary.watson
 DATE: 5/21/2007
 TIME: 2:55:56 PM
 DGN: 06822_uo06.dgn

NOTE:
ALL PROPOSED UTILITY WORK SHOWN ON THIS SHEET WILL BE DONE BY OTHERS

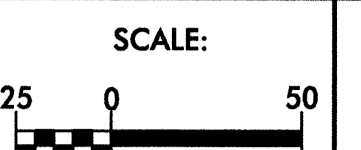

UTILITIES BY OTHERS

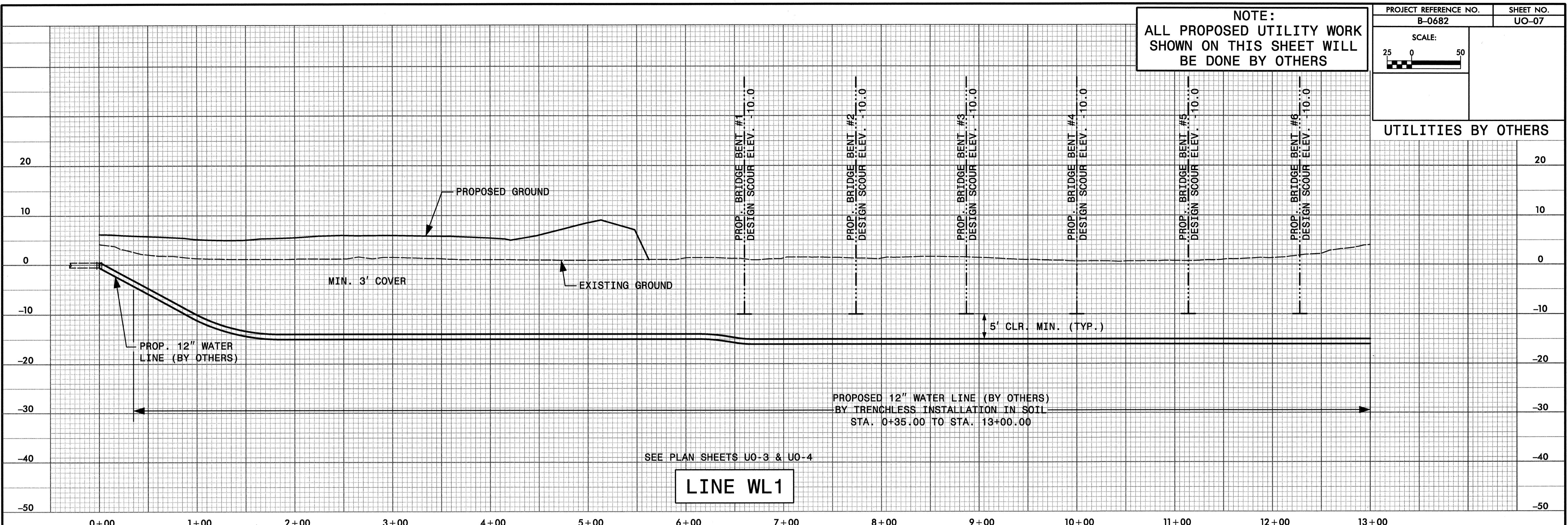

LINE WL1

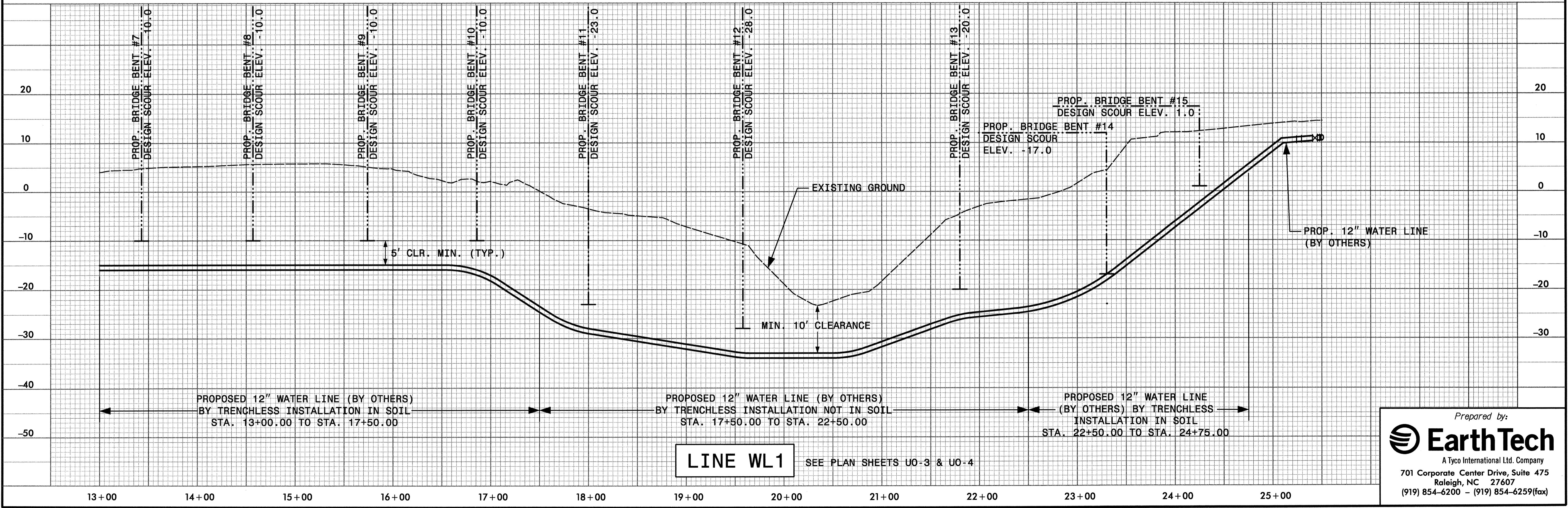

LINE WL1

Prepared by:
EarthTech
A Tyco International Ltd. Company
701 Corporate Center Drive, Suite 475
Raleigh, NC 27607
(919) 854-6200 - (919) 854-6259(fax)

USER: g07ydw/hsan
DATE: 5/21/2007
TIME: 2:56:39 PM
JOB: 0682.uo07.dwg