

NOTES

THE GUARDRAIL ANCHOR ASSEMBLY SHALL CONSIST OF A 1/4" HOLD DOWN PLATE AND 7 - 7/8" Ø BOLTS WITH NUTS AND WASHERS.

THE HOLD-DOWN PLATE SHALL CONFORM TO AASHTO M270 GRADE 36. AFTER FABRICATION, THE HOLD-DOWN PLATE SHALL BE HOT-DIP GALVANIZED IN ACCORDANCE WITH AASHTO M111.

BOLTS SHALL CONFORM TO THE REQUIREMENTS OF ASTM A307 AND NUTS SHALL CONFORM TO THE REQUIREMENTS OF AASHTO M291. BOLTS, NUTS AND WASHERS SHALL BE GALVANIZED. AT THE CONTRACTOR'S OPTION, STAINLESS STEEL BOLTS, NUTS AND WASHERS MAY BE USED AS AN ALTERNATE FOR THE 7/8" Ø GALVANIZED BOLTS, NUTS AND WASHERS. THEY SHALL CONFORM TO OR EXCEED THE MECHANICAL REQUIREMENTS OF ASTM A307. THE USE OF THIS ALTERNATE SHALL BE APPROVED BY THE ENGINEER.

AFTER INSTALLATION, THE EXPOSED THREAD OF THE BOLT SHALL BE BURRED WITH A SHARP POINTED TOOL.

THE COST OF THE GUARDRAIL ANCHOR ASSEMBLIES WITH BOLTS, NUTS AND WASHERS COMPLETE IN PLACE, SHALL BE INCLUDED IN THE LUMP SUM CONTRACT PRICE BID FOR BRIDGE APPROACH SLABS.

THE 1 1/4" Ø HOLES SHALL BE FORMED OR DRILLED WITH A CORE BIT. IMPACT TOOLS WILL NOT BE PERMITTED. ANY CONCRETE DAMAGED BY THIS WORK SHALL BE REPAIRED TO THE SATISFACTION OF THE ENGINEER.

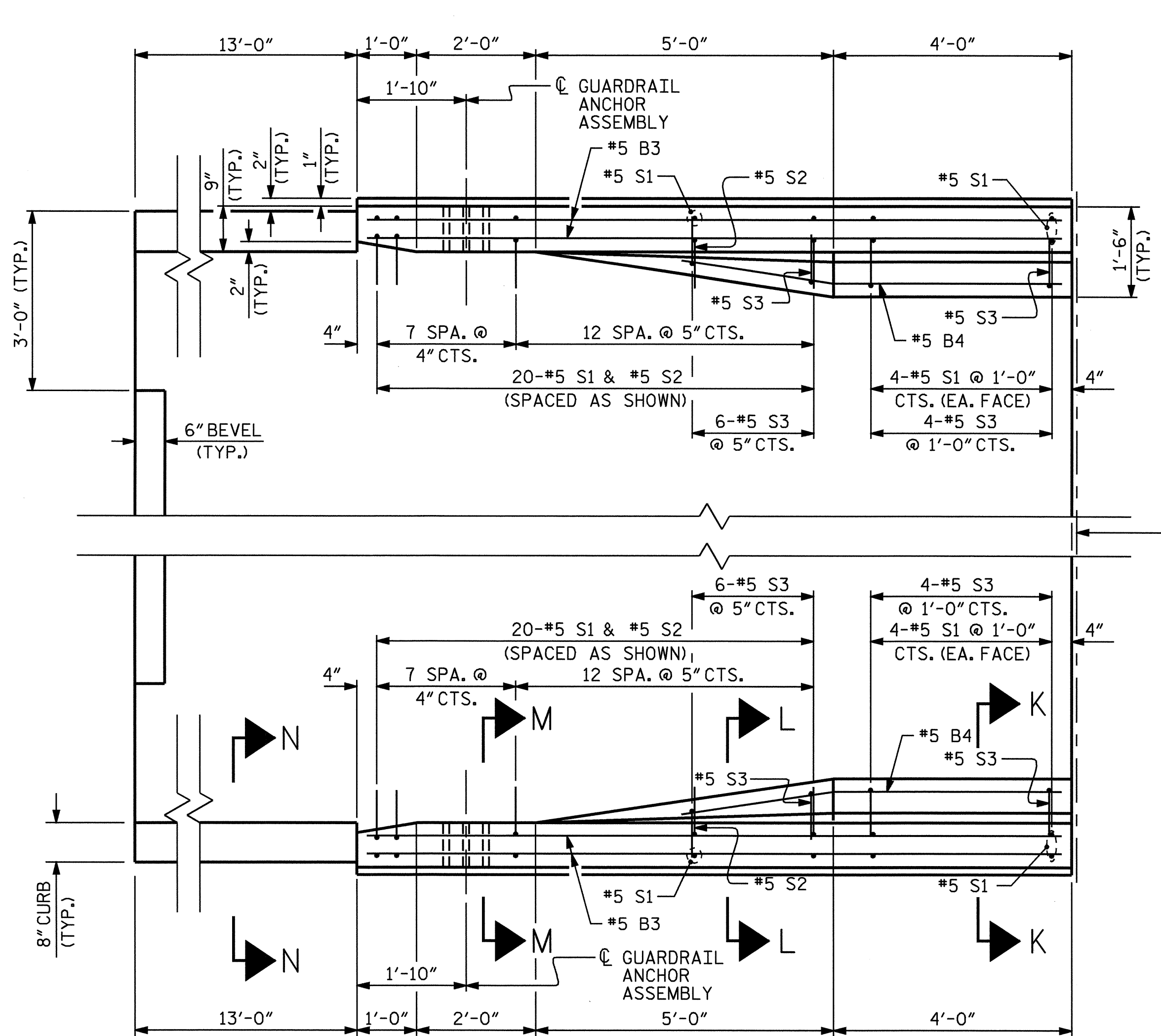

PLAN

GUARDRAIL ANCHOR ASSEMBLY DETAILS

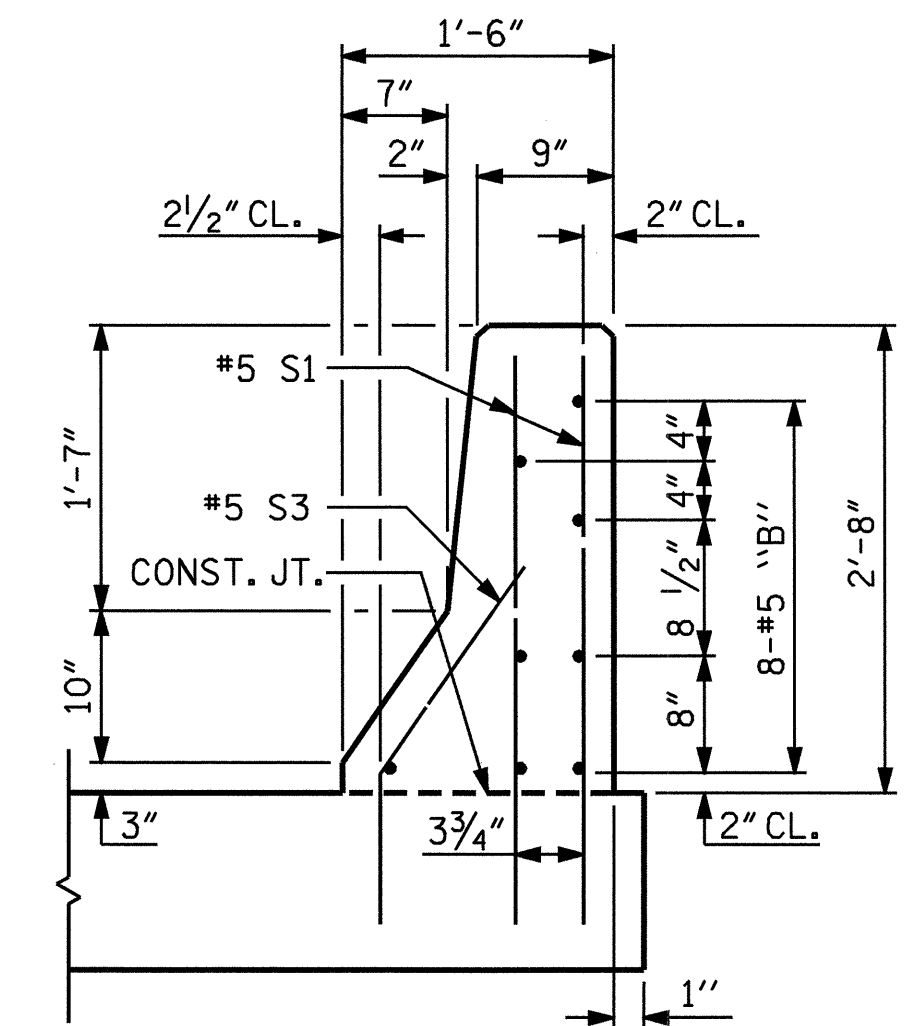

SECTION K-K

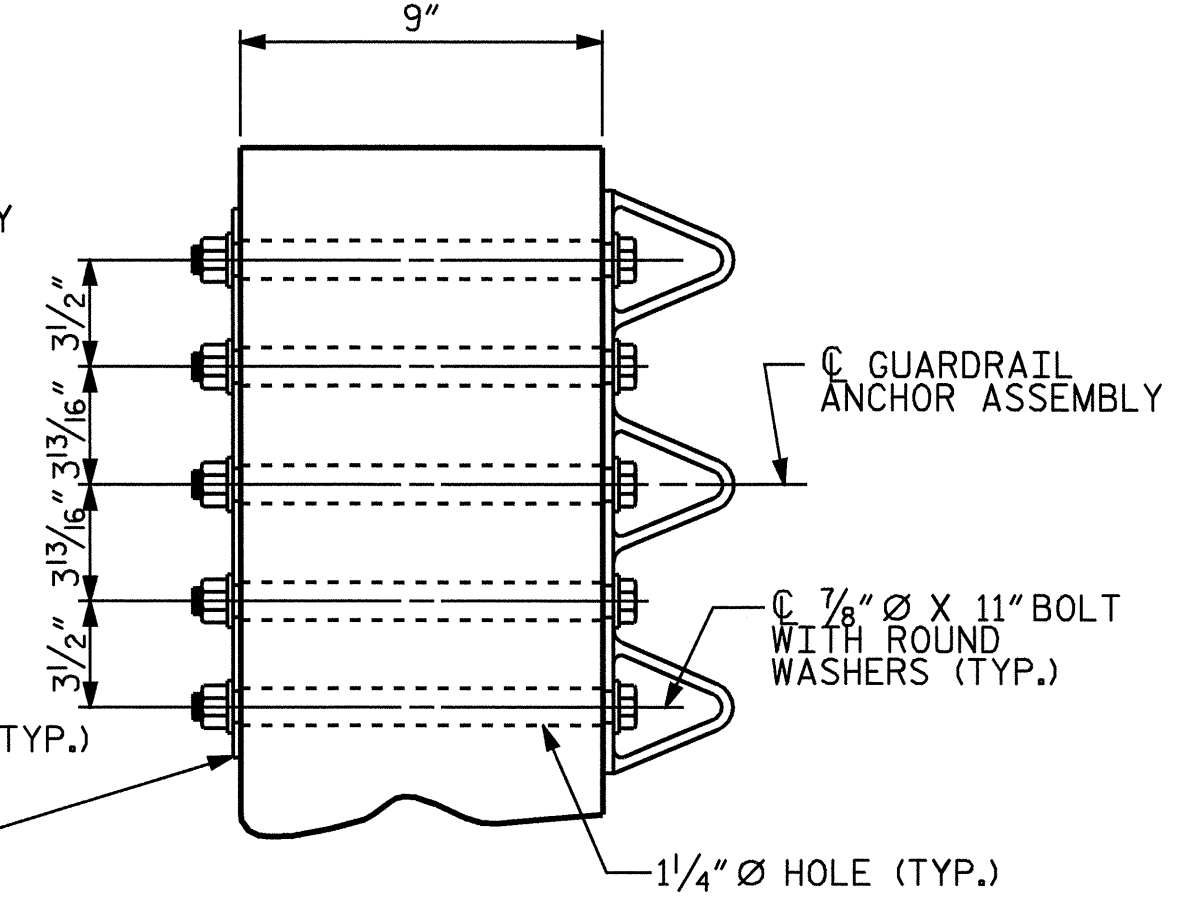

SECTION E-E

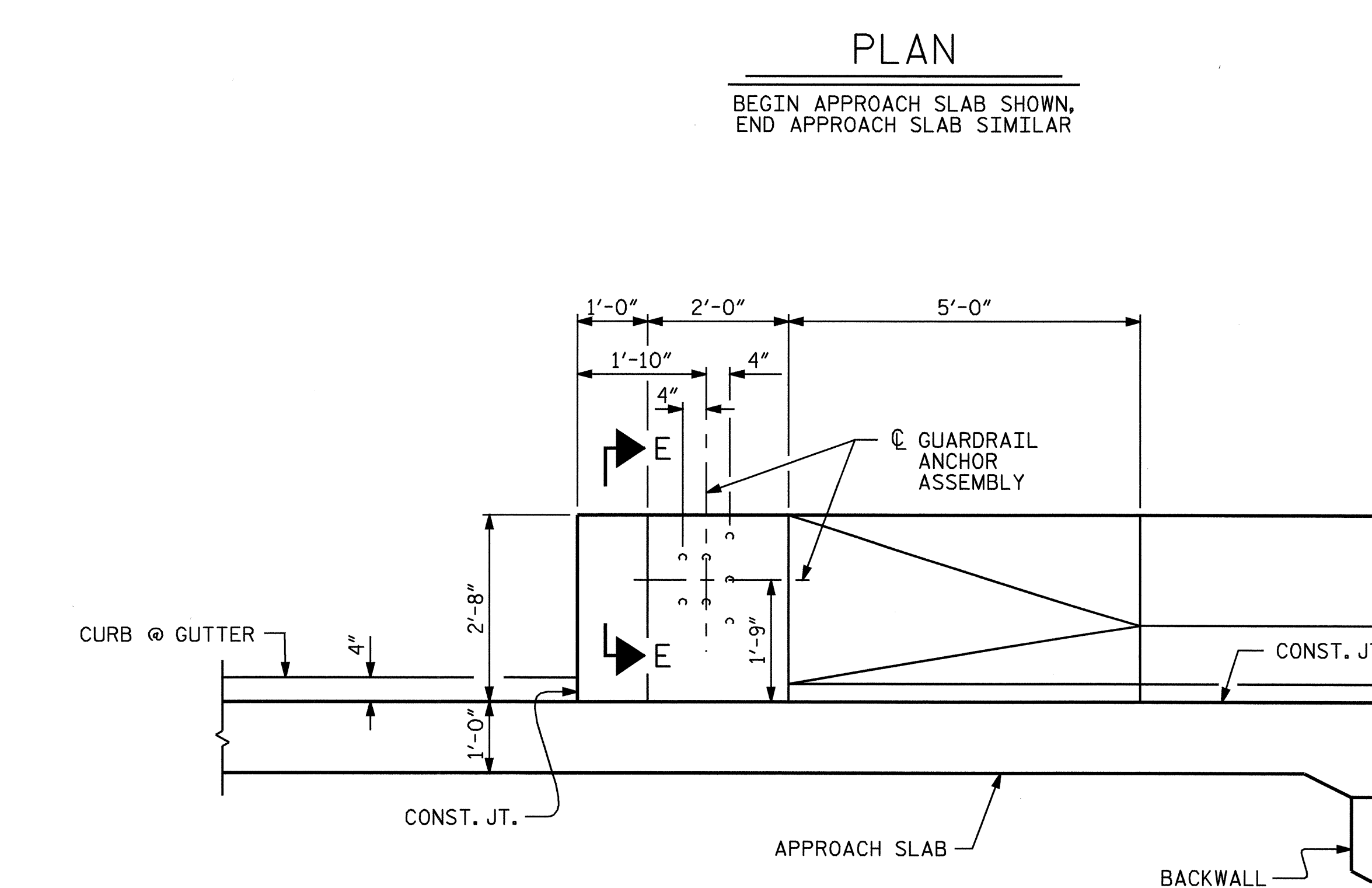

ELEVATION

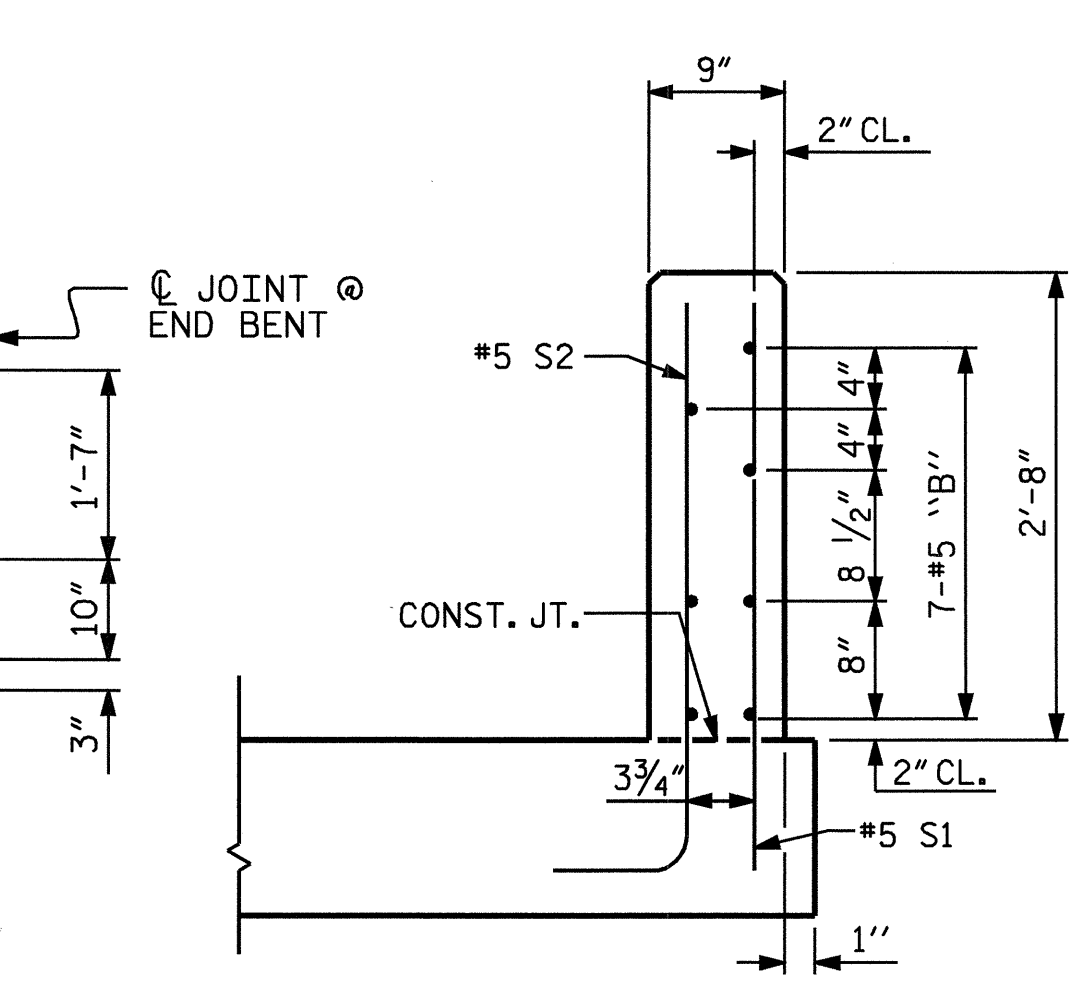

SECTION M-M

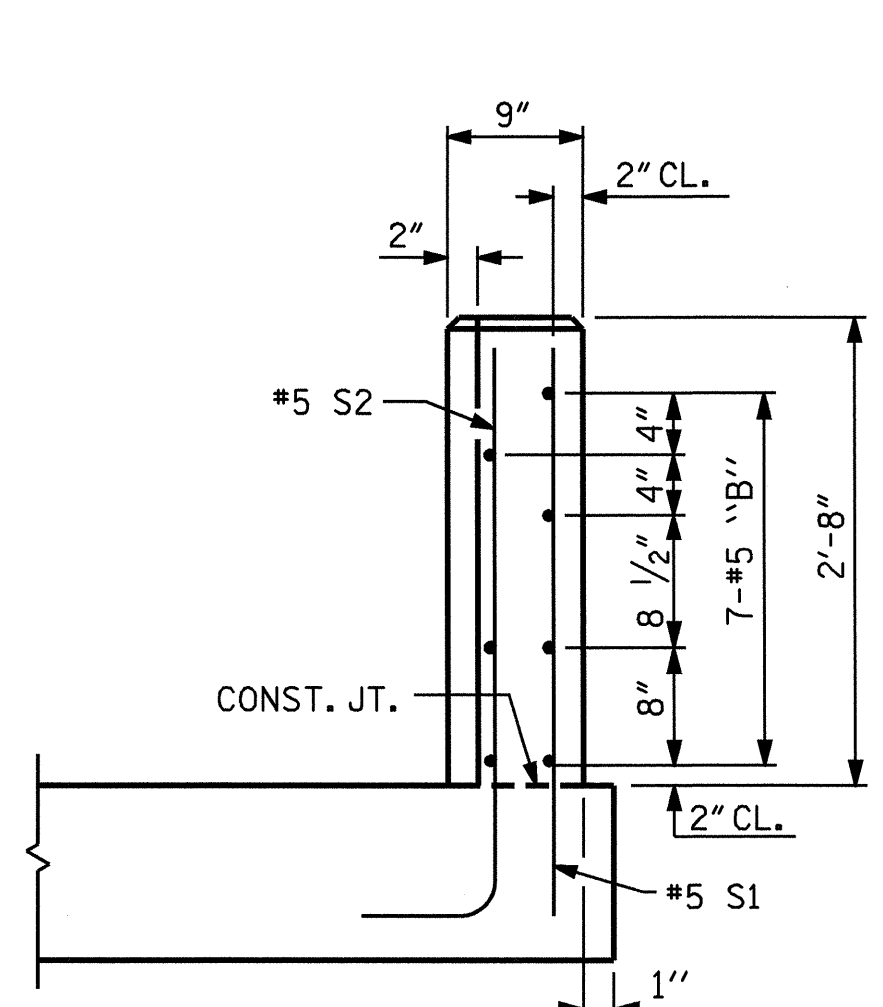

END VIEW

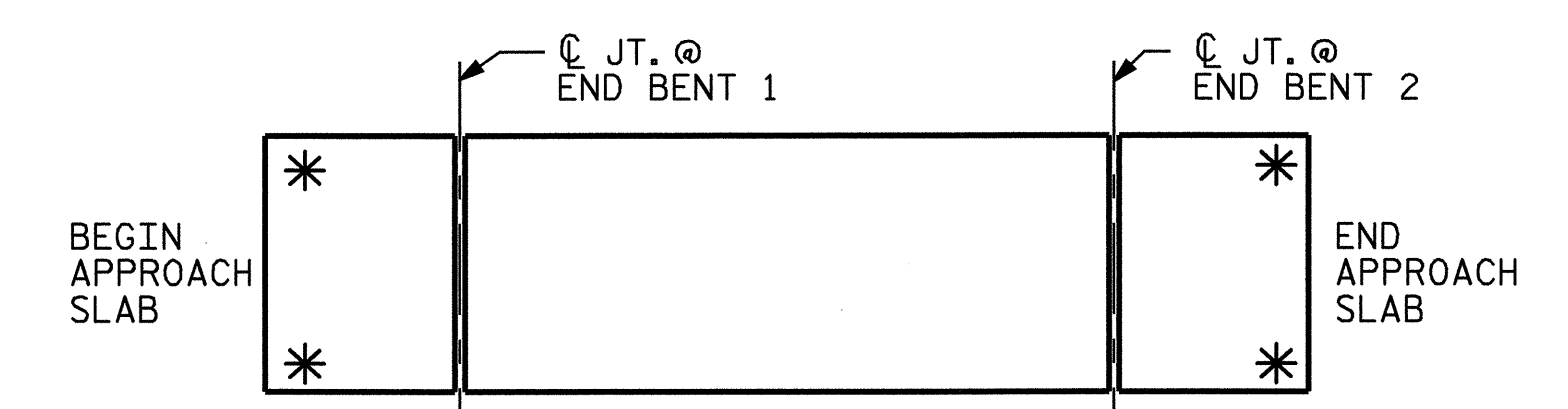

SKETCH SHOWING POINTS OF ATTACHMENT

* INDICATES POINTS OF ATTACHMENT

ASSEMBLED BY : T.L.CLELLAND DATE : 9/24/04
 CHECKED BY : T.A.HARRIS DATE : 9/24/04
 DRAWN BY : LES 8/01 REV. 5/7/03R RWW/JTE
 CHECKED BY : RDR 8/01



PROJECT NO. B-3866
 LENOIR/GREENE COUNTY
 STATION: 19+21.50 -L-

SHEET 2 OF 3

REVISIONS						SHEET NO.	
NO.	BY:	DATE:	NO.	BY:	DATE:	S-18	
1			3			TOTAL SHEETS	
2			4			19	