

PLAN OF LEFT WING (W1)

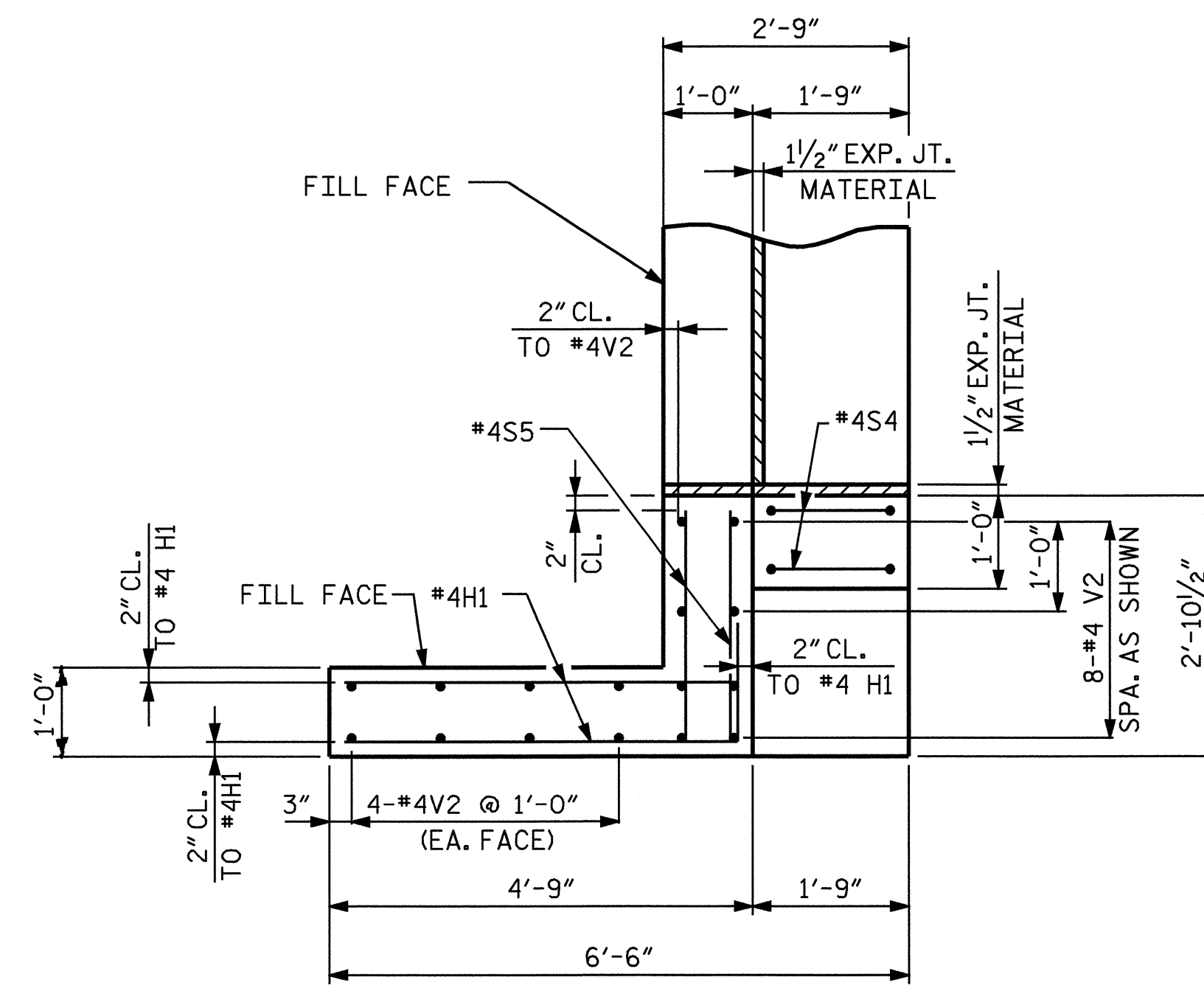

PLAN OF RIGHT WING (W2)

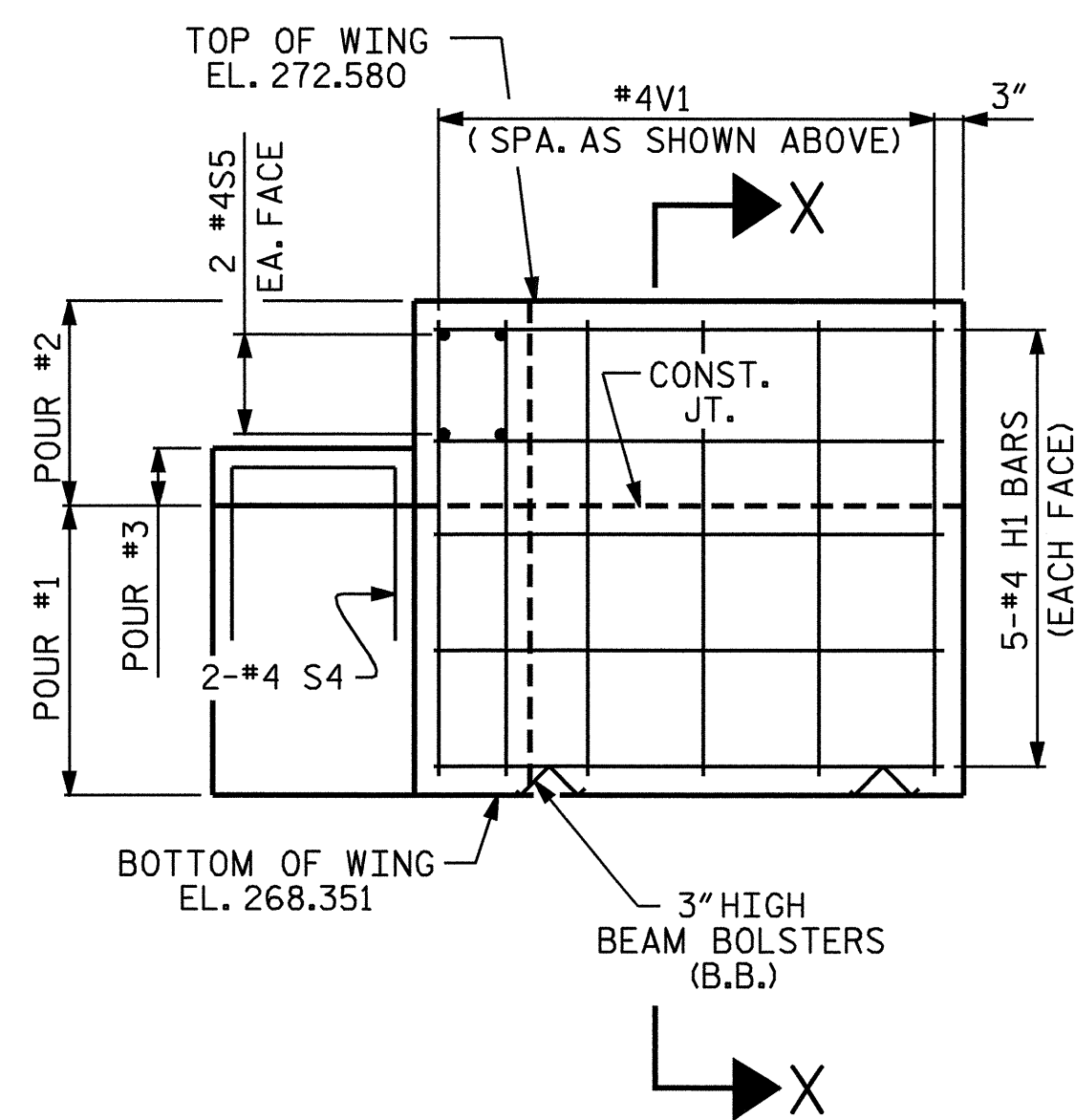

ELEVATION OF LEFT WING (W1)

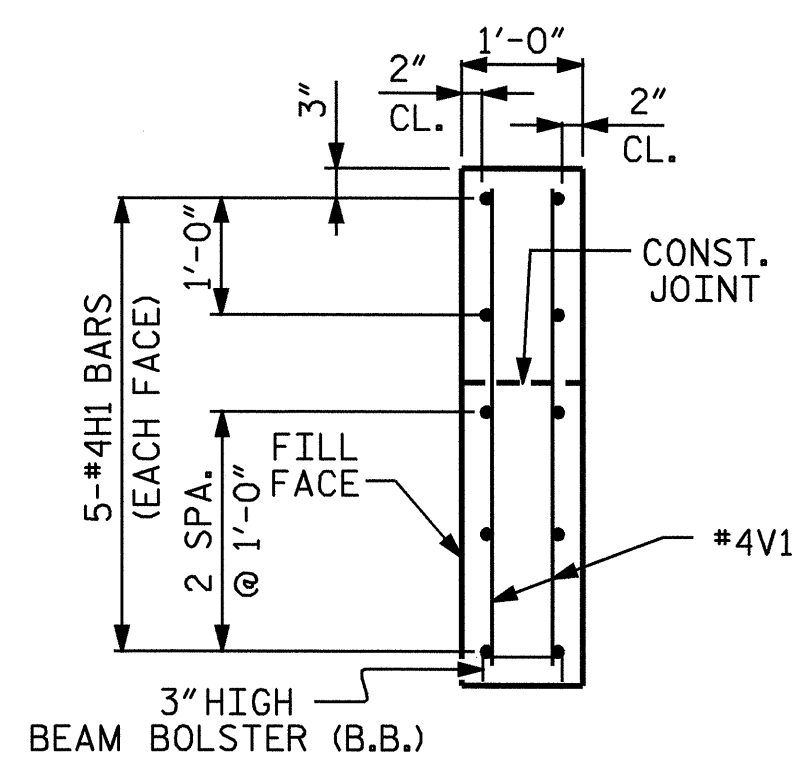

SECTION X-X

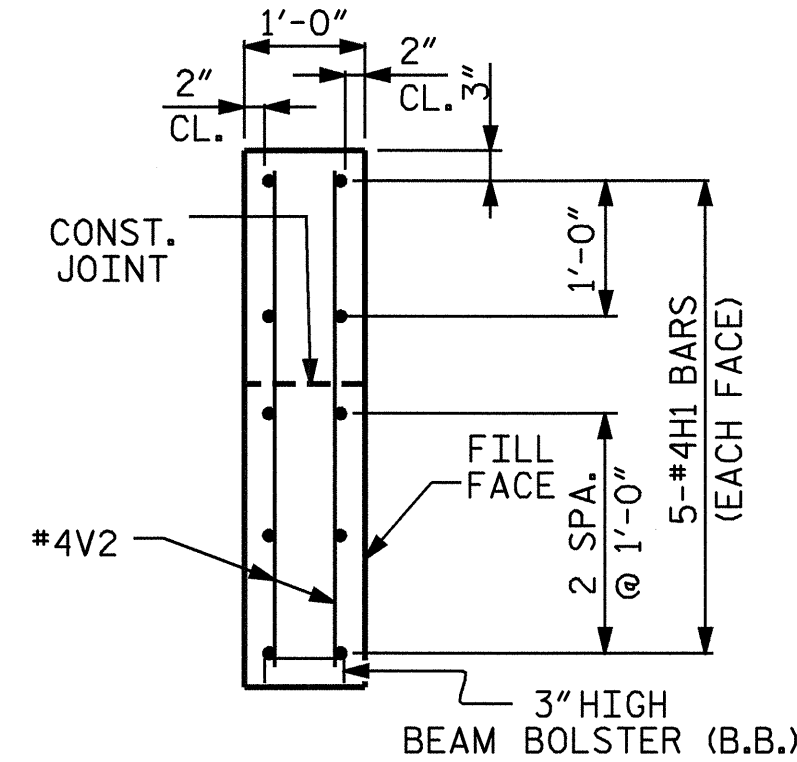

SECTION Y-Y

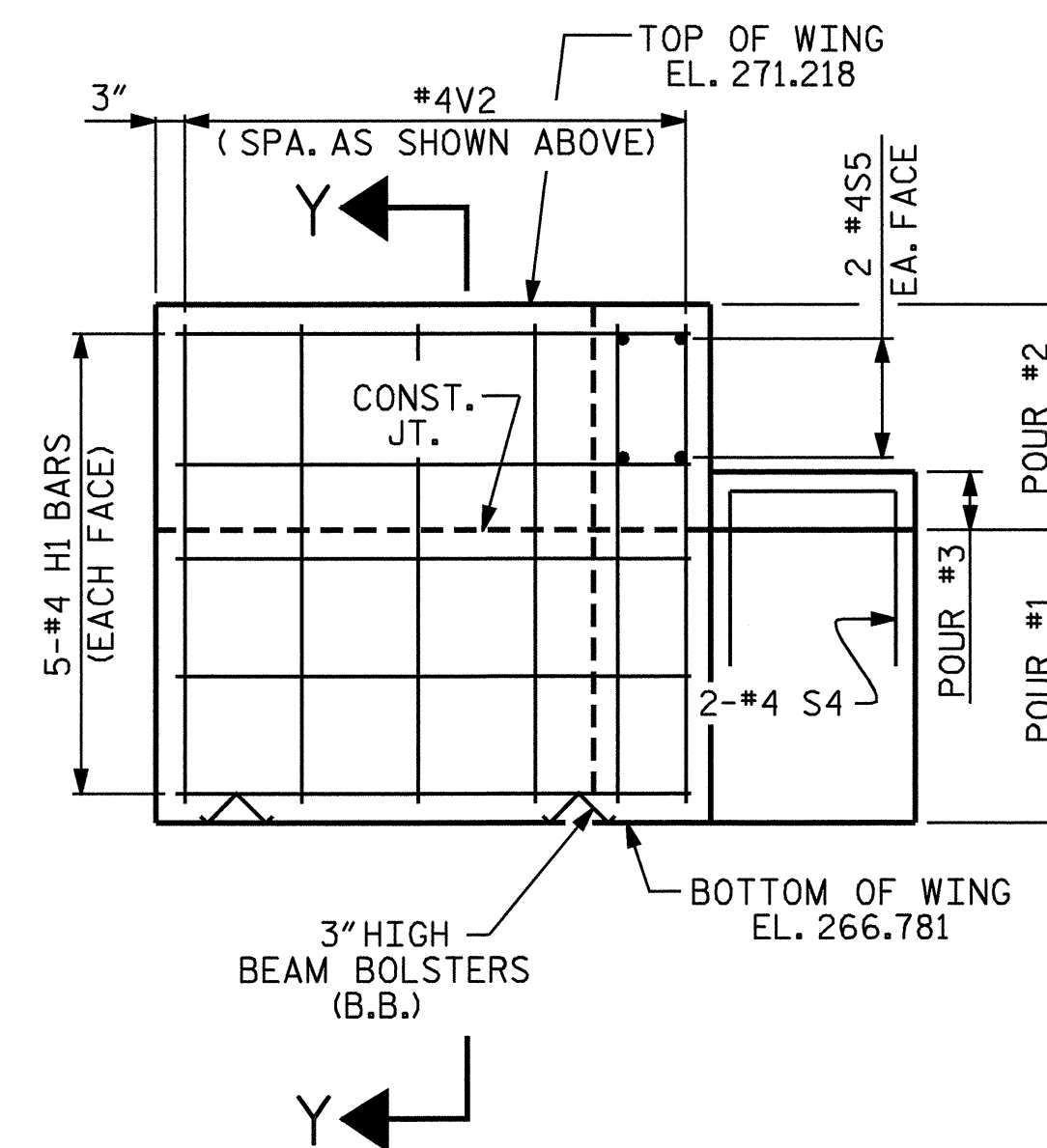

ELEVATION OF RIGHT WING (W2)

PROJECT NO. B-3703
WAKE COUNTY
 STATION: 18+17.85 -L-

SHEET 2 OF 3
 STATE OF NORTH CAROLINA
 DEPARTMENT OF TRANSPORTATION
 RALEIGH
 SUBSTRUCTURE
 END BENT #1

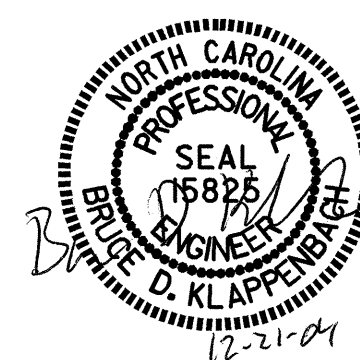

DRAWN BY: M. G. SHAIKH DATE: 10-21-04
 CHECKED BY: D. A. GLADDEN DATE: 10-26-04

REVISIONS						SHEET NO.	
NO.	BY:	DATE:	NO.	BY:	DATE:	S-15	
1			3			TOTAL SHEETS	
2			4			27	