

# BR-0004 INDEX OF CROSS SECTIONS

<u>LINE</u>	<u>SHEET NO.</u>
-L-	X-2 TO X-24
-Y1-	X-25 TO X-28
-Y1A-	X-29 TO X-30
-Y1DET-	X-31 TO X-33

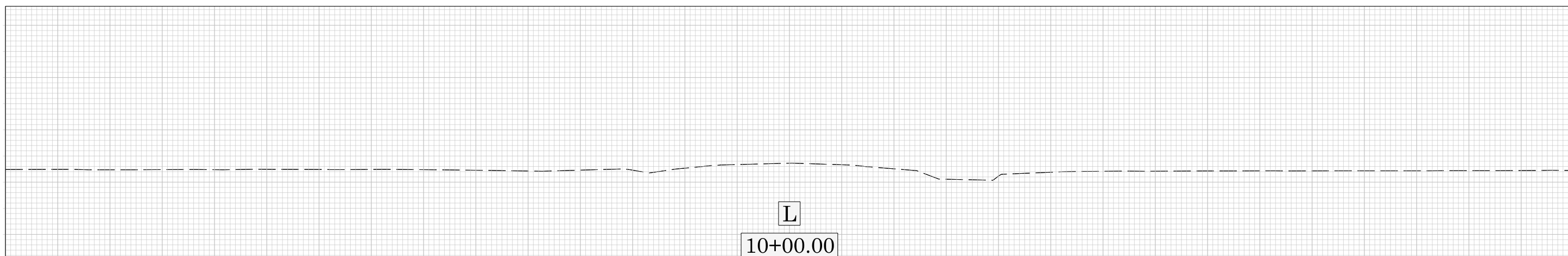

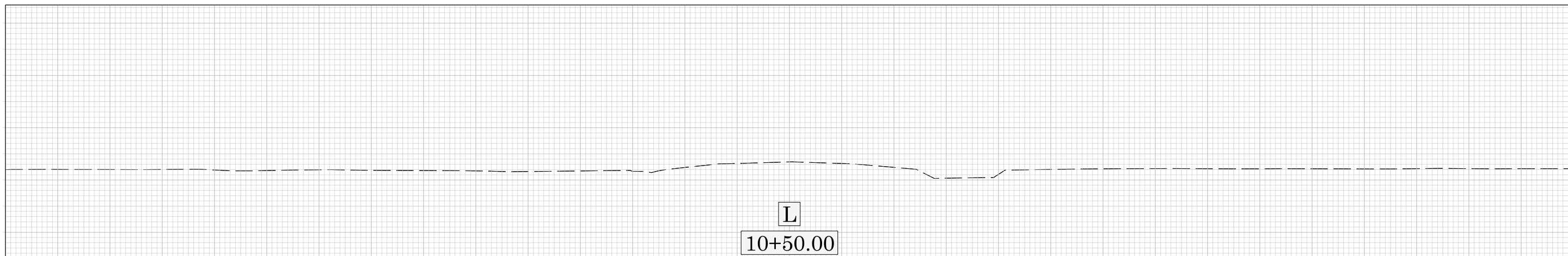
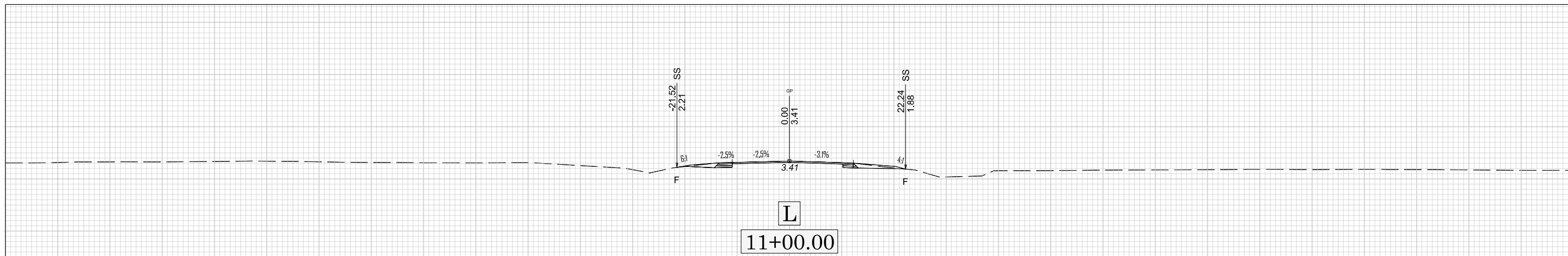

X 002

BR-0004

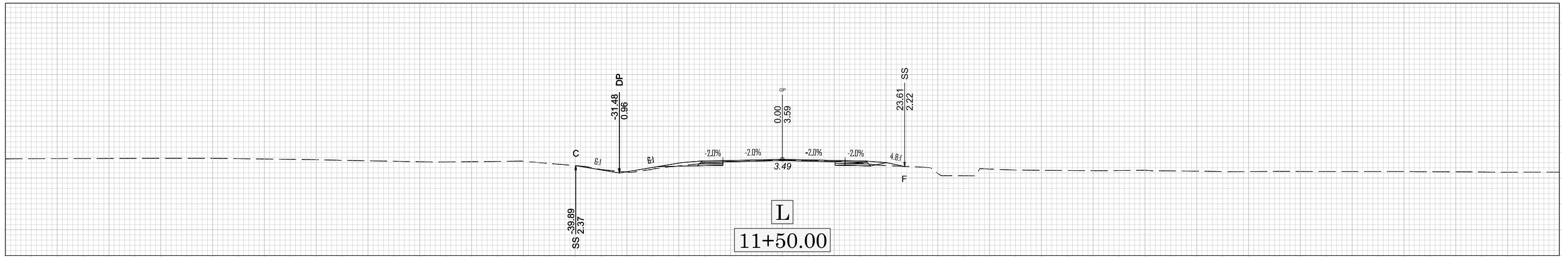
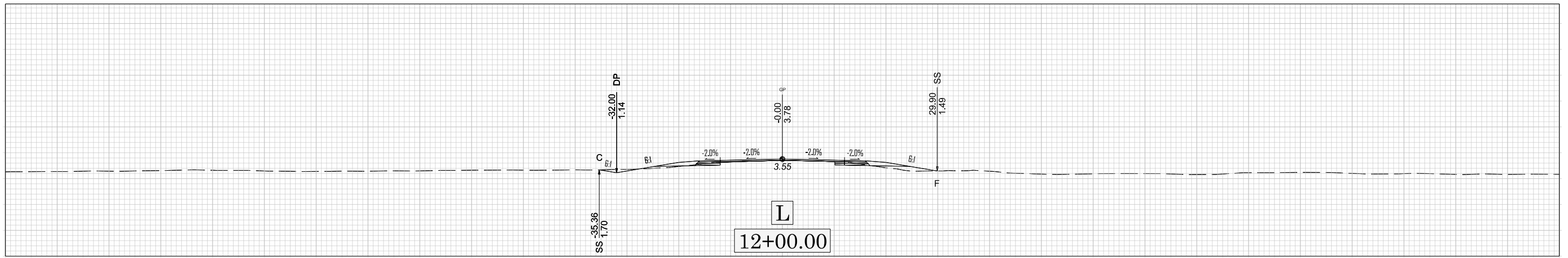
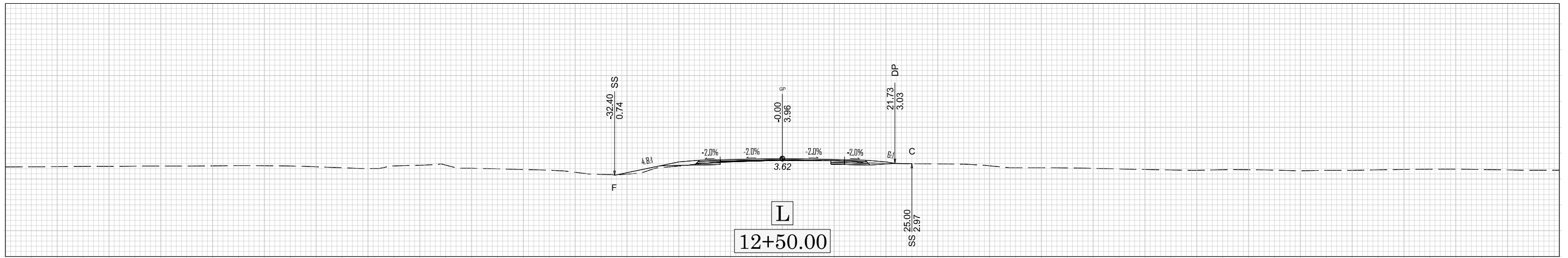

X 003

BR-0004

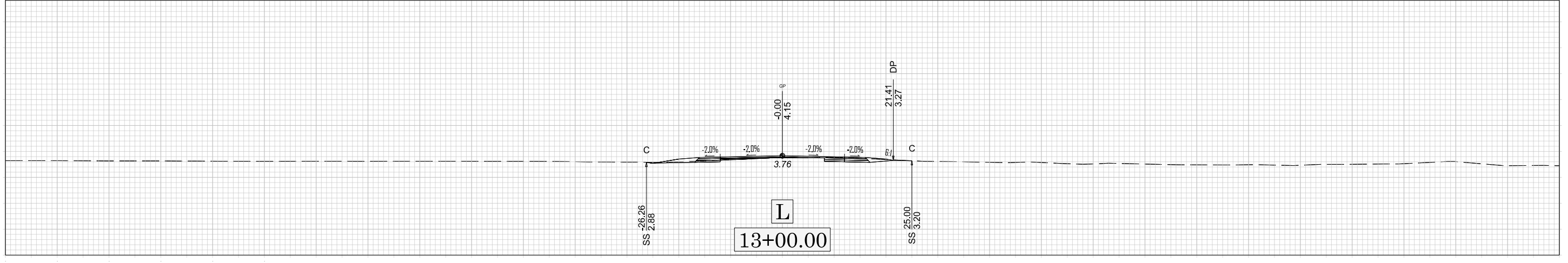
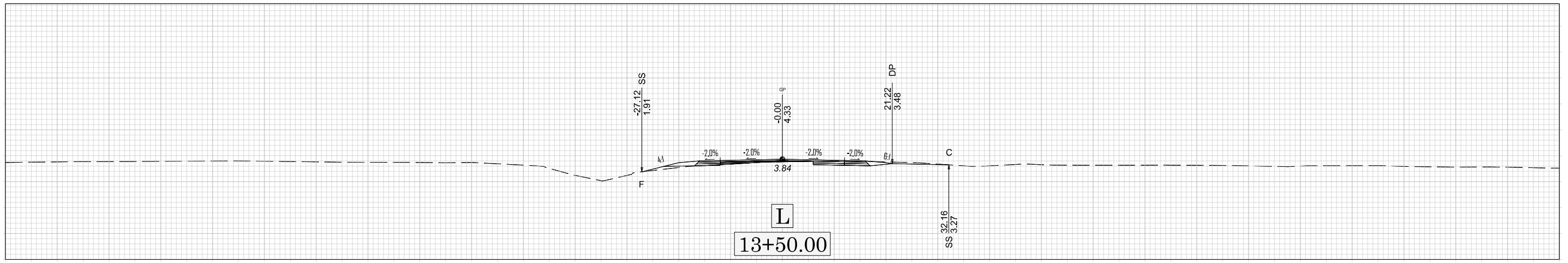
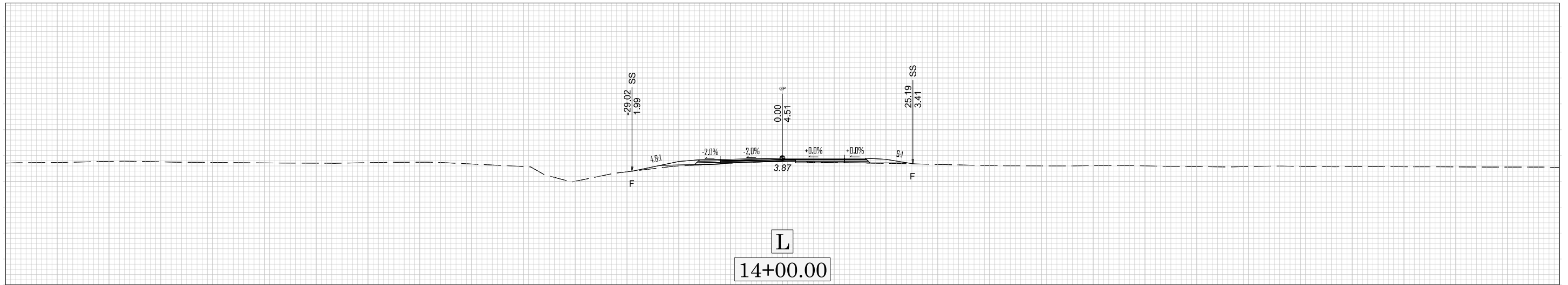

X 004

BR-0004

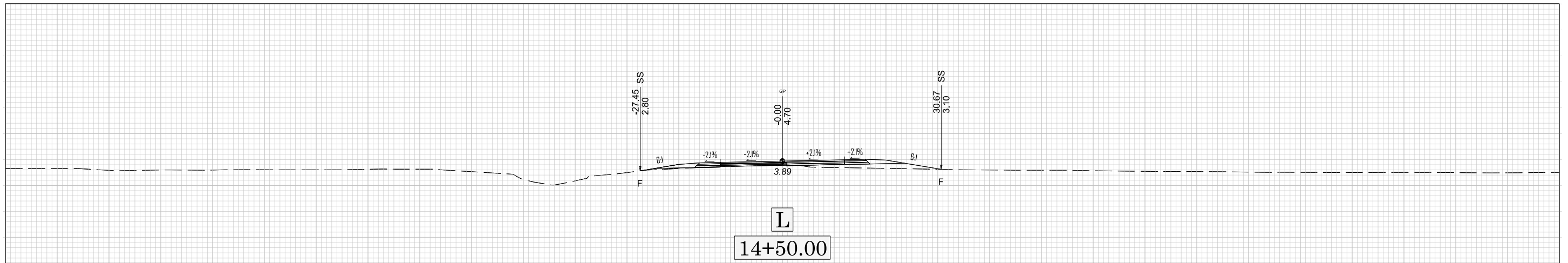
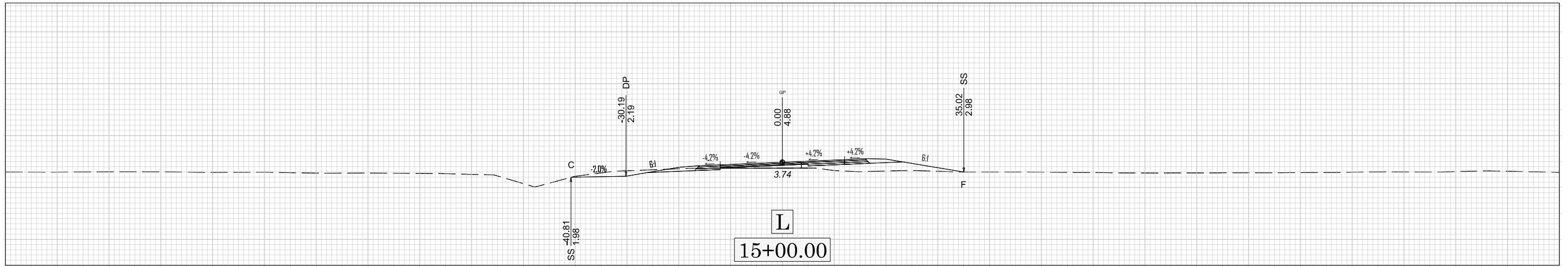
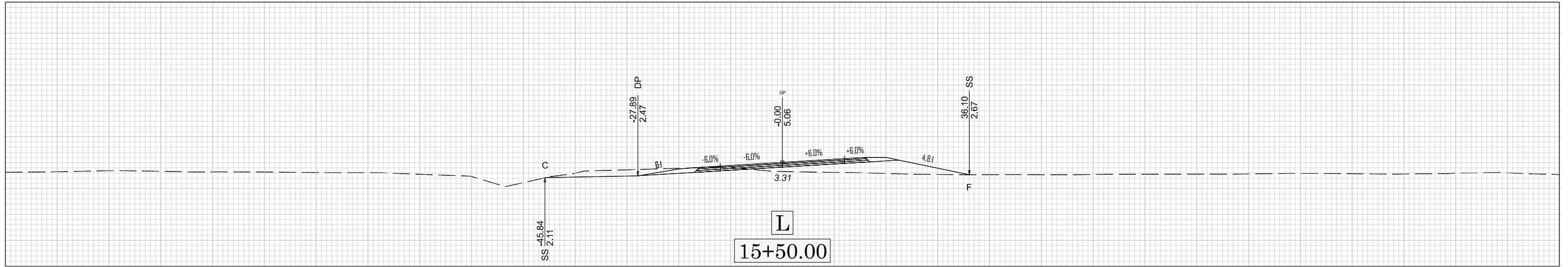

X 005

BR-0004

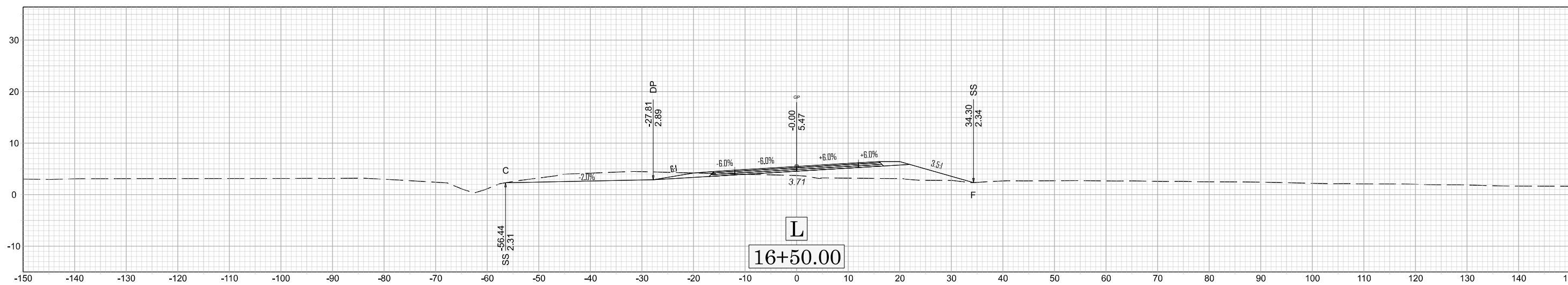
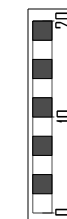
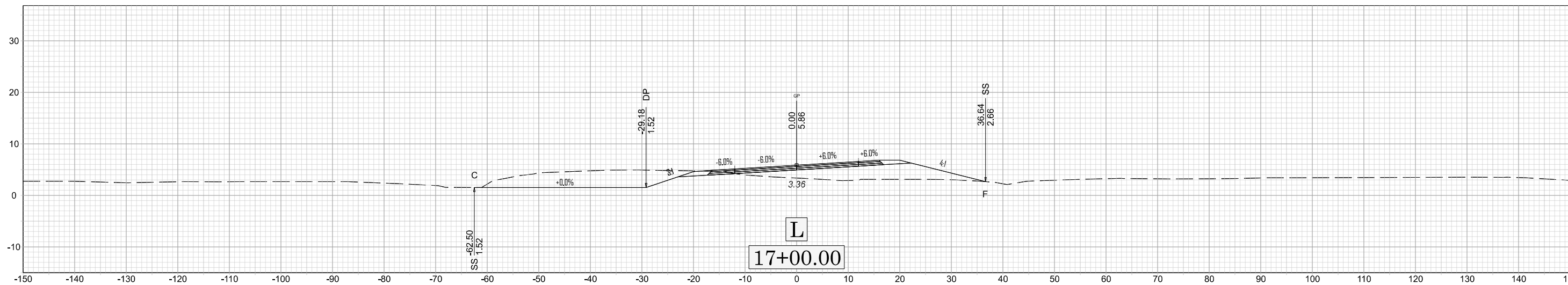

X 006

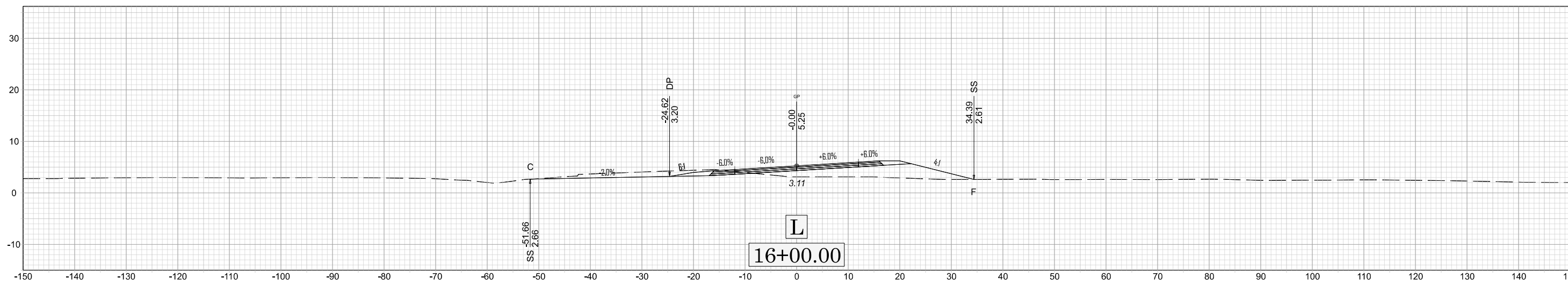

BR-0004

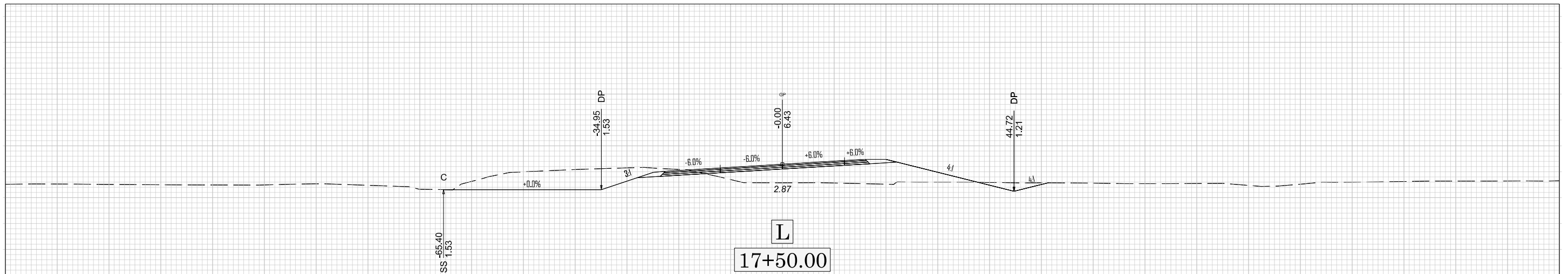
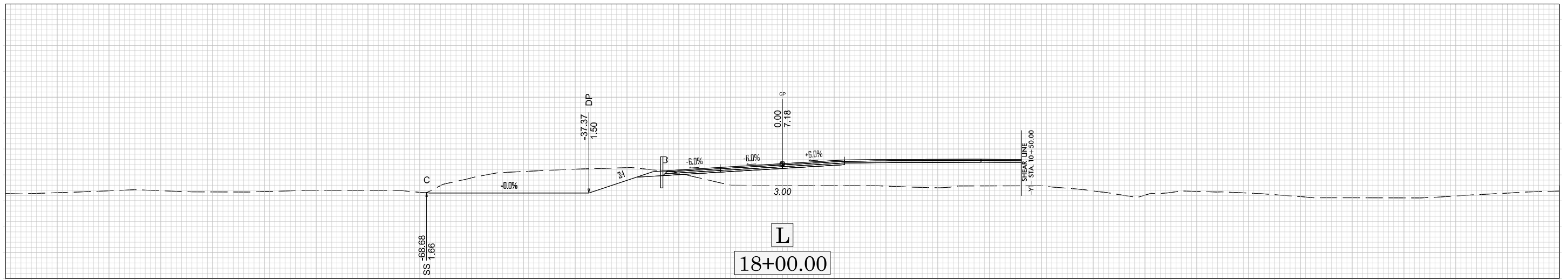
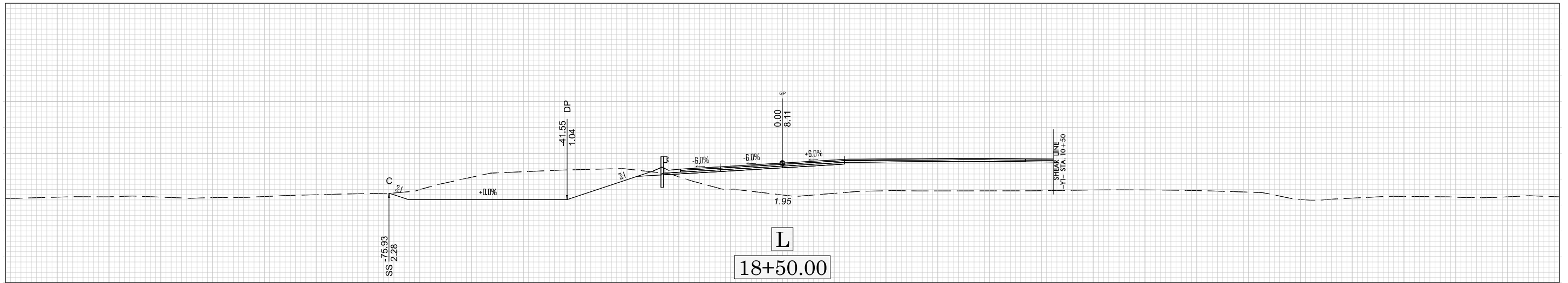

X 007

BR-0004

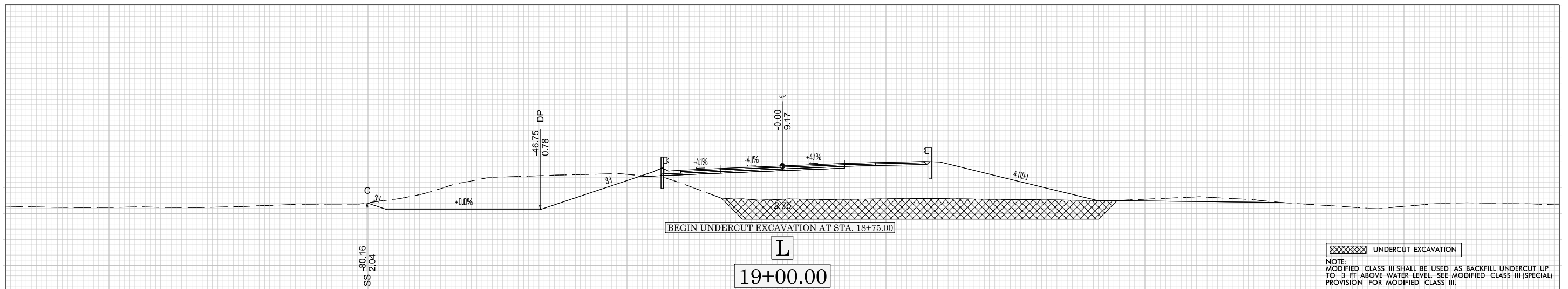
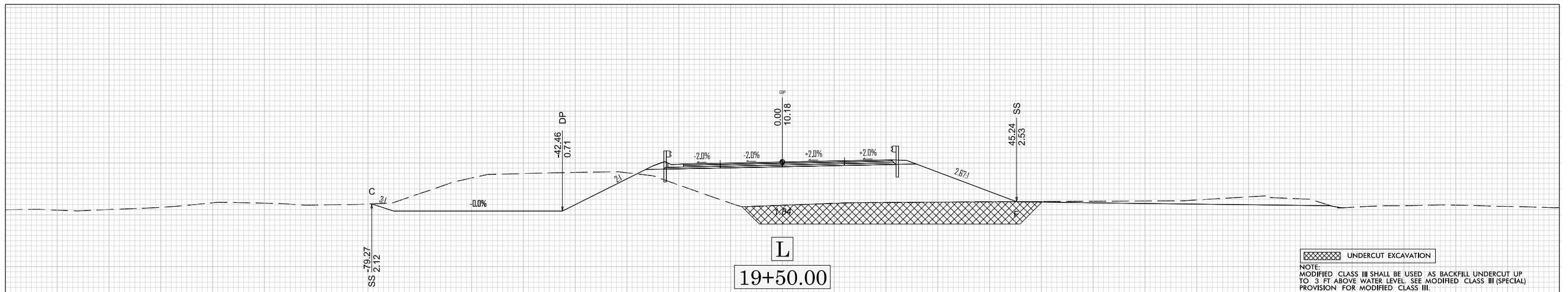
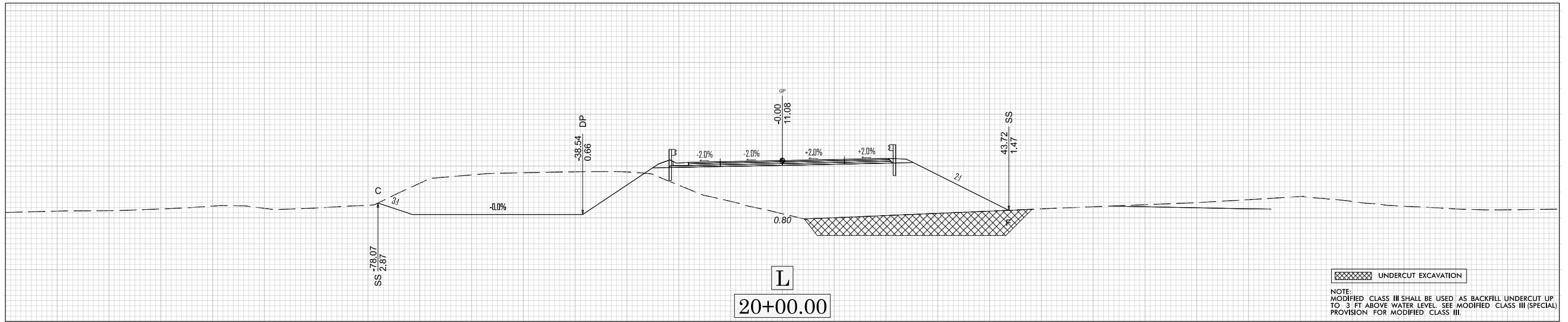

X 008

BR-0004

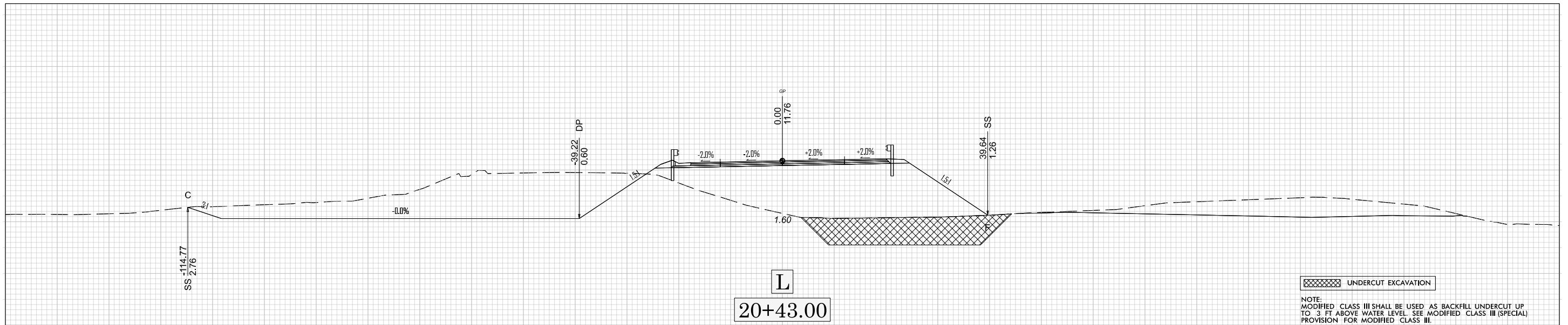
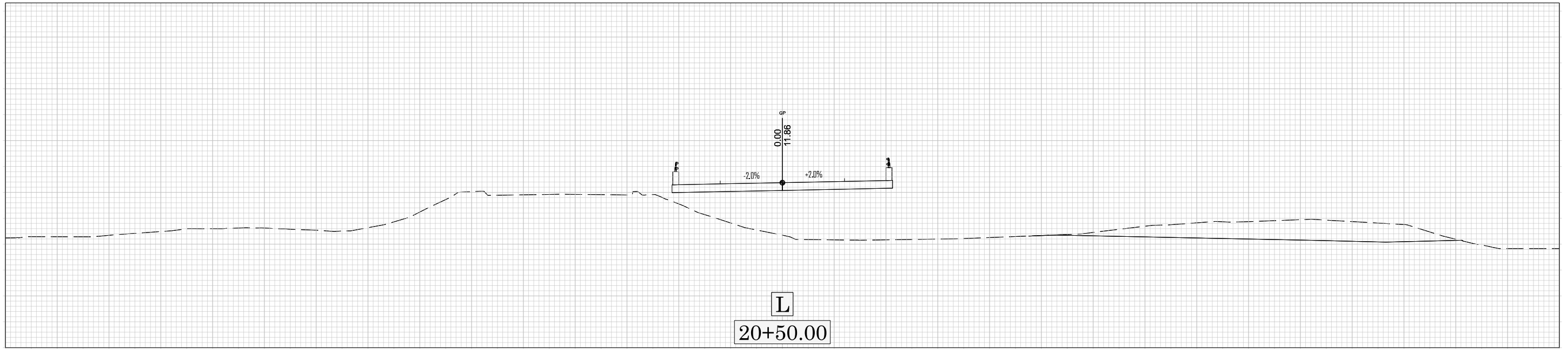

X 009

BR-0004

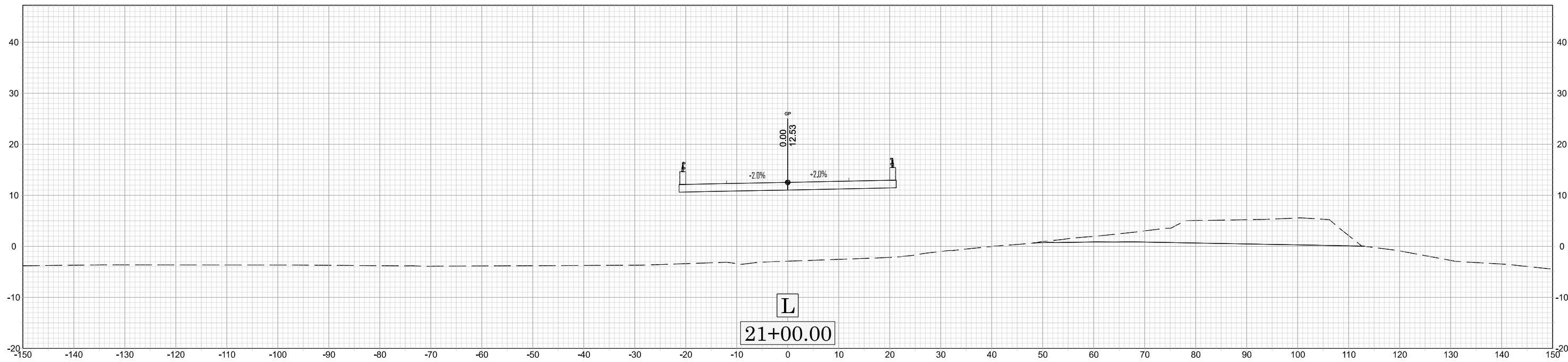
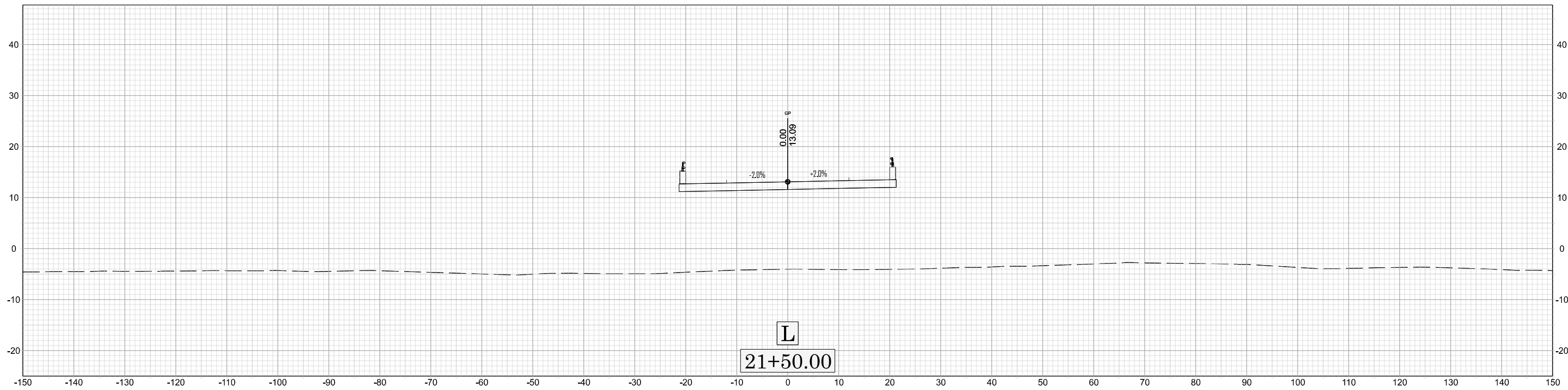

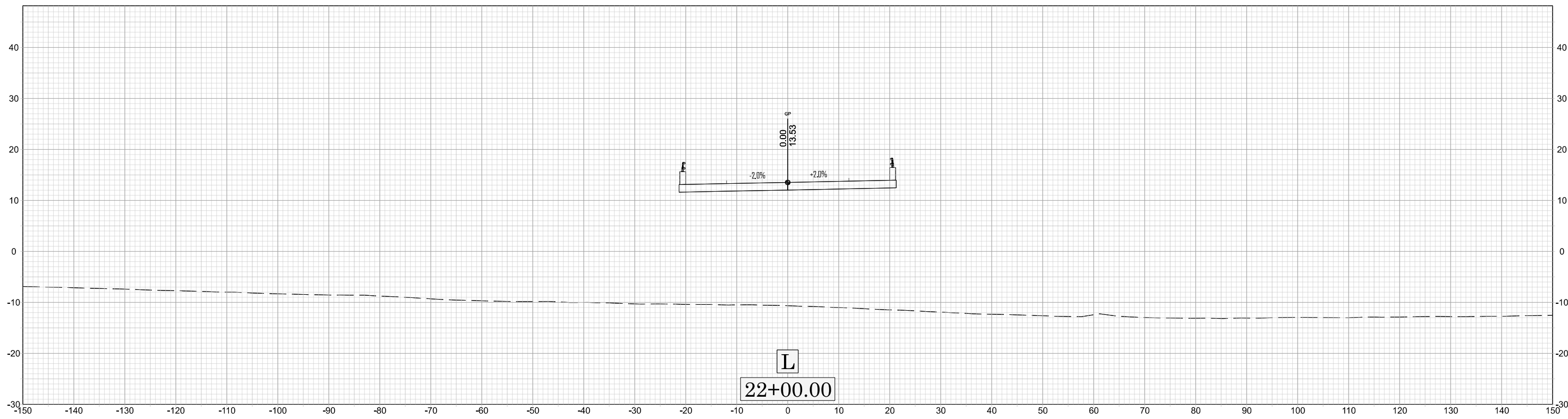
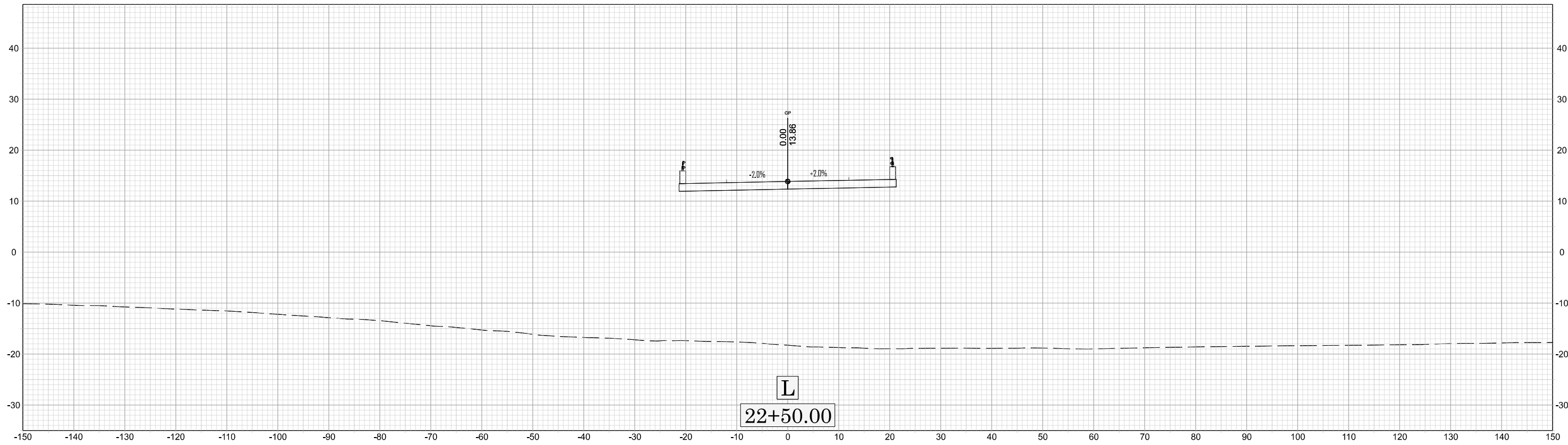

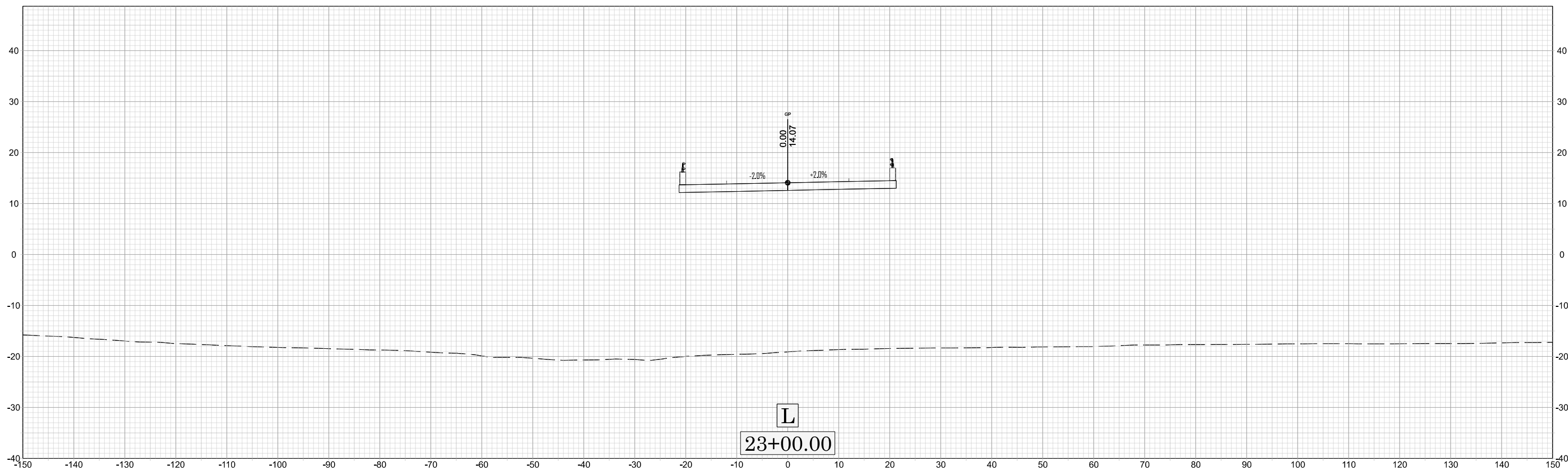
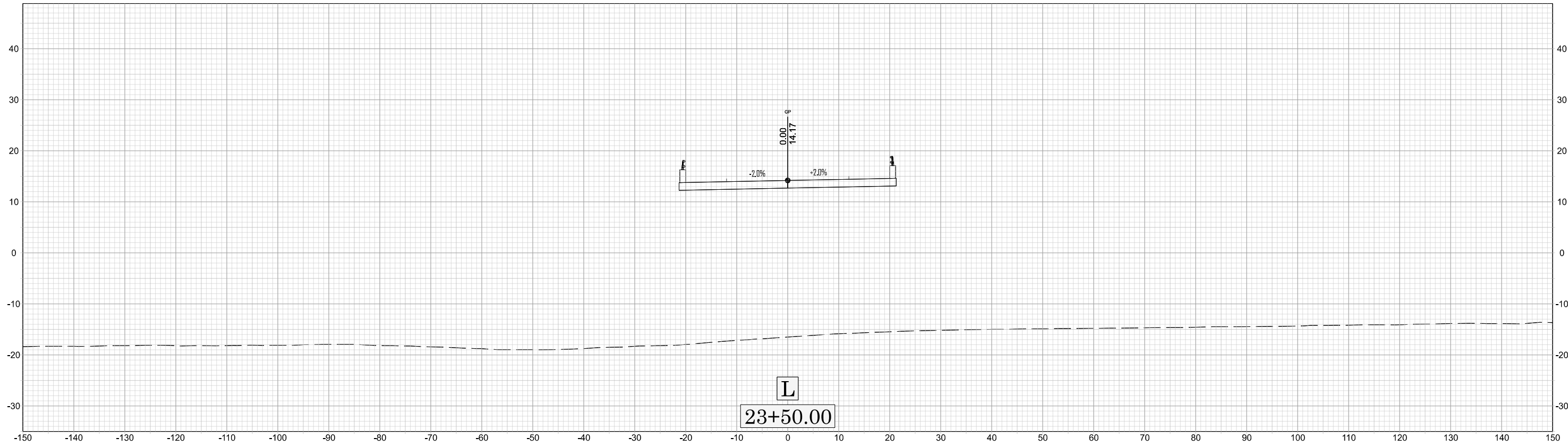

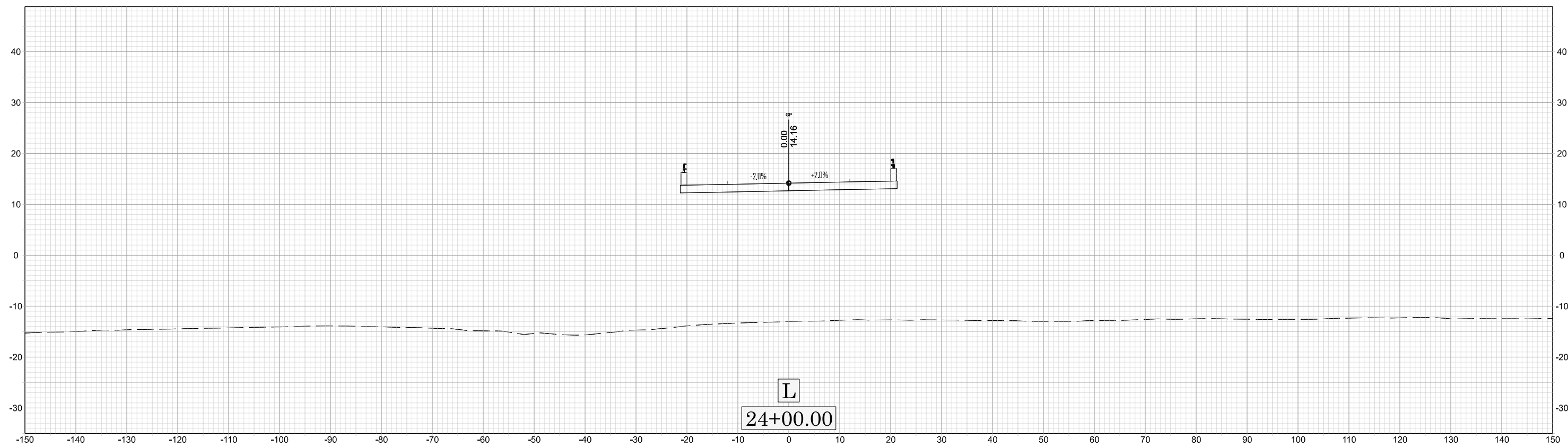
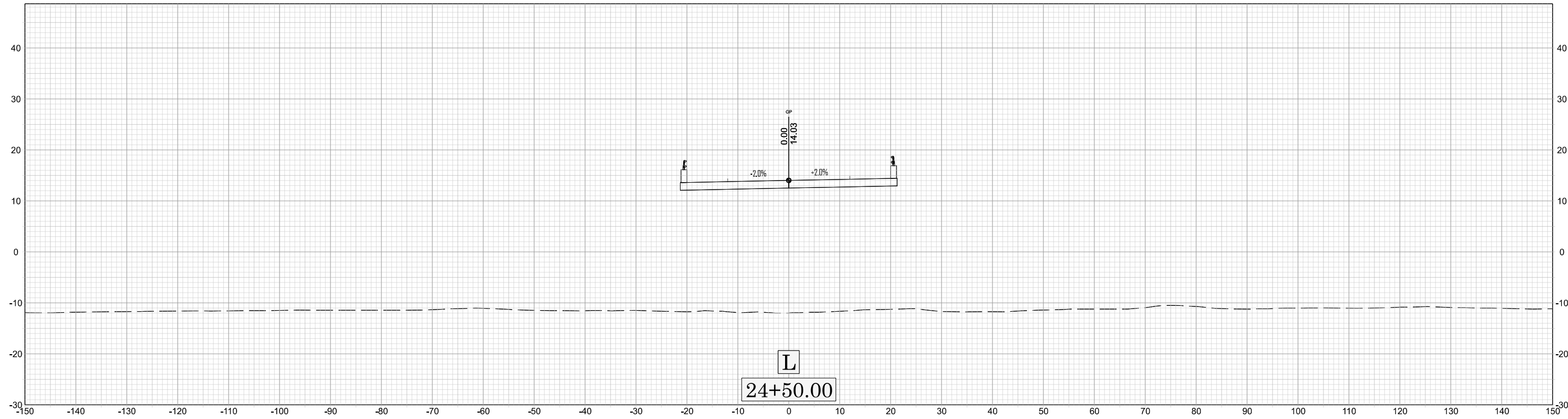

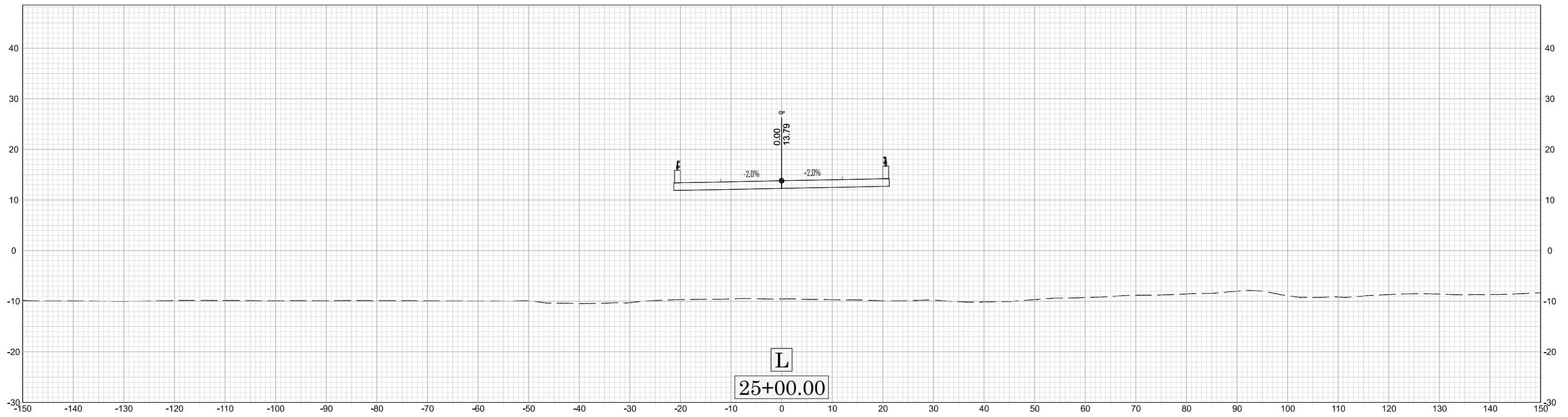
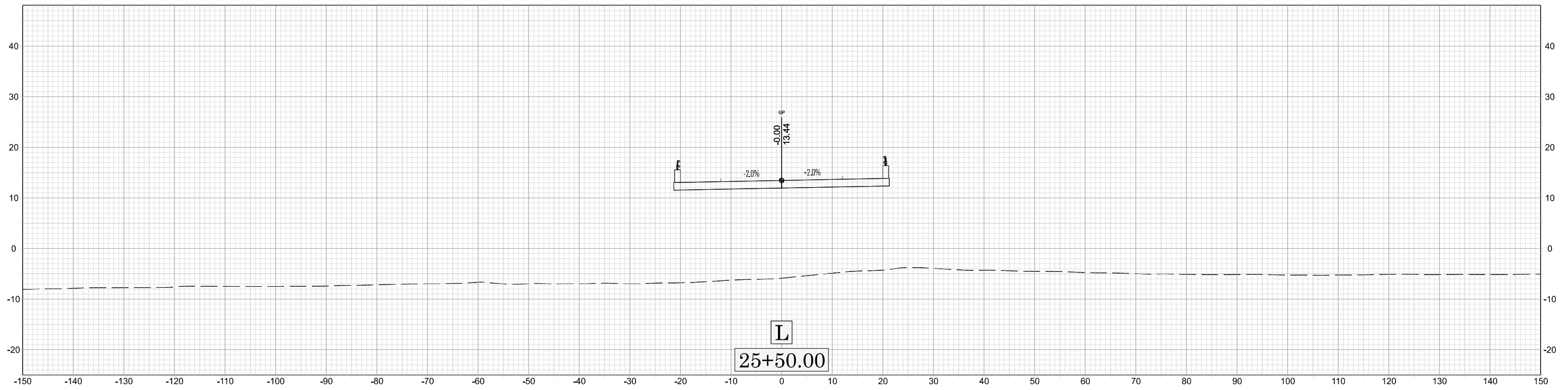

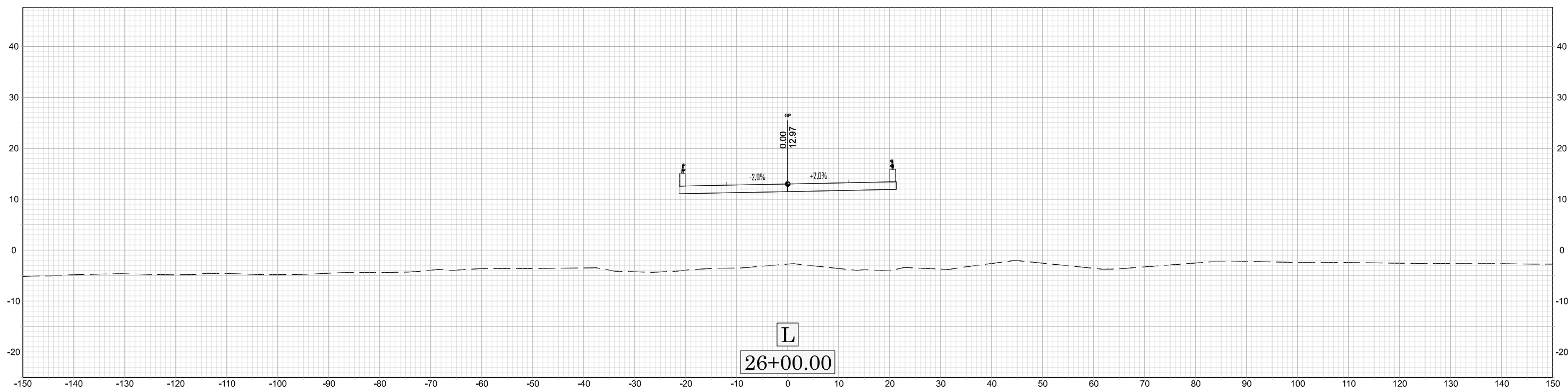
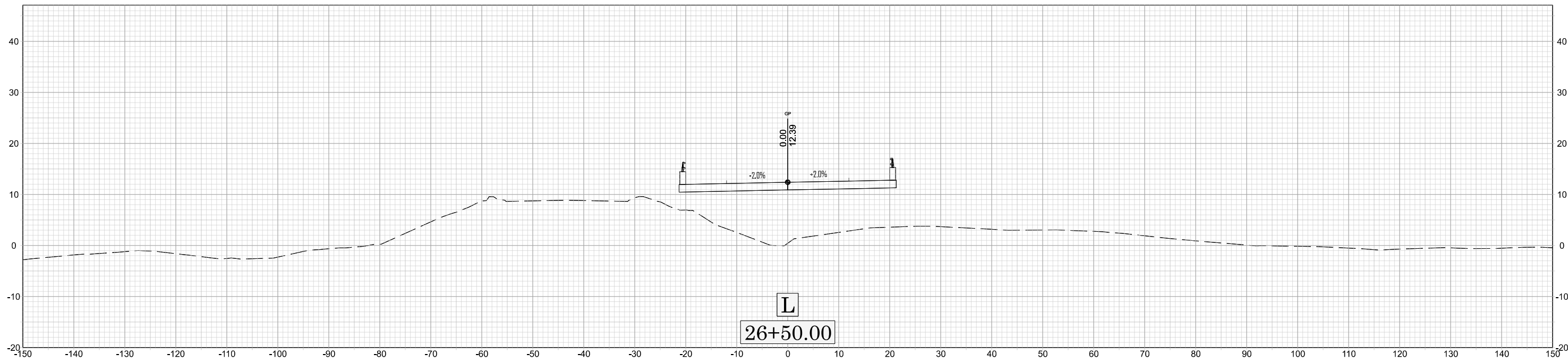

X 015

BR-0004

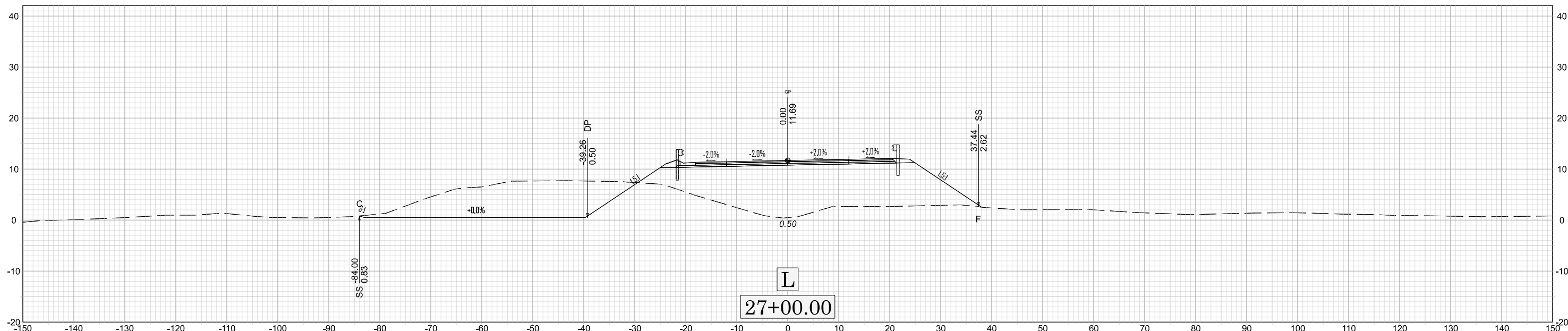
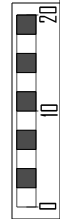
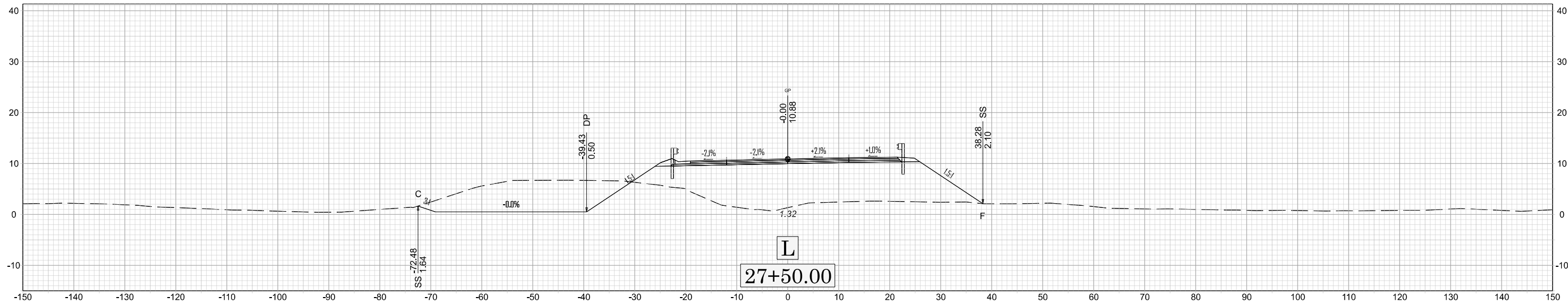

X 016

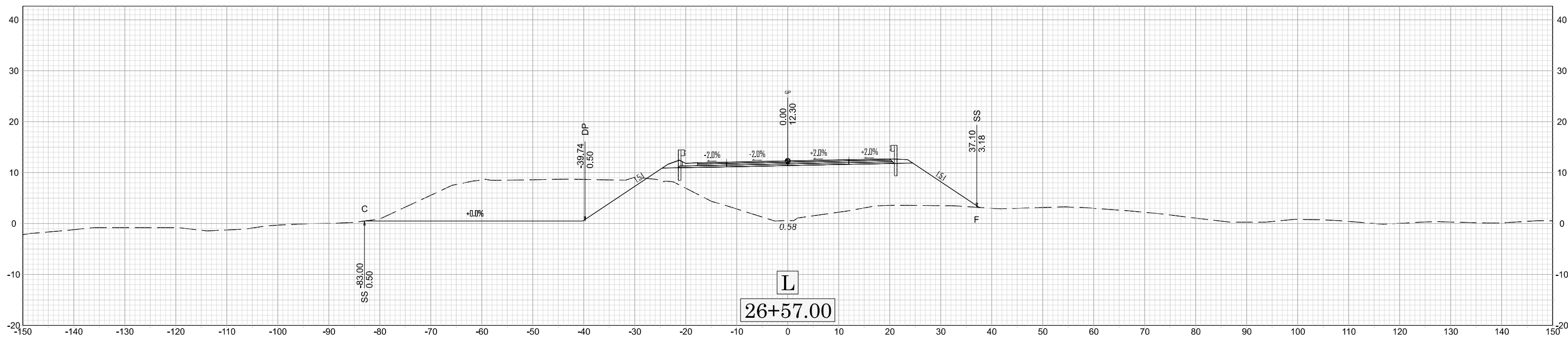

BR-0004

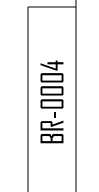
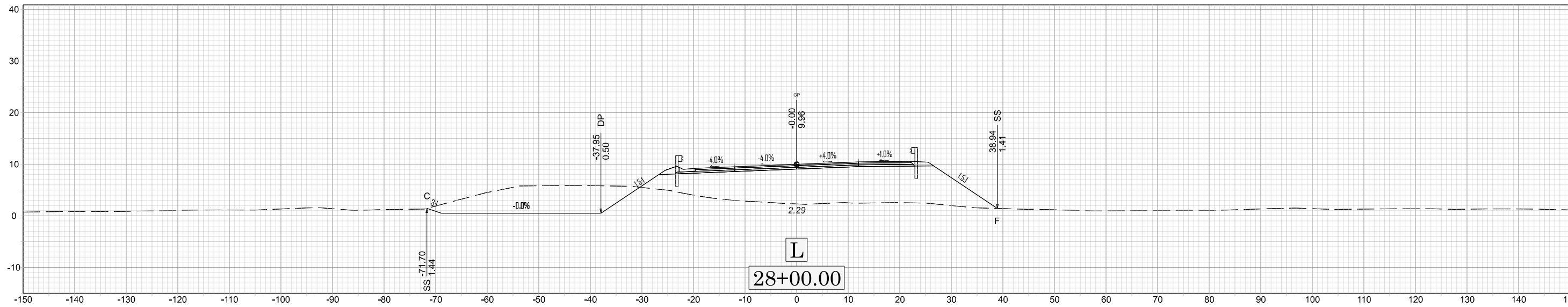
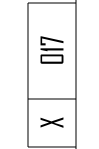
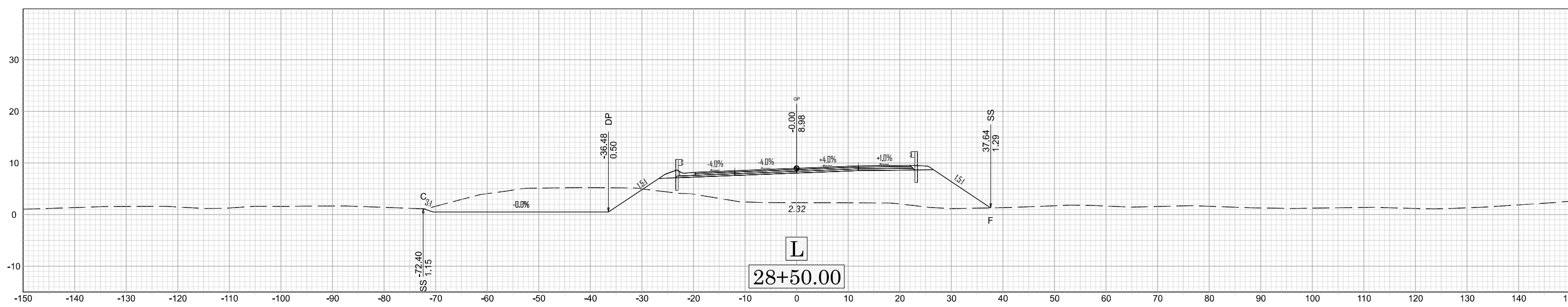
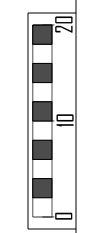
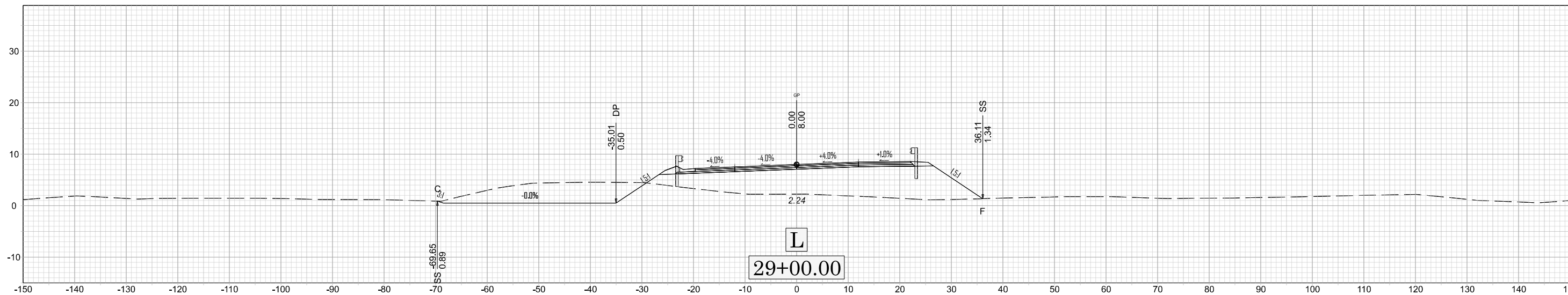

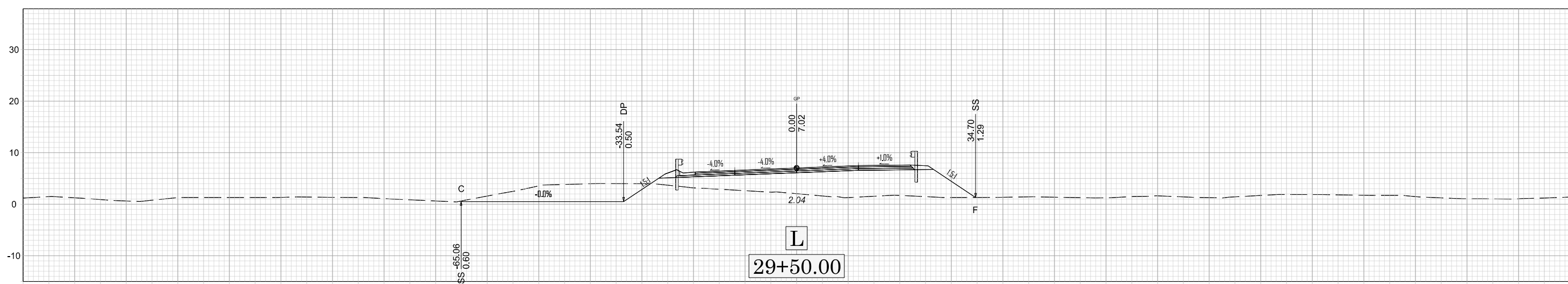
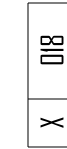
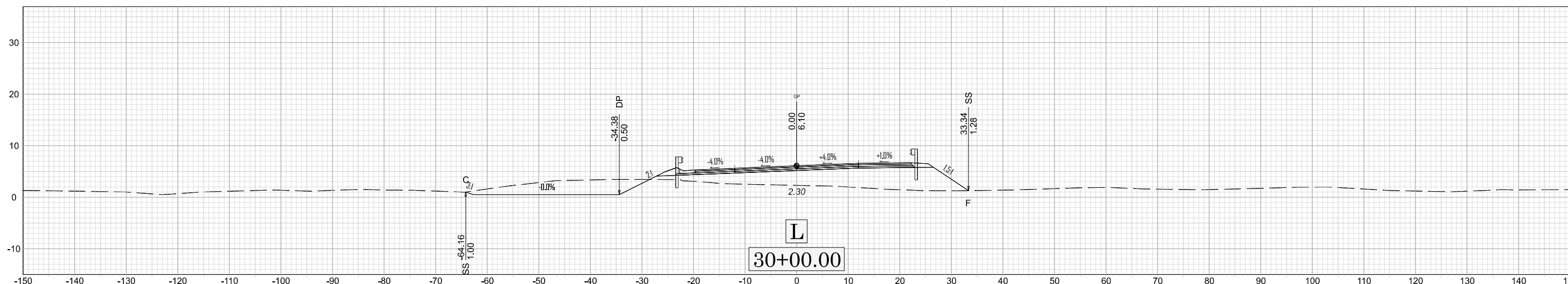
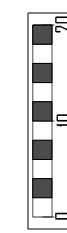
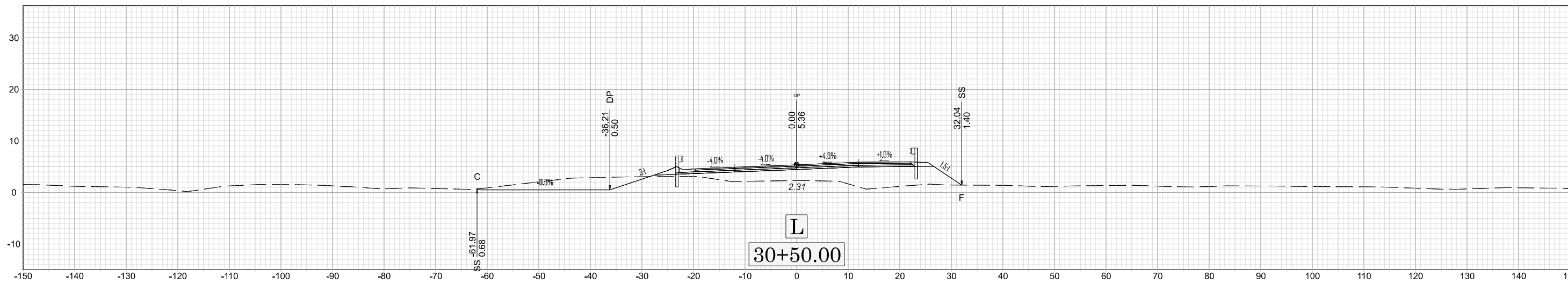

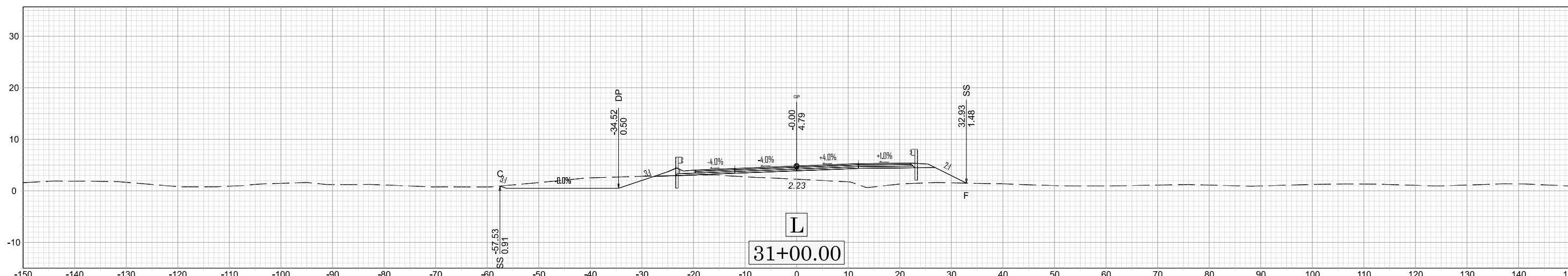
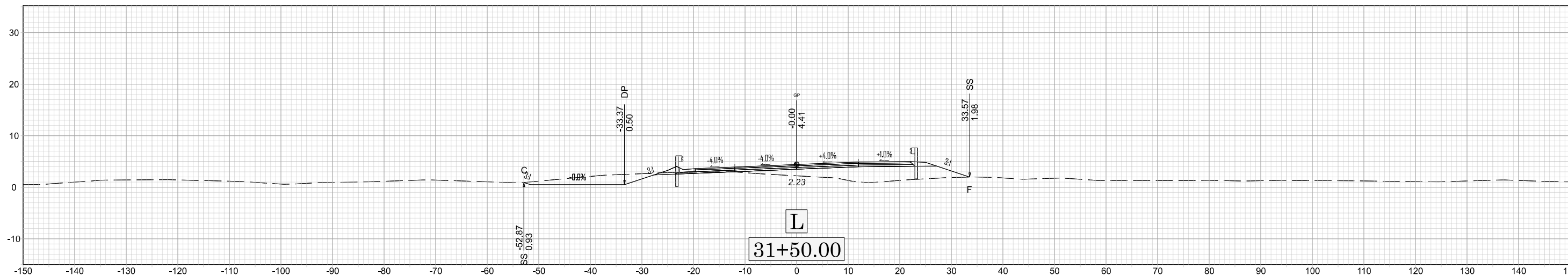
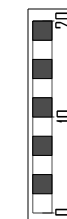
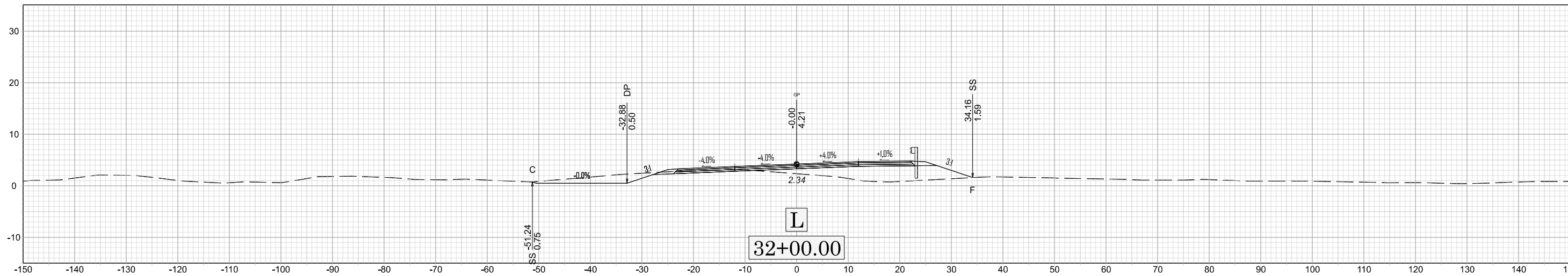

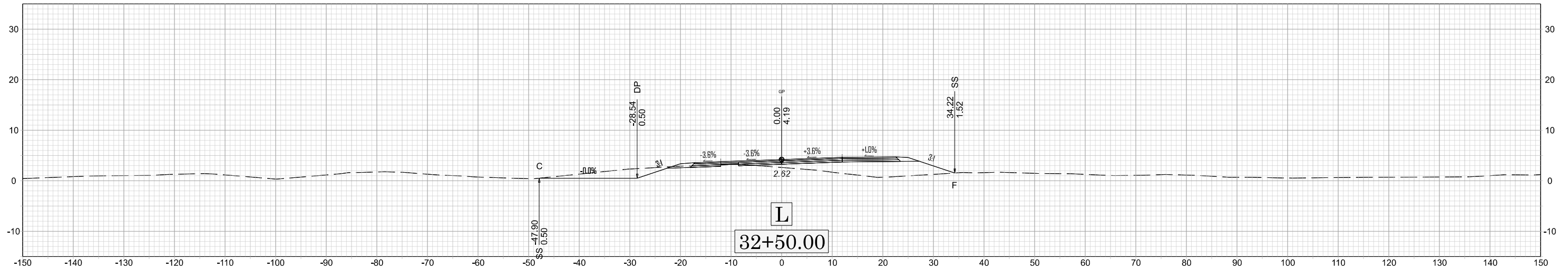
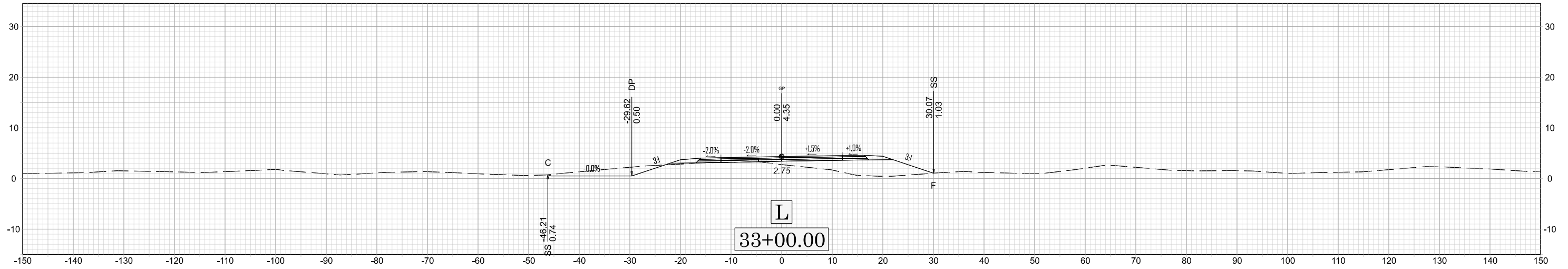
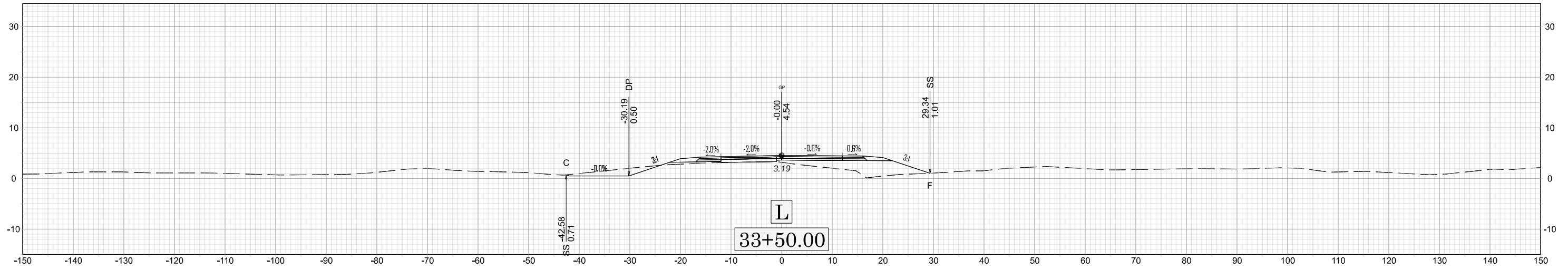

X 020

BR-0004

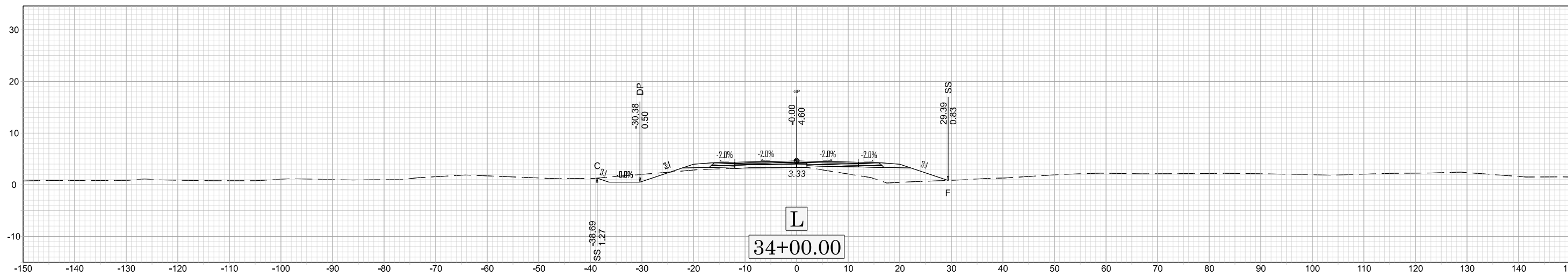
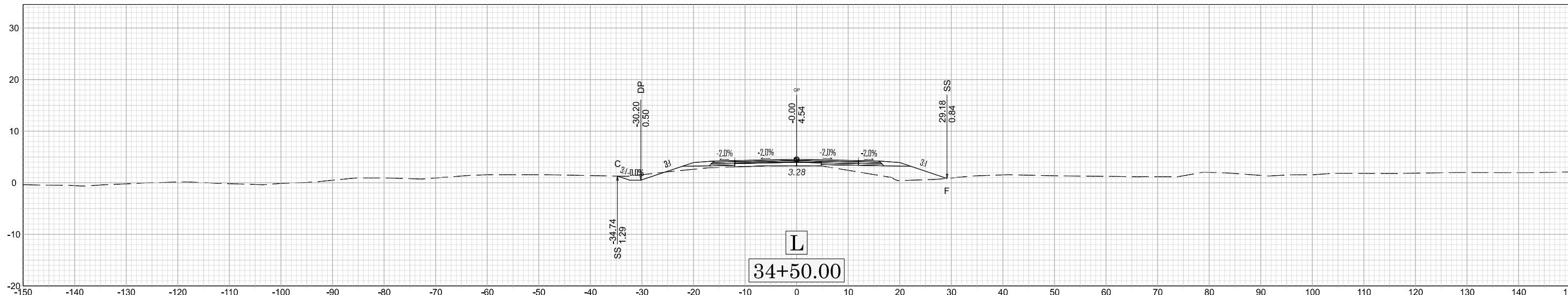
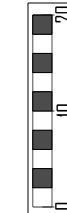
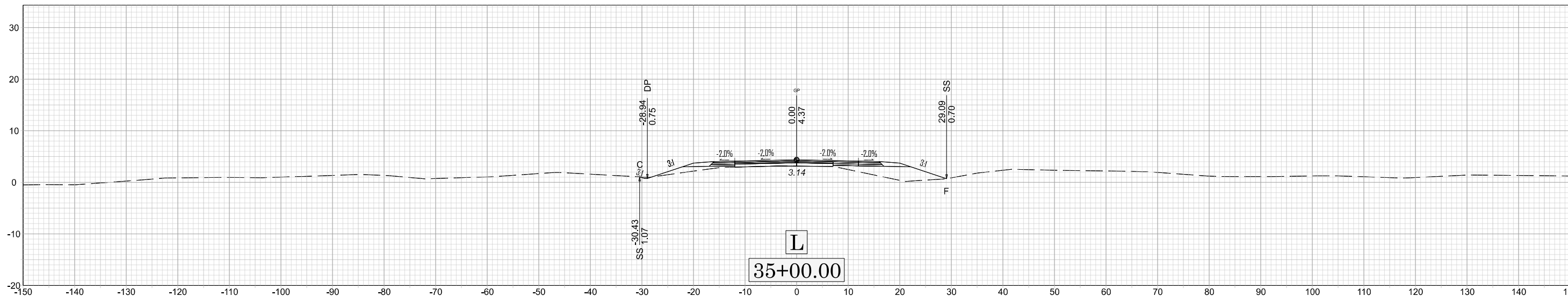

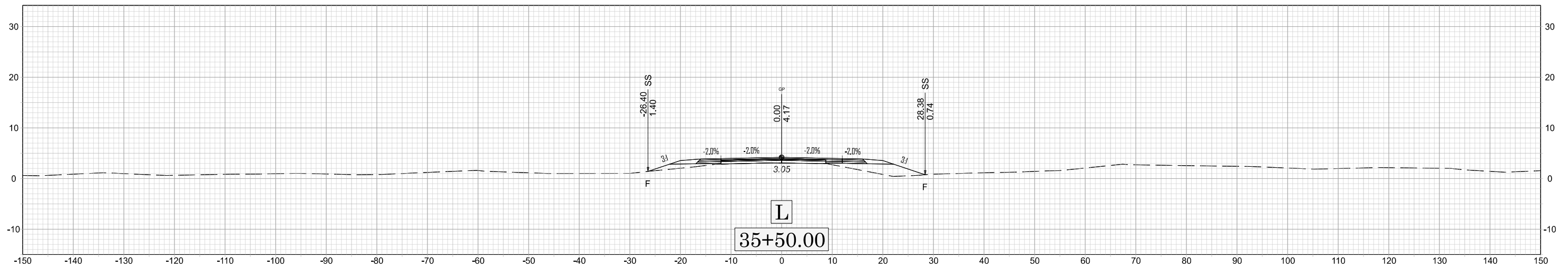
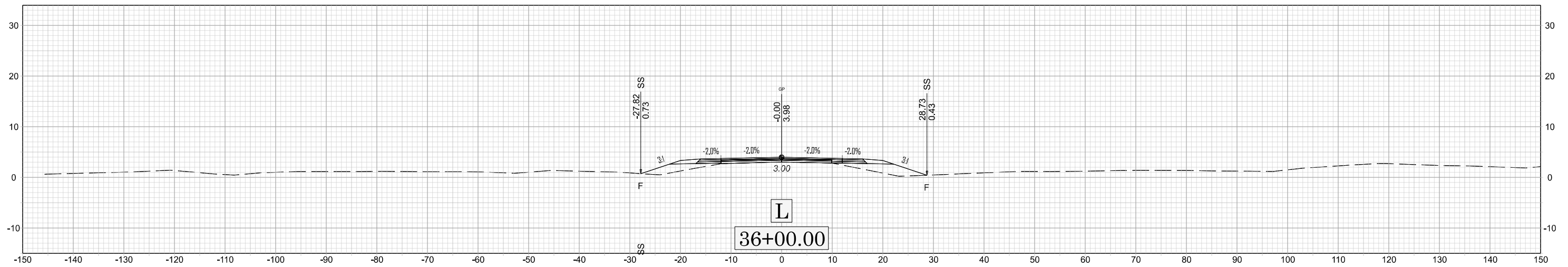
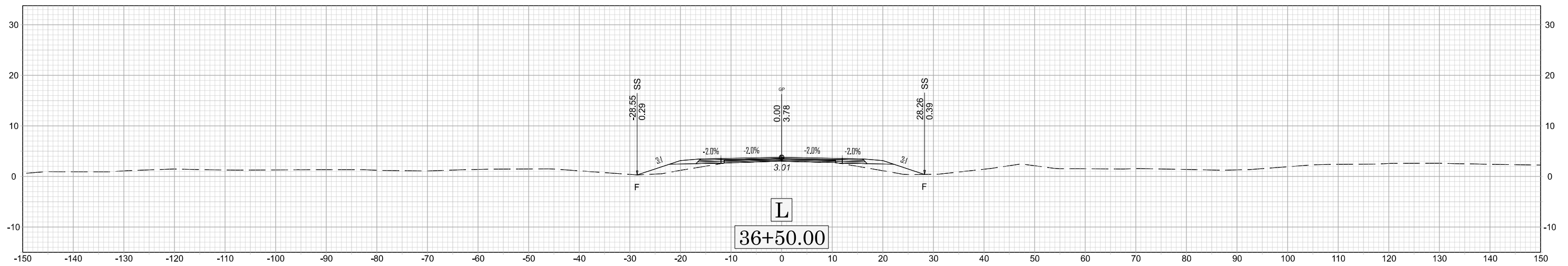

X 022

BR-0004

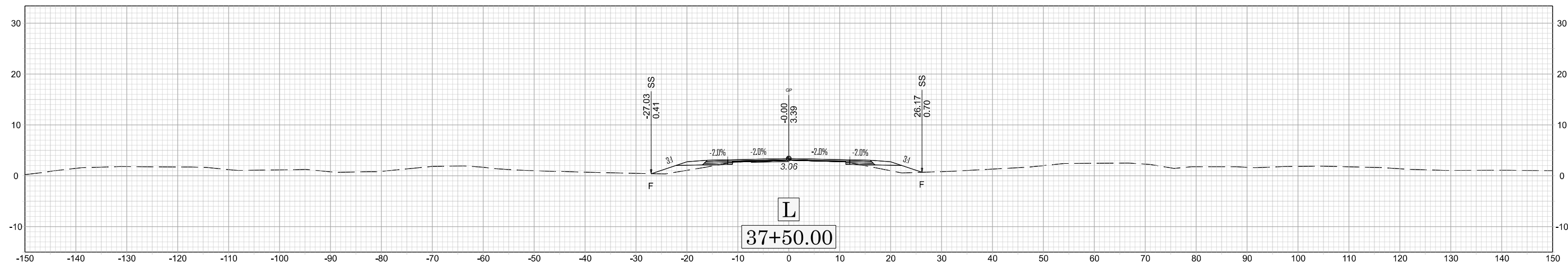
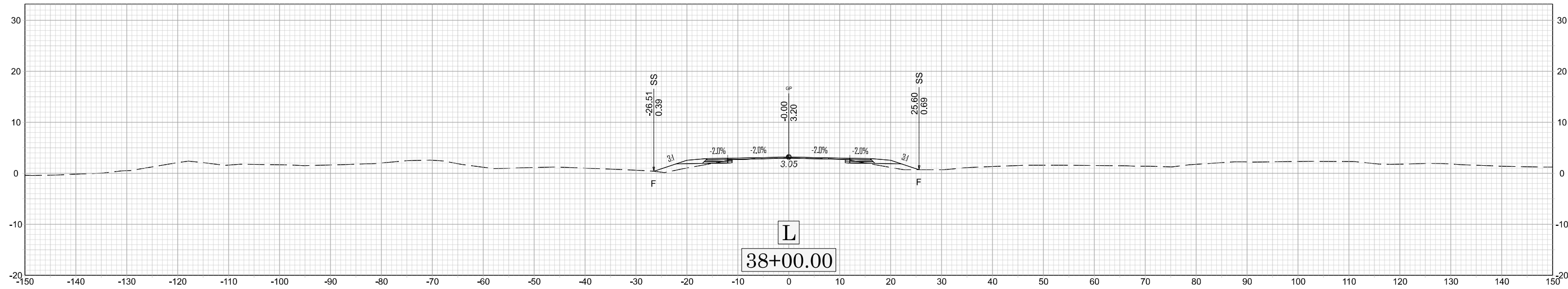

X 023

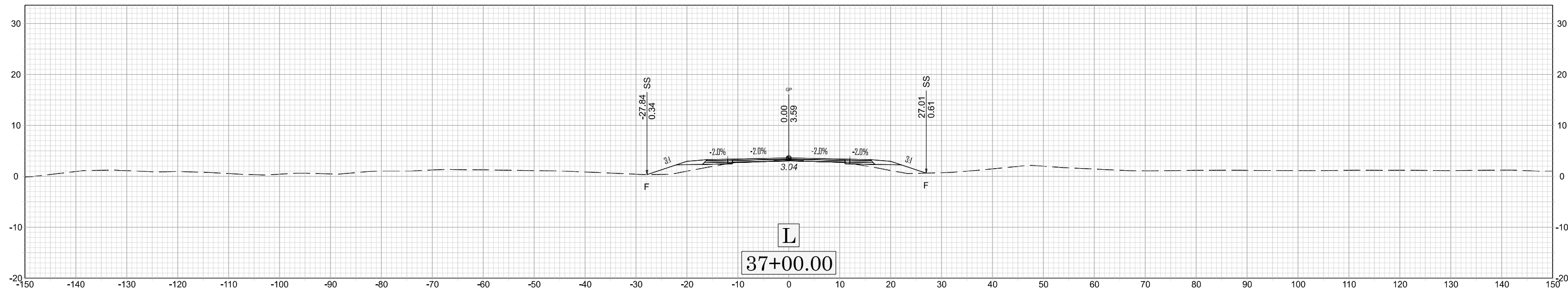

BR-0004

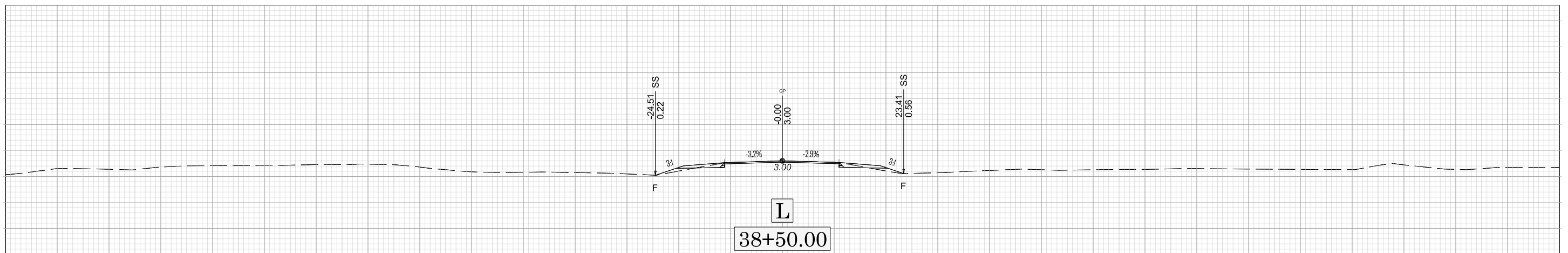
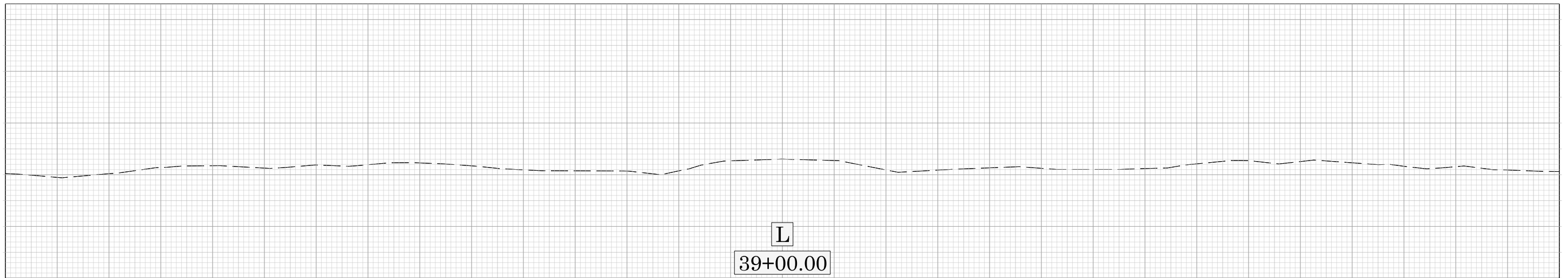
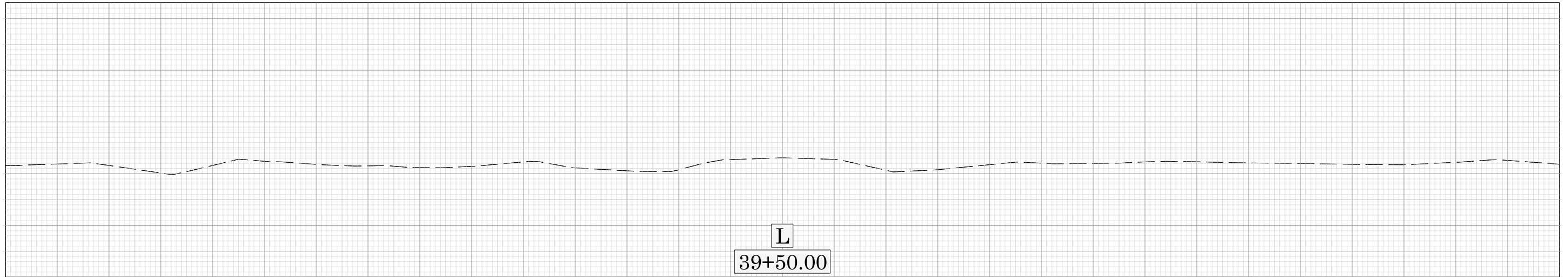

X 024

BR-0004



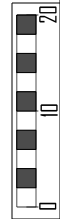
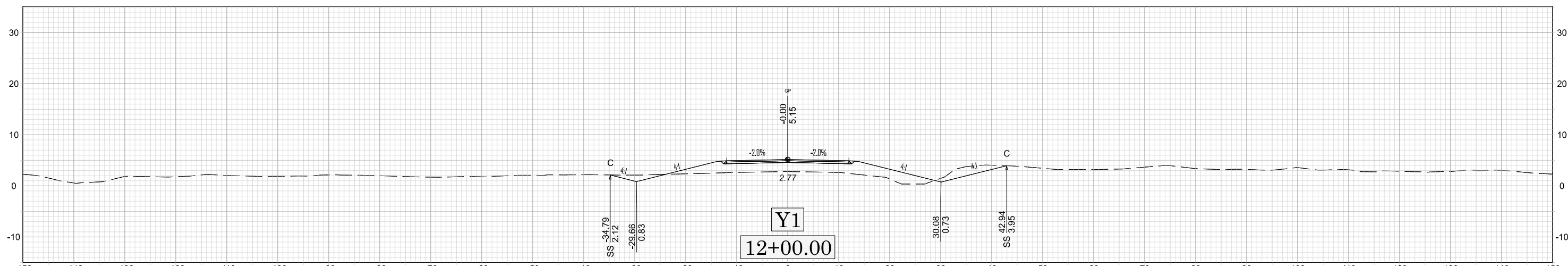
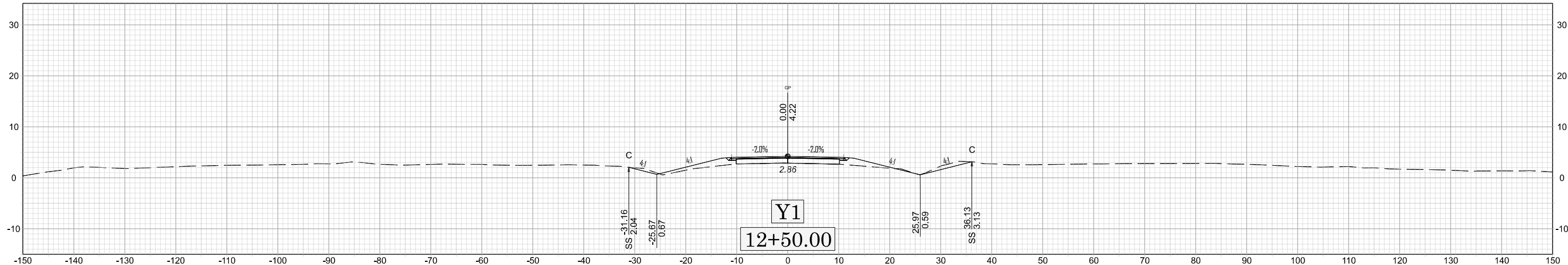
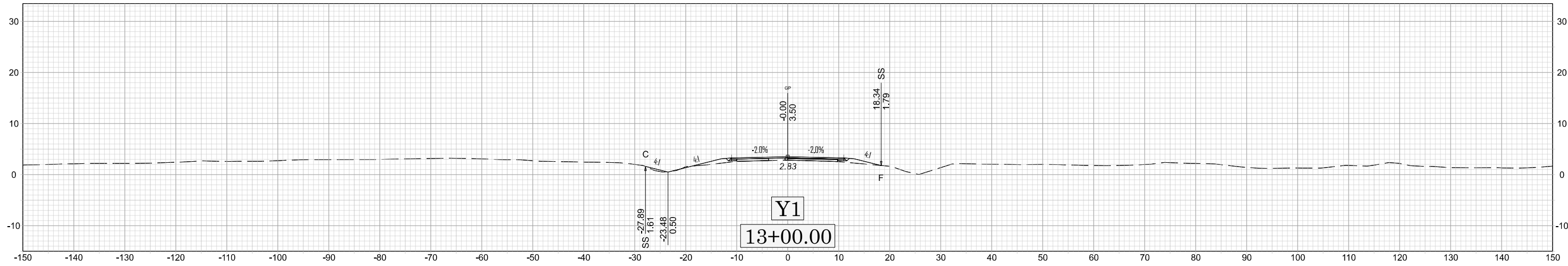

X 026

BR-0004

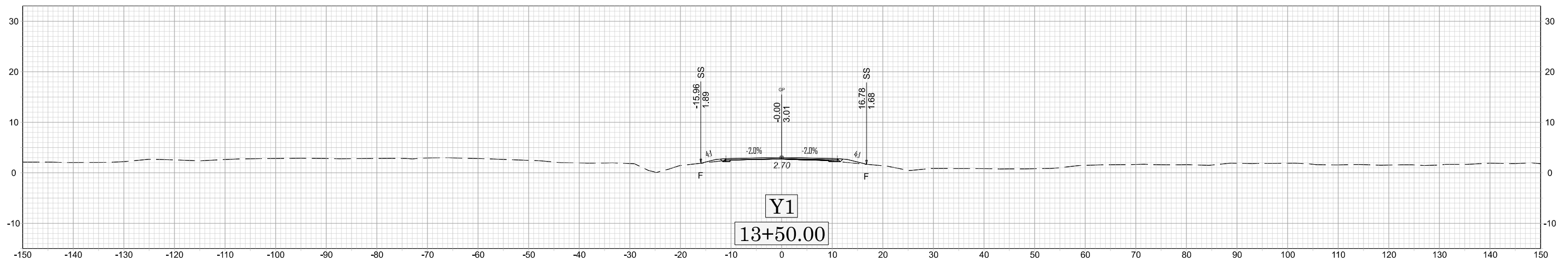
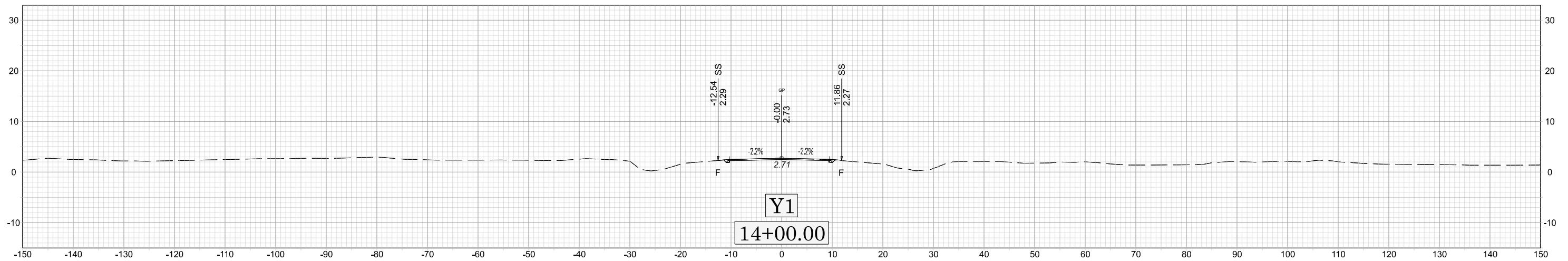
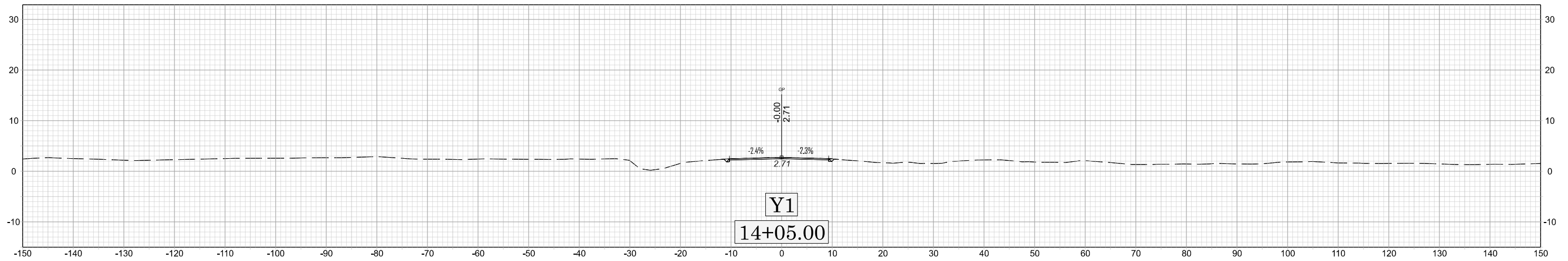

X 027

BR-0004

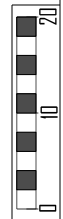
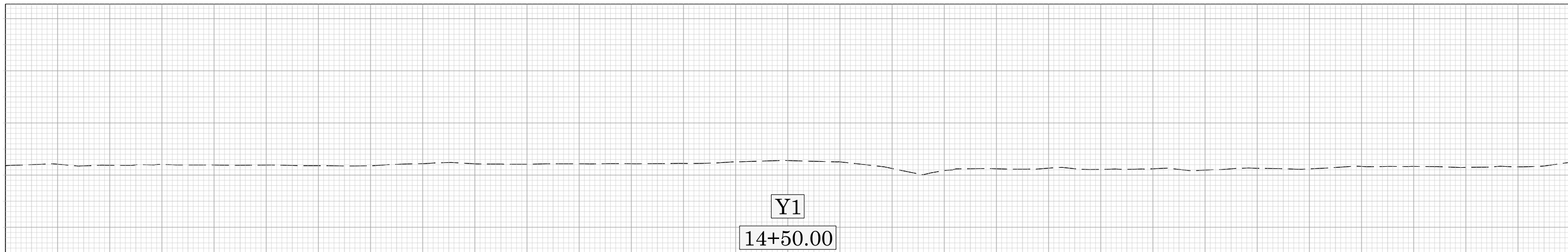

X 028

BR-0004

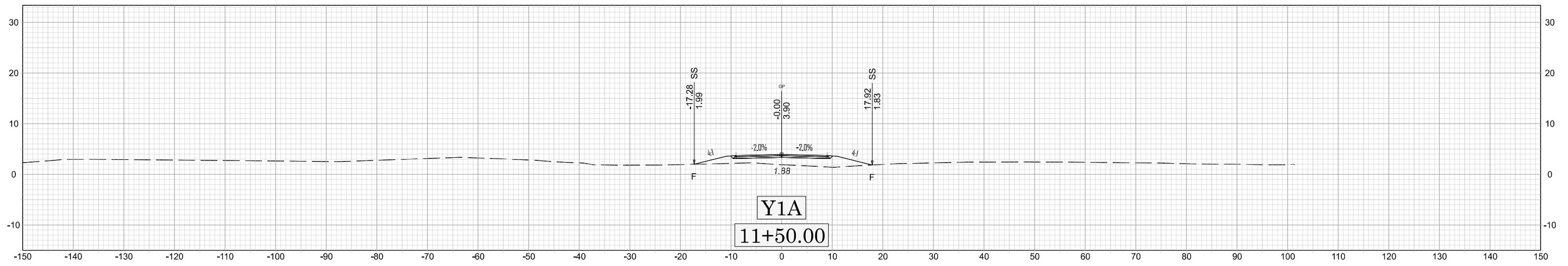

X 029

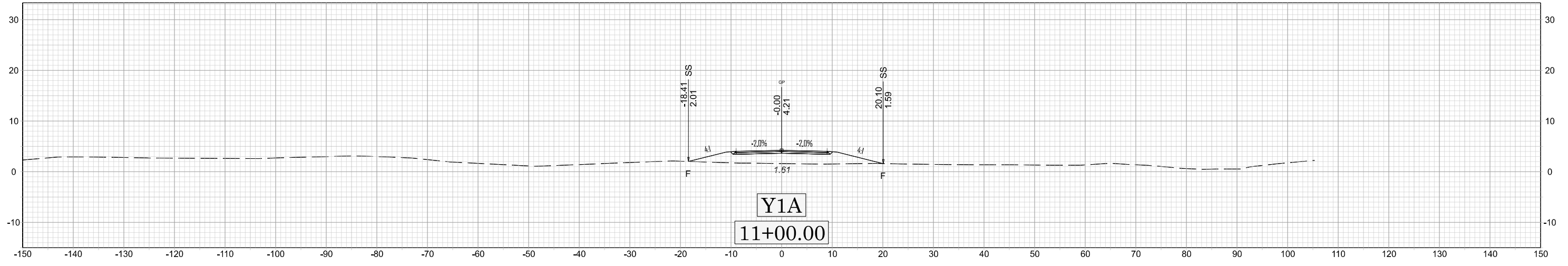

BR-0004

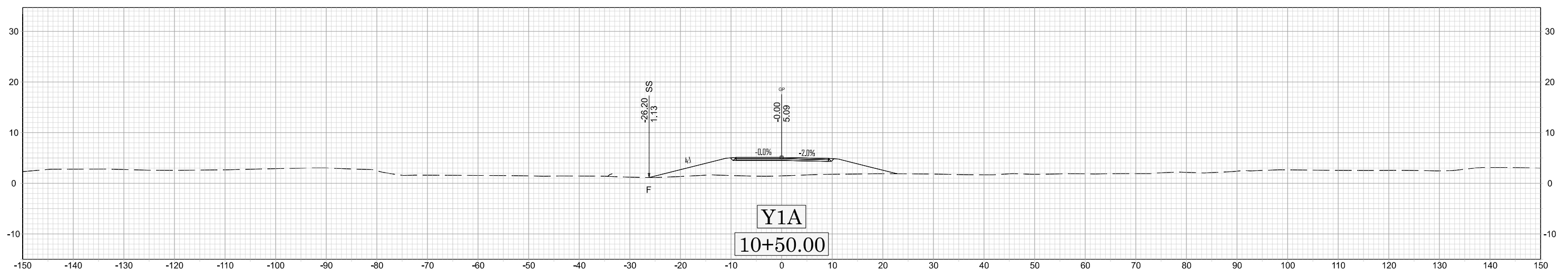

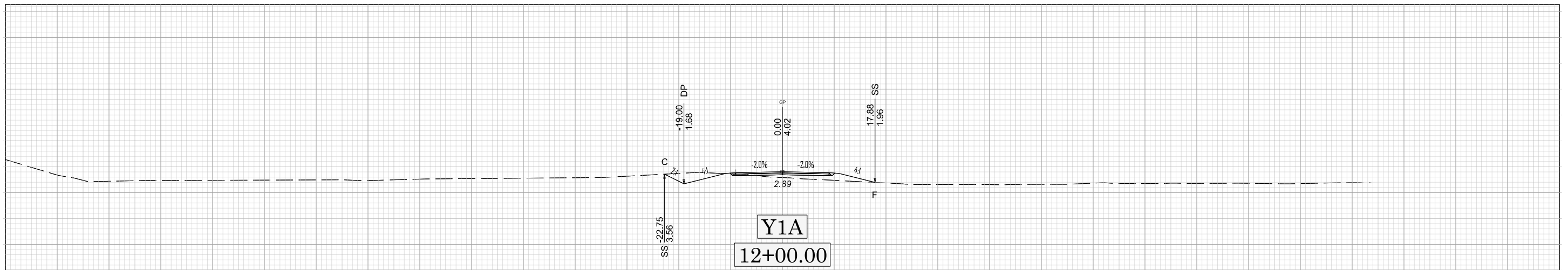
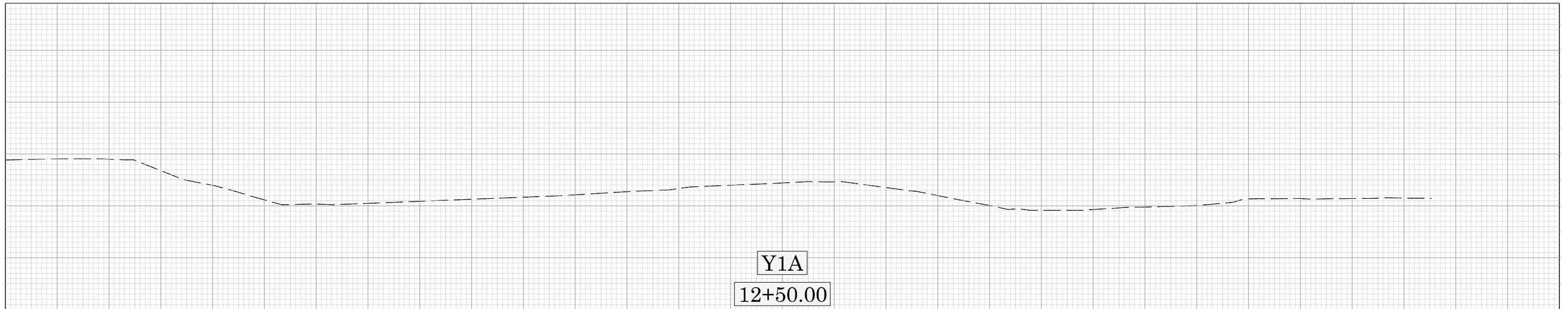
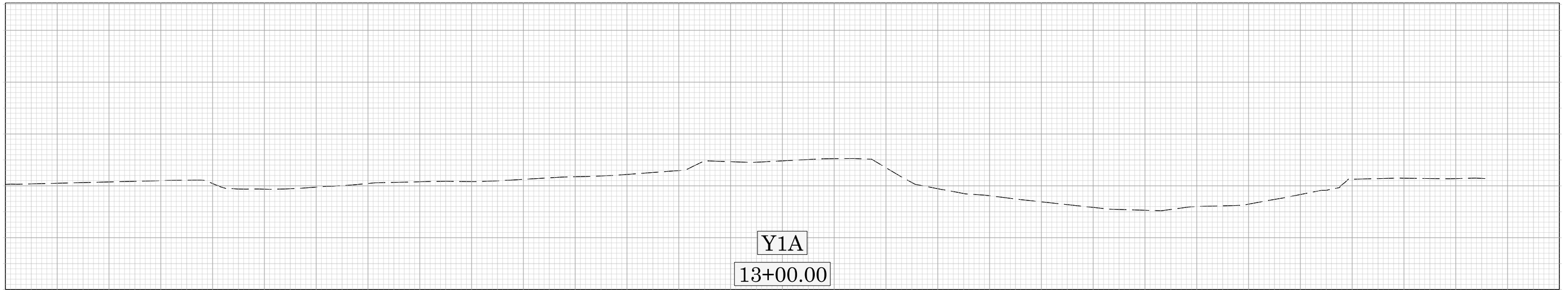

X 030

BR-0004

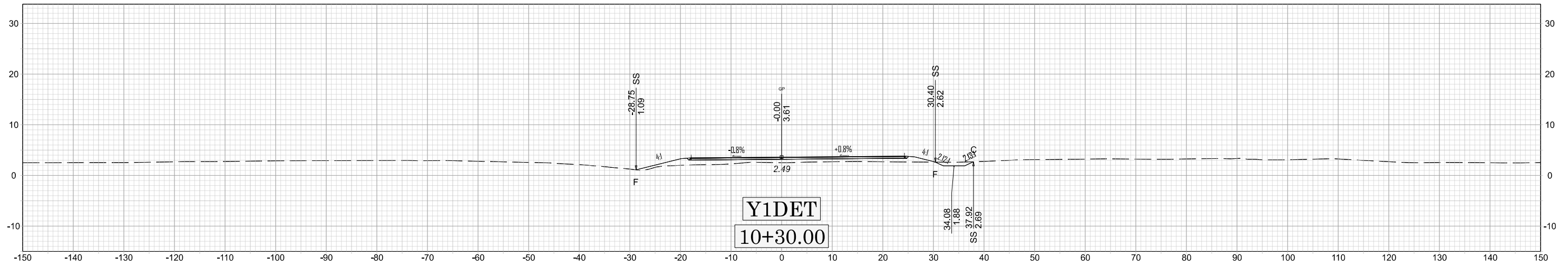
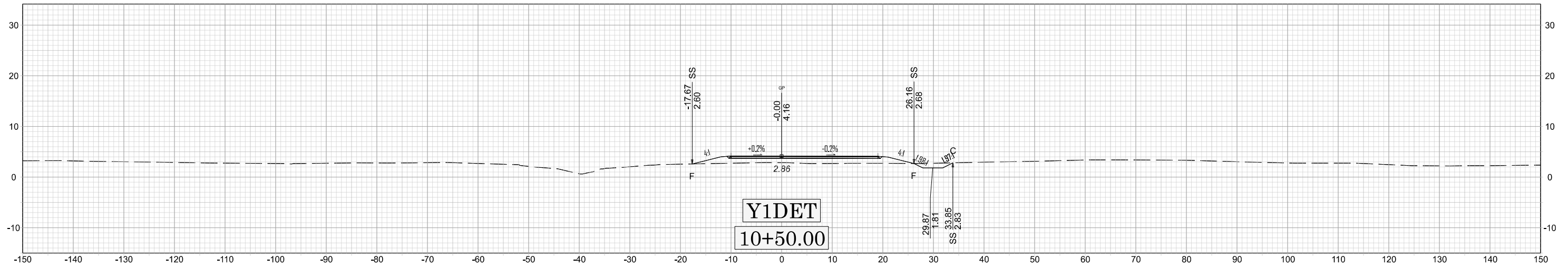
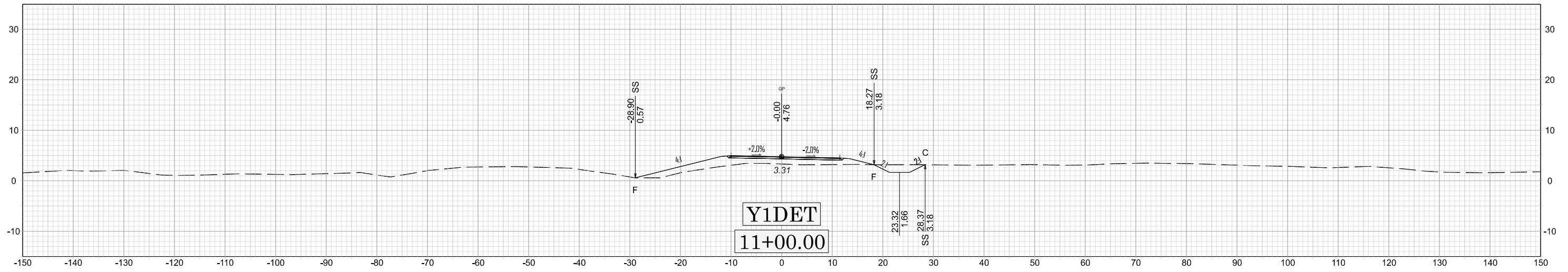

X 031

BR-0004

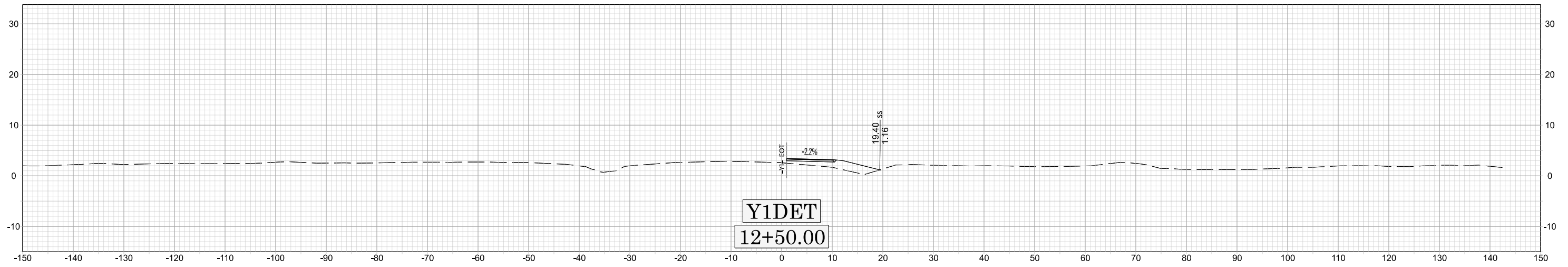

Y1DET

12+50.00

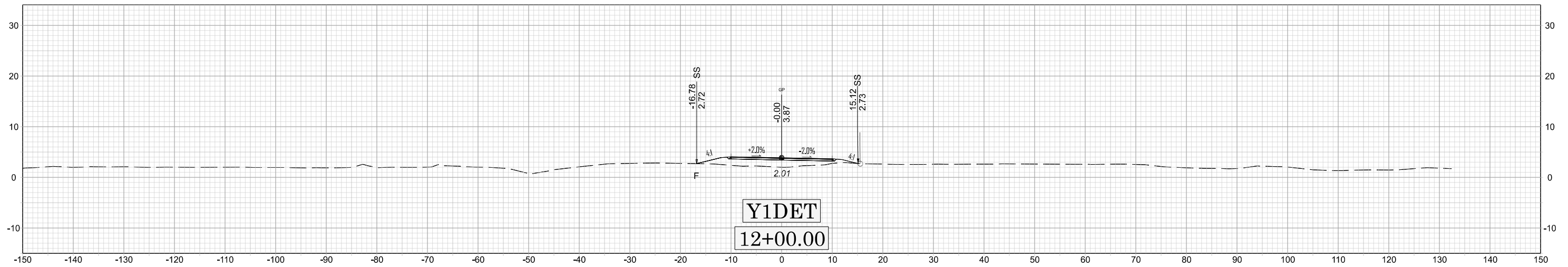

Y1DET

12+00.00

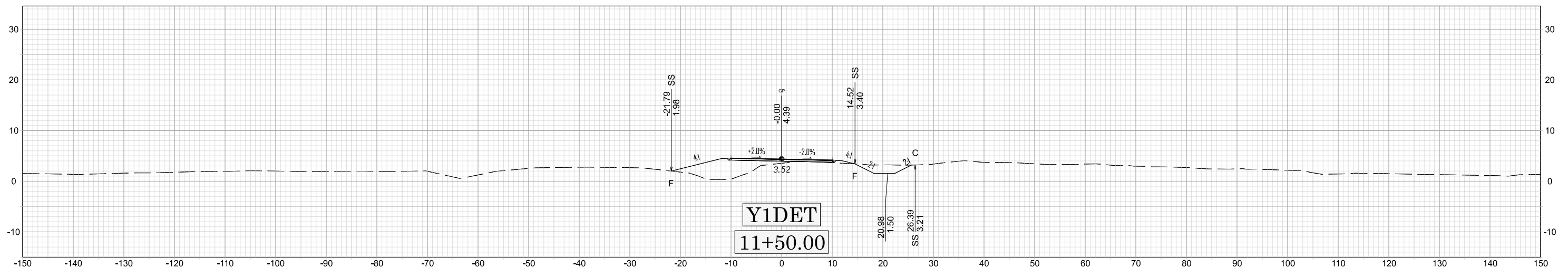

Y1DET

11+50.00



X 032

BR-0004

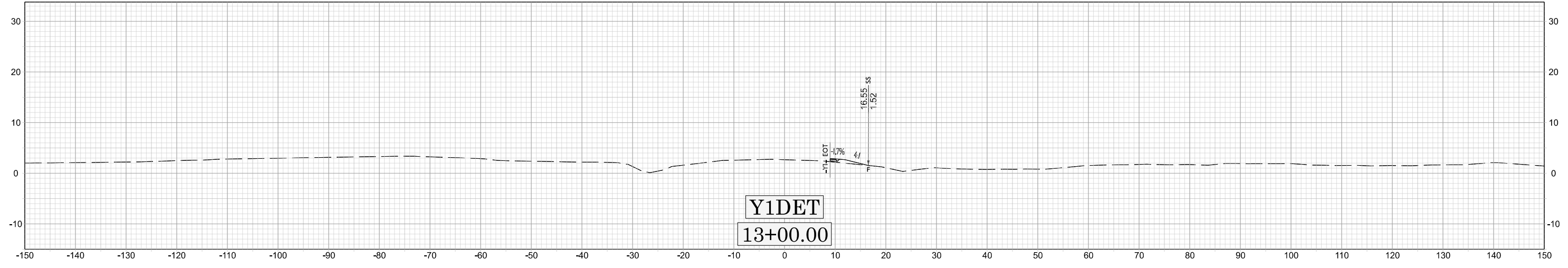
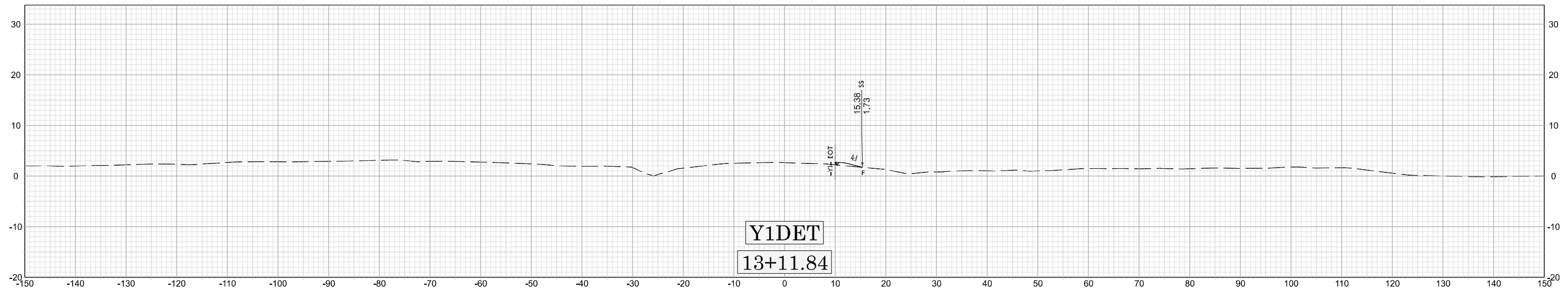

X 033

BR-0004