

**STATE OF NORTH CAROLINA
DEPARTMENT OF TRANSPORTATION**

**SIGNING PLAN
HERTFORD COUNTY**

**LOCATION: US 158/258 AT SR 1157 (POWEL ROAD), SR 1230 (CLOVER CIRCLE)
AND SR 1160 (BENTHALL BRIDGE ROAD) INTERSECTIONS NEAR MURFREESBORO**

TIP NO. HS-2401P	SHEET NO. SIGN-1
APPROVED: <i>David J. Sears</i> 06018328E5741E	
DATE: 2/25/2026	
SEAL 	
DOCUMENT NOT CONSIDERED FINAL UNLESS ALL SIGNATURES COMPLETED	

ROADWAY STANDARD DRAWING

THE FOLLOWING ROADWAY STANDARDS AS APPEAR IN "ROADWAY STANDARD DRAWINGS" - PROJECT SERVICES UNIT - N.C. DEPARTMENT OF TRANSPORTATION - RALEIGH, N.C., DATED JANUARY 2024 ARE APPLICABLE TO THIS PROJECT AND BY REFERENCE HEREBY ARE CONSIDERED A PART OF THESE PLANS:

STD. NO.	TITLE
903.20	WOOD SIGN SUPPORTS
904.10	ORIENTATION OF GROUND MOUNTED SIGNS
904.50	MOUNTING OF TYPE D, E AND F SIGNS ON U-CHANNEL POSTS
910.30	SIGNING SIGNALIZED AND UNSIGNALIZED SUPERSTREET
1264.01	OBJECT MARKERS - TYPES
1264.02	OBJECT MARKERS - INSTALLATION

GENERAL NOTES

- SIGNS FURNISHED BY STATE (BUNN PLANT).
- CONFIRM IN WRITING AT LEAST 4 MONTHS IN ADVANCE, THE ACTUAL DATE THE DEPARTMENT FURNISHED SIGNS WILL BE REQUIRED.
- IF REMOVAL OR RELOCATION OF SIGNS ON PRIVATE STREET (NON-STATE MAINTAINED) IS REQUIRED DUE TO CONSTRUCTION, THE CONTRACTOR SHALL INFORM THE ENGINEER. THE WORK WILL BE COMPLETED BY OTHERS.
- WHEN NOT STATIONED OR DIMENSIONED ON PLANS, ALL 'E' AND 'F' SIGNS SHALL BE FIELD LOCATED BY THE ENGINEER.
- ALL EXISTING SIGNS ON WOOD POST WITHIN THE PROJECT LIMITS SHALL BE REMOVED AND DISPOSED OF UNLESS OTHERWISE NOTED ON PLANS.
- WHEN EXISTING SIGNS ARE REMOVED AND INSTALLED ON NEW SUPPORTS, THE RE-ERECTION SHALL IMMEDIATELY FOLLOW THE REMOVAL.
- THE BACKGROUND FOR TYPE E & F SIGNS SHALL BE TYPE C REFLECTIVE SHEETING.
- SEE ROADWAY PLANS FOR GUARD/GUIDE RAIL DETAILS.

SUMMARY OF QUANTITIES

ITEM NO.	ITEM DESCRIPTION	QUANTITY	UNIT
DESC. NO.	SECT. NO.		
4072000000	903	70	L.F.
4082000000	903	1,023	L.F.
4102000000	904	44	EA.
4108000000	904	10	EA.
4158000000	907	43	EA.

INDEX

SHEET NO.	DESCRIPTION
SIGN-1	TITLE SHEET
SIGN-2	E AND F SIGNS
SIGN-3	SIGN DESIGNS
SIGN-4 thru 12	SIGNING PLAN SHEETS

PLAN SUBMITTED TO: NCDOT Division 1, Signing & Delineation Unit

Justin Smith, PE Division 1 Project Engineer
Mitch Eaton, PE Signing & Delineation Regional Engineer
Stacey Johns Signing & Delineation Project Design Engineer

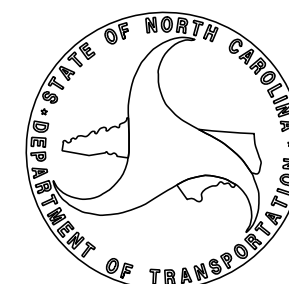

PLAN PREPARED BY:

David Sears, PE, PTOE Project Manager
Allen Tutt Project Designer



P: (919) 878-9560
 8601 Six Forks Road, Forum 1, Suite 700
 Raleigh, North Carolina 27615-3960
 NC License No. F-0112

Engineers | Construction Managers | Planners | Scientists
 www.rkk.com
 Responsive People | Creative Solutions

T.I.P.: HS-2401P

CONTRACT: C205153

PROJECT REFERENCE NO. HS-2401P	SHEET NO. SIGN-2
Approved by: <i>David T. Sears</i> <small>089183F28E5741E</small>	
DATE: 2/25/2026	
SEAL	
	
DOCUMENT NOT CONSIDERED FINAL UNLESS ALL SIGNATURES COMPLETED	

401 QUANTITY REQ'D 1

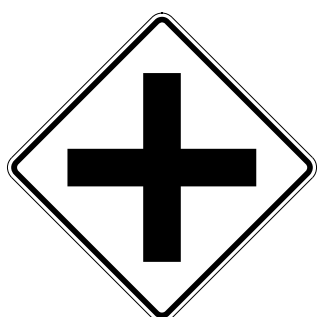

W2-1
30"X 30"

ONE WOOD POST

402 QUANTITY REQ'D 5



R6-1L
48"X 18"

TWO WOOD POSTS PER SIGN

403 QUANTITY REQ'D 10

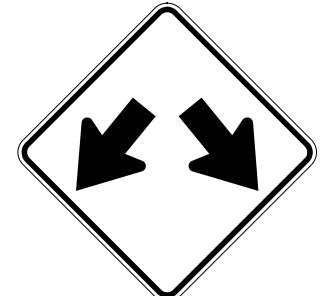

W12-1
30"X 30"

ONE WOOD POST PER SIGN

404 QUANTITY REQ'D 5

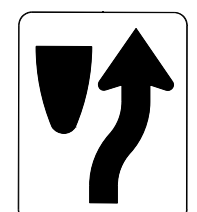

R4-7
24"X 30"

ONE WOOD POST PER SIGN

405 QUANTITY REQ'D 5



R6-1R
36"X 12"

MOUNT ABOVE SIGN 406
IN 5 INSTALLATIONS

406 QUANTITY REQ'D 10

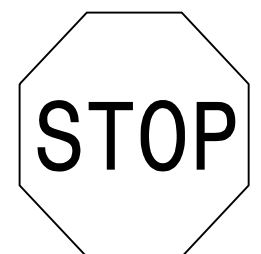

R1-1
36"X 36"

ONE WOOD POST PER SIGN
IN 5 INSTALLATIONS.
TWO WOOD POSTS PER SIGN
IN 5 INSTALLATIONS.

407 QUANTITY REQ'D 3

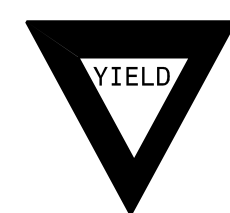

R1-2
36"X36"X36"

ONE WOOD POST PER SIGN

408 QUANTITY REQ'D 1

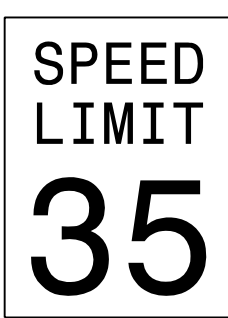

R2-1
24"X 30"

ONE WOOD POST

409 QUANTITY REQ'D 2

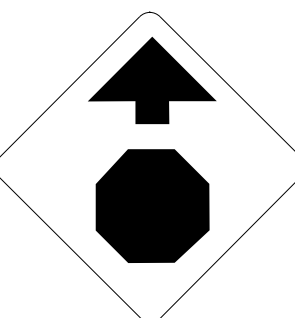

W3-1
30"X 30"

ONE WOOD POST PER SIGN

410 QUANTITY REQ'D 1



R2-1
24"X 30"

ONE WOOD POST

411 QUANTITY REQ'D 1

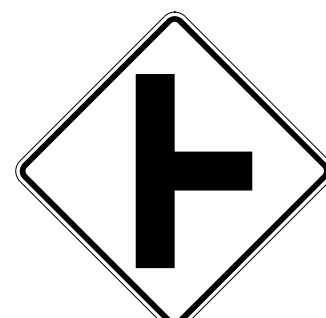

W2-2
30"X 30"

ONE WOOD POST

501 506

M3-4P
24"X 12"

M1-4
30"X 24"



M3-3P
24"X 12"

M1-4
30"X 24"

TWO WOOD POSTS PER SIGN

502 508

M3-2P
24"X 12"

M1-4
30"X 24"

*U-TURN
21"X 21"



M3-1P
24"X 12"

M1-4
30"X 24"

*U-TURN
21"X 21"

TWO WOOD POSTS PER SIGN

503 505 509

M3-4P
24"X 12"

M1-4
30"X 24"

*U-TURN
21"X 21"

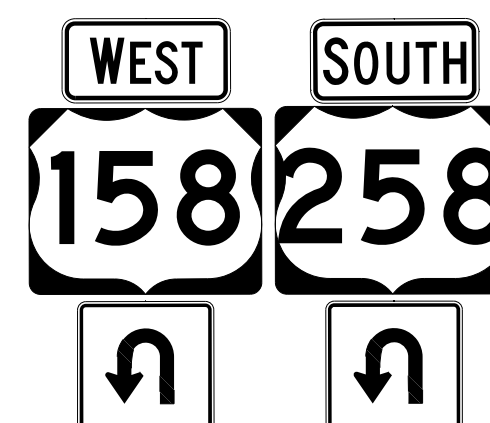

M3-3P
24"X 12"

M1-4
30"X 24"

*U-TURN
21"X 21"

TWO WOOD POSTS PER SIGN

504 507 510

M3-2P
24"X 12"

M1-4
30"X 24"

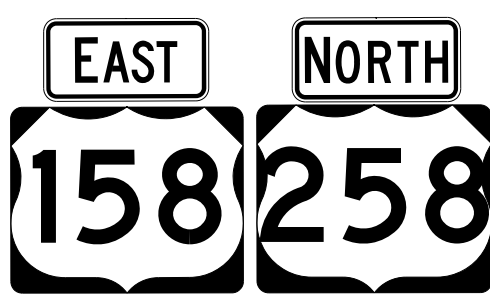

M3-1P
24"X 12"

M1-4
30"X 24"

TWO WOOD POSTS PER SIGN

504 507 510

M3-2P
24"X 12"

M1-4
30"X 24"

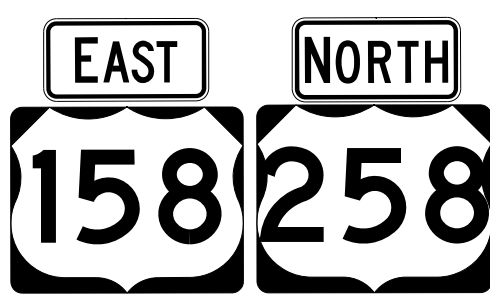

M3-1P
24"X 12"

M1-4
30"X 24"

TWO WOOD POSTS PER SIGN

504 507 510

M3-2P
24"X 12"

M1-4
30"X 24"

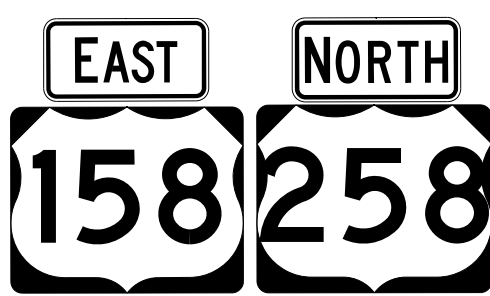

M3-1P
24"X 12"

M1-4
30"X 24"

TWO WOOD POSTS PER SIGN

504 507 510

M3-2P
24"X 12"

M1-4
30"X 24"

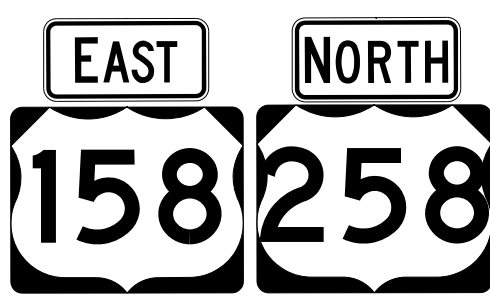

M3-1P
24"X 12"

M1-4
30"X 24"

TWO WOOD POSTS PER SIGN

504 507 510

M3-2P
24"X 12"

M1-4
30"X 24"

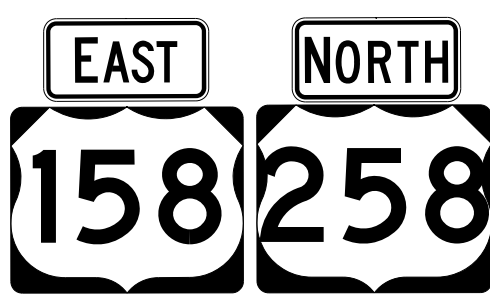

M3-1P
24"X 12"

M1-4
30"X 24"

TWO WOOD POSTS PER SIGN

504 507 510

M3-2P
24"X 12"

M1-4
30"X 24"

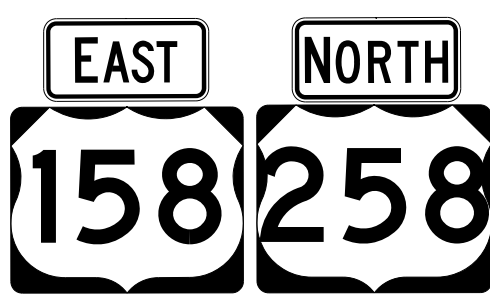

M3-1P
24"X 12"

M1-4
30"X 24"

TWO WOOD POSTS PER SIGN

*NOTE:
SEE SGN-3 FOR
U-TURN DETAIL

TYPE "E" & "F" SIGNS

RK&K
 P: (919) 878-9560
 8601 Six Forks Road, Forum 1, Suite 700
 Raleigh, North Carolina 27615-3960
 NC License No. F-0112
 Engineers | Construction Managers | Planners | Scientists
 www.rkk.com
 Responsive People | Creative Solutions

R:\03\461P_SGN_E_PSH02.dgn

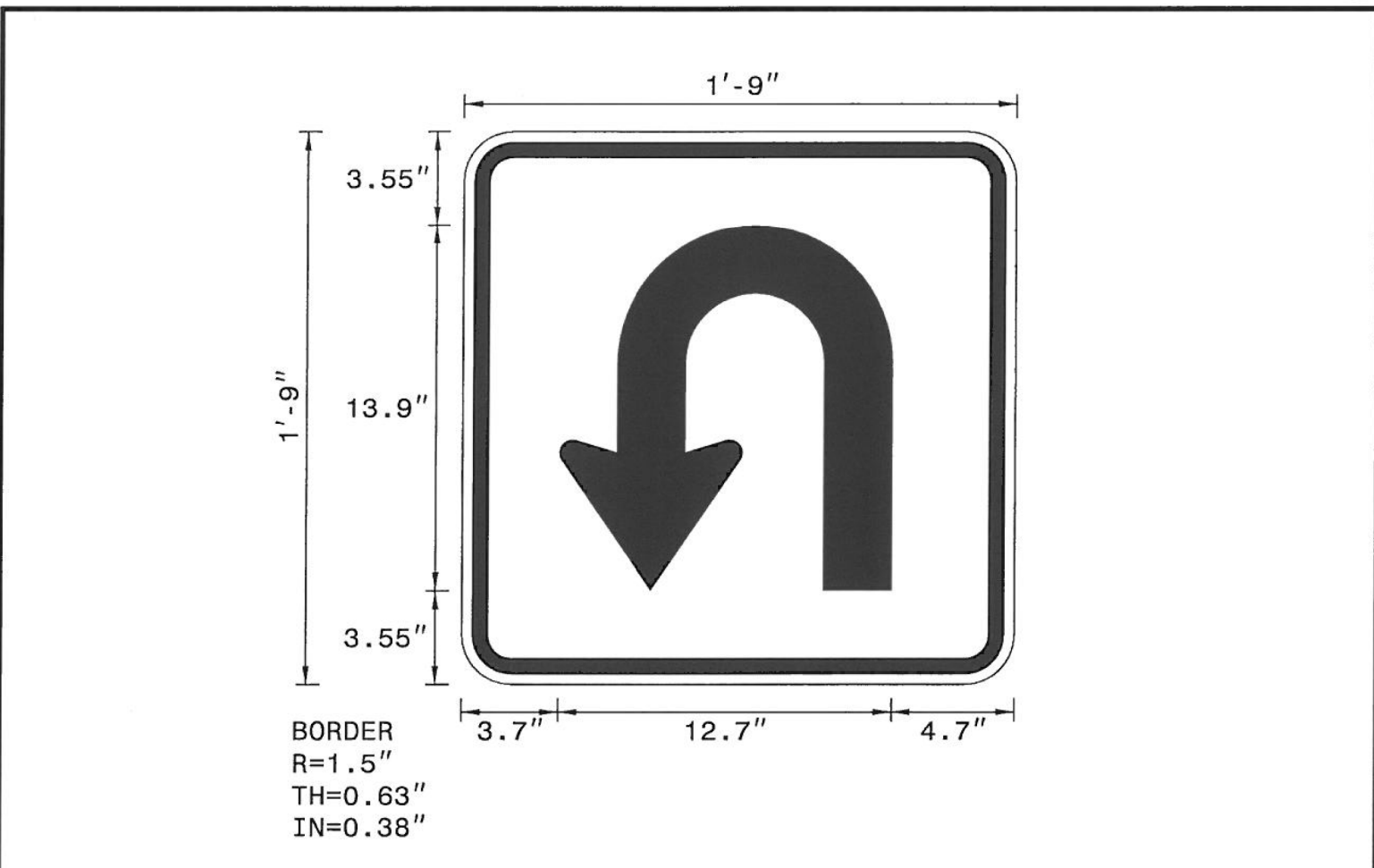
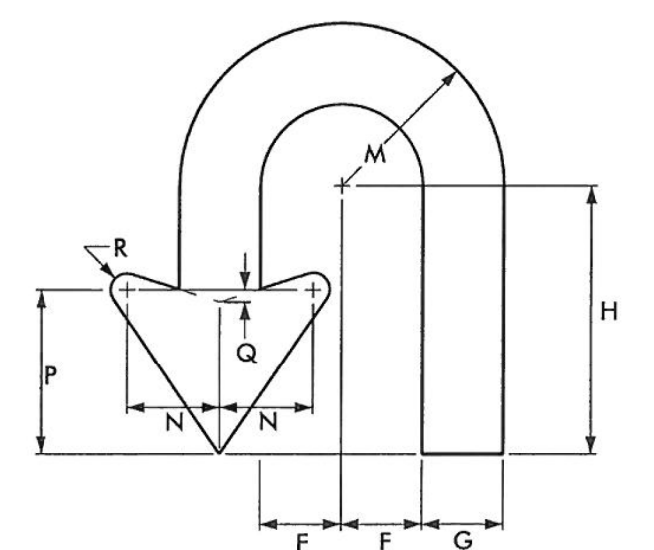
<p>SIGN NUMR: 502,503,505,508,509 BACKG. COLOR: White TYPE: F Ground COPY COLOR: Black QUANTITY: 10</p> <p>SIGN WIDTH: 1'-9" HEIGHT: 1'-9" TOTAL AREA: 3.1 Sq.Ft.</p> <p>MAT'L: 0.063" ALUMINUM</p> <p><u>BORDER TYPE</u>: RECESSED RECESS: 0.38" WIDTH: 0.63" RADII: 1.5"</p> <p>NO. Z BARS: LENGTH:</p>	<p>DESIGN BY: CHK BY: STD #: PROJECT ID: DIV: DATE:</p>	<p style="text-align: right;">N. C. DEPARTMENT OF TRANSPORTATION DIVISION OF HIGHWAYS TRANSPORTATION MOBILITY & SAFETY SIGNING & DELINEATION UNIT</p> <div style="text-align: center;">  </div> <p>BORDER R=1.5" TH=0.63" IN=0.38"</p>																		
<p>NOTES:</p> <ol style="list-style-type: none"> Legend and border shall be direct applied Non-reflective sheeting. Background shall be Grade C reflective sheeting. 																				
<p>Arrow Details</p>  <table border="1" style="margin: 10px auto; border-collapse: collapse;"> <thead> <tr> <th>ARROW DIMENSIONS (INCHES)</th> <th>F</th> <th>G</th> <th>H</th> <th>M</th> <th>N</th> <th>P</th> <th>Q</th> <th>R</th> </tr> </thead> <tbody> <tr> <td></td> <td>2.625</td> <td>2.625</td> <td>8.659</td> <td>5.25</td> <td>3</td> <td>5.25</td> <td>0.375</td> <td>0.5</td> </tr> </tbody> </table> <p>Spacing Factor is 1 unless specified otherwise FILENAME: GSENG</p>			ARROW DIMENSIONS (INCHES)	F	G	H	M	N	P	Q	R		2.625	2.625	8.659	5.25	3	5.25	0.375	0.5
ARROW DIMENSIONS (INCHES)	F	G	H	M	N	P	Q	R												
	2.625	2.625	8.659	5.25	3	5.25	0.375	0.5												

MAD 83NA 2011

MATCHLINE -L- STA. 75+00 SEE SIGN-5

STA. 89+00 SEE SIGN-7
MATCHLINE -L-

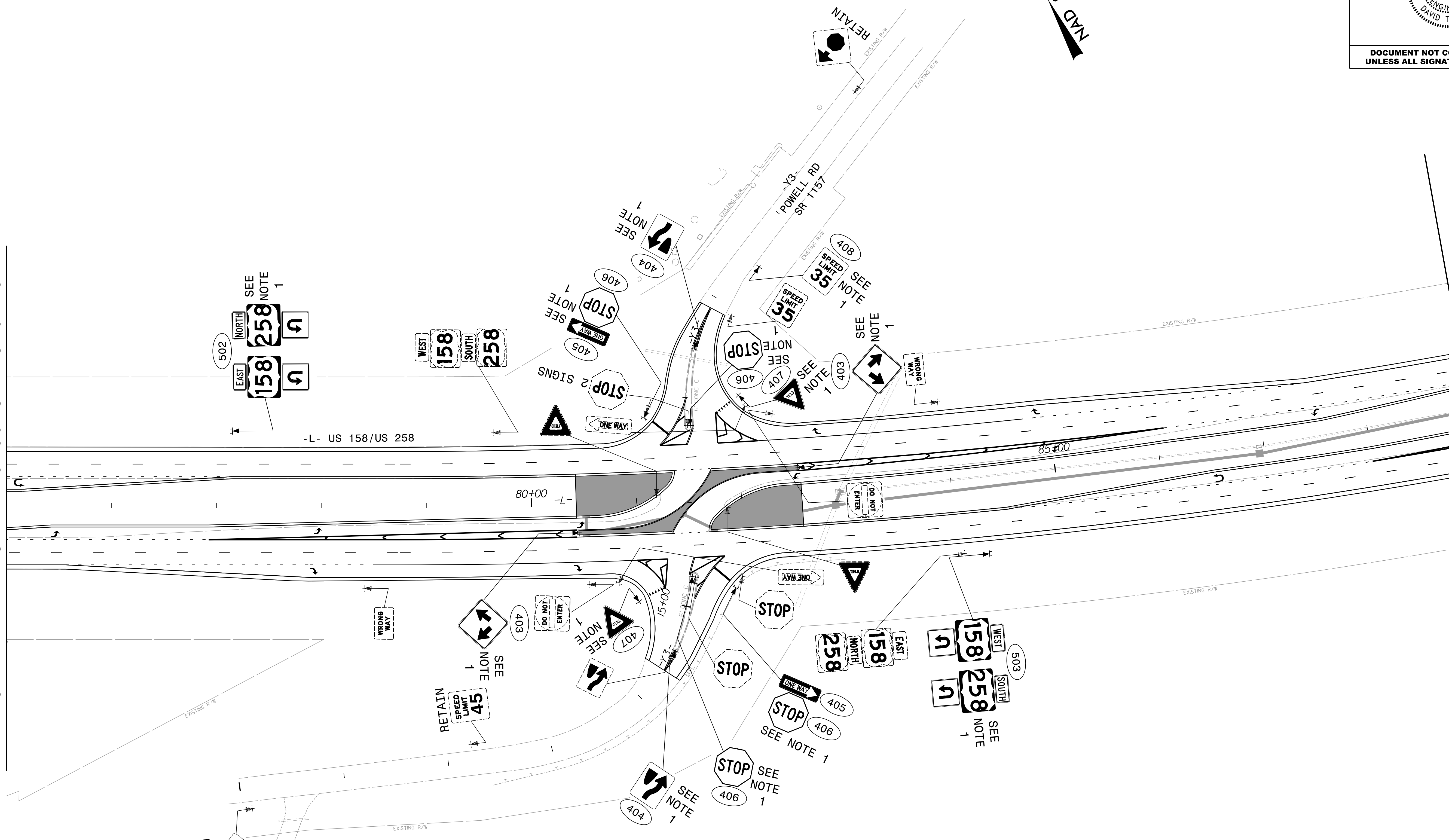

PROJECT NOTES

- 1 SIGN ERECTION, TYPE D, E, AND F

SIGNING PLAN

RK&K
 P: (919) 878-9560
 8601 Six Forks Road, Forum 1, Suite 700
 Raleigh, North Carolina 27615-3960
 NC License No. F-0112
 Engineers | Construction Managers | Planners | Scientists
 www.rkk.com
 Responsive People | Creative Solutions

R:\2026\03\27\2026\SIGN_L_PSH06.dgn

NAD 83 NVA 2011

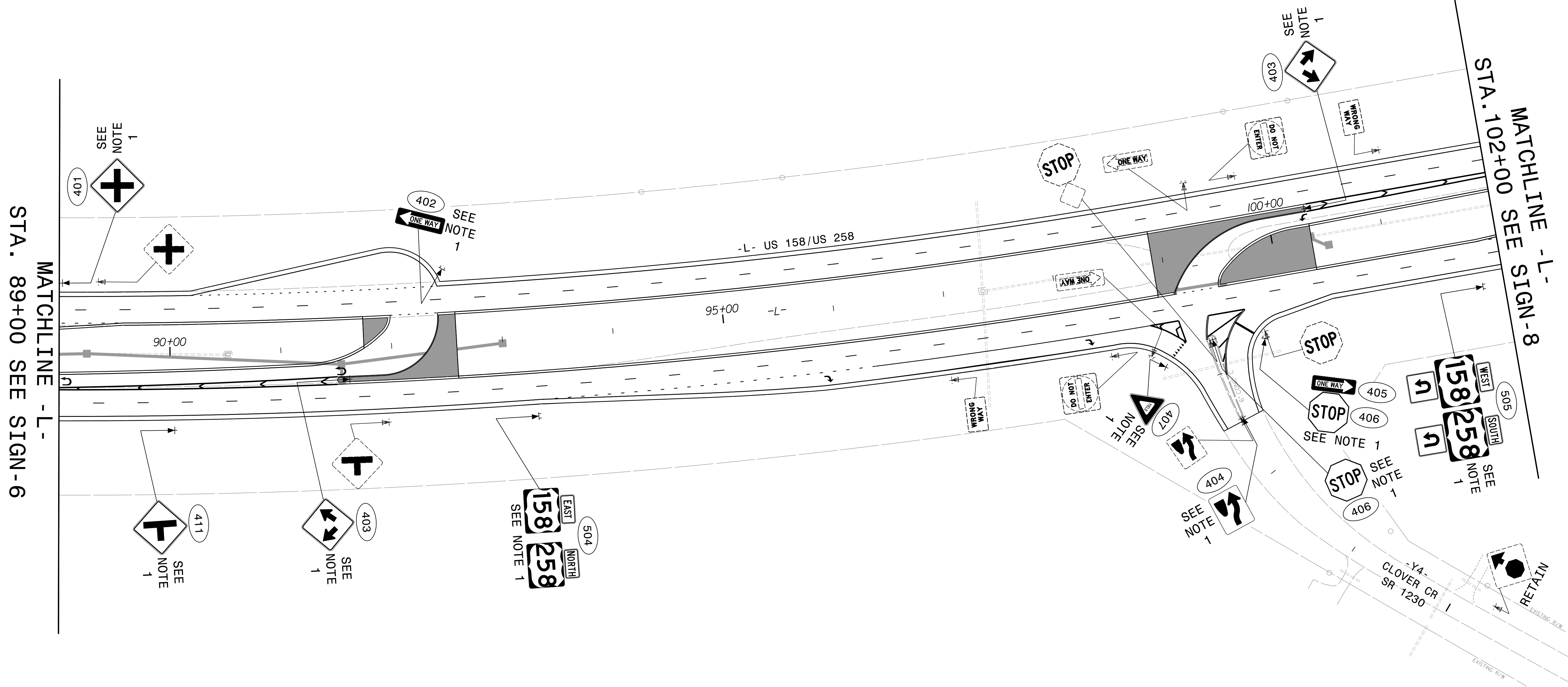

MATCHLINE -L-
STA. 89+00 SEE SIGN-6

MATCHLINE -L-
STA. 102+00 SEE SIGN-8

PROJECT NOTES
 1 SIGN ERECTION, TYPE D, E, AND F

SIGNING PLAN

PROJECT REFERENCE NO. HS-2401P	SHEET NO. SIGN-8
APPROVED: <i>David T. Seals</i> <small>089183F28E5741E</small>	
DATE: 2/25/2026	
SEAL	
	
DOCUMENT NOT CONSIDERED FINAL UNLESS ALL SIGNATURES COMPLETED	

NAD 83/NA 2011

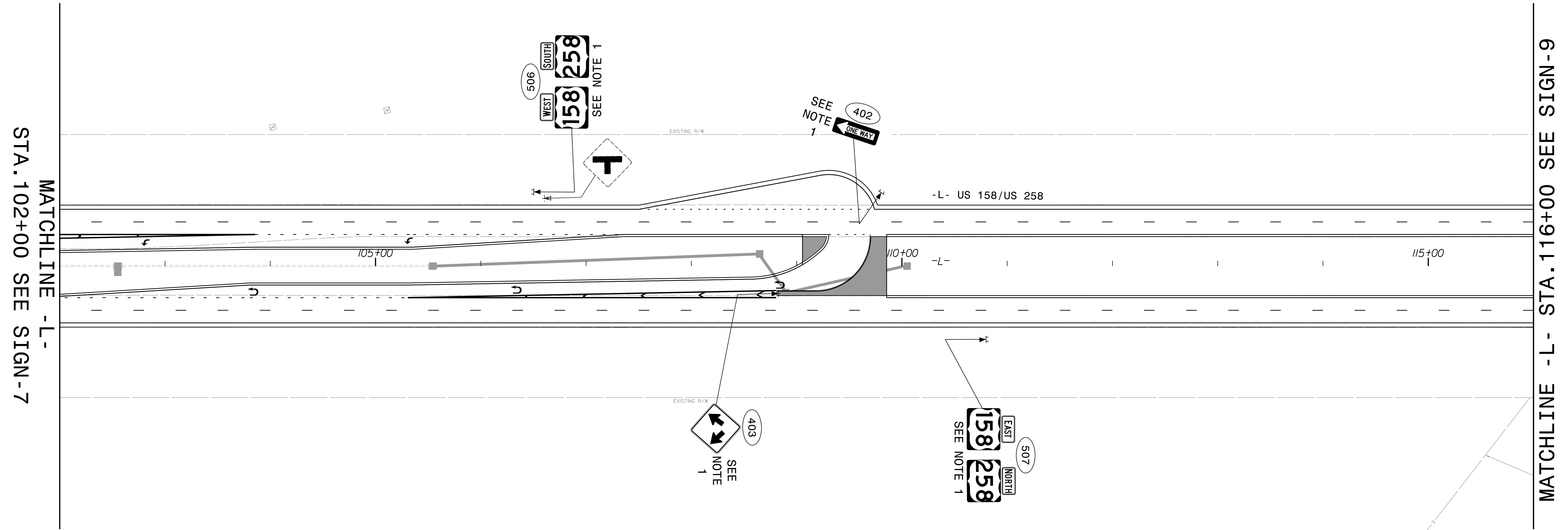

MATCHLINE -L- STA. 102+00 SEE SIGN-7

MATCHLINE -L- STA. 116+00 SEE SIGN-9

RK&K
 P: (919) 878-9560
 8601 Six Forks Road, Forum 1, Suite 700
 Raleigh, North Carolina 27615-3960
 NC License No. F-0112

Engineers | Construction Managers | Planners | Scientists
 www.rkk.com

Responsive People | Creative Solutions

PROJECT NOTES

1 SIGN ERECTION, TYPE D, E, AND F

SIGNING PLAN

R:\03\401\SGN_L_PSH08.dgn

MATCHLINE -L- STA. 116+00 SEE SIGN -8

MATCHLINE -L- STA. 130+00 SEE SIGN -10

NAD 83/NA 2011

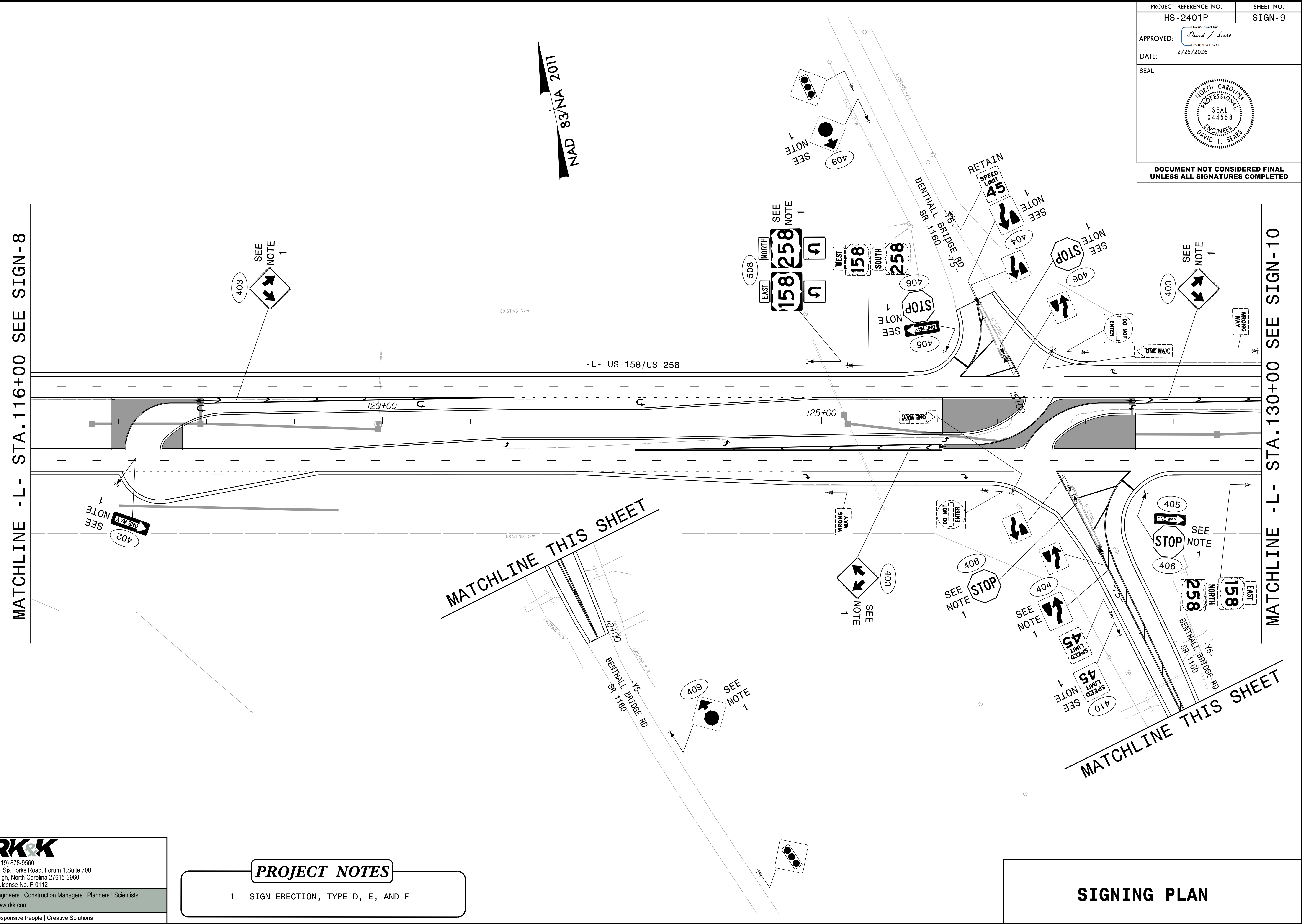

MATCHLINE THIS SHEET

MATCHLINE THIS SHEET

RK&K
 P: (919) 878-9560
 8601 Six Forks Road, Forum 1, Suite 700
 Raleigh, North Carolina 27615-3960
 NC License No. F-0112

Engineers | Construction Managers | Planners | Scientists
 www.rkk.com

Responsive People | Creative Solutions

PROJECT NOTES

1 SIGN ERECTION, TYPE D, E, AND F

SIGNING PLAN

R:\03\461\SGN_L_PSH09.dgn

PROJECT REFERENCE NO. HS-2401P	SHEET NO. SIGN-10
Designed by: <i>David T. Sears</i> APPROVED: _____ <small>089183F28E5741E</small> DATE: 2/25/2026	
SEAL 	
DOCUMENT NOT CONSIDERED FINAL UNLESS ALL SIGNATURES COMPLETED	

NAD 83/NA 2011

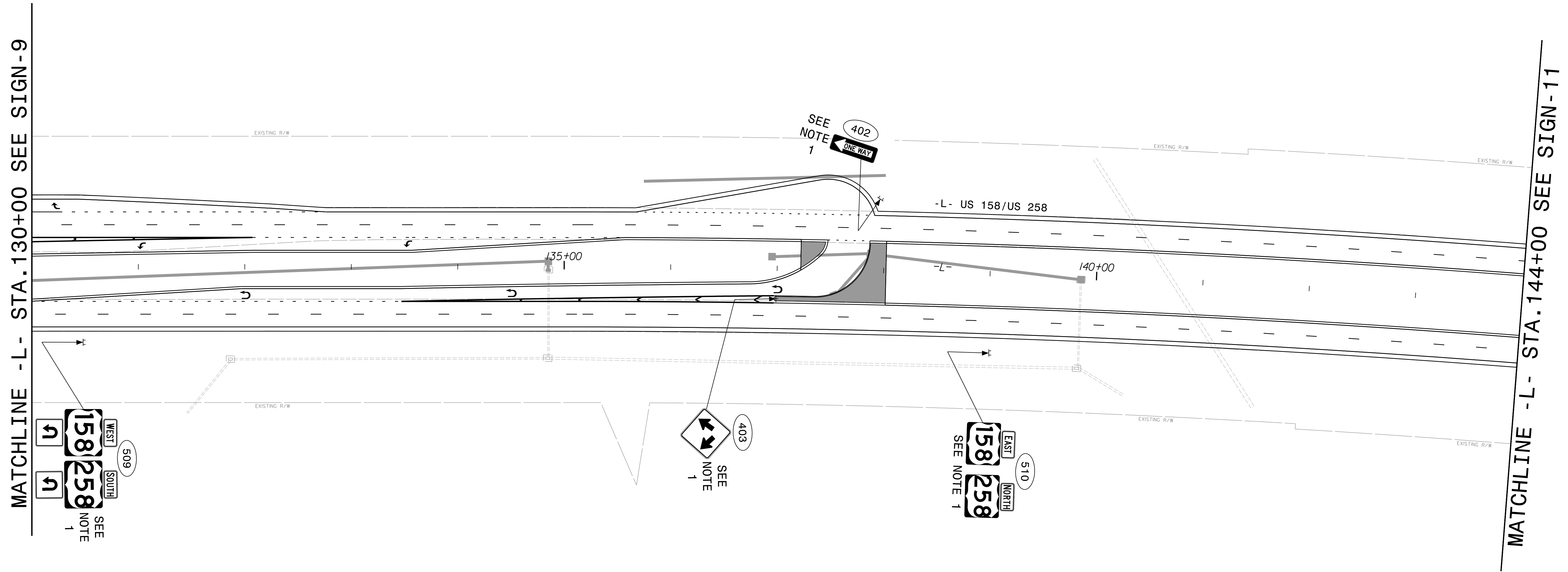

MATCHLINE -L- STA. 130+00 SEE SIGN-9

MATCHLINE -L- STA. 144+00 SEE SIGN-11

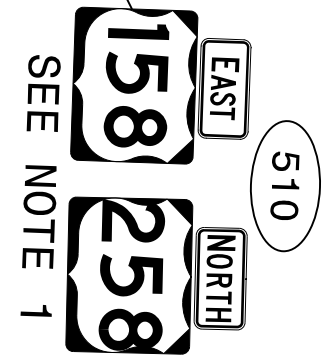
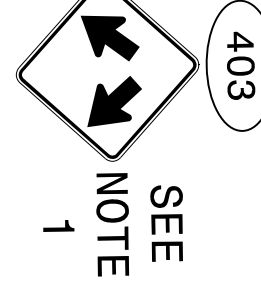
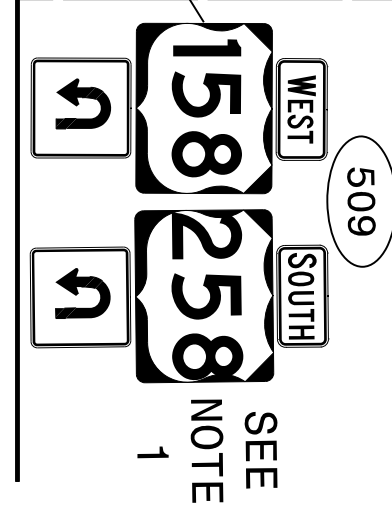

PROJECT NOTES

- 1 SIGN ERECTION, TYPE D, E, AND F

SIGNING PLAN

RK&K
 P: (919) 878-9560
 8601 Six Forks Road, Forum 1, Suite 700
 Raleigh, North Carolina 27615-3960
 NC License No. F-0112

Engineers | Construction Managers | Planners | Scientists
 www.rkk.com

Responsive People | Creative Solutions

R:\03\401\SGN_L_PSH010.dgn

PROJECT REFERENCE NO.	SHEET NO.
HS-2401P	SIGN-11
APPROVED: <i>David T. Sears</i>	
DATE: 2/25/2026	
SEAL	
	
DOCUMENT NOT CONSIDERED FINAL UNLESS ALL SIGNATURES COMPLETED	

NAD 83/NA 2011

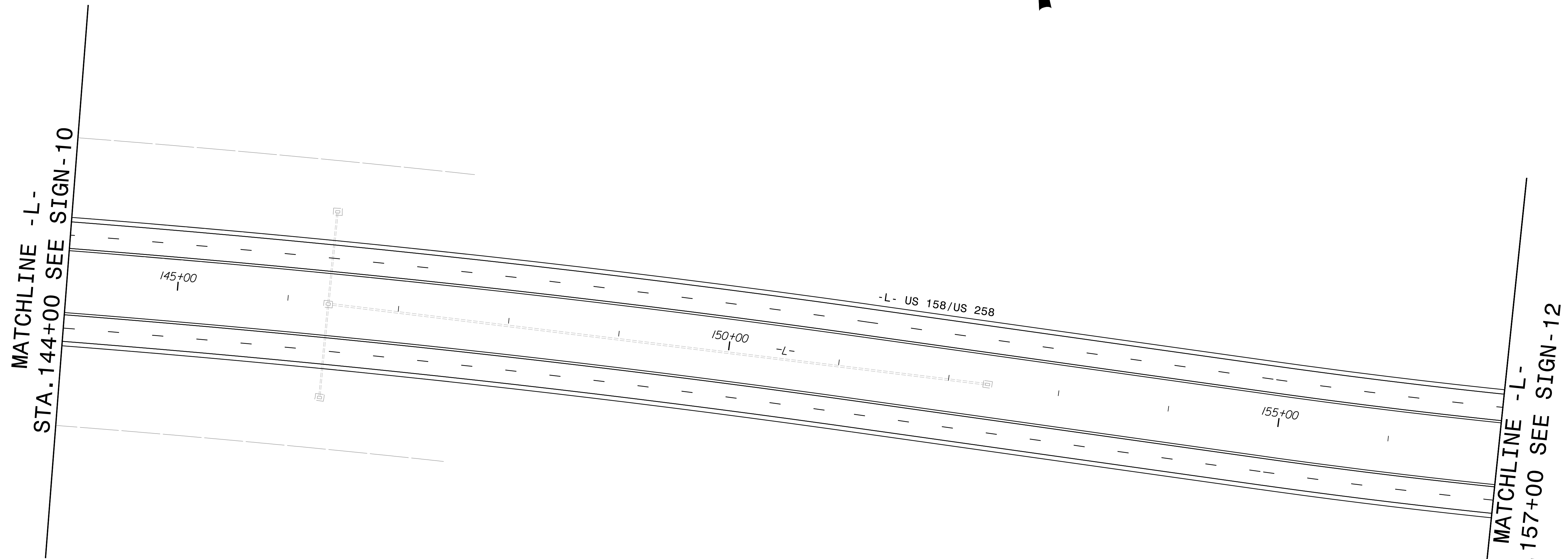

PLAN SHEET INCLUDED FOR
INFORMATIONAL PURPOSES ONLY

RK&K
P: (919) 878-9560
8601 Six Forks Road, Forum 1, Suite 700
Raleigh, North Carolina 27615-3960
NC License No. F-0112

Engineers | Construction Managers | Planners | Scientists
www.rkk.com

Responsive People | Creative Solutions

PROJECT NOTES

1 SIGN ERECTION, TYPE D, E, AND F

SIGNING PLAN

R:\03\401\SGN_PSH01.dgn

NAD 83/NA 2011

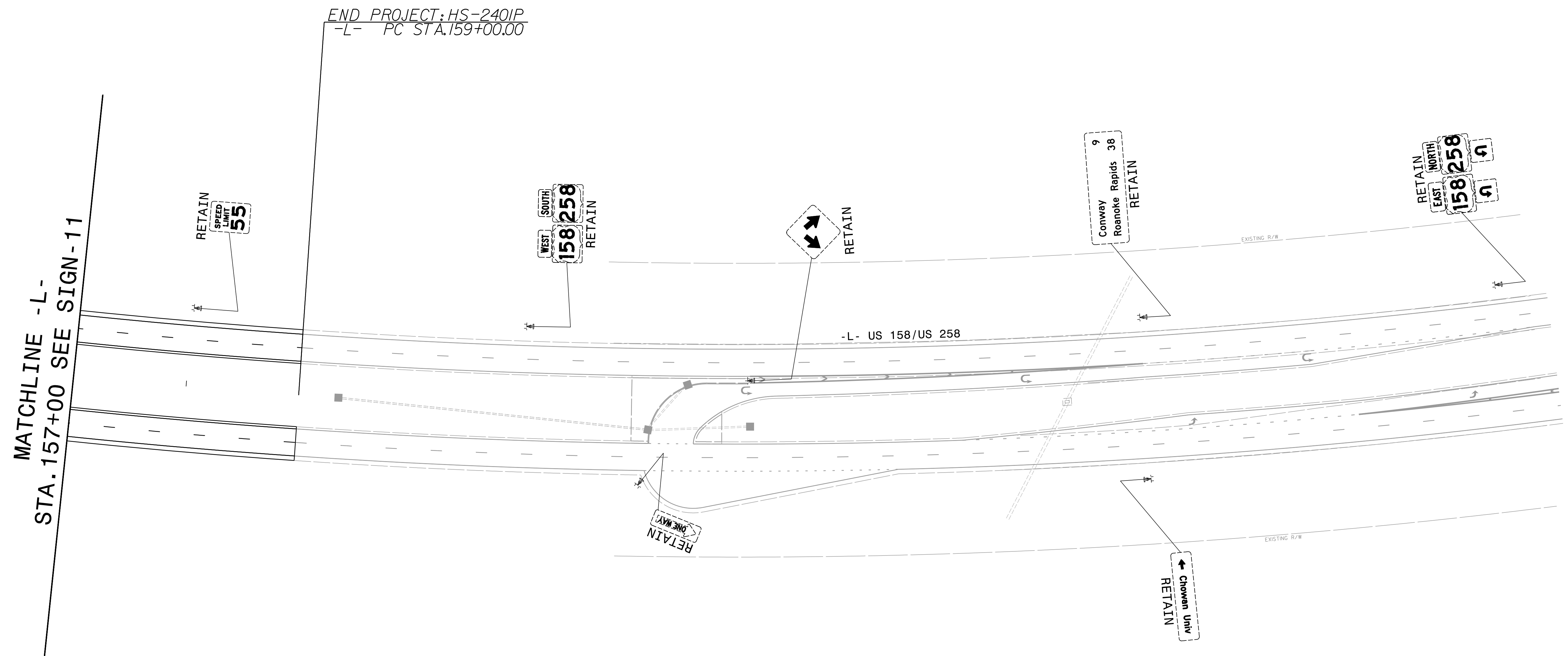

PROJECT NOTES

1 SIGN ERECTION, TYPE D, E, AND F

SIGNING PLAN

R:\03\401\SGN_L_PSH012.dgn