

High Speed Detection (≥35 mph)

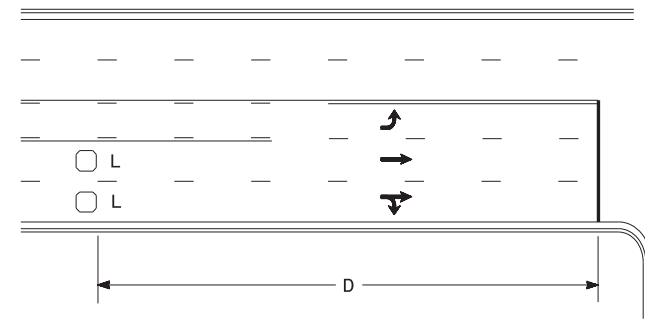

Speed Limit mph	D ft
35	200
40	250
45	300
50	355
55	420
60	475
65	550

L = 6ft X 6ft
Wired separately

Volume Density Operation

OR

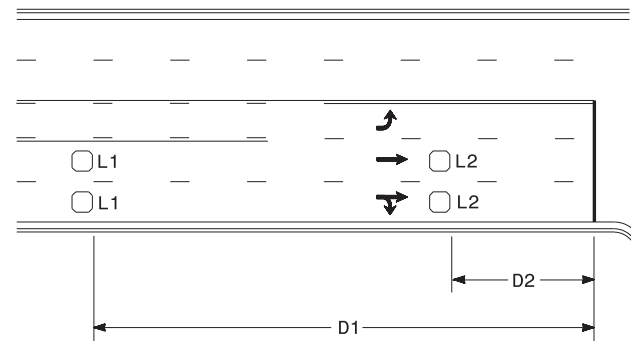

Speed Limit mph	D1 ft	D2 ft
40	250	80
45	300	90
50	355	100
55	420	110
60	475	120
65	550	130

L1 = 6ft X 6ft
Wired in series

L2 = 6ft X 6ft
Wired in series

"Stretch" Operation

Low Speed Detection (≤35 mph)

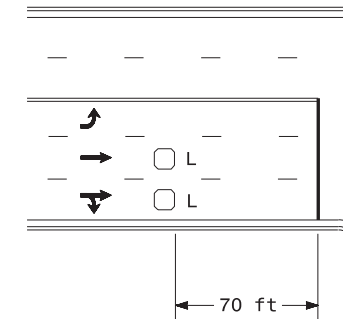

L = 6ft X 6ft
Wired in series

OR

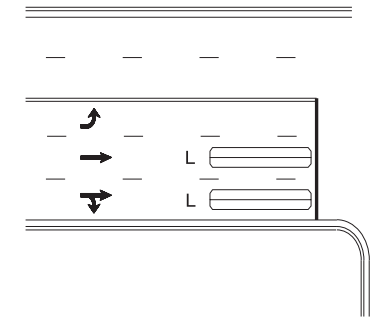

L = 6ft X 40ft
Quadrupole loop, wired separately

Left Turn Lane Detection

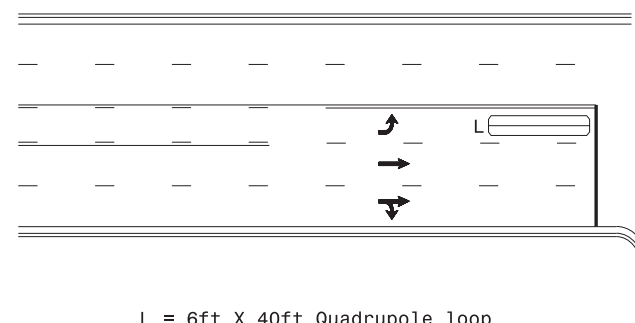

L = 6ft X 40ft Quadrupole loop

Presence Loop Detection

OR

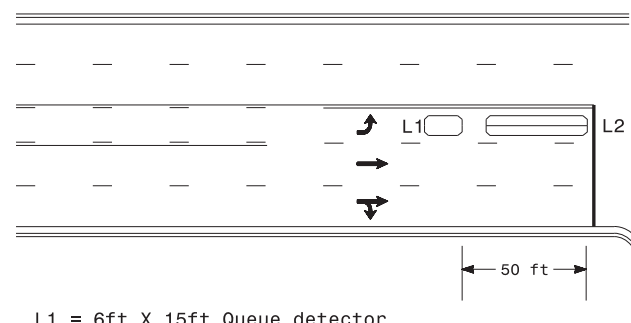

L1 = 6ft X 15ft Queue detector
L2 = 6ft X 40ft Quadrupole loop

Queue Loop Detection

Right Turn Lane Detection

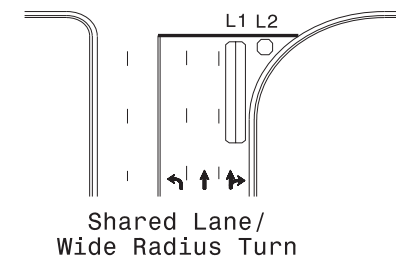

Shared Lane/
Wide Radius Turn

L1 = 6ft X 40ft Quadrupole loop
L2 = 6ft X 6ft [Minimum] Presence loop
Wired separately

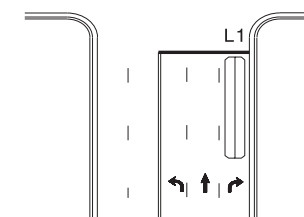

Standard Turn

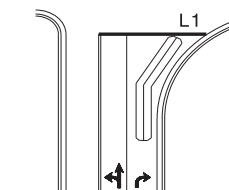

Wide Radius Turn

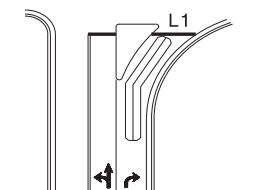

Channelized Turn

Side Street Detection

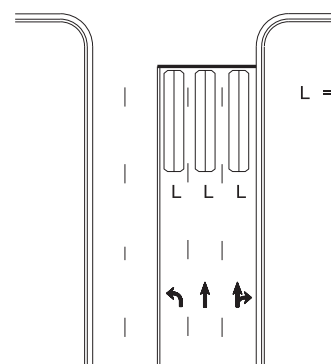

L = 6ft X 40ft
Quadrupole loop
Wired to separate
detectors/channels

Presence Loop Placement at Stop Lines

Locate loop slightly
behind leading
edge of stop line

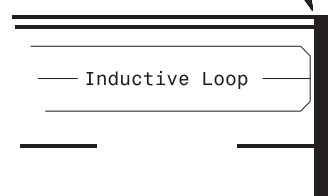

- Note:
Loop may be located in advance
of stop line under any of the
following conditions:
- 1) stop line is greater than 15' from edge of intersecting roadway
 - 2) loop detects a permissive or protected/permissive left turn
 - 3) for an exclusive right turn lane

Recommended Number of Turns

Single 6' X 6' loop
(when wired separately):

Length of Lead-in ft	Number of Turns
< 250	3
250-375	4
375-525	5
> 525	6

Quadrupole loops: Use 2-4-2 turns

6' X 15' Loops:
Lead-in < 150', use 2 turns
Lead-in > 150', use 3 turns

Typical Signal Loop Locations

Prepared in the Offices of:		PLAN DATE: September 2025		REVIEWED BY:	
		PREPARED BY: J.A. Lohr		REVIEWED BY:	
		SCALE: N/A		DATE:	
750 N. Greenfield Pkwy, Garner, NC 27529		REVISIONS		INIT. DATE	
1990-48997-44484		DATE: 11/25/2025		DATE:	

SIG. INVENTORY NO.