

# US 64 & US 49 TIP NO. U-5813 CROSS SECTION INDEX

LOCATION	STATION TO STATION	SHEET NO.	LOCATION	STATION TO STATION	SHEET NO.
-L-	STA. 13 + 00.00 TO STA. 129 + 00.00	X-1 THRU X-60	-Y18-	STA. 10 + 00.00 TO STA. 12 + 50.00	X-161 THRU X-166
-Y-	STA. 10 + 00.00 TO STA. 52 + 00.00	X-61 THRU X-81	-Y19-	STA. 10 + 00.00 TO STA. 13 + 50.00	X-167 THRU X-170
-Y_SLIP-	STA. 10 + 00.00 TO STA. 21 + 25.00	X-82 THRU X-92	-RPA_REV-	STA. 11 + 50.00 TO STA. 18 + 50.00	X-171 THRU X-174
-Y1-	STA. 10 + 00.00 TO STA. 13 + 75.00	X-93 THRU X-97	-RPB_REV-	STA. 14 + 00.00 TO STA. 20 + 50.00	X-175 THRU X-177
-Y2-	STA. 10 + 25.00 TO STA. 14 + 00.00	X-98 THRU X-101	-RPC_REV-	STA. 10 + 00.00 TO STA. 23 + 00.00	X-178 THRU X-184
-Y3-	STA. 10 + 00.00 TO STA. 12 + 75.00	X-102 THRU X-105	-RPD_REV-	STA. 11 + 00.00 TO STA. 21 + 00.00	X-185 THRU X-188
-Y4_REV-	STA. 10 + 00.00 TO STA. 14 + 00.00	X-106 THRU X-110	-RPBC-	STA. 10 + 00.00 TO STA. 16 + 50.00	X-189 THRU X-197
-Y5-	STA. 10 + 00.00 TO STA. 13 + 25.00	X-111 THRU X-114	-RPDA-	STA. 10 + 00.00 TO STA. 17 + 00.00	X-198 THRU X-207
-Y6-	STA. 10 + 00.00 TO STA. 12 + 25.00	X-115 THRU X-117	-LPA-	STA. 10 + 00.00 TO STA. 21 + 75.00	X-208 THRU X-223
-Y7-	STA. 10 + 00.00 TO STA. 13 + 50.00	X-118 THRU X-121	-LPC-	STA. 10 + 00.00 TO STA. 20 + 50.00	X-224 THRU X-238
-Y8-	STA. 10 + 00.00 TO STA. 12 + 75.00	X-122 THRU X-125	-SRV_REV-	STA. 10 + 00.00 TO STA. 26 + 00.00	X-239 THRU X-246
-Y9-	STA. 10 + 00.00 TO STA. 11 + 50.00	X-126 THRU X-127	-DRW01-	STA. 10 + 00.00 TO STA. 11 + 00.00	X-247 THRU X-248
-Y10-	STA. 10 + 00.00 TO STA. 12 + 00.00	X-128 THRU X-130	-DRW02-	STA. 10 + 00.00 TO STA. 12 + 75.00	X-249 THRU X-251
-Y11-	STA. 10 + 00.00 TO STA. 12 + 00.00	X-131 THRU X-132	-DRW03-	STA. 10 + 00.00 TO STA. 11 + 25.00	X-252
-Y12-	STA. 18 + 50.00 TO STA. 20 + 25.00	X-133 THRU X-134	-TEMP_DRW1-	STA. 10 + 00.00 TO STA. 15 + 00.00	X-253 THRU X-258
-Y13-	STA. 10 + 25.00 TO STA. 16 + 00.00	X-135 THRU X-140	-TEMP_RPBC1-	STA. 10 + 00.00 TO STA. 11 + 75.00	X-259 THRU X-260
-Y14-	STA. 10 + 00.00 TO STA. 11 + 50.00	X-141 THRU X-142	-TEMP_RPD-	STA. 19 + 50.00 TO STA. 22 + 25.00	X-261 THRU X-263
-Y17-	STA. 10 + 00.00 TO STA. 21 + 00.00	X-143 THRU X-154	-TEMP_RPDA-	STA. 14 + 25.00 TO STA. 18 + 00.00	X-264 THRU X-267
-Y17A-	STA. 10 + 00.00 TO STA. 15 + 00.00	X-155 THRU X-160			

8/23/99

25-APR-2024 17:54  
\\fpgw\gway\CorridorModeling\U5813\_RDY\_XPL\_X-0\_SHEET.dgn  
XNB

STATE OF NORTH CAROLINA  
DIVISION OF HIGHWAYS

NOTE: QUANTITIES ARE APPROXIMATE ONLY. THE RESIDENT ENGINEER WILL RE-CROSS-SECTION THE WORK ACCURATELY WHEN THE PROJECT IS STAKED OUT. THESE CROSS-SECTION NOTES WILL BE USED IN COMPUTING THE FINAL QUANTITIES FOR WHICH THE CONTRACTOR WILL BE PAID.

NOTE: EMBANKMENT DOES NOT INCLUDE BACKFILL FOR UNDERCUT

**CROSS-SECTION SUMMARY**

Station	Uncl. Exc.	Embt	Undercut	Station	Uncl. Exc.	Embt	Undercut	Station	Uncl. Exc.	Embt	Undercut	Station	Uncl. Exc.	Embt	Undercut	Station	Uncl. Exc.	Embt	Undercut
L	(cu. yd.)	(cu. yd.)	(cu. yd.)	L	(cu. yd.)	(cu. yd.)	(cu. yd.)	L	(cu. yd.)	(cu. yd.)	(cu. yd.)	L	(cu. yd.)	(cu. yd.)	(cu. yd.)	L	(cu. yd.)	(cu. yd.)	(cu. yd.)
17+50.00	0	0		44+00.00	219	95		68+50.00	43	490		92+50.00	55	292		116+00.00	0	0	
18+00.00	90	1		44+50.00	156	108	4	69+00.00	128	520		93+00.00	54	226		116+50.00	32	61	
18+50.00	72	1		45+00.00	159	113		69+50.00	258	227		93+50.00	60	160		117+00.00	49	39	
19+00.00	26	50						70+00.00	348	156		94+00.00	51	140		117+50.00	86	32	
19+50.00	11	94		<b>Station</b>	<b>Uncl. Exc.</b>	<b>Embt</b>	<b>Undercut</b>	70+50.00	424	217		94+50.00	16	118		118+00.00	62	27	
20+00.00	16	87						71+00.00	467	243		95+00.00	25	58		118+50.00	38	30	
20+50.00	23	77		<b>L</b>	<b>(cu. yd.)</b>	<b>(cu. yd.)</b>	<b>(cu. yd.)</b>	71+50.00	370	219		95+50.00	104	36		119+00.00	31	18	
21+00.00	35	71		45+00.00	0	0		72+00.00	158	521		96+00.00	190	54		119+50.00	22	0	
21+50.00	48	69		45+50.00	189	96		72+50.00	58	1233		96+50.00	273	67		120+00.00	12	119	
22+00.00	59	67		46+00.00	129	110		73+00.00	39	1547		97+00.00	355	77		120+50.00	9	281	
22+50.00	70	58		46+50.00	61	191		73+50.00	36	1337		97+50.00	589	88		121+00.00	15	277	
23+00.00	81	26		47+00.00	30	332		74+00.00	32	1067		98+00.00	801	84		121+50.00	37	214	
23+50.00	86	5		47+50.00	6	599		74+50.00	21	775		98+50.00	656	77		122+00.00	62	202	
24+00.00	92	3		48+00.00	1	549		75+00.00	12	562		99+00.00	425	59		122+50.00	73	148	
24+50.00	96	2		48+50.00	0	183						99+50.00	313	84		123+00.00	86	77	
25+00.00	99	1		49+00.00	0	24		<b>Station</b>	<b>Uncl. Exc.</b>	<b>Embt</b>	<b>Undercut</b>	100+00.00	250	119		123+50.00	71	40	
25+50.00	100	501		49+50.00	0	13						100+50.00	234	92		124+00.00	33	20	
26+00.00	95	1267		50+00.00	85	33	152	<b>L</b>	<b>(cu. yd.)</b>	<b>(cu. yd.)</b>	<b>(cu. yd.)</b>	101+00.00	275	78		124+50.00	21	40	
26+50.00	93	1756		50+50.00	316	64		75+00.00	0	0		101+50.00	396	85		125+00.00	30	29	
27+00.00	92	2293		51+00.00	474	98		75+50.00	10	291		102+00.00	540	84		125+50.00	37	13	
27+50.00	92	2796		51+50.00	420	117		76+00.00	165	80		102+50.00	571	94		126+00.00	21	21	
28+00.00	56	3930		52+00.00	346	123	109	76+50.00	506	42		103+00.00	395	161		126+50.00	12	31	
28+50.00	17	5371		52+50.00	198	227	350	77+00.00	364	30		103+50.00	119	198		127+00.00	10	40	
29+00.00	13	5623		53+00.00	29	474		77+50.00	50	23		104+00.00	0	182		127+50.00	6	25	
29+50.00	13	5133		53+50.00	0	810		78+00.00	88	29		104+50.00	0	186		128+00.00	6	11	
30+00.00	49	4688		54+00.00	0	1462		78+50.00	91	89		105+00.00	0	192		128+50.00	5	7	
30+50.00	83	4416		54+50.00	0	2114		79+00.00	63	133		105+50.00	10	482		129+00.00	8	4	
31+00.00	46	5047		55+00.00	0	1893		79+50.00	374	114									
31+50.00	25	5330		55+50.00	0	1473		80+00.00	707	90		<b>Station</b>	<b>Uncl. Exc.</b>	<b>Embt</b>	<b>Undercut</b>	<b>Station</b>	<b>Uncl. Exc.</b>	<b>Embt</b>	<b>Undercut</b>
32+00.00	28	3035		56+00.00	0	1459		80+50.00	585	77						<b>L</b>	<b>(cu. yd.)</b>	<b>(cu. yd.)</b>	<b>(cu. yd.)</b>
32+50.00	17	892		56+50.00	0	1309		81+00.00	270	73						<b>Y</b>	<b>(cu. yd.)</b>	<b>(cu. yd.)</b>	<b>(cu. yd.)</b>
33+00.00	27	526		57+00.00	1	969		81+50.00	73	78		105+50.00	0	0		14+50.00	0	0	
33+50.00	88	425		57+50.00	8	567		82+00.00	53	143		106+00.00	32	430		15+00.00	60	19	
34+00.00	201	435		58+00.00	27	255		82+50.00	56	143		106+50.00	60	175		15+50.00	41	57	
34+50.00	309	391		58+50.00	58	78		83+00.00	81	72		107+00.00	88	142		16+00.00	20	103	
35+00.00	502	275		59+00.00	150	69		83+50.00	108	58		107+50.00	109	114		16+50.00	6	75	
35+50.00	546	189		59+50.00	166	129		84+00.00	90	58		108+00.00	122	97		17+00.00	0	25	
36+00.00	356	181		60+00.00	135	122		84+50.00	58	65		108+50.00	123	98		17+50.00	0	68	
36+50.00	186	215		60+50.00	191	65		85+00.00	33	118		109+00.00	110	95		18+00.00	0	294	
37+00.00	51	231		61+00.00	267	52		85+50.00	8	147		109+50.00	75	90		18+50.00	0	1327	
37+50.00	0	226		61+50.00	489	61		86+00.00	16	119		110+00.00	32	56		19+00.00	0	2484	
38+00.00	0	228		62+00.00	626	58		86+50.00	24	127		110+50.00	11	11		19+50.00	0	2901	
38+50.00	15	258		62+50.00	552	93		87+00.00	24	72		111+00.00	46	17		20+00.00	0	3159	
39+00.00	42	395		63+00.00	600	101		87+50.00	14	2		111+50.00	53	29		20+50.00	0	3368	
39+50.00	27	440		63+50.00	653	79		88+00.00	5	4		112+00.00	18	20		21+00.00	0	3333	
40+00.00	0	278		64+00.00	477	108		88+50.00	22	4		112+50.00	16	13					
40+50.00	30	196		64+50.00	439	159		89+00.00	38	36		113+00.00	16	9		<b>Station</b>	<b>Uncl. Exc.</b>	<b>Embt</b>	<b>Undercut</b>
41+00.00	51	178		65+00.00	602	158		89+50.00	30	67		113+50.00	15	4		<b>Y</b>	<b>(cu. yd.)</b>	<b>(cu. yd.)</b>	<b>(cu. yd.)</b>
41+50.00	43	127		65+50.00	578	151		90+00.00	35	57						23+00.00	0	0	
42+00.00	50	87		66+00.00	578	355		90+50.00	48	60						23+50.00	0	3228	
42+50.00	157	75		67+00.00	69	219		91+00.00	49	121						24+00.00	0	2387	
43+00.00	252	81		67+50.00	62	305		91+50.00	41	245						24+50.00	0	2322	
43+50.00	248	88		68+00.00	54	307		92+00.00	42	327									

STATE OF NORTH CAROLINA  
DIVISION OF HIGHWAYS

NOTE: QUANTITIES ARE APPROXIMATE ONLY. THE RESIDENT ENGINEER WILL RE-CROSS-SECTION THE WORK ACCURATELY WHEN THE PROJECT IS STAKES OUT. THESE CROSS-SECTION NOTES WILL BE USED IN COMPUTING THE FINAL QUANTITIES FOR WHICH THE CONTRACTOR WILL BE PAID.

NOTE: EMBANKMENT DOES NOT INCLUDE BACKFILL FOR UNDERCUT

CROSS-SECTION SUMMARY

Table with columns: Station, Uncl. Exc., Embt, Undercut, Station, Uncl. Exc., Embt, Undercut, Station, Uncl. Exc., Embt, Undercut, Station, Uncl. Exc., Embt, Undercut, Station, Uncl. Exc., Embt, Undercut. Rows include stationing from 25+00.00 to 50+50.00 and Y1 through Y13.

12/06/07

STATE OF NORTH CAROLINA  
DIVISION OF HIGHWAYS

PROJ. REFERENCE NO. U-5813  
SHEET NO. X-0C

NOTE: QUANTITIES ARE APPROXIMATE ONLY. THE RESIDENT ENGINEER WILL RE-CROSS-SECTION THE WORK ACCURATELY WHEN THE PROJECT IS STAKED OUT. THESE CROSS-SECTION NOTES WILL BE USED IN COMPUTING THE FINAL QUANTITIES FOR WHICH THE CONTRACTOR WILL BE PAID.

NOTE: EMBANKMENT DOES NOT INCLUDE BACKFILL FOR UNDERCUT

**CROSS-SECTION SUMMARY**

Station	Uncl. Exc.	Embt	Undercut	Station	Uncl. Exc.	Embt	Undercut	Station	Uncl. Exc.	Embt	Undercut	Station	Uncl. Exc.	Embt	Undercut	Station	Uncl. Exc.	Embt	Undercut
Y13	(cu. yd.)	(cu. yd.)	(cu. yd.)	Y17	(cu. yd.)	(cu. yd.)	(cu. yd.)	Y19	(cu. yd.)	(cu. yd.)	(cu. yd.)	Rpb_rev	(cu. yd.)	(cu. yd.)	(cu. yd.)	Rpc_rev	(cu. yd.)	(cu. yd.)	(cu. yd.)
12+25.00	147	0		16+75.00	51	10		11+25.00	5	13									
12+50.00	156	0		17+00.00	18	24		11+50.00	5	14		17+00.00	315	38					
12+75.00	178	0		17+25.00	0	36		11+75.00	4	7		23+00.00			0	743			
13+00.00	172	0		17+50.00	0	43		12+00.00	3	6		17+50.00	160	132					
13+25.00	135	0		17+75.00	0	50		12+25.00	2	10									
13+50.00	97	0		18+00.00	16	52		12+50.00	0	25		18+00.00	159	250		<b>Station</b>	<b>Uncl. Exc.</b>	<b>Embt</b>	<b>Undercut</b>
13+75.00	81	0		18+25.00	40	41		12+75.00	0	48						<b>Rpd_rev</b>	<b>(cu. yd.)</b>	<b>(cu. yd.)</b>	<b>(cu. yd.)</b>
14+00.00	84	0		18+50.00	48	23		13+00.00	0	121		18+50.00	175	294					
14+25.00	73	0		18+75.00	24	21		13+25.00	0	178									
14+50.00	51	0		19+00.00	2	21						19+00.00	161	282		12+00.00	0	0	
14+75.00	24	1		19+25.00	19	10		<b>Station</b>	<b>Uncl. Exc.</b>	<b>Embt</b>	<b>Undercut</b>								
15+00.00	5	2		19+50.00	35	6		<b>Rpa_rev</b>	<b>(cu. yd.)</b>	<b>(cu. yd.)</b>	<b>(cu. yd.)</b>	19+50.00	184	235		12+50.00	45	4	
				19+75.00	38	5													
<b>Station</b>	<b>Uncl. Exc.</b>	<b>Embt</b>	<b>Undercut</b>	20+00.00	41	5						20+00.00	128	135		13+00.00	36	8	
<b>Y14</b>	<b>(cu. yd.)</b>	<b>(cu. yd.)</b>	<b>(cu. yd.)</b>	20+25.00	21	6						20+50.00	52	53					
10+00.00	0	0		20+50.00	1	6		12+50.00	0	0									
10+25.00	4	9										<b>Station</b>	<b>Uncl. Exc.</b>	<b>Embt</b>	<b>Undercut</b>				
10+50.00	4	15		<b>Station</b>	<b>Uncl. Exc.</b>	<b>Embt</b>	<b>Undercut</b>	13+00.00	45	59		<b>Rpc_rev</b>	<b>(cu. yd.)</b>	<b>(cu. yd.)</b>	<b>(cu. yd.)</b>	14+00.00	119	9	
10+75.00	12	18		<b>Y17A</b>	<b>(cu. yd.)</b>	<b>(cu. yd.)</b>	<b>(cu. yd.)</b>	13+50.00	39	100		14+50.00	0	0		14+50.00	107	15	
11+00.00	21	19		12+00.00	0	0	118	14+00.00	42	189		15+00.00	49	4		15+00.00	104	17	
11+25.00	25	28		12+25.00	300	3	189	14+50.00	43	234		15+50.00	38	11		15+50.00	116	10	
11+50.00	26	21		12+50.00	110	3	119	15+00.00	63	241		16+00.00	36	18		16+00.00	145	4	
<b>Station</b>	<b>Uncl. Exc.</b>	<b>Embt</b>	<b>Undercut</b>	12+75.00	62	4	94	15+50.00	88	242		16+50.00	31	31		16+50.00	92	24	
<b>Y17</b>	<b>(cu. yd.)</b>	<b>(cu. yd.)</b>	<b>(cu. yd.)</b>	13+00.00	57	11	92	16+00.00	128	169		17+00.00	19	56		17+00.00	52	84	
10+25.00	0	0		13+25.00	39	18	92	16+50.00	321	54		17+50.00	5	80		17+50.00	76	139	
10+50.00	115	9		13+50.00	23	48	83	17+00.00	380	44		18+00.00	0	108		18+00.00	76	150	
10+75.00	255	0		13+75.00	13	70	73	17+50.00	215	85		18+50.00	0	136		18+50.00	74	163	
11+00.00	384	0		14+00.00	8	106	80	18+00.00	79	90		19+00.00	0	167		19+00.00	83	260	
11+25.00	545	0		14+25.00	1	166		18+50.00	33	70		19+50.00	0	223		19+50.00	114	405	
11+50.00	639	0		14+50.00	0	186													
11+75.00	645	0		14+75.00	0	166		<b>Station</b>	<b>Uncl. Exc.</b>	<b>Embt</b>	<b>Undercut</b>	20+00.00	0	342		20+00.00	139	454	
12+00.00	631	0		15+00.00	0	101		<b>Rpb_rev</b>	<b>(cu. yd.)</b>	<b>(cu. yd.)</b>	<b>(cu. yd.)</b>	20+50.00	0	445		20+50.00	139	297	
12+25.00	625	0		<b>Station</b>	<b>Uncl. Exc.</b>	<b>Embt</b>	<b>Undercut</b>	15+00.00	0	0		21+00.00	0	488		21+00.00	84	112	
12+50.00	614	0		<b>Y18</b>	<b>(cu. yd.)</b>	<b>(cu. yd.)</b>	<b>(cu. yd.)</b>	15+50.00	38	54		21+50.00	0	524					
12+75.00	573	0		10+50.00	0	0		16+00.00	125	57		22+00.00	0	510					
13+00.00	524	0		10+75.00	61	9		16+50.00	314	28		22+50.00	0	568					
13+25.00	479	0		11+00.00	64	6													
13+50.00	438	0		11+25.00	26	10													
13+75.00	401	0		11+50.00	11	7													
14+00.00	390	0		11+75.00	5	3													
14+25.00	383	0		12+00.00	4	3													
14+50.00	348	0		<b>Station</b>	<b>Uncl. Exc.</b>	<b>Embt</b>	<b>Undercut</b>												
14+75.00	285	0		<b>Y19</b>	<b>(cu. yd.)</b>	<b>(cu. yd.)</b>	<b>(cu. yd.)</b>												
15+00.00	194	0		10+00.00	0	0													
15+25.00	101	9		10+25.00	24	64													
15+50.00	41	14		10+50.00	15	45													
15+75.00	25	5		10+75.00	7	14													
16+00.00	47	0		11+00.00	6	8													
16+25.00	65	0																	
16+50.00	69	1																	

C:\Users\jw\Documents\Projects\U5813.RDY\_XSC\_VOL\_SUM.dgn  
 12/06/07





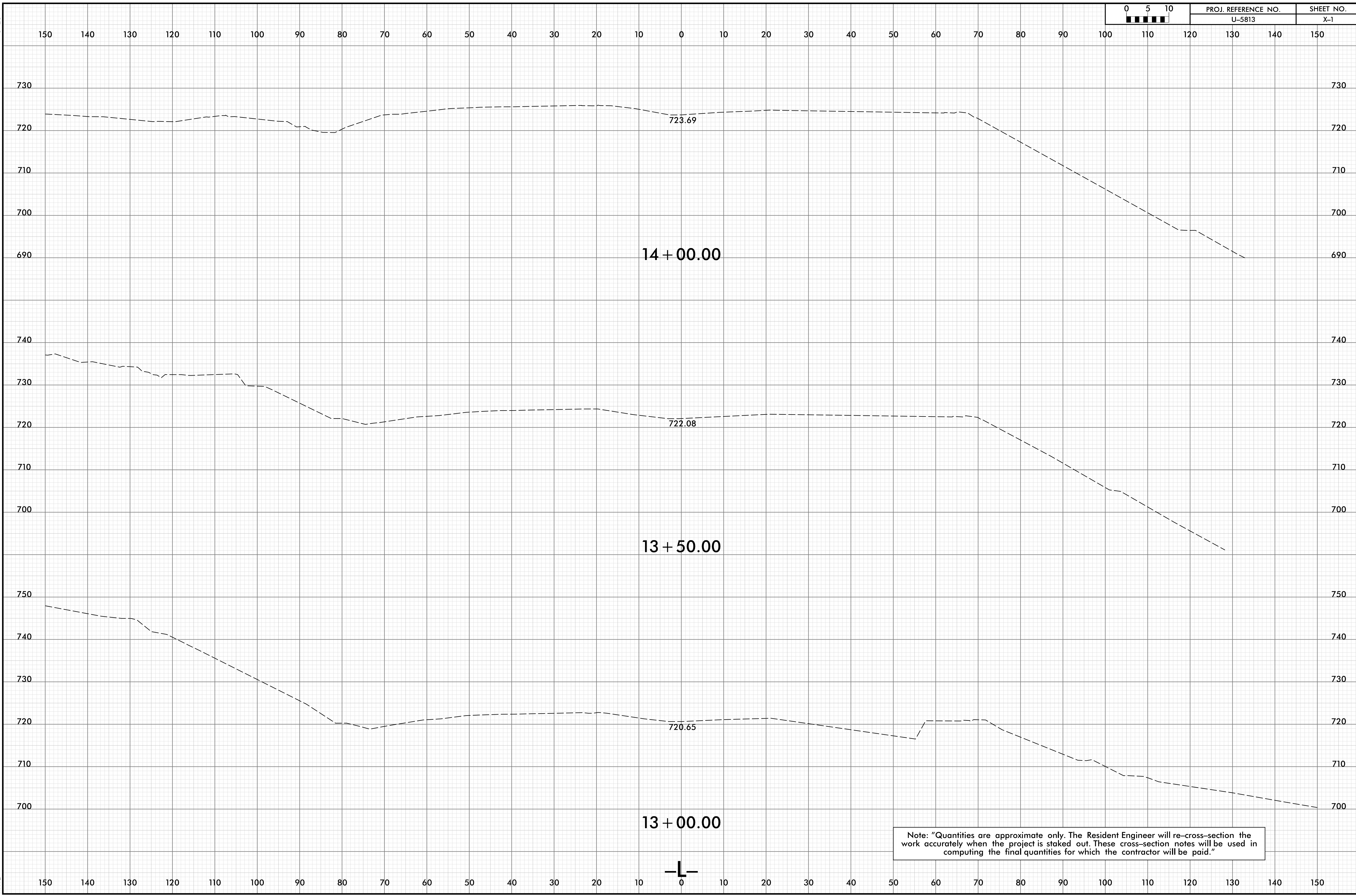

Note: "Quantities are approximate only. The Resident Engineer will re-cross-section the work accurately when the project is staked out. These cross-section notes will be used in computing the final quantities for which the contractor will be paid."

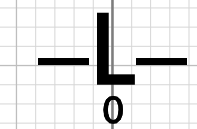

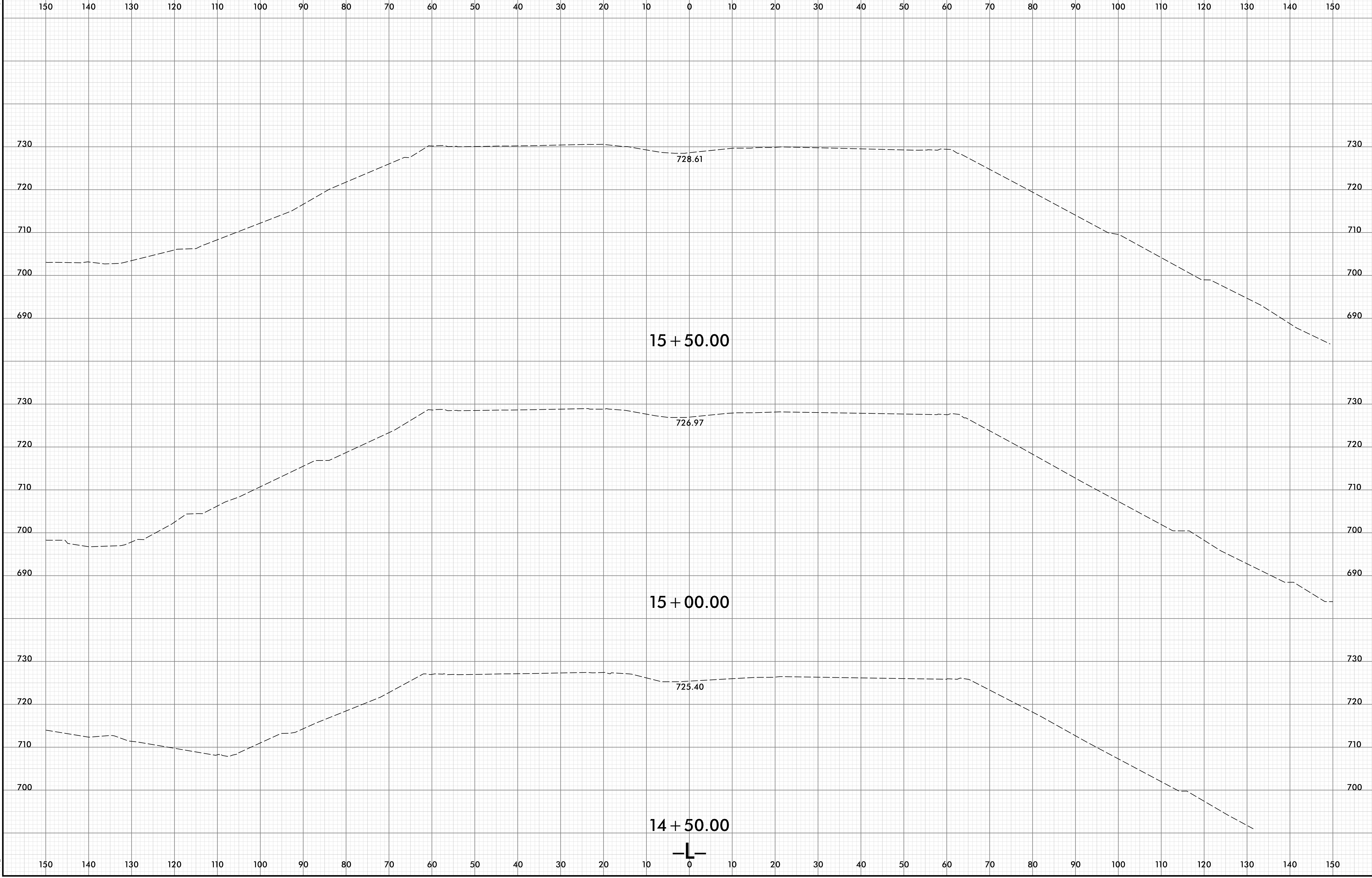

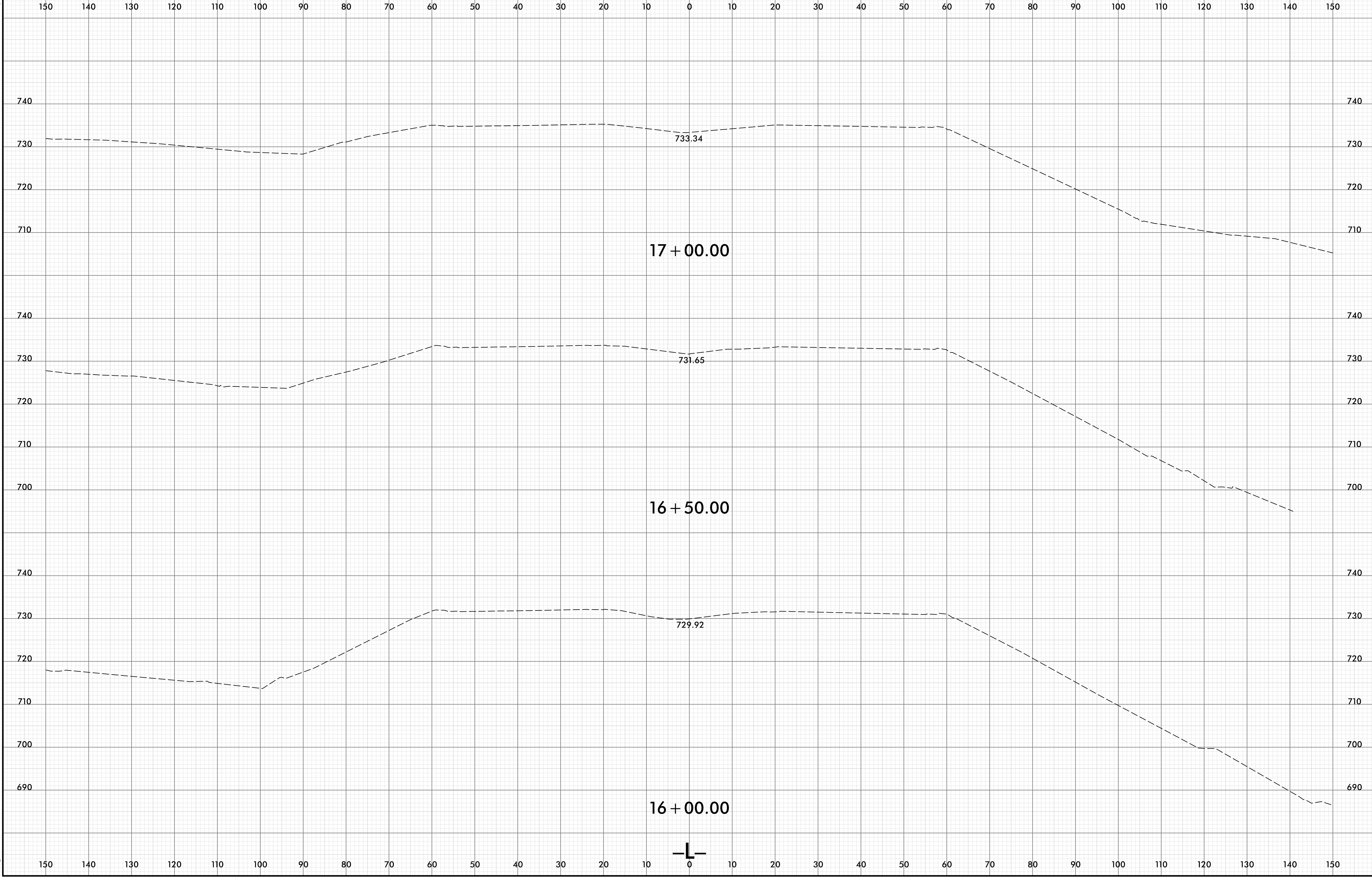



8/23/99



PROJ. REFERENCE NO.	SHEET NO.
U-5813	X-4

150 140 130 120 110 100 90 80 70 60 50 40 30 20 10 0 10 20 30 40 50 60 70 80 90 100 110 120 130 140 150

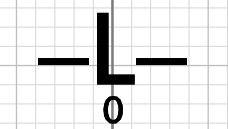
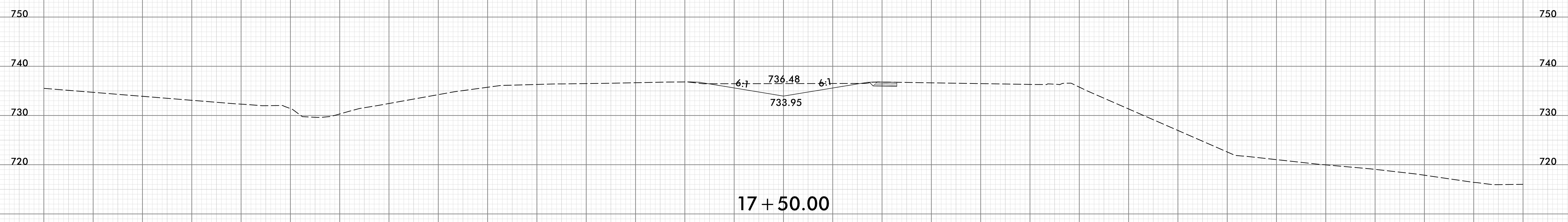
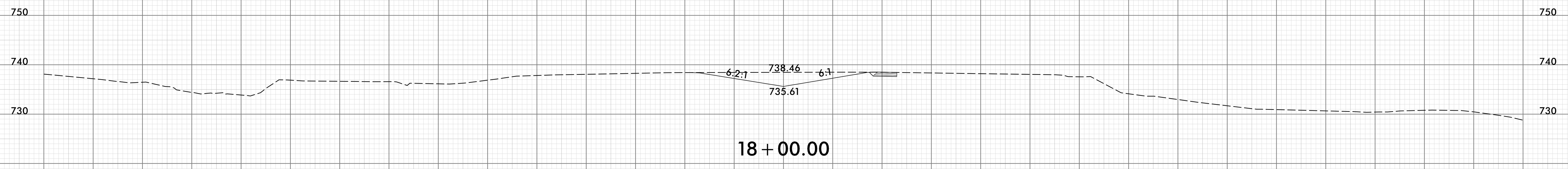
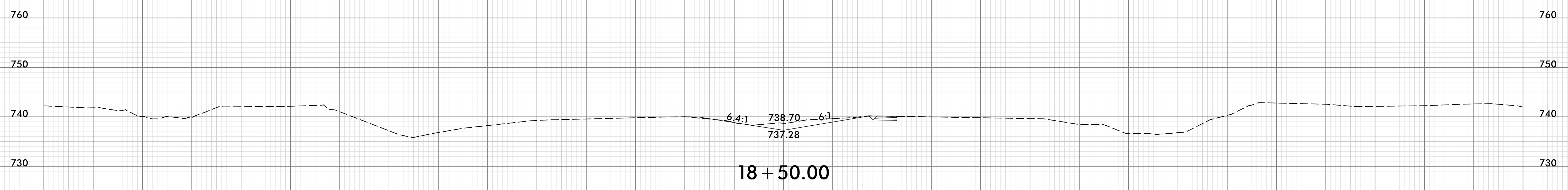
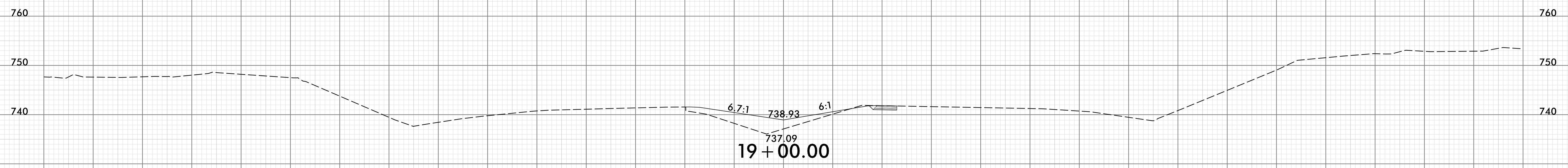

150 140 130 120 110 100 90 80 70 60 50 40 30 20 10 0 10 20 30 40 50 60 70 80 90 100 110 120 130 140 150

25-APR-2024 17:55  
 \\Redway\CorridorModeling\U5813\_RDY.L\_XPL.dgn  
 HNTB

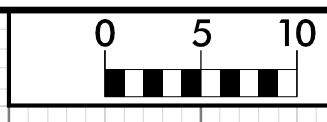

150 140 130 120 110 100 90 80 70 60 50 40 30 20 10 0 10 20 30 40 50 60 70 80 90 100 110 120 130 140 150

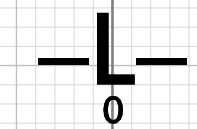
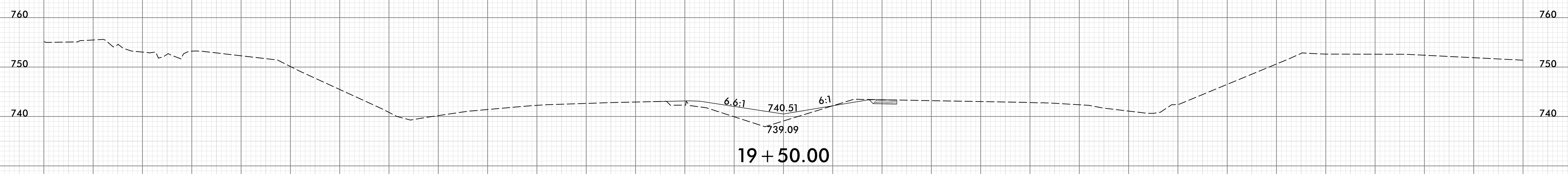
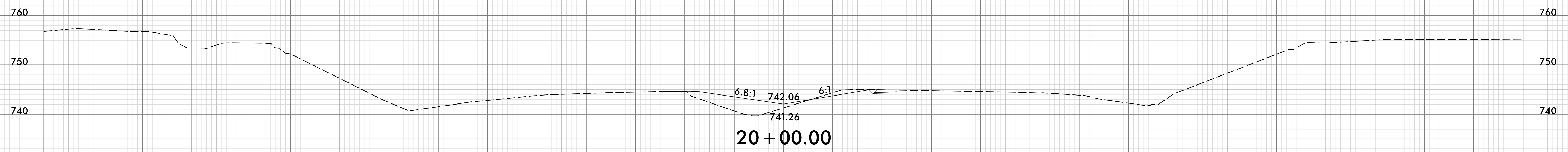
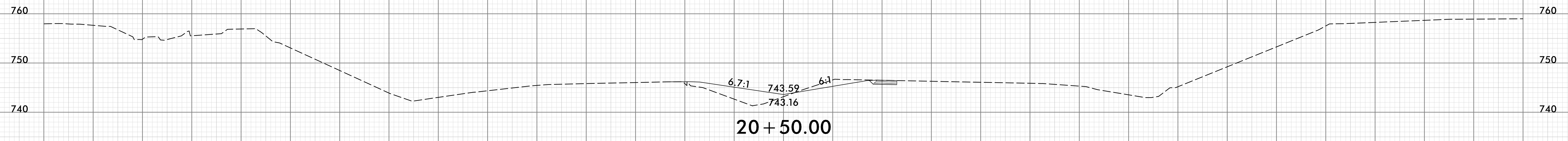
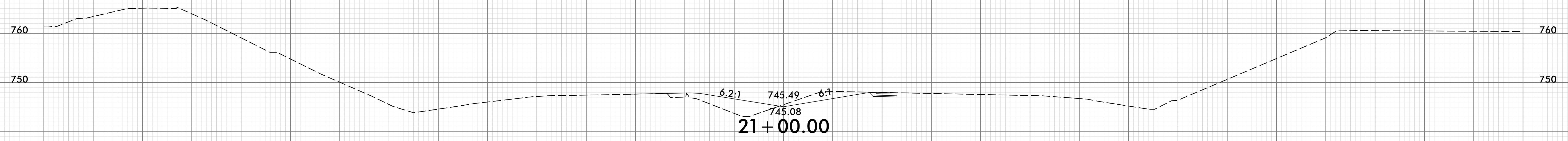

150 140 130 120 110 100 90 80 70 60 50 40 30 20 10 0 10 20 30 40 50 60 70 80 90 100 110 120 130 140 150

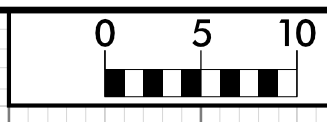

150 140 130 120 110 100 90 80 70 60 50 40 30 20 10 0 10 20 30 40 50 60 70 80 90 100 110 120 130 140 150

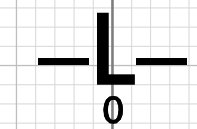
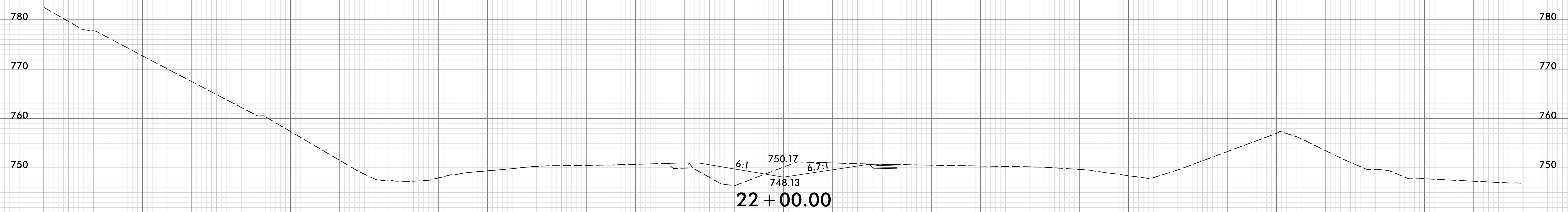
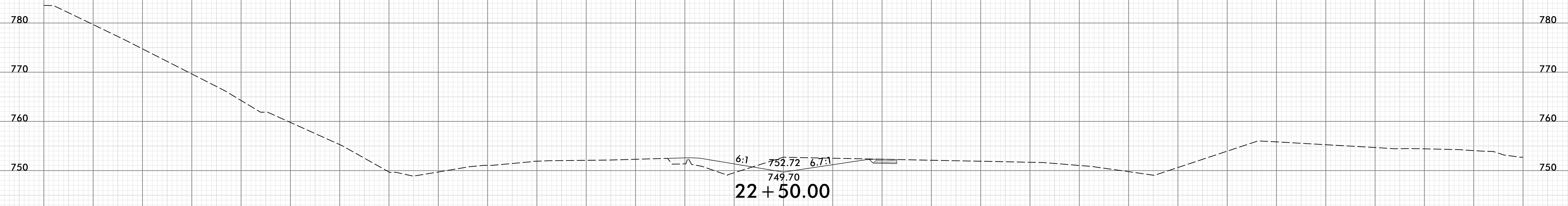

150 140 130 120 110 100 90 80 70 60 50 40 30 20 10 0 10 20 30 40 50 60 70 80 90 100 110 120 130 140 150

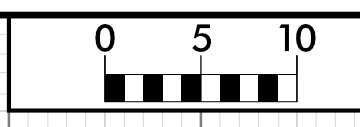

150 140 130 120 110 100 90 80 70 60 50 40 30 20 10 0 10 20 30 40 50 60 70 80 90 100 110 120 130 140 150

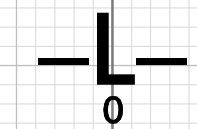
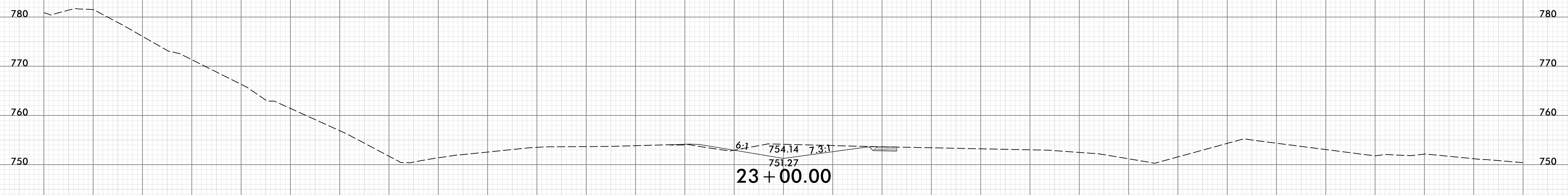
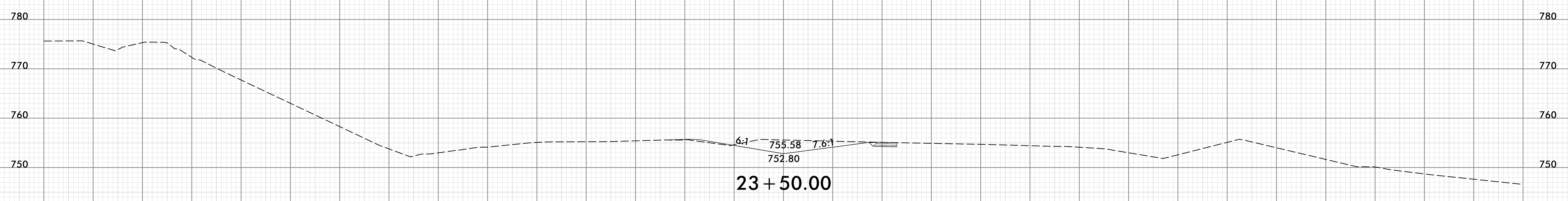
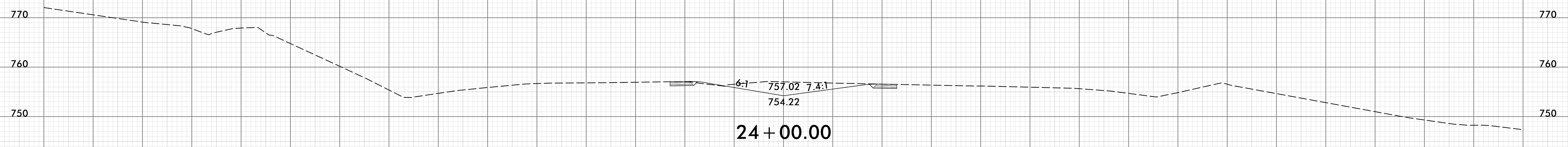





150 140 130 120 110 100 90 80 70 60 50 40 30 20 10 0 10 20 30 40 50 60 70 80 90 100 110 120 130 140 150

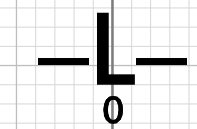
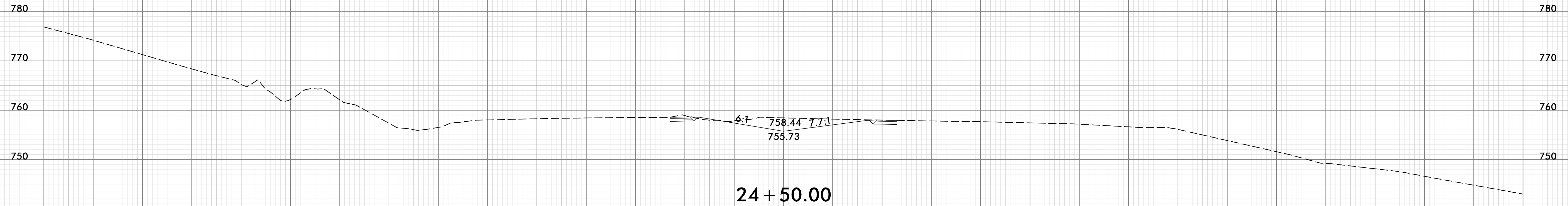
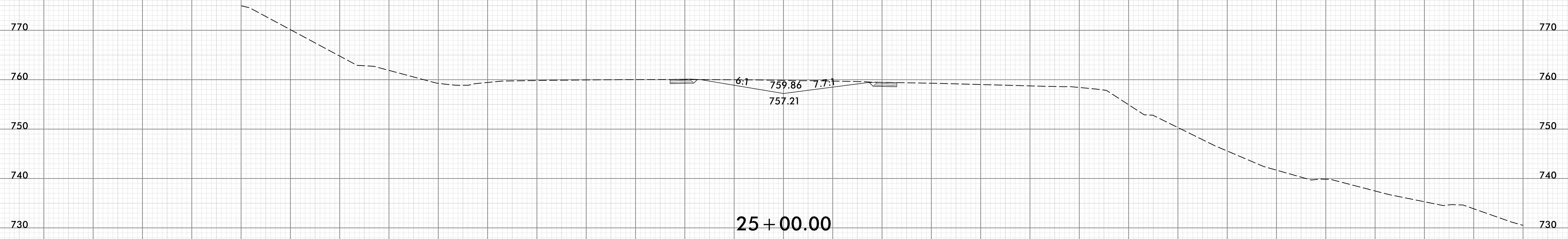
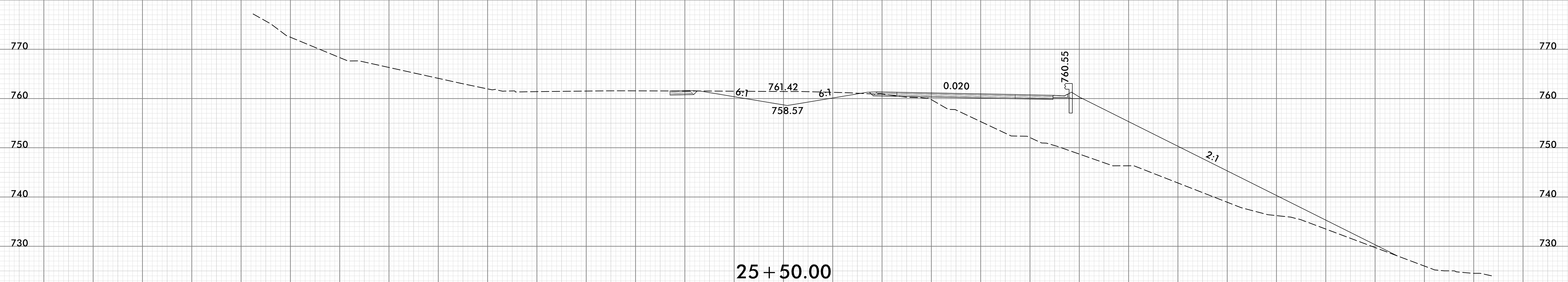

150 140 130 120 110 100 90 80 70 60 50 40 30 20 10 0 10 20 30 40 50 60 70 80 90 100 110 120 130 140 150

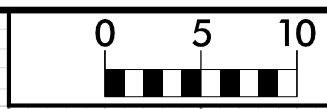

150 140 130 120 110 100 90 80 70 60 50 40 30 20 10 0 10 20 30 40 50 60 70 80 90 100 110 120 130 140 150

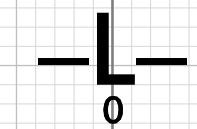
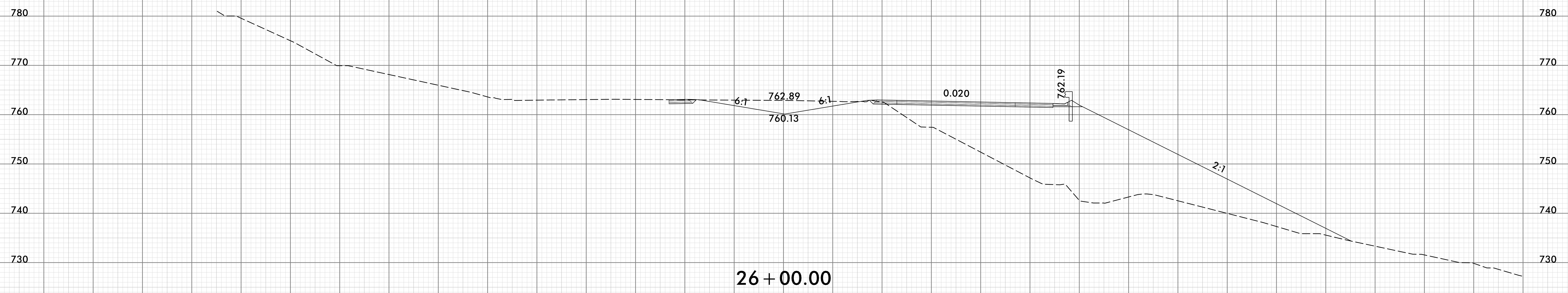
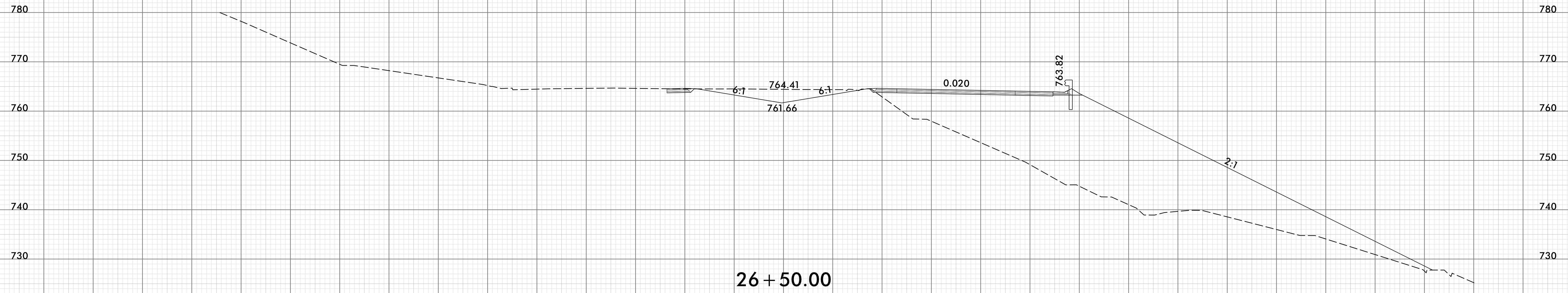

150 140 130 120 110 100 90 80 70 60 50 40 30 20 10 0 10 20 30 40 50 60 70 80 90 100 110 120 130 140 150

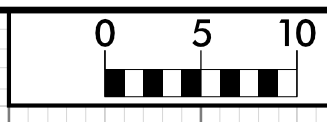

150 140 130 120 110 100 90 80 70 60 50 40 30 20 10 0 10 20 30 40 50 60 70 80 90 100 110 120 130 140 150

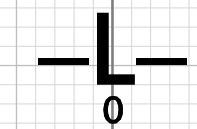
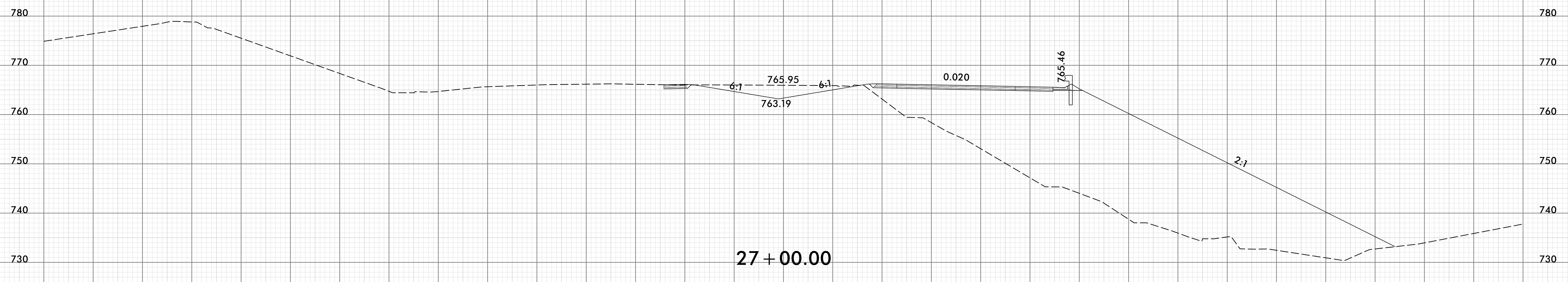
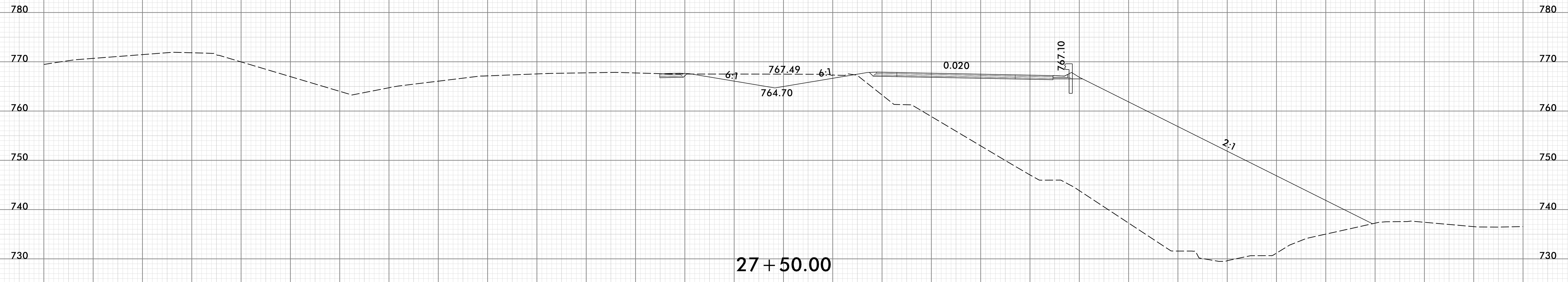

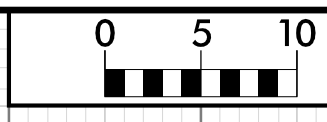

150 140 130 120 110 100 90 80 70 60 50 40 30 20 10 0 10 20 30 40 50 60 70 80 90 100 110 120 130 140 150

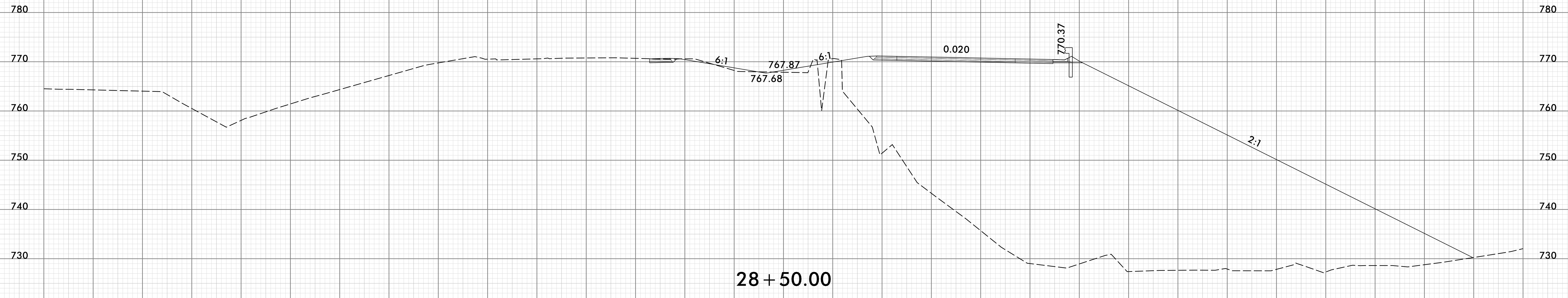

150 140 130 120 110 100 90 80 70 60 50 40 30 20 10 0 10 20 30 40 50 60 70 80 90 100 110 120 130 140 150

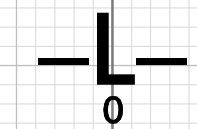



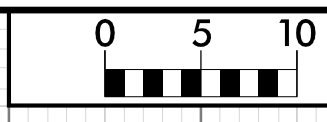

150 140 130 120 110 100 90 80 70 60 50 40 30 20 10 0 10 20 30 40 50 60 70 80 90 100 110 120 130 140 150

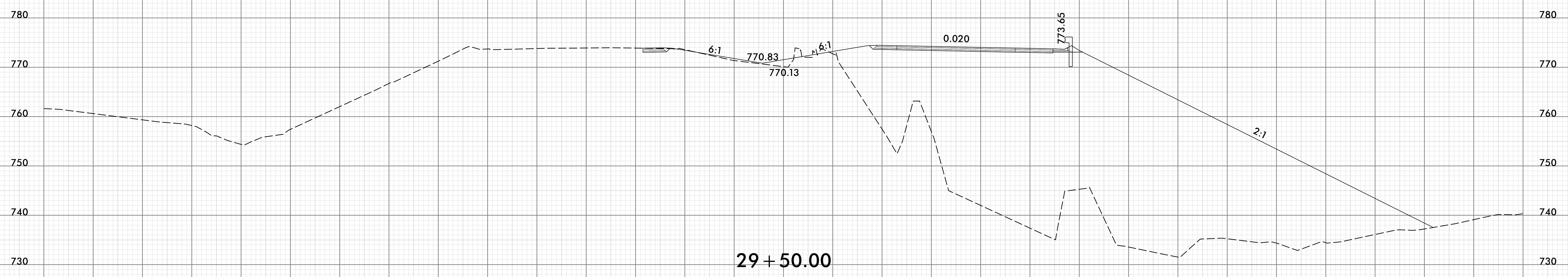

150 140 130 120 110 100 90 80 70 60 50 40 30 20 10 0 10 20 30 40 50 60 70 80 90 100 110 120 130 140 150

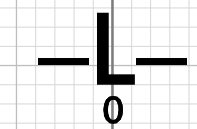

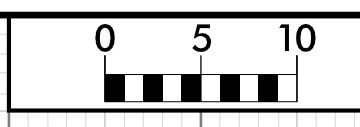

150 140 130 120 110 100 90 80 70 60 50 40 30 20 10 0 10 20 30 40 50 60 70 80 90 100 110 120 130 140 150

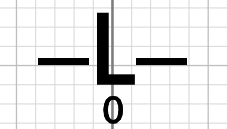
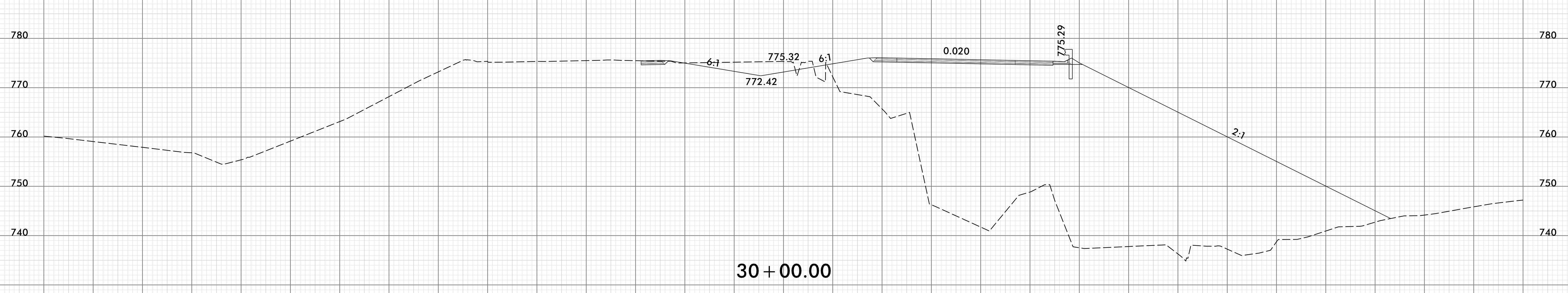

150 140 130 120 110 100 90 80 70 60 50 40 30 20 10 0 10 20 30 40 50 60 70 80 90 100 110 120 130 140 150

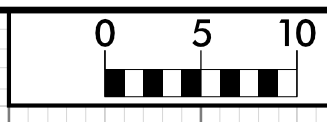

150 140 130 120 110 100 90 80 70 60 50 40 30 20 10 0 10 20 30 40 50 60 70 80 90 100 110 120 130 140 150

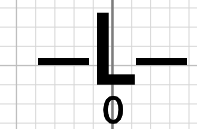
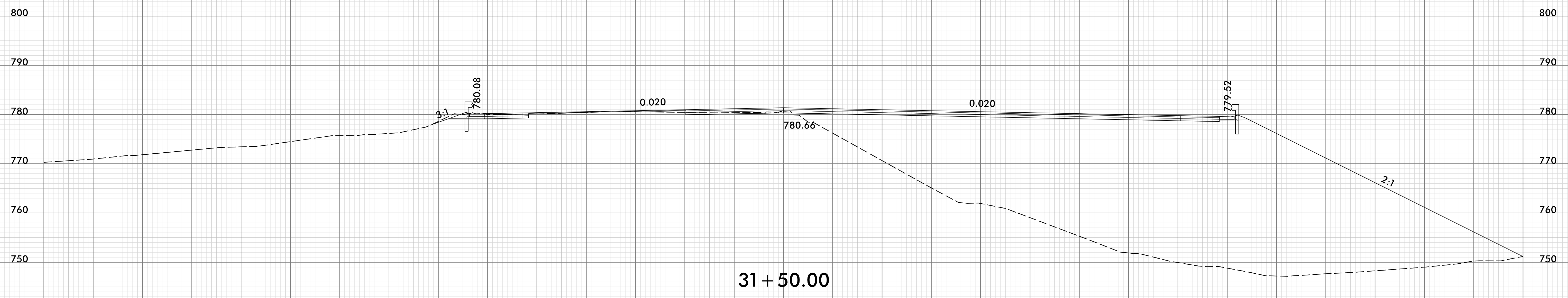
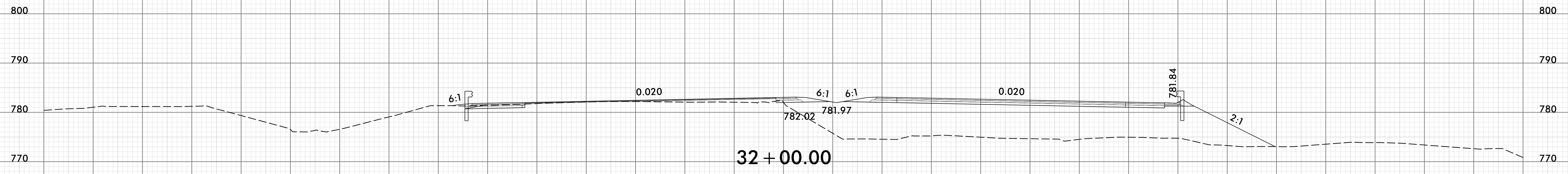
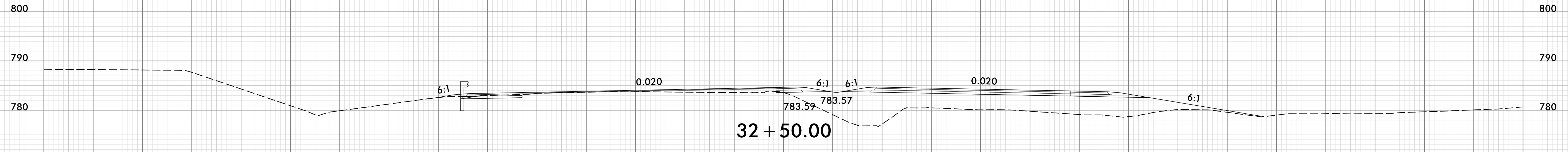

150 140 130 120 110 100 90 80 70 60 50 40 30 20 10 0 10 20 30 40 50 60 70 80 90 100 110 120 130 140 150

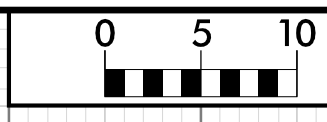

150 140 130 120 110 100 90 80 70 60 50 40 30 20 10 0 10 20 30 40 50 60 70 80 90 100 110 120 130 140 150

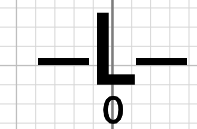
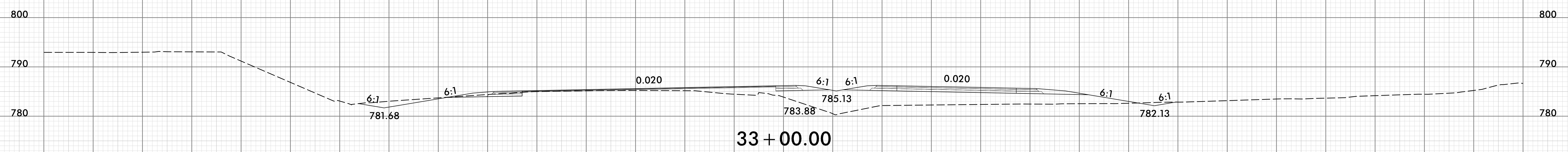
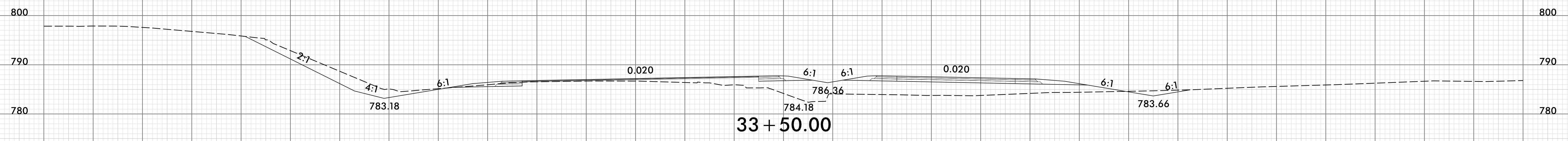
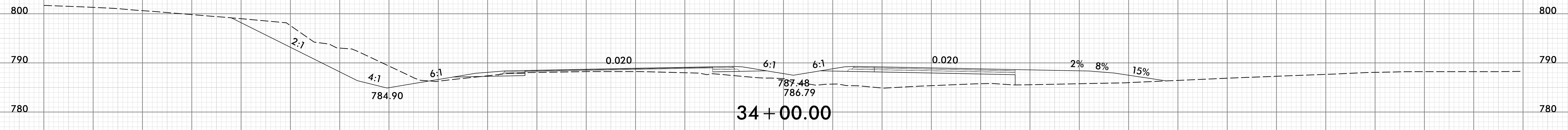
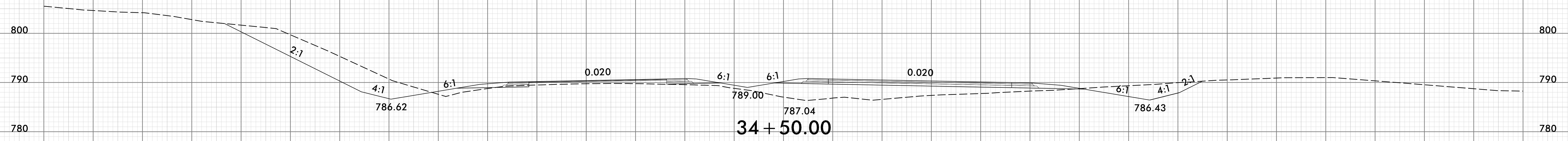

150 140 130 120 110 100 90 80 70 60 50 40 30 20 10 0 10 20 30 40 50 60 70 80 90 100 110 120 130 140 150



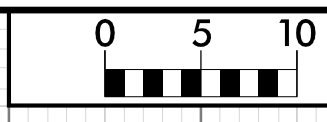

150 140 130 120 110 100 90 80 70 60 50 40 30 20 10 0 10 20 30 40 50 60 70 80 90 100 110 120 130 140 150

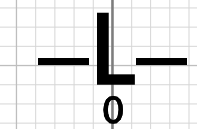
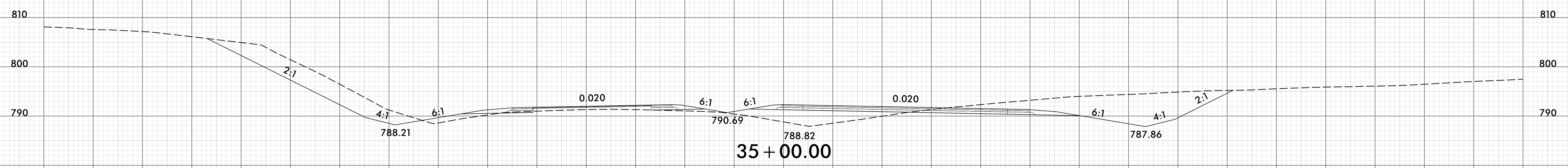
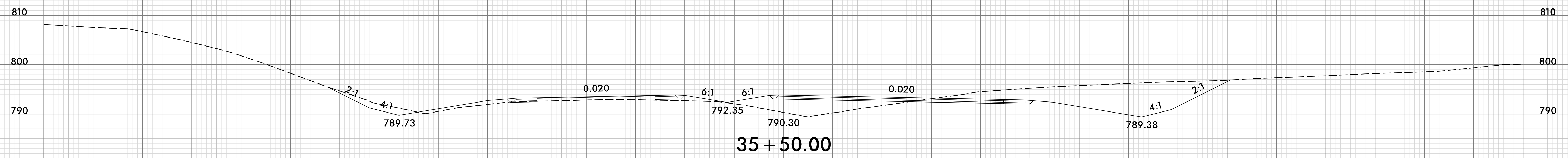
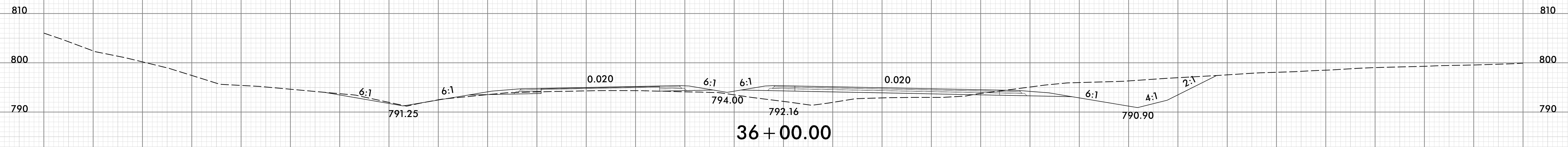
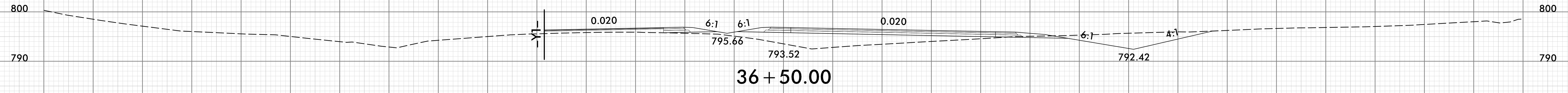

150 140 130 120 110 100 90 80 70 60 50 40 30 20 10 0 10 20 30 40 50 60 70 80 90 100 110 120 130 140 150

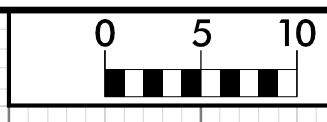

150 140 130 120 110 100 90 80 70 60 50 40 30 20 10 0 10 20 30 40 50 60 70 80 90 100 110 120 130 140 150

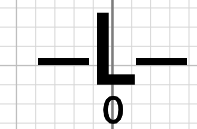
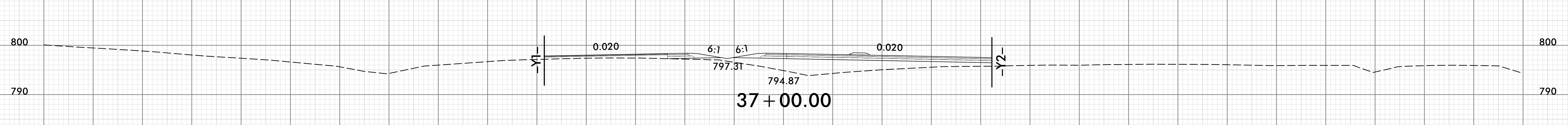
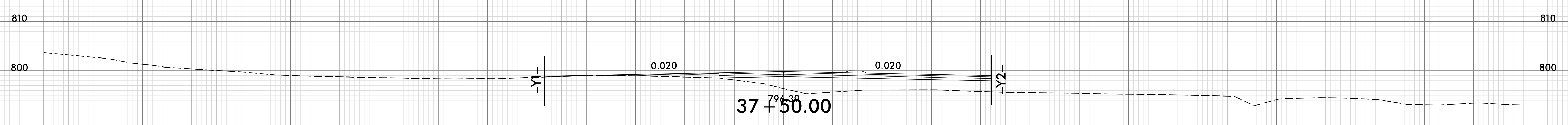
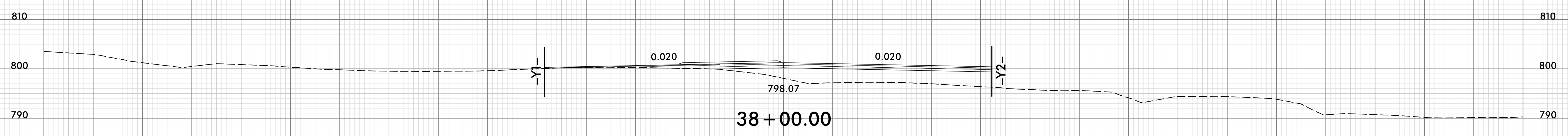
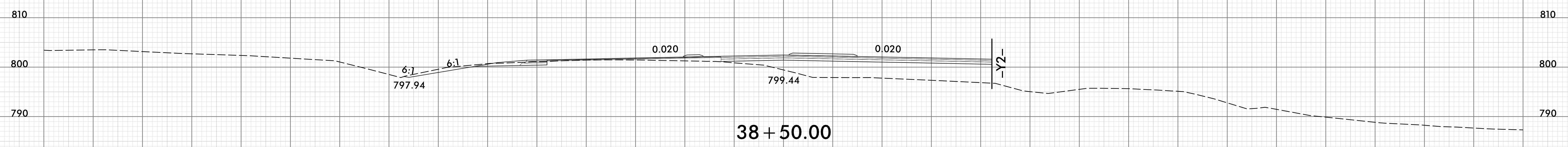
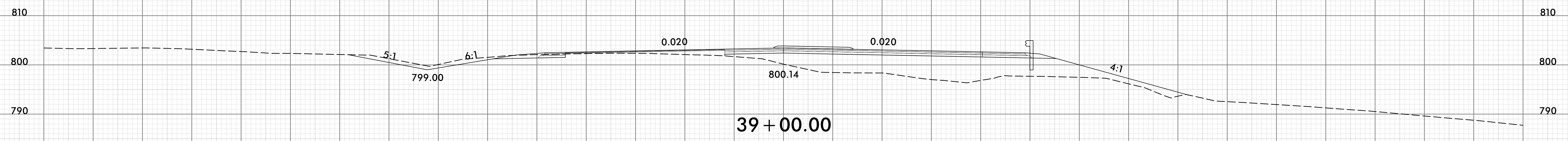

150 140 130 120 110 100 90 80 70 60 50 40 30 20 10 0 10 20 30 40 50 60 70 80 90 100 110 120 130 140 150

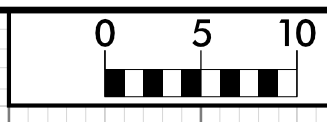

150 140 130 120 110 100 90 80 70 60 50 40 30 20 10 0 10 20 30 40 50 60 70 80 90 100 110 120 130 140 150

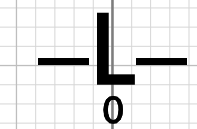
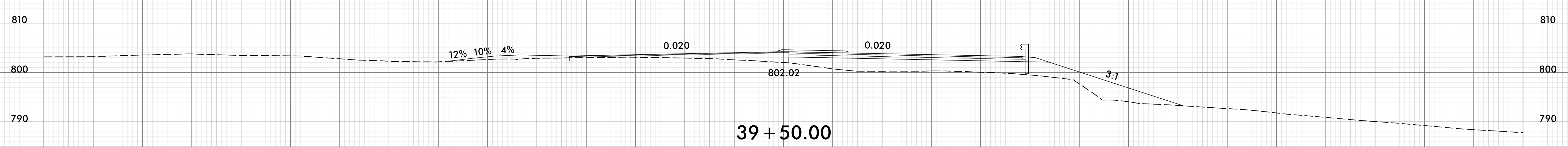
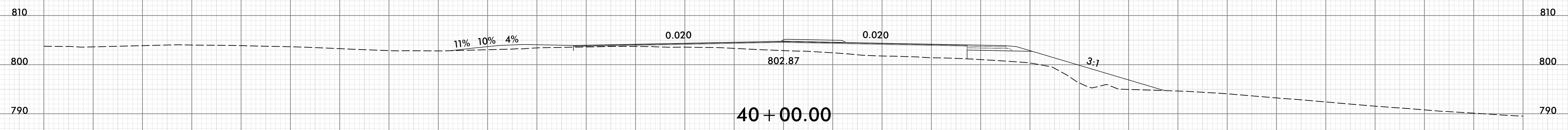
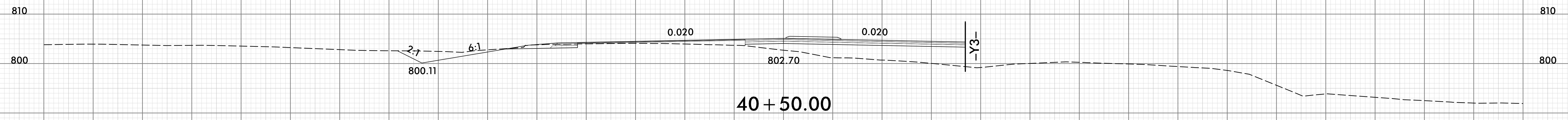
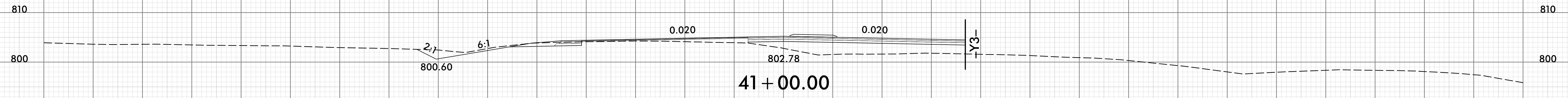
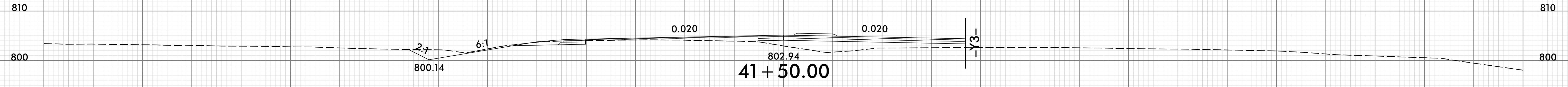

150 140 130 120 110 100 90 80 70 60 50 40 30 20 10 0 10 20 30 40 50 60 70 80 90 100 110 120 130 140 150

8/23/99

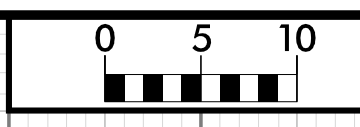

PROJ. REFERENCE NO.	SHEET NO.
U-5813	X-19

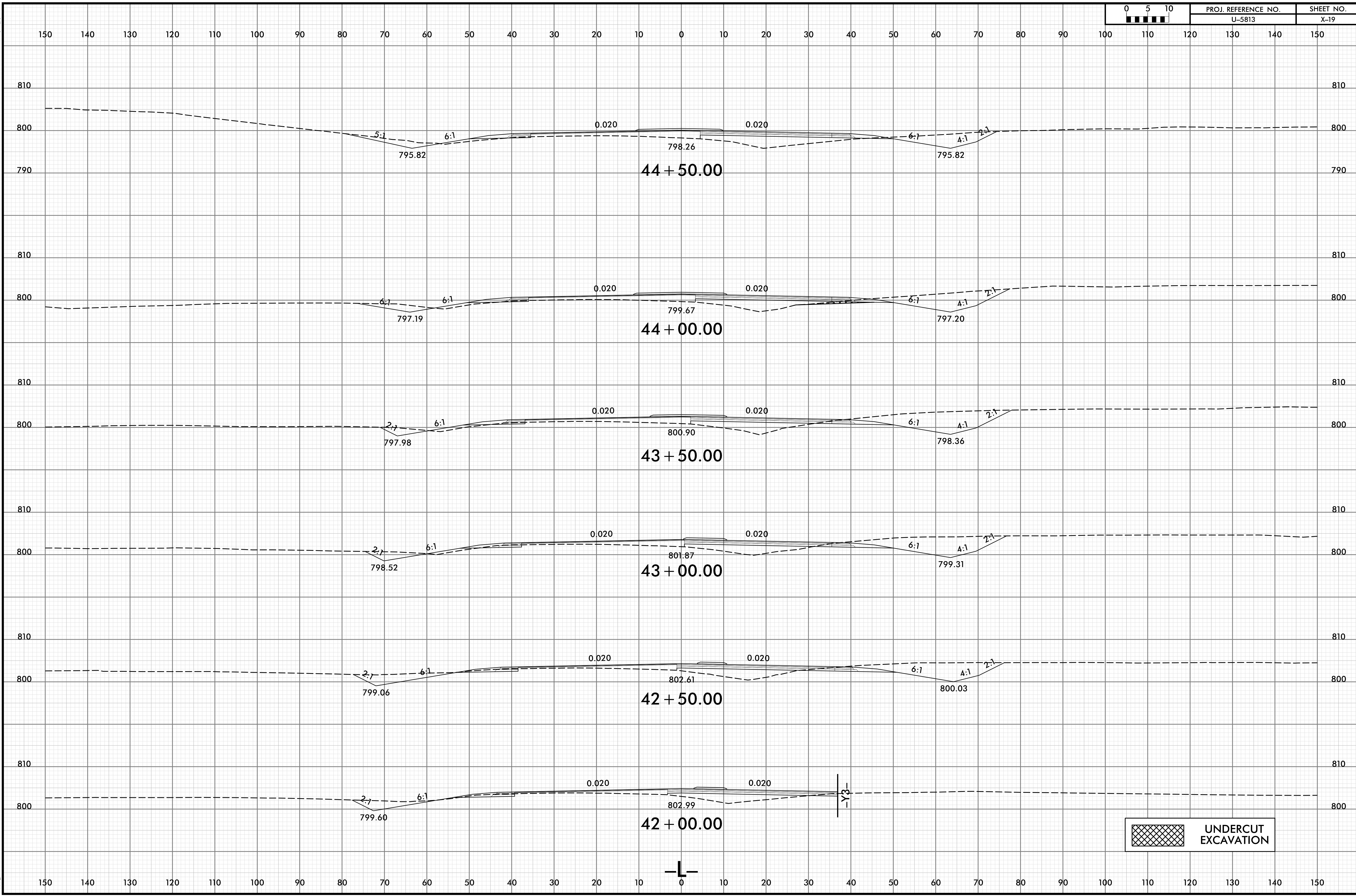

25-APR-2024 17:55  
 \\Roadway\CorridorModeling\U5813\_RDY.L\_XPL.dgn  
 HNTB

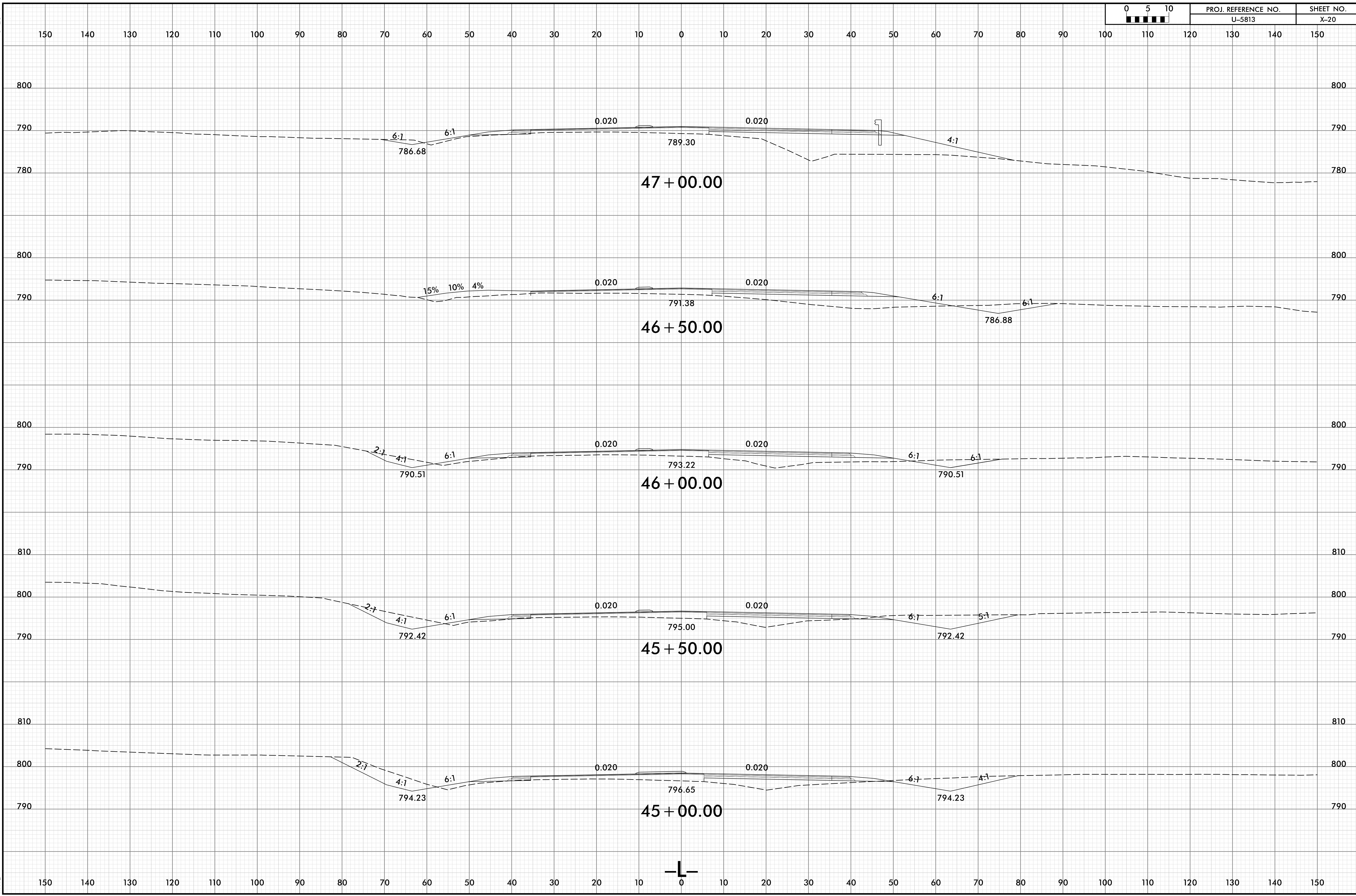

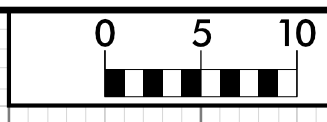

150 140 130 120 110 100 90 80 70 60 50 40 30 20 10 0 10 20 30 40 50 60 70 80 90 100 110 120 130 140 150

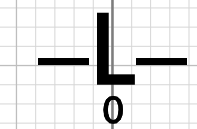
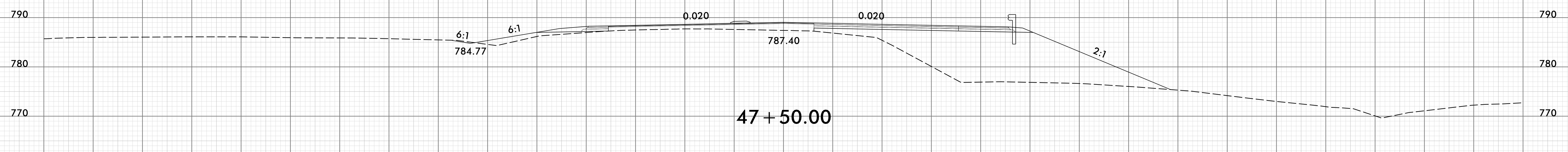
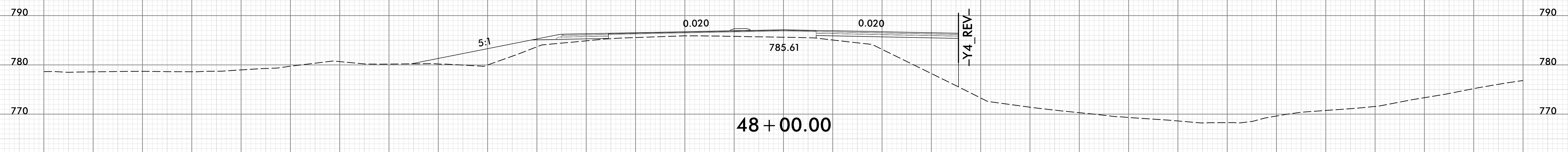
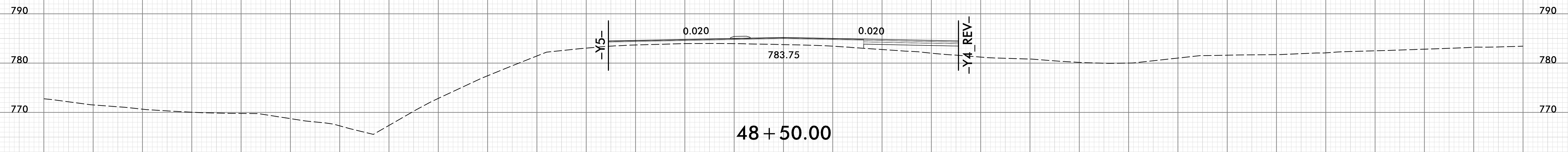
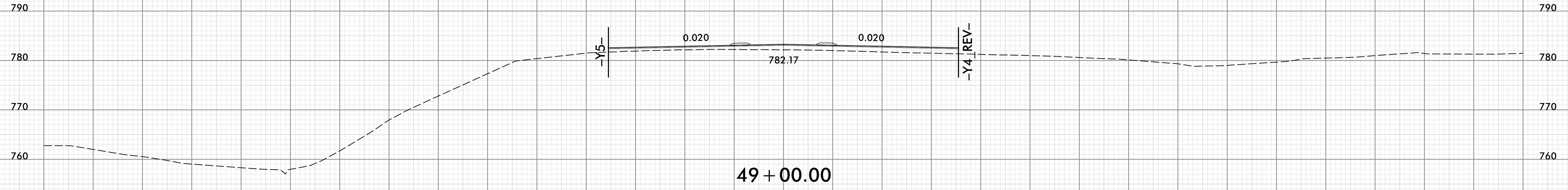

150 140 130 120 110 100 90 80 70 60 50 40 30 20 10 0 10 20 30 40 50 60 70 80 90 100 110 120 130 140 150

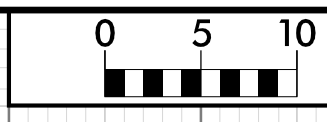

150 140 130 120 110 100 90 80 70 60 50 40 30 20 10 0 10 20 30 40 50 60 70 80 90 100 110 120 130 140 150

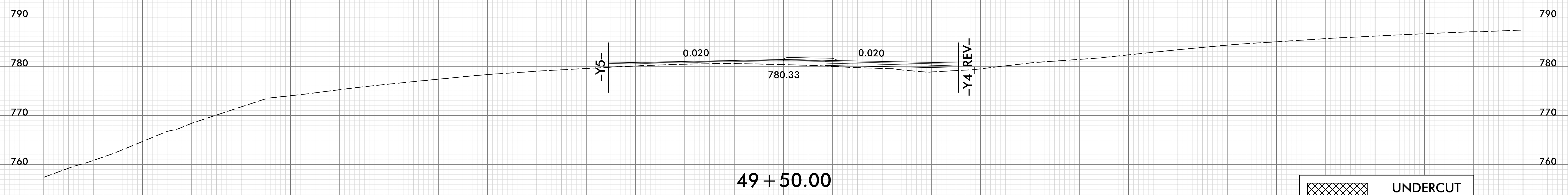
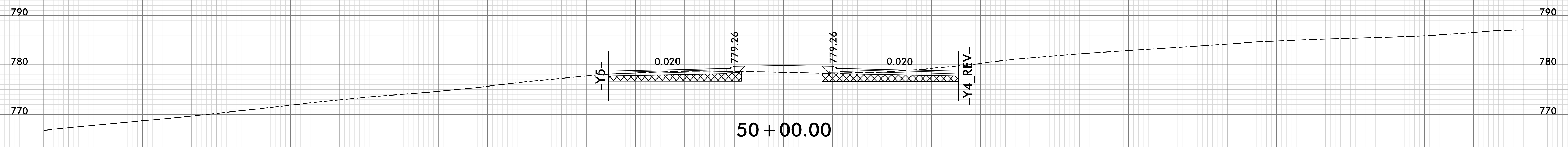
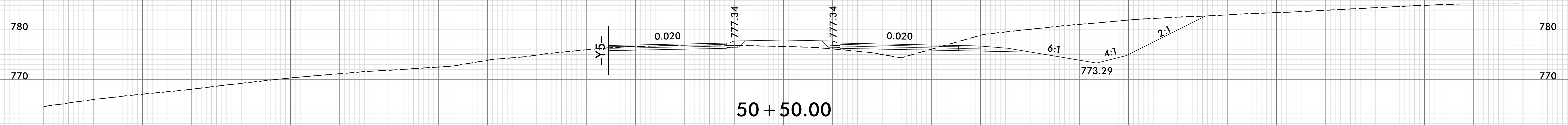
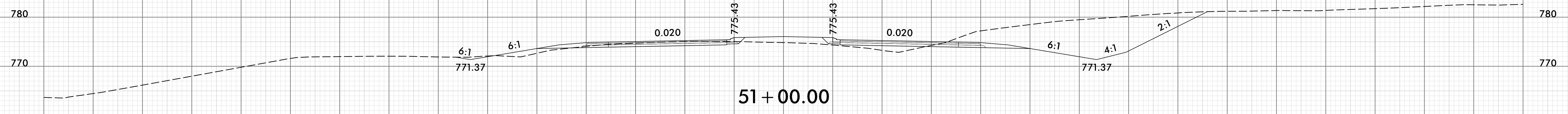

UNDERCUT EXCAVATION

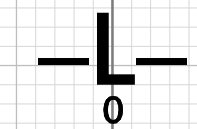

150 140 130 120 110 100 90 80 70 60 50 40 30 20 10 0 10 20 30 40 50 60 70 80 90 100 110 120 130 140 150

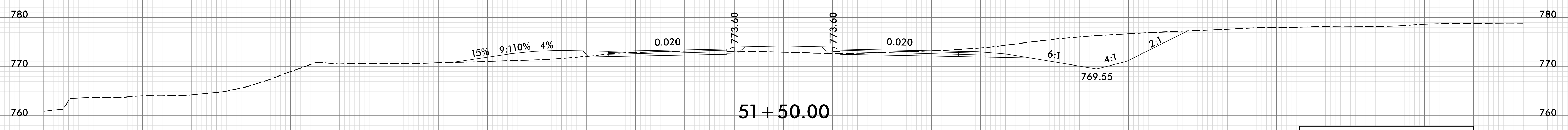
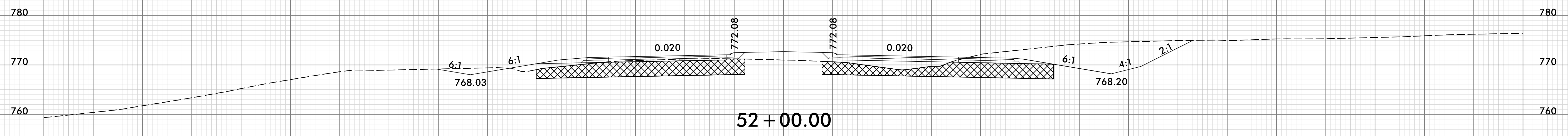
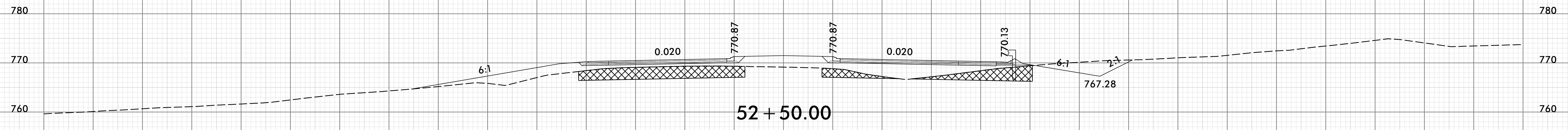
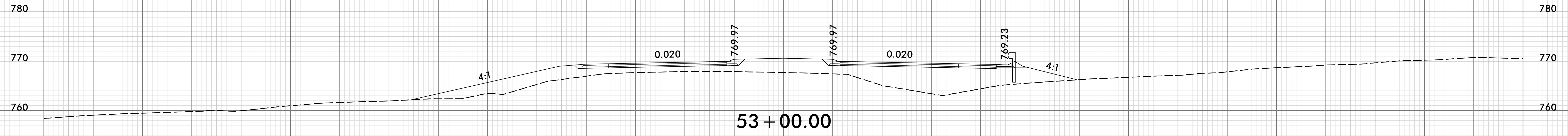

UNDERCUT EXCAVATION

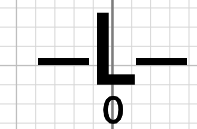





150 140 130 120 110 100 90 80 70 60 50 40 30 20 10 0 10 20 30 40 50 60 70 80 90 100 110 120 130 140 150

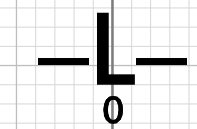
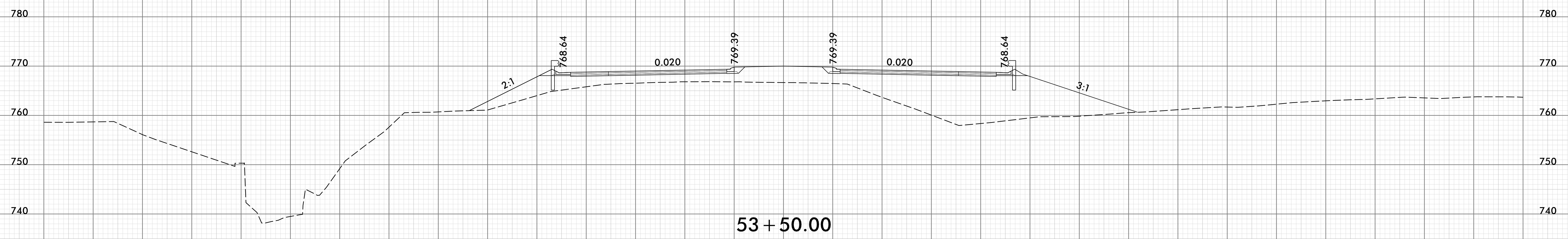
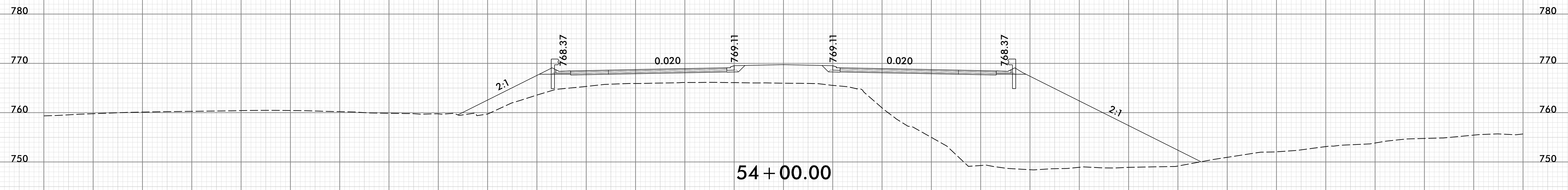
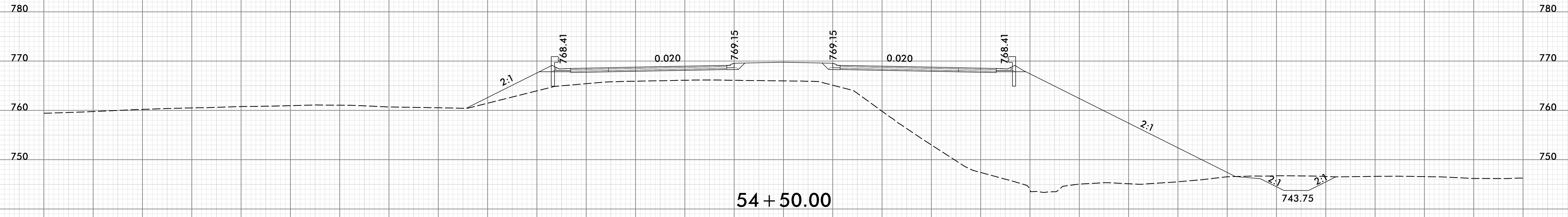

150 140 130 120 110 100 90 80 70 60 50 40 30 20 10 0 10 20 30 40 50 60 70 80 90 100 110 120 130 140 150

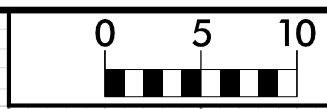

150 140 130 120 110 100 90 80 70 60 50 40 30 20 10 0 10 20 30 40 50 60 70 80 90 100 110 120 130 140 150

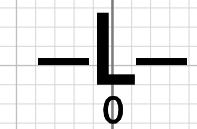
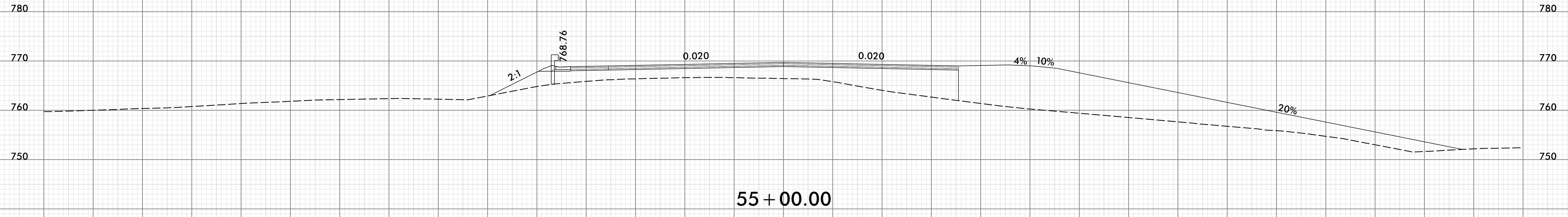
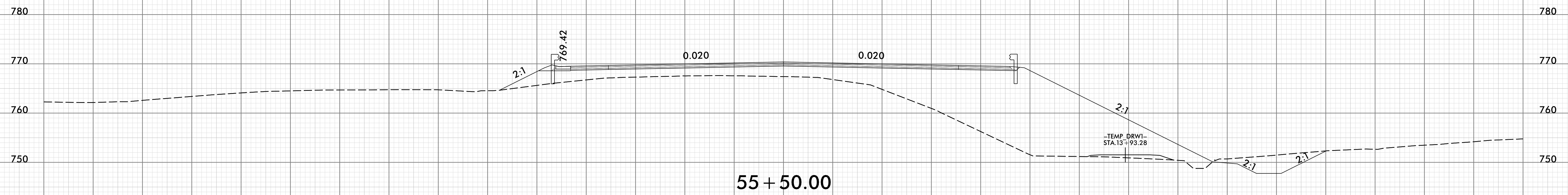
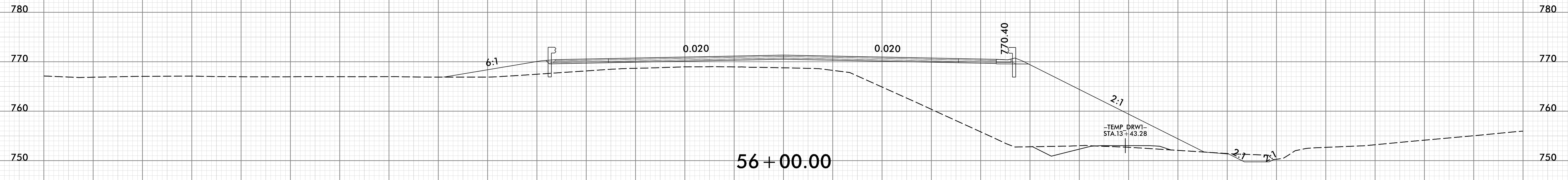

150 140 130 120 110 100 90 80 70 60 50 40 30 20 10 0 10 20 30 40 50 60 70 80 90 100 110 120 130 140 150

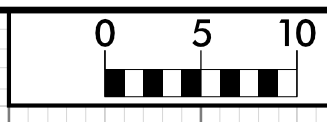

150 140 130 120 110 100 90 80 70 60 50 40 30 20 10 0 10 20 30 40 50 60 70 80 90 100 110 120 130 140 150

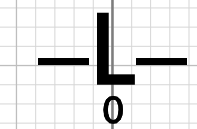
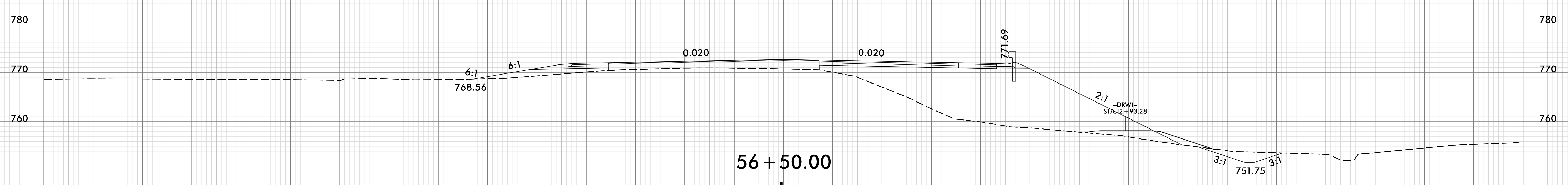
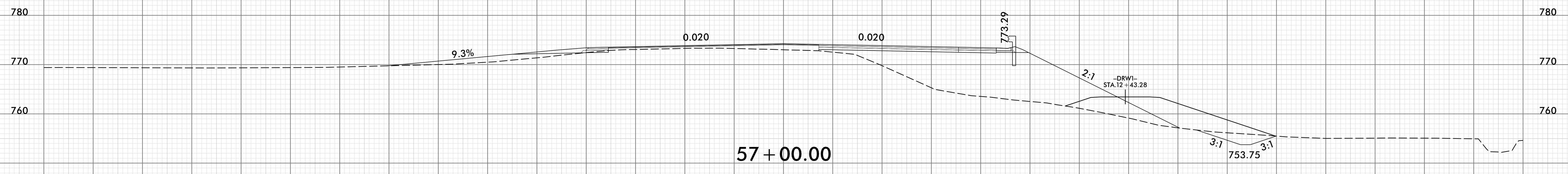
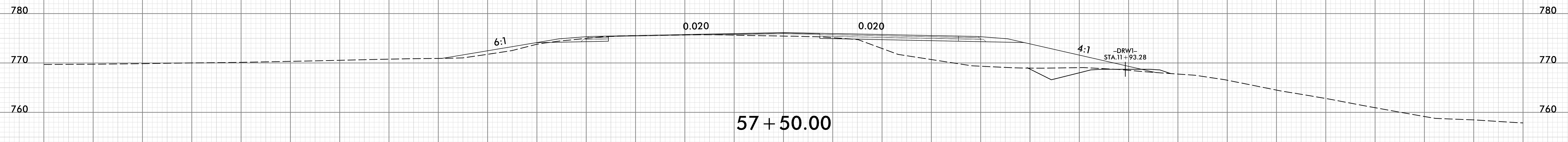
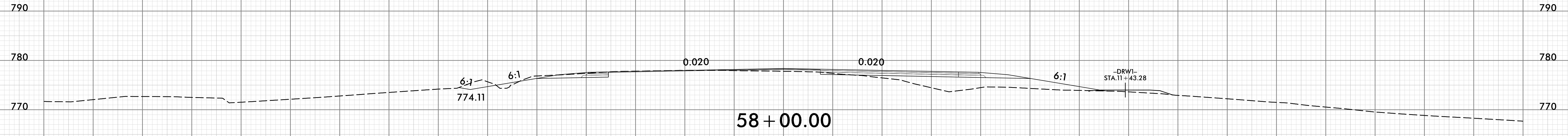

150 140 130 120 110 100 90 80 70 60 50 40 30 20 10 0 10 20 30 40 50 60 70 80 90 100 110 120 130 140 150

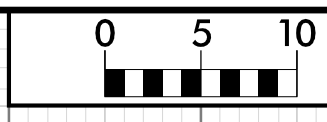

150 140 130 120 110 100 90 80 70 60 50 40 30 20 10 0 10 20 30 40 50 60 70 80 90 100 110 120 130 140 150

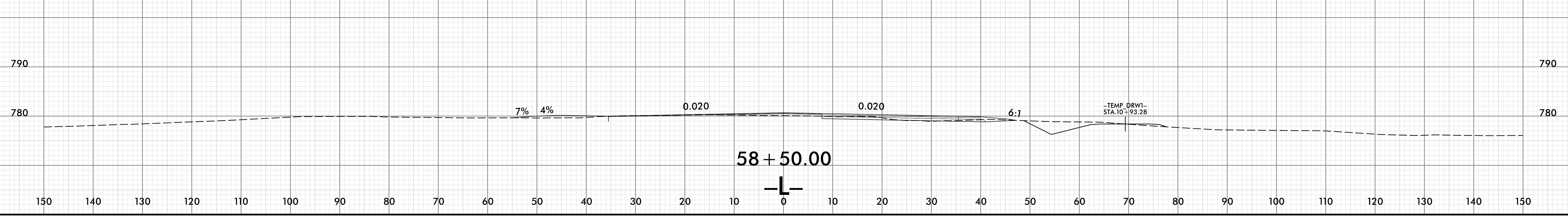
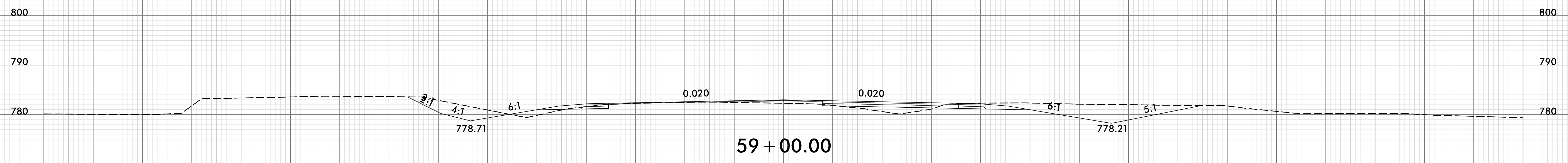
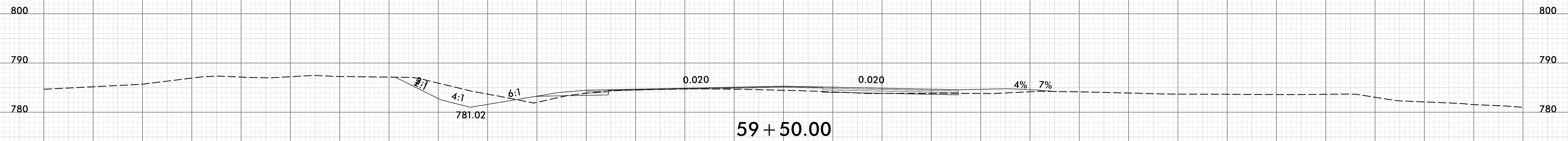
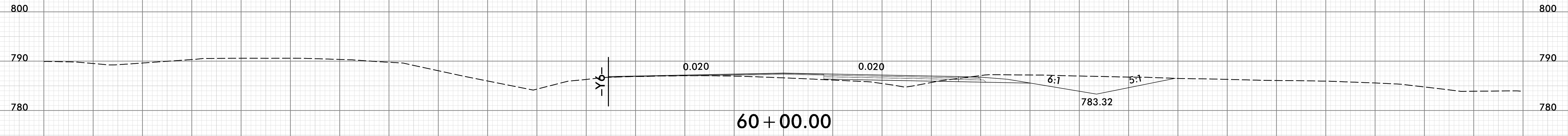

150 140 130 120 110 100 90 80 70 60 50 40 30 20 10 0 10 20 30 40 50 60 70 80 90 100 110 120 130 140 150



150 140 130 120 110 100 90 80 70 60 50 40 30 20 10 0 10 20 30 40 50 60 70 80 90 100 110 120 130 140 150

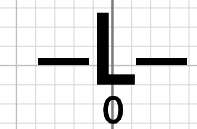
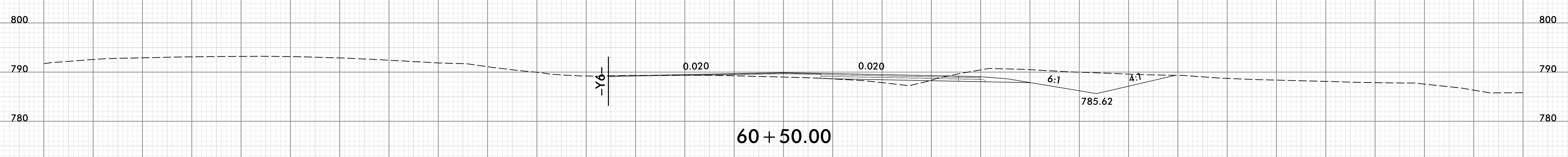
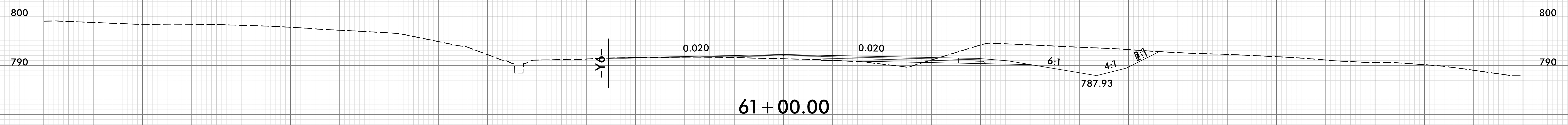
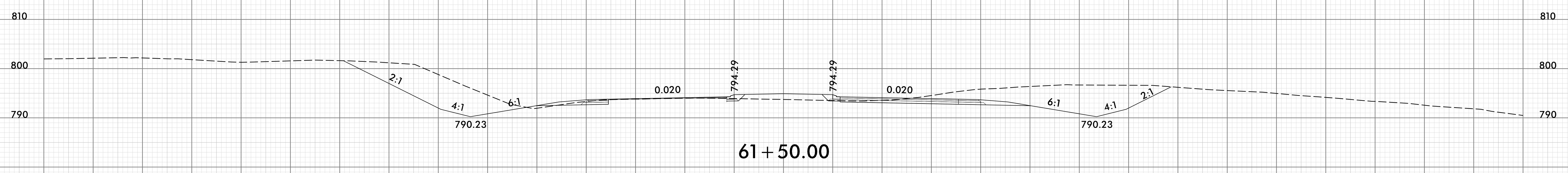
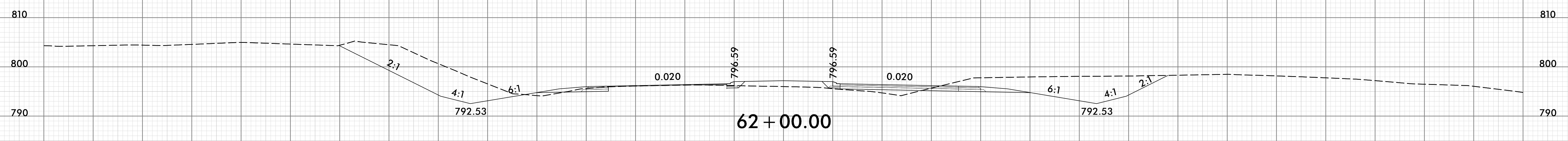
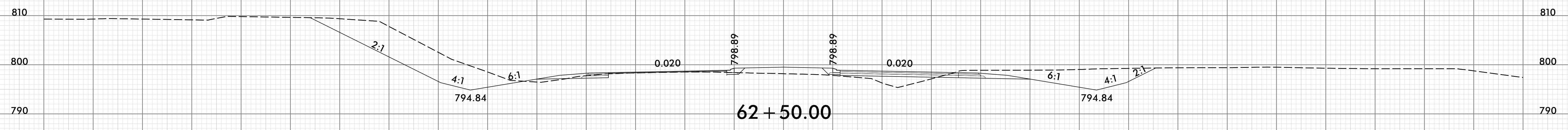

150 140 130 120 110 100 90 80 70 60 50 40 30 20 10 0 10 20 30 40 50 60 70 80 90 100 110 120 130 140 150

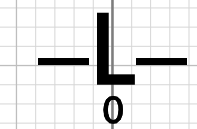
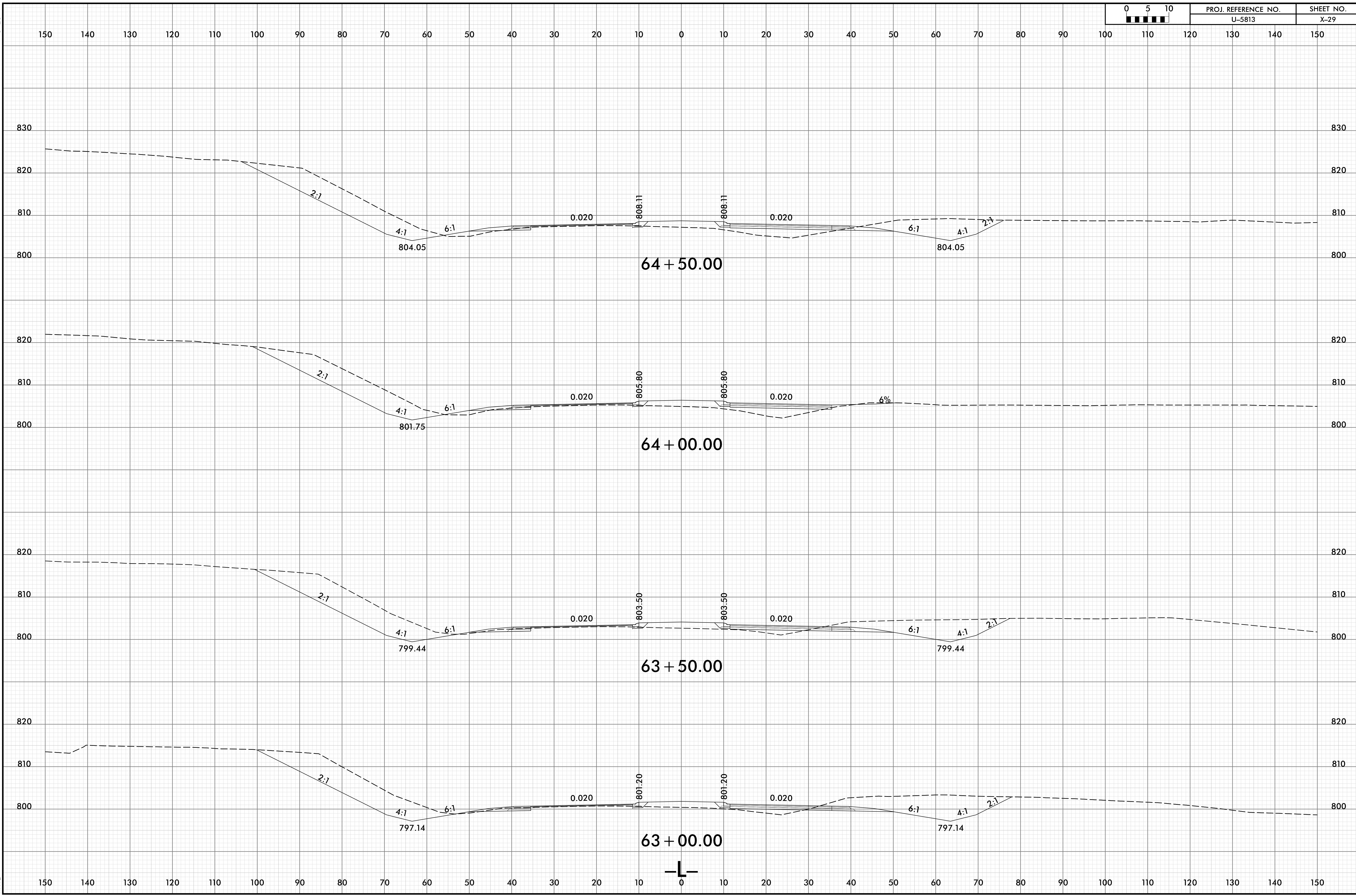

8/23/99

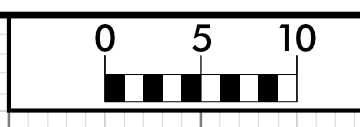

PROJ. REFERENCE NO.	SHEET NO.
U-5813	X-30

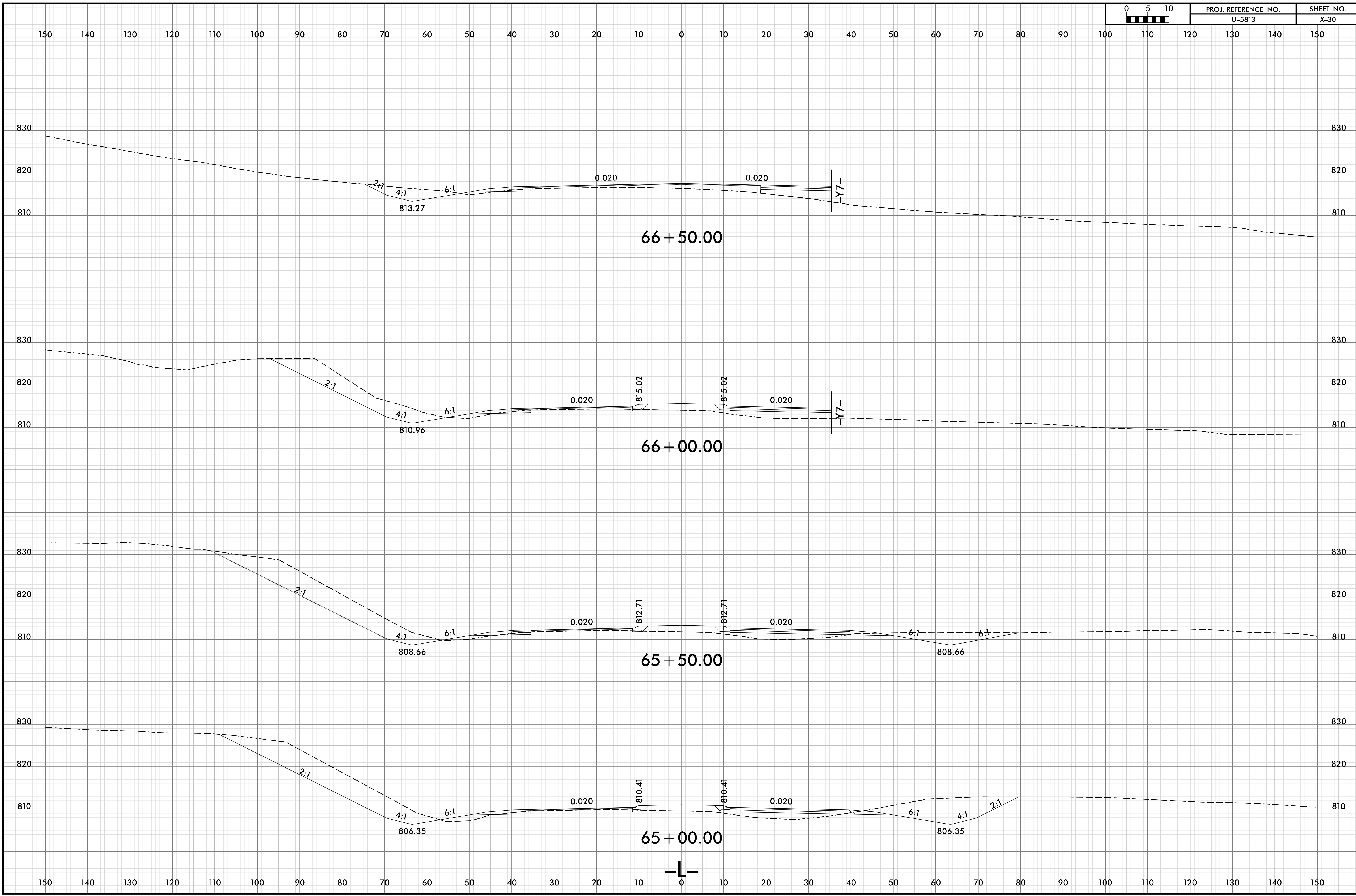

25-APR-2024 17:55  
 \\regdrivej\CorridorModeling\U5813\_RDY.L\_XPL.dgn  
 HNTB

150 140 130 120 110 100 90 80 70 60 50 40 30 20 10 0 10 20 30 40 50 60 70 80 90 100 110 120 130 140 150

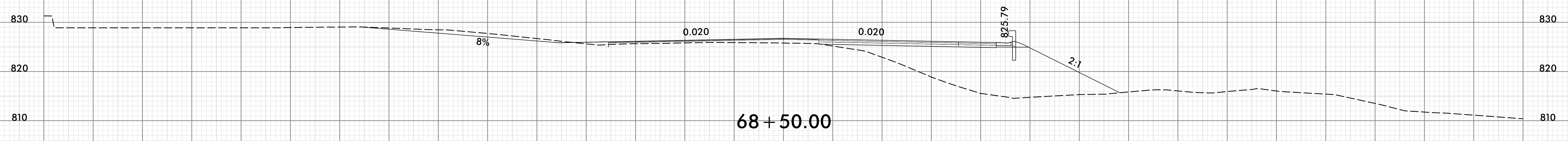

68 + 50.00

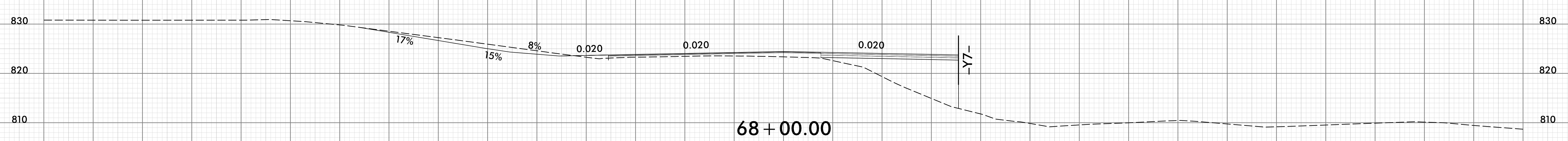

68 + 00.00

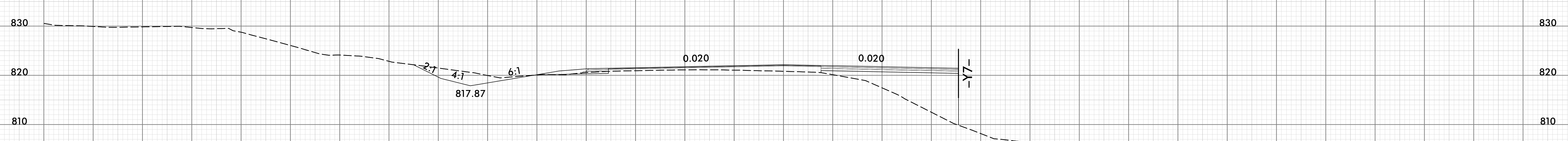

67 + 50.00

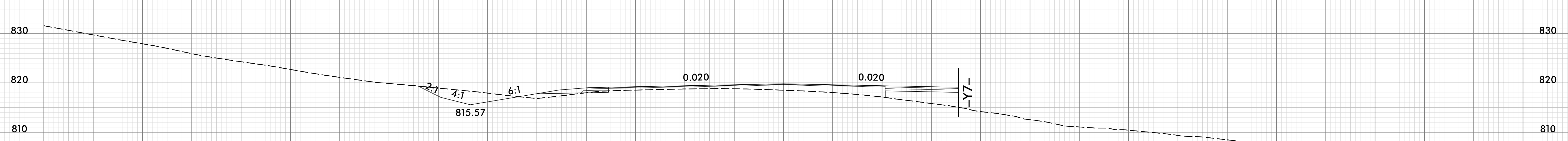

67 + 00.00

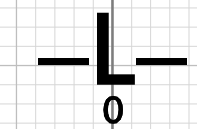

150 140 130 120 110 100 90 80 70 60 50 40 30 20 10 0 10 20 30 40 50 60 70 80 90 100 110 120 130 140 150



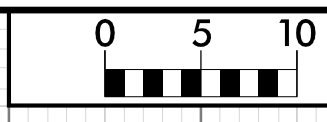

150 140 130 120 110 100 90 80 70 60 50 40 30 20 10 0 10 20 30 40 50 60 70 80 90 100 110 120 130 140 150

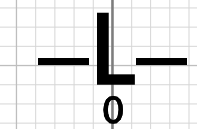
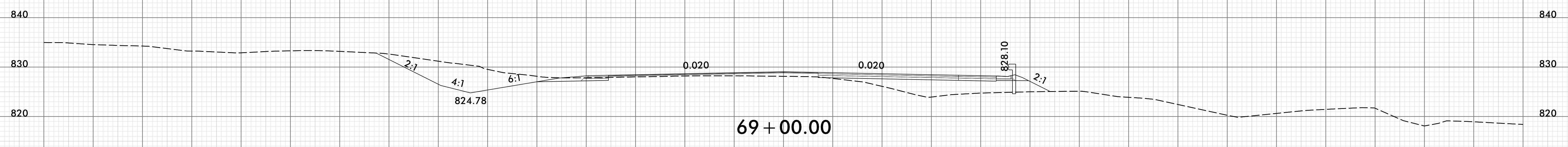
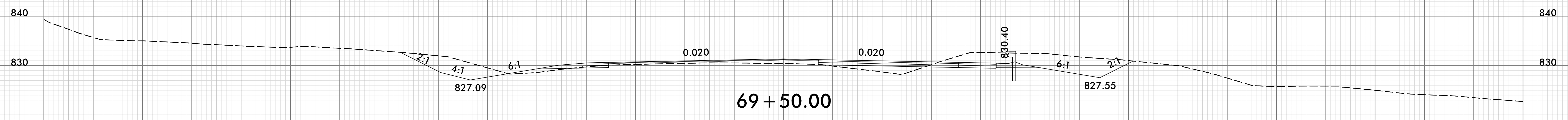
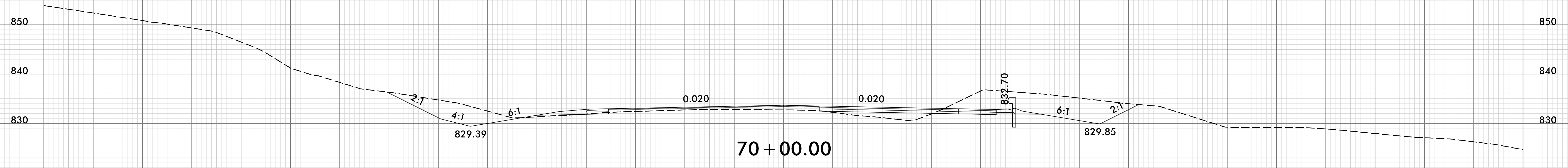
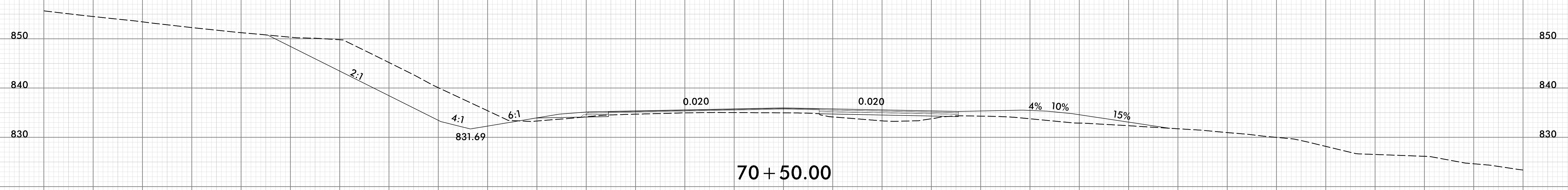

150 140 130 120 110 100 90 80 70 60 50 40 30 20 10 0 10 20 30 40 50 60 70 80 90 100 110 120 130 140 150

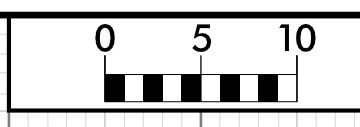

150 140 130 120 110 100 90 80 70 60 50 40 30 20 10 0 10 20 30 40 50 60 70 80 90 100 110 120 130 140 150

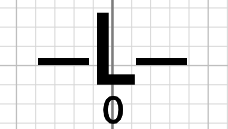
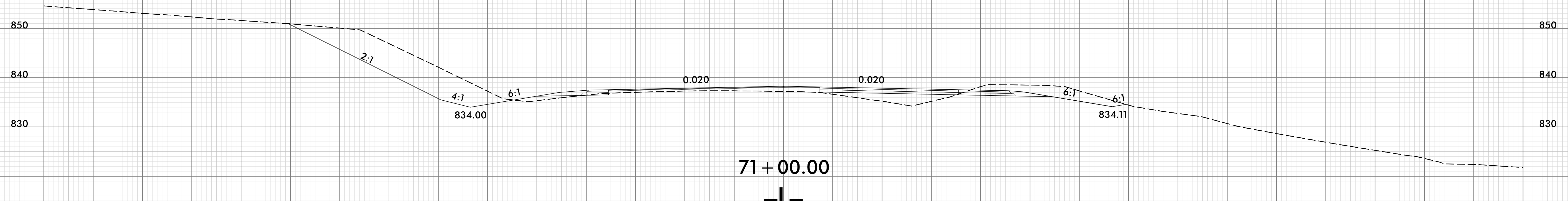
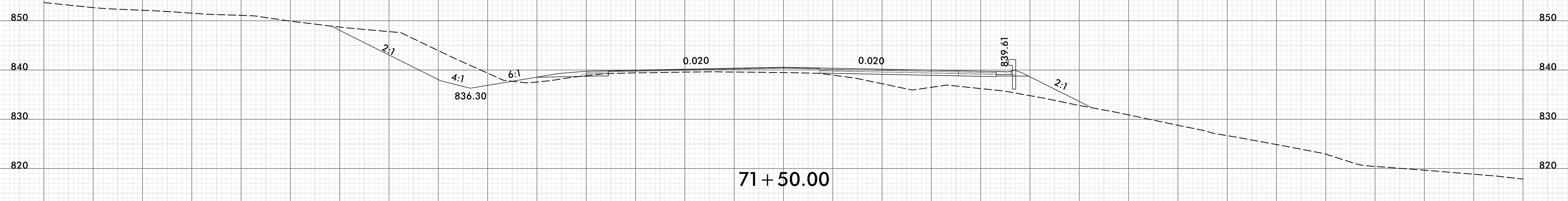
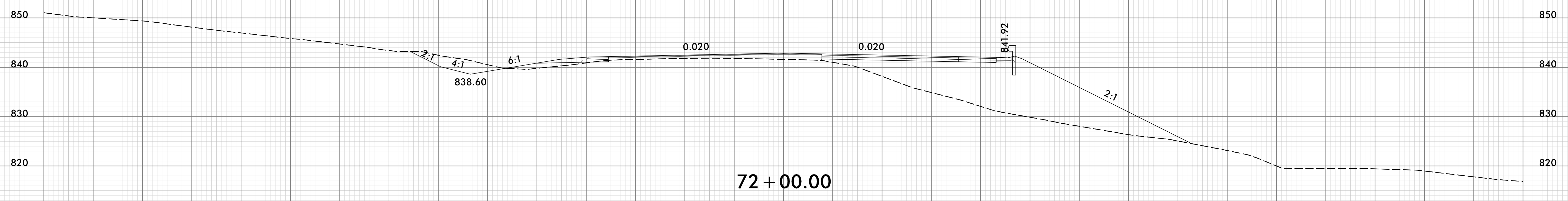
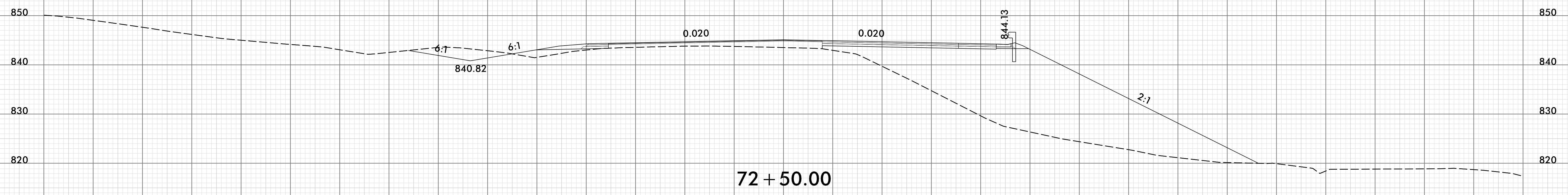

150 140 130 120 110 100 90 80 70 60 50 40 30 20 10 0 10 20 30 40 50 60 70 80 90 100 110 120 130 140 150

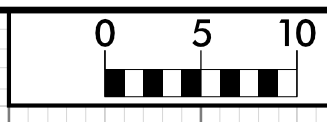

150 140 130 120 110 100 90 80 70 60 50 40 30 20 10 0 10 20 30 40 50 60 70 80 90 100 110 120 130 140 150

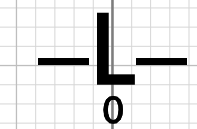
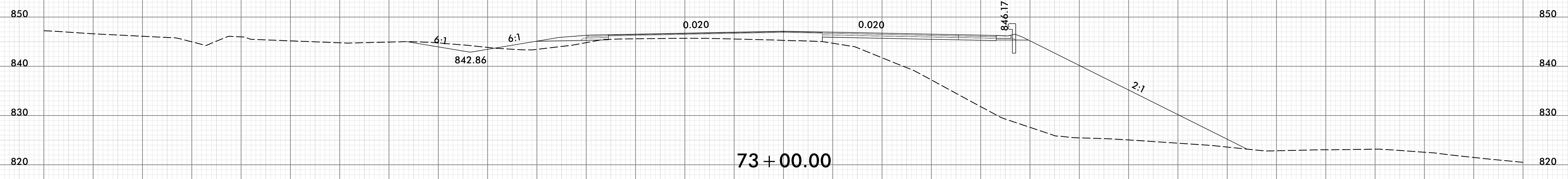
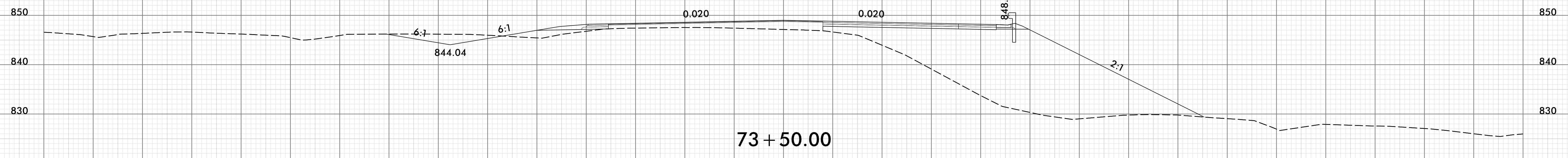
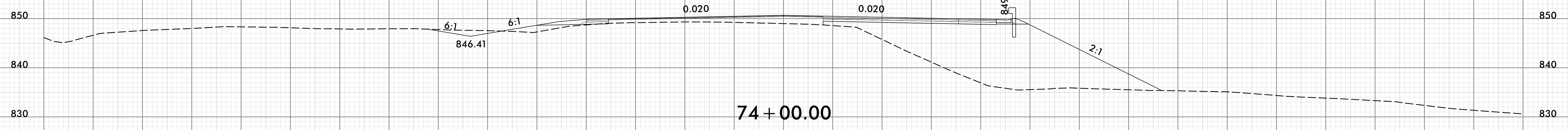
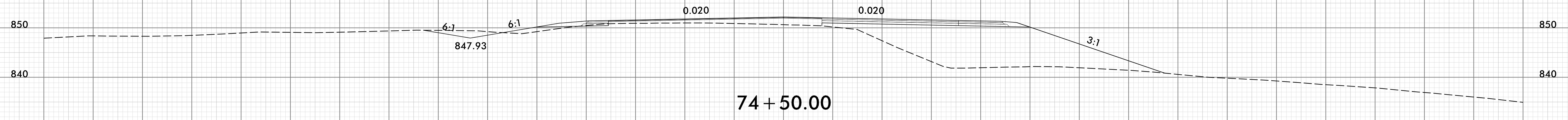

150 140 130 120 110 100 90 80 70 60 50 40 30 20 10 0 10 20 30 40 50 60 70 80 90 100 110 120 130 140 150

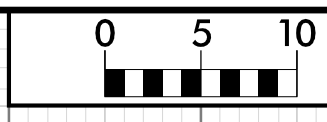

150 140 130 120 110 100 90 80 70 60 50 40 30 20 10 0 10 20 30 40 50 60 70 80 90 100 110 120 130 140 150

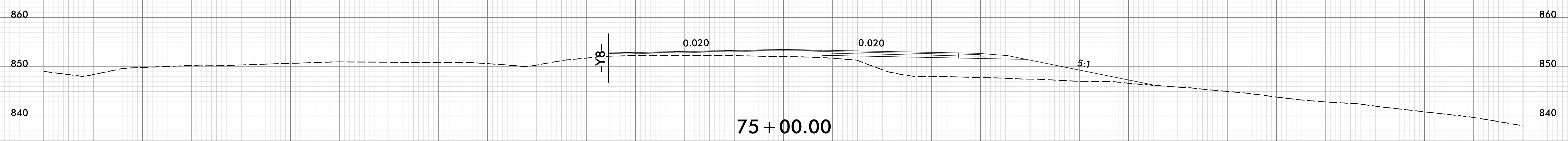
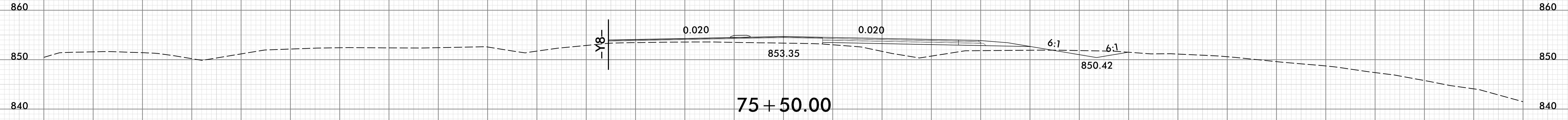
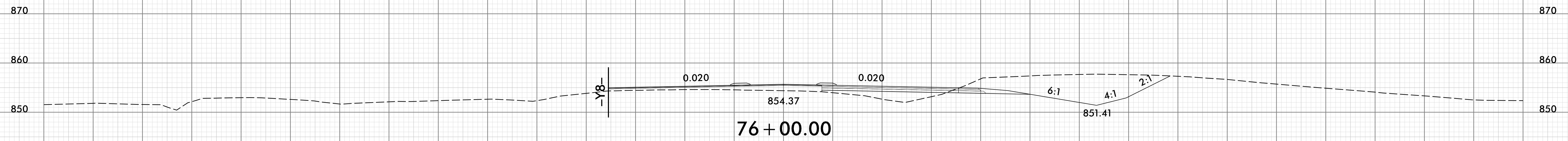
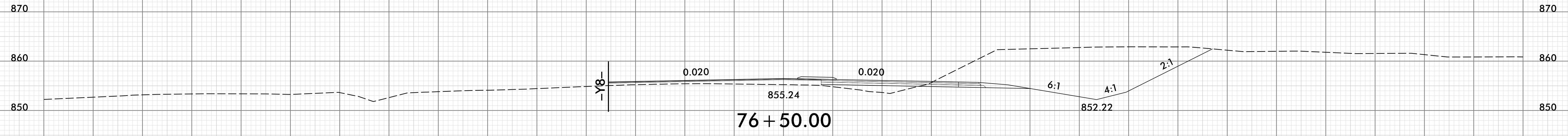

150 140 130 120 110 100 90 80 70 60 50 40 30 20 10 0 10 20 30 40 50 60 70 80 90 100 110 120 130 140 150

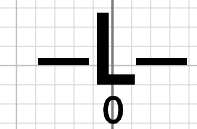

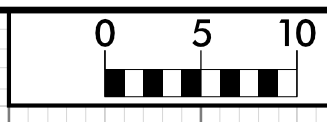

150 140 130 120 110 100 90 80 70 60 50 40 30 20 10 0 10 20 30 40 50 60 70 80 90 100 110 120 130 140 150

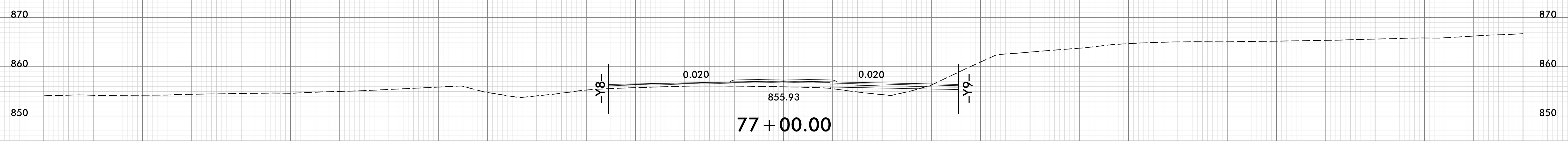
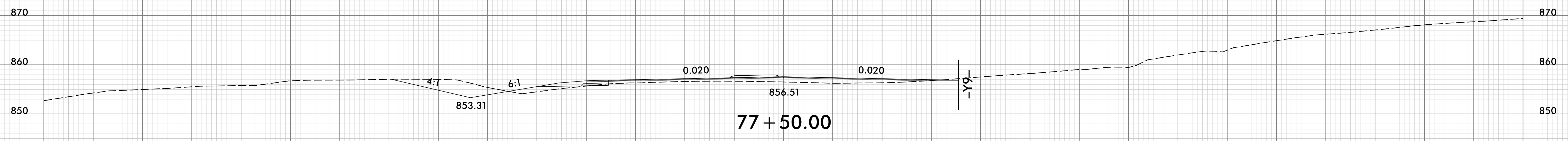
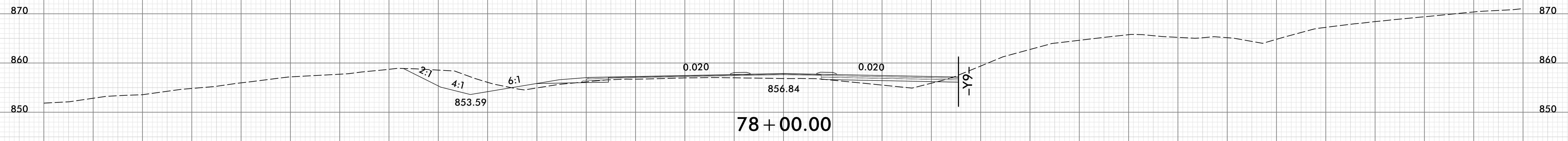
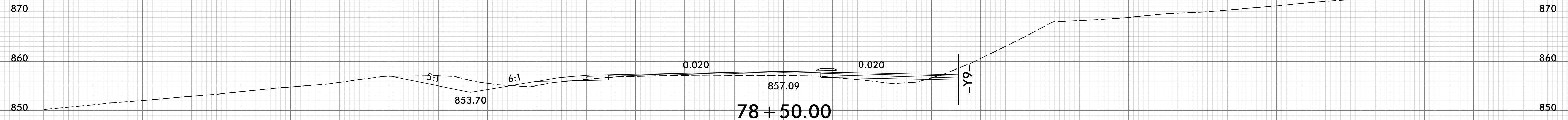

150 140 130 120 110 100 90 80 70 60 50 40 30 20 10 0 10 20 30 40 50 60 70 80 90 100 110 120 130 140 150

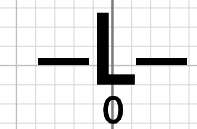

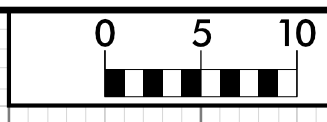

150 140 130 120 110 100 90 80 70 60 50 40 30 20 10 0 10 20 30 40 50 60 70 80 90 100 110 120 130 140 150

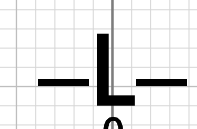
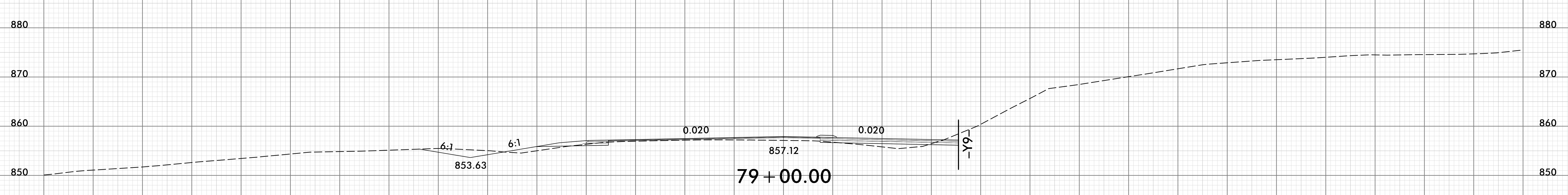
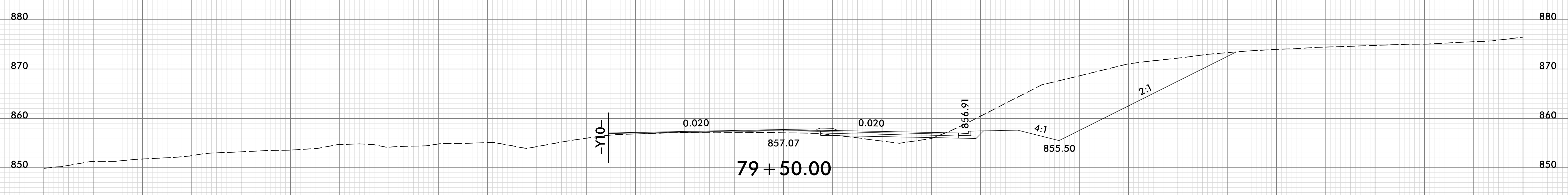
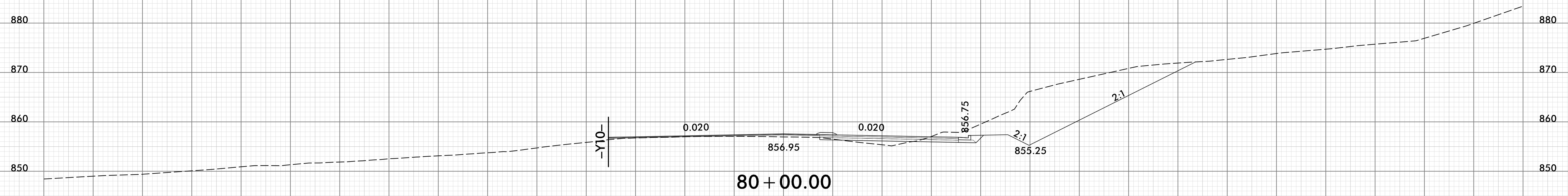

150 140 130 120 110 100 90 80 70 60 50 40 30 20 10 0 10 20 30 40 50 60 70 80 90 100 110 120 130 140 150

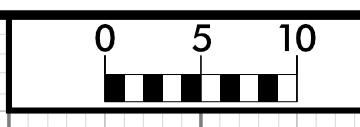

150 140 130 120 110 100 90 80 70 60 50 40 30 20 10 0 10 20 30 40 50 60 70 80 90 100 110 120 130 140 150

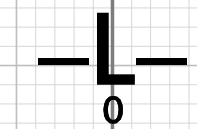
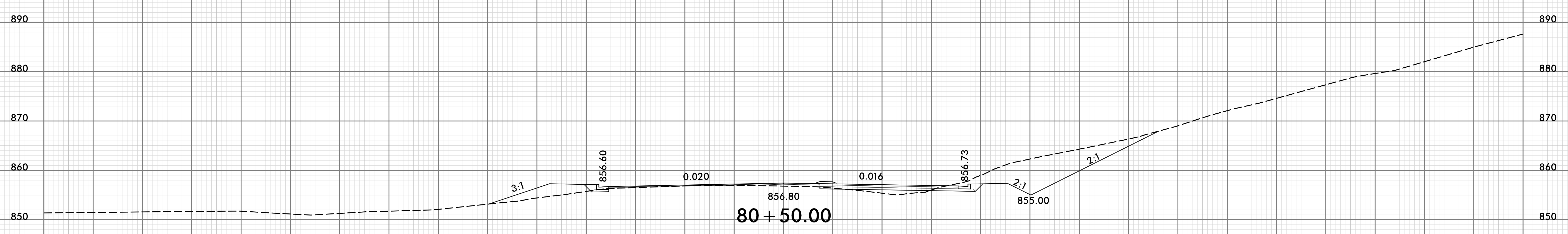
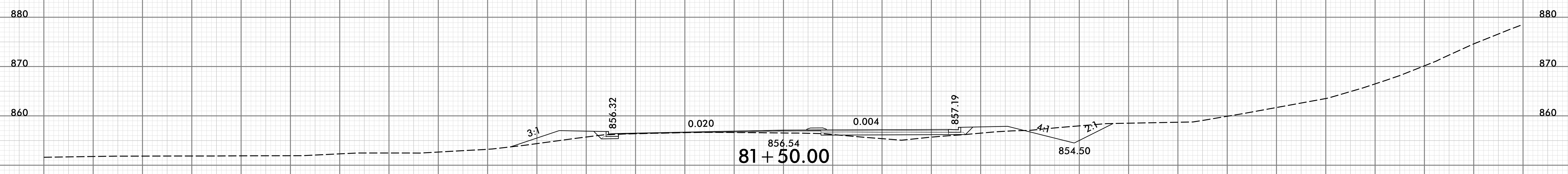

150 140 130 120 110 100 90 80 70 60 50 40 30 20 10 0 10 20 30 40 50 60 70 80 90 100 110 120 130 140 150

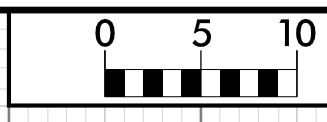

150 140 130 120 110 100 90 80 70 60 50 40 30 20 10 0 10 20 30 40 50 60 70 80 90 100 110 120 130 140 150

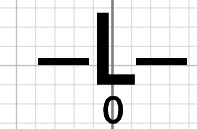
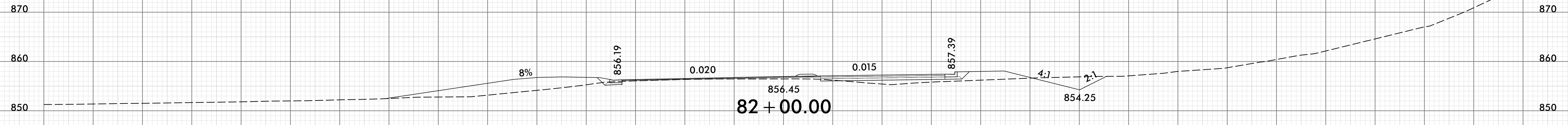
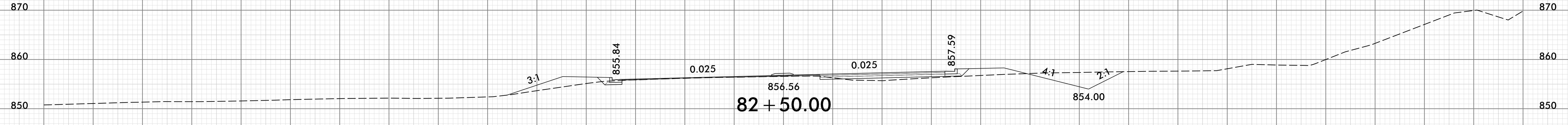
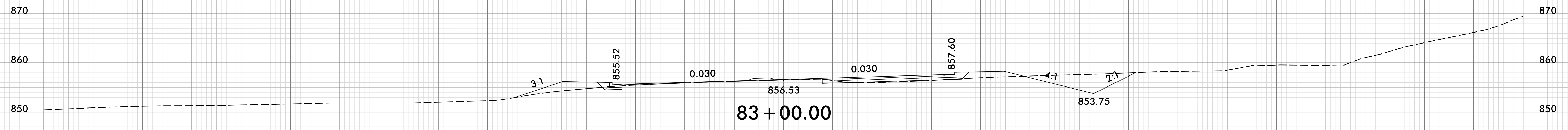
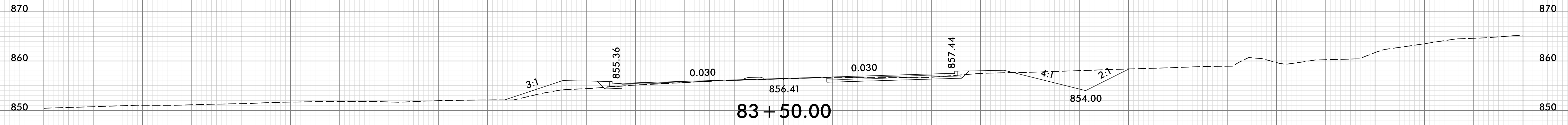

150 140 130 120 110 100 90 80 70 60 50 40 30 20 10 0 10 20 30 40 50 60 70 80 90 100 110 120 130 140 150



150 140 130 120 110 100 90 80 70 60 50 40 30 20 10 0 10 20 30 40 50 60 70 80 90 100 110 120 130 140 150

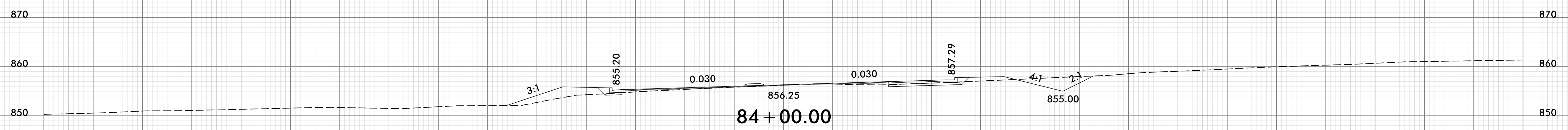
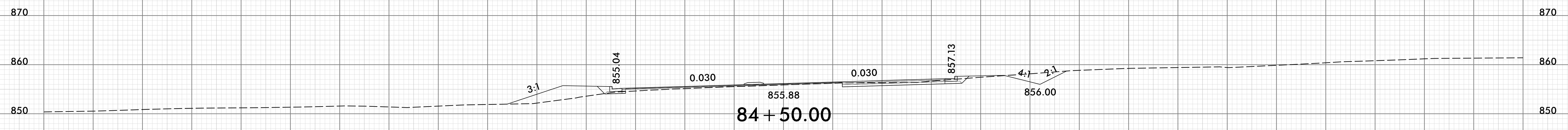
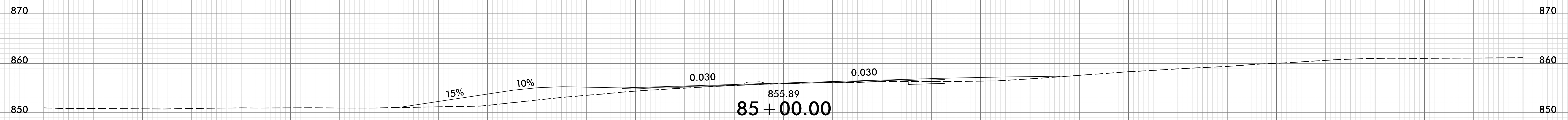
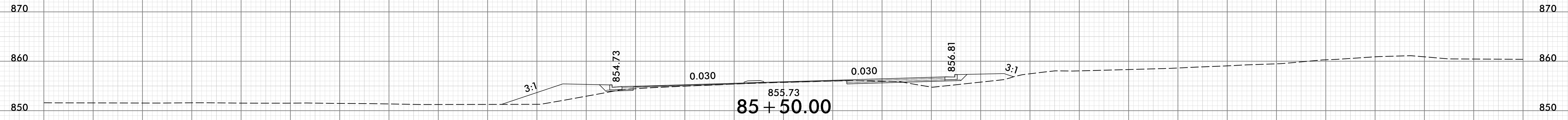

150 140 130 120 110 100 90 80 70 60 50 40 30 20 10 0 10 20 30 40 50 60 70 80 90 100 110 120 130 140 150

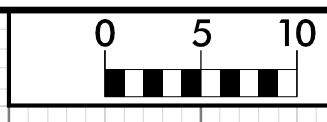

150 140 130 120 110 100 90 80 70 60 50 40 30 20 10 0 10 20 30 40 50 60 70 80 90 100 110 120 130 140 150

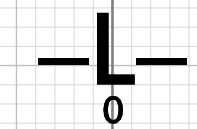
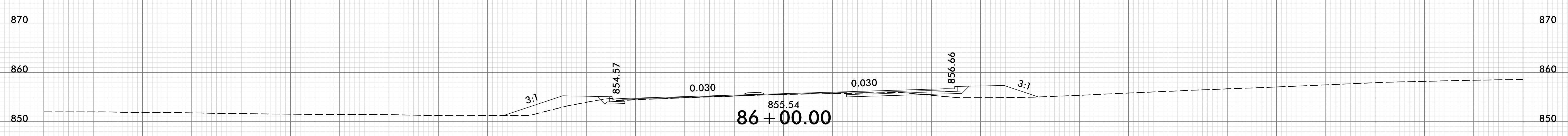
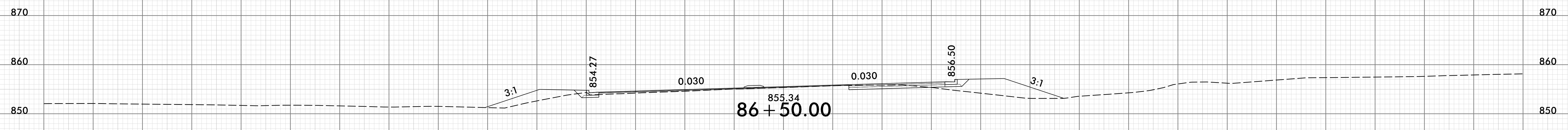
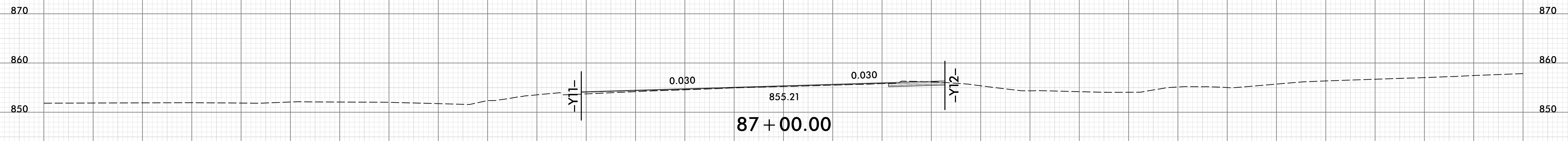
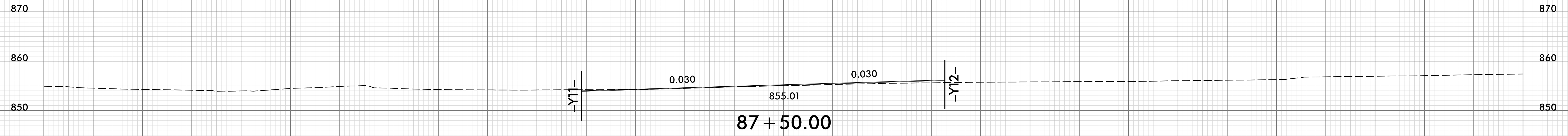

150 140 130 120 110 100 90 80 70 60 50 40 30 20 10 0 10 20 30 40 50 60 70 80 90 100 110 120 130 140 150

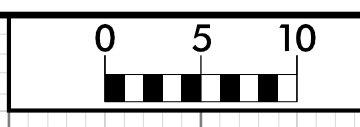

150 140 130 120 110 100 90 80 70 60 50 40 30 20 10 0 10 20 30 40 50 60 70 80 90 100 110 120 130 140 150

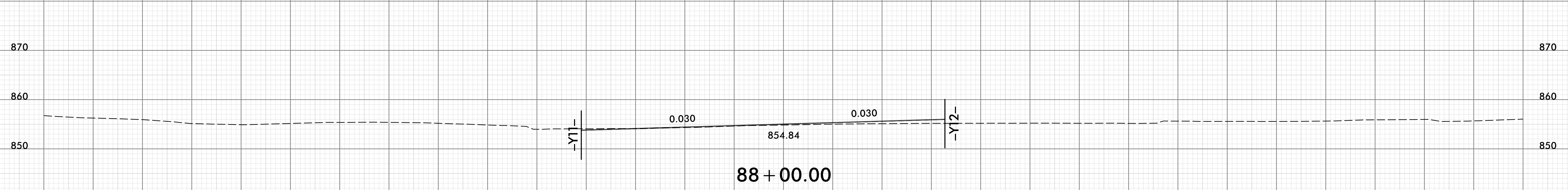
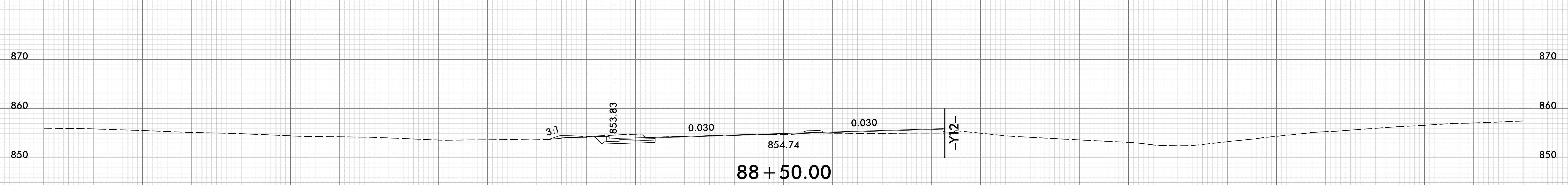
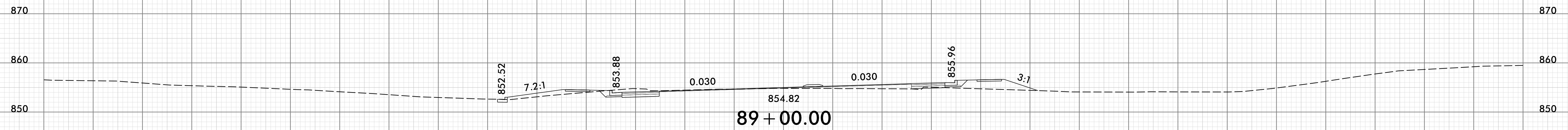
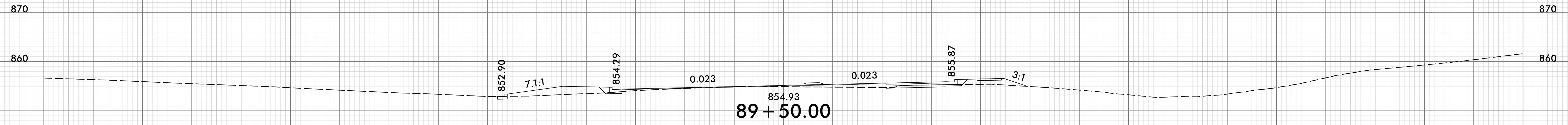
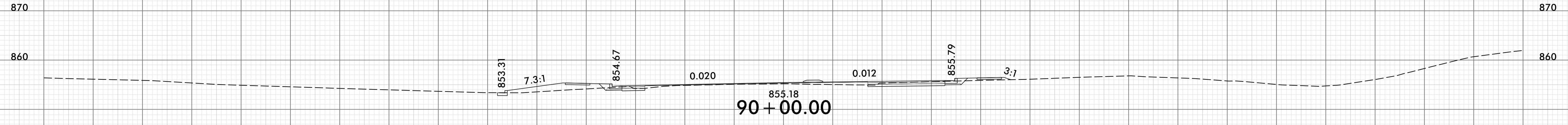

150 140 130 120 110 100 90 80 70 60 50 40 30 20 10 0 10 20 30 40 50 60 70 80 90 100 110 120 130 140 150

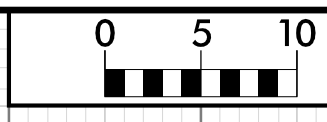

150 140 130 120 110 100 90 80 70 60 50 40 30 20 10 0 10 20 30 40 50 60 70 80 90 100 110 120 130 140 150

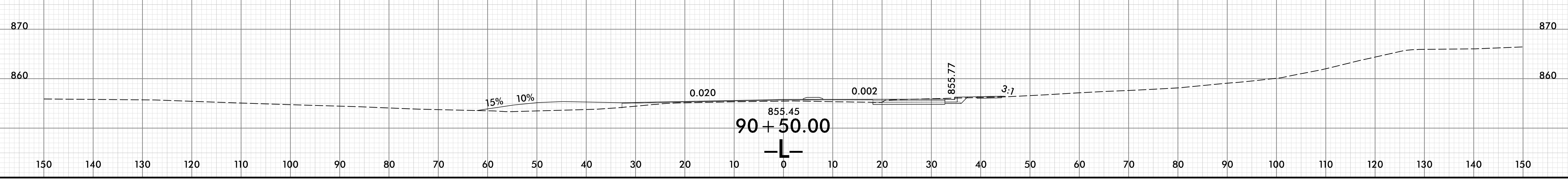
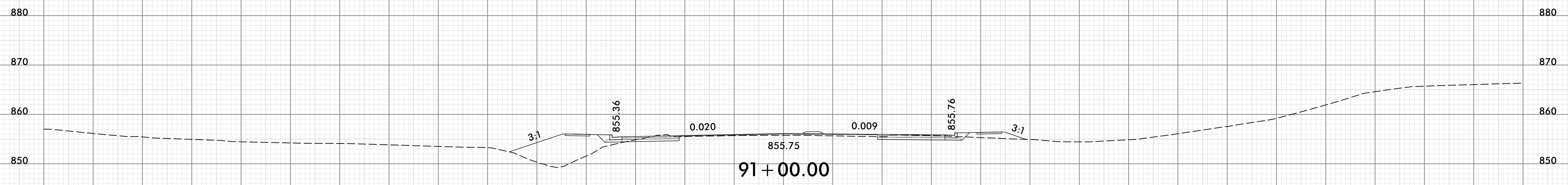
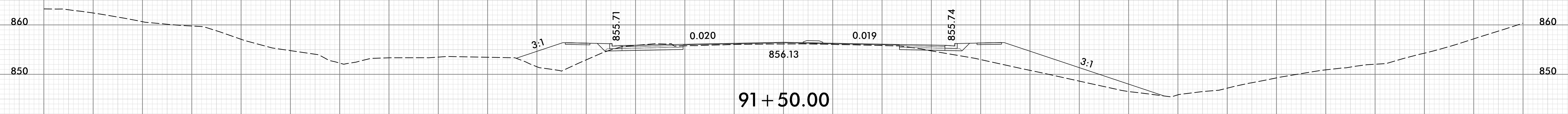
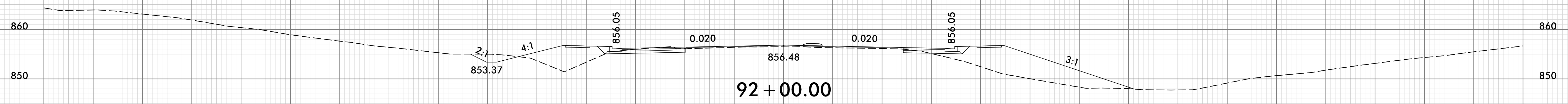
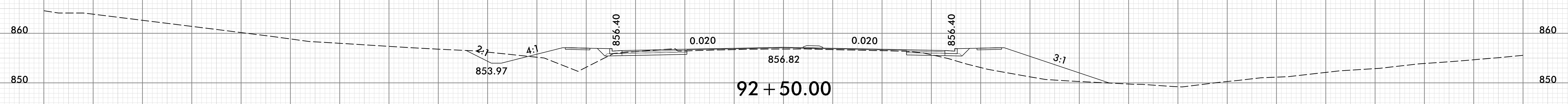

150 140 130 120 110 100 90 80 70 60 50 40 30 20 10 0 10 20 30 40 50 60 70 80 90 100 110 120 130 140 150

150 140 130 120 110 100 90 80 70 60 50 40 30 20 10 0 10 20 30 40 50 60 70 80 90 100 110 120 130 140 150

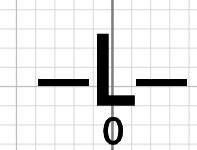
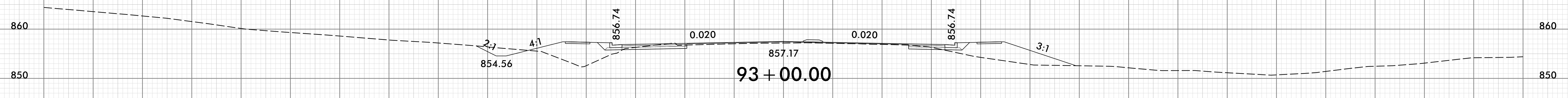
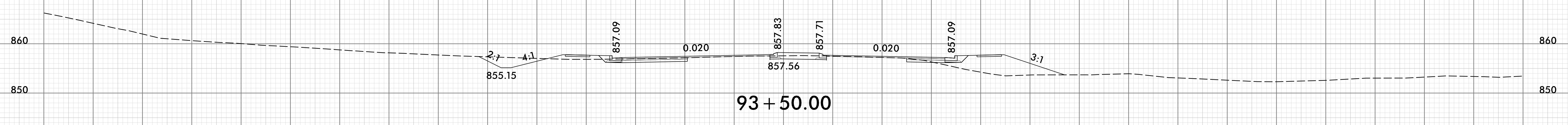
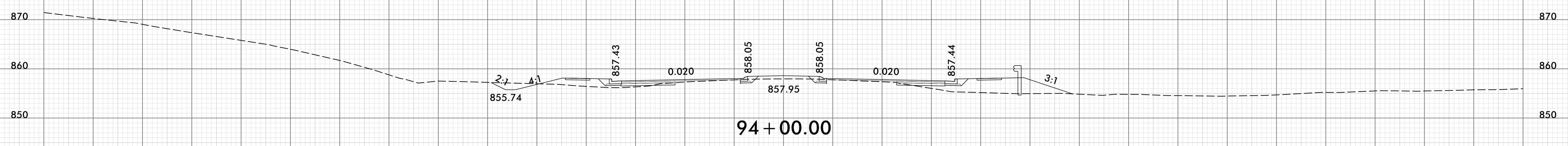
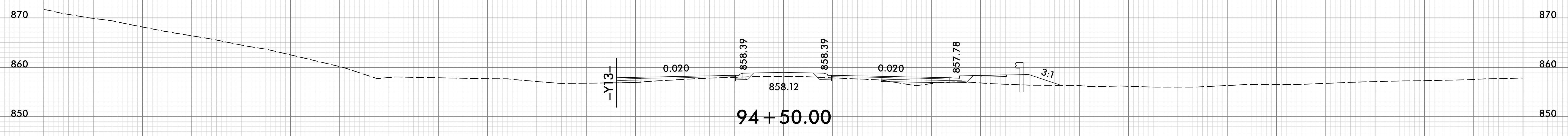
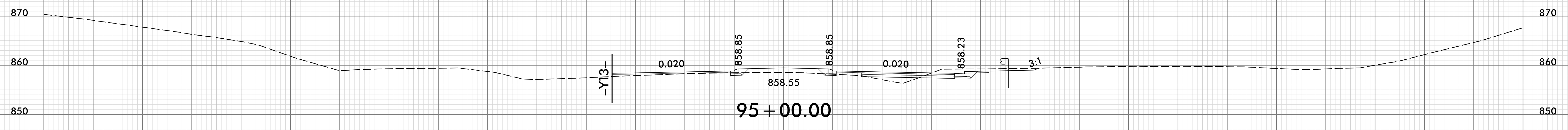

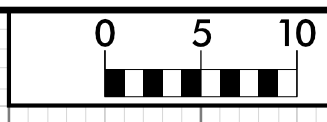

150 140 130 120 110 100 90 80 70 60 50 40 30 20 10 0 10 20 30 40 50 60 70 80 90 100 110 120 130 140 150

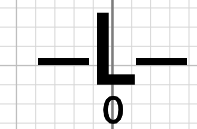
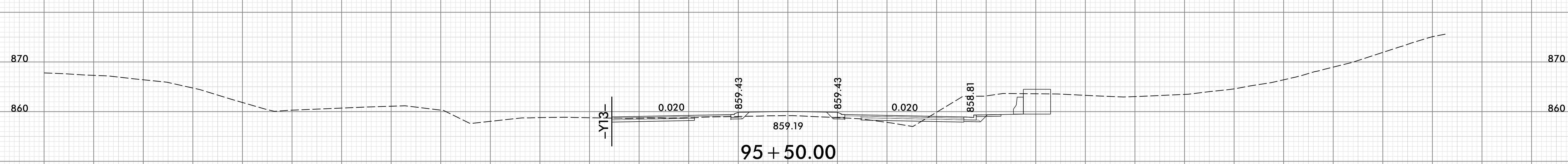
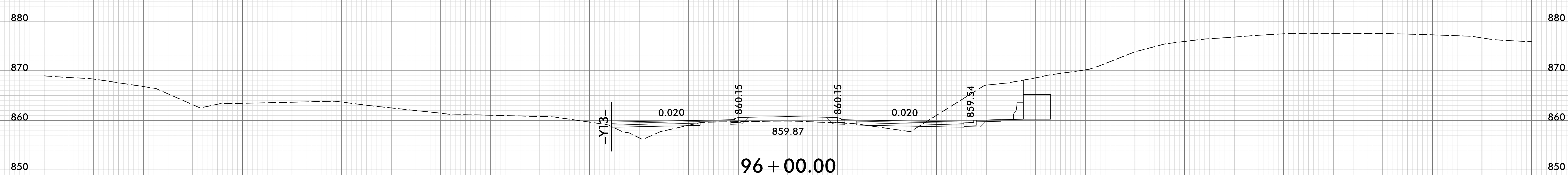
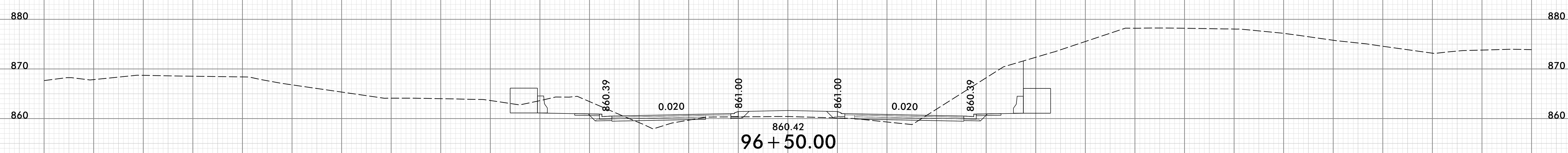
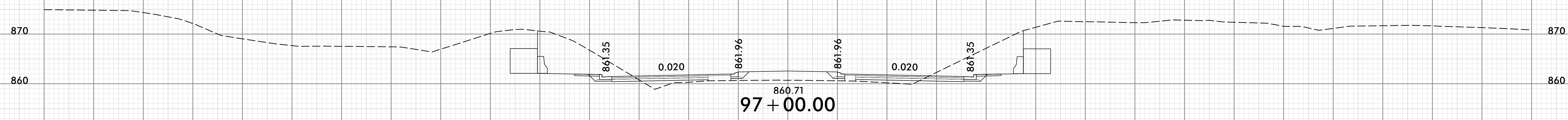
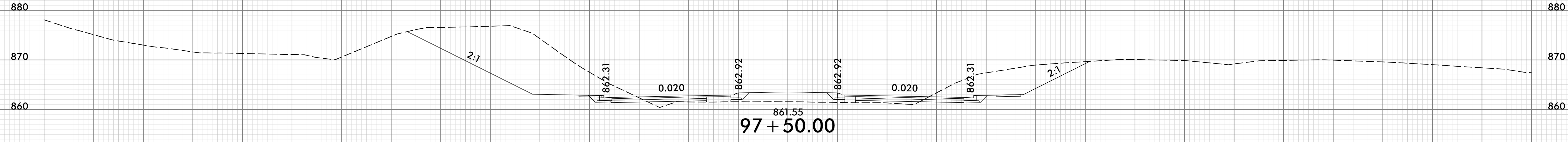

150 140 130 120 110 100 90 80 70 60 50 40 30 20 10 0 10 20 30 40 50 60 70 80 90 100 110 120 130 140 150

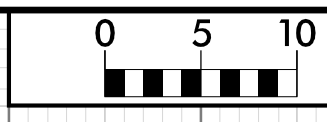

150 140 130 120 110 100 90 80 70 60 50 40 30 20 10 0 10 20 30 40 50 60 70 80 90 100 110 120 130 140 150

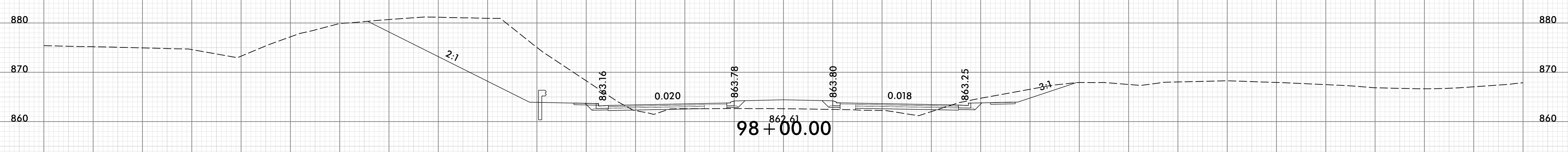
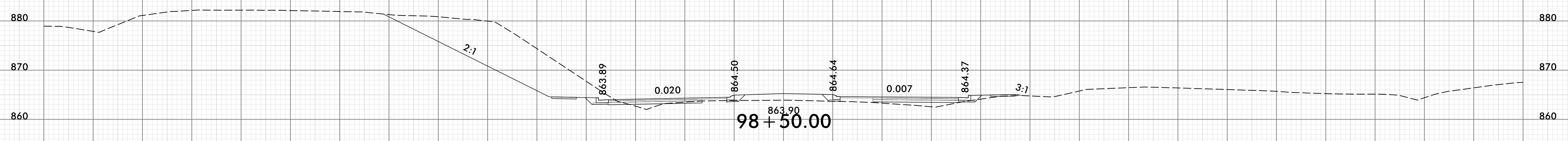
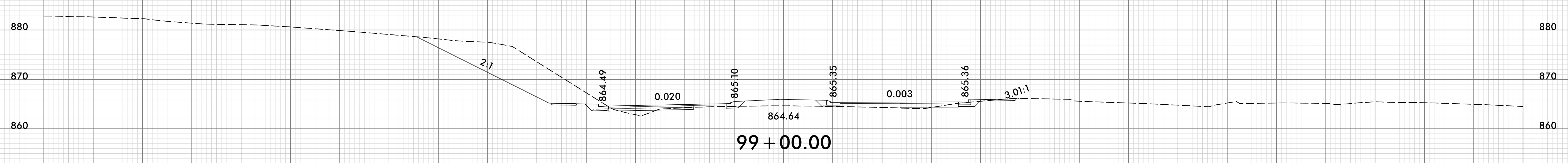
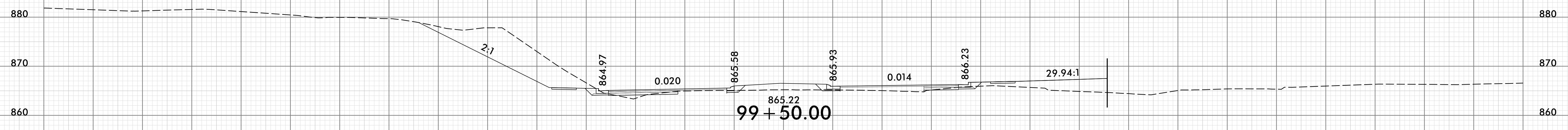

150 140 130 120 110 100 90 80 70 60 50 40 30 20 10 0 10 20 30 40 50 60 70 80 90 100 110 120 130 140 150

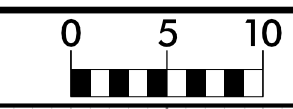

150 140 130 120 110 100 90 80 70 60 50 40 30 20 10 0 10 20 30 40 50 60 70 80 90 100 110 120 130 140 150

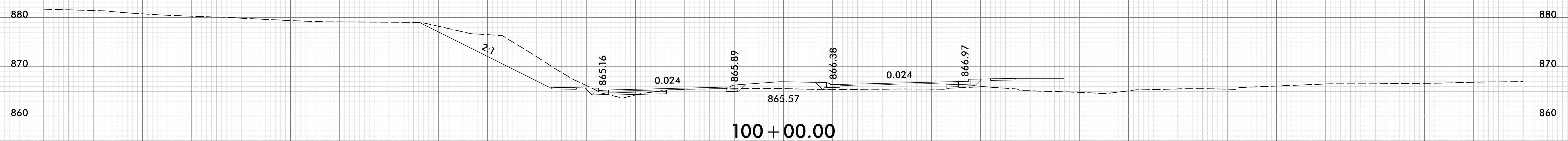
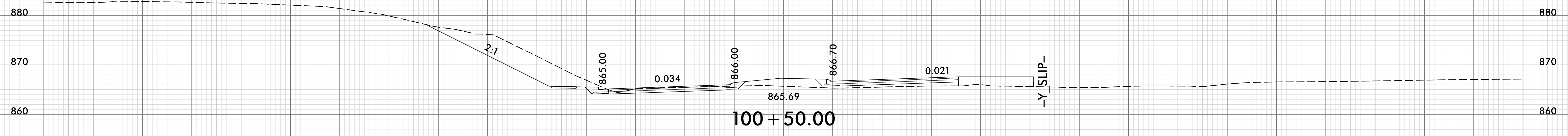
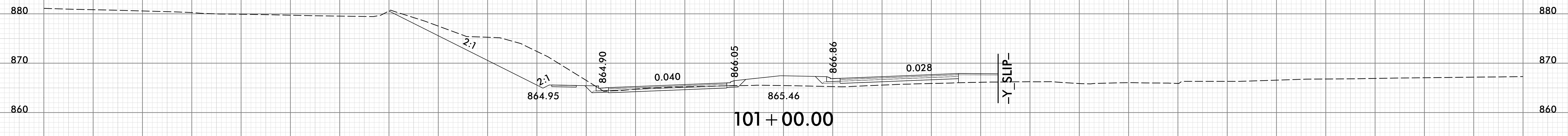
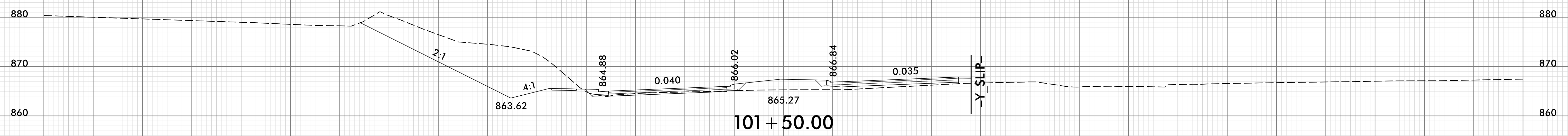

150 140 130 120 110 100 90 80 70 60 50 40 30 20 10 0 10 20 30 40 50 60 70 80 90 100 110 120 130 140 150

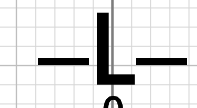



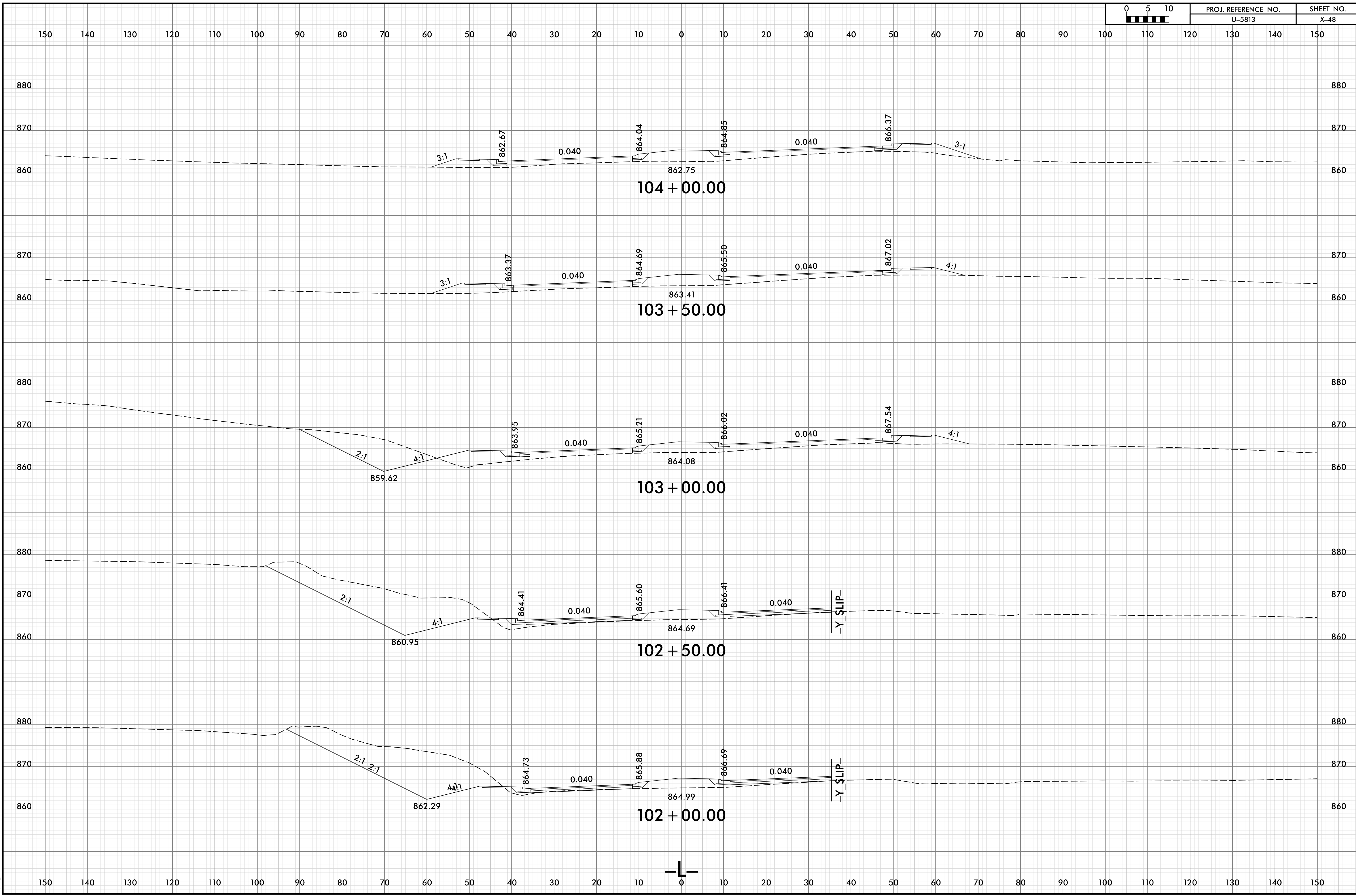

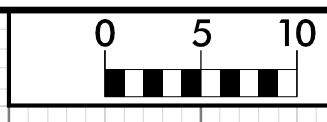

150 140 130 120 110 100 90 80 70 60 50 40 30 20 10 0 10 20 30 40 50 60 70 80 90 100 110 120 130 140 150

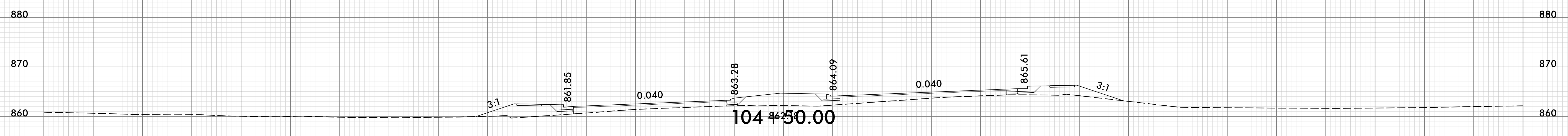
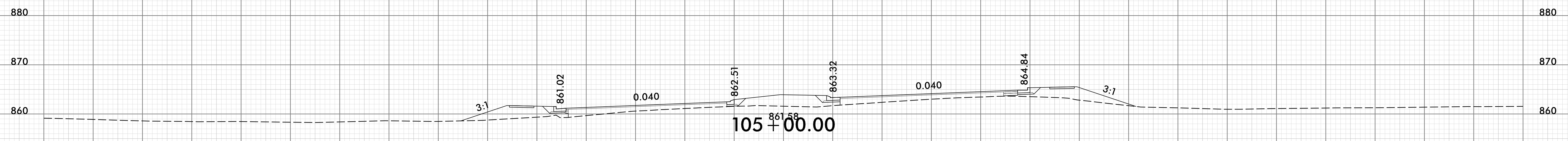
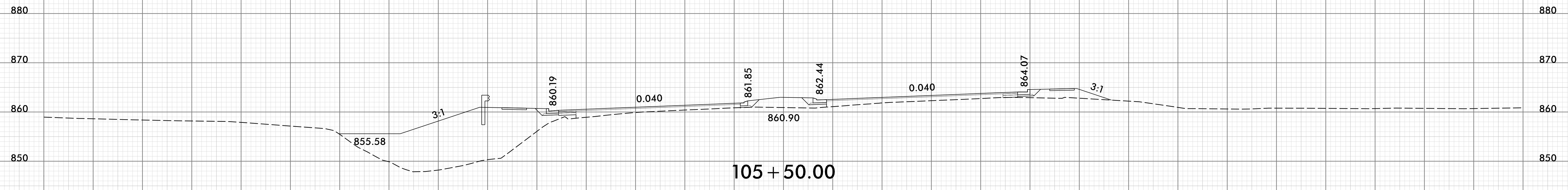
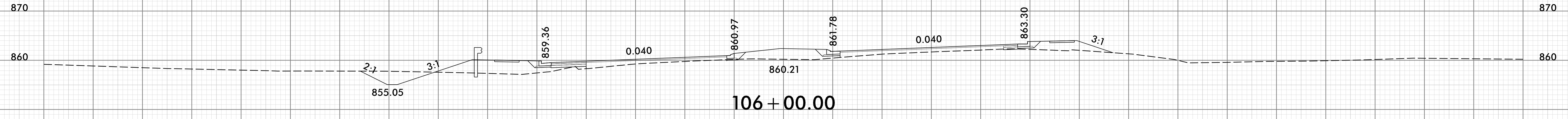

150 140 130 120 110 100 90 80 70 60 50 40 30 20 10 0 10 20 30 40 50 60 70 80 90 100 110 120 130 140 150

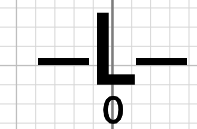

150 140 130 120 110 100 90 80 70 60 50 40 30 20 10 0 10 20 30 40 50 60 70 80 90 100 110 120 130 140 150

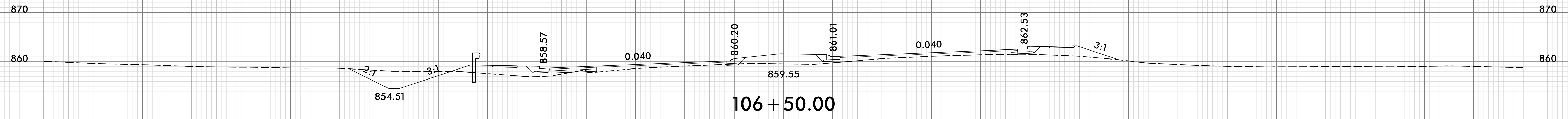
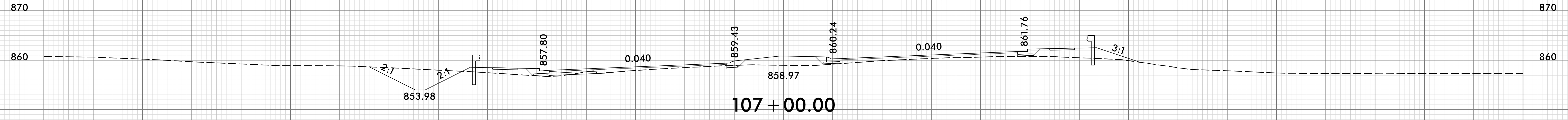
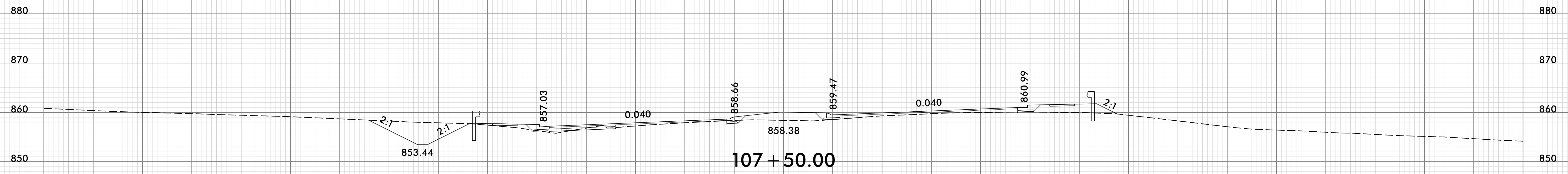
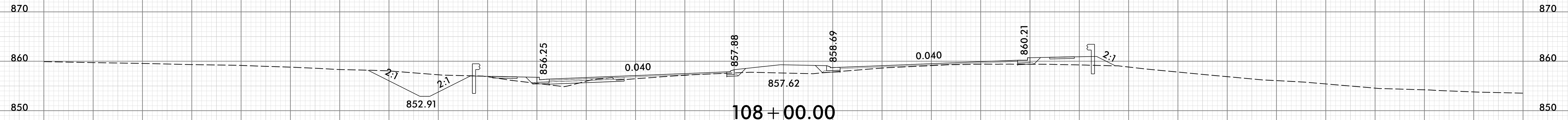

150 140 130 120 110 100 90 80 70 60 50 40 30 20 10 0 10 20 30 40 50 60 70 80 90 100 110 120 130 140 150

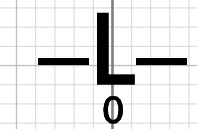
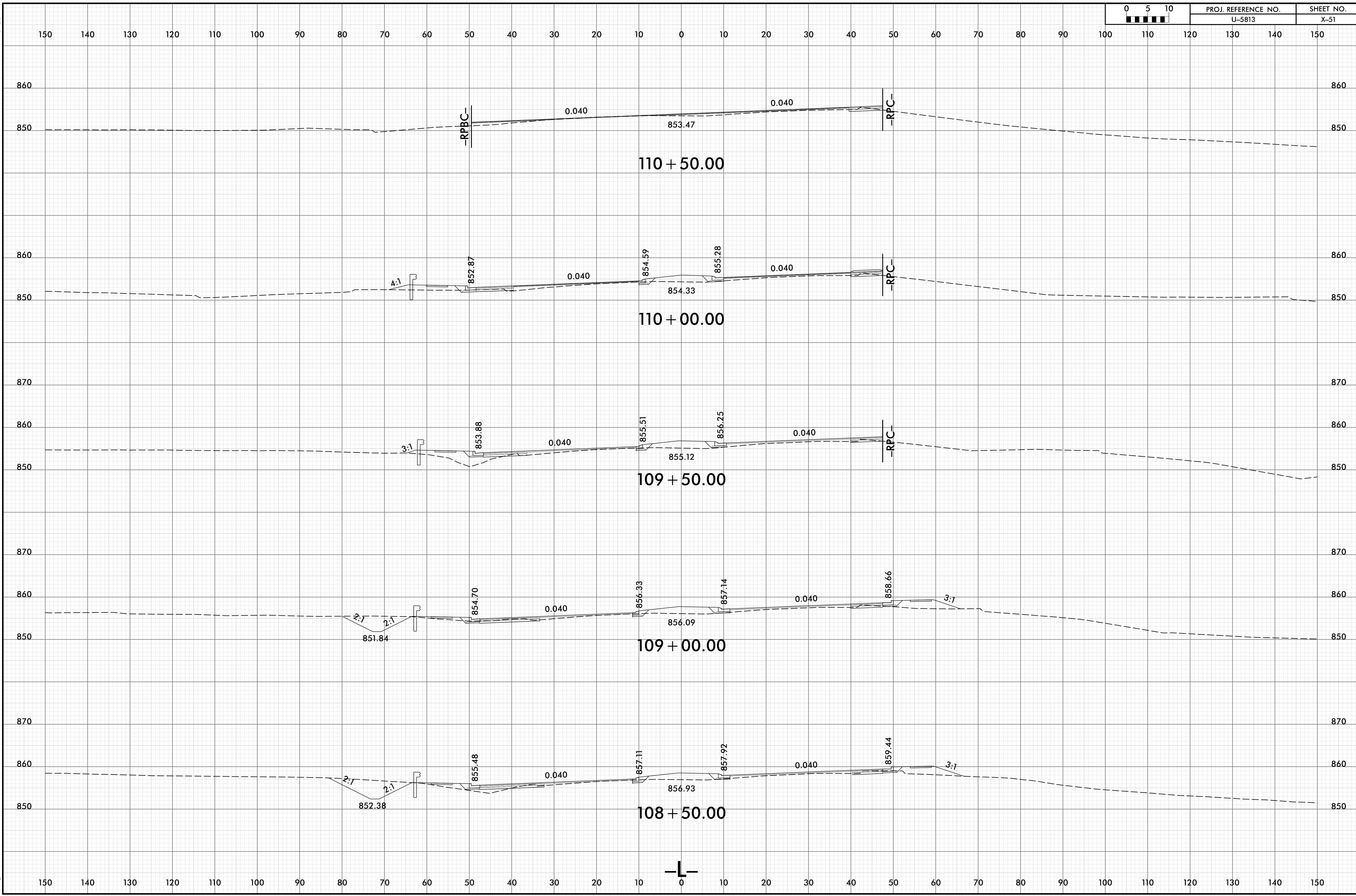

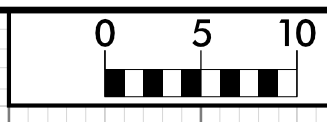

150 140 130 120 110 100 90 80 70 60 50 40 30 20 10 0 10 20 30 40 50 60 70 80 90 100 110 120 130 140 150

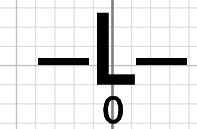
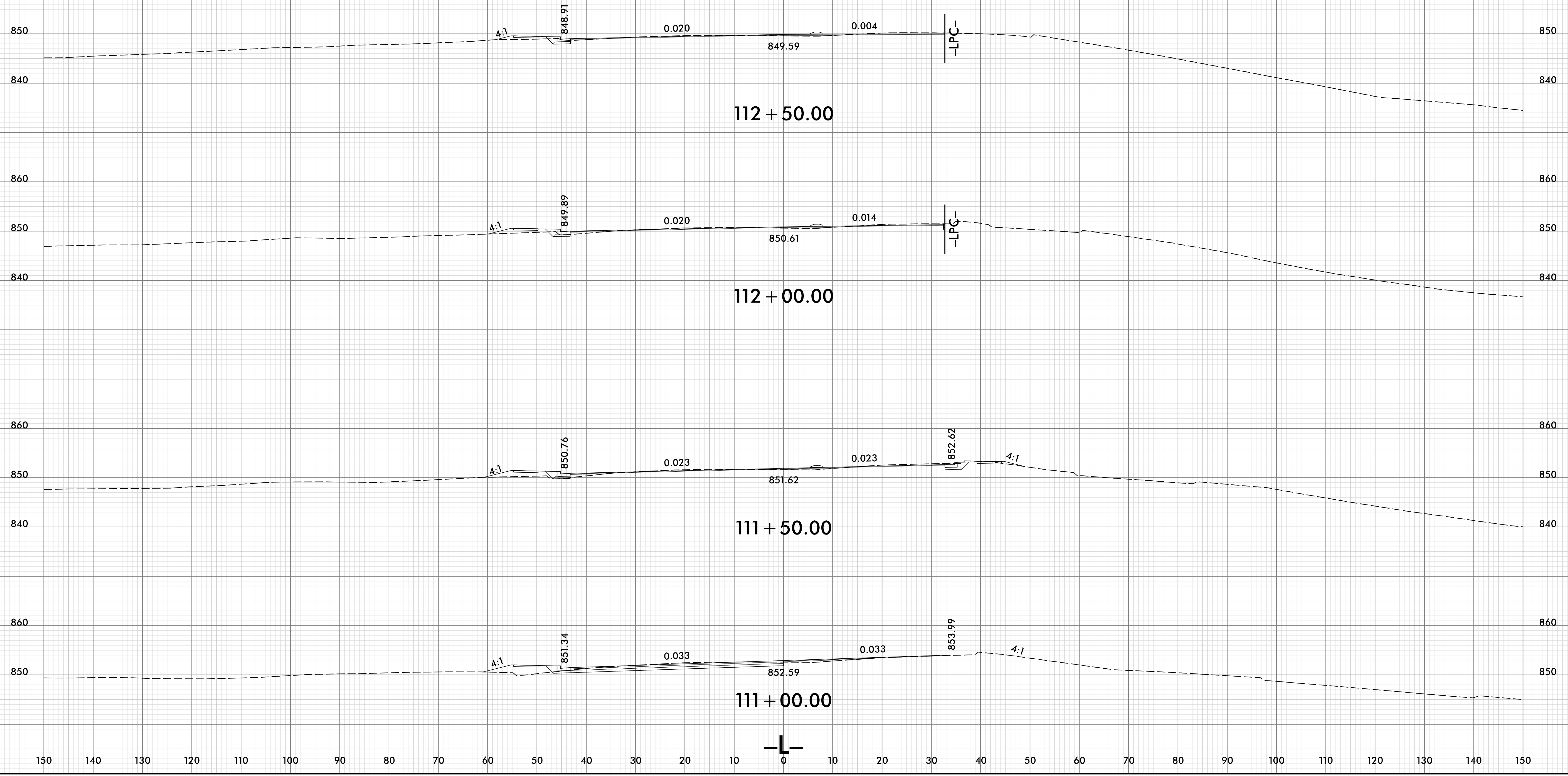

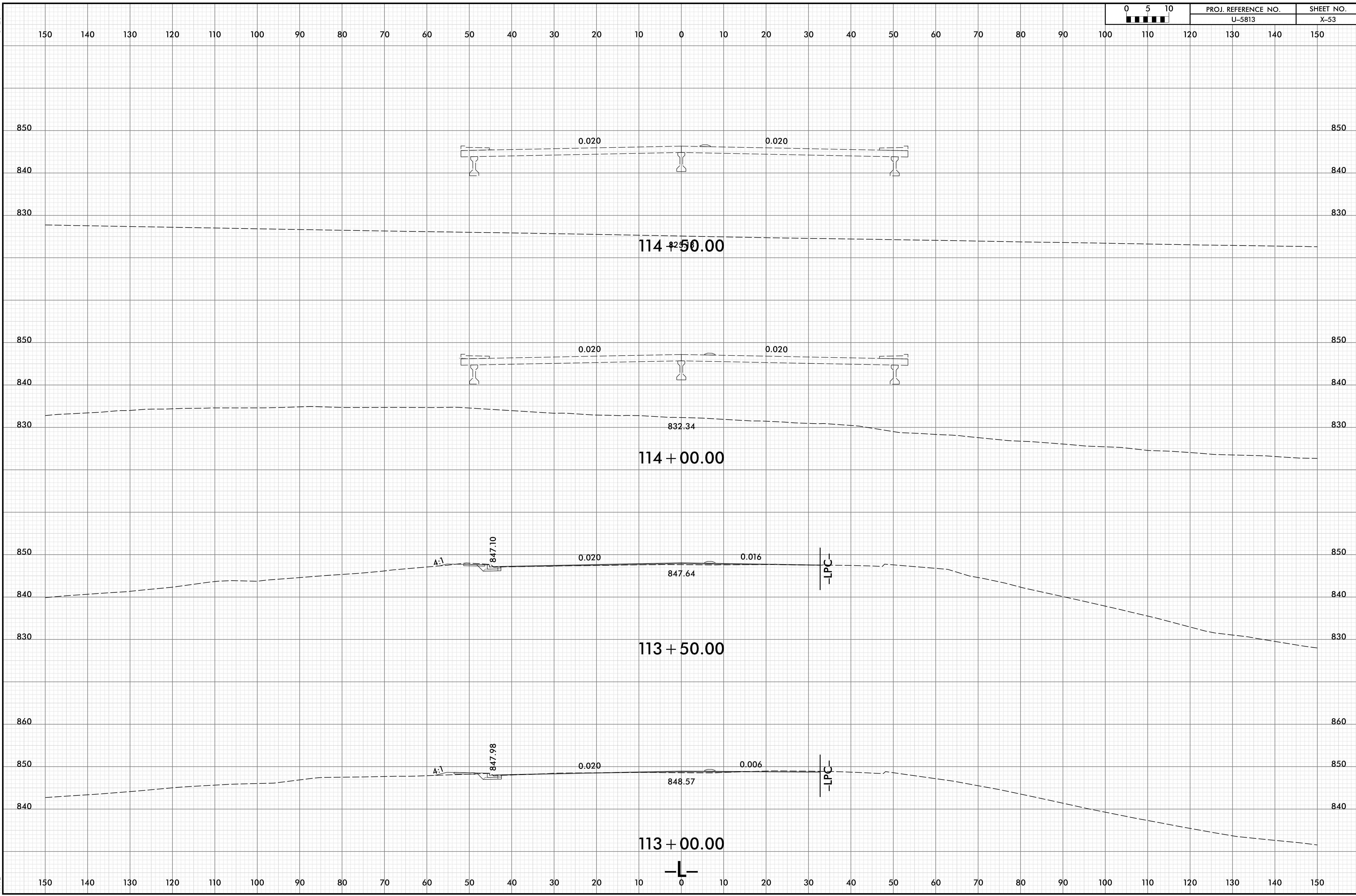

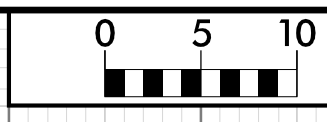

150 140 130 120 110 100 90 80 70 60 50 40 30 20 10 0 10 20 30 40 50 60 70 80 90 100 110 120 130 140 150

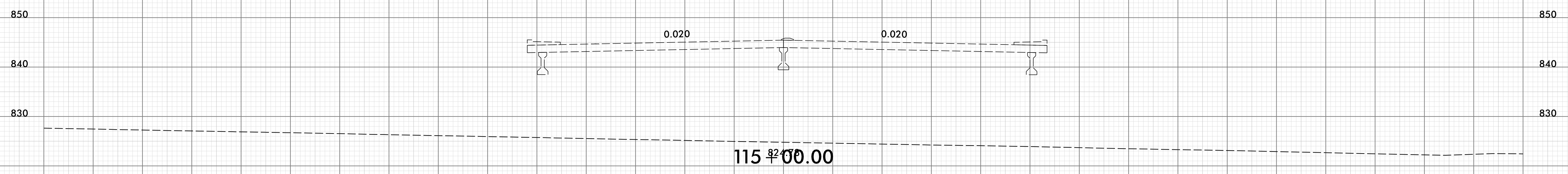
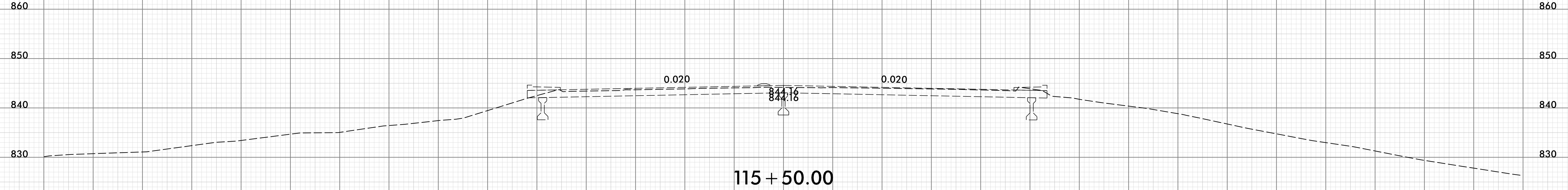
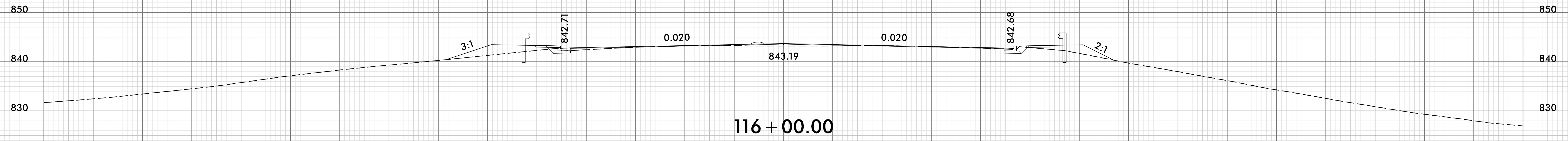
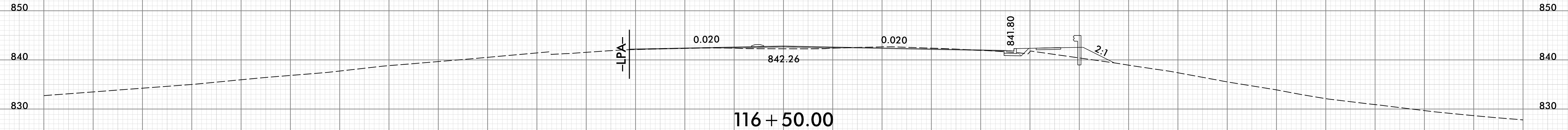

150 140 130 120 110 100 90 80 70 60 50 40 30 20 10 0 10 20 30 40 50 60 70 80 90 100 110 120 130 140 150



150 140 130 120 110 100 90 80 70 60 50 40 30 20 10 0 10 20 30 40 50 60 70 80 90 100 110 120 130 140 150

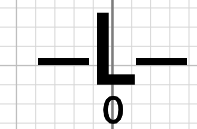
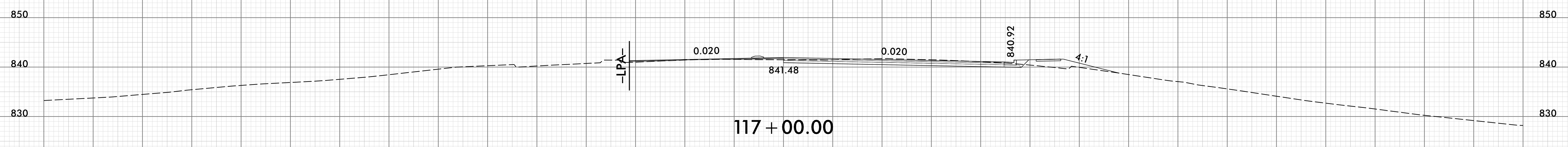
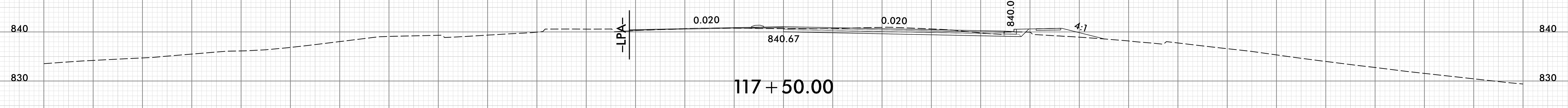
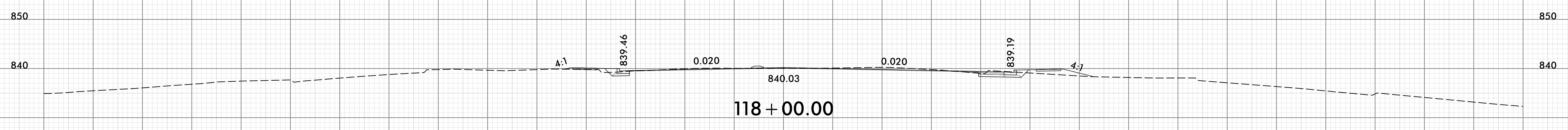
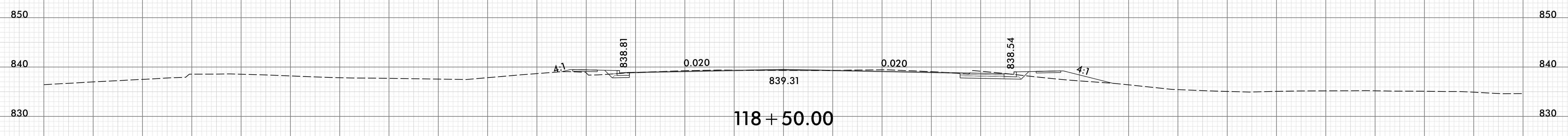
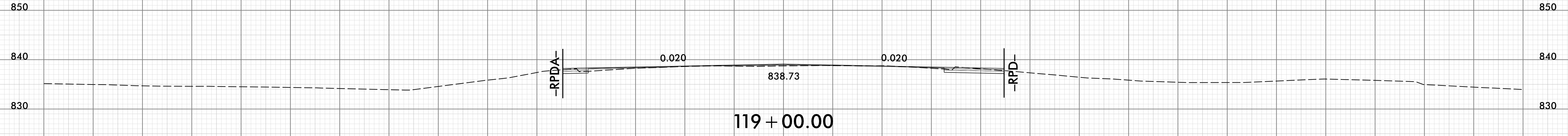

150 140 130 120 110 100 90 80 70 60 50 40 30 20 10 0 10 20 30 40 50 60 70 80 90 100 110 120 130 140 150



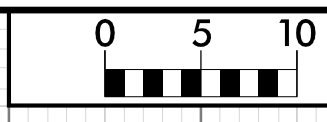

150 140 130 120 110 100 90 80 70 60 50 40 30 20 10 0 10 20 30 40 50 60 70 80 90 100 110 120 130 140 150

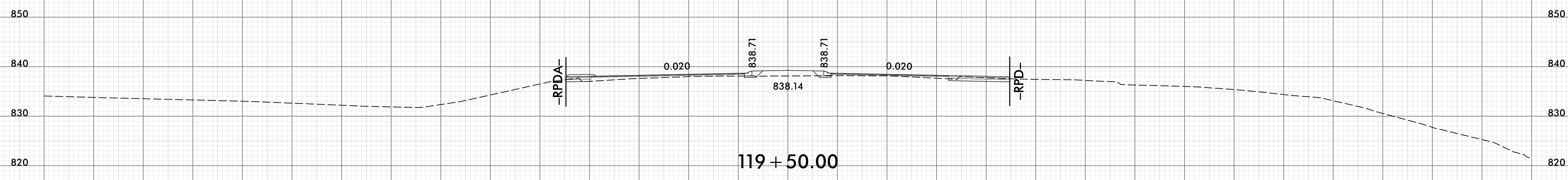
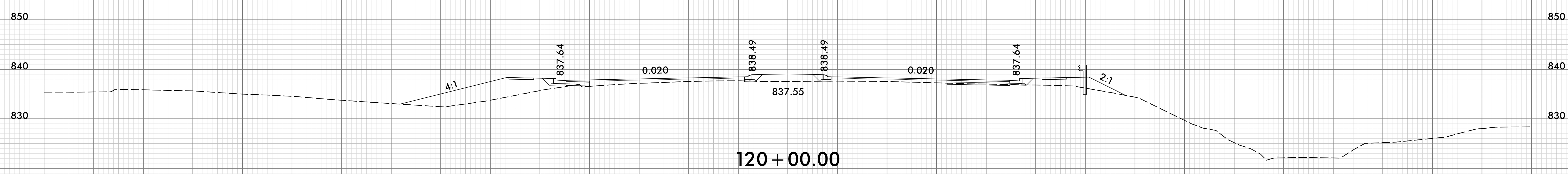
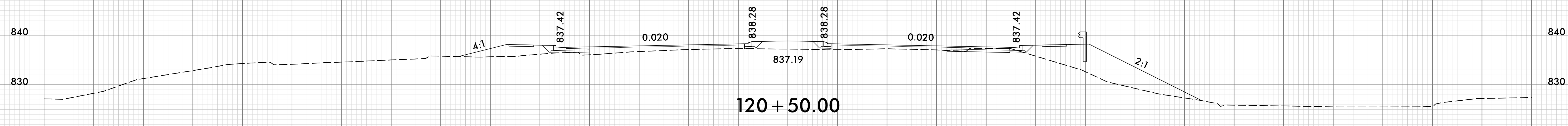
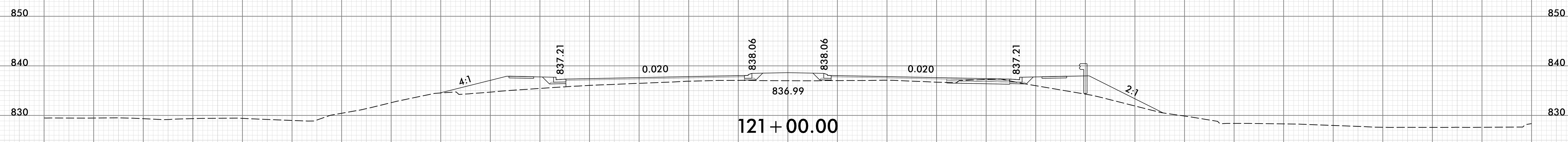

150 140 130 120 110 100 90 80 70 60 50 40 30 20 10 0 10 20 30 40 50 60 70 80 90 100 110 120 130 140 150

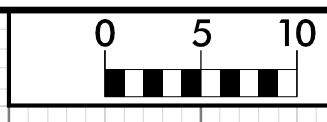

150 140 130 120 110 100 90 80 70 60 50 40 30 20 10 0 10 20 30 40 50 60 70 80 90 100 110 120 130 140 150

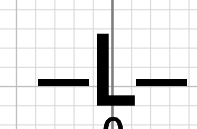
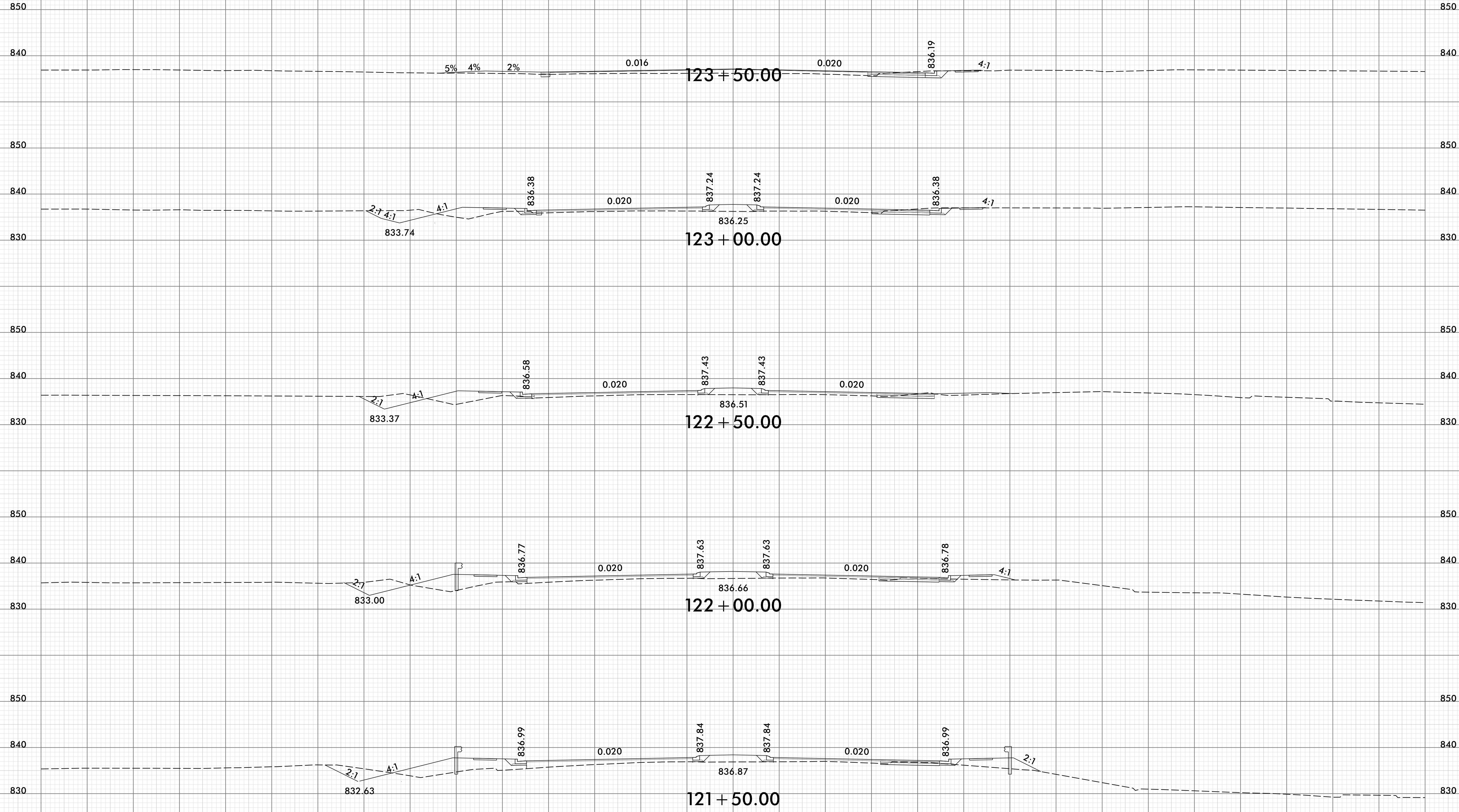

150 140 130 120 110 100 90 80 70 60 50 40 30 20 10 0 10 20 30 40 50 60 70 80 90 100 110 120 130 140 150

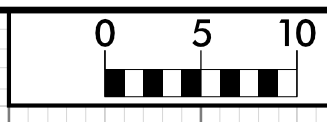

150 140 130 120 110 100 90 80 70 60 50 40 30 20 10 0 10 20 30 40 50 60 70 80 90 100 110 120 130 140 150

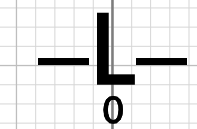
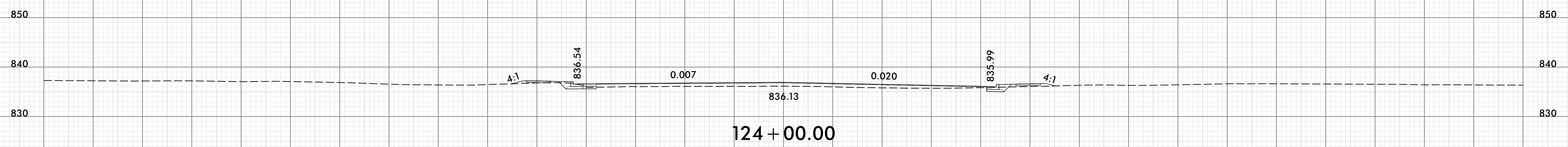
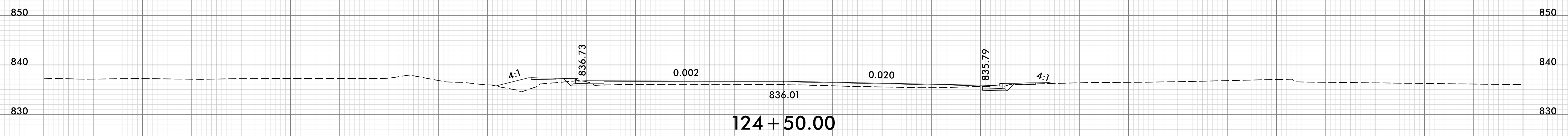
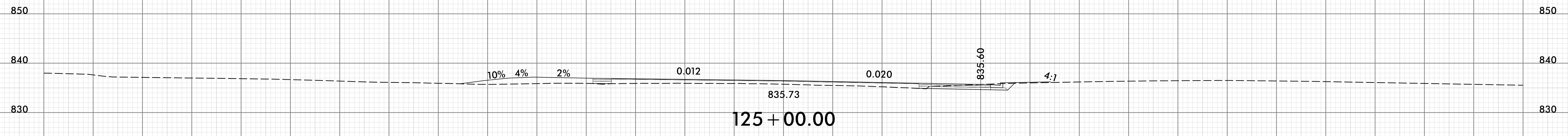
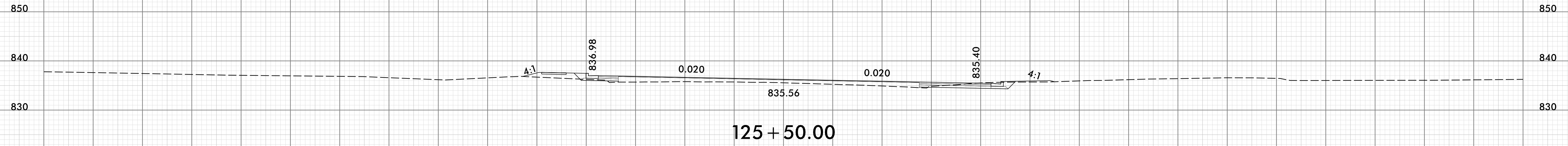

150 140 130 120 110 100 90 80 70 60 50 40 30 20 10 0 10 20 30 40 50 60 70 80 90 100 110 120 130 140 150

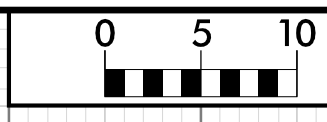

150 140 130 120 110 100 90 80 70 60 50 40 30 20 10 0 10 20 30 40 50 60 70 80 90 100 110 120 130 140 150

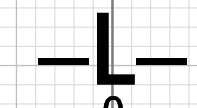
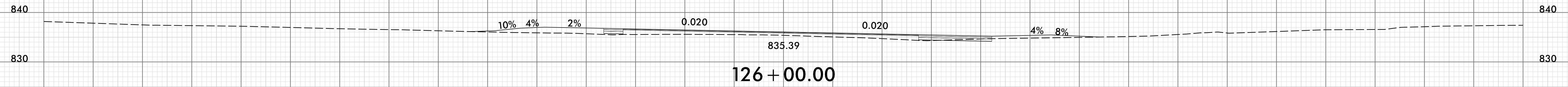
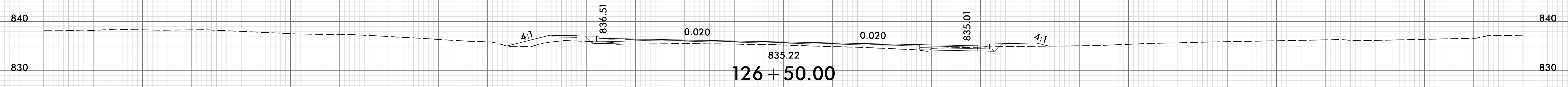
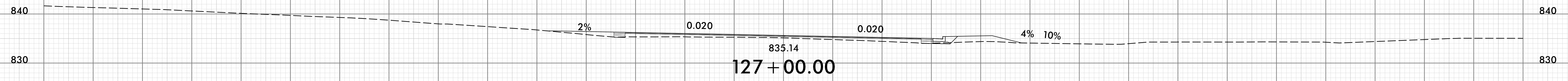
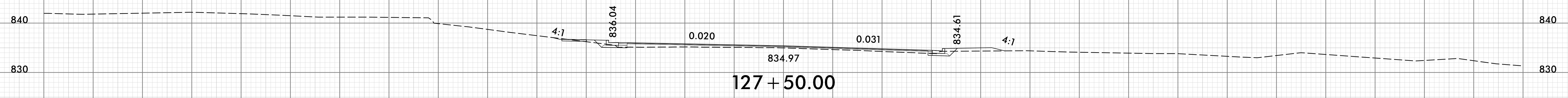
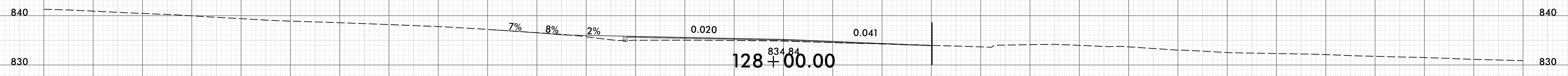

150 140 130 120 110 100 90 80 70 60 50 40 30 20 10 0 10 20 30 40 50 60 70 80 90 100 110 120 130 140 150

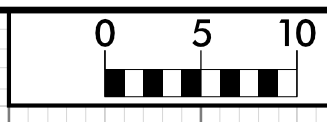

150 140 130 120 110 100 90 80 70 60 50 40 30 20 10 0 10 20 30 40 50 60 70 80 90 100 110 120 130 140 150

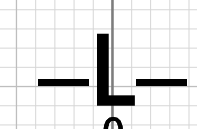
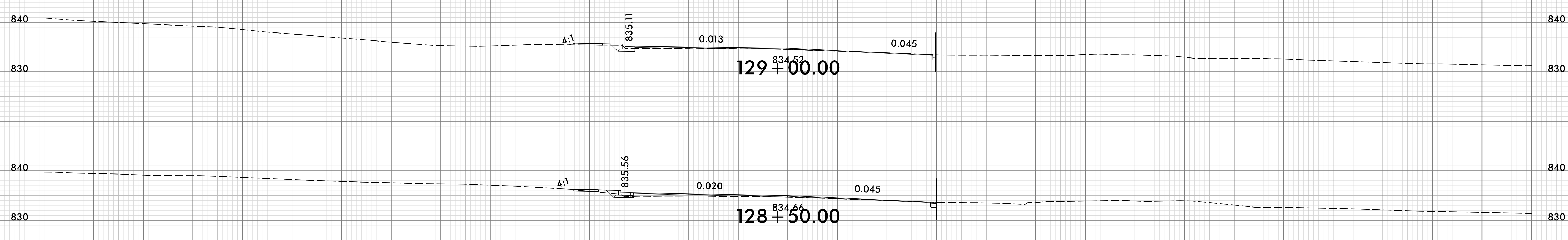

150 140 130 120 110 100 90 80 70 60 50 40 30 20 10 0 10 20 30 40 50 60 70 80 90 100 110 120 130 140 150



PROJ. REFERENCE NO.	SHEET NO.
U-5813	X-61

150 140 130 120 110 100 90 80 70 60 50 40 30 20 10 0 10 20 30 40 50 60 70 80 90 100 110 120 130 140 150

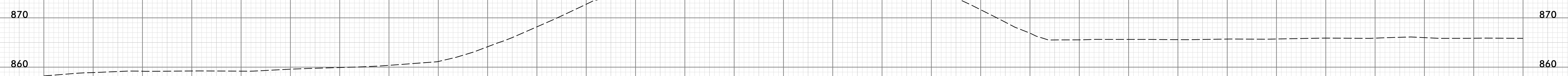
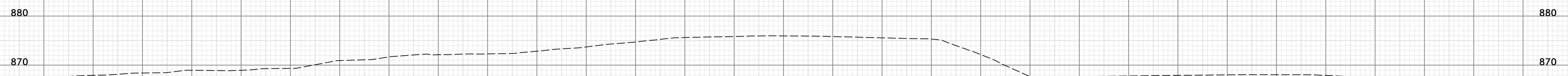
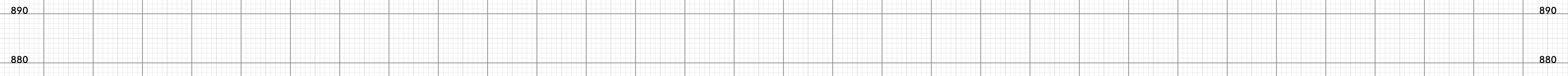
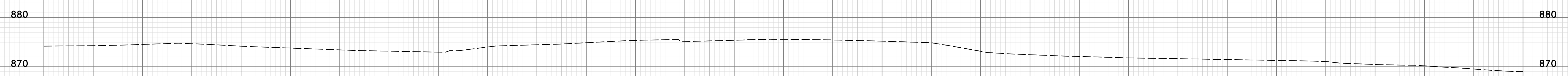
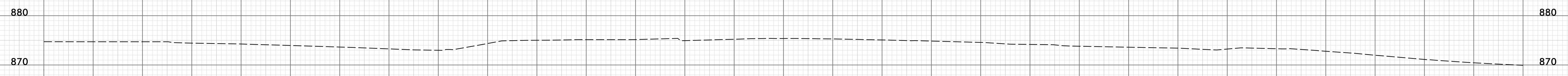

—Y—

150 140 130 120 110 100 90 80 70 60 50 40 30 20 10 0 10 20 30 40 50 60 70 80 90 100 110 120 130 140 150

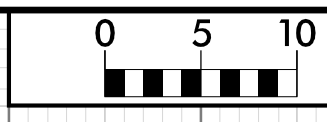

150 140 130 120 110 100 90 80 70 60 50 40 30 20 10 0 10 20 30 40 50 60 70 80 90 100 110 120 130 140 150

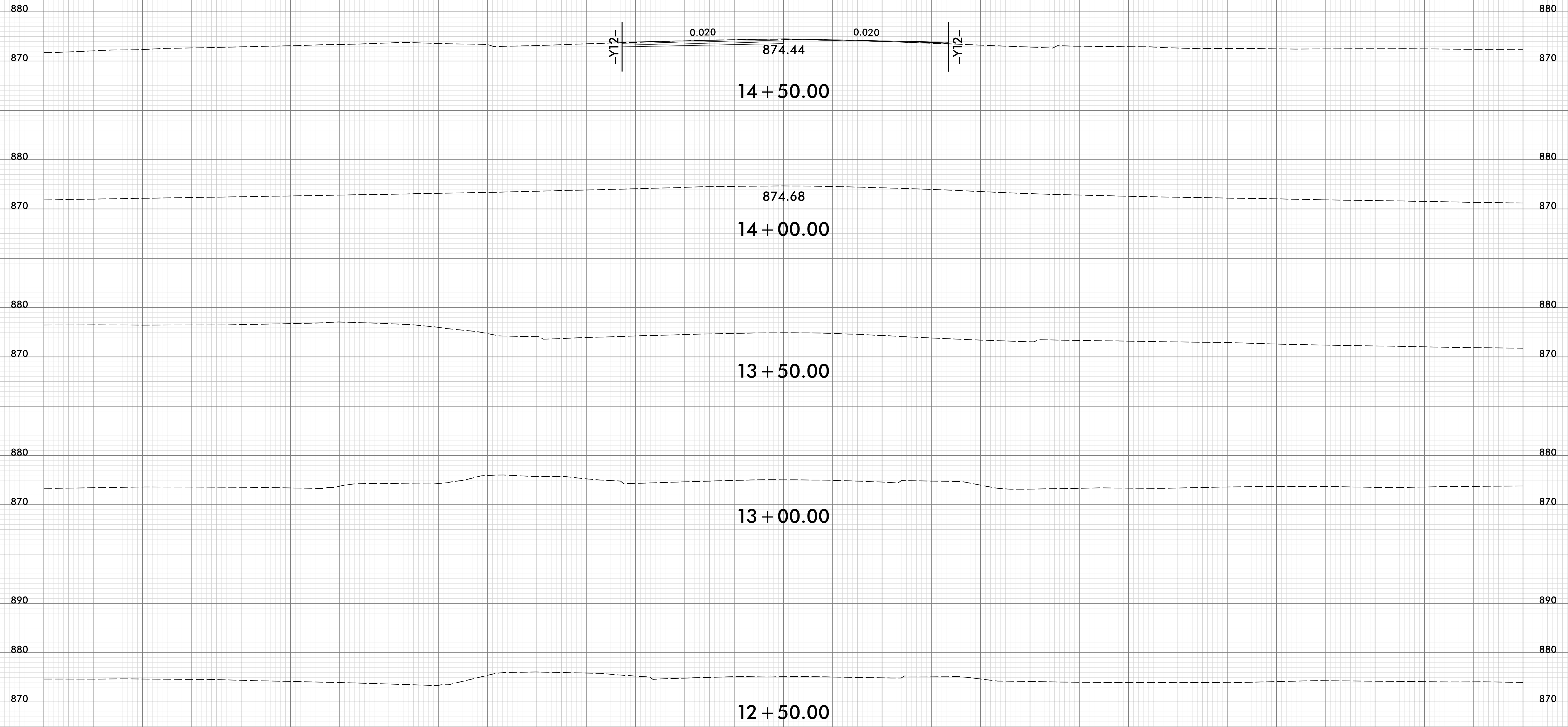

150 140 130 120 110 100 90 80 70 60 50 40 30 20 10 0 10 20 30 40 50 60 70 80 90 100 110 120 130 140 150

Y

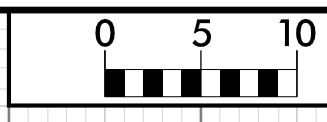

150 140 130 120 110 100 90 80 70 60 50 40 30 20 10 0 10 20 30 40 50 60 70 80 90 100 110 120 130 140 150

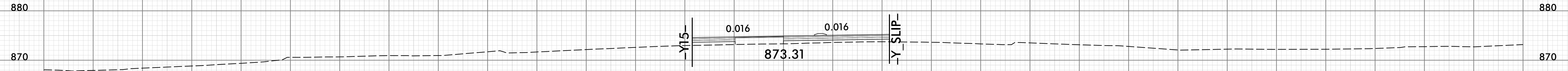

17 + 00.00

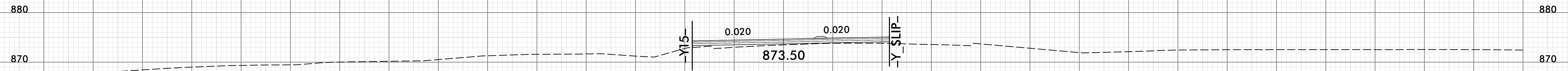

16 + 50.00

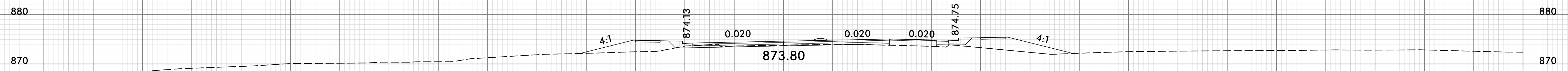

16 + 00.00

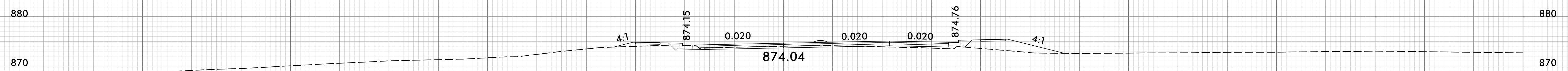

15 + 50.00

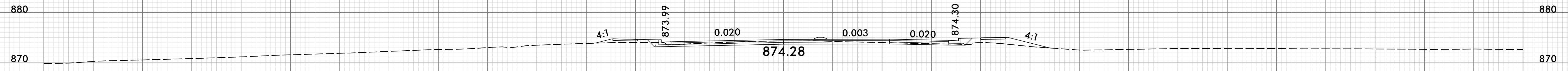

15 + 00.00

-Y-

150 140 130 120 110 100 90 80 70 60 50 40 30 20 10 0 10 20 30 40 50 60 70 80 90 100 110 120 130 140 150



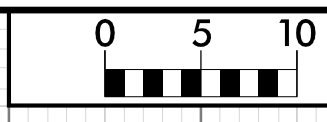

150 140 130 120 110 100 90 80 70 60 50 40 30 20 10 0 10 20 30 40 50 60 70 80 90 100 110 120 130 140 150

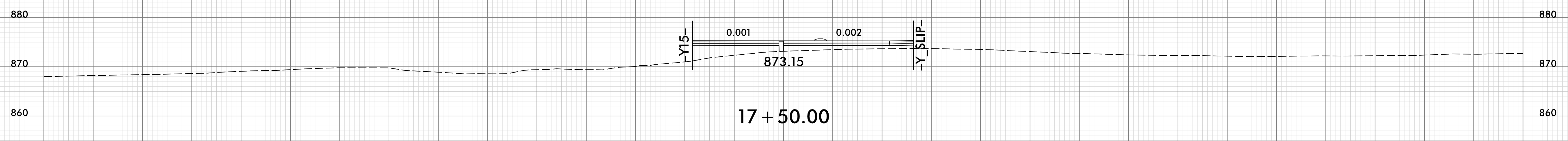
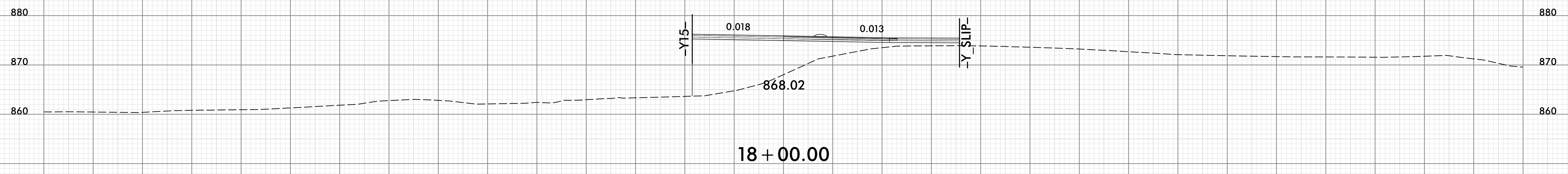
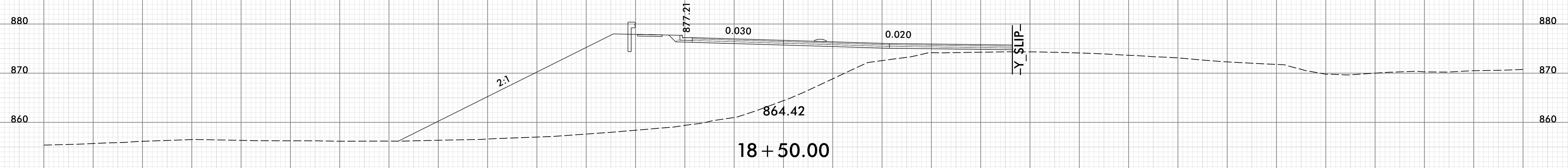
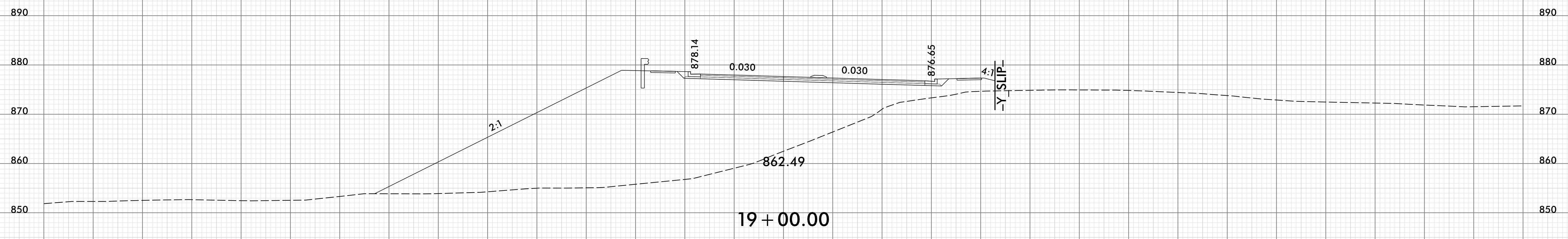

-Y-

150 140 130 120 110 100 90 80 70 60 50 40 30 20 10 0 10 20 30 40 50 60 70 80 90 100 110 120 130 140 150

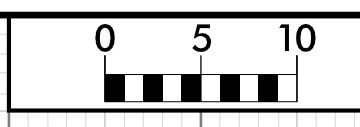

150 140 130 120 110 100 90 80 70 60 50 40 30 20 10 0 10 20 30 40 50 60 70 80 90 100 110 120 130 140 150

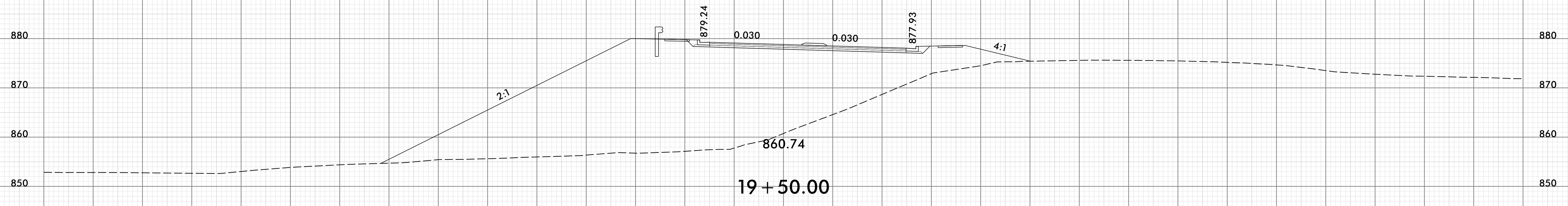
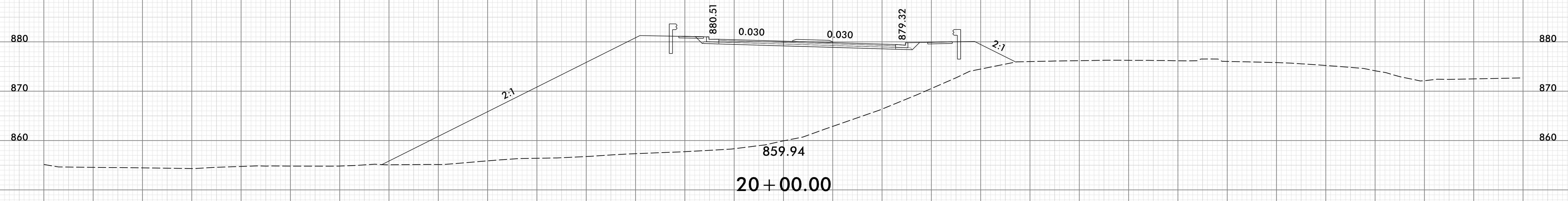
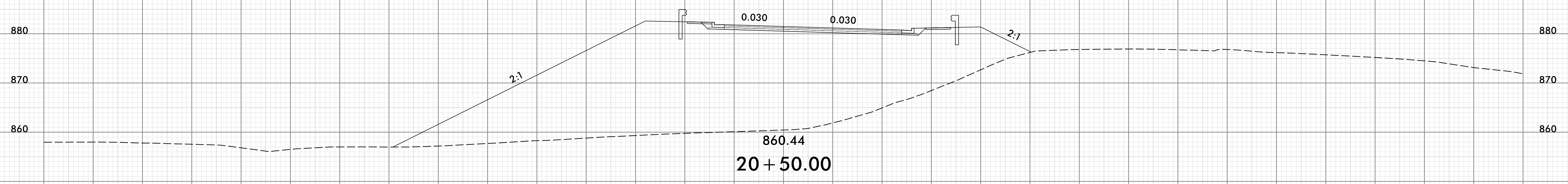

-Y-

150 140 130 120 110 100 90 80 70 60 50 40 30 20 10 0 10 20 30 40 50 60 70 80 90 100 110 120 130 140 150

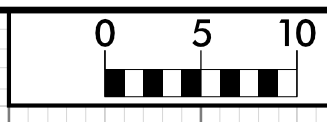

150 140 130 120 110 100 90 80 70 60 50 40 30 20 10 0 10 20 30 40 50 60 70 80 90 100 110 120 130 140 150

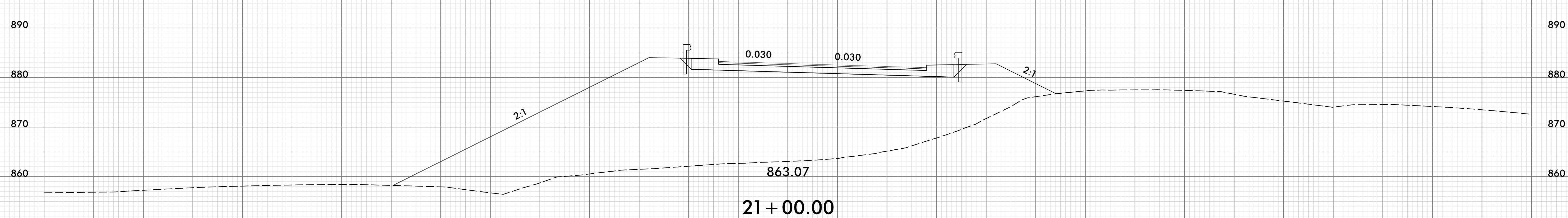
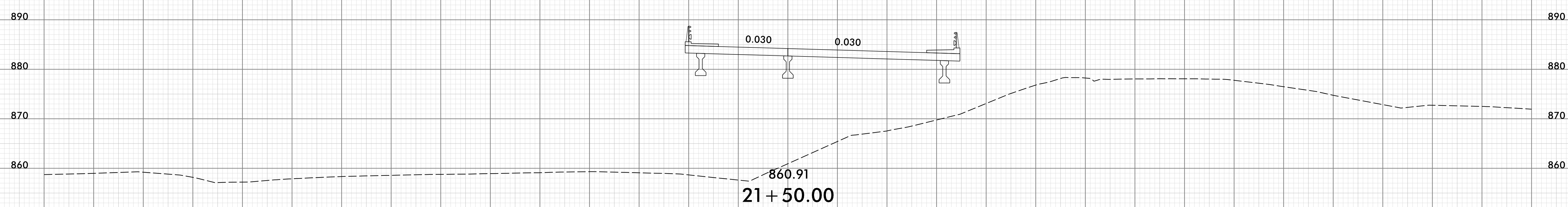
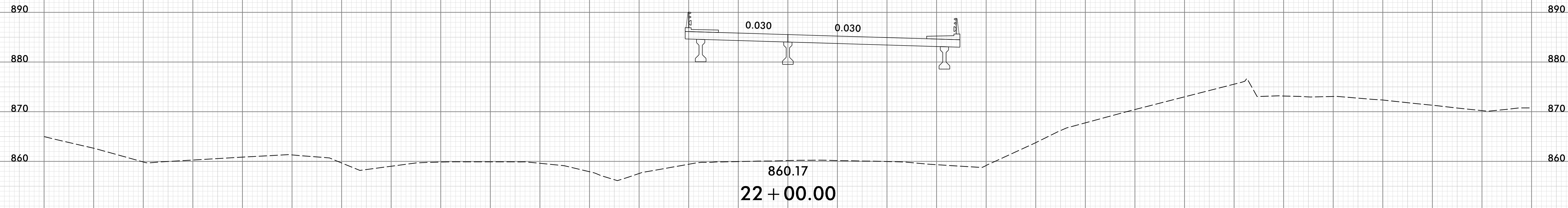

-Y-

150 140 130 120 110 100 90 80 70 60 50 40 30 20 10 0 10 20 30 40 50 60 70 80 90 100 110 120 130 140 150

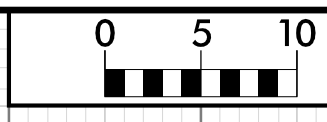

150 140 130 120 110 100 90 80 70 60 50 40 30 20 10 0 10 20 30 40 50 60 70 80 90 100 110 120 130 140 150

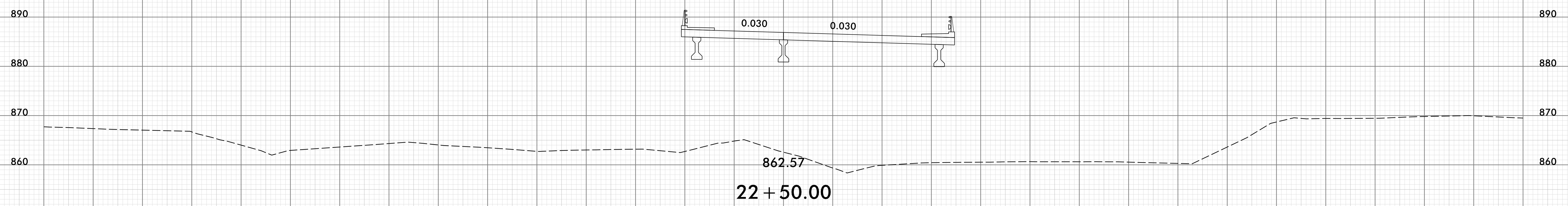
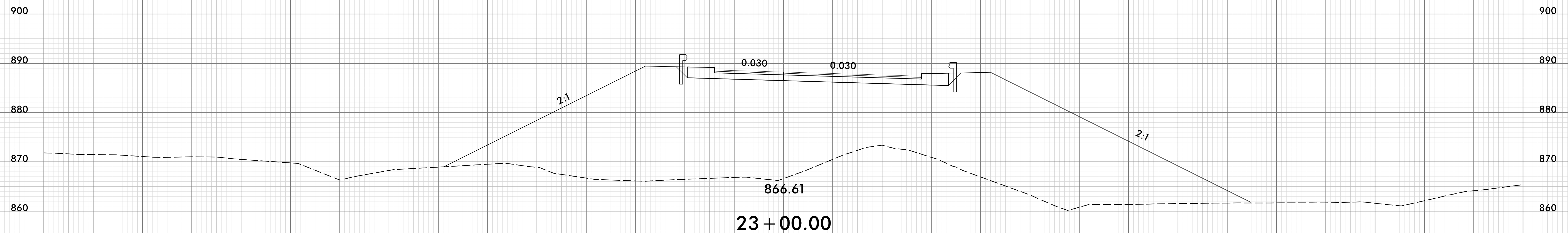
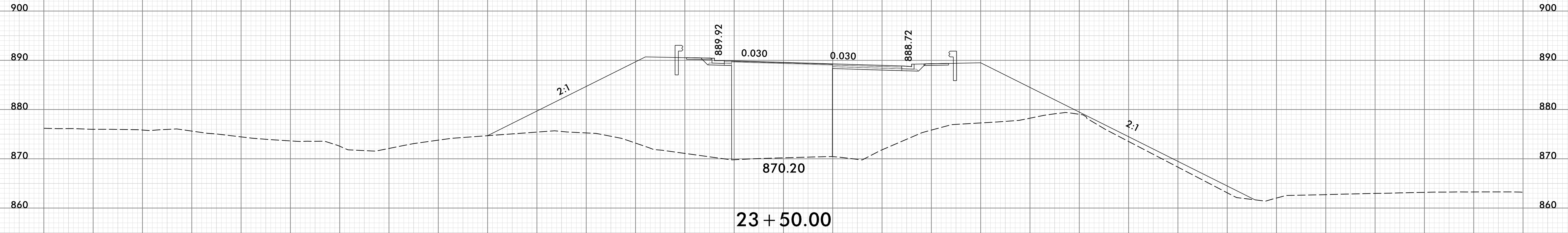

-Y-

150 140 130 120 110 100 90 80 70 60 50 40 30 20 10 0 10 20 30 40 50 60 70 80 90 100 110 120 130 140 150

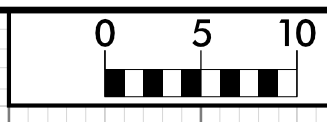

150 140 130 120 110 100 90 80 70 60 50 40 30 20 10 0 10 20 30 40 50 60 70 80 90 100 110 120 130 140 150

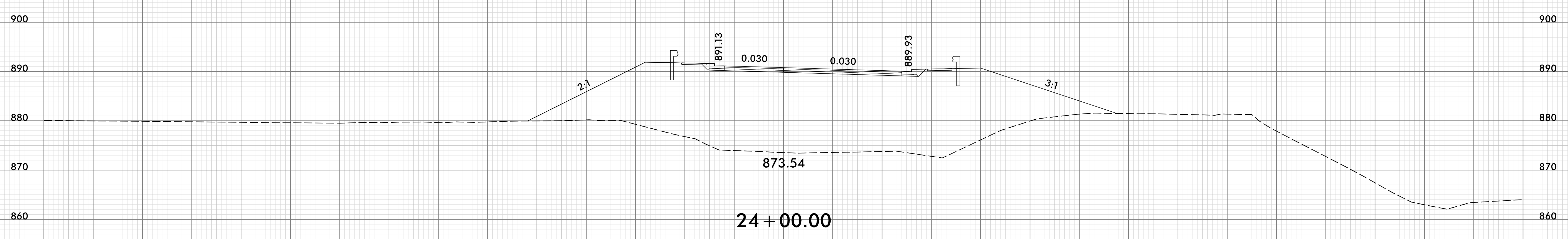
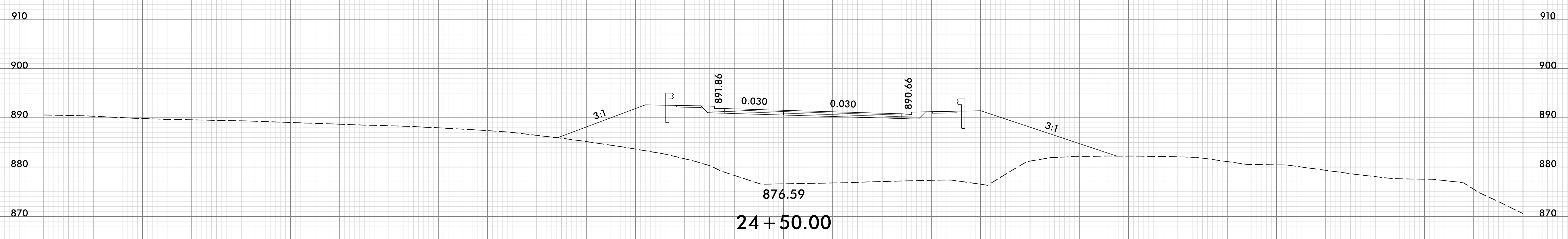
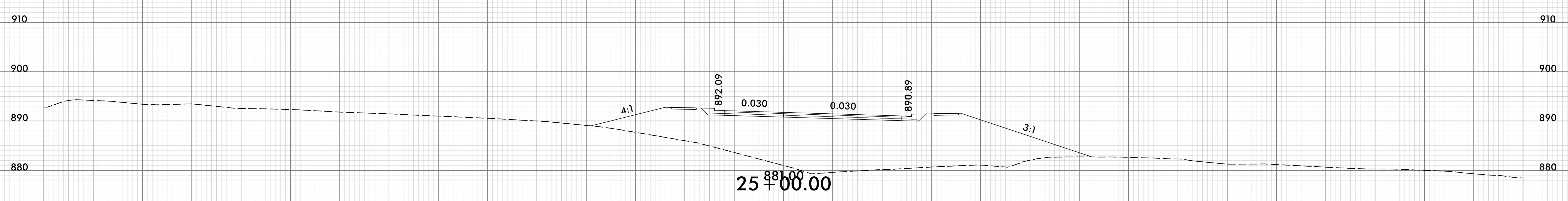

-Y-

150 140 130 120 110 100 90 80 70 60 50 40 30 20 10 0 10 20 30 40 50 60 70 80 90 100 110 120 130 140 150



150 140 130 120 110 100 90 80 70 60 50 40 30 20 10 0 10 20 30 40 50 60 70 80 90 100 110 120 130 140 150

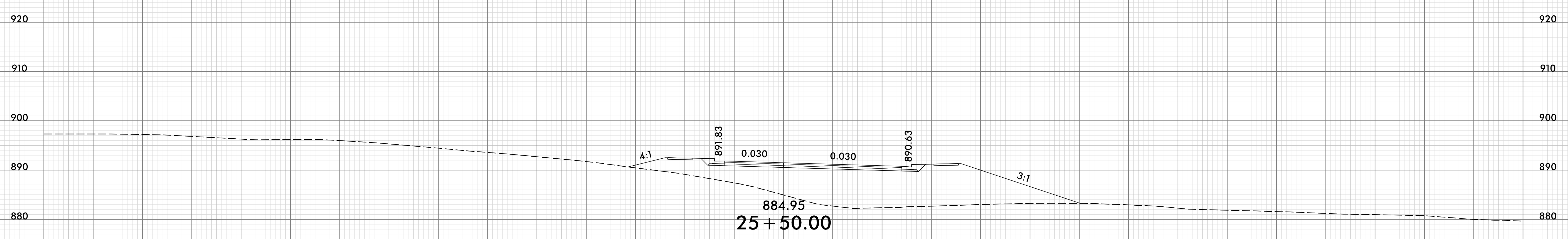
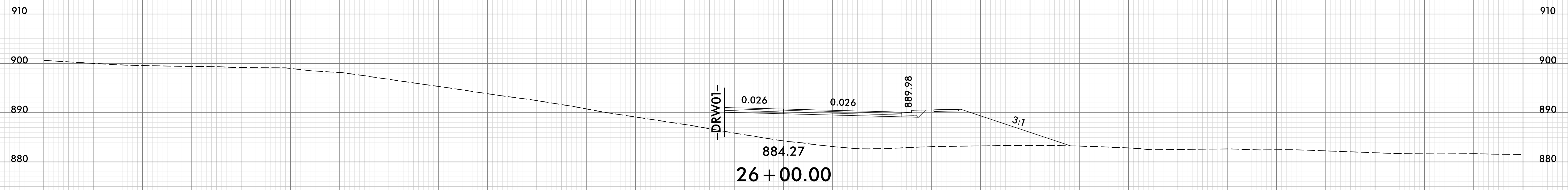
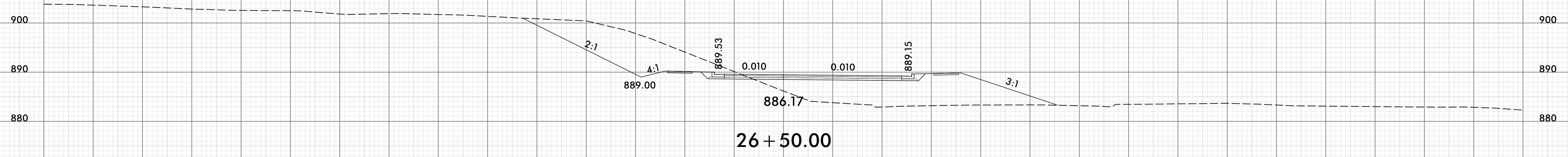
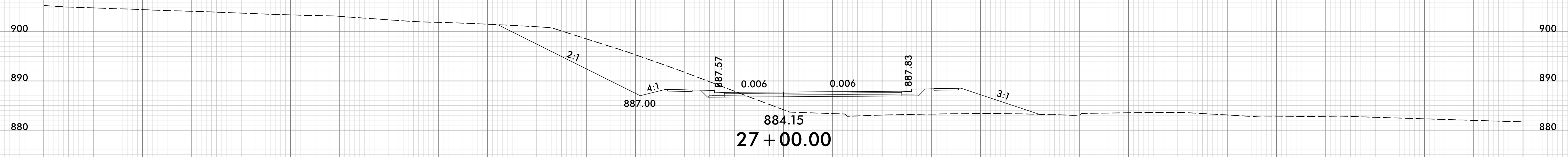

-Y-

150 140 130 120 110 100 90 80 70 60 50 40 30 20 10 0 10 20 30 40 50 60 70 80 90 100 110 120 130 140 150

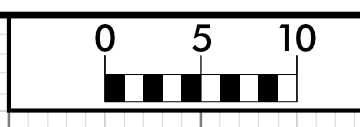

150 140 130 120 110 100 90 80 70 60 50 40 30 20 10 0 10 20 30 40 50 60 70 80 90 100 110 120 130 140 150

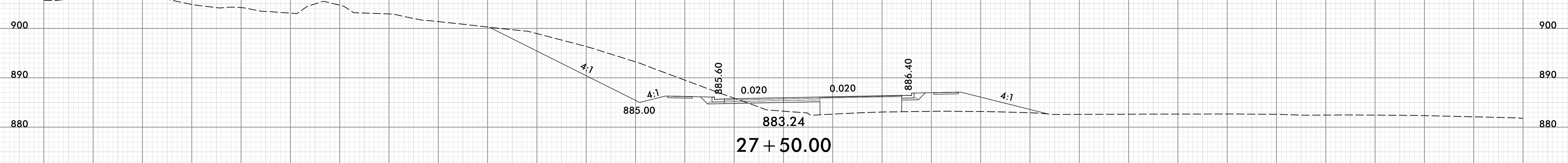
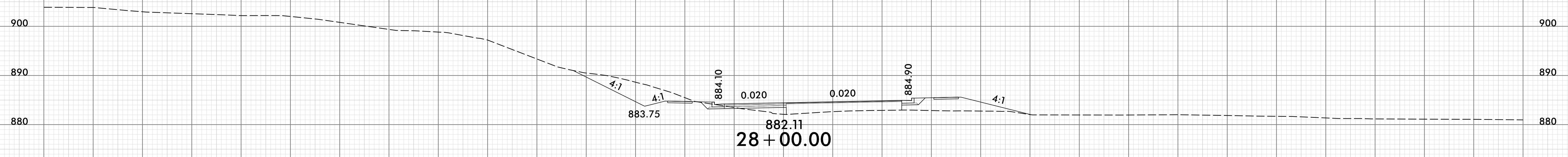
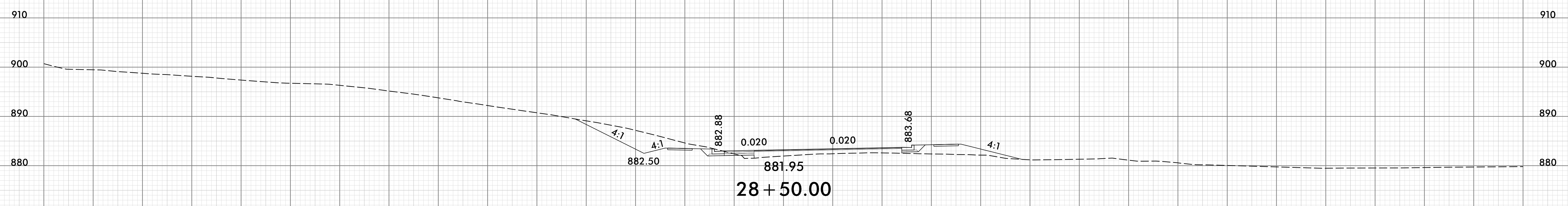
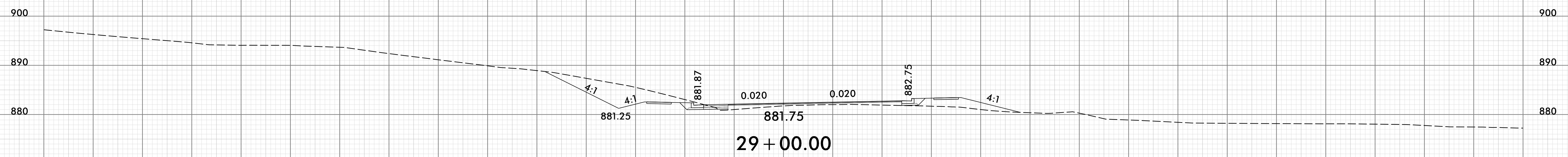

-Y-

150 140 130 120 110 100 90 80 70 60 50 40 30 20 10 0 10 20 30 40 50 60 70 80 90 100 110 120 130 140 150

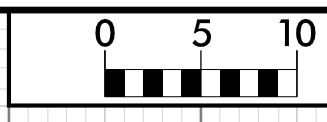

150 140 130 120 110 100 90 80 70 60 50 40 30 20 10 0 10 20 30 40 50 60 70 80 90 100 110 120 130 140 150

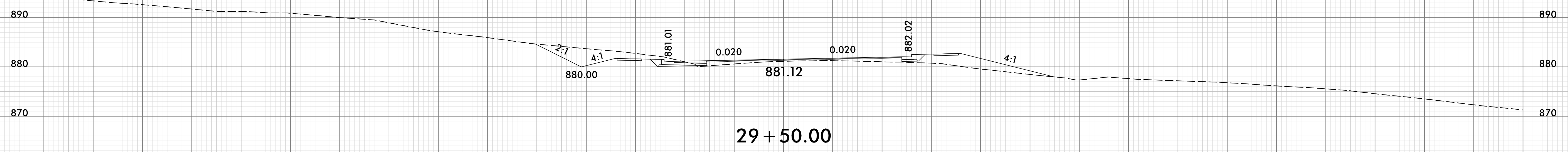
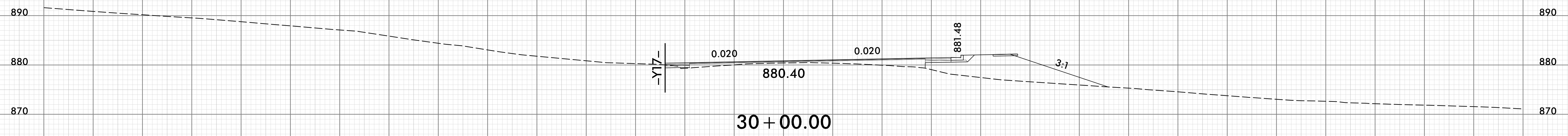
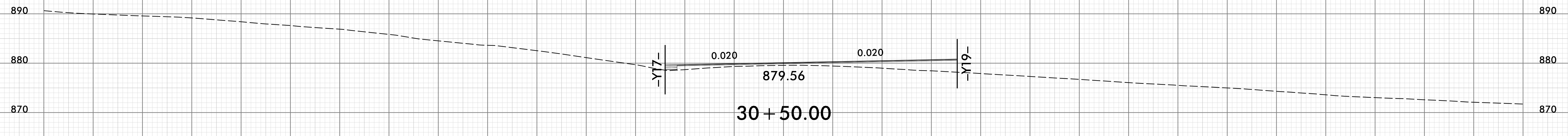
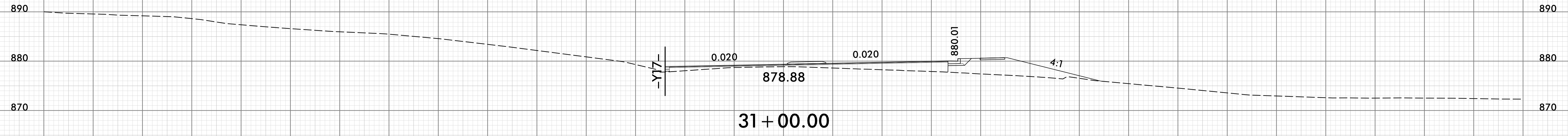

-Y-

150 140 130 120 110 100 90 80 70 60 50 40 30 20 10 0 10 20 30 40 50 60 70 80 90 100 110 120 130 140 150



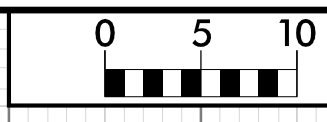

150 140 130 120 110 100 90 80 70 60 50 40 30 20 10 0 10 20 30 40 50 60 70 80 90 100 110 120 130 140 150

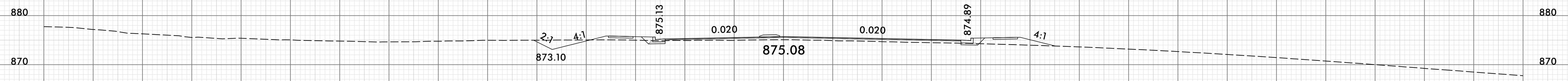

33 + 50.00

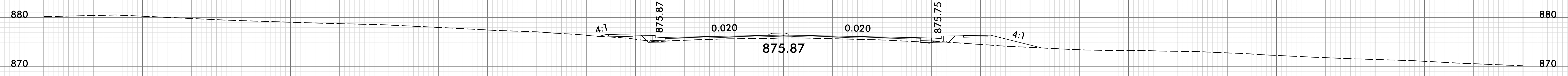

33 + 00.00

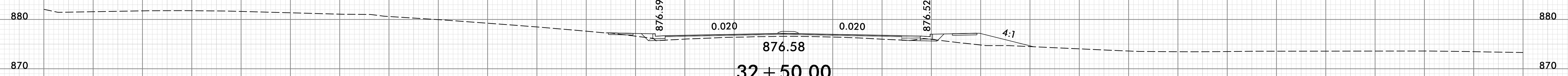

32 + 50.00

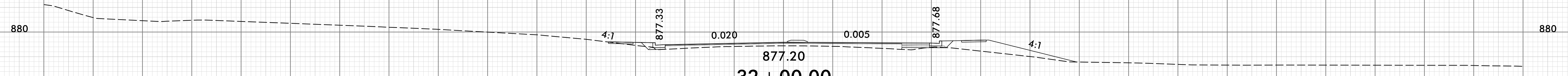

32 + 00.00

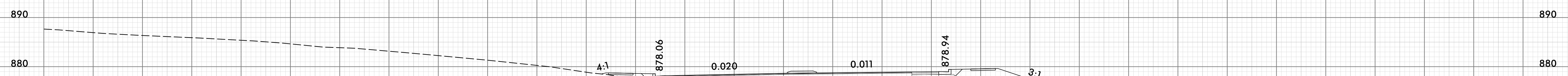

31 + 50.00

-Y-

150 140 130 120 110 100 90 80 70 60 50 40 30 20 10 0 10 20 30 40 50 60 70 80 90 100 110 120 130 140 150

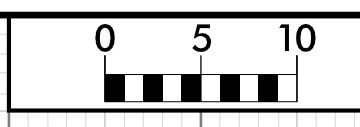

150 140 130 120 110 100 90 80 70 60 50 40 30 20 10 0 10 20 30 40 50 60 70 80 90 100 110 120 130 140 150

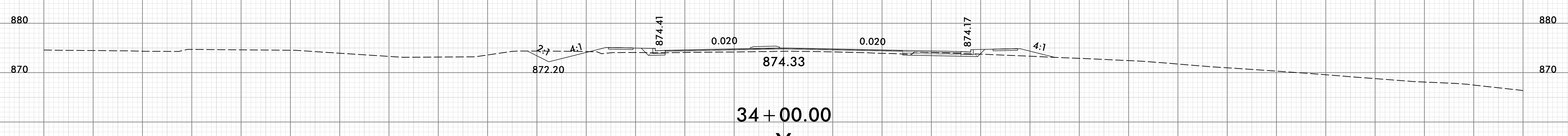
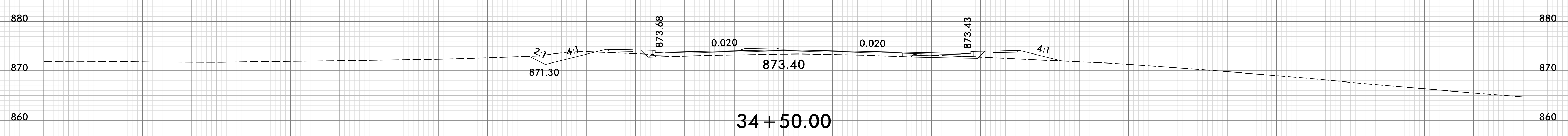
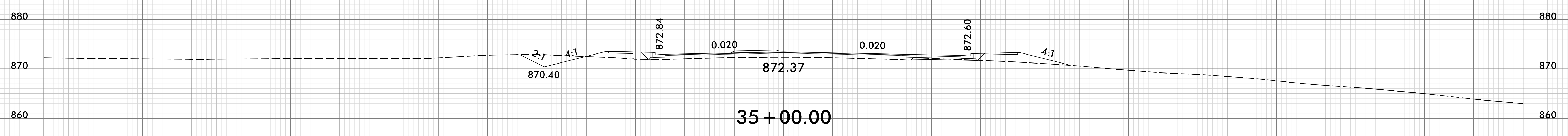
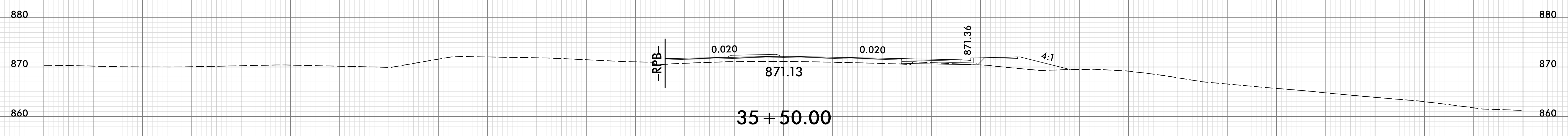
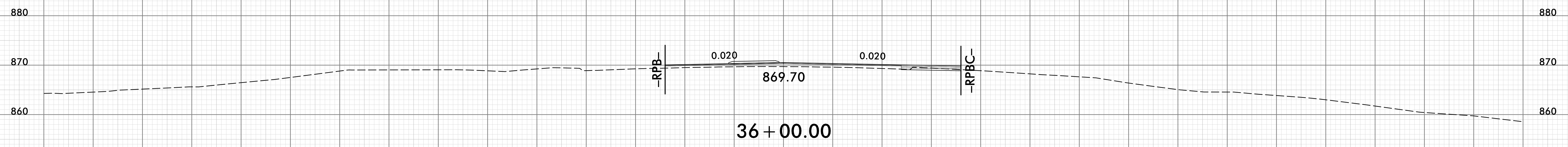

150 140 130 120 110 100 90 80 70 60 50 40 30 20 10 0 10 20 30 40 50 60 70 80 90 100 110 120 130 140 150

-Y-

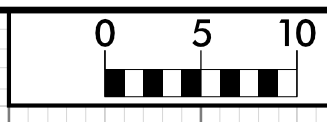

150 140 130 120 110 100 90 80 70 60 50 40 30 20 10 0 10 20 30 40 50 60 70 80 90 100 110 120 130 140 150

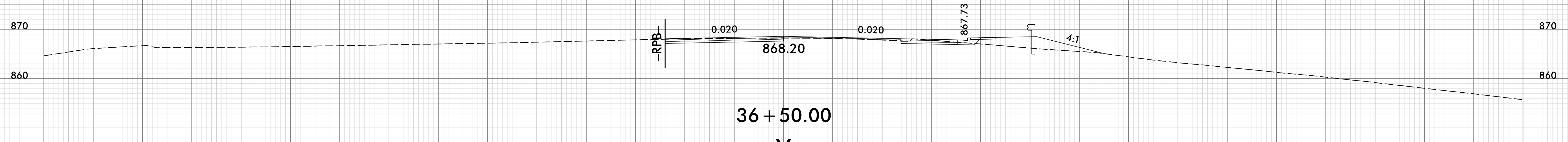
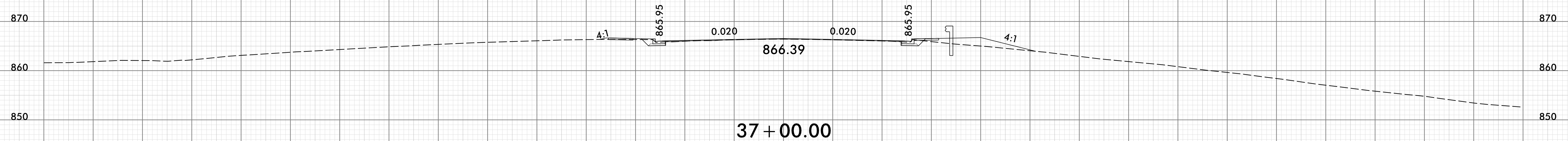
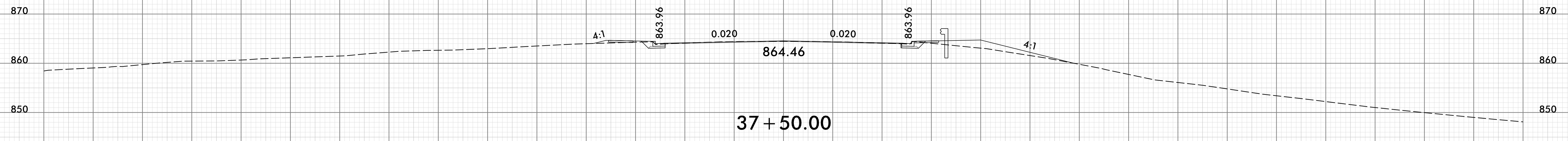
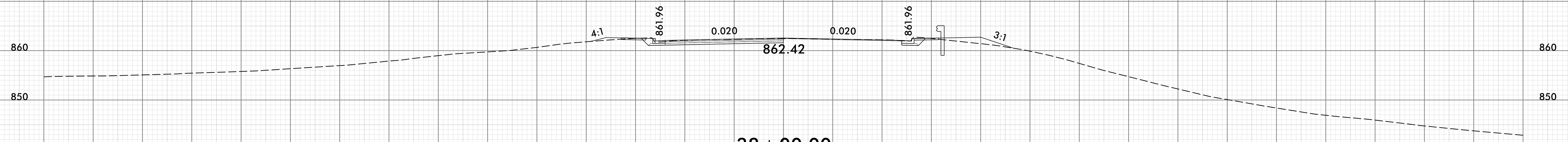

-Y-

150 140 130 120 110 100 90 80 70 60 50 40 30 20 10 0 10 20 30 40 50 60 70 80 90 100 110 120 130 140 150

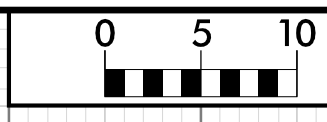

150 140 130 120 110 100 90 80 70 60 50 40 30 20 10 0 10 20 30 40 50 60 70 80 90 100 110 120 130 140 150

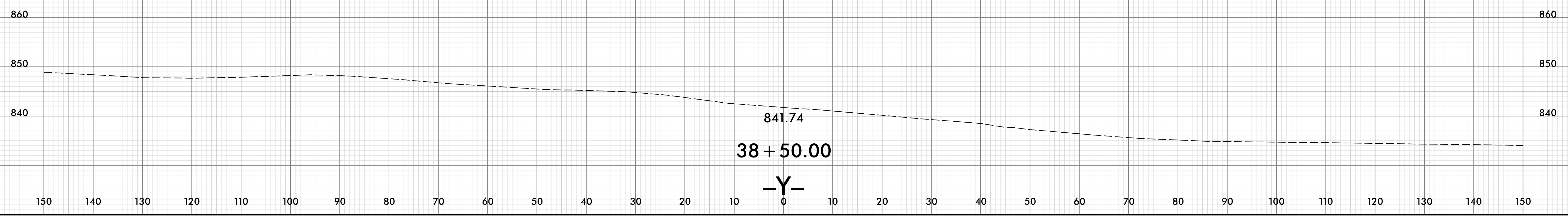
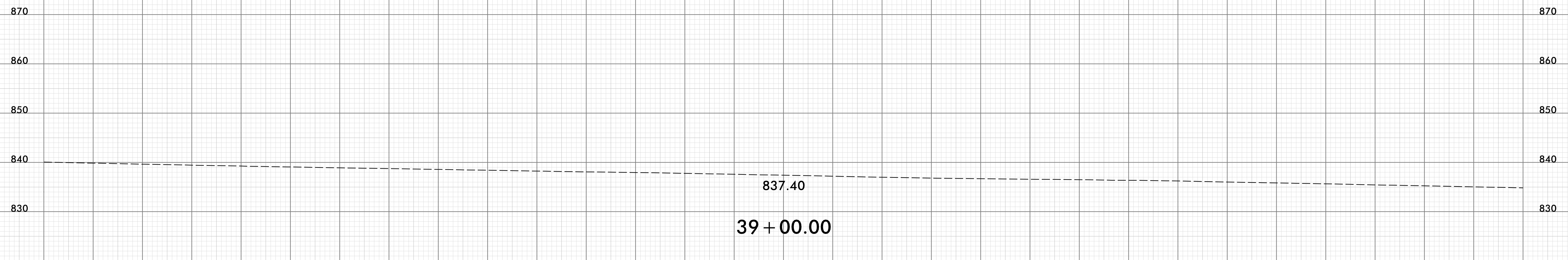
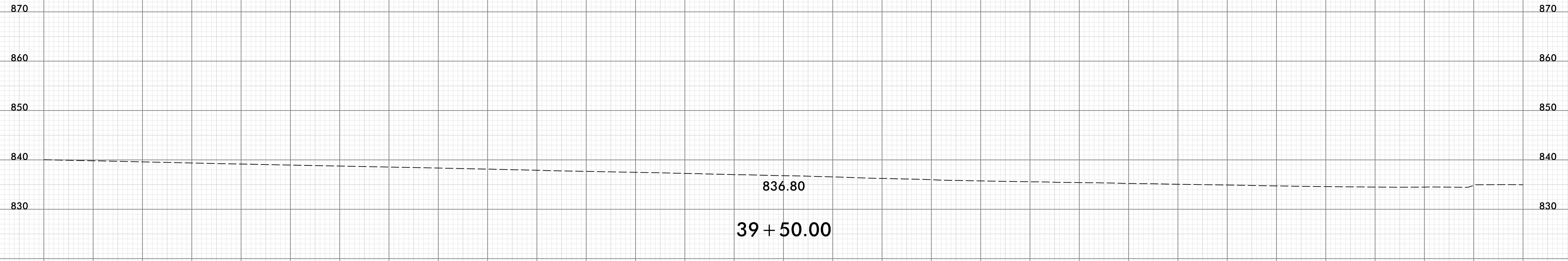



150 140 130 120 110 100 90 80 70 60 50 40 30 20 10 0 10 20 30 40 50 60 70 80 90 100 110 120 130 140 150

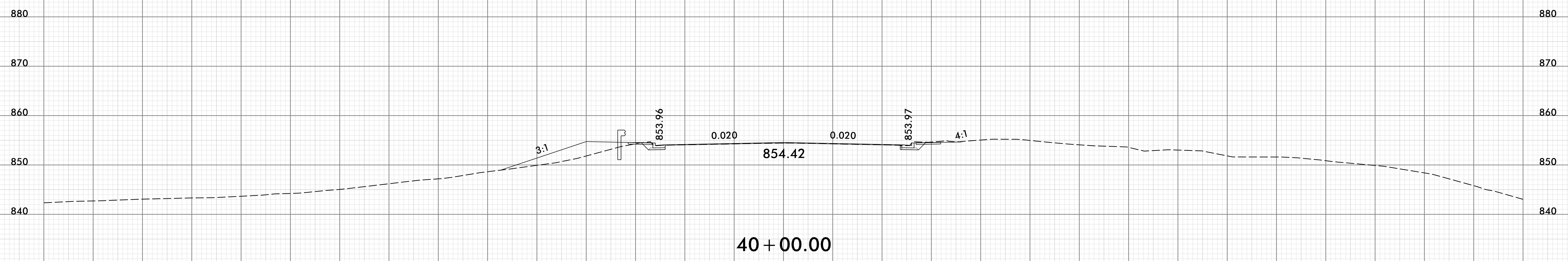
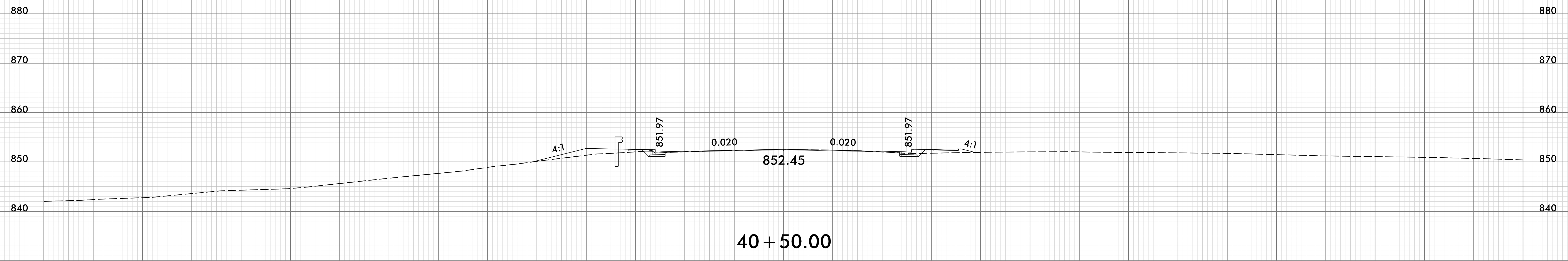
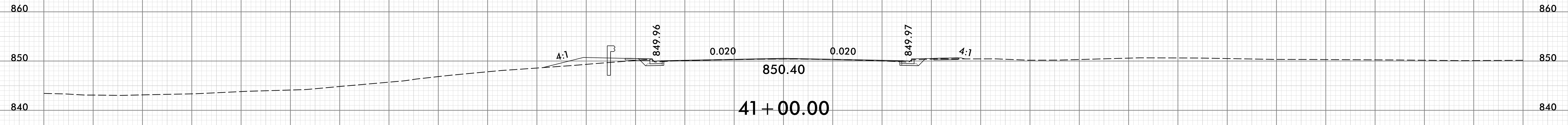

-Y-

150 140 130 120 110 100 90 80 70 60 50 40 30 20 10 0 10 20 30 40 50 60 70 80 90 100 110 120 130 140 150

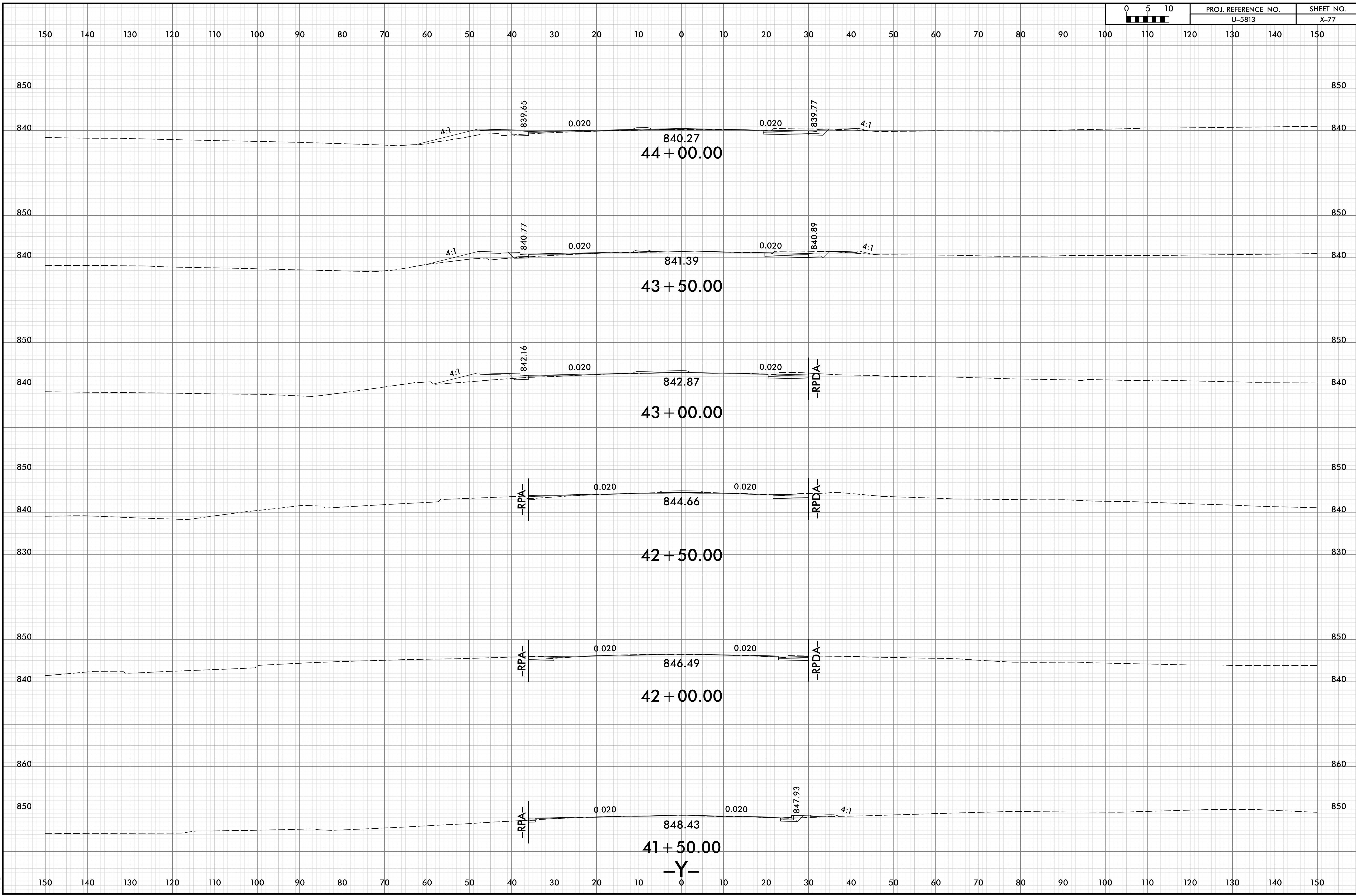

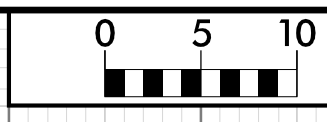

150 140 130 120 110 100 90 80 70 60 50 40 30 20 10 0 10 20 30 40 50 60 70 80 90 100 110 120 130 140 150

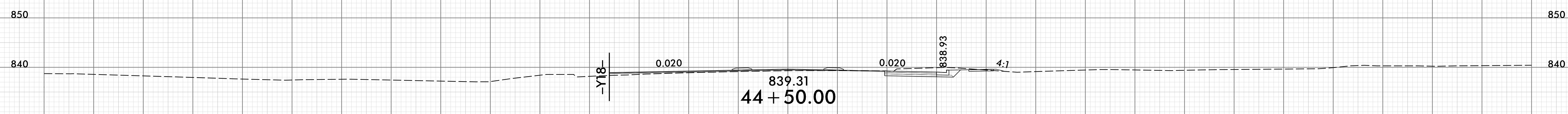
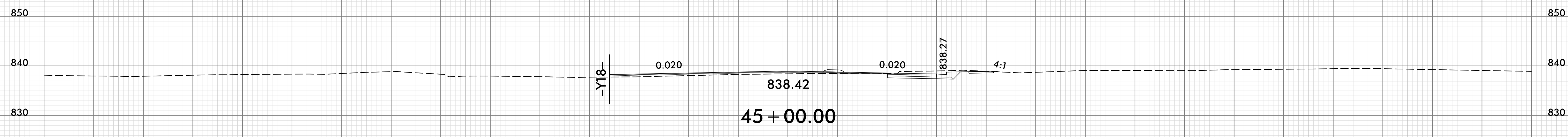
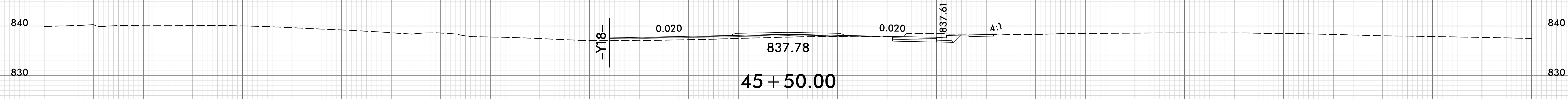
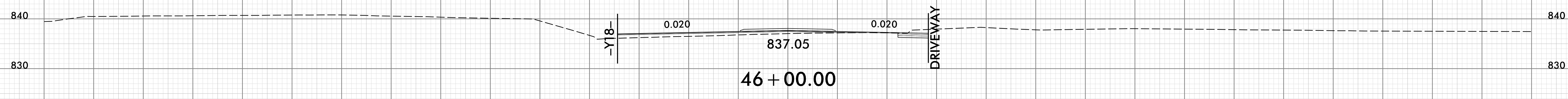
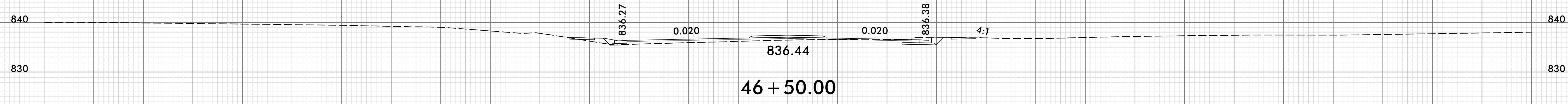

-Y-

150 140 130 120 110 100 90 80 70 60 50 40 30 20 10 0 10 20 30 40 50 60 70 80 90 100 110 120 130 140 150

8/23/99

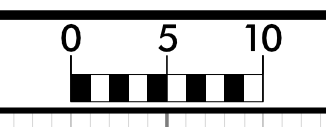

PROJ. REFERENCE NO.	SHEET NO.
U-5813	X-79

150 140 130 120 110 100 90 80 70 60 50 40 30 20 10 0 10 20 30 40 50 60 70 80 90 100 110 120 130 140 150

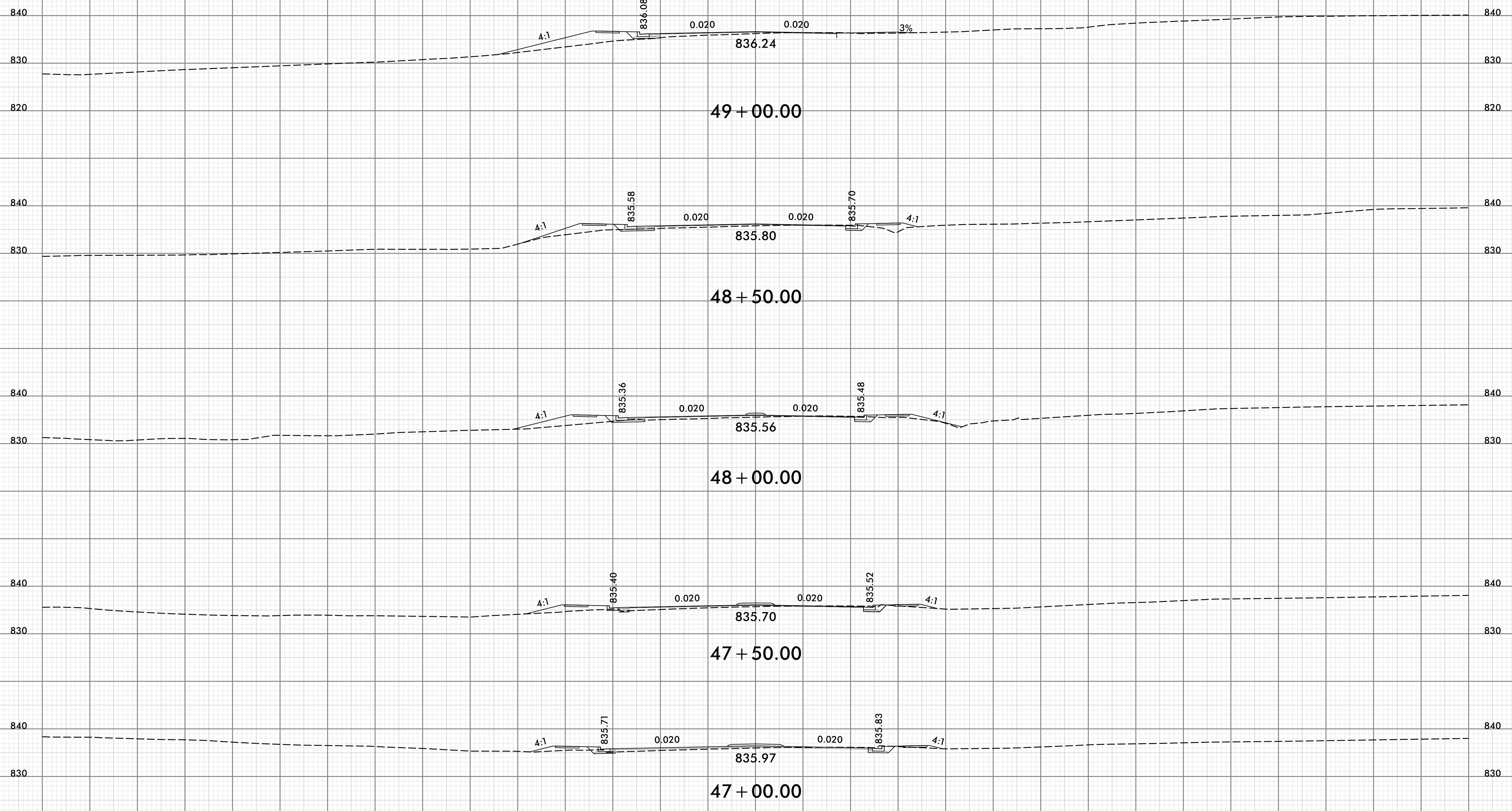

-Y-

150 140 130 120 110 100 90 80 70 60 50 40 30 20 10 0 10 20 30 40 50 60 70 80 90 100 110 120 130 140 150

25-APR-2024 17:57  
 \\Roadway\CorridorModeling\U5813\_RDY\_Y\_XPL.dgn  
 HNTB



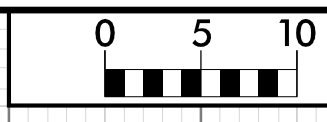

150 140 130 120 110 100 90 80 70 60 50 40 30 20 10 0 10 20 30 40 50 60 70 80 90 100 110 120 130 140 150

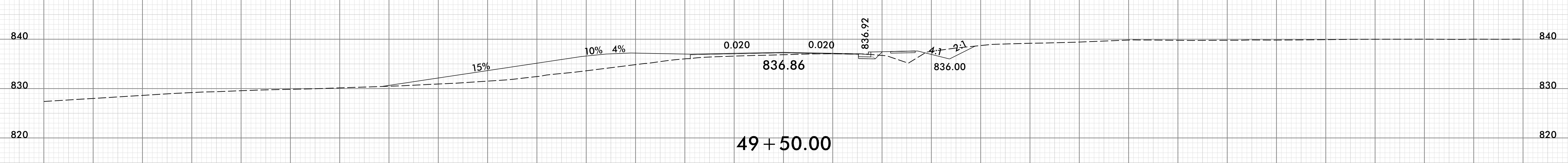
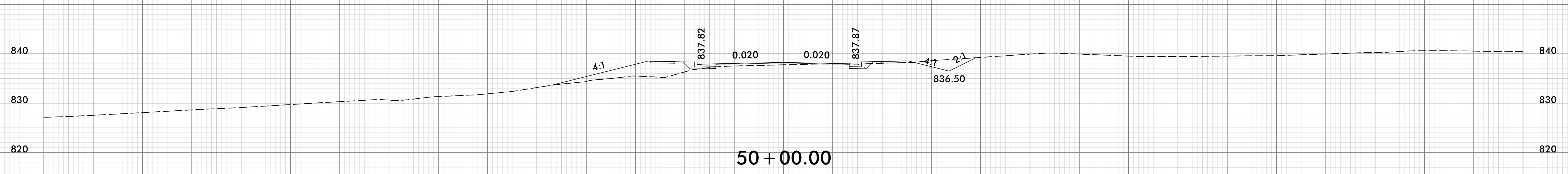
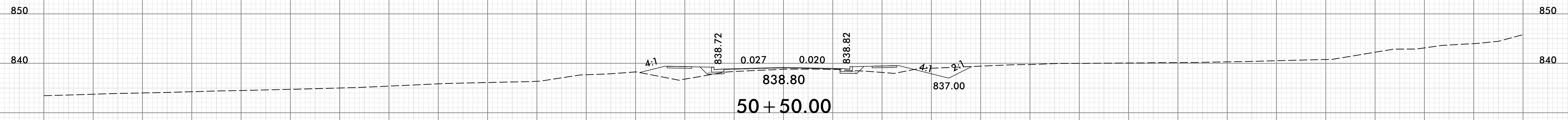
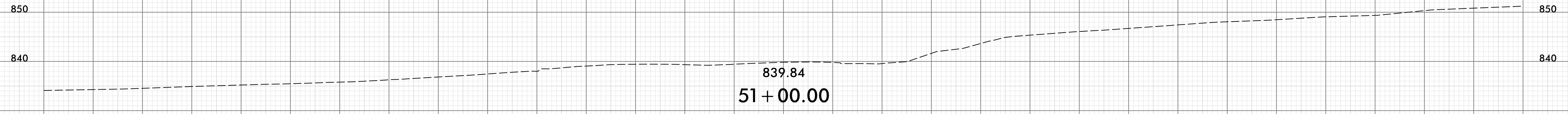
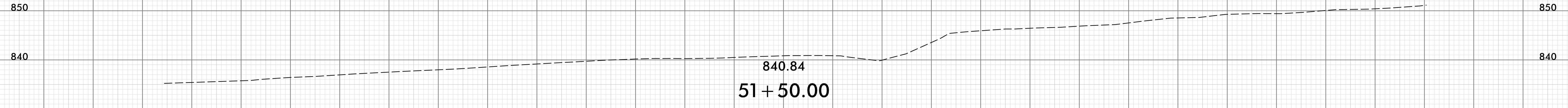

-Y-

150 140 130 120 110 100 90 80 70 60 50 40 30 20 10 0 10 20 30 40 50 60 70 80 90 100 110 120 130 140 150

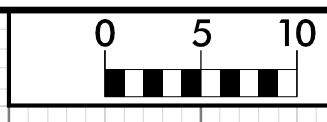

PROJ. REFERENCE NO.  
U-5813

SHEET NO.  
X-81

150 140 130 120 110 100 90 80 70 60 50 40 30 20 10 0 10 20 30 40 50 60 70 80 90 100 110 120 130 140 150

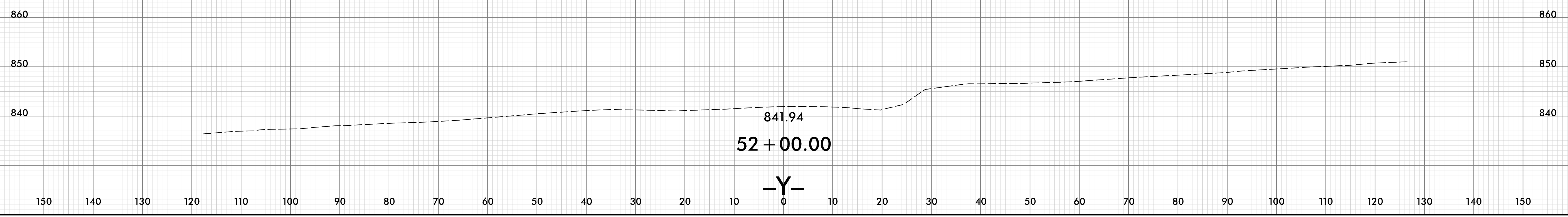

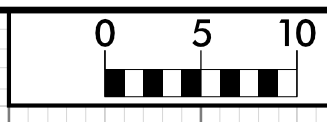

150 140 130 120 110 100 90 80 70 60 50 40 30 20 10 0 10 20 30 40 50 60 70 80 90 100 110 120 130 140 150

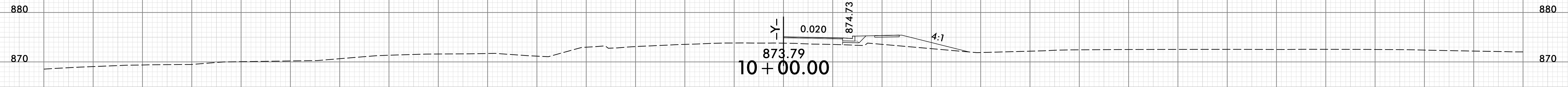
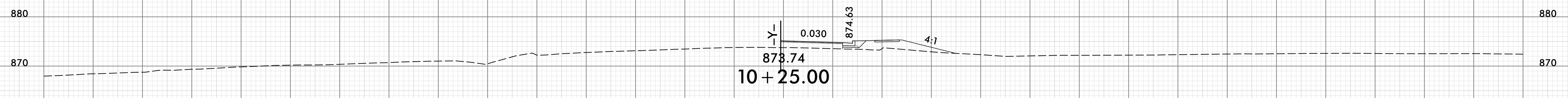
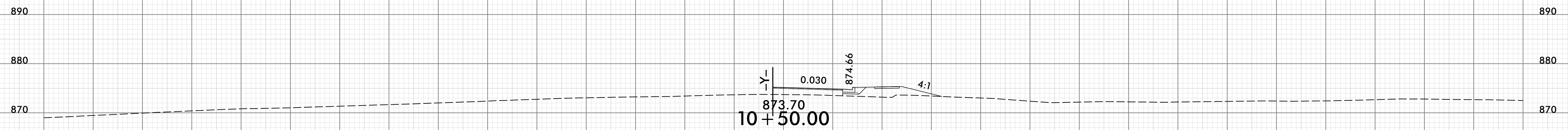
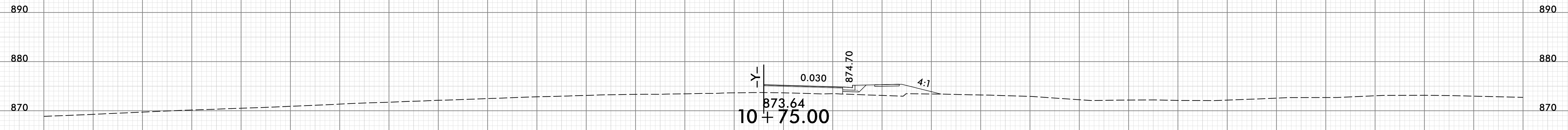
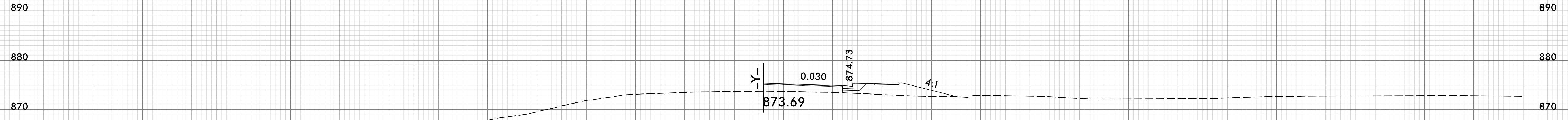

-Y-SLIP-

150 140 130 120 110 100 90 80 70 60 50 40 30 20 10 0 10 20 30 40 50 60 70 80 90 100 110 120 130 140 150

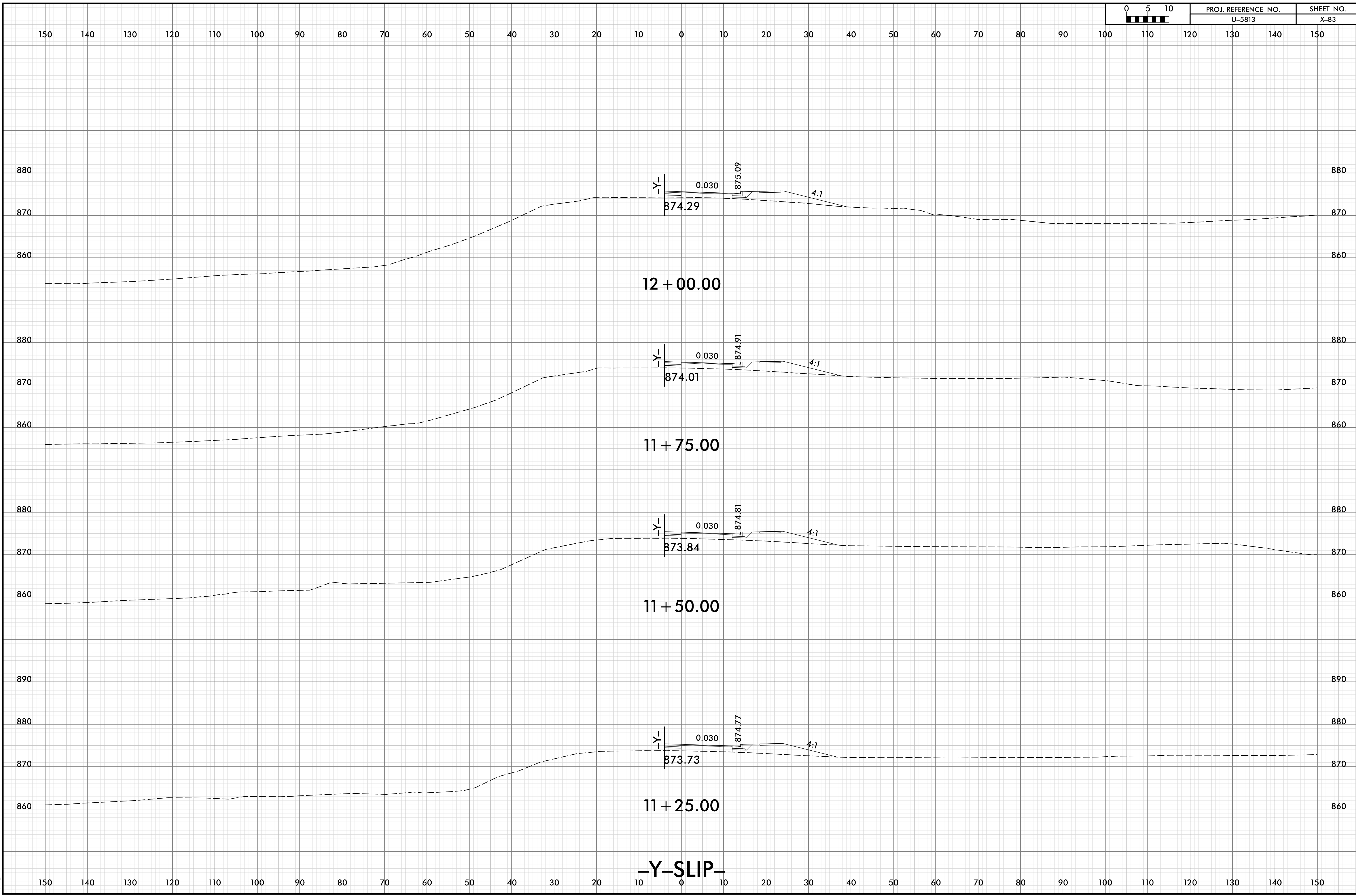

-Y-SLIP-

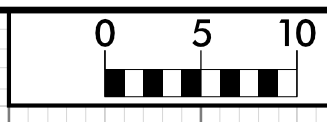

150 140 130 120 110 100 90 80 70 60 50 40 30 20 10 0 10 20 30 40 50 60 70 80 90 100 110 120 130 140 150

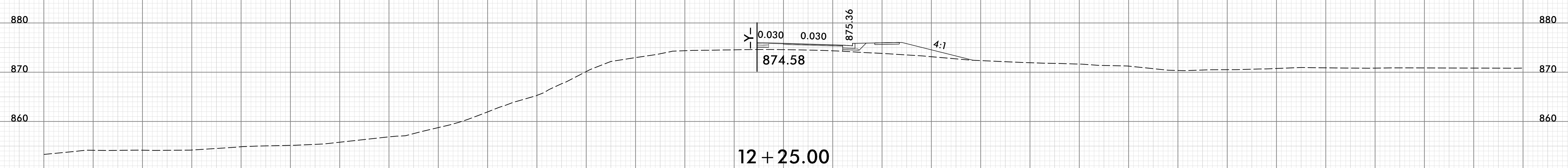
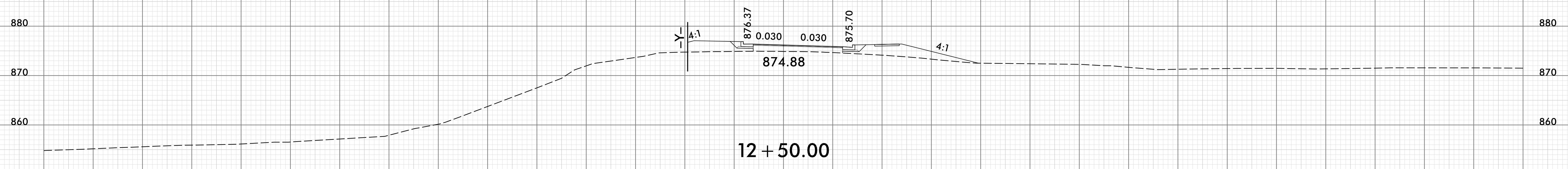
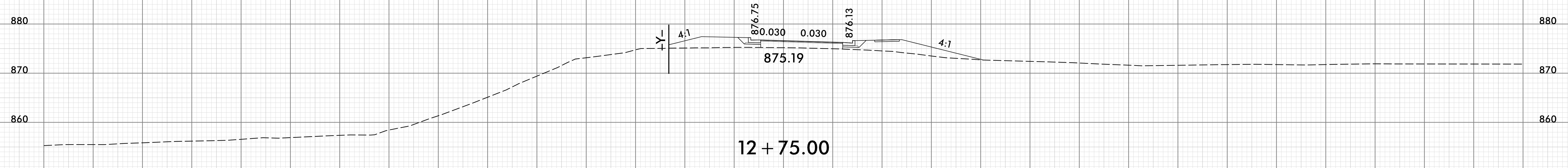
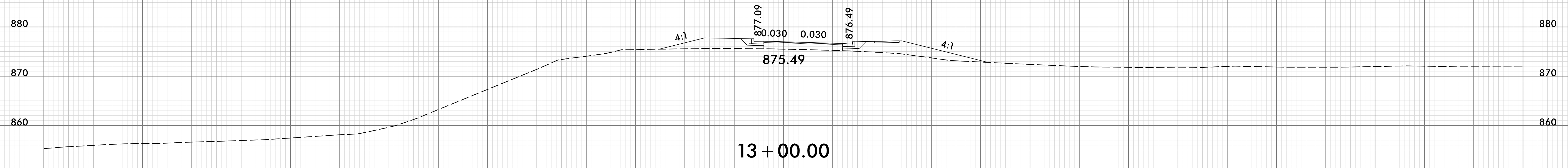

-Y-SLIP-

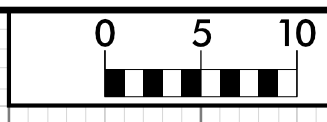

150 140 130 120 110 100 90 80 70 60 50 40 30 20 10 0 10 20 30 40 50 60 70 80 90 100 110 120 130 140 150

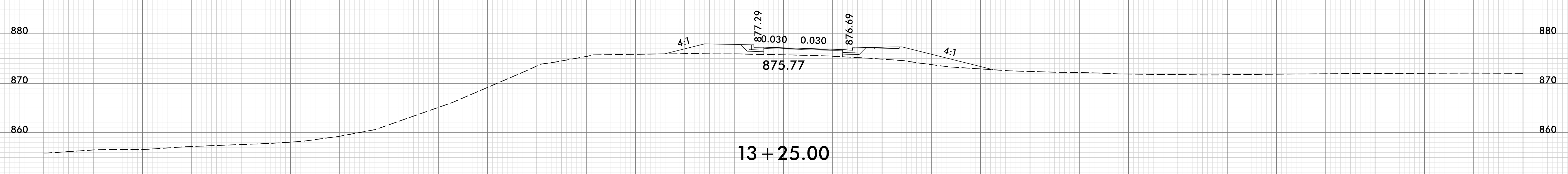
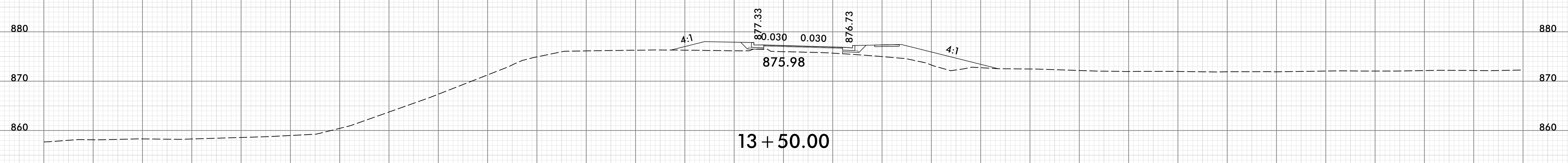
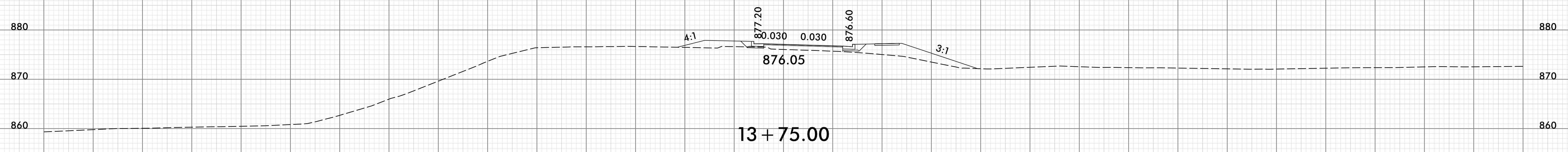
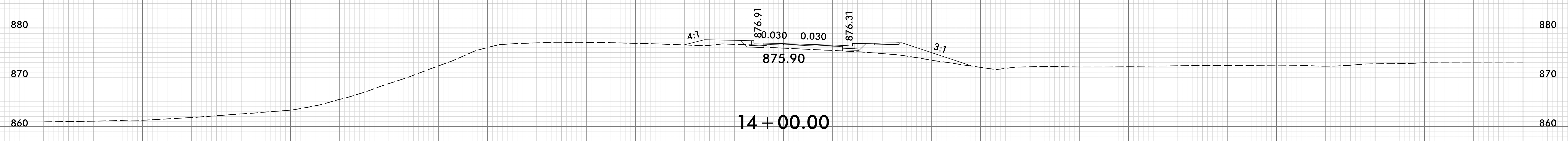

-Y-SLIP-

150 140 130 120 110 100 90 80 70 60 50 40 30 20 10 0 10 20 30 40 50 60 70 80 90 100 110 120 130 140 150

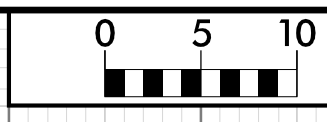

150 140 130 120 110 100 90 80 70 60 50 40 30 20 10 0 10 20 30 40 50 60 70 80 90 100 110 120 130 140 150

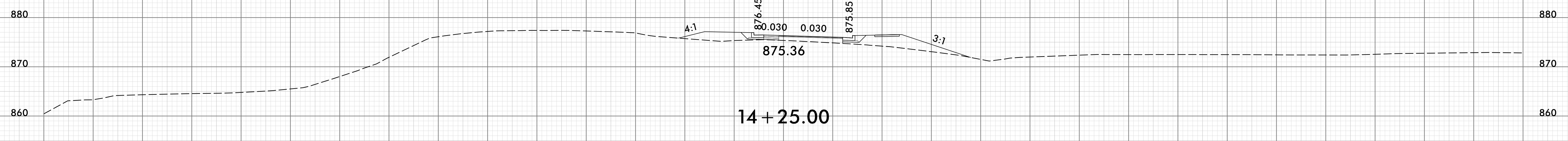
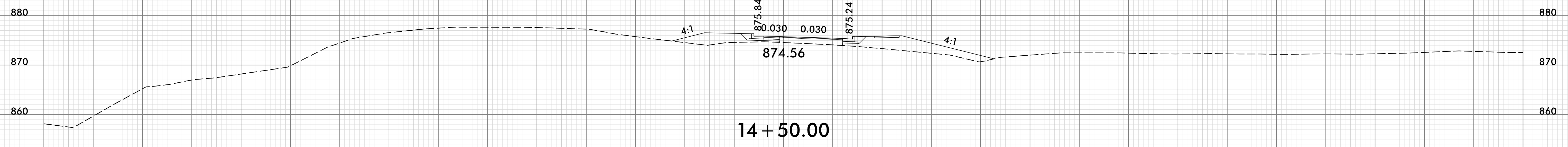
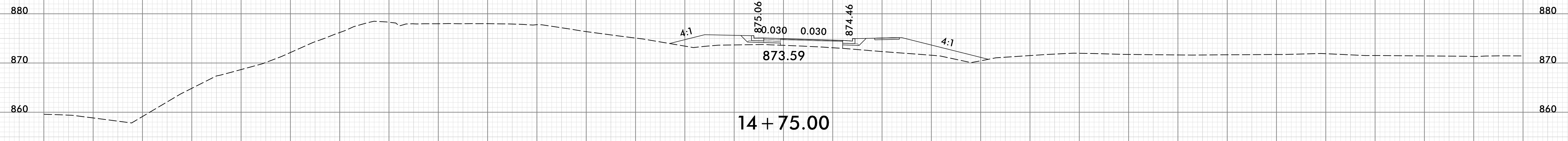
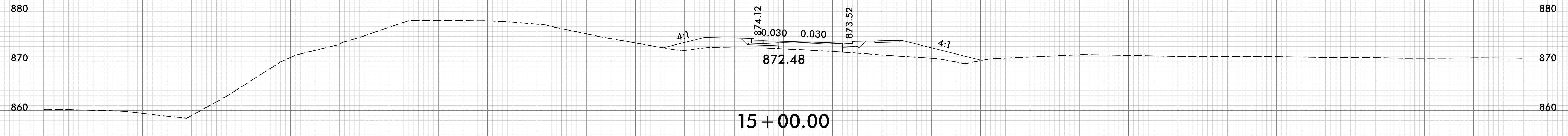

-Y-SLIP-

150 140 130 120 110 100 90 80 70 60 50 40 30 20 10 0 10 20 30 40 50 60 70 80 90 100 110 120 130 140 150

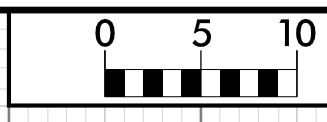

150 140 130 120 110 100 90 80 70 60 50 40 30 20 10 0 10 20 30 40 50 60 70 80 90 100 110 120 130 140 150

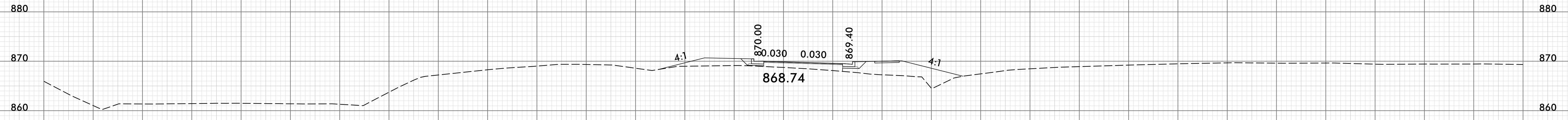

16 + 00.00

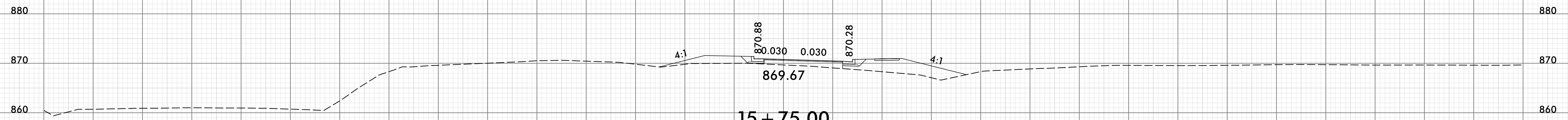

15 + 75.00

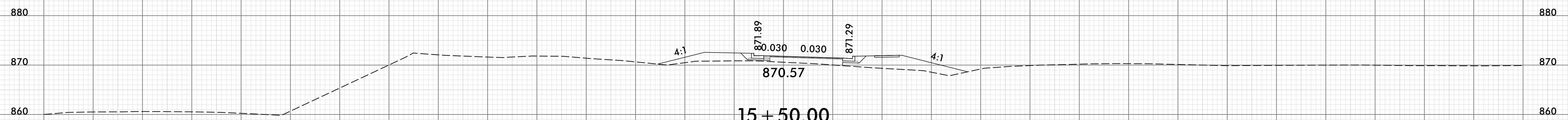

15 + 50.00

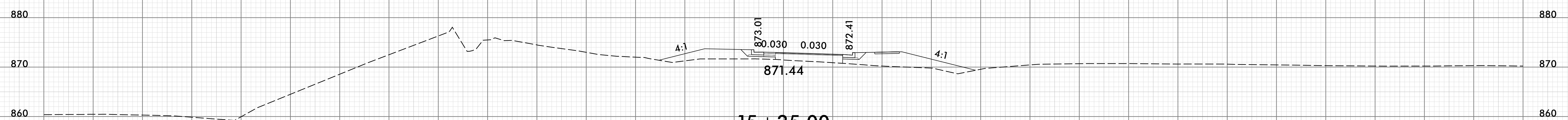

15 + 25.00

-Y-SLIP-

150 140 130 120 110 100 90 80 70 60 50 40 30 20 10 0 10 20 30 40 50 60 70 80 90 100 110 120 130 140 150



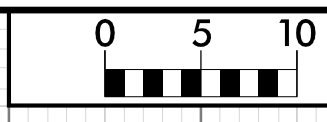

150 140 130 120 110 100 90 80 70 60 50 40 30 20 10 0 10 20 30 40 50 60 70 80 90 100 110 120 130 140 150

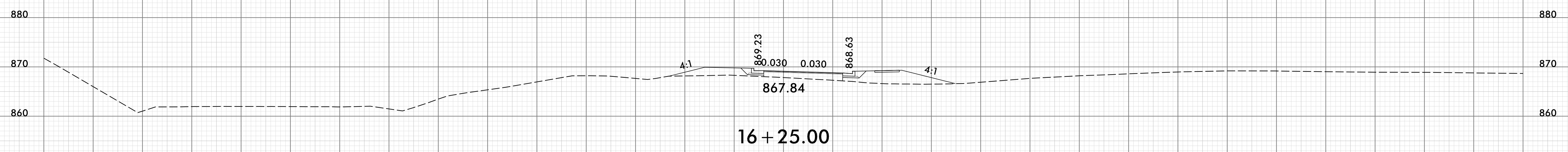
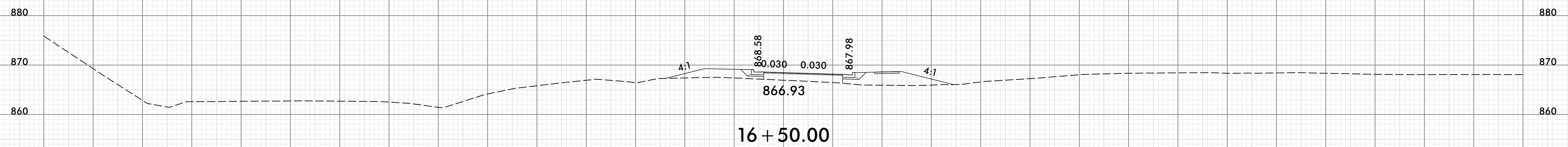
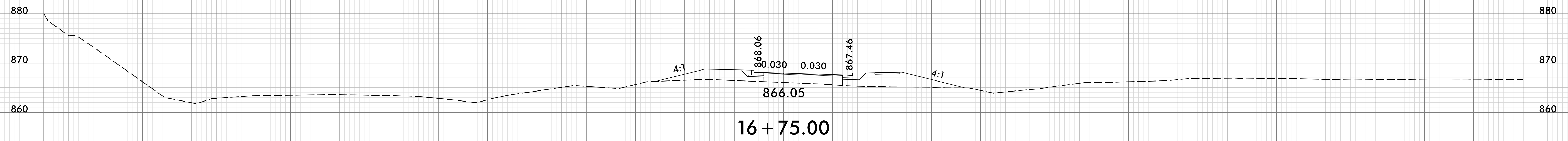
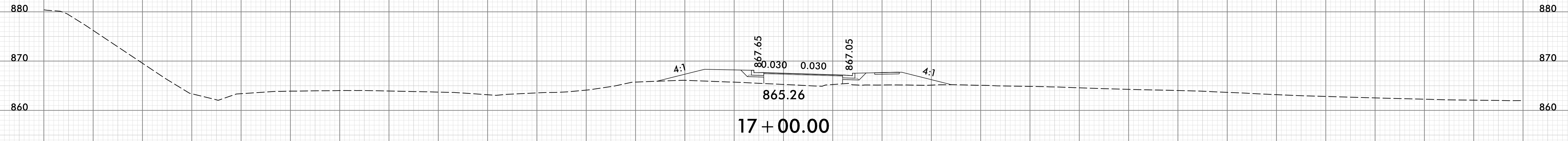

-Y-SLIP-

150 140 130 120 110 100 90 80 70 60 50 40 30 20 10 0 10 20 30 40 50 60 70 80 90 100 110 120 130 140 150

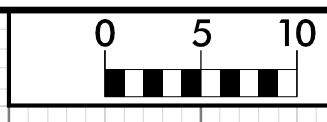

150 140 130 120 110 100 90 80 70 60 50 40 30 20 10 0 10 20 30 40 50 60 70 80 90 100 110 120 130 140 150

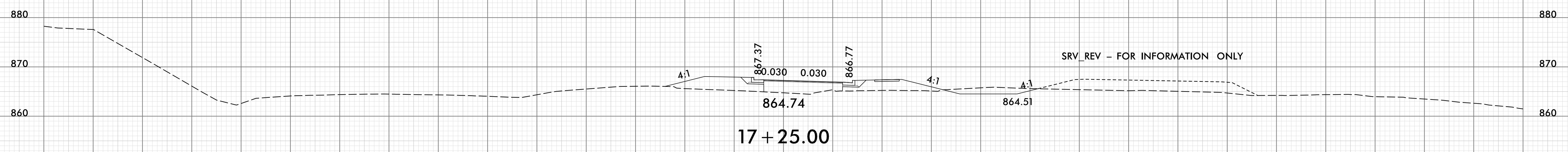
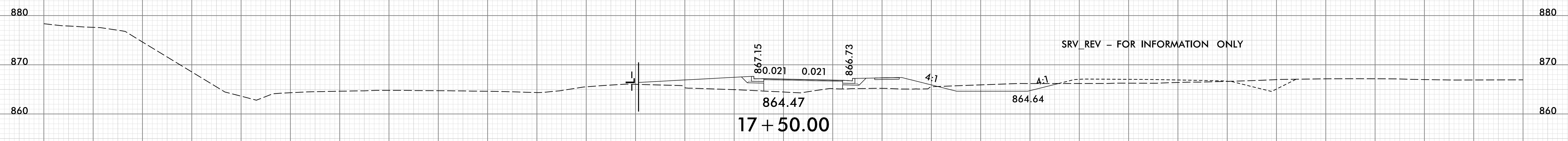
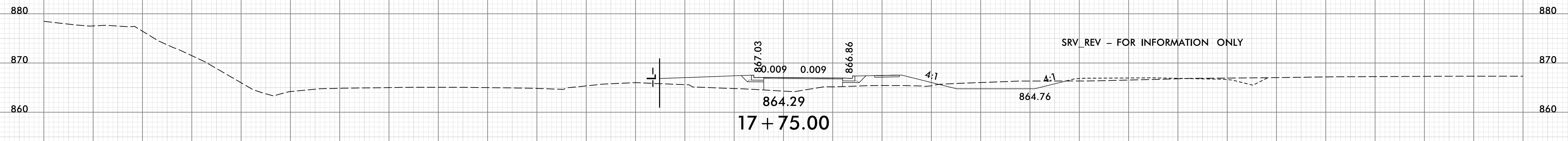
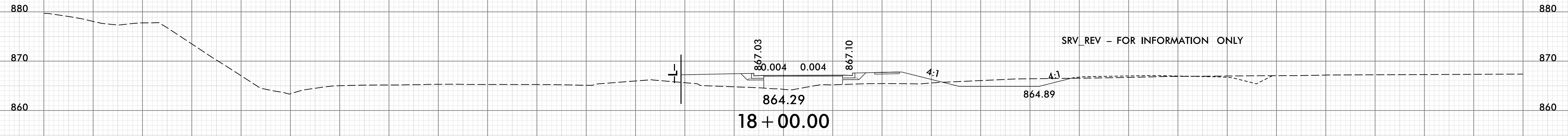

-Y-SLIP-

150 140 130 120 110 100 90 80 70 60 50 40 30 20 10 0 10 20 30 40 50 60 70 80 90 100 110 120 130 140 150

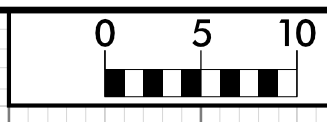

150 140 130 120 110 100 90 80 70 60 50 40 30 20 10 0 10 20 30 40 50 60 70 80 90 100 110 120 130 140 150

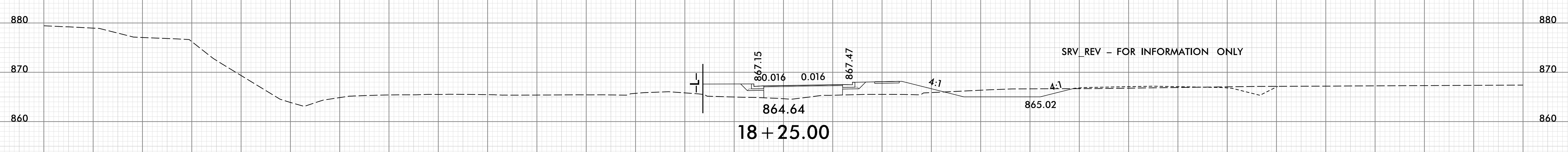
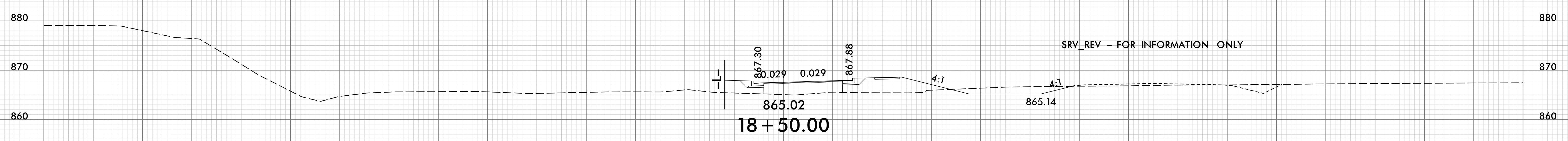
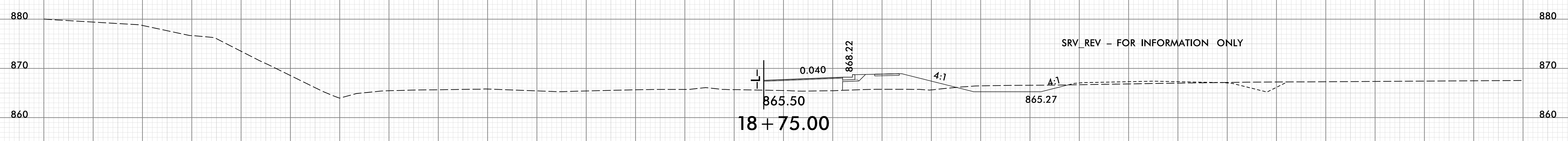
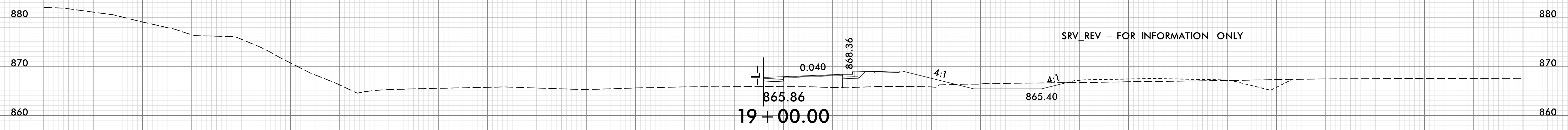

-Y-SLIP-

150 140 130 120 110 100 90 80 70 60 50 40 30 20 10 0 10 20 30 40 50 60 70 80 90 100 110 120 130 140 150

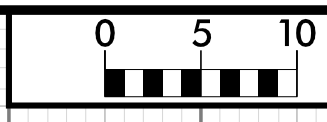

150 140 130 120 110 100 90 80 70 60 50 40 30 20 10 0 10 20 30 40 50 60 70 80 90 100 110 120 130 140 150

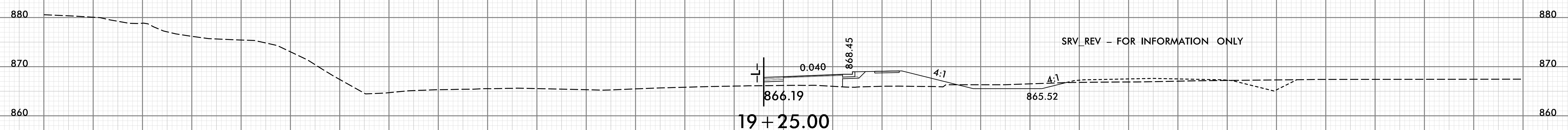
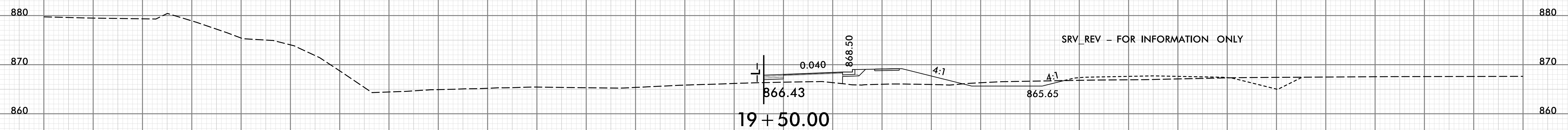
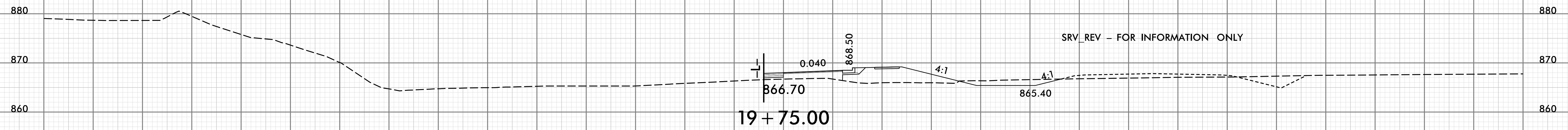
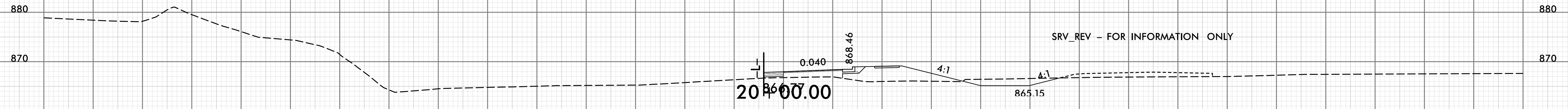
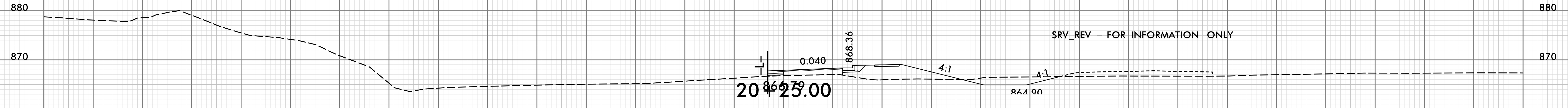

-Y-SLIP-

150 140 130 120 110 100 90 80 70 60 50 40 30 20 10 0 10 20 30 40 50 60 70 80 90 100 110 120 130 140 150

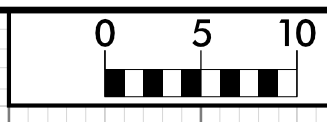

150 140 130 120 110 100 90 80 70 60 50 40 30 20 10 0 10 20 30 40 50 60 70 80 90 100 110 120 130 140 150

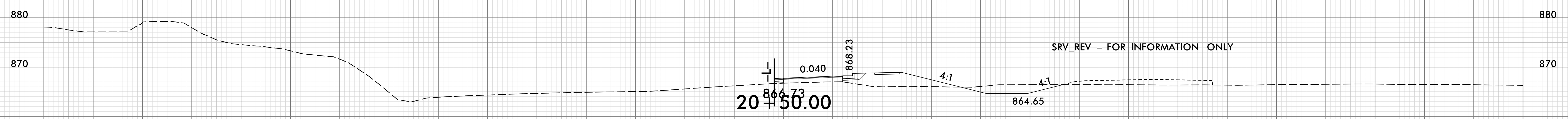
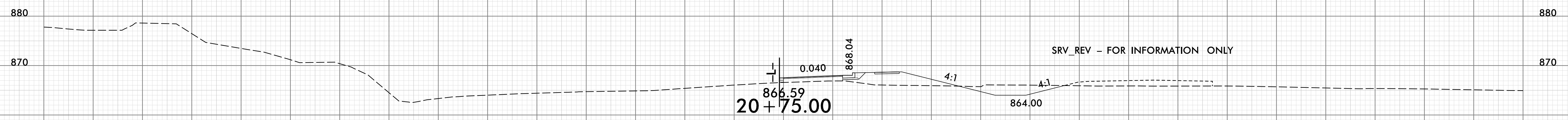
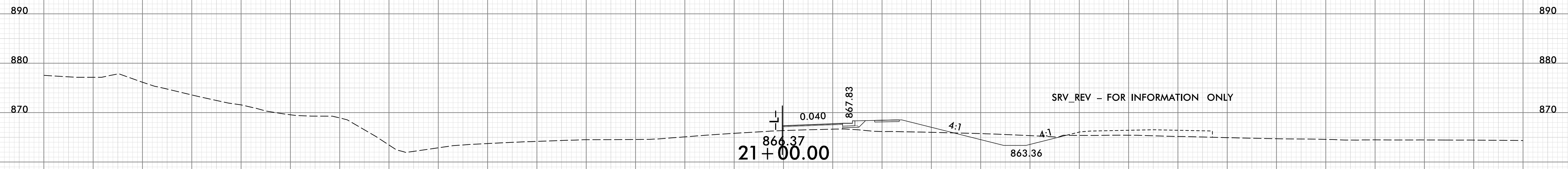
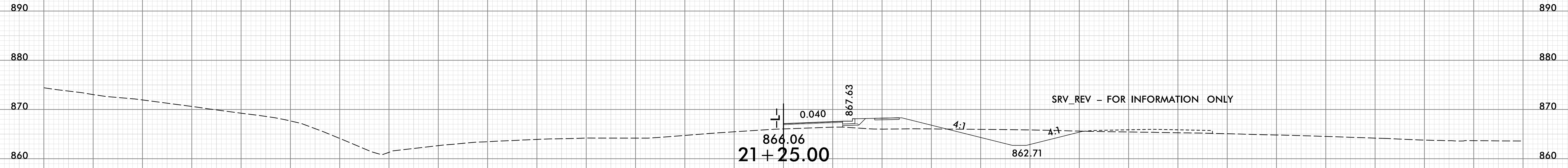

-Y-SLIP-

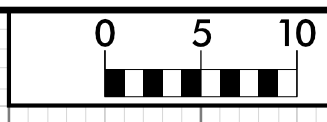

150 140 130 120 110 100 90 80 70 60 50 40 30 20 10 0 10 20 30 40 50 60 70 80 90 100 110 120 130 140 150

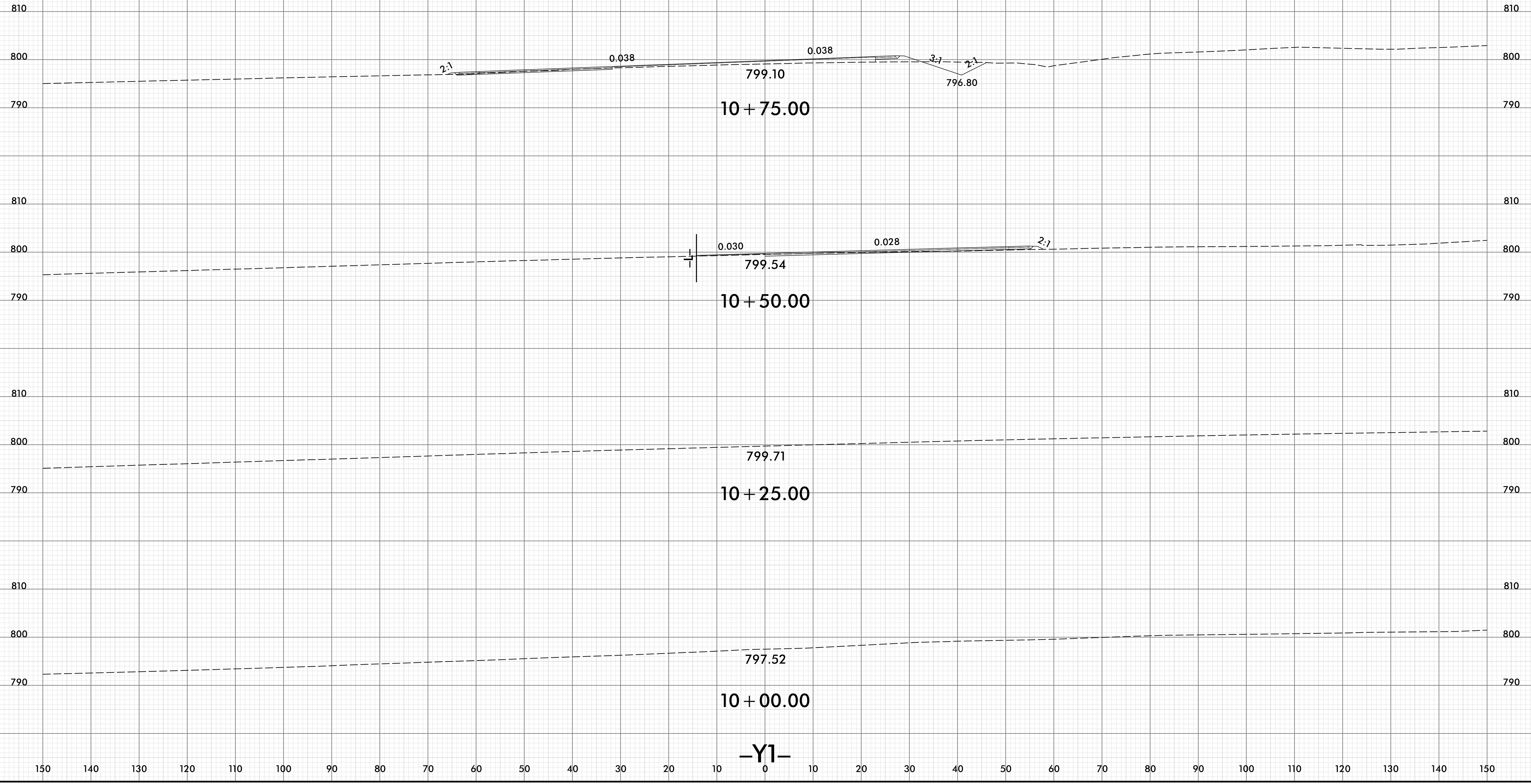

150 140 130 120 110 100 90 80 70 60 50 40 30 20 10 0 10 20 30 40 50 60 70 80 90 100 110 120 130 140 150

-Y1-

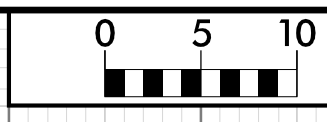

150 140 130 120 110 100 90 80 70 60 50 40 30 20 10 0 10 20 30 40 50 60 70 80 90 100 110 120 130 140 150

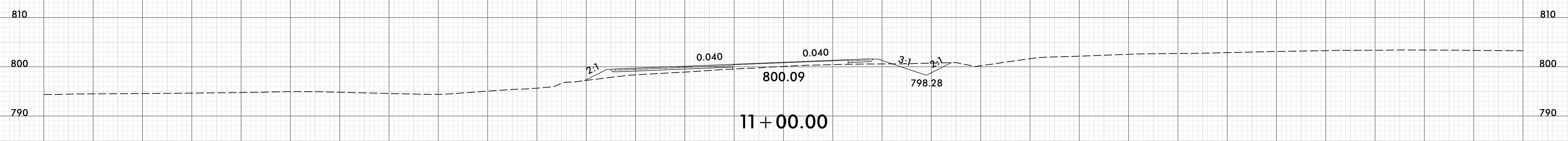
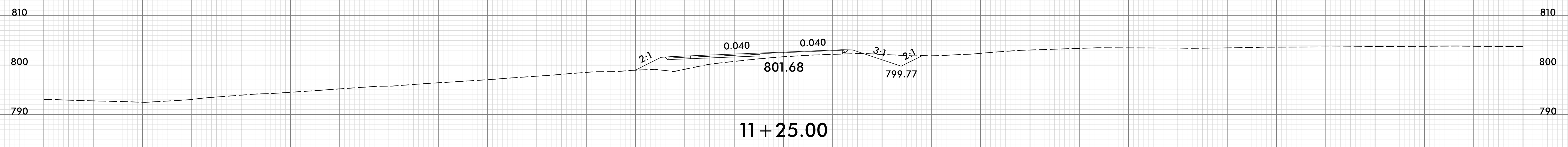
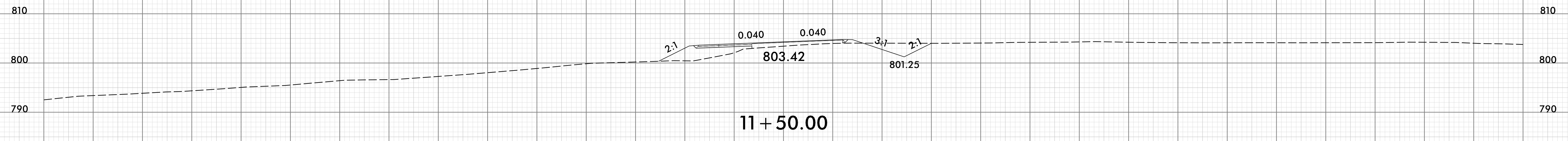
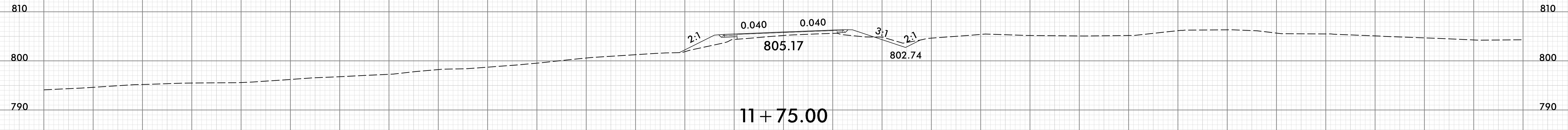

-Y1-

150 140 130 120 110 100 90 80 70 60 50 40 30 20 10 0 10 20 30 40 50 60 70 80 90 100 110 120 130 140 150

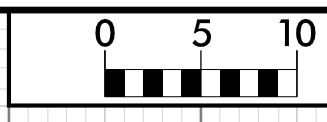

150 140 130 120 110 100 90 80 70 60 50 40 30 20 10 0 10 20 30 40 50 60 70 80 90 100 110 120 130 140 150

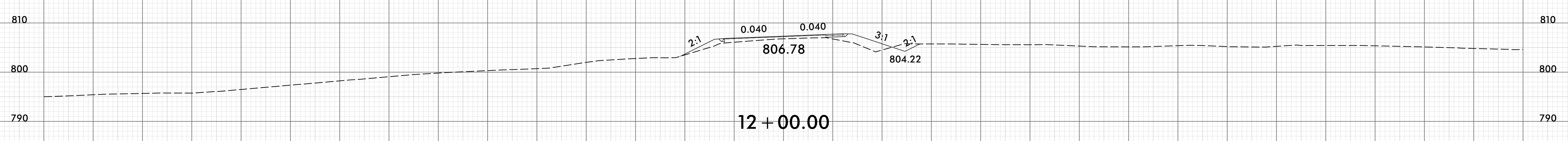
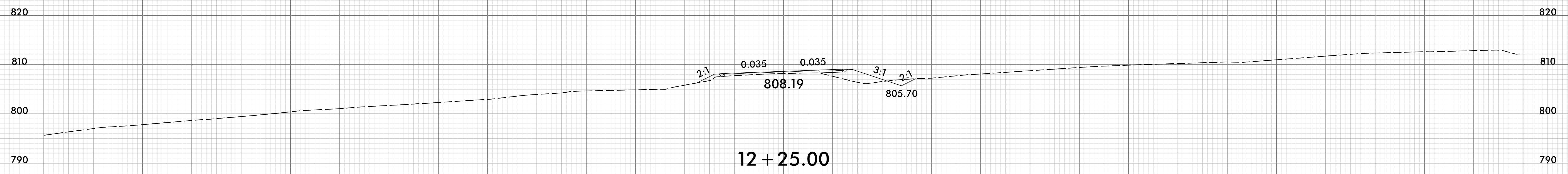
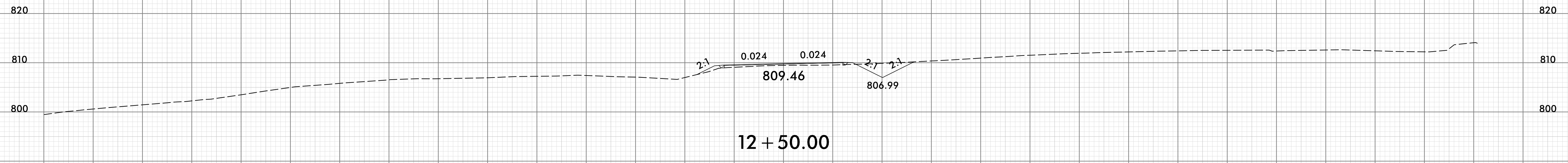
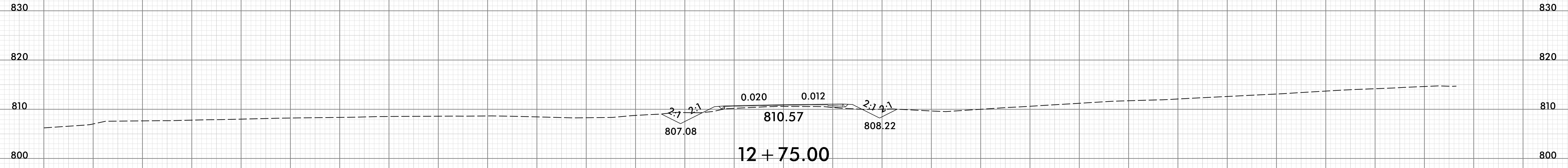

-Y1-

150 140 130 120 110 100 90 80 70 60 50 40 30 20 10 0 10 20 30 40 50 60 70 80 90 100 110 120 130 140 150



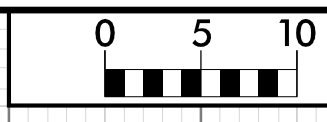

150 140 130 120 110 100 90 80 70 60 50 40 30 20 10 0 10 20 30 40 50 60 70 80 90 100 110 120 130 140 150

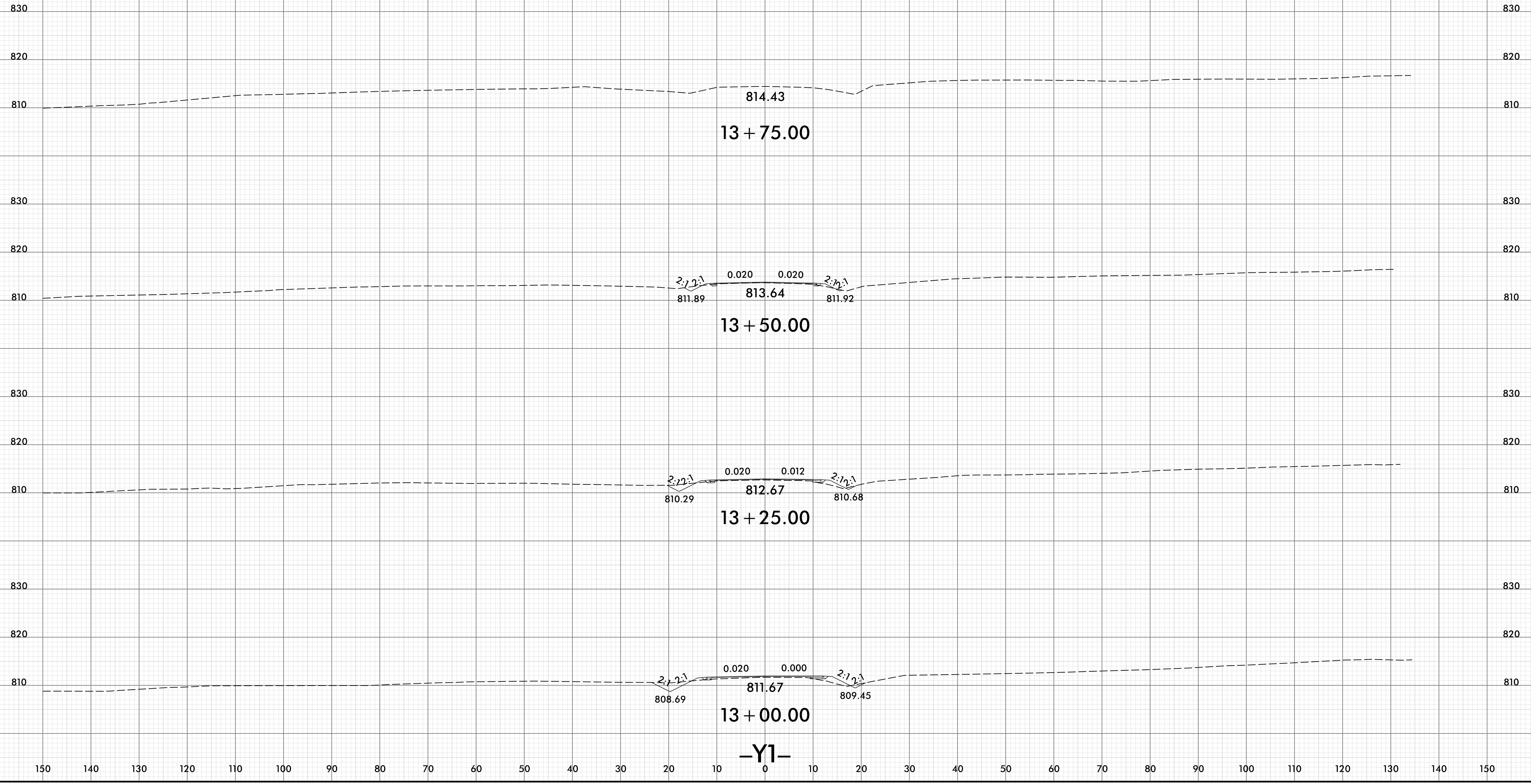

150 140 130 120 110 100 90 80 70 60 50 40 30 20 10 0 10 20 30 40 50 60 70 80 90 100 110 120 130 140 150

-Y1-

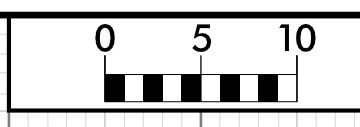

150 140 130 120 110 100 90 80 70 60 50 40 30 20 10 0 10 20 30 40 50 60 70 80 90 100 110 120 130 140 150

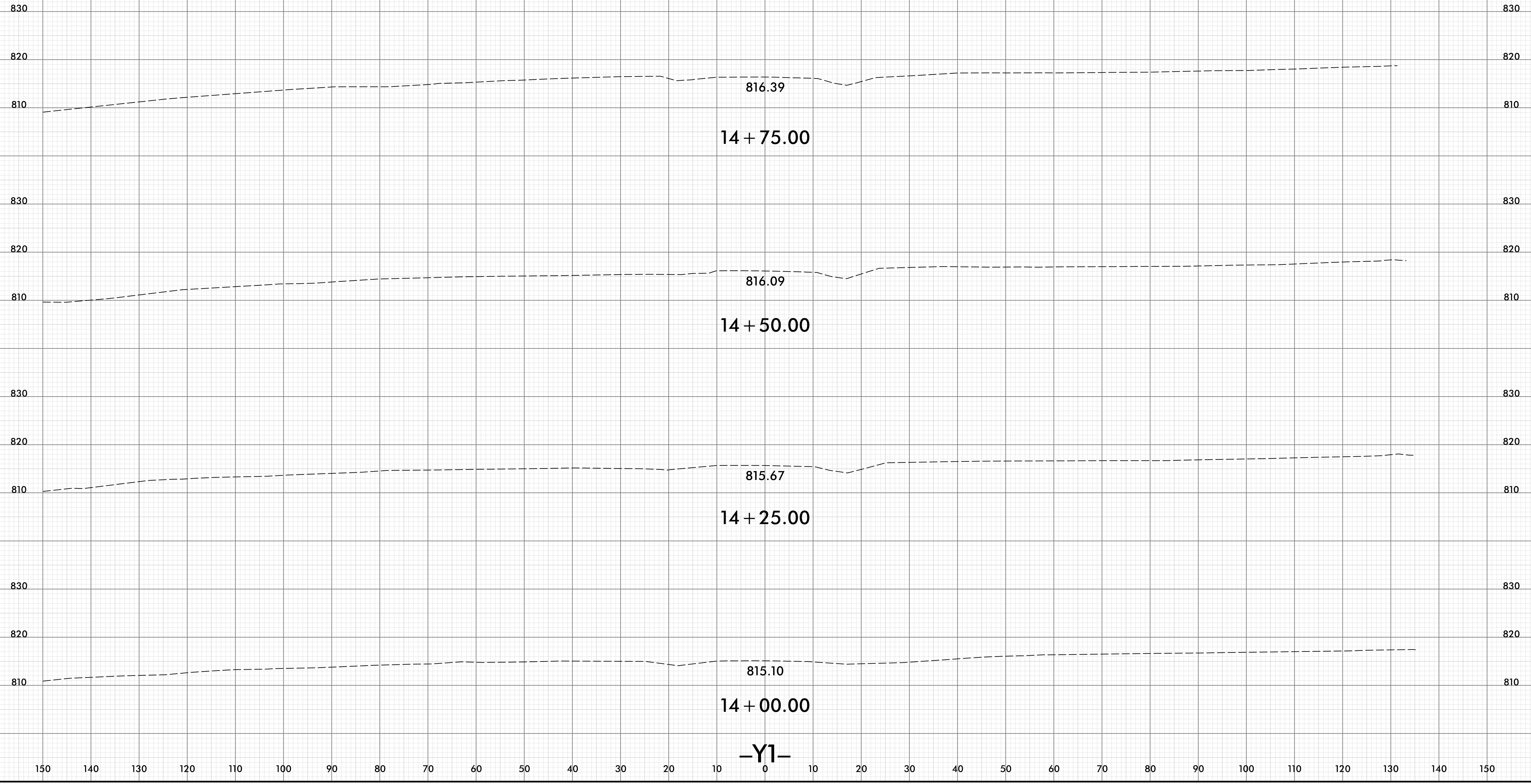

-Y1-

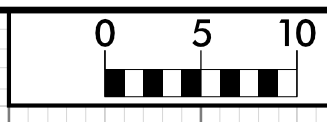

150 140 130 120 110 100 90 80 70 60 50 40 30 20 10 0 10 20 30 40 50 60 70 80 90 100 110 120 130 140 150

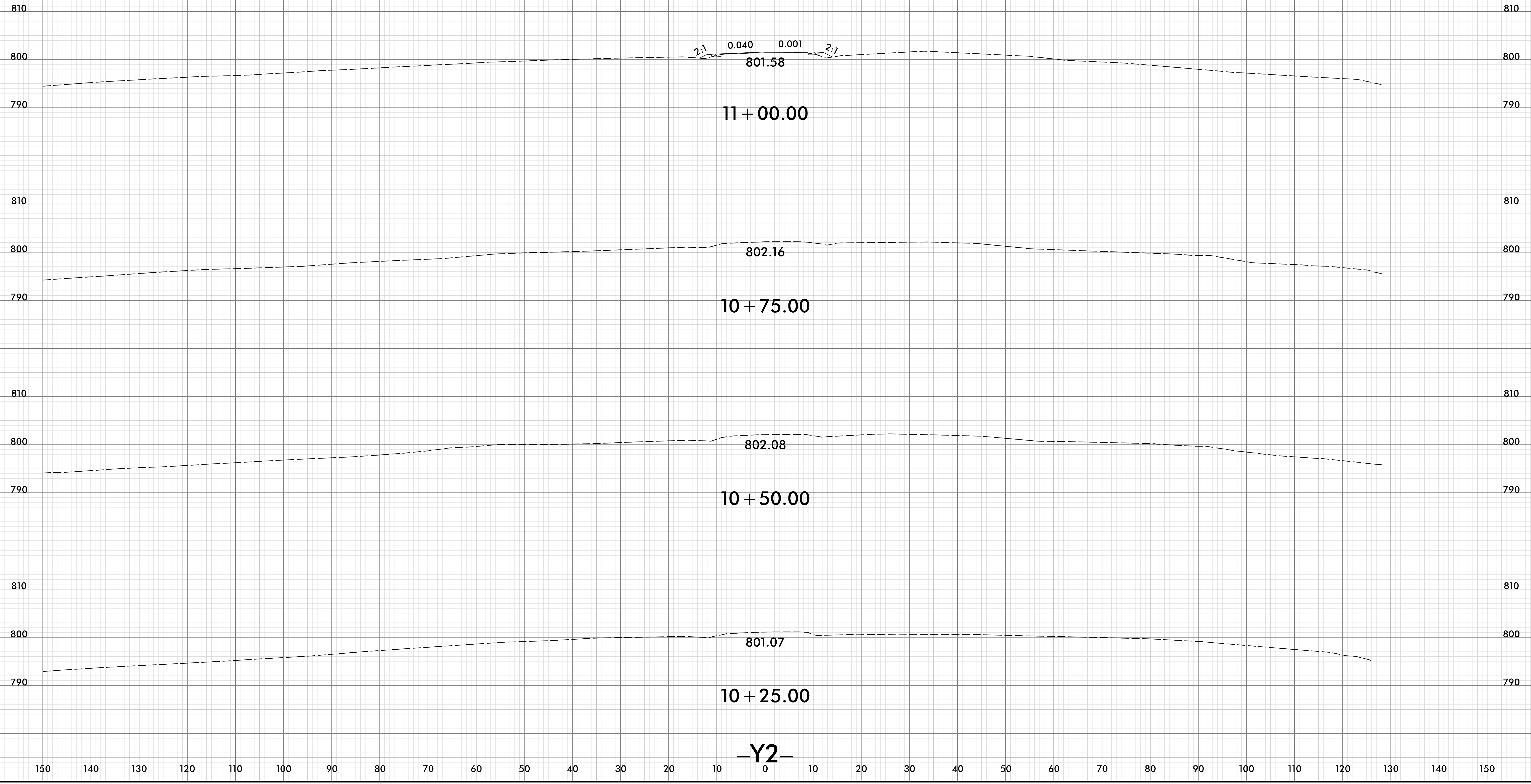

150 140 130 120 110 100 90 80 70 60 50 40 30 20 10 0 10 20 30 40 50 60 70 80 90 100 110 120 130 140 150

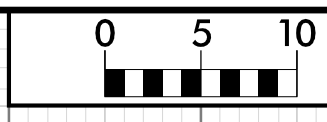

150 140 130 120 110 100 90 80 70 60 50 40 30 20 10 0 10 20 30 40 50 60 70 80 90 100 110 120 130 140 150

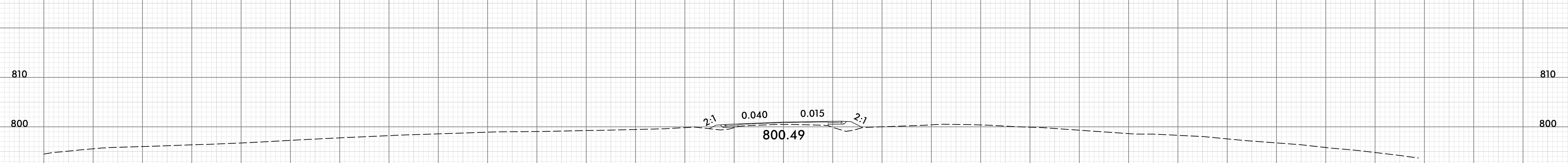
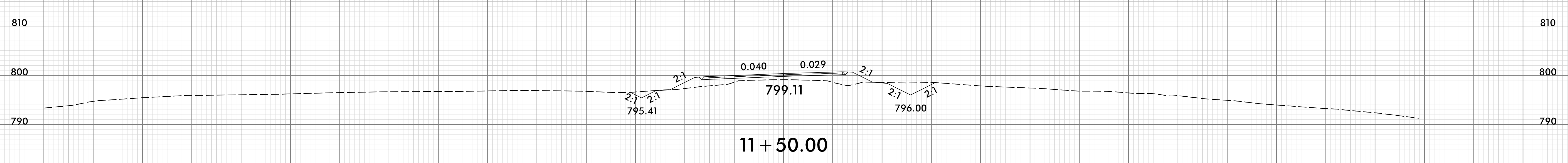
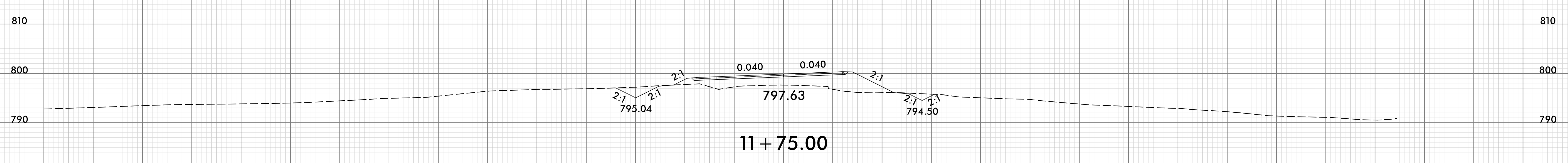
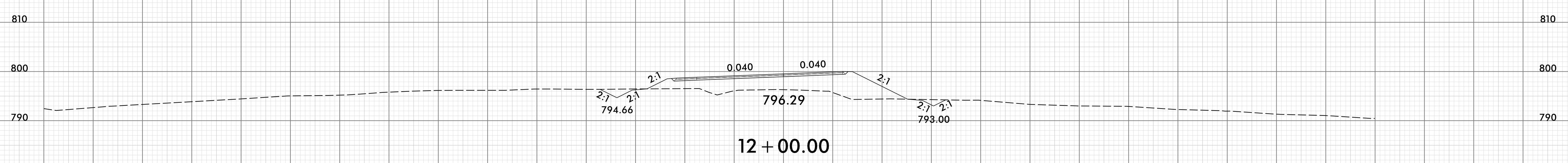

150 140 130 120 110 100 90 80 70 60 50 40 30 20 10 0 10 20 30 40 50 60 70 80 90 100 110 120 130 140 150

-Y2-

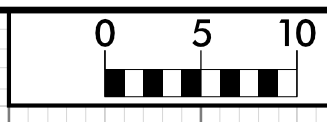

150 140 130 120 110 100 90 80 70 60 50 40 30 20 10 0 10 20 30 40 50 60 70 80 90 100 110 120 130 140 150

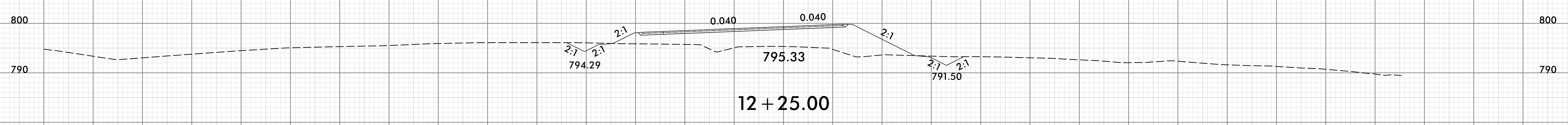
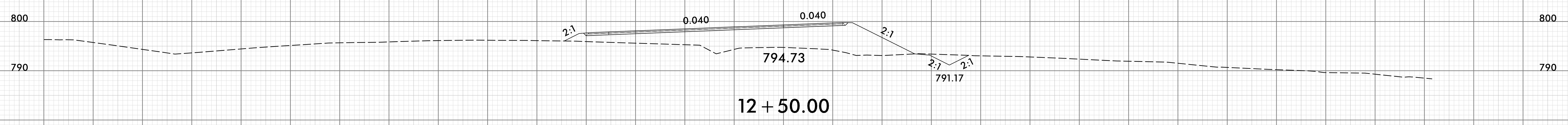
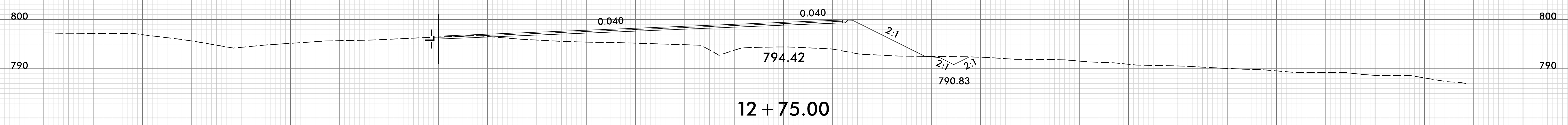
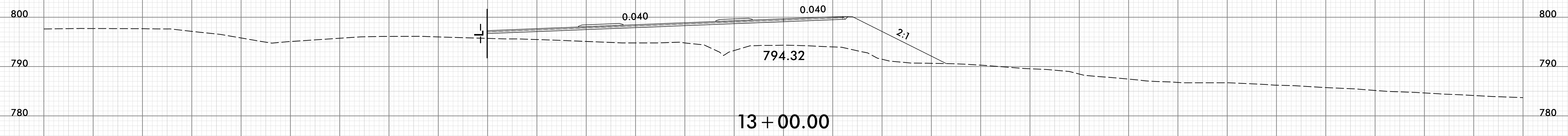

-Y2-

150 140 130 120 110 100 90 80 70 60 50 40 30 20 10 0 10 20 30 40 50 60 70 80 90 100 110 120 130 140 150

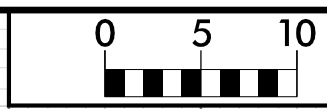

150 140 130 120 110 100 90 80 70 60 50 40 30 20 10 0 10 20 30 40 50 60 70 80 90 100 110 120 130 140 150

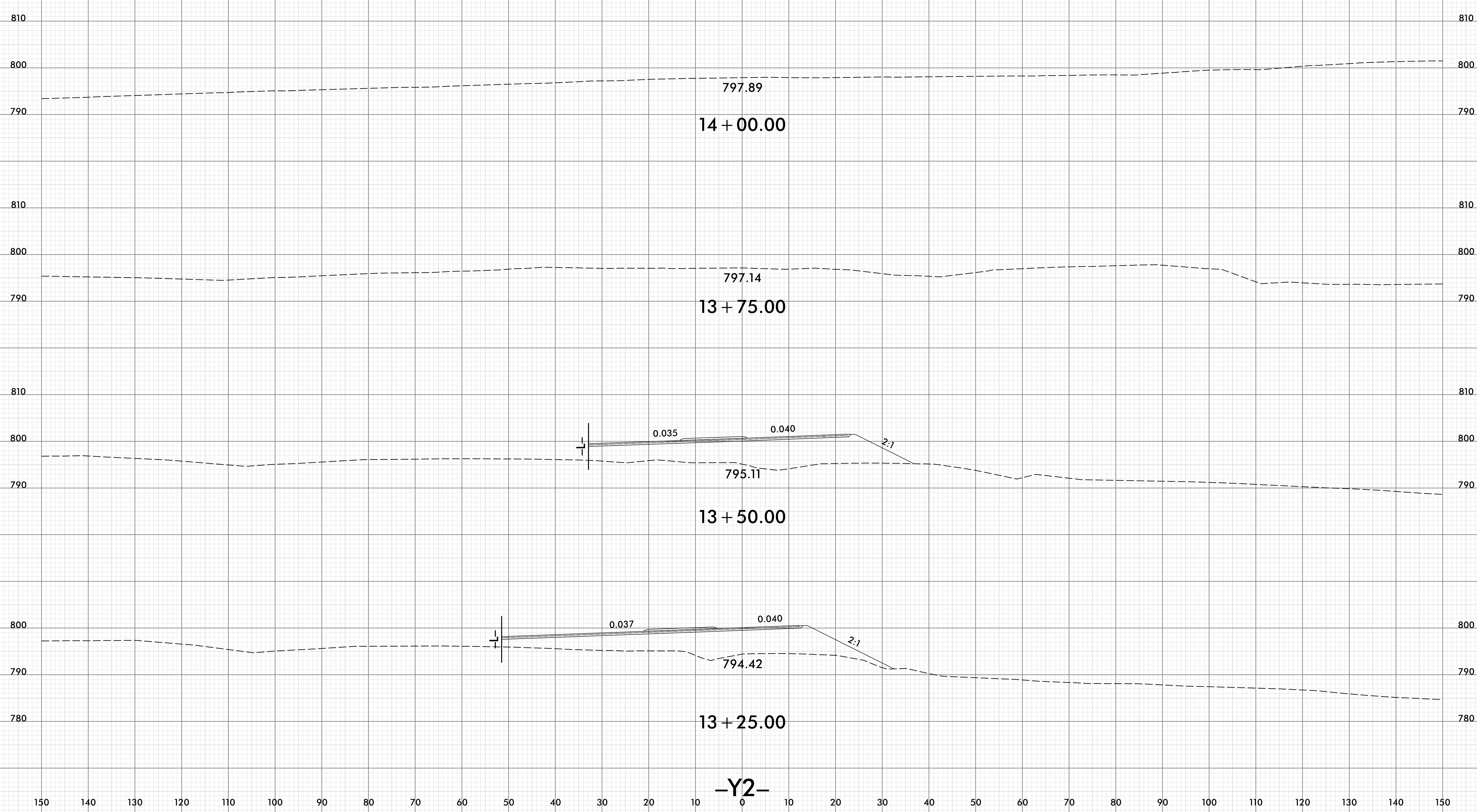

150 140 130 120 110 100 90 80 70 60 50 40 30 20 10 0 10 20 30 40 50 60 70 80 90 100 110 120 130 140 150

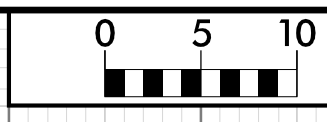

150 140 130 120 110 100 90 80 70 60 50 40 30 20 10 0 10 20 30 40 50 60 70 80 90 100 110 120 130 140 150

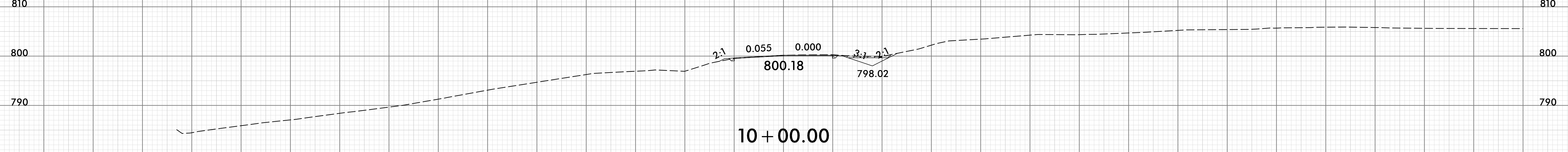
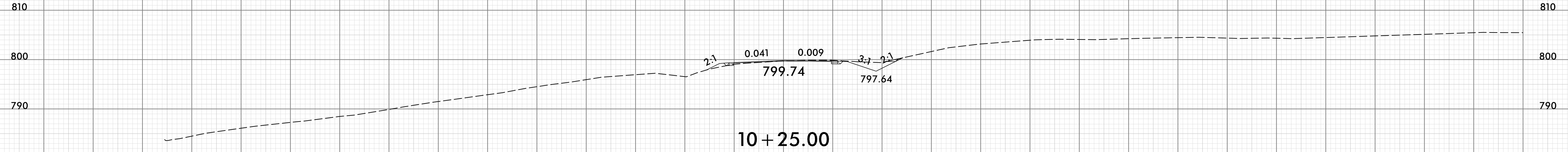
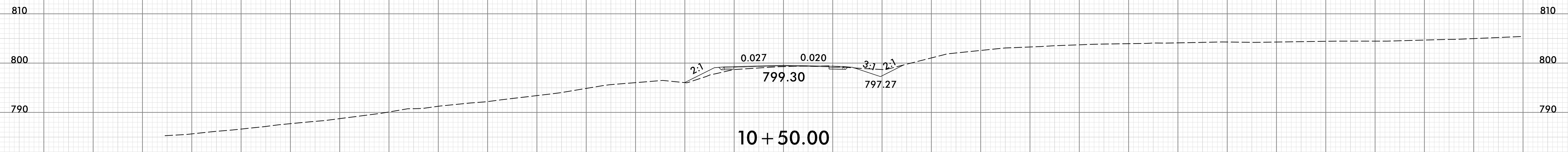
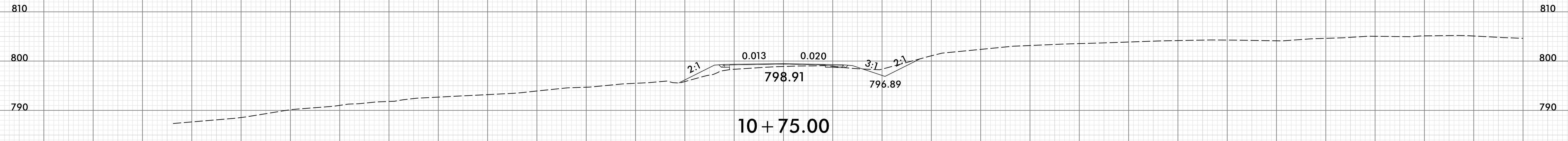

150 140 130 120 110 100 90 80 70 60 50 40 30 20 10 0 10 20 30 40 50 60 70 80 90 100 110 120 130 140 150

-Y3-

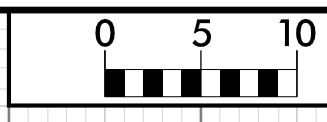

150 140 130 120 110 100 90 80 70 60 50 40 30 20 10 0 10 20 30 40 50 60 70 80 90 100 110 120 130 140 150

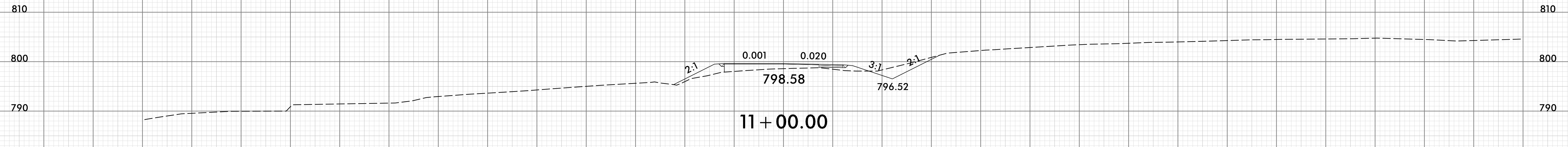
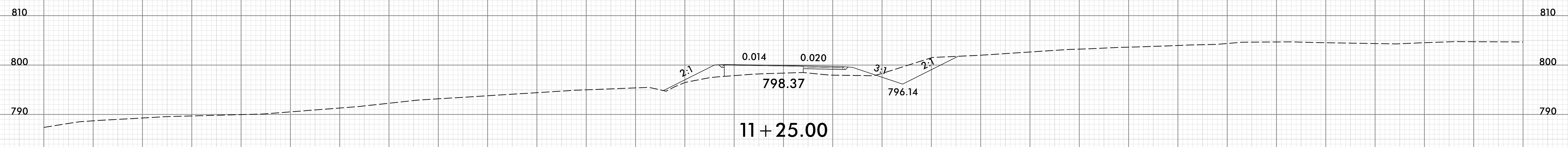
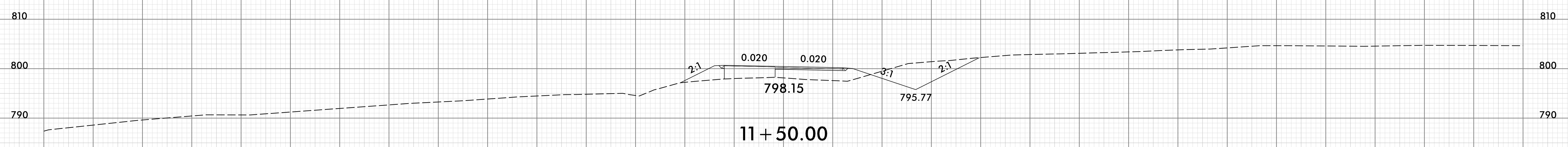
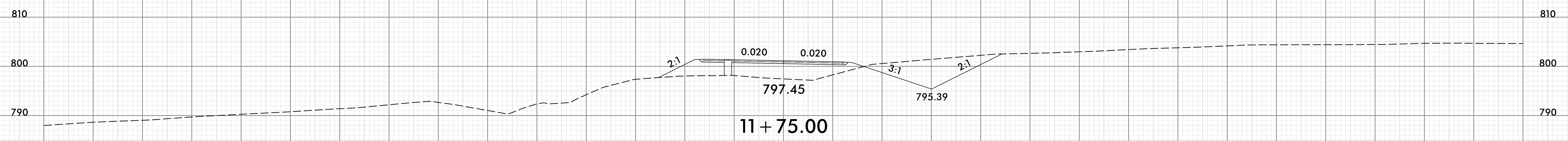

-Y3-

150 140 130 120 110 100 90 80 70 60 50 40 30 20 10 0 10 20 30 40 50 60 70 80 90 100 110 120 130 140 150



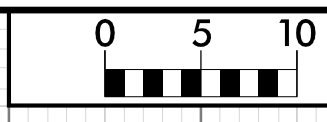

150 140 130 120 110 100 90 80 70 60 50 40 30 20 10 0 10 20 30 40 50 60 70 80 90 100 110 120 130 140 150

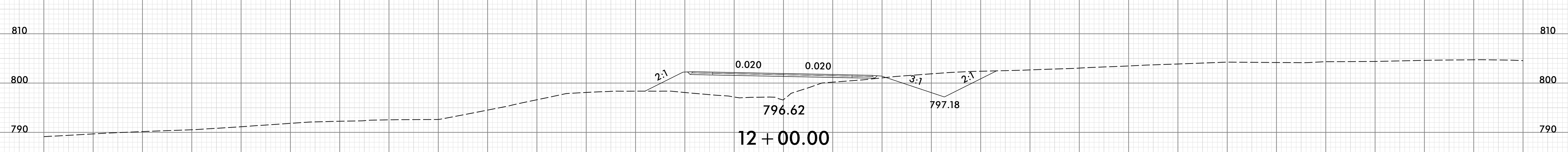
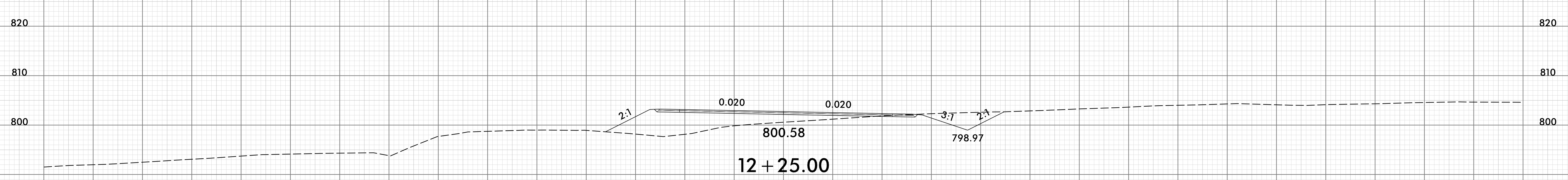
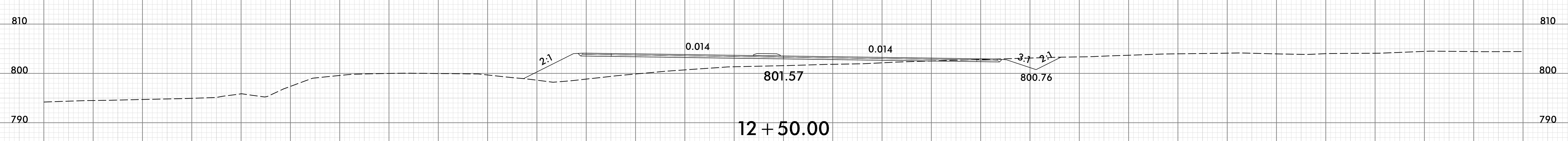
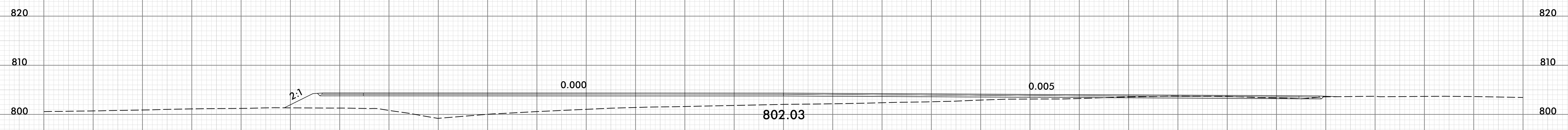

-Y3-

150 140 130 120 110 100 90 80 70 60 50 40 30 20 10 0 10 20 30 40 50 60 70 80 90 100 110 120 130 140 150

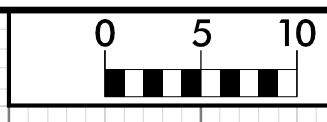

PROJ. REFERENCE NO.  
U-5813

SHEET NO.  
X-105

150 140 130 120 110 100 90 80 70 60 50 40 30 20 10 0 10 20 30 40 50 60 70 80 90 100 110 120 130 140 150

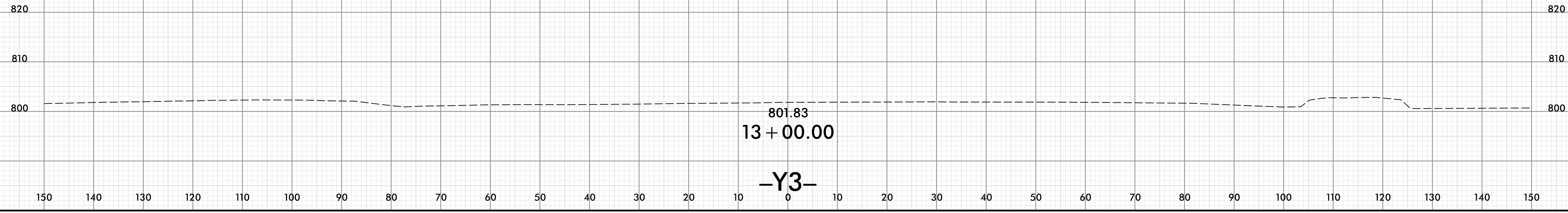

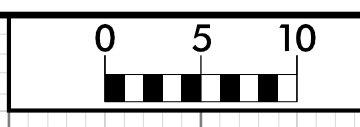

150 140 130 120 110 100 90 80 70 60 50 40 30 20 10 0 10 20 30 40 50 60 70 80 90 100 110 120 130 140 150

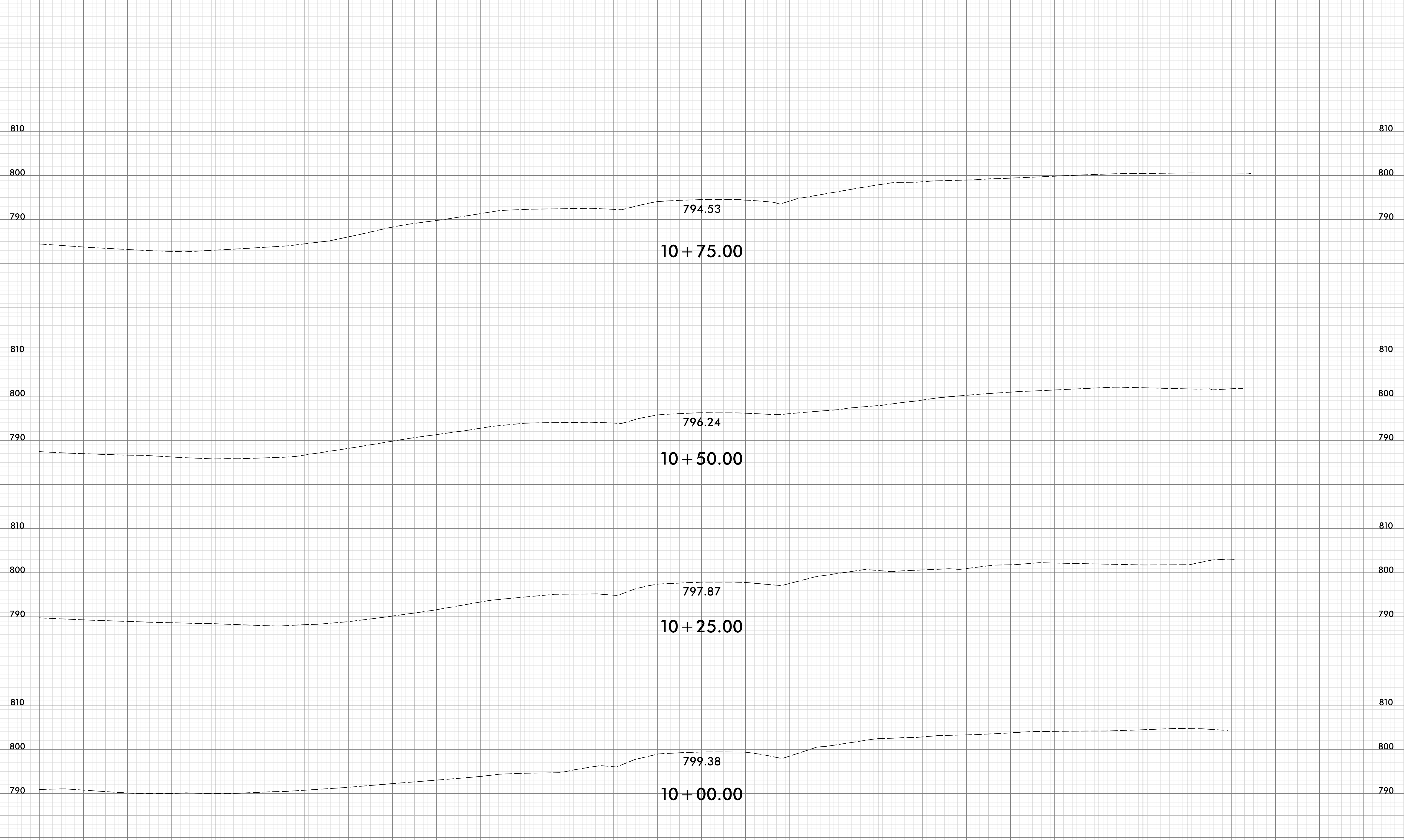

-Y4 REV-

150 140 130 120 110 100 90 80 70 60 50 40 30 20 10 0 10 20 30 40 50 60 70 80 90 100 110 120 130 140 150

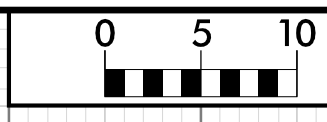

150 140 130 120 110 100 90 80 70 60 50 40 30 20 10 0 10 20 30 40 50 60 70 80 90 100 110 120 130 140 150

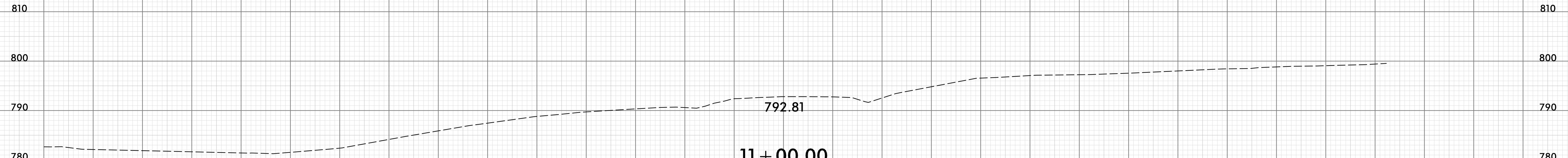
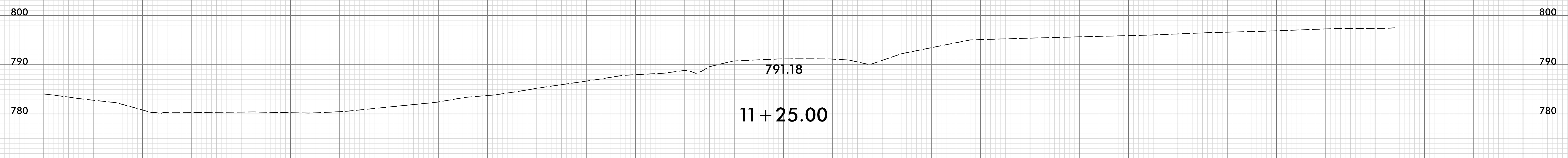
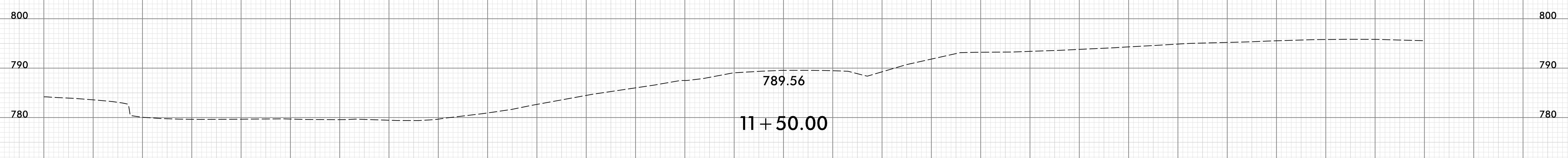
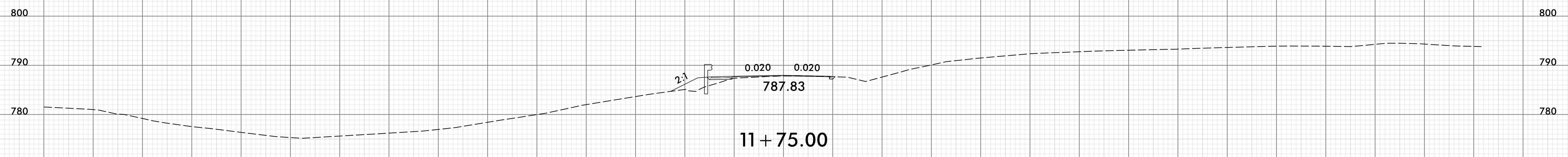

-Y4 REV-

150 140 130 120 110 100 90 80 70 60 50 40 30 20 10 0 10 20 30 40 50 60 70 80 90 100 110 120 130 140 150

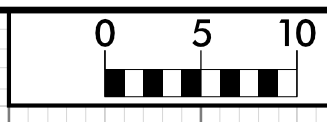

150 140 130 120 110 100 90 80 70 60 50 40 30 20 10 0 10 20 30 40 50 60 70 80 90 100 110 120 130 140 150

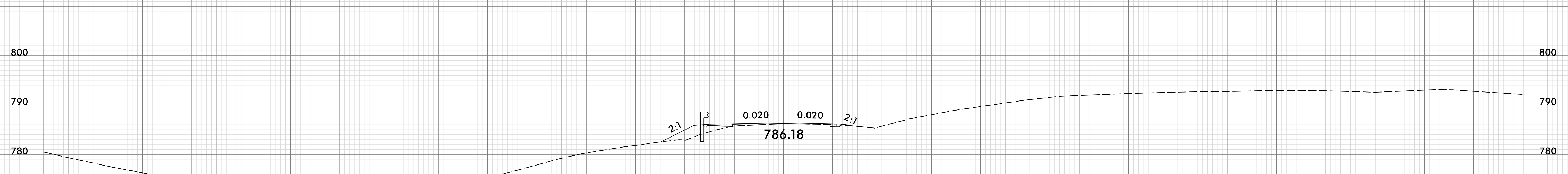
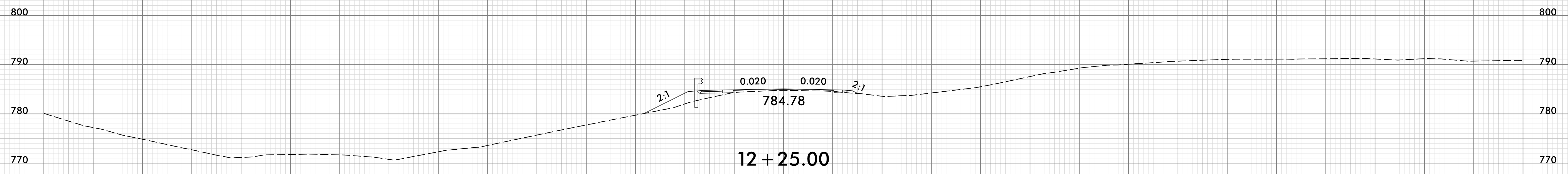
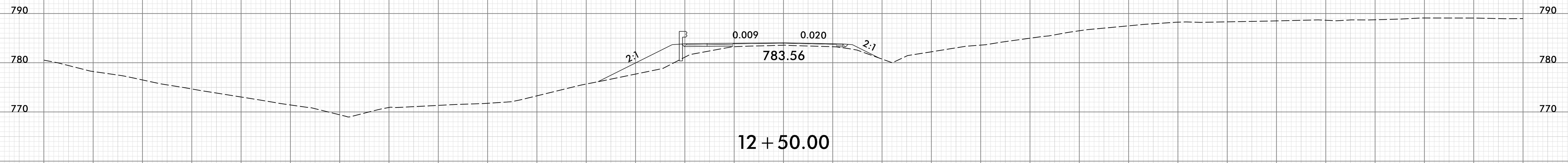
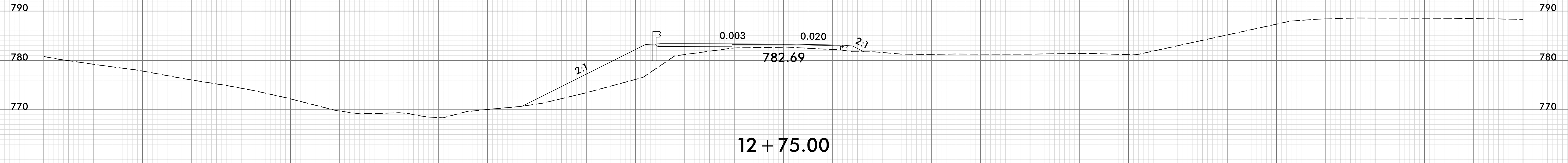

-Y4 REV-

150 140 130 120 110 100 90 80 70 60 50 40 30 20 10 0 10 20 30 40 50 60 70 80 90 100 110 120 130 140 150

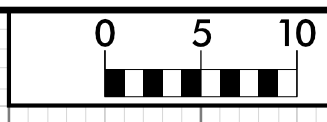

150 140 130 120 110 100 90 80 70 60 50 40 30 20 10 0 10 20 30 40 50 60 70 80 90 100 110 120 130 140 150

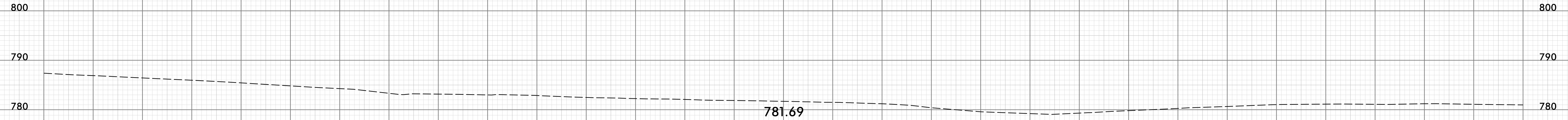

13 + 75.00

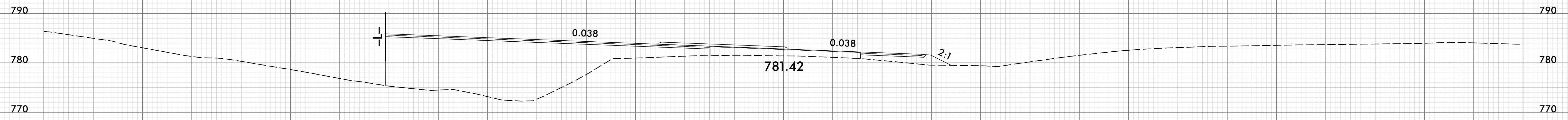

13 + 50.00

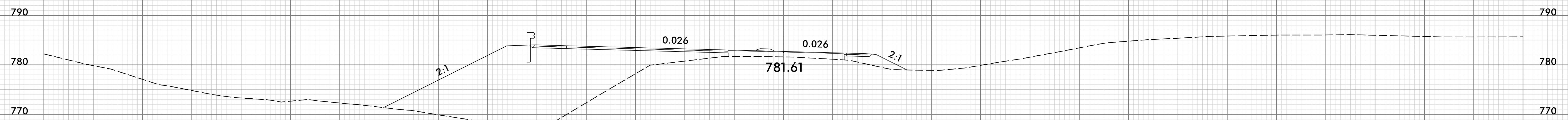

13 + 25.00

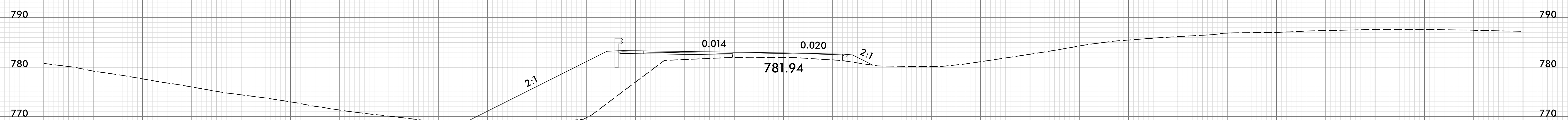

13 + 00.00

-Y4 REV-

150 140 130 120 110 100 90 80 70 60 50 40 30 20 10 0 10 20 30 40 50 60 70 80 90 100 110 120 130 140 150

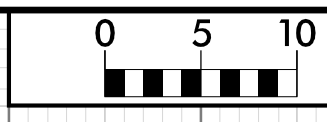

150 140 130 120 110 100 90 80 70 60 50 40 30 20 10 0 10 20 30 40 50 60 70 80 90 100 110 120 130 140 150

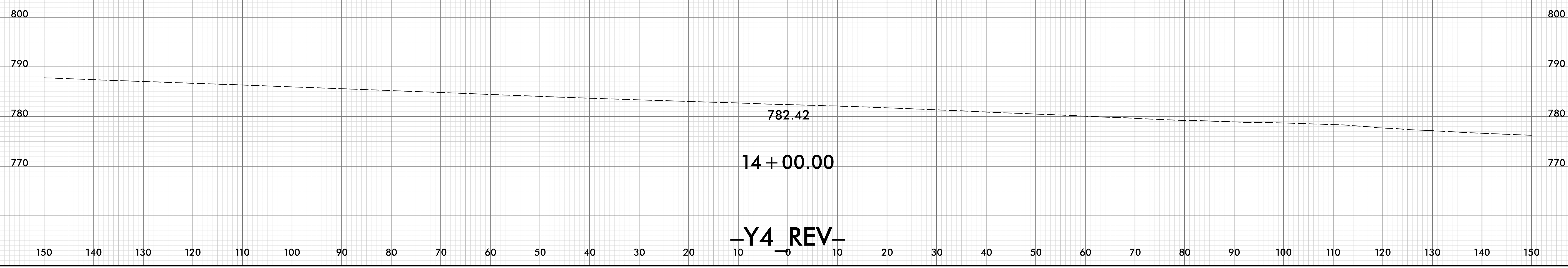

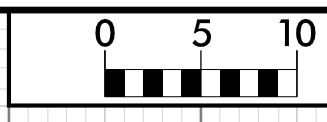

150 140 130 120 110 100 90 80 70 60 50 40 30 20 10 0 10 20 30 40 50 60 70 80 90 100 110 120 130 140 150

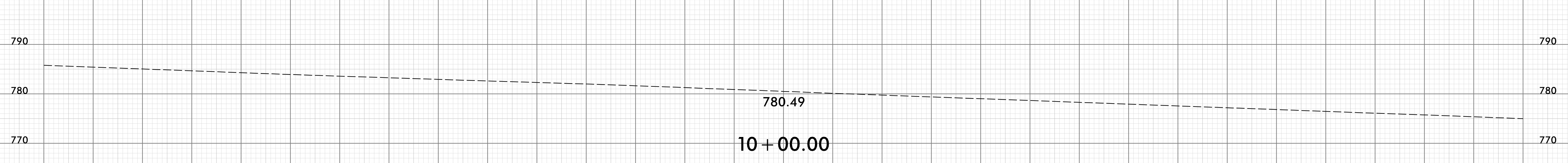
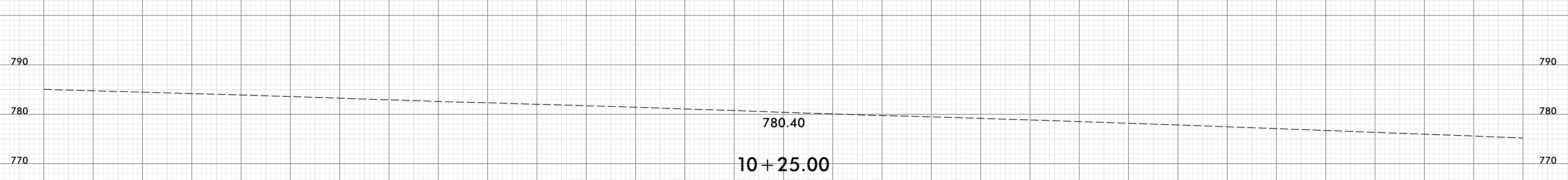
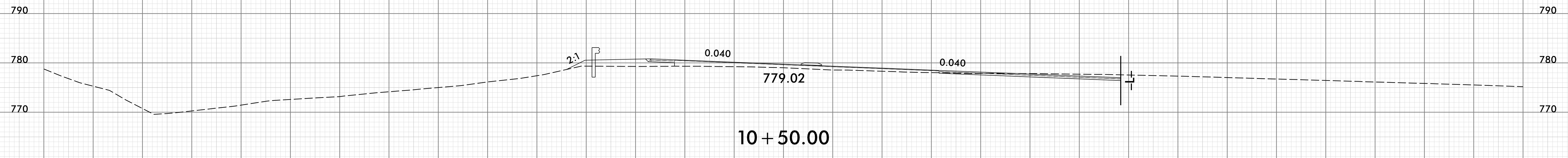
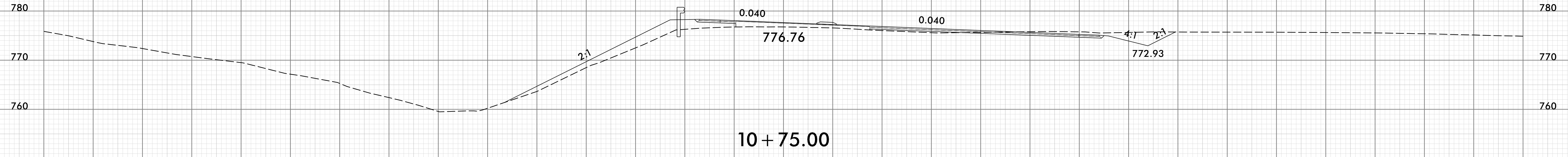

-Y5-

150 140 130 120 110 100 90 80 70 60 50 40 30 20 10 0 10 20 30 40 50 60 70 80 90 100 110 120 130 140 150



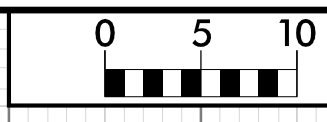

150 140 130 120 110 100 90 80 70 60 50 40 30 20 10 0 10 20 30 40 50 60 70 80 90 100 110 120 130 140 150

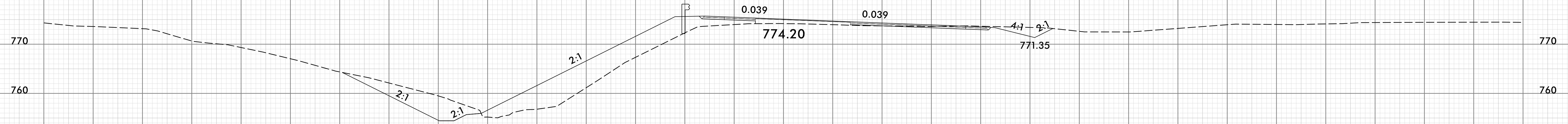
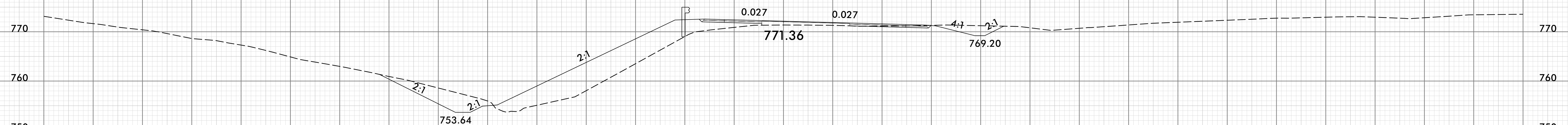
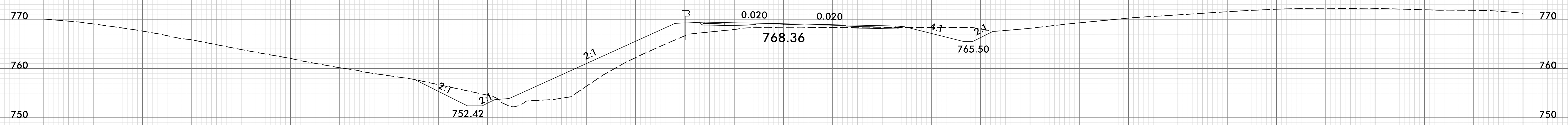
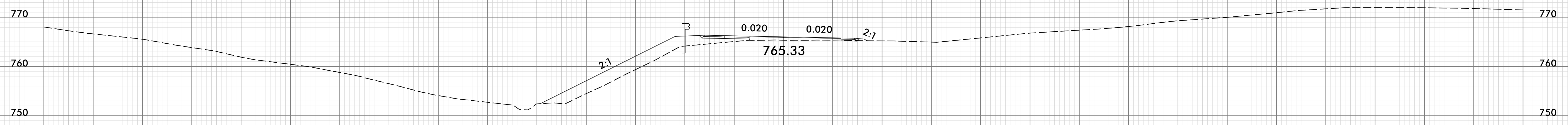

-Y5-

150 140 130 120 110 100 90 80 70 60 50 40 30 20 10 0 10 20 30 40 50 60 70 80 90 100 110 120 130 140 150

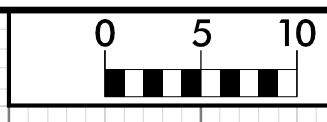

150 140 130 120 110 100 90 80 70 60 50 40 30 20 10 0 10 20 30 40 50 60 70 80 90 100 110 120 130 140 150

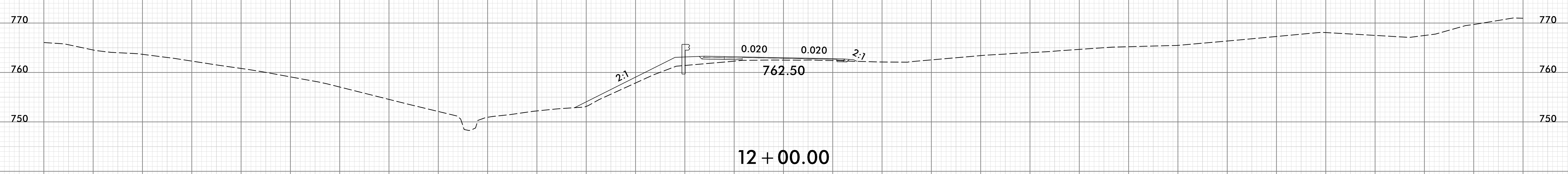
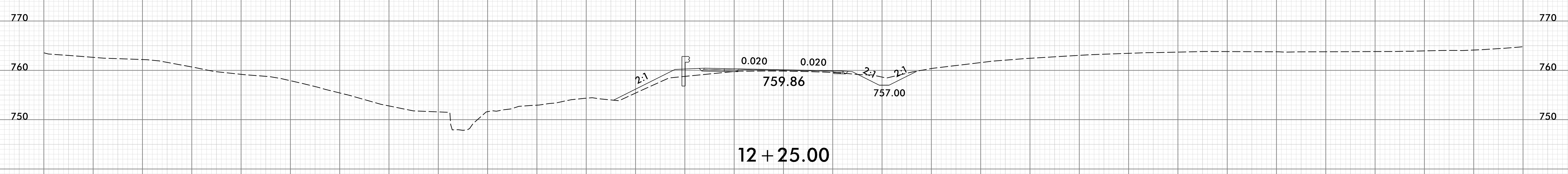
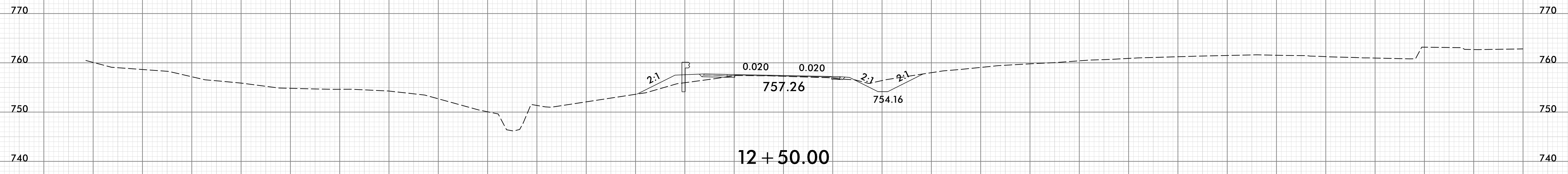
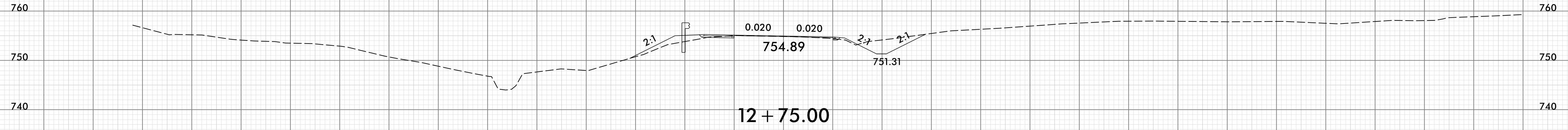

-Y5-

150 140 130 120 110 100 90 80 70 60 50 40 30 20 10 0 10 20 30 40 50 60 70 80 90 100 110 120 130 140 150

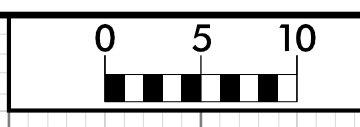

150 140 130 120 110 100 90 80 70 60 50 40 30 20 10 0 10 20 30 40 50 60 70 80 90 100 110 120 130 140 150

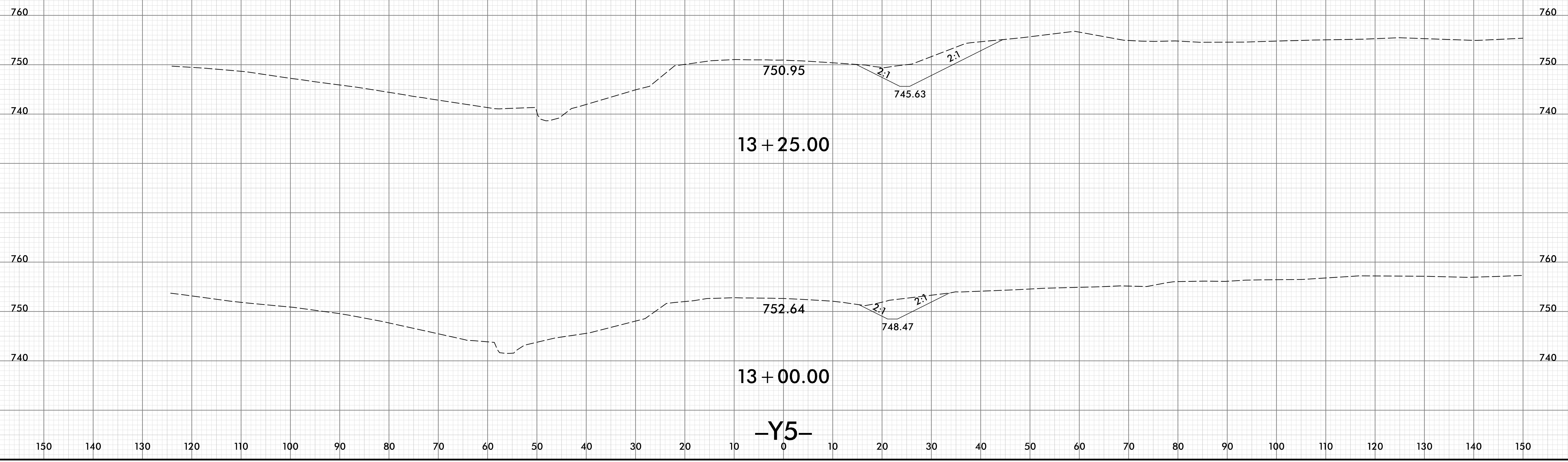

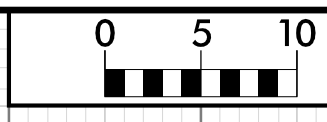

150 140 130 120 110 100 90 80 70 60 50 40 30 20 10 0 10 20 30 40 50 60 70 80 90 100 110 120 130 140 150

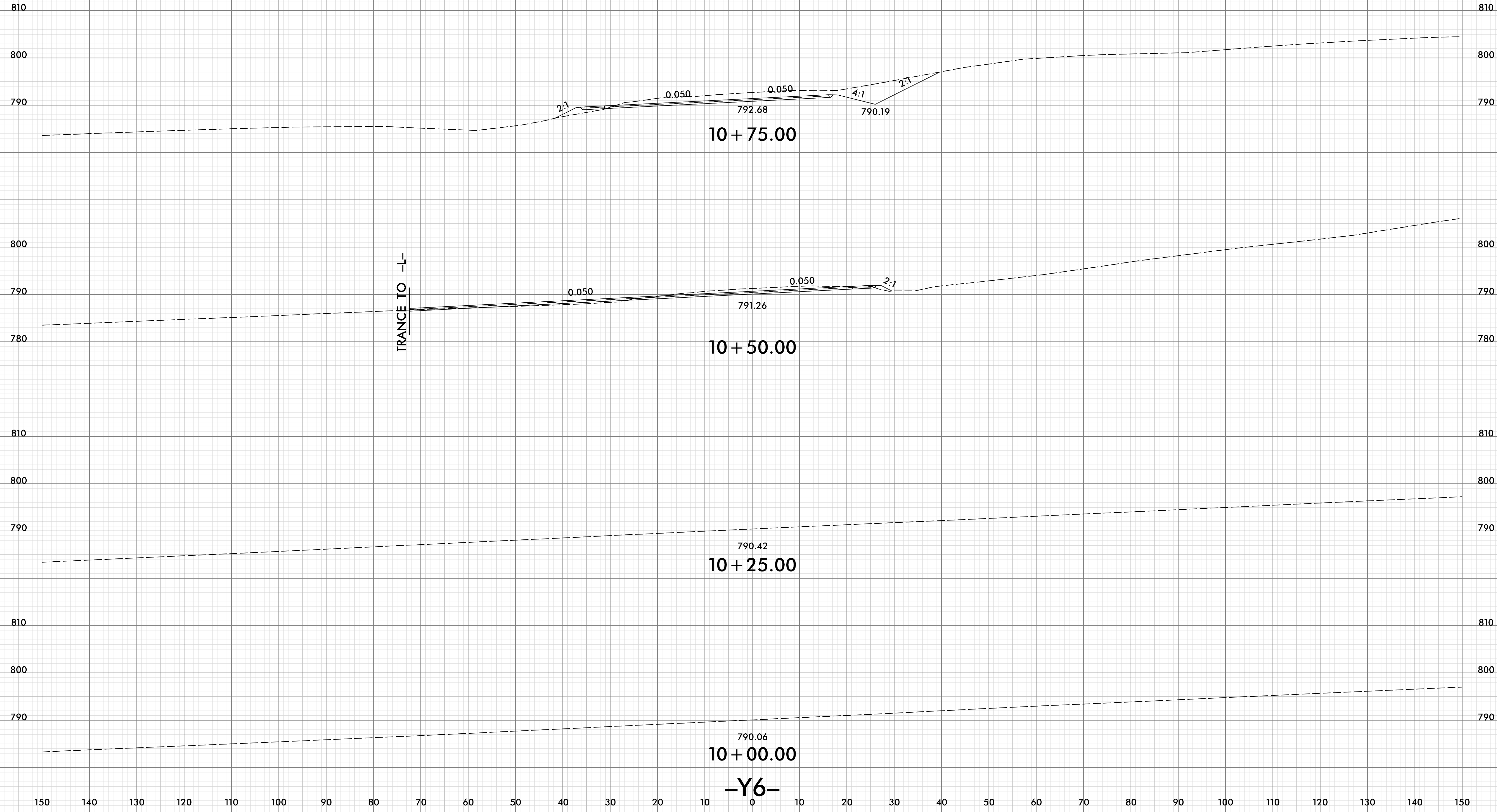

150 140 130 120 110 100 90 80 70 60 50 40 30 20 10 0 10 20 30 40 50 60 70 80 90 100 110 120 130 140 150

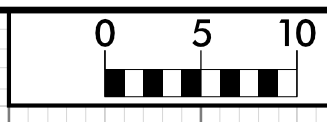

150 140 130 120 110 100 90 80 70 60 50 40 30 20 10 0 10 20 30 40 50 60 70 80 90 100 110 120 130 140 150

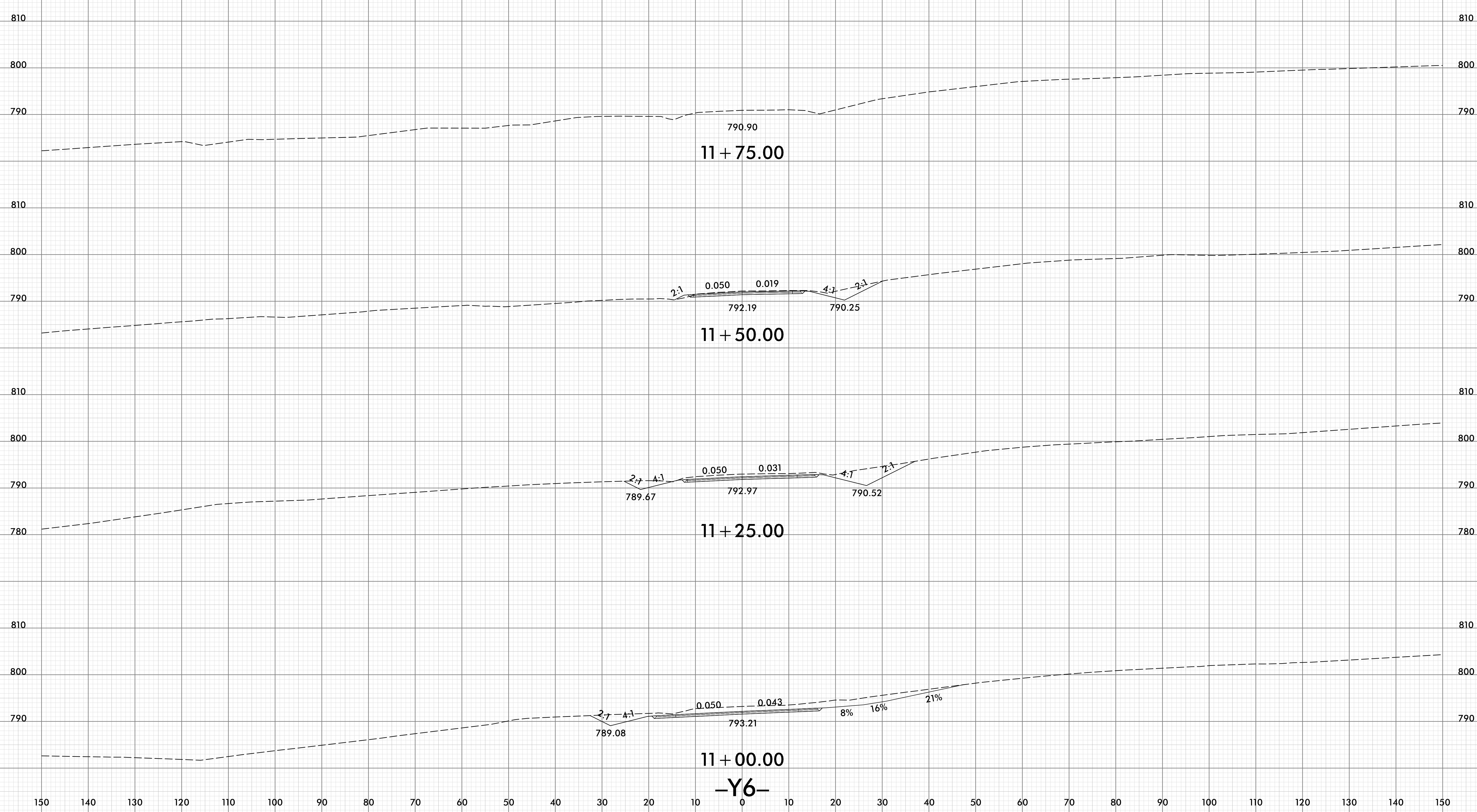

11+75.00

11+50.00

11+25.00

11+00.00

-Y6-

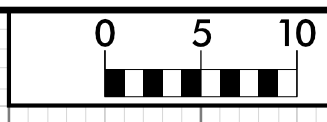

150 140 130 120 110 100 90 80 70 60 50 40 30 20 10 0 10 20 30 40 50 60 70 80 90 100 110 120 130 140 150

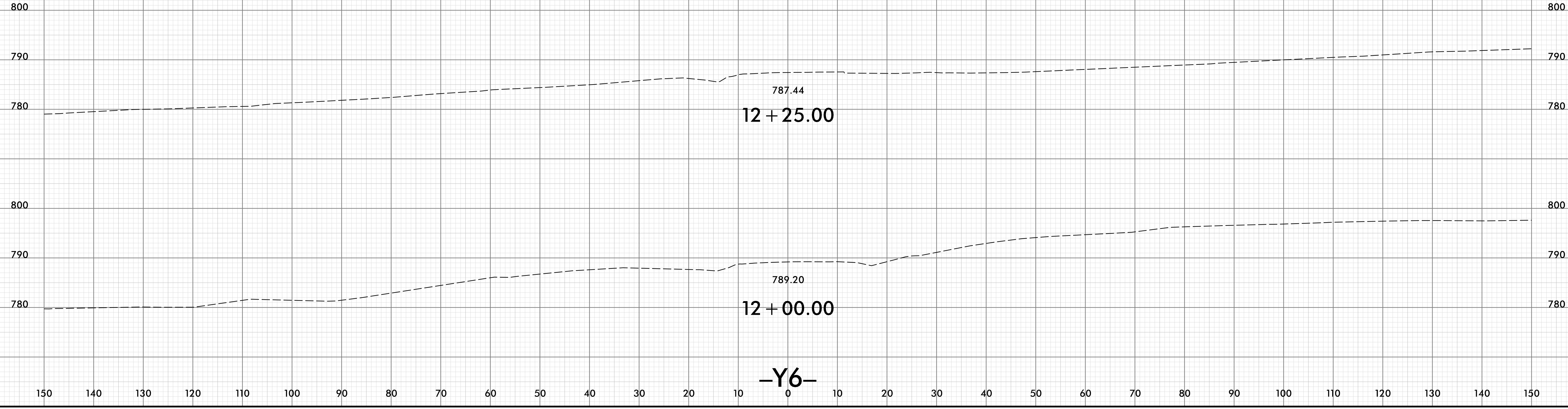

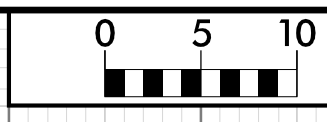

150 140 130 120 110 100 90 80 70 60 50 40 30 20 10 0 10 20 30 40 50 60 70 80 90 100 110 120 130 140 150

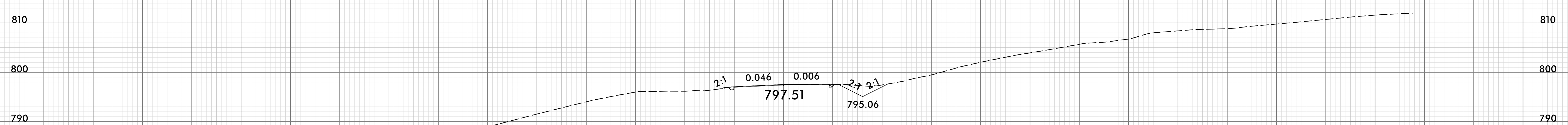
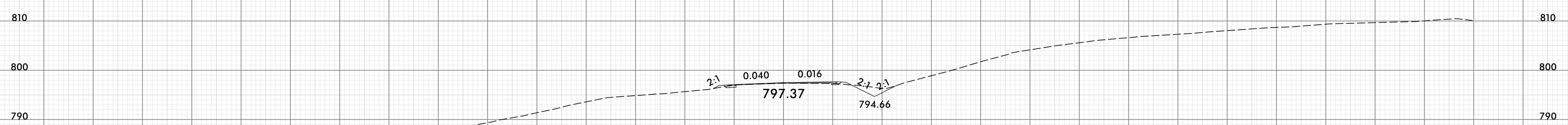
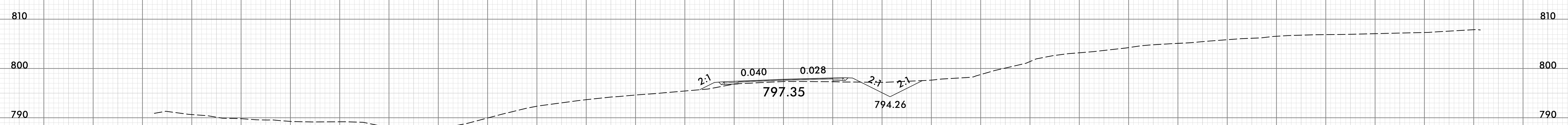
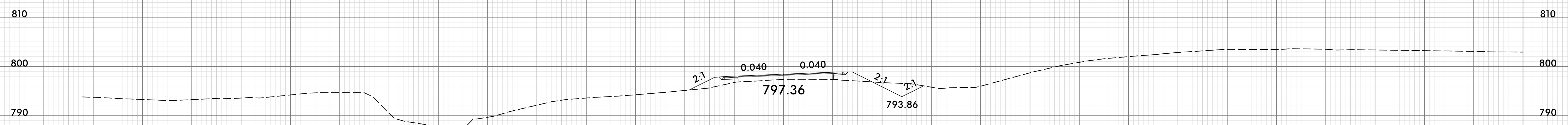

150 140 130 120 110 100 90 80 70 60 50 40 30 20 10 0 10 20 30 40 50 60 70 80 90 100 110 120 130 140 150

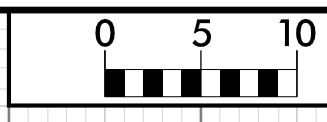

150 140 130 120 110 100 90 80 70 60 50 40 30 20 10 0 10 20 30 40 50 60 70 80 90 100 110 120 130 140 150

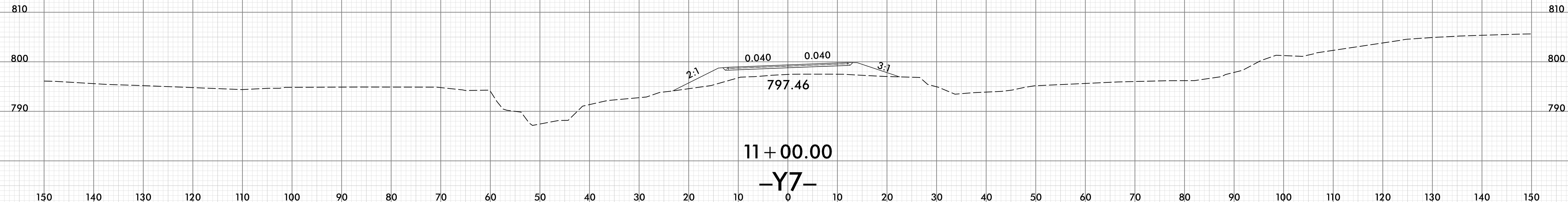
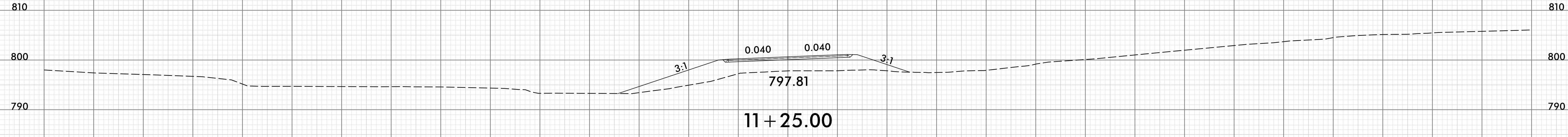
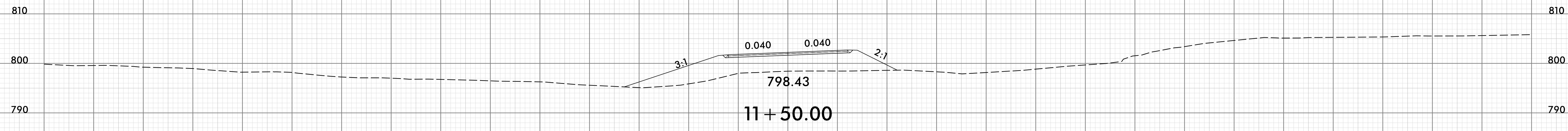
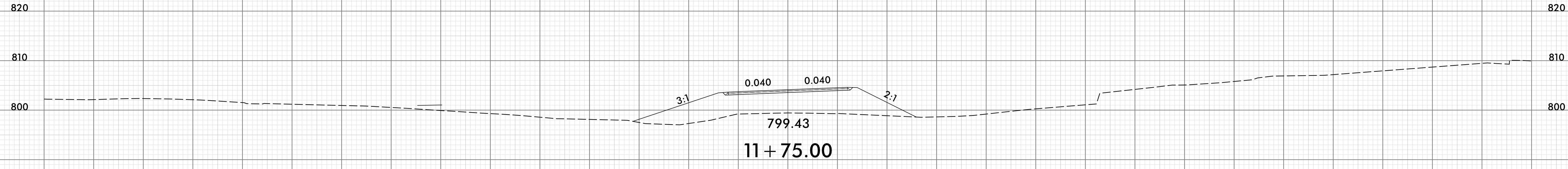



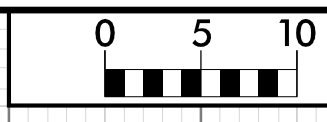

150 140 130 120 110 100 90 80 70 60 50 40 30 20 10 0 10 20 30 40 50 60 70 80 90 100 110 120 130 140 150

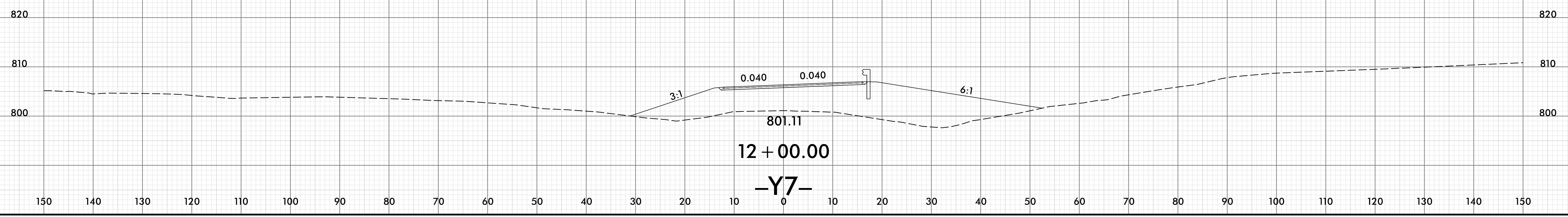
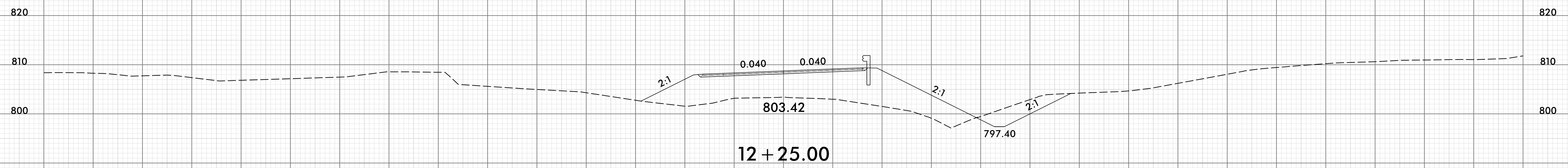
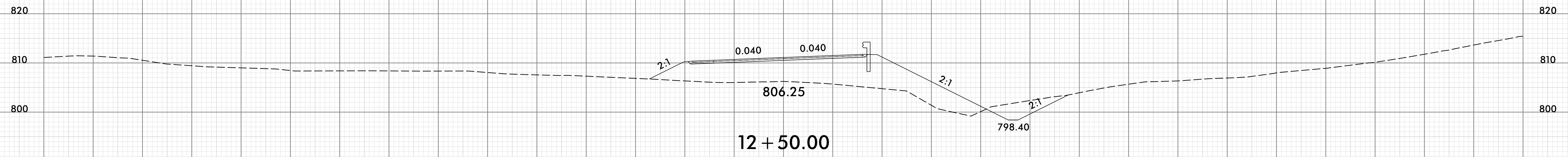
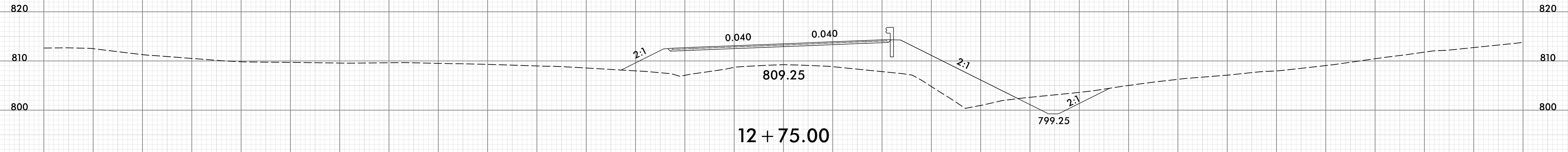

150 140 130 120 110 100 90 80 70 60 50 40 30 20 10 0 10 20 30 40 50 60 70 80 90 100 110 120 130 140 150

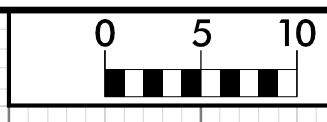

150 140 130 120 110 100 90 80 70 60 50 40 30 20 10 0 10 20 30 40 50 60 70 80 90 100 110 120 130 140 150

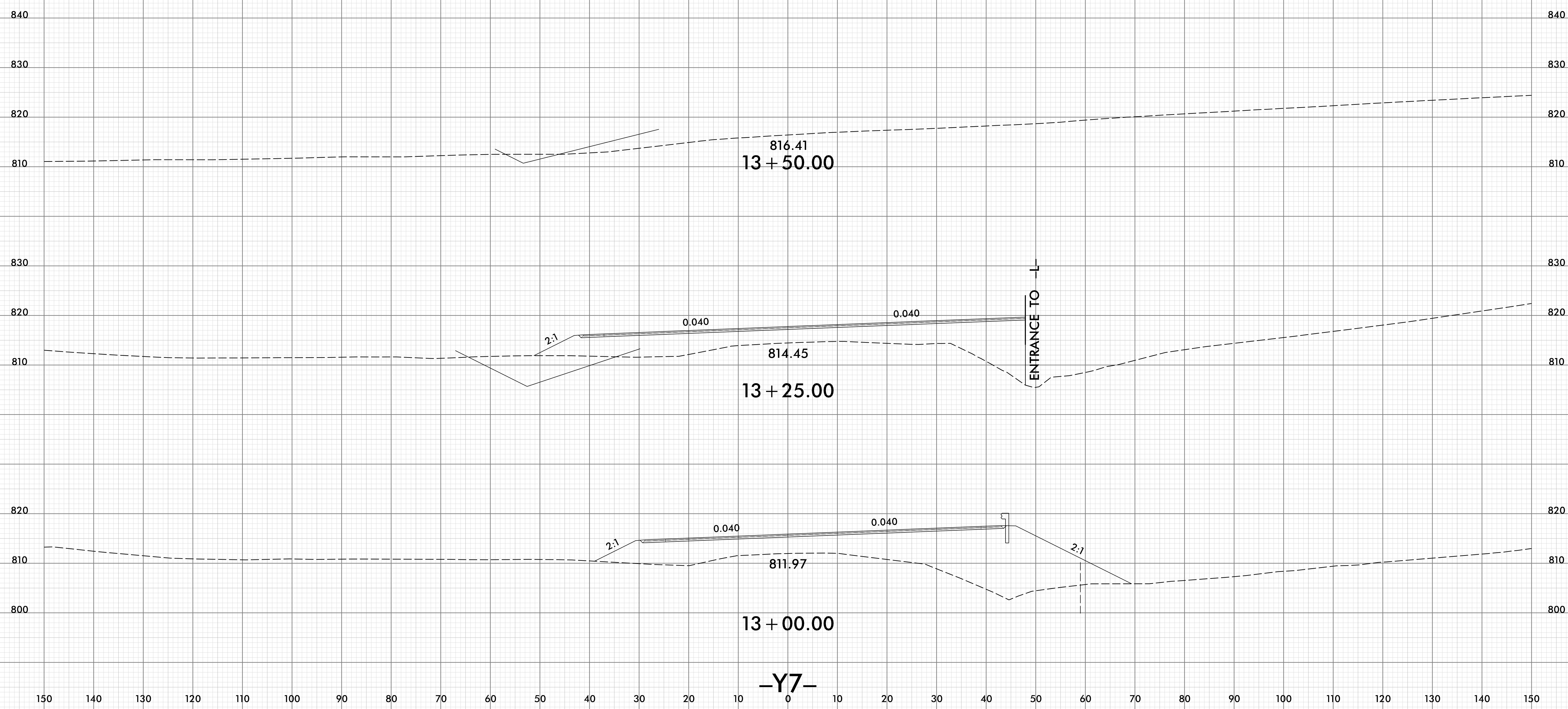

-Y7-

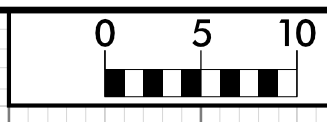

150 140 130 120 110 100 90 80 70 60 50 40 30 20 10 0 10 20 30 40 50 60 70 80 90 100 110 120 130 140 150

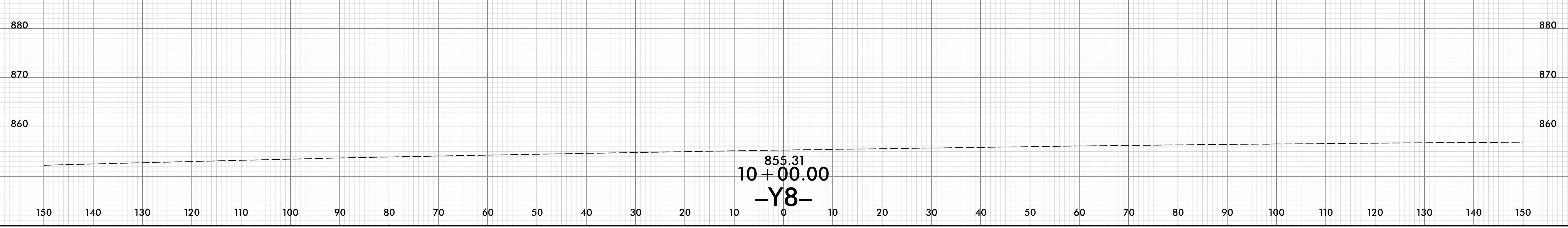
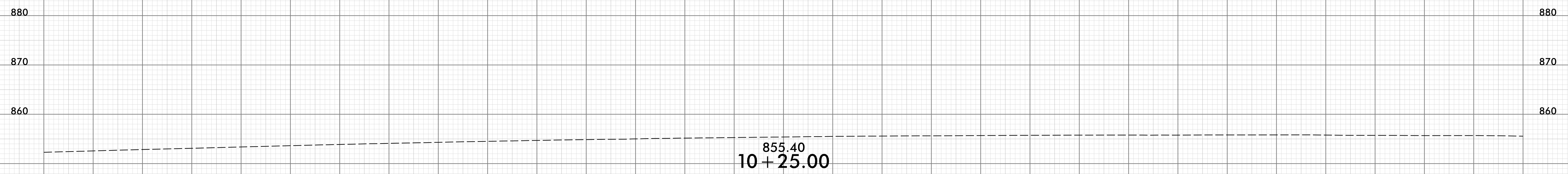
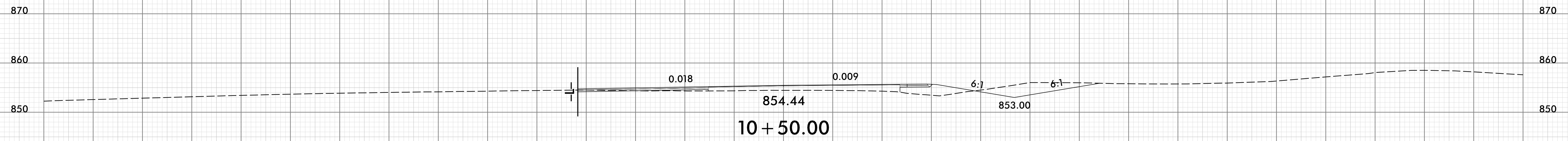
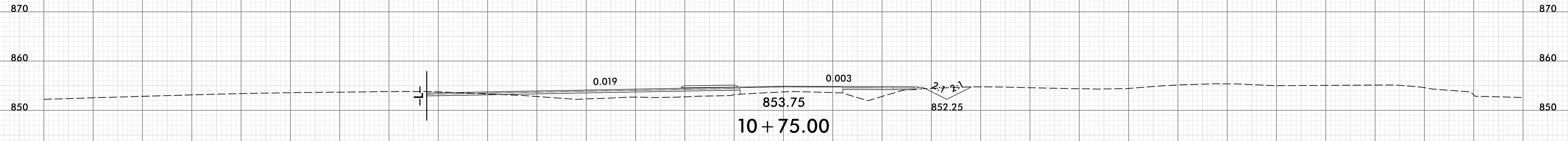

150 140 130 120 110 100 90 80 70 60 50 40 30 20 10 0 10 20 30 40 50 60 70 80 90 100 110 120 130 140 150

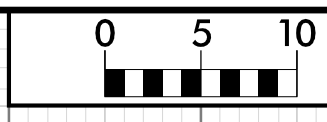

150 140 130 120 110 100 90 80 70 60 50 40 30 20 10 0 10 20 30 40 50 60 70 80 90 100 110 120 130 140 150

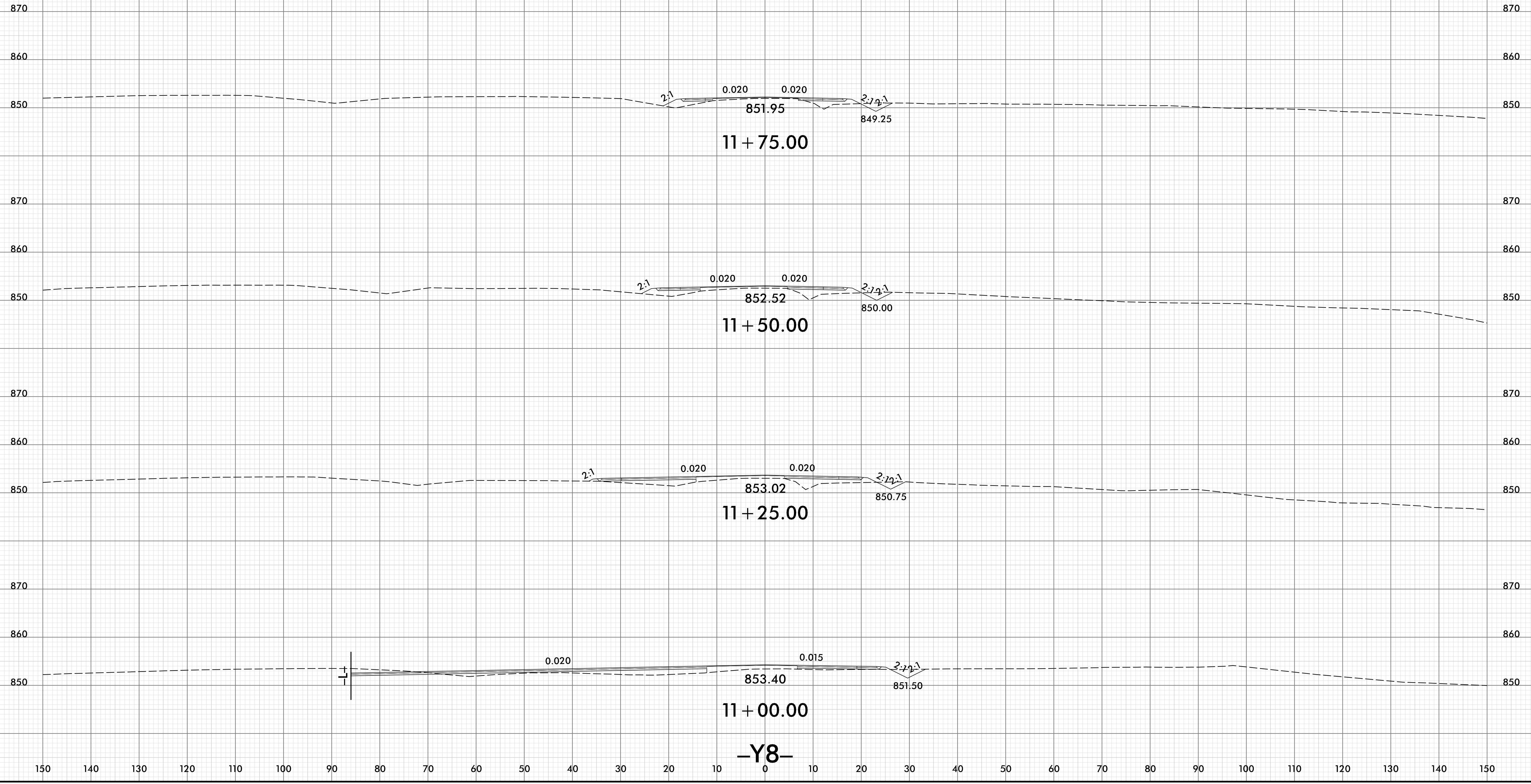

-Y8-

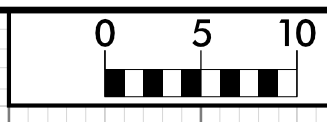

150 140 130 120 110 100 90 80 70 60 50 40 30 20 10 0 10 20 30 40 50 60 70 80 90 100 110 120 130 140 150

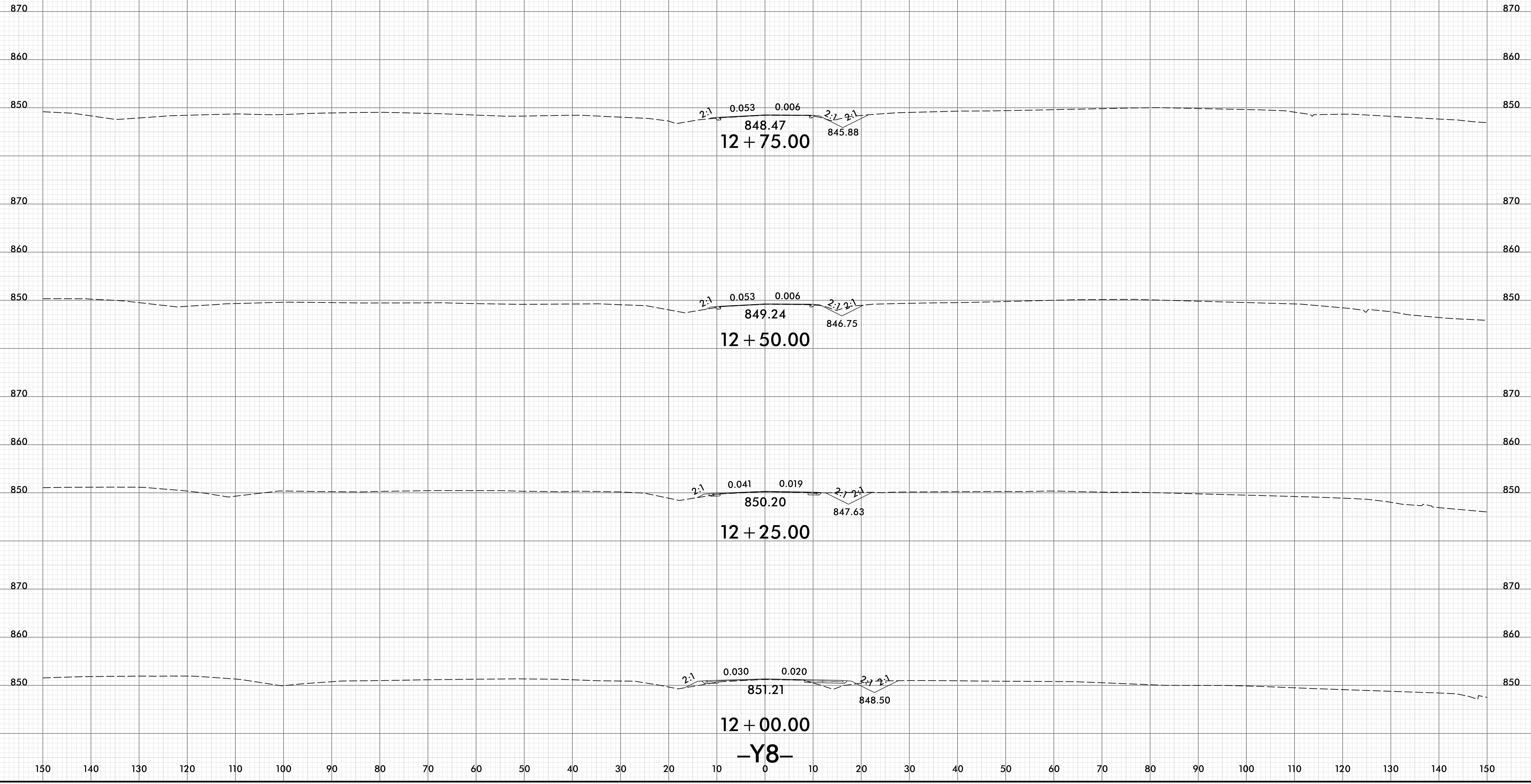

150 140 130 120 110 100 90 80 70 60 50 40 30 20 10 0 10 20 30 40 50 60 70 80 90 100 110 120 130 140 150

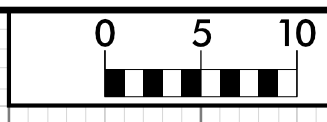

PROJ. REFERENCE NO.  
U-5813

SHEET NO.  
X-125

150 140 130 120 110 100 90 80 70 60 50 40 30 20 10 0 10 20 30 40 50 60 70 80 90 100 110 120 130 140 150

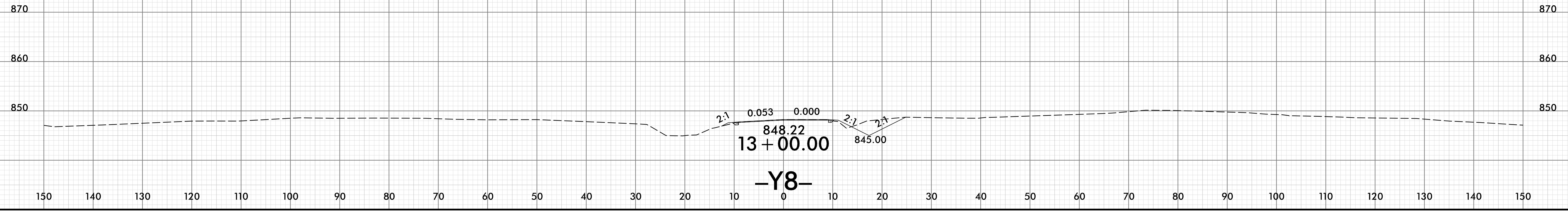

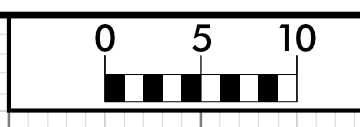

150 140 130 120 110 100 90 80 70 60 50 40 30 20 10 0 10 20 30 40 50 60 70 80 90 100 110 120 130 140 150

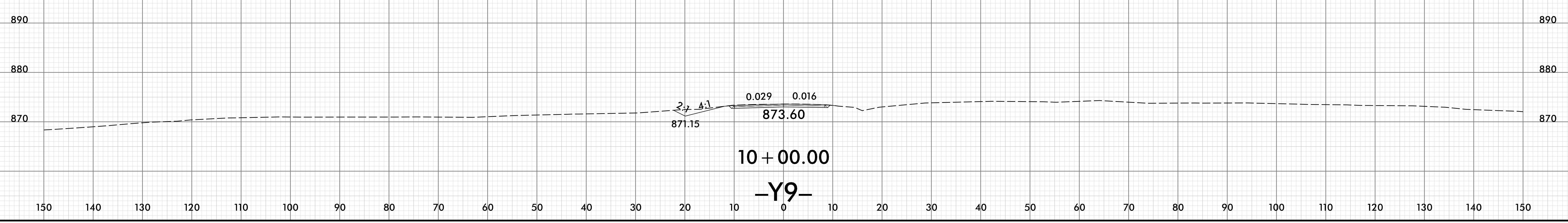
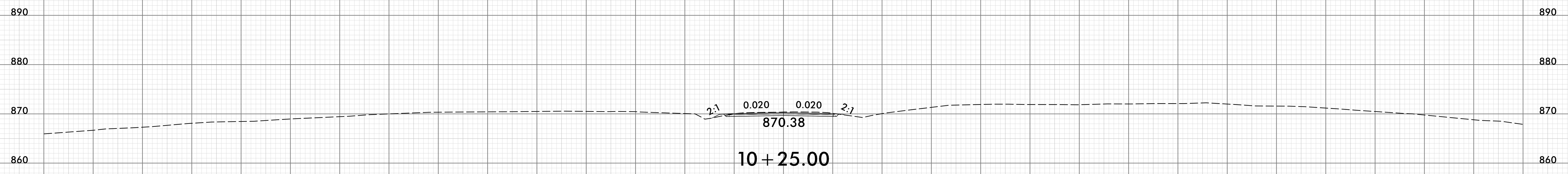
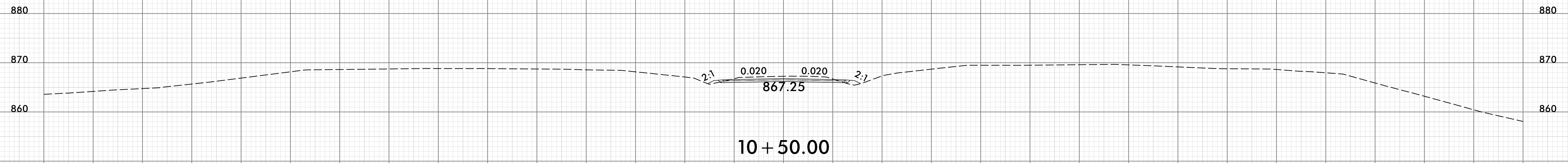
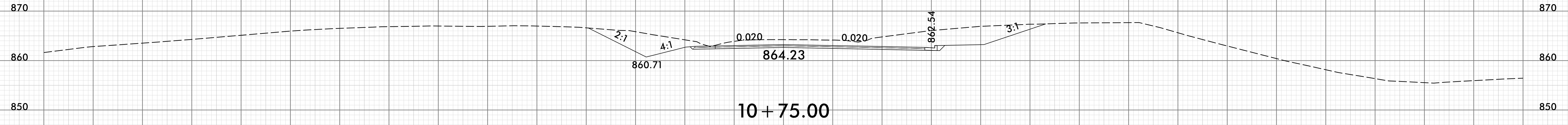

150 140 130 120 110 100 90 80 70 60 50 40 30 20 10 0 10 20 30 40 50 60 70 80 90 100 110 120 130 140 150

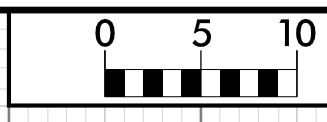

150 140 130 120 110 100 90 80 70 60 50 40 30 20 10 0 10 20 30 40 50 60 70 80 90 100 110 120 130 140 150

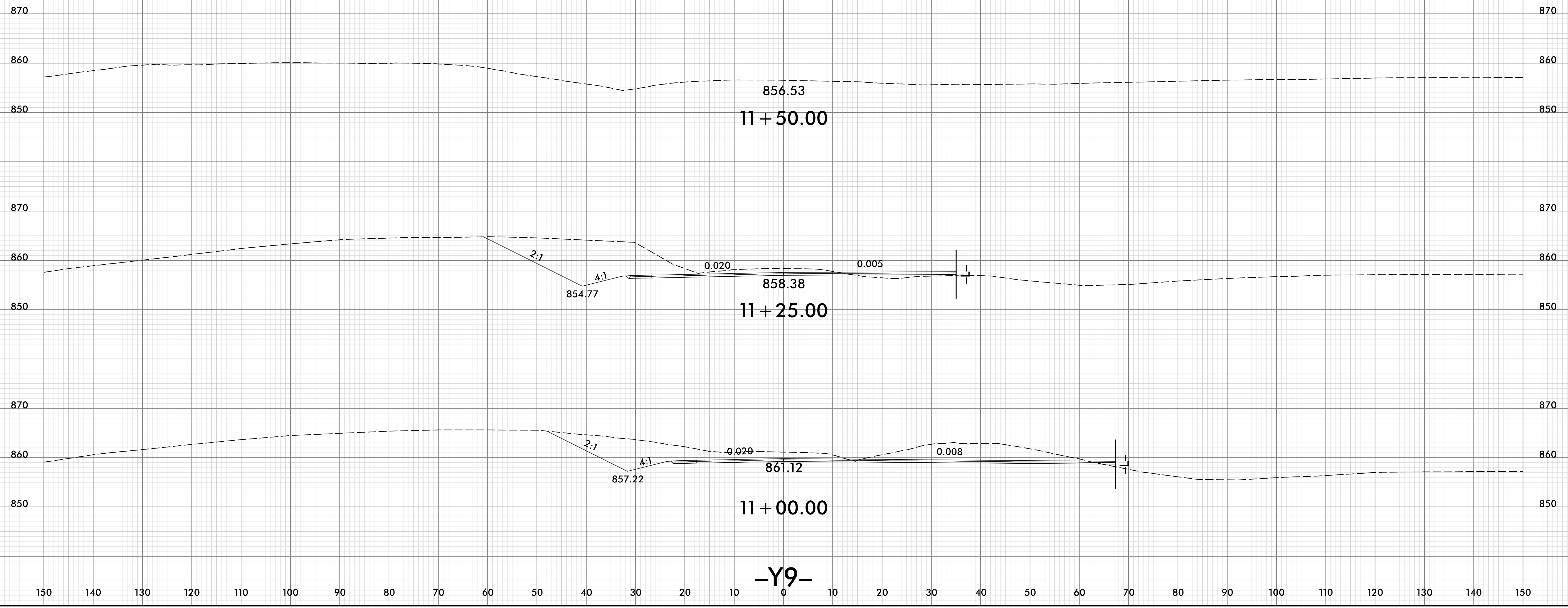

-Y9-



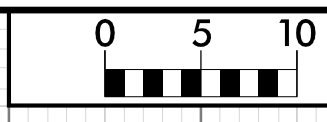

150 140 130 120 110 100 90 80 70 60 50 40 30 20 10 0 10 20 30 40 50 60 70 80 90 100 110 120 130 140 150

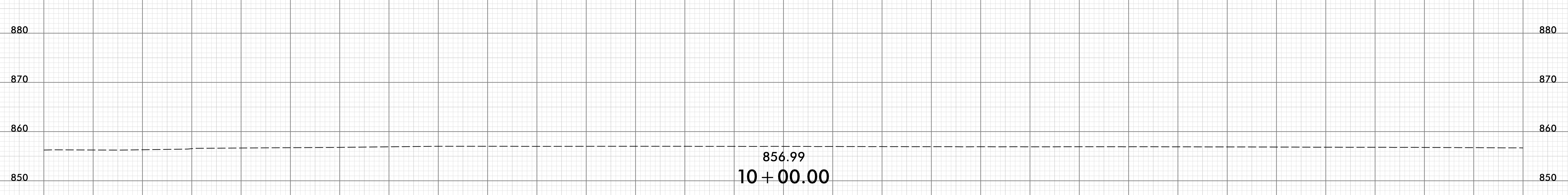
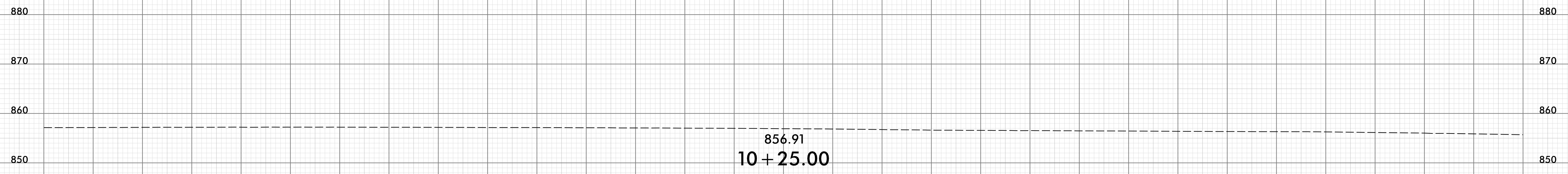
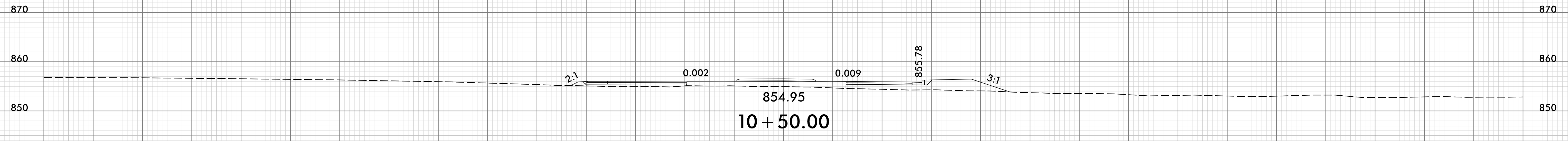
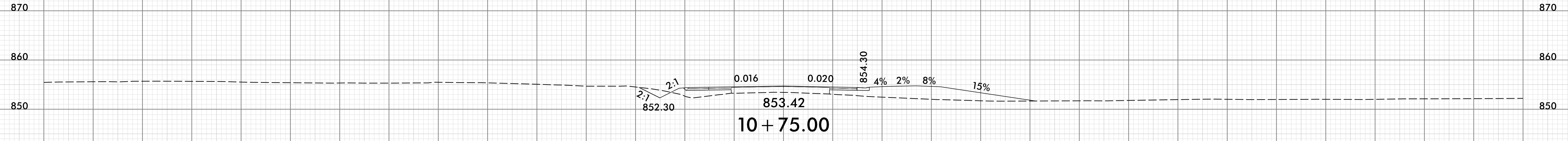

-Y10-

150 140 130 120 110 100 90 80 70 60 50 40 30 20 10 0 10 20 30 40 50 60 70 80 90 100 110 120 130 140 150

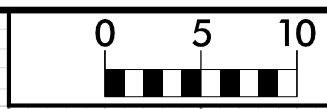

150 140 130 120 110 100 90 80 70 60 50 40 30 20 10 0 10 20 30 40 50 60 70 80 90 100 110 120 130 140 150

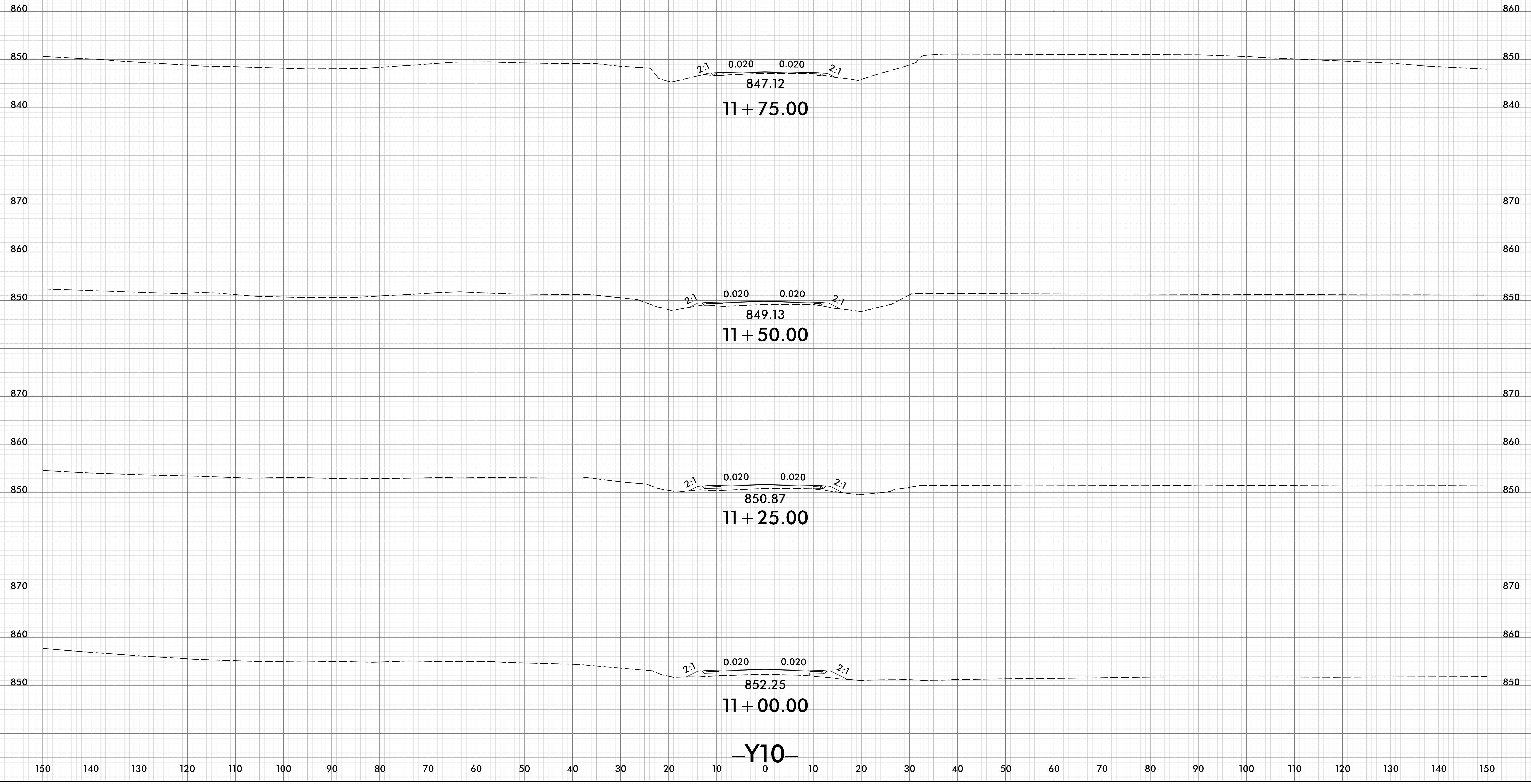

-Y10-

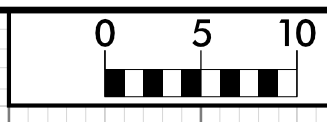

150 140 130 120 110 100 90 80 70 60 50 40 30 20 10 0 10 20 30 40 50 60 70 80 90 100 110 120 130 140 150

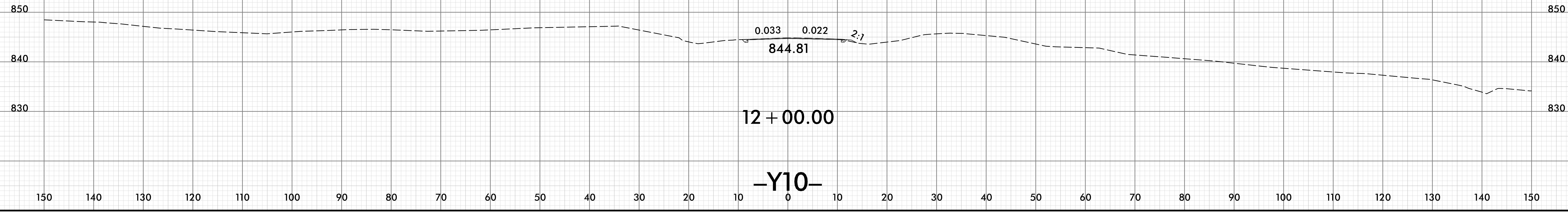

150 140 130 120 110 100 90 80 70 60 50 40 30 20 10 0 10 20 30 40 50 60 70 80 90 100 110 120 130 140 150

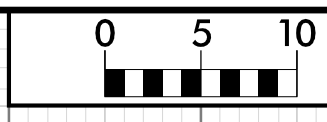

150 140 130 120 110 100 90 80 70 60 50 40 30 20 10 0 10 20 30 40 50 60 70 80 90 100 110 120 130 140 150

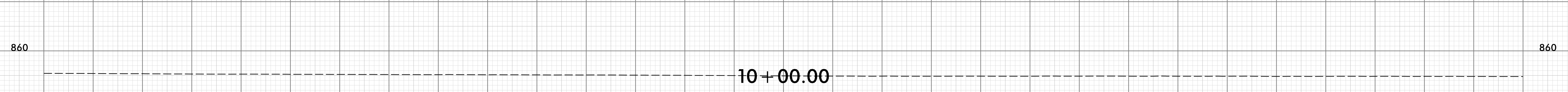
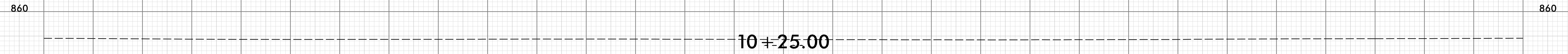
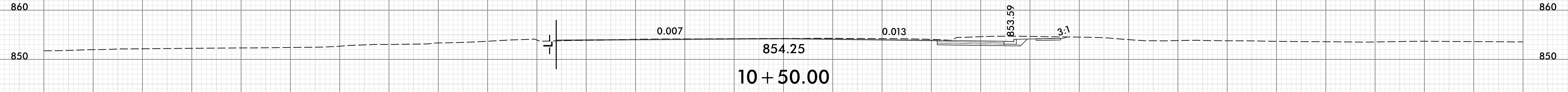
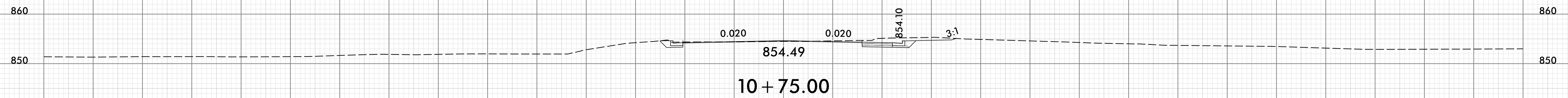
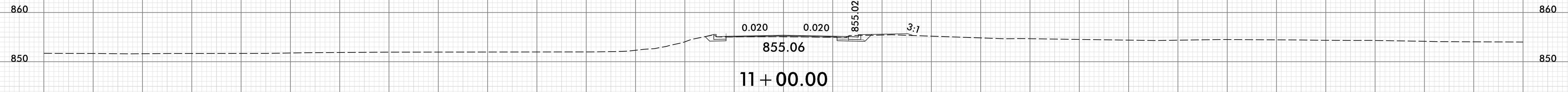
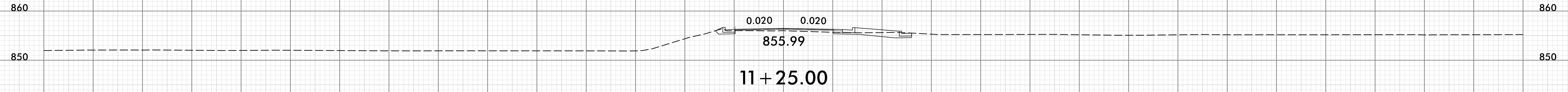

-Y11-

150 140 130 120 110 100 90 80 70 60 50 40 30 20 10 0 10 20 30 40 50 60 70 80 90 100 110 120 130 140 150

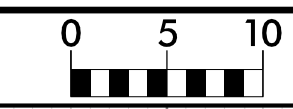

150 140 130 120 110 100 90 80 70 60 50 40 30 20 10 0 10 20 30 40 50 60 70 80 90 100 110 120 130 140 150

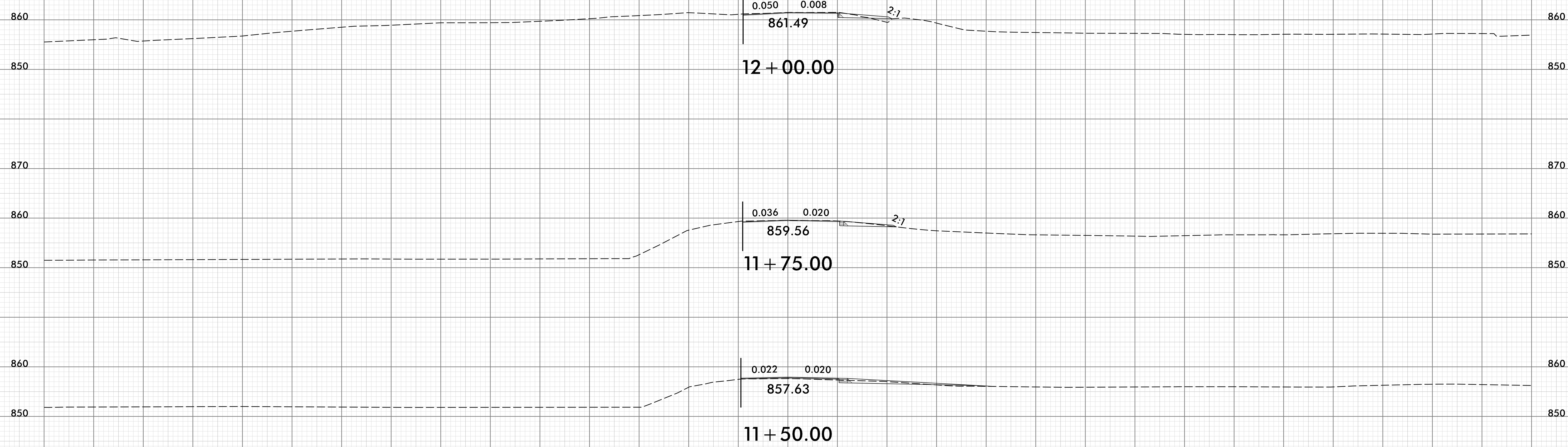

-Y11-

150 140 130 120 110 100 90 80 70 60 50 40 30 20 10 0 10 20 30 40 50 60 70 80 90 100 110 120 130 140 150

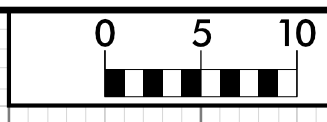

150 140 130 120 110 100 90 80 70 60 50 40 30 20 10 0 10 20 30 40 50 60 70 80 90 100 110 120 130 140 150

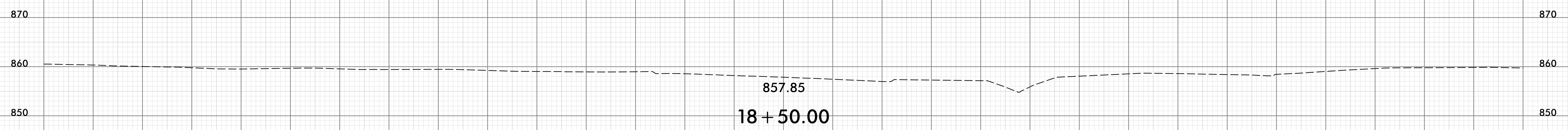
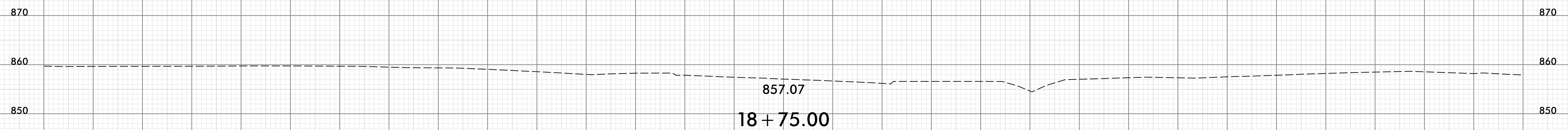
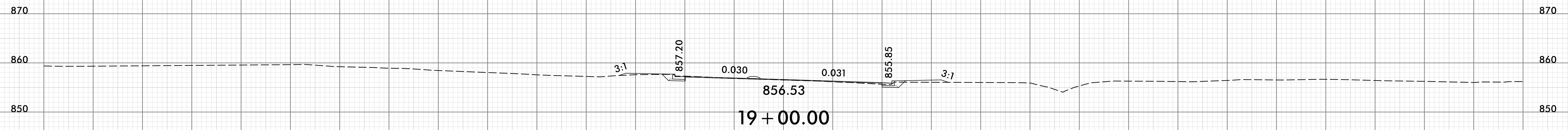
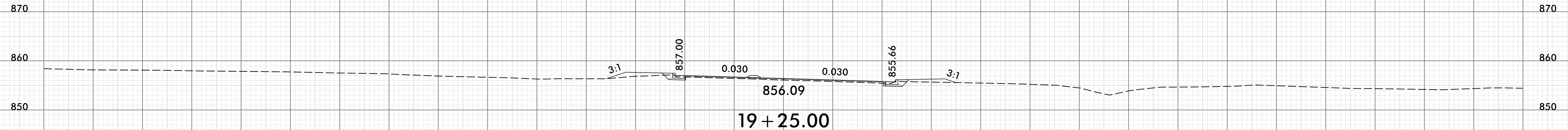

-Y12-

150 140 130 120 110 100 90 80 70 60 50 40 30 20 10 0 10 20 30 40 50 60 70 80 90 100 110 120 130 140 150

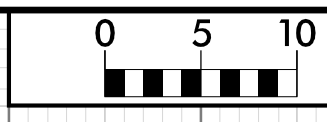

150 140 130 120 110 100 90 80 70 60 50 40 30 20 10 0 10 20 30 40 50 60 70 80 90 100 110 120 130 140 150

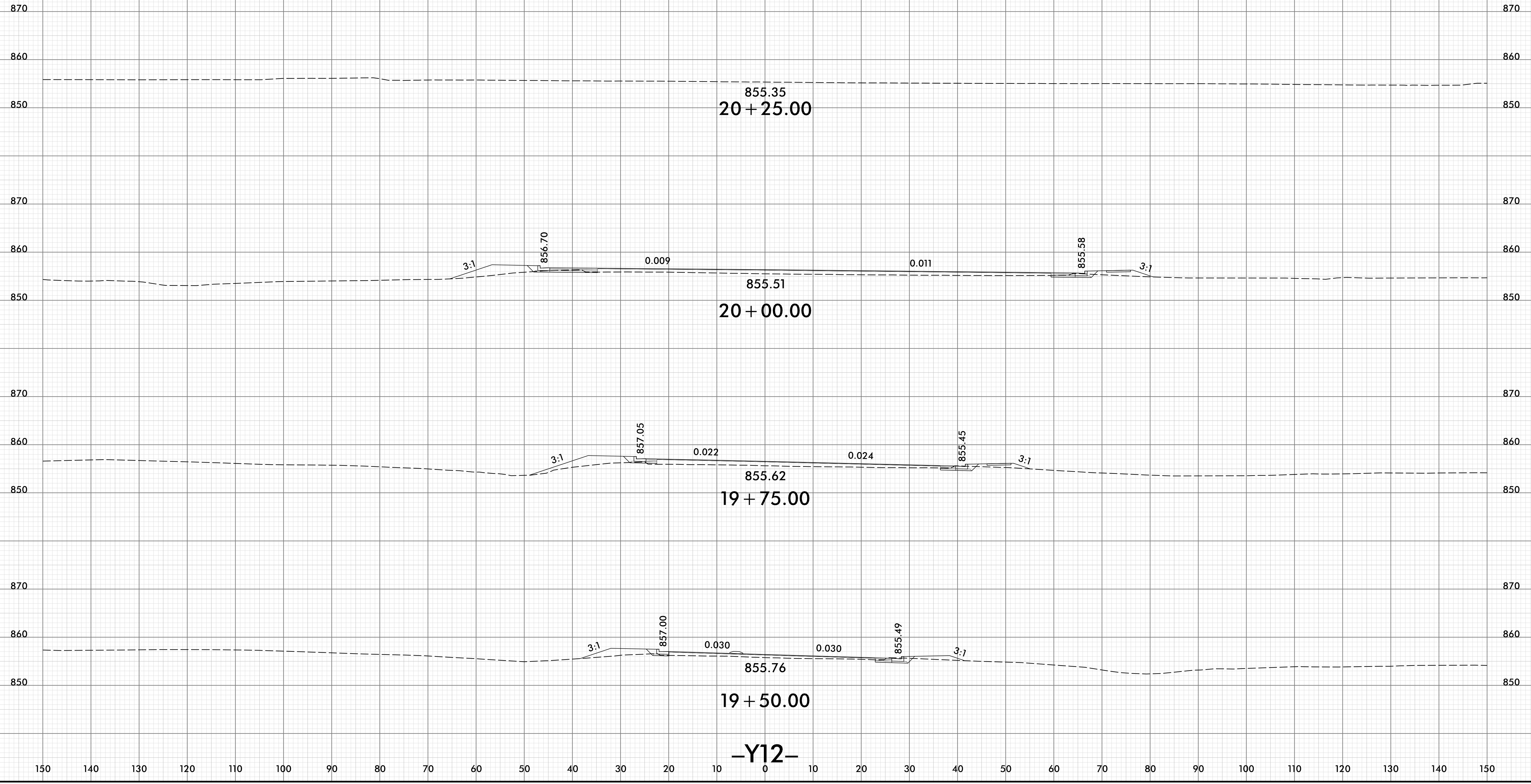

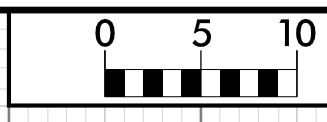

150 140 130 120 110 100 90 80 70 60 50 40 30 20 10 0 10 20 30 40 50 60 70 80 90 100 110 120 130 140 150

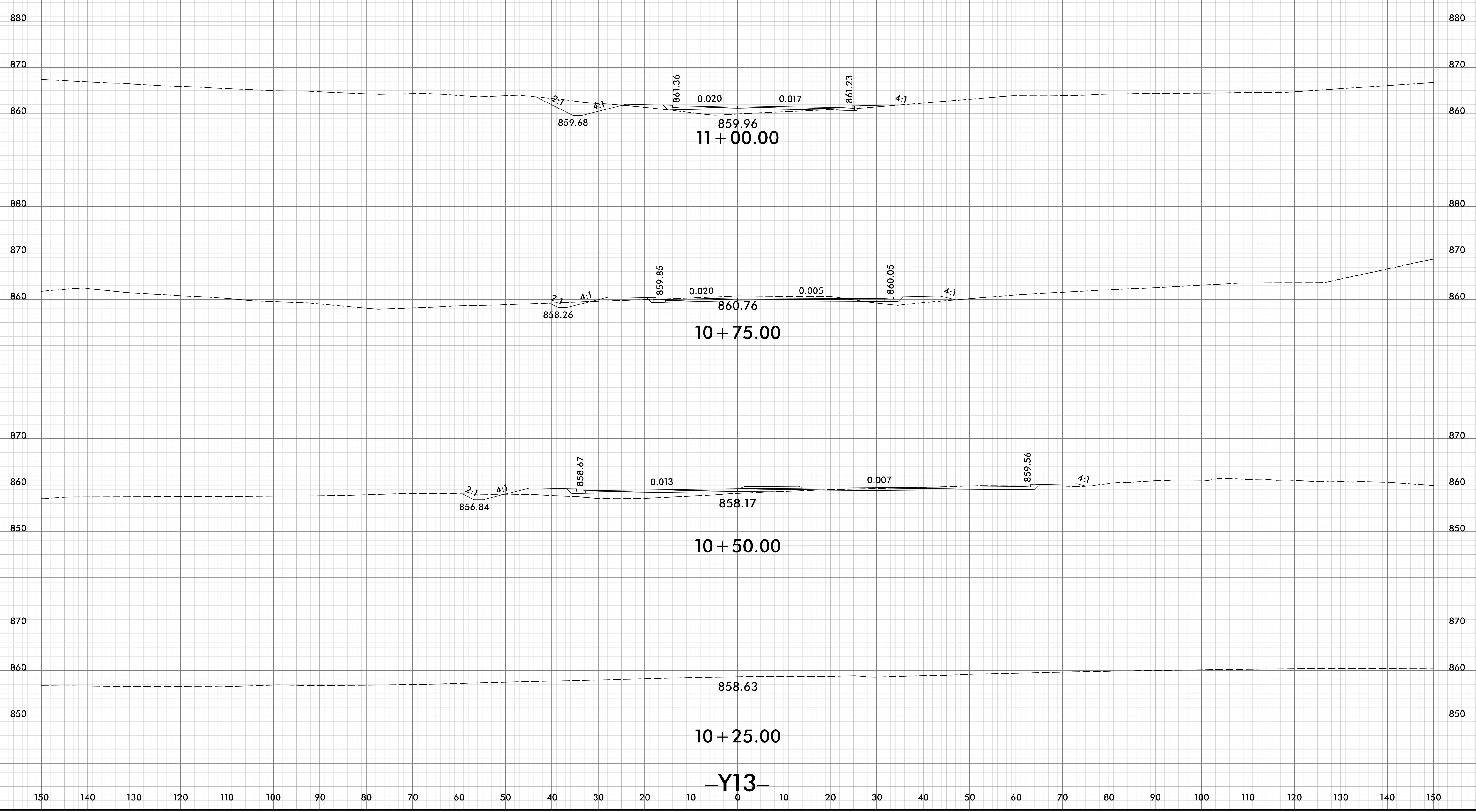

-Y13-



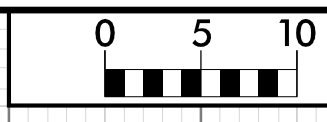

150 140 130 120 110 100 90 80 70 60 50 40 30 20 10 0 10 20 30 40 50 60 70 80 90 100 110 120 130 140 150

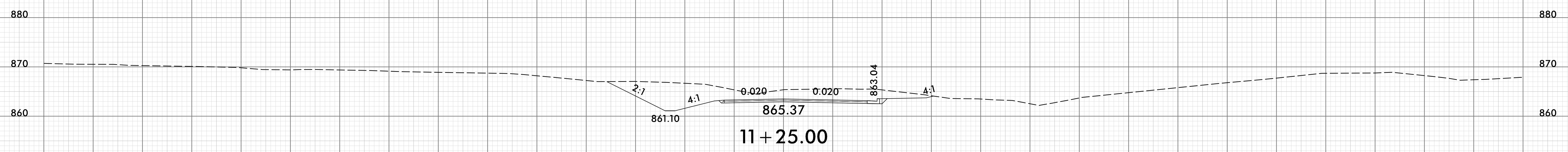
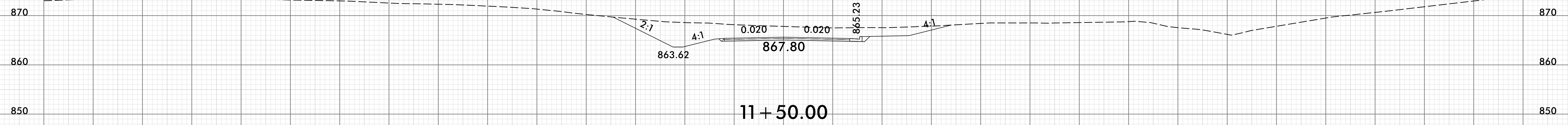
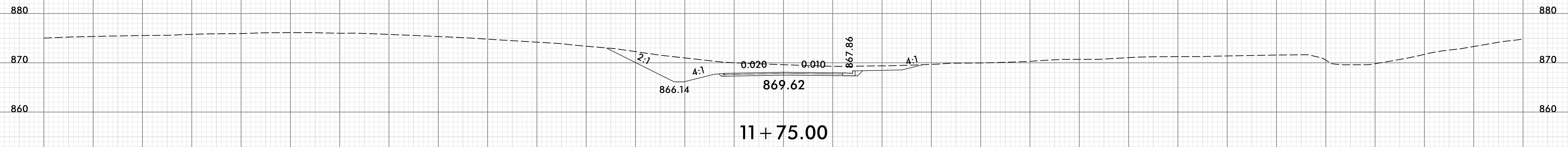
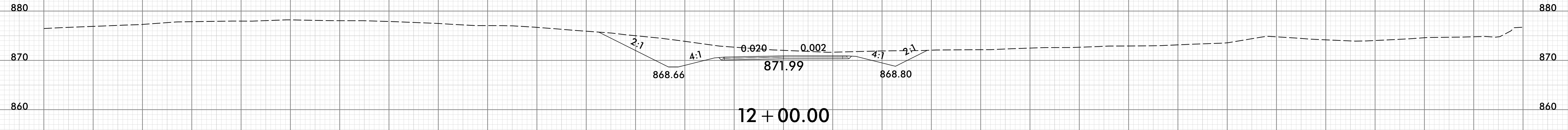

-Y13-

150 140 130 120 110 100 90 80 70 60 50 40 30 20 10 0 10 20 30 40 50 60 70 80 90 100 110 120 130 140 150

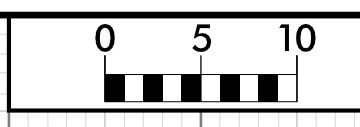

150 140 130 120 110 100 90 80 70 60 50 40 30 20 10 0 10 20 30 40 50 60 70 80 90 100 110 120 130 140 150

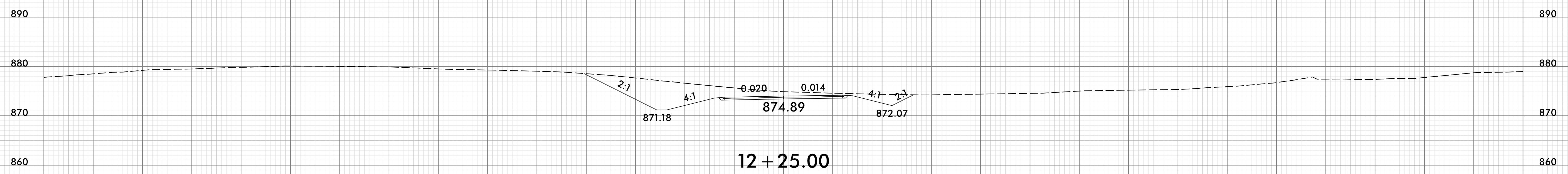
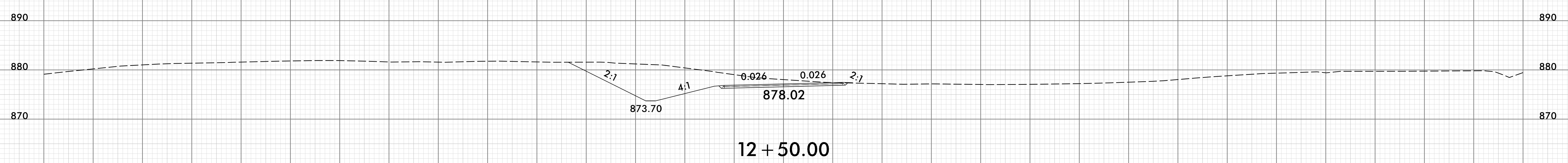
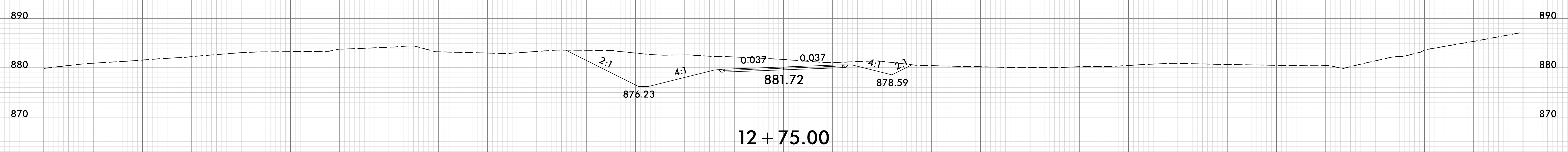
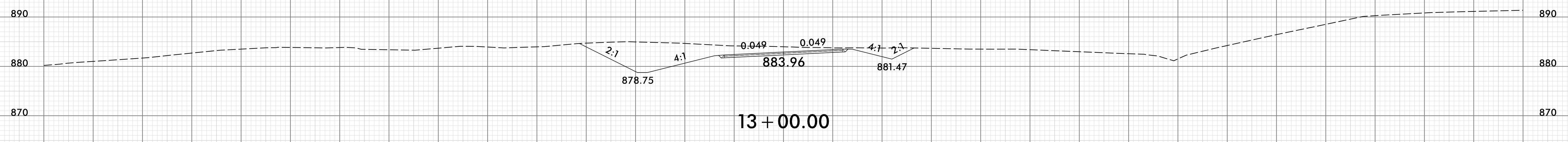

-Y13-

150 140 130 120 110 100 90 80 70 60 50 40 30 20 10 0 10 20 30 40 50 60 70 80 90 100 110 120 130 140 150

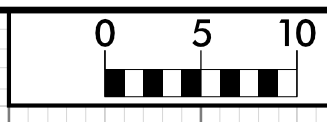

150 140 130 120 110 100 90 80 70 60 50 40 30 20 10 0 10 20 30 40 50 60 70 80 90 100 110 120 130 140 150

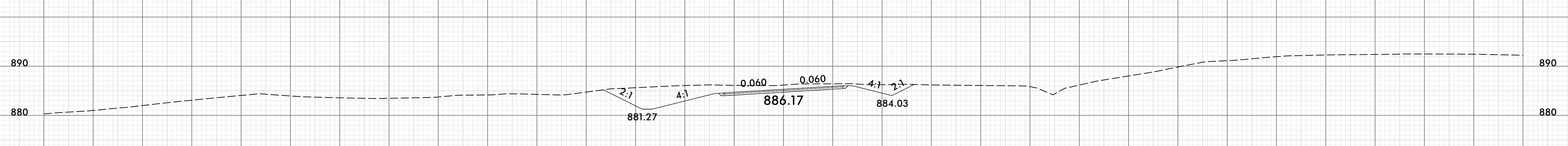
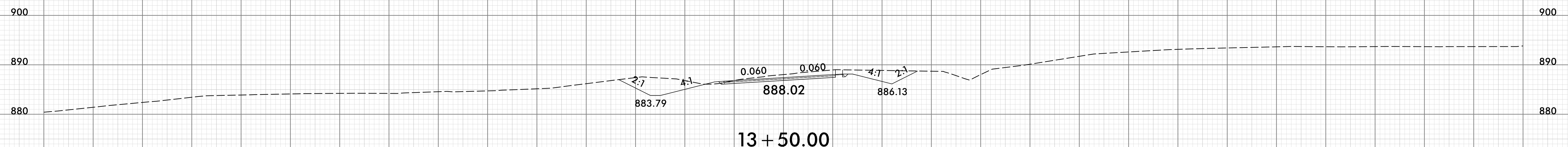
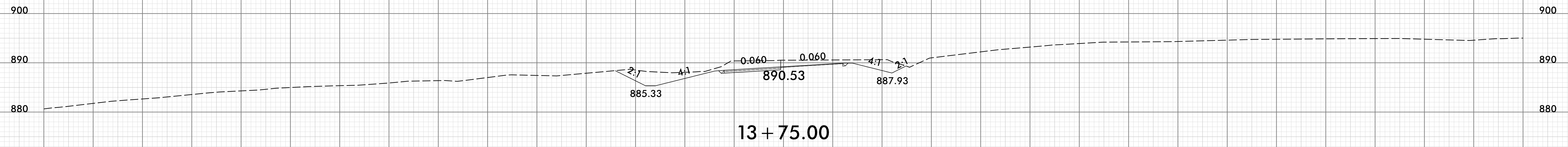
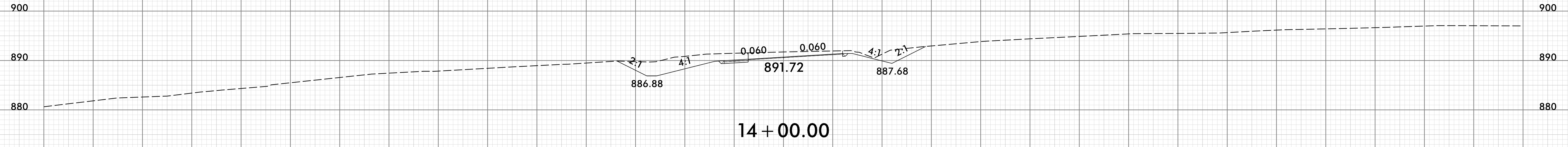

-Y13-

150 140 130 120 110 100 90 80 70 60 50 40 30 20 10 0 10 20 30 40 50 60 70 80 90 100 110 120 130 140 150

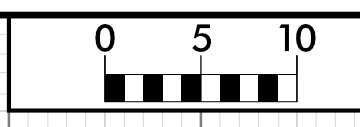

150 140 130 120 110 100 90 80 70 60 50 40 30 20 10 0 10 20 30 40 50 60 70 80 90 100 110 120 130 140 150

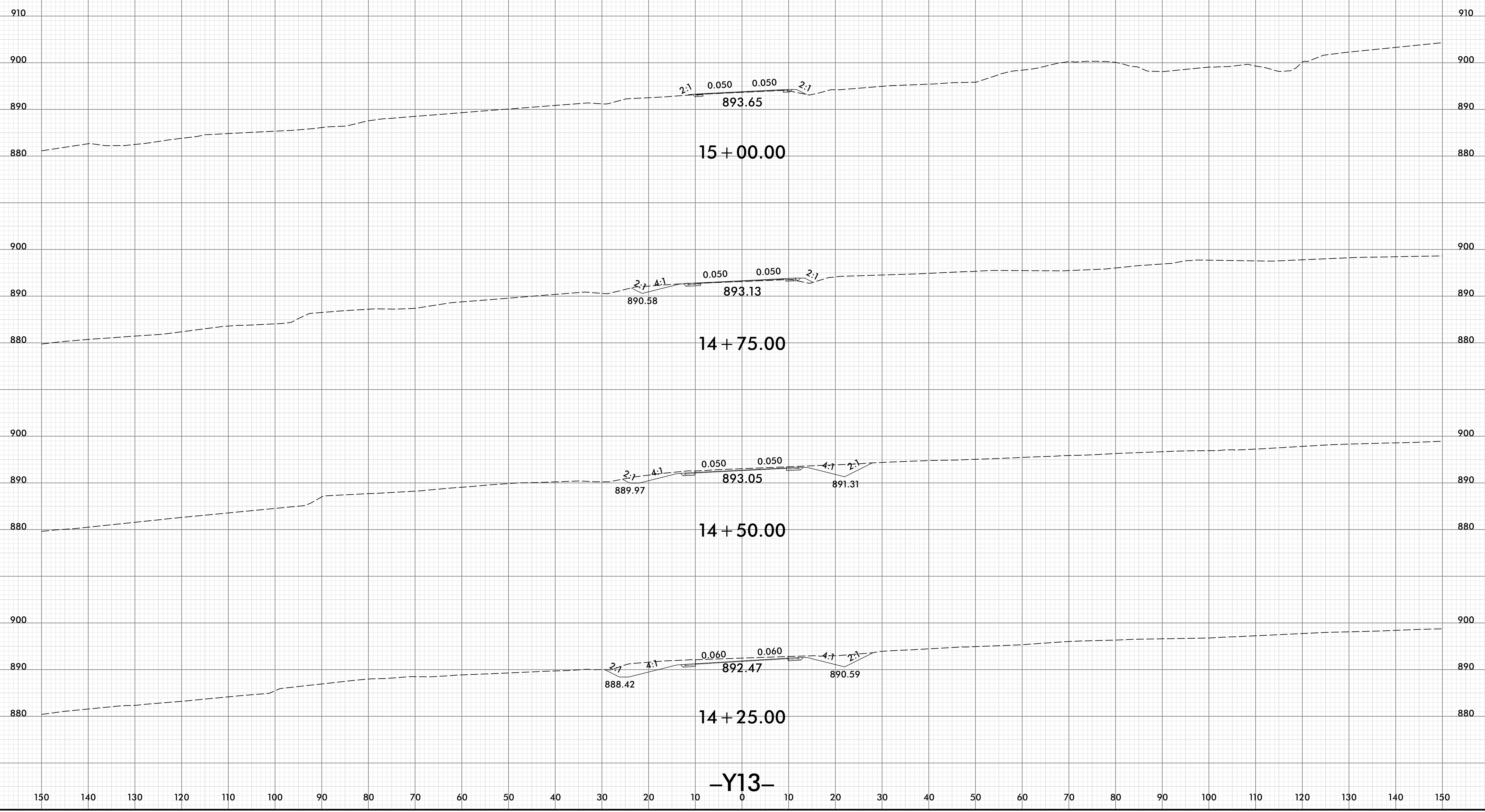

-Y13-



150 140 130 120 110 100 90 80 70 60 50 40 30 20 10 0 10 20 30 40 50 60 70 80 90 100 110 120 130 140 150

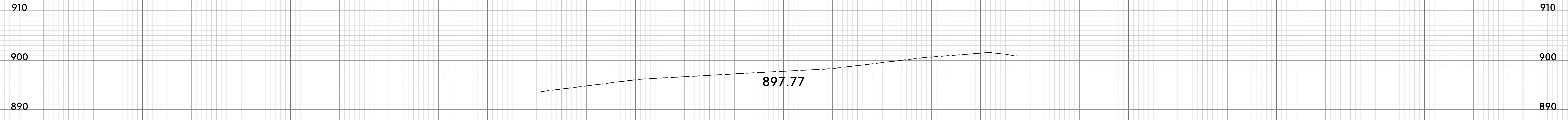

16 + 00.00

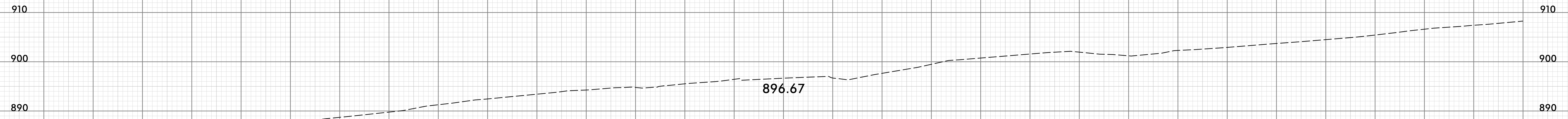

15 + 75.00

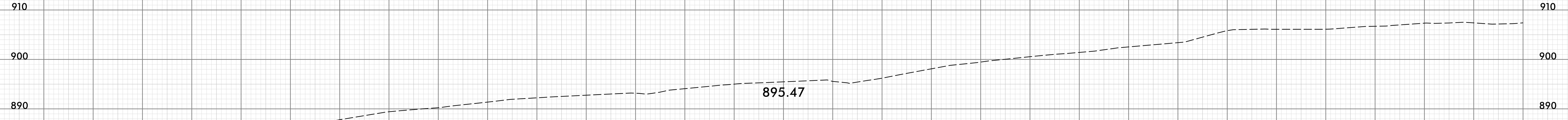

15 + 50.00

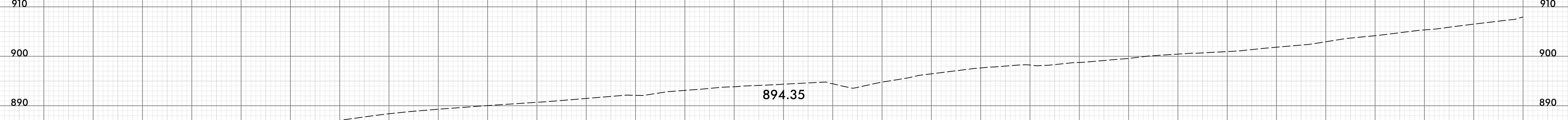

15 + 25.00

-Y13-

150 140 130 120 110 100 90 80 70 60 50 40 30 20 10 0 10 20 30 40 50 60 70 80 90 100 110 120 130 140 150

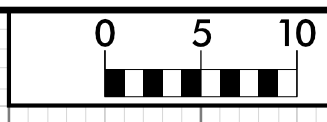

150 140 130 120 110 100 90 80 70 60 50 40 30 20 10 0 10 20 30 40 50 60 70 80 90 100 110 120 130 140 150

880 880

870 870

860 860

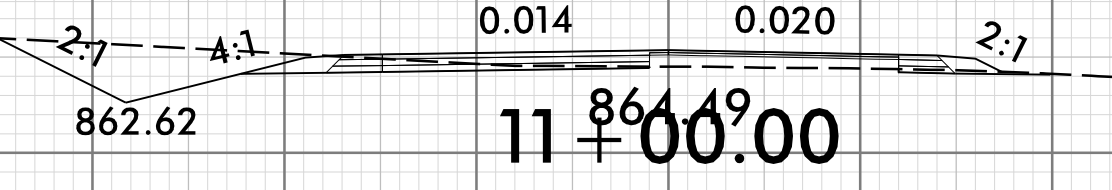

11 + 00.00

870 870

860 860



10 + 75.00

870 870

860 860

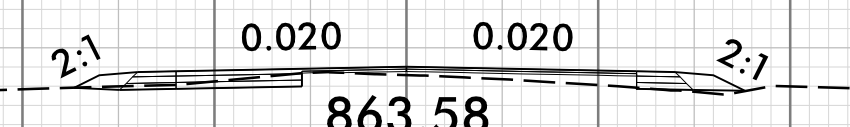

10 + 50.00

870 870

860 860

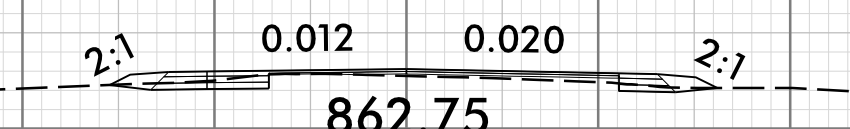

10 + 25.00

850 850

860 860

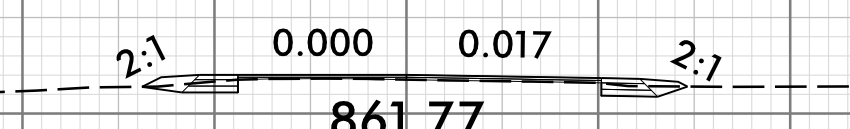

10 + 00.00

-Y14-

150 140 130 120 110 100 90 80 70 60 50 40 30 20 10 0 10 20 30 40 50 60 70 80 90 100 110 120 130 140 150

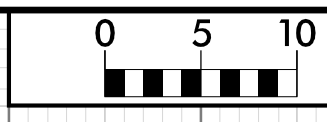

150 140 130 120 110 100 90 80 70 60 50 40 30 20 10 0 10 20 30 40 50 60 70 80 90 100 110 120 130 140 150

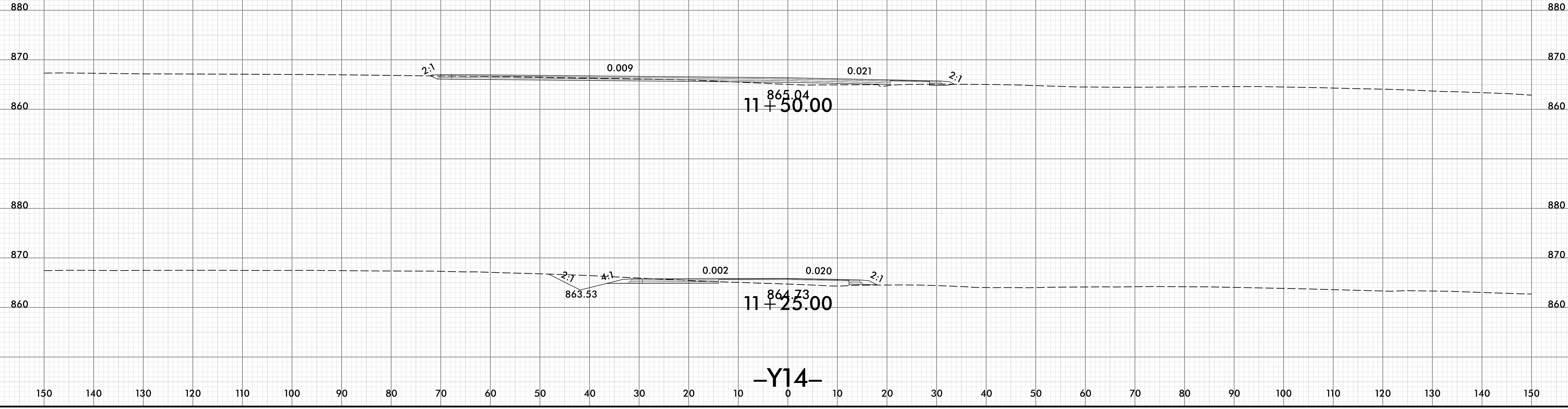

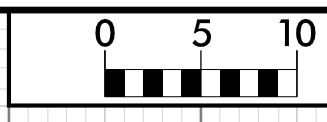

150 140 130 120 110 100 90 80 70 60 50 40 30 20 10 0 10 20 30 40 50 60 70 80 90 100 110 120 130 140 150

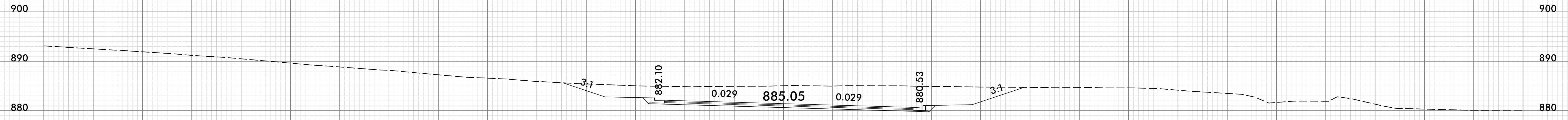

10 + 75.00

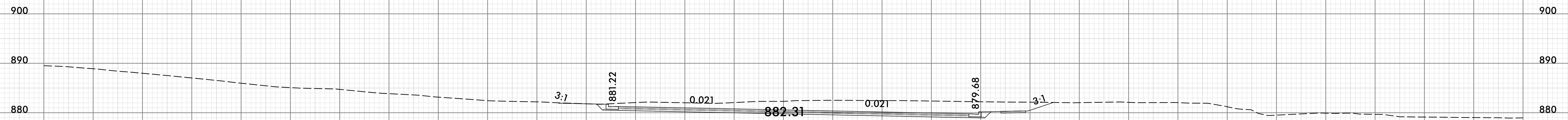

10 + 50.00

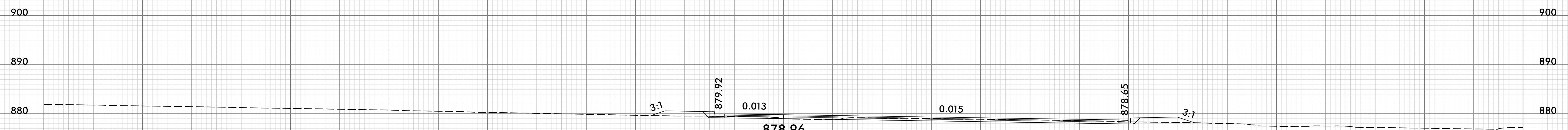

10 + 25.00

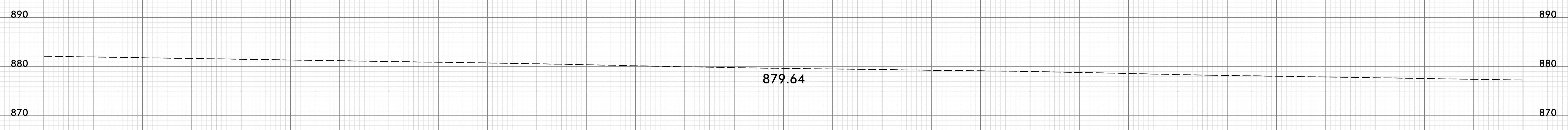

10 + 00.00

-Y17-

150 140 130 120 110 100 90 80 70 60 50 40 30 20 10 0 10 20 30 40 50 60 70 80 90 100 110 120 130 140 150





150 140 130 120 110 100 90 80 70 60 50 40 30 20 10 0 10 20 30 40 50 60 70 80 90 100 110 120 130 140 150

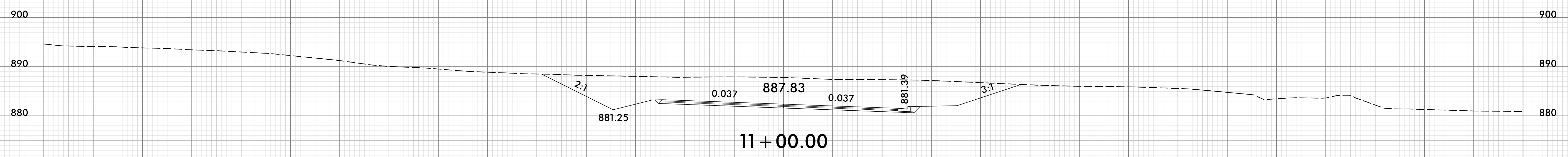
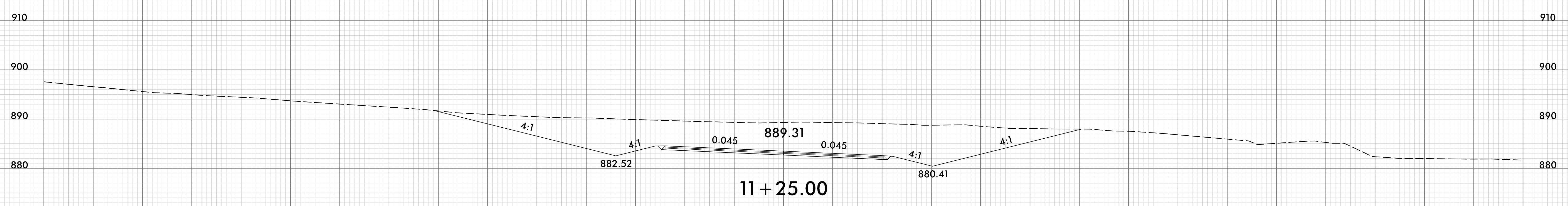
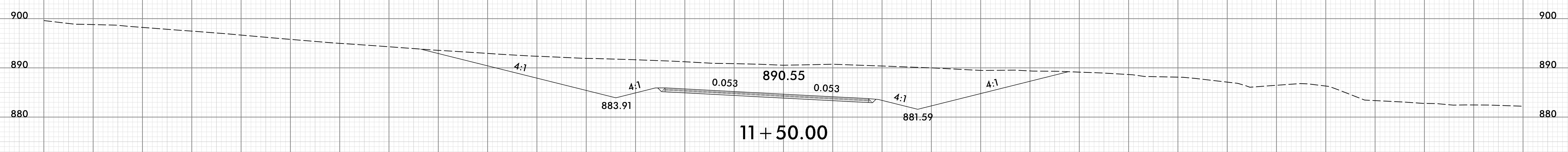
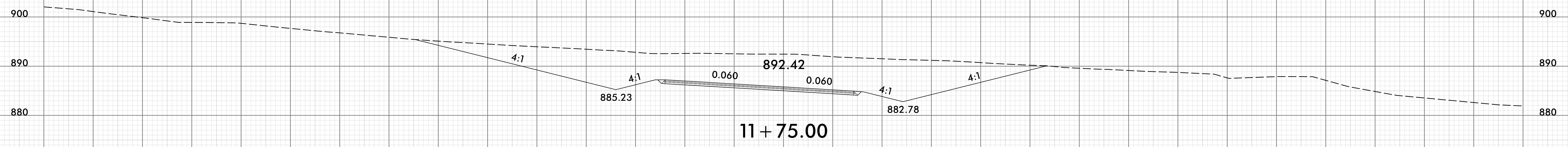

-Y17-

150 140 130 120 110 100 90 80 70 60 50 40 30 20 10 0 10 20 30 40 50 60 70 80 90 100 110 120 130 140 150

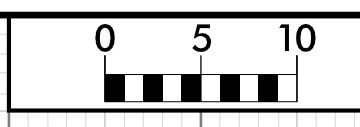

150 140 130 120 110 100 90 80 70 60 50 40 30 20 10 0 10 20 30 40 50 60 70 80 90 100 110 120 130 140 150

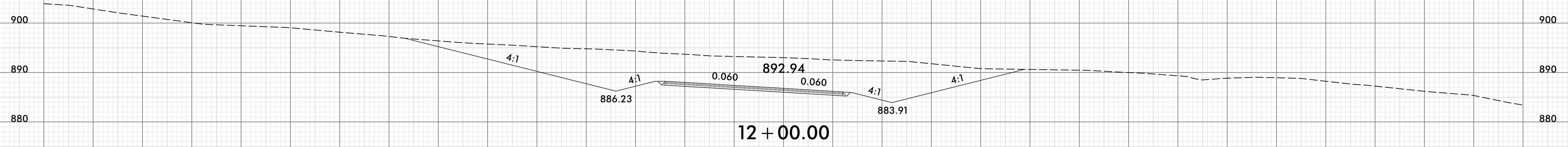
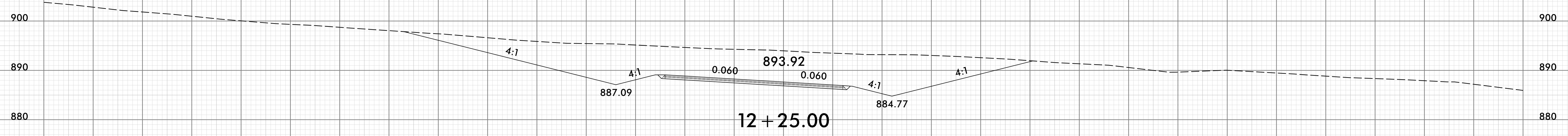
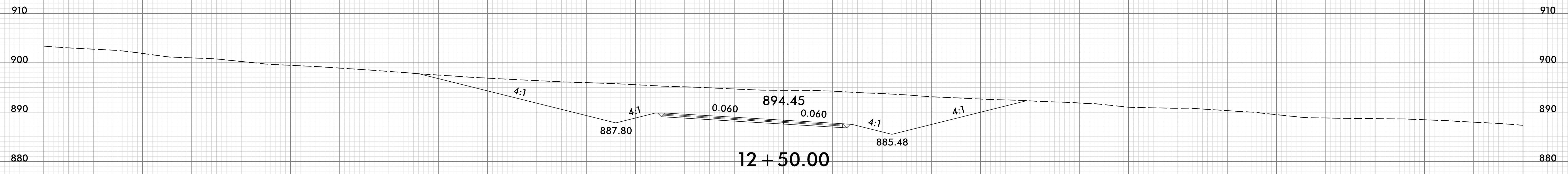
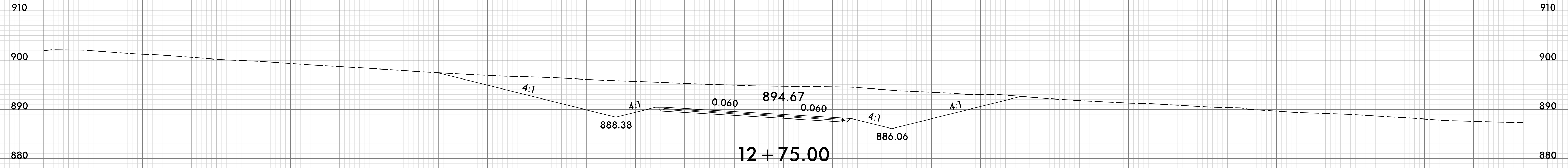

-Y17-

150 140 130 120 110 100 90 80 70 60 50 40 30 20 10 0 10 20 30 40 50 60 70 80 90 100 110 120 130 140 150

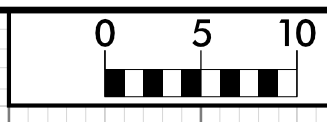

150 140 130 120 110 100 90 80 70 60 50 40 30 20 10 0 10 20 30 40 50 60 70 80 90 100 110 120 130 140 150

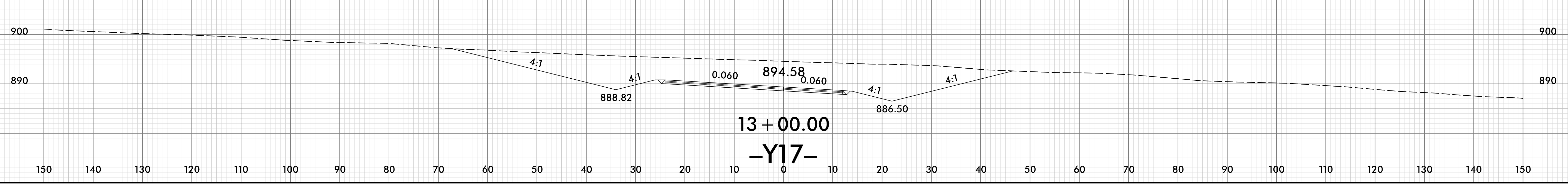
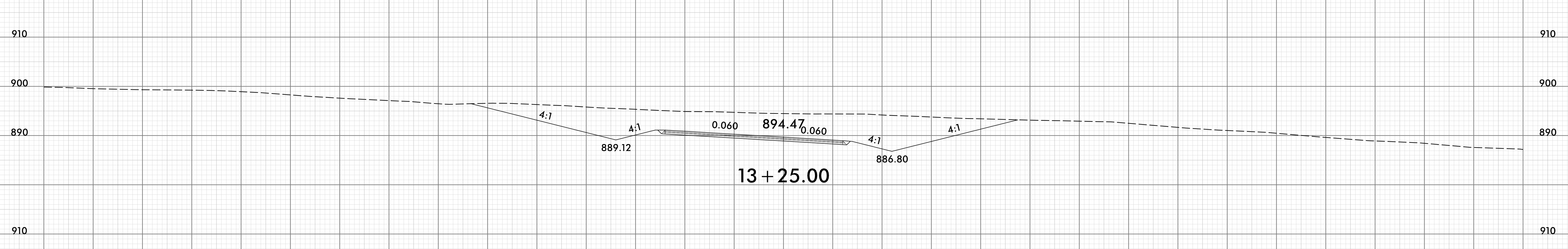
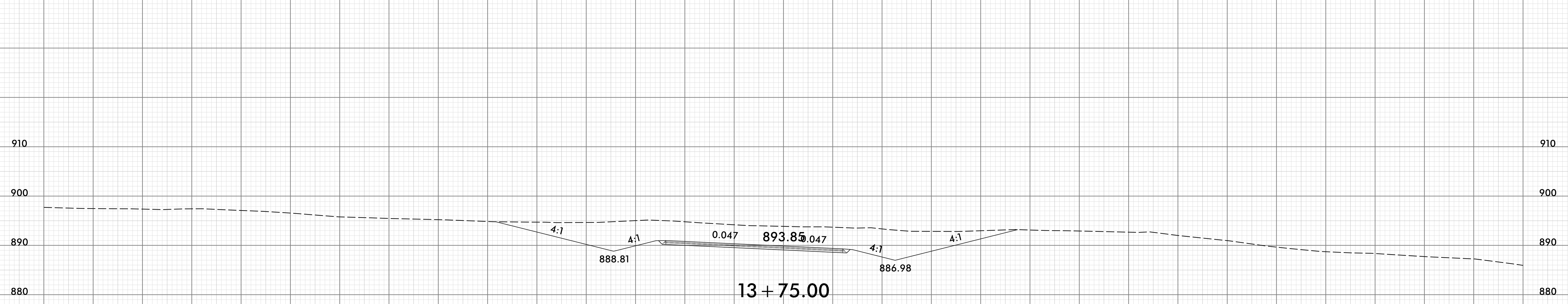

-Y17-

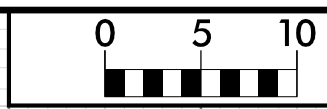

150 140 130 120 110 100 90 80 70 60 50 40 30 20 10 0 10 20 30 40 50 60 70 80 90 100 110 120 130 140 150

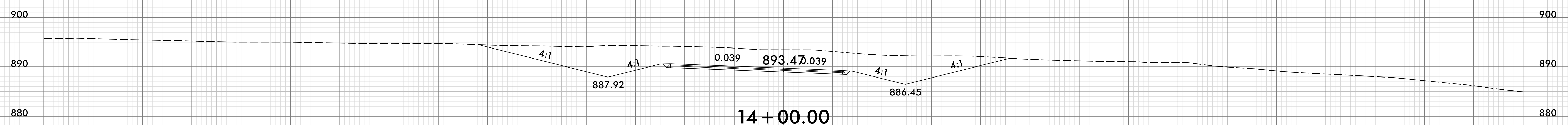
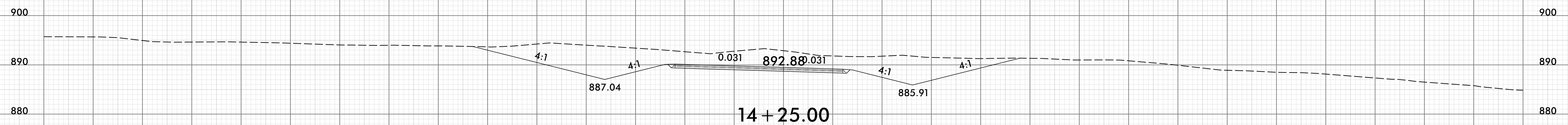
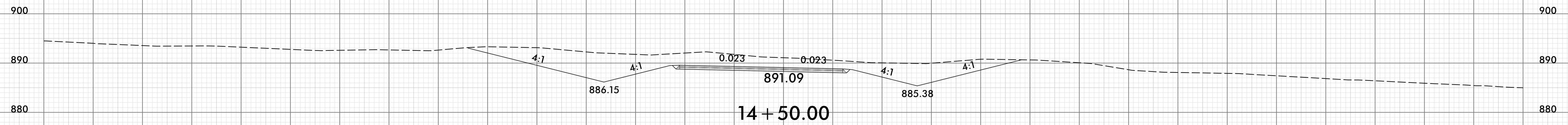
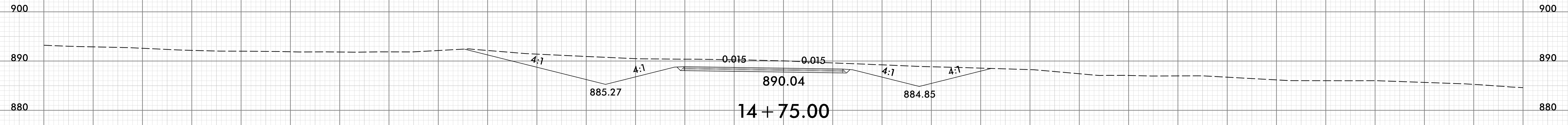

-Y17-

150 140 130 120 110 100 90 80 70 60 50 40 30 20 10 0 10 20 30 40 50 60 70 80 90 100 110 120 130 140 150



150 140 130 120 110 100 90 80 70 60 50 40 30 20 10 0 10 20 30 40 50 60 70 80 90 100 110 120 130 140 150

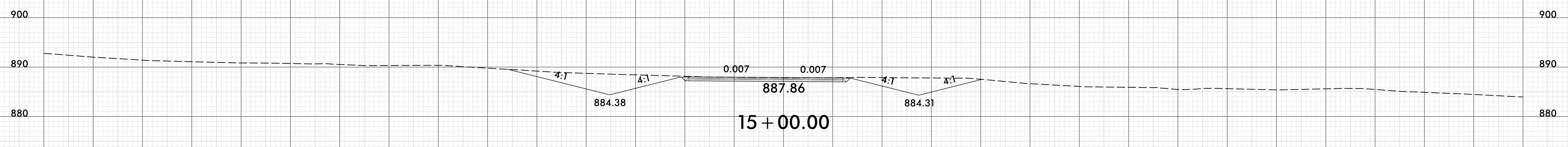
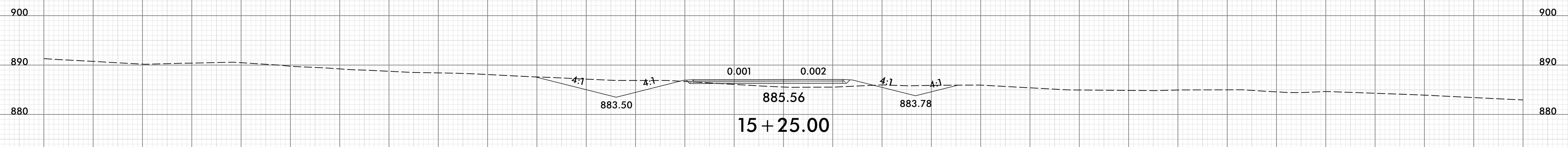
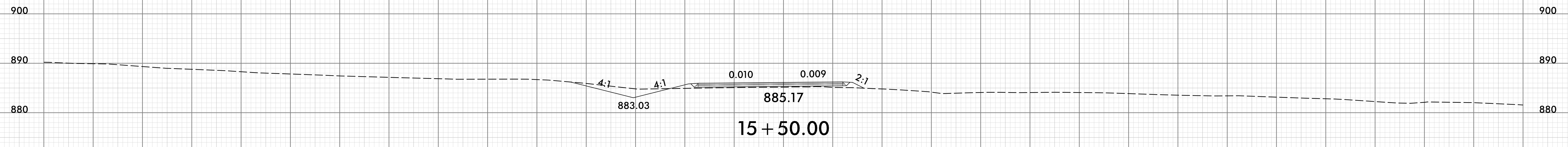
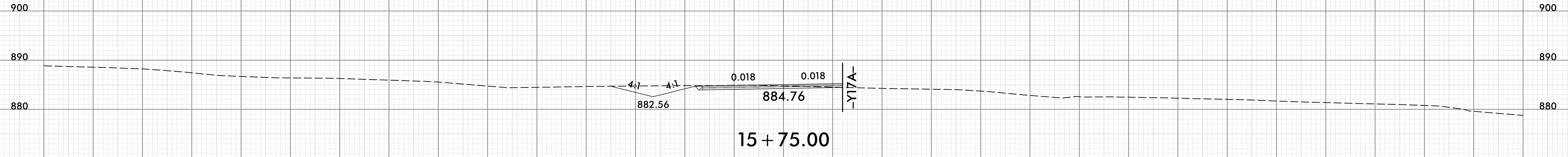

-Y17-

150 140 130 120 110 100 90 80 70 60 50 40 30 20 10 0 10 20 30 40 50 60 70 80 90 100 110 120 130 140 150

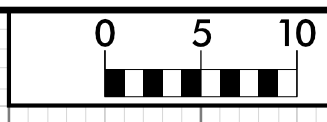

150 140 130 120 110 100 90 80 70 60 50 40 30 20 10 0 10 20 30 40 50 60 70 80 90 100 110 120 130 140 150

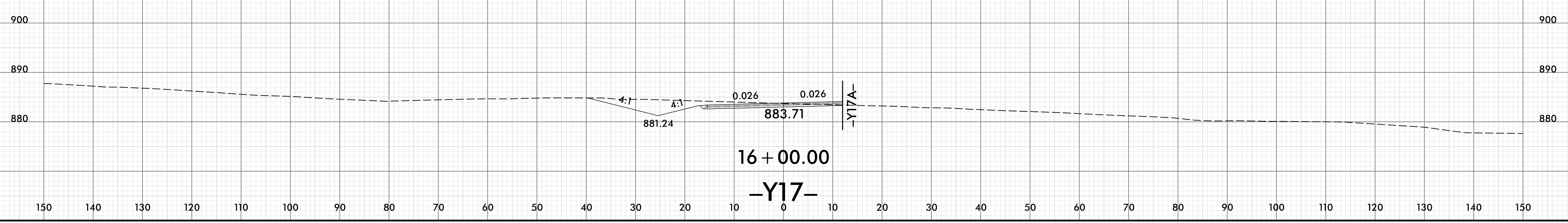
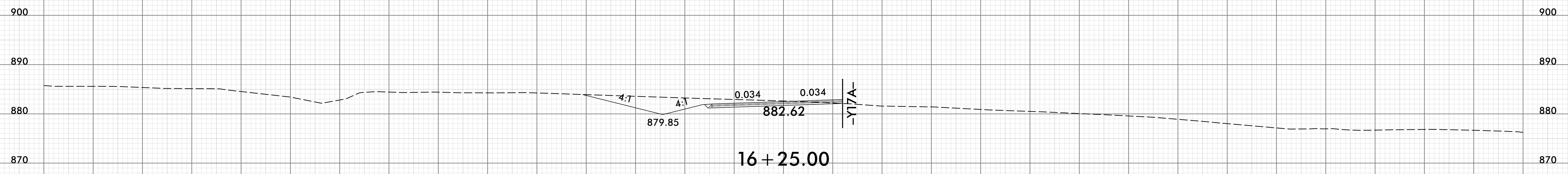
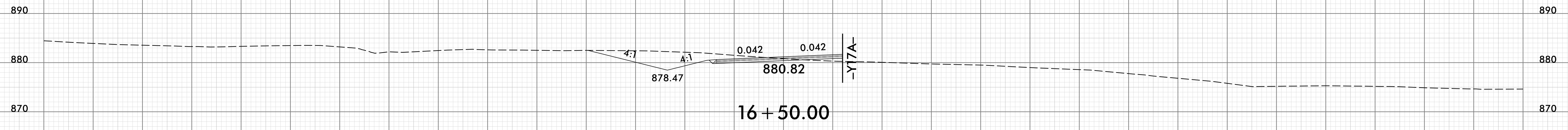
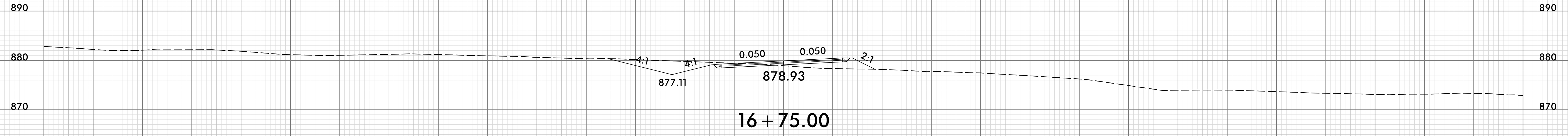

150 140 130 120 110 100 90 80 70 60 50 40 30 20 10 0 10 20 30 40 50 60 70 80 90 100 110 120 130 140 150

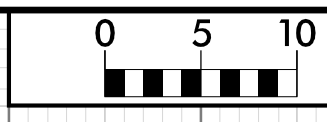

150 140 130 120 110 100 90 80 70 60 50 40 30 20 10 0 10 20 30 40 50 60 70 80 90 100 110 120 130 140 150

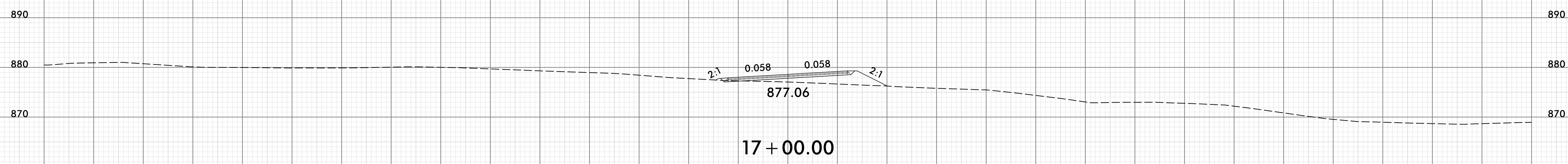
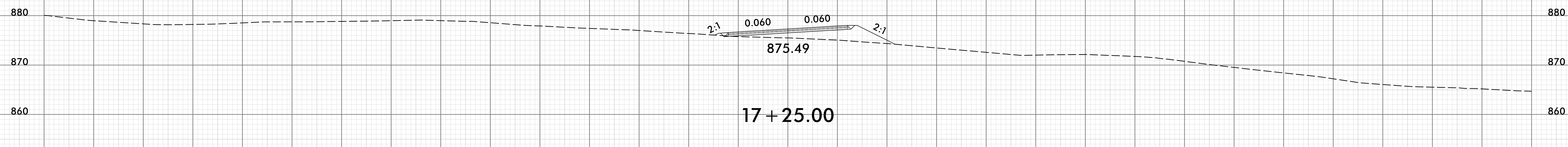
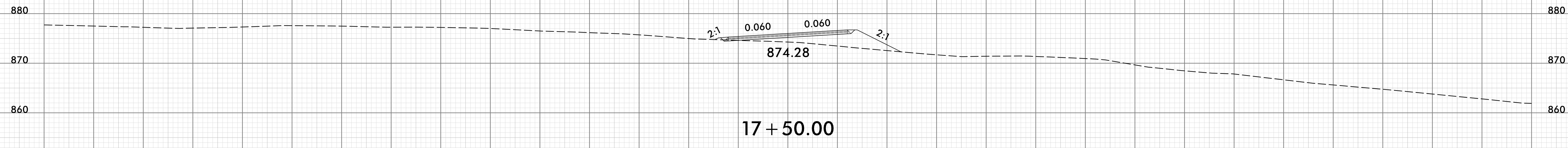
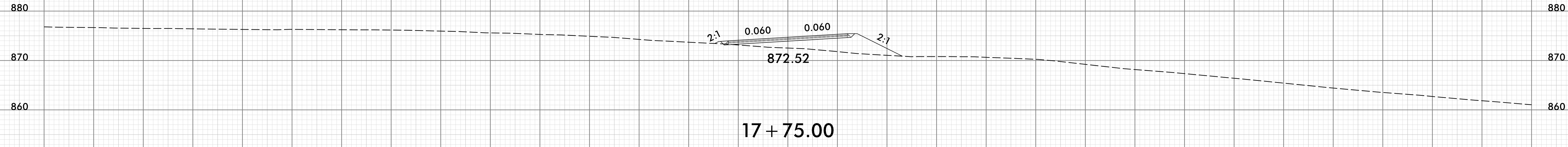

-Y17-

150 140 130 120 110 100 90 80 70 60 50 40 30 20 10 0 10 20 30 40 50 60 70 80 90 100 110 120 130 140 150

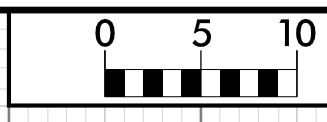

150 140 130 120 110 100 90 80 70 60 50 40 30 20 10 0 10 20 30 40 50 60 70 80 90 100 110 120 130 140 150

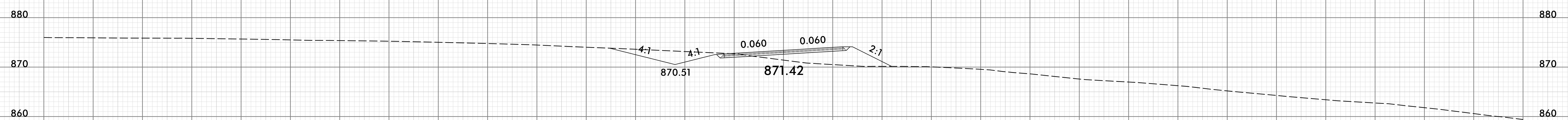
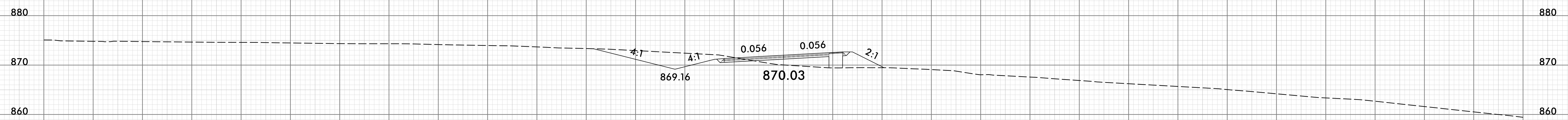
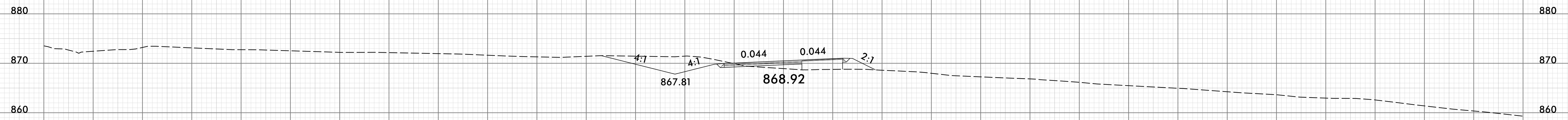
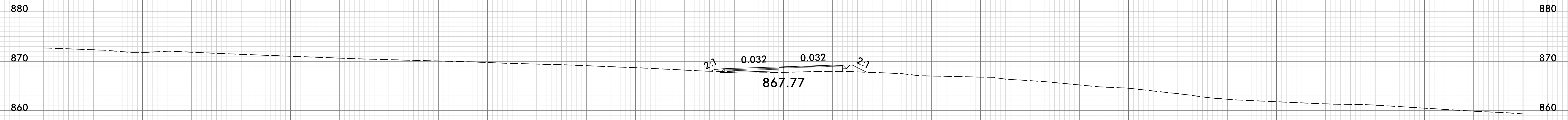

-Y17-

150 140 130 120 110 100 90 80 70 60 50 40 30 20 10 0 10 20 30 40 50 60 70 80 90 100 110 120 130 140 150



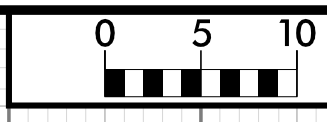

150 140 130 120 110 100 90 80 70 60 50 40 30 20 10 0 10 20 30 40 50 60 70 80 90 100 110 120 130 140 150

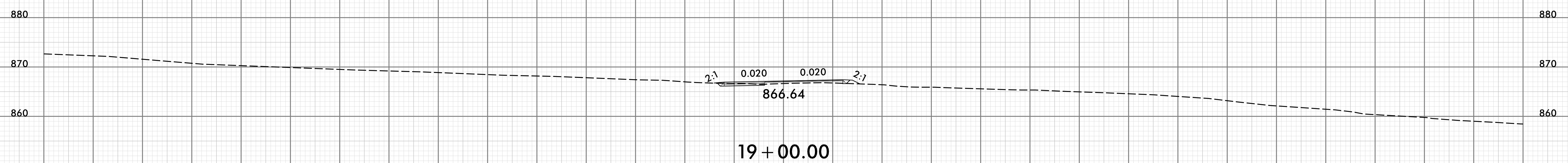
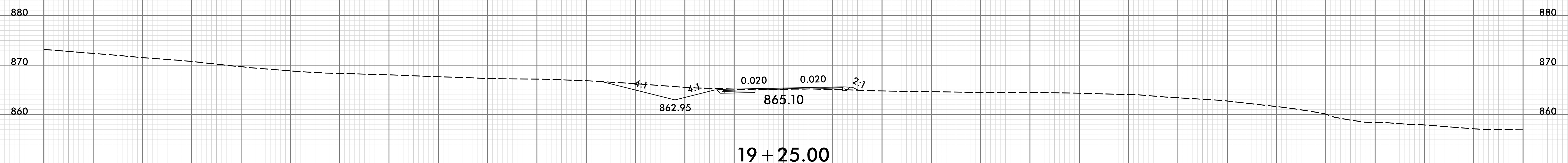
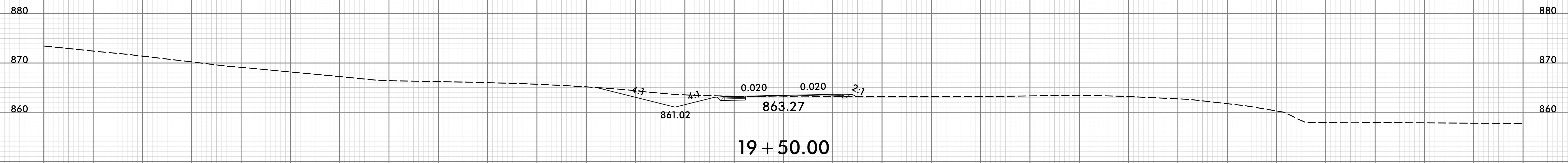
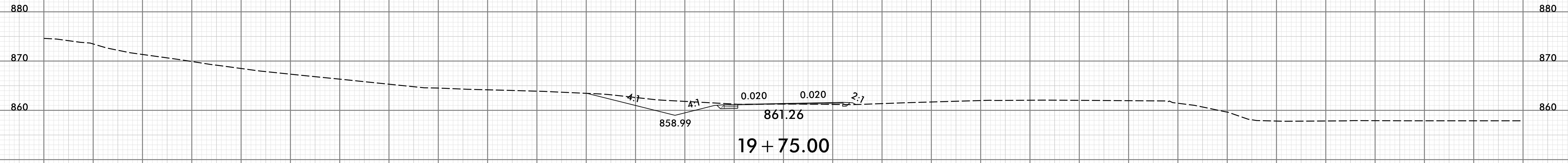

150 140 130 120 110 100 90 80 70 60 50 40 30 20 10 0 10 20 30 40 50 60 70 80 90 100 110 120 130 140 150

-Y17-

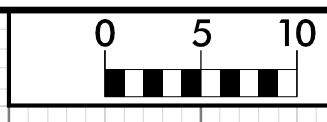

150 140 130 120 110 100 90 80 70 60 50 40 30 20 10 0 10 20 30 40 50 60 70 80 90 100 110 120 130 140 150

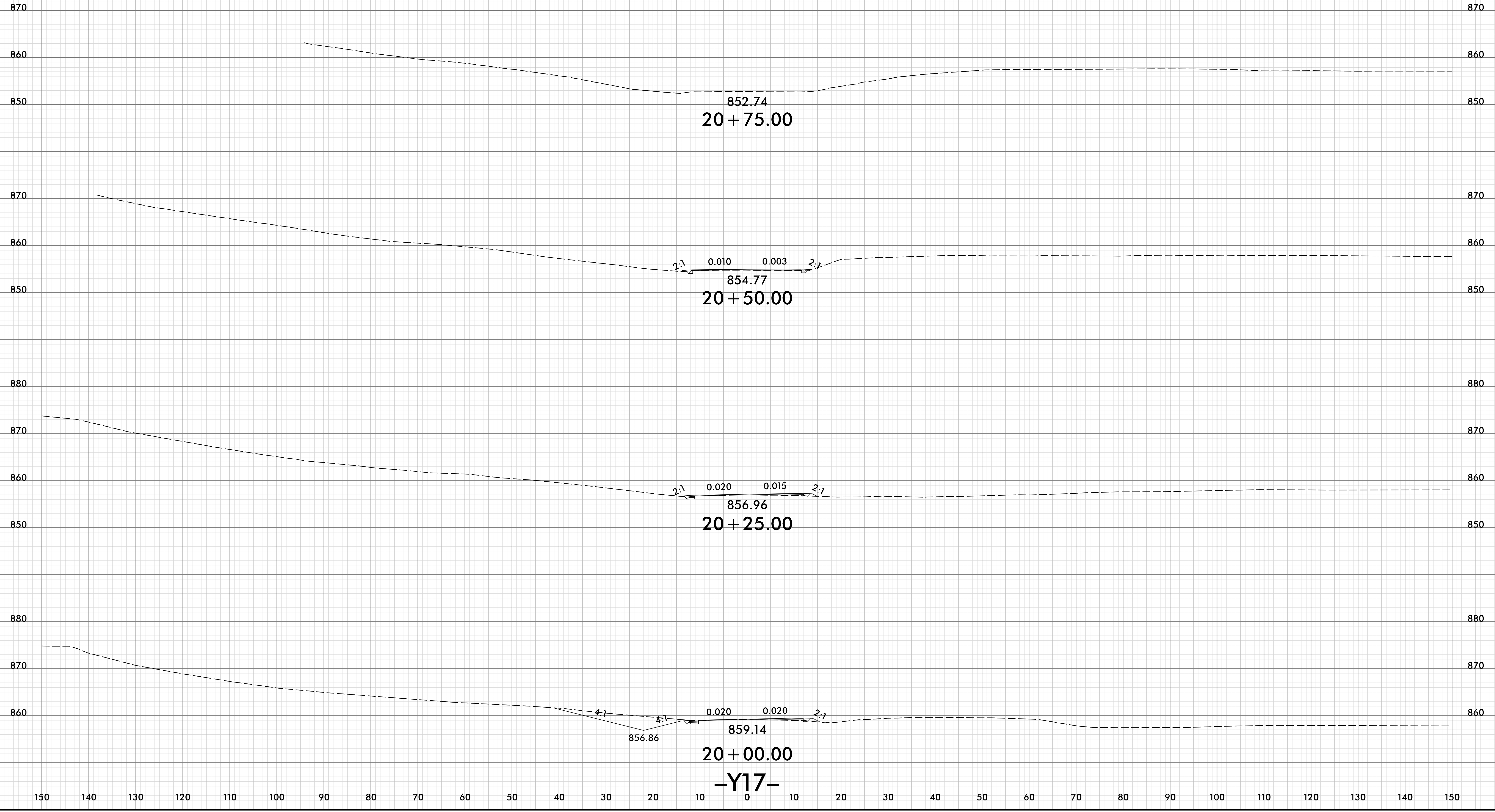

150 140 130 120 110 100 90 80 70 60 50 40 30 20 10 0 10 20 30 40 50 60 70 80 90 100 110 120 130 140 150

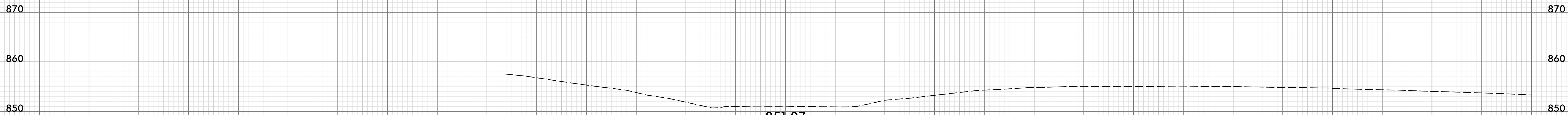

851.07  
21+00.00

-Y17-

150 140 130 120 110 100 90 80 70 60 50 40 30 20 10 0 10 20 30 40 50 60 70 80 90 100 110 120 130 140 150

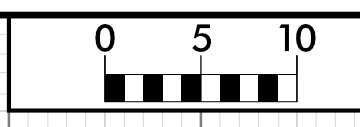

150 140 130 120 110 100 90 80 70 60 50 40 30 20 10 0 10 20 30 40 50 60 70 80 90 100 110 120 130 140 150

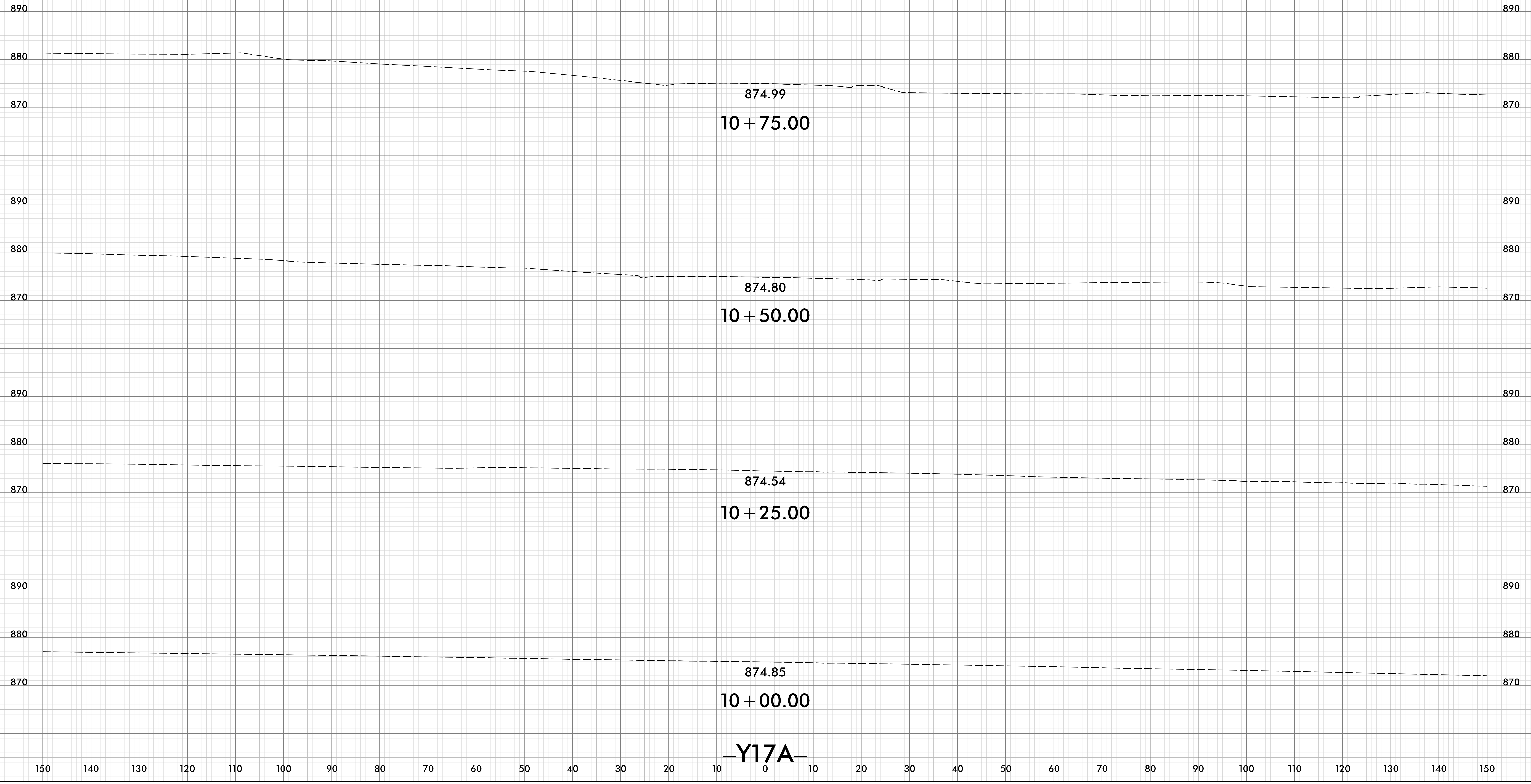

-Y17A-



150 140 130 120 110 100 90 80 70 60 50 40 30 20 10 0 10 20 30 40 50 60 70 80 90 100 110 120 130 140 150

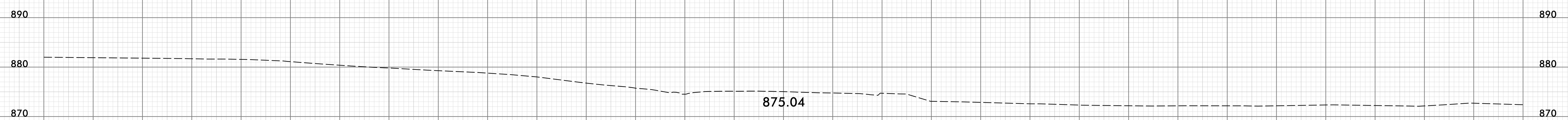
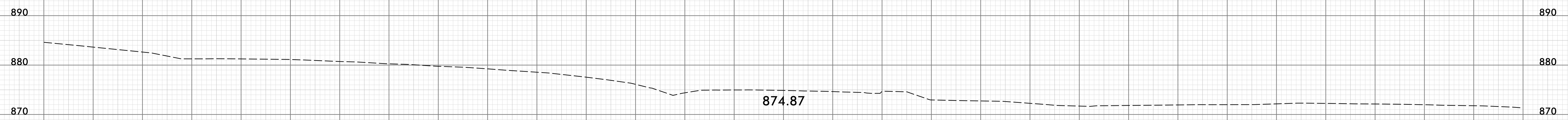
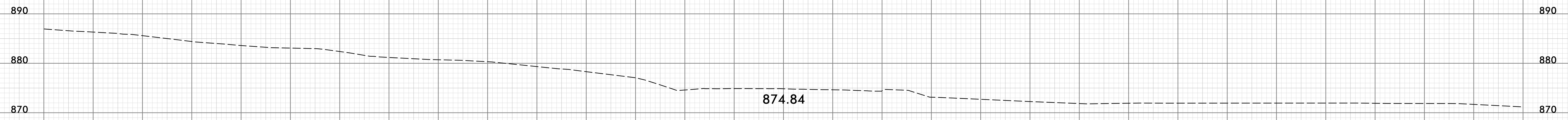
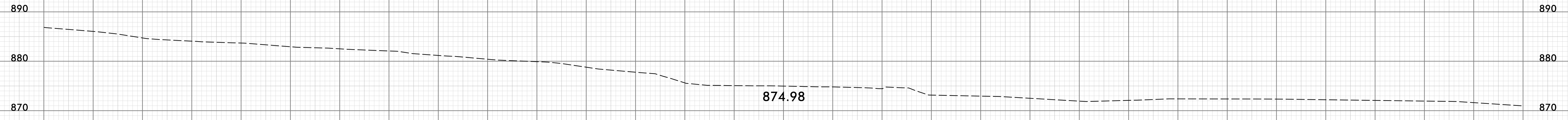

-Y17A-

150 140 130 120 110 100 90 80 70 60 50 40 30 20 10 0 10 20 30 40 50 60 70 80 90 100 110 120 130 140 150

150 140 130 120 110 100 90 80 70 60 50 40 30 20 10 0 10 20 30 40 50 60 70 80 90 100 110 120 130 140 150

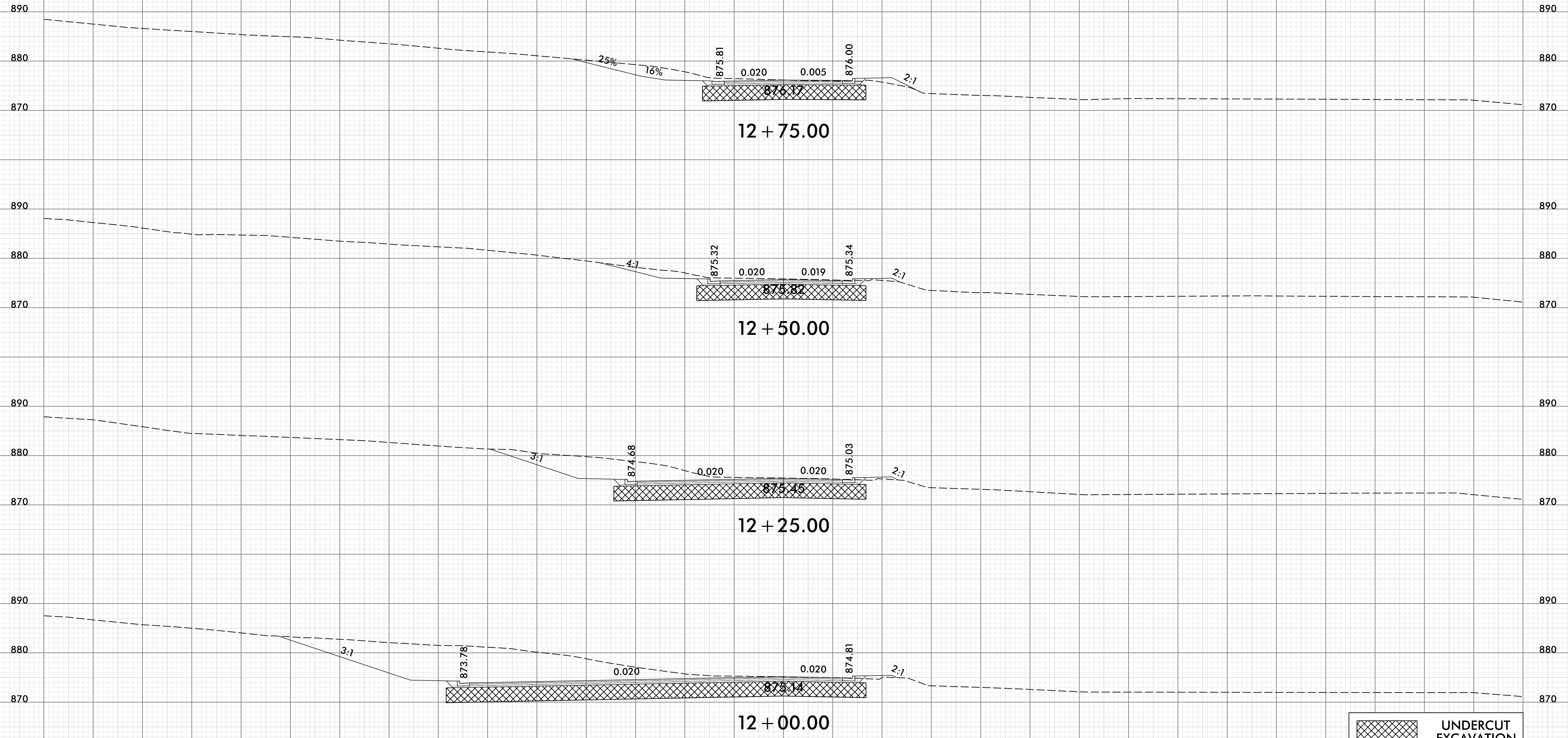

12 + 00.00

-Y17A-

[Cross-hatched Box] UNDERCUT EXCAVATION

150 140 130 120 110 100 90 80 70 60 50 40 30 20 10 0 10 20 30 40 50 60 70 80 90 100 110 120 130 140 150

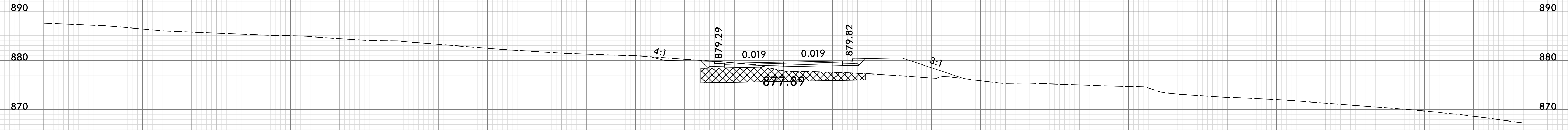

13 + 75.00

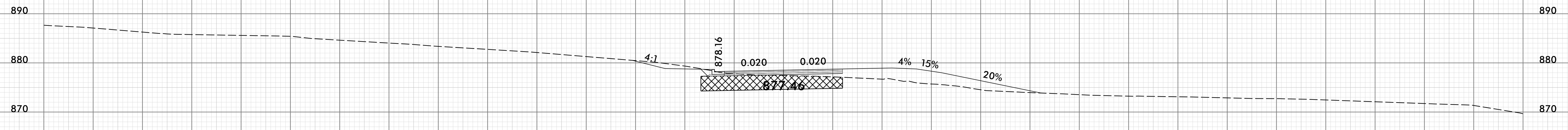

13 + 50.00

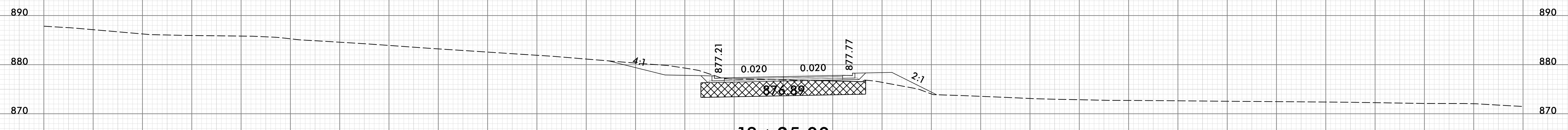

13 + 25.00

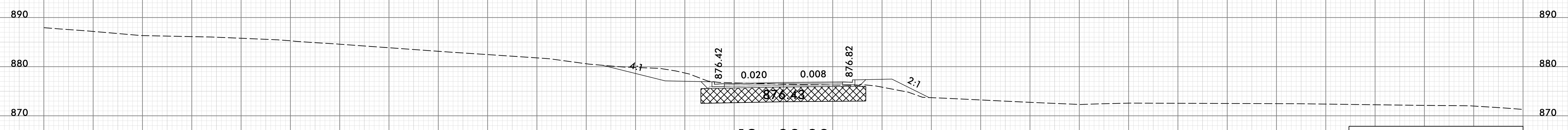

13 + 00.00

-Y17A-

UNDERCUT EXCAVATION

150 140 130 120 110 100 90 80 70 60 50 40 30 20 10 0 10 20 30 40 50 60 70 80 90 100 110 120 130 140 150

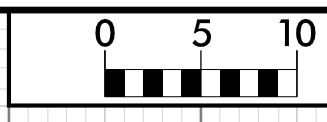

150 140 130 120 110 100 90 80 70 60 50 40 30 20 10 0 10 20 30 40 50 60 70 80 90 100 110 120 130 140 150

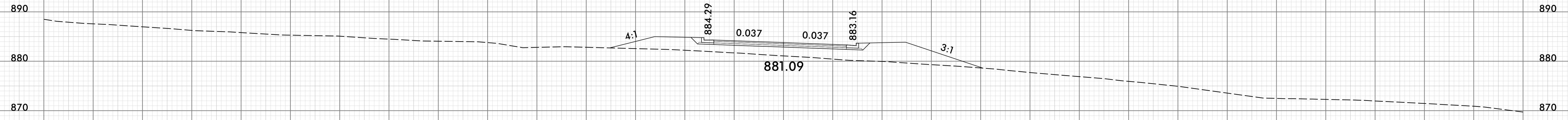

14 + 75.00

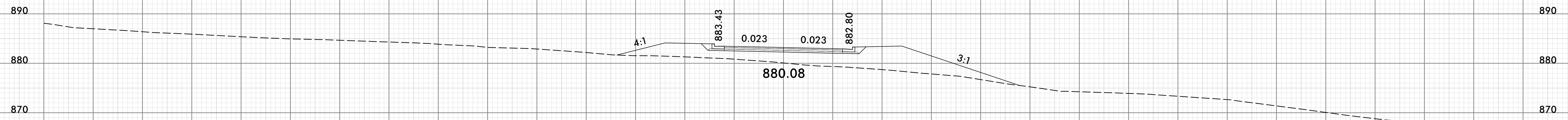

14 + 50.00

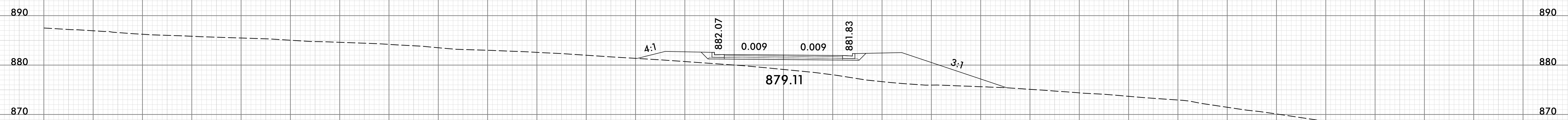

14 + 25.00

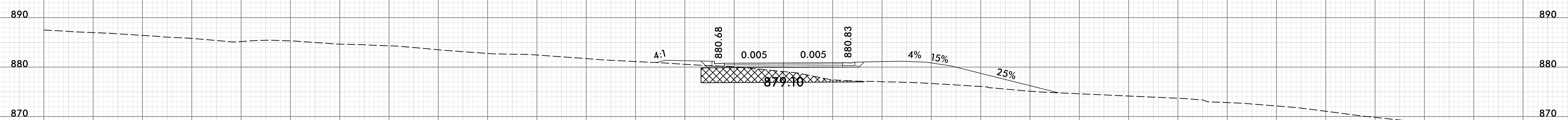

14 + 00.00

-Y17A-

UNDERCUT EXCAVATION

150 140 130 120 110 100 90 80 70 60 50 40 30 20 10 0 10 20 30 40 50 60 70 80 90 100 110 120 130 140 150



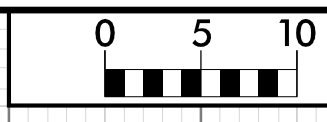

PROJ. REFERENCE NO.  
U-5813

SHEET NO.  
X-160

150 140 130 120 110 100 90 80 70 60 50 40 30 20 10 0 10 20 30 40 50 60 70 80 90 100 110 120 130 140 150

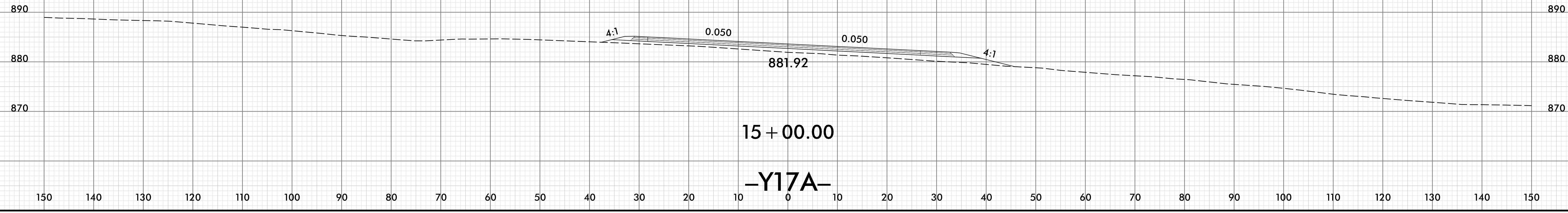

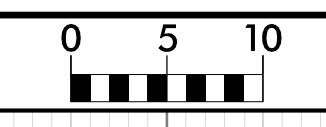

150 140 130 120 110 100 90 80 70 60 50 40 30 20 10 0 10 20 30 40 50 60 70 80 90 100 110 120 130 140 150

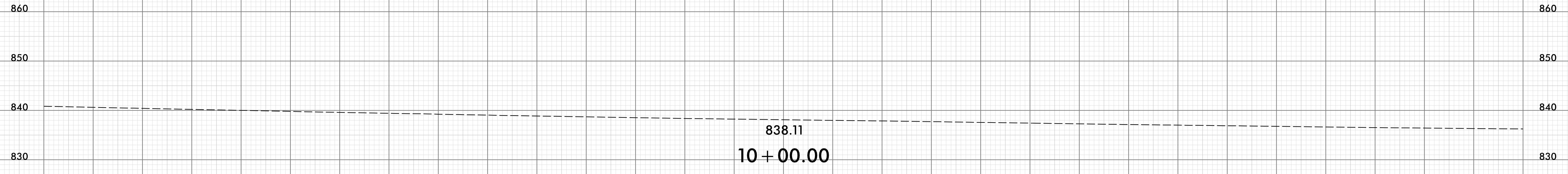
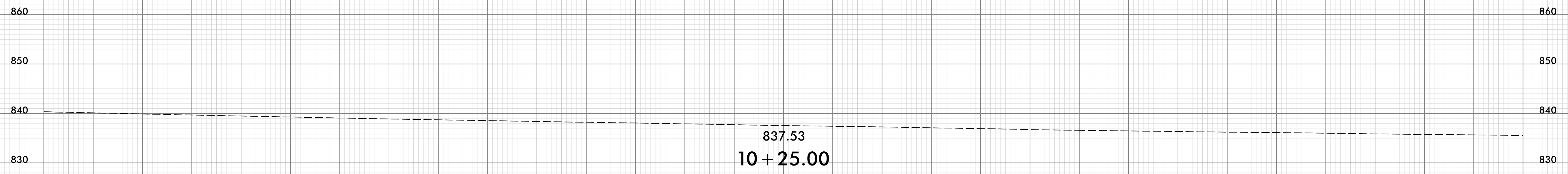
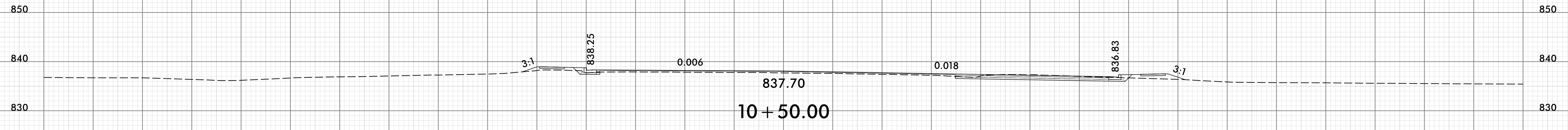
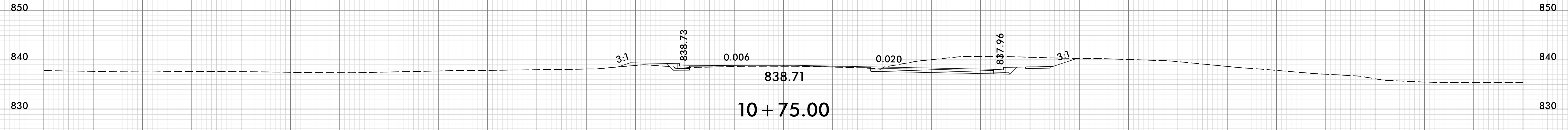

-Y18-

150 140 130 120 110 100 90 80 70 60 50 40 30 20 10 0 10 20 30 40 50 60 70 80 90 100 110 120 130 140 150

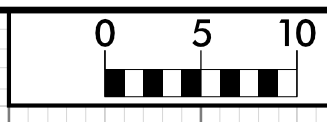

150 140 130 120 110 100 90 80 70 60 50 40 30 20 10 0 10 20 30 40 50 60 70 80 90 100 110 120 130 140 150

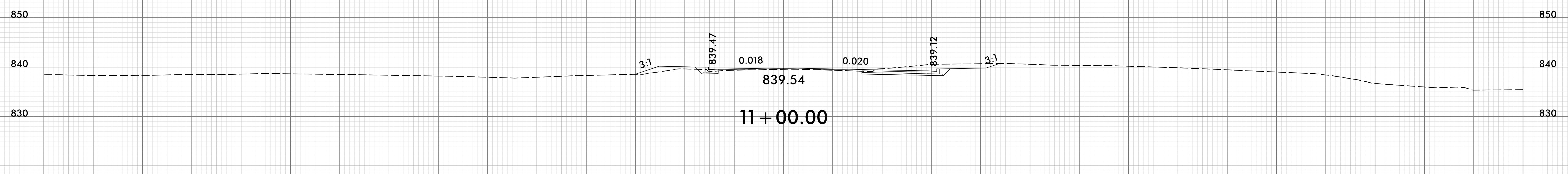
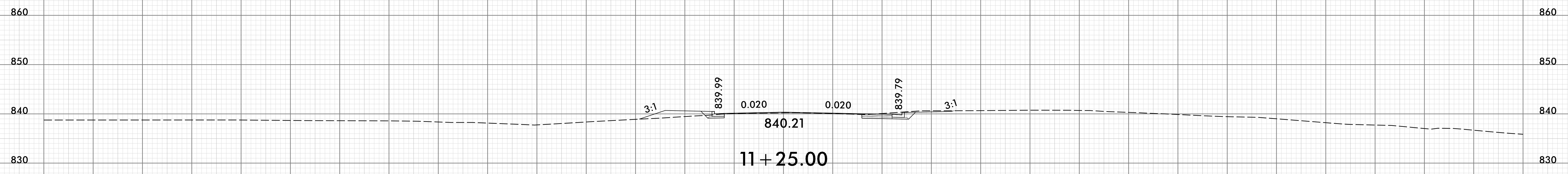
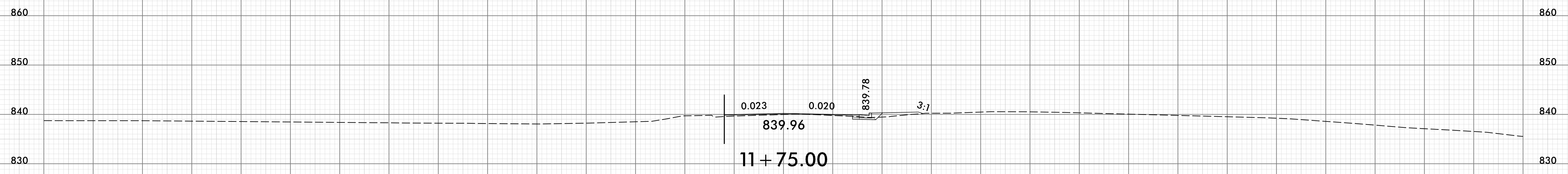

-Y18-

150 140 130 120 110 100 90 80 70 60 50 40 30 20 10 0 10 20 30 40 50 60 70 80 90 100 110 120 130 140 150

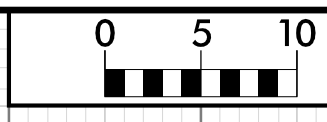

150 140 130 120 110 100 90 80 70 60 50 40 30 20 10 0 10 20 30 40 50 60 70 80 90 100 110 120 130 140 150

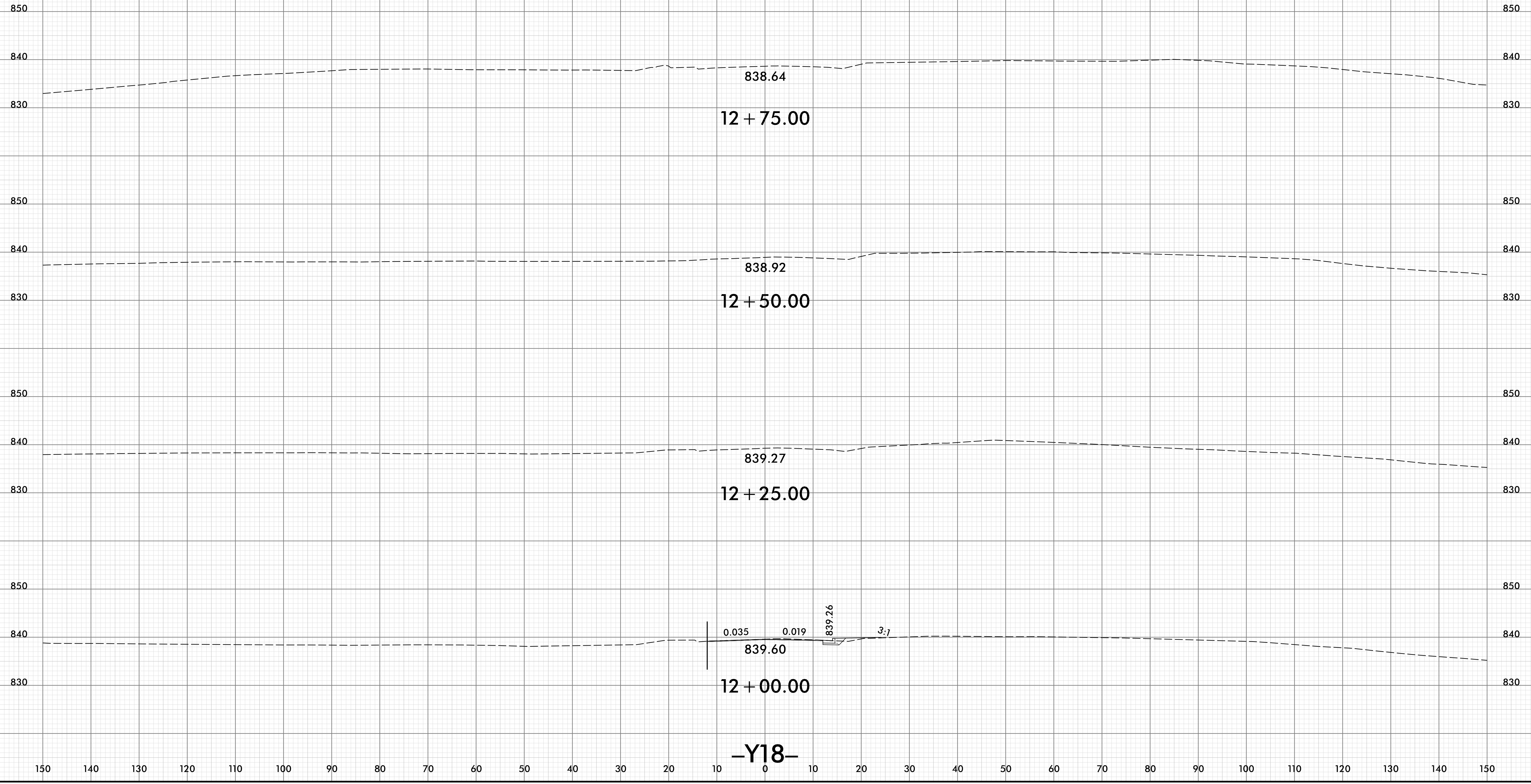

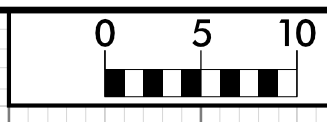

150 140 130 120 110 100 90 80 70 60 50 40 30 20 10 0 10 20 30 40 50 60 70 80 90 100 110 120 130 140 150

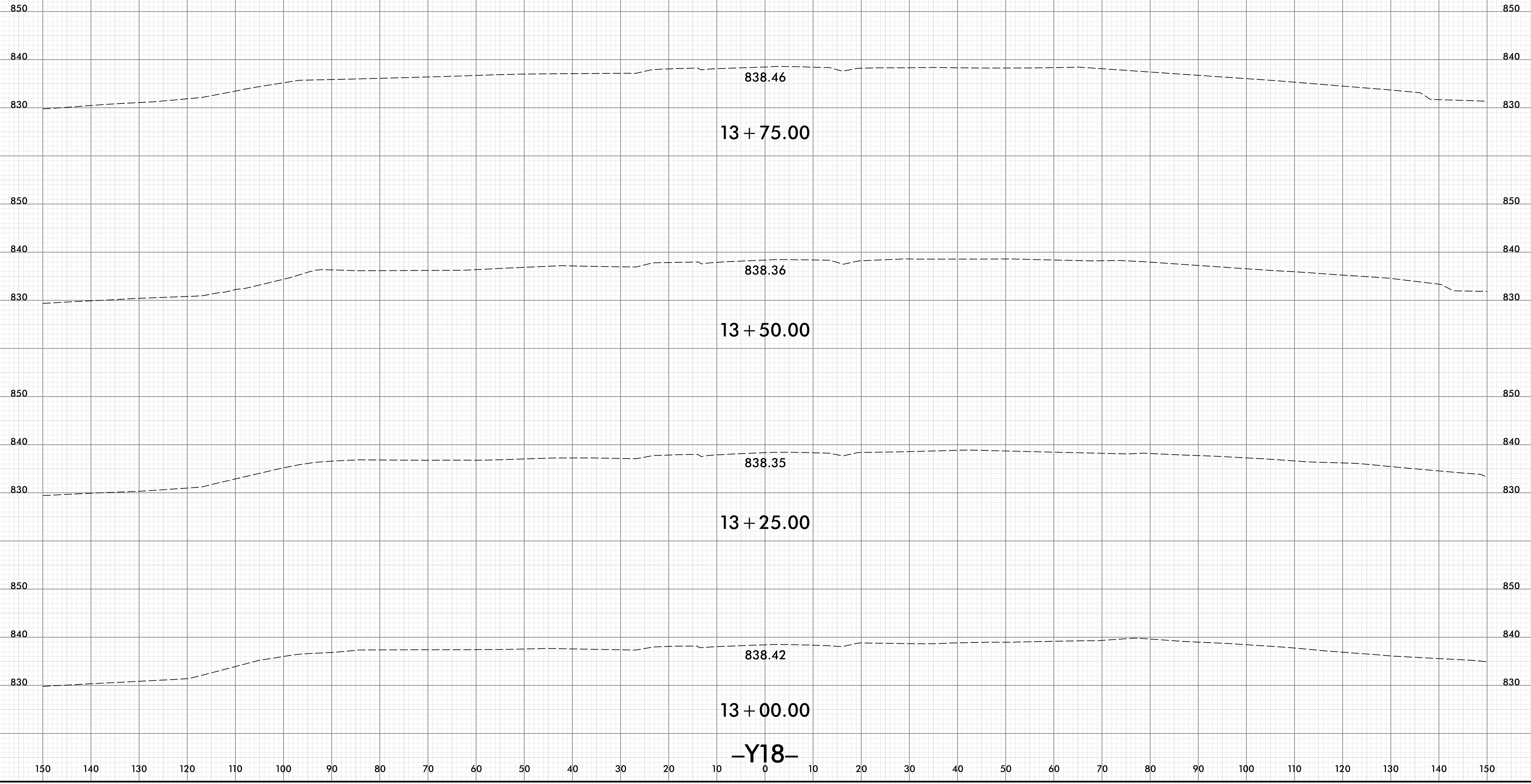

-Y18-

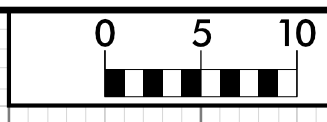

150 140 130 120 110 100 90 80 70 60 50 40 30 20 10 0 10 20 30 40 50 60 70 80 90 100 110 120 130 140 150

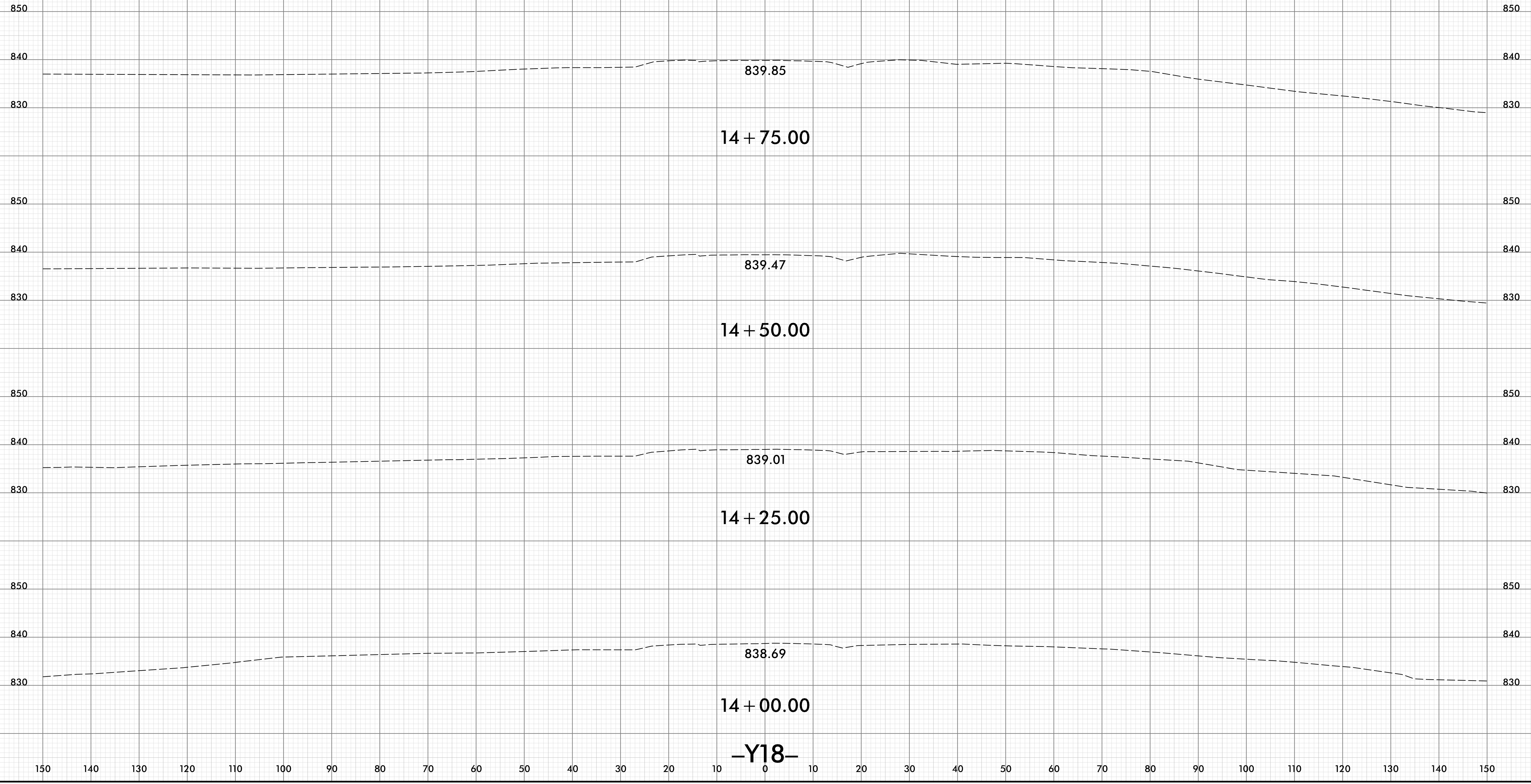

-Y18-

150 140 130 120 110 100 90 80 70 60 50 40 30 20 10 0 10 20 30 40 50 60 70 80 90 100 110 120 130 140 150

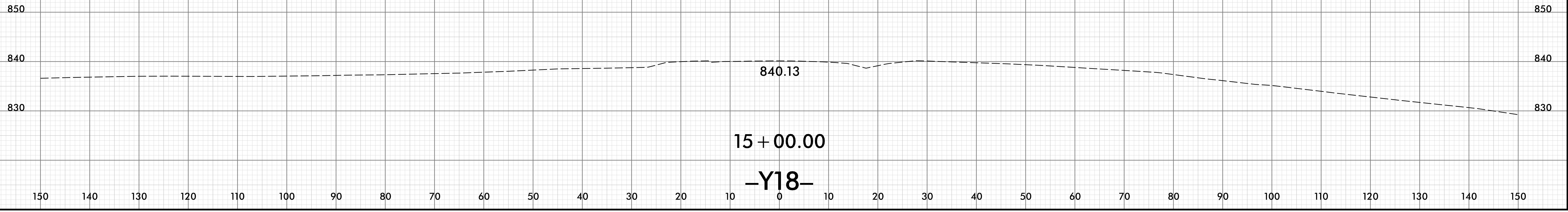

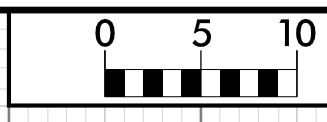

150 140 130 120 110 100 90 80 70 60 50 40 30 20 10 0 10 20 30 40 50 60 70 80 90 100 110 120 130 140 150

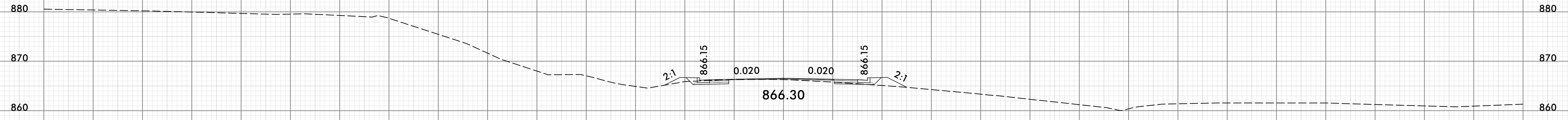

10 + 75.00

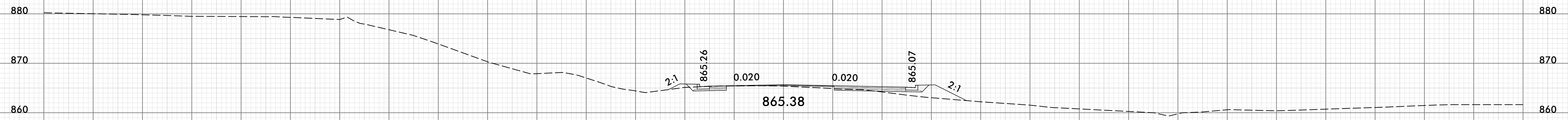

10 + 50.00

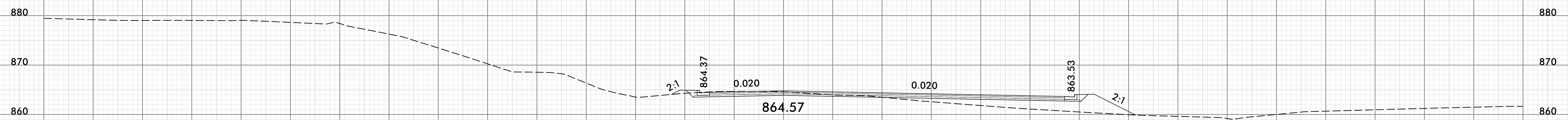

10 + 25.00

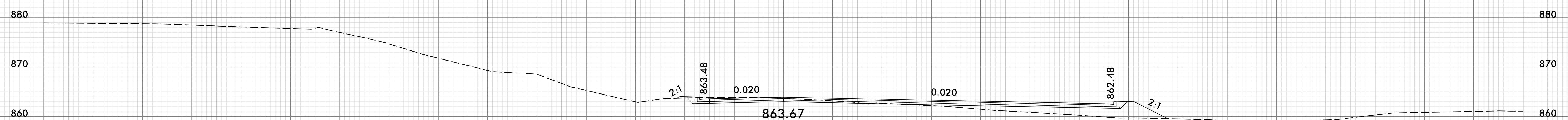

10 + 00.00

-Y19-

150 140 130 120 110 100 90 80 70 60 50 40 30 20 10 0 10 20 30 40 50 60 70 80 90 100 110 120 130 140 150



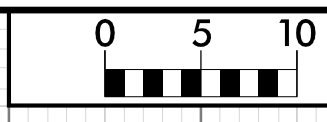

150 140 130 120 110 100 90 80 70 60 50 40 30 20 10 0 10 20 30 40 50 60 70 80 90 100 110 120 130 140 150

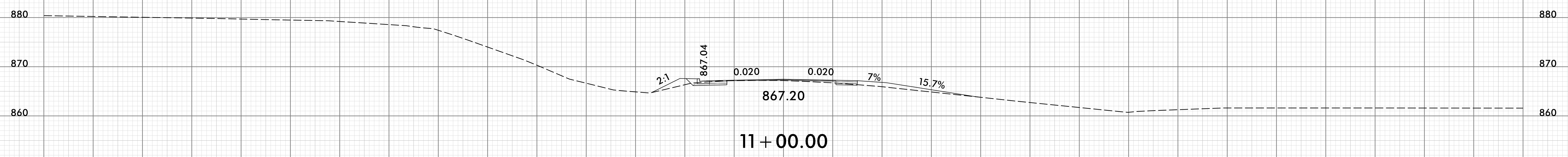
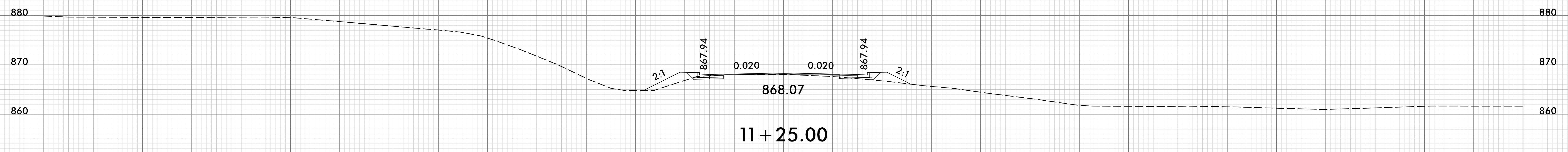
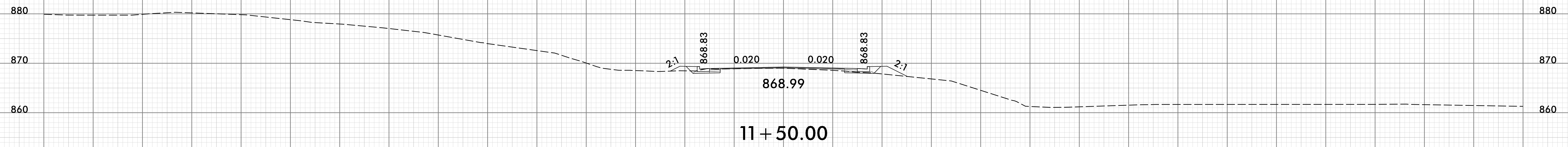
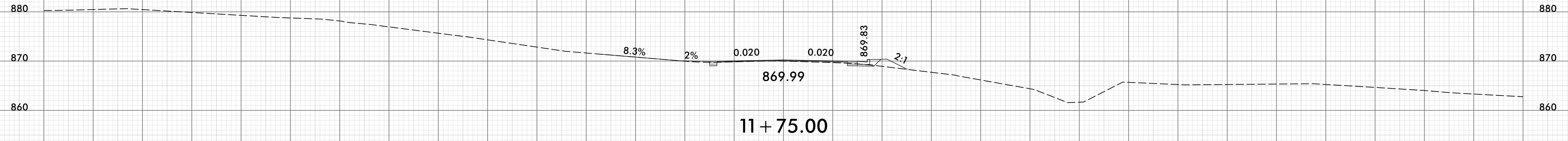

-Y19-

150 140 130 120 110 100 90 80 70 60 50 40 30 20 10 0 10 20 30 40 50 60 70 80 90 100 110 120 130 140 150

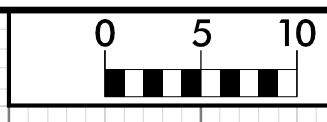

150 140 130 120 110 100 90 80 70 60 50 40 30 20 10 0 10 20 30 40 50 60 70 80 90 100 110 120 130 140 150

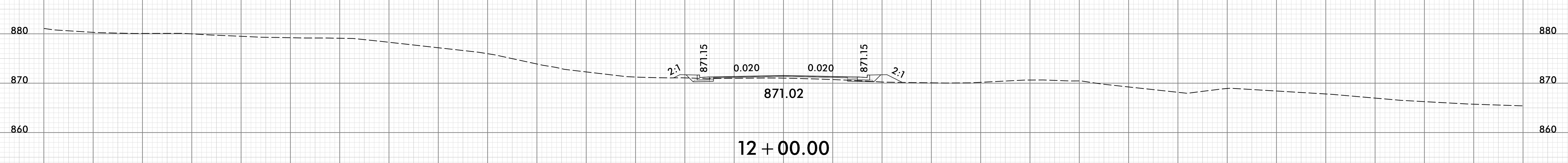
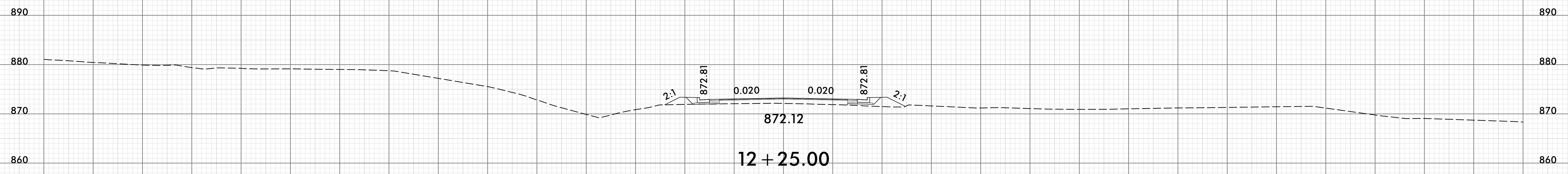
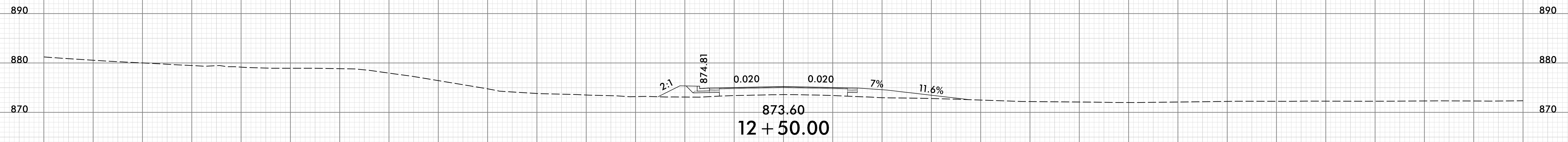
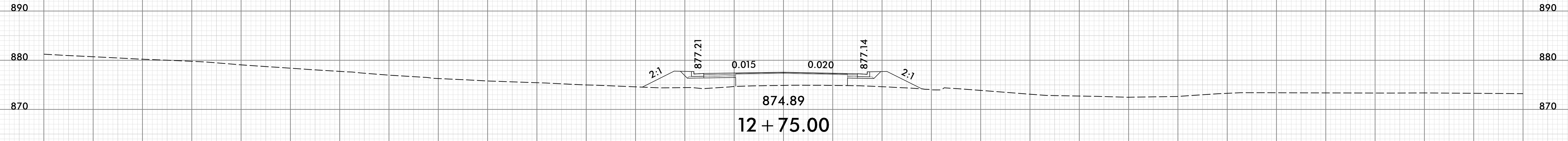

-Y19-

150 140 130 120 110 100 90 80 70 60 50 40 30 20 10 0 10 20 30 40 50 60 70 80 90 100 110 120 130 140 150

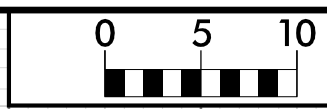

150 140 130 120 110 100 90 80 70 60 50 40 30 20 10 0 10 20 30 40 50 60 70 80 90 100 110 120 130 140 150

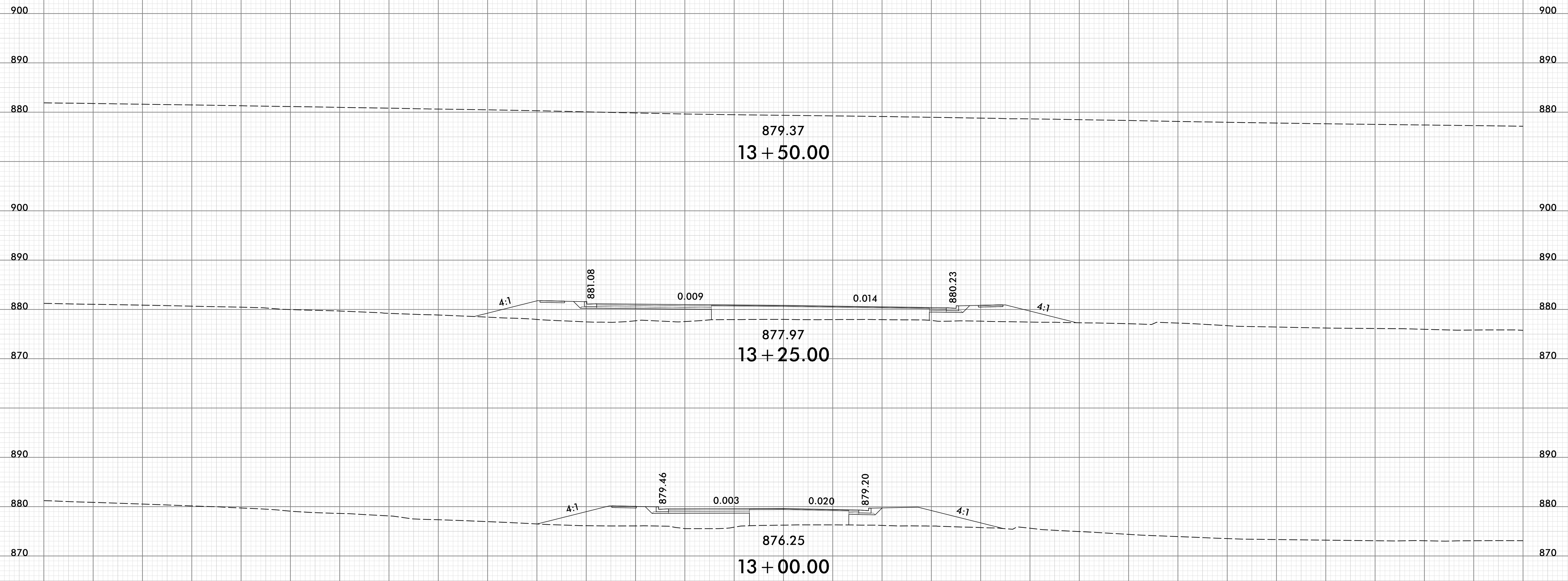

-Y19-

150 140 130 120 110 100 90 80 70 60 50 40 30 20 10 0 10 20 30 40 50 60 70 80 90 100 110 120 130 140 150

8/23/99

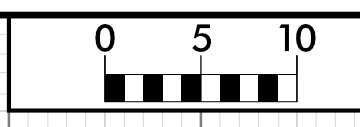

PROJ. REFERENCE NO.	SHEET NO.
U-5813	X-171

150 140 130 120 110 100 90 80 70 60 50 40 30 20 10 0 10 20 30 40 50 60 70 80 90 100 110 120 130 140 150

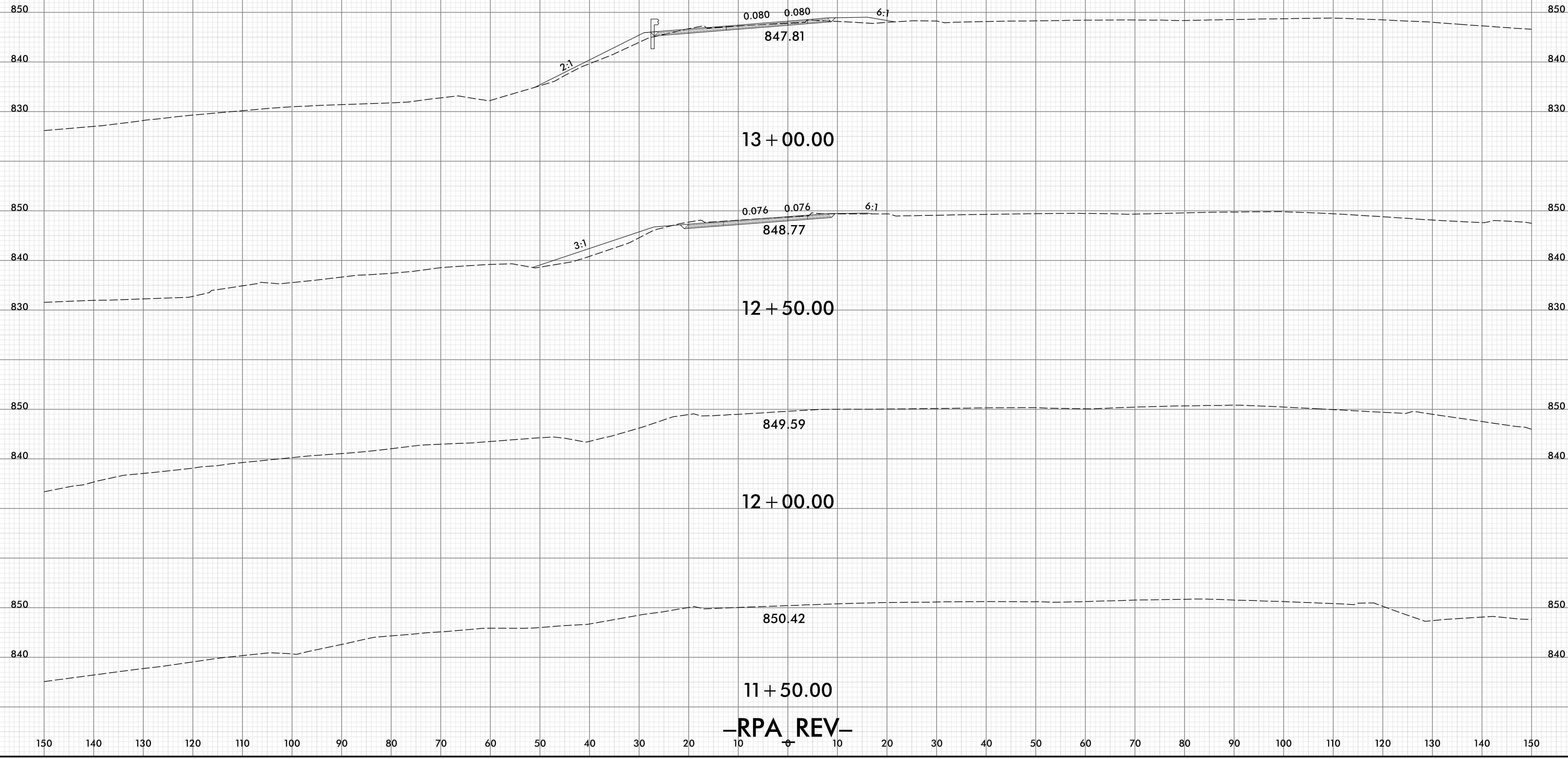

25-APR-2024 18:00  
\\Redkey\CorridorModeling\U5813\_RDY\_RPA\_REV\_XPL.dgn  
HNTB

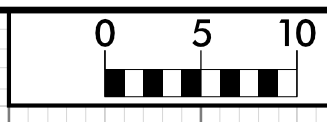

150 140 130 120 110 100 90 80 70 60 50 40 30 20 10 0 10 20 30 40 50 60 70 80 90 100 110 120 130 140 150

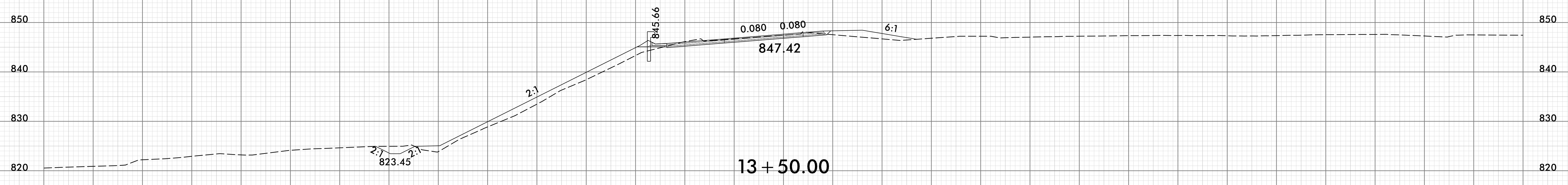
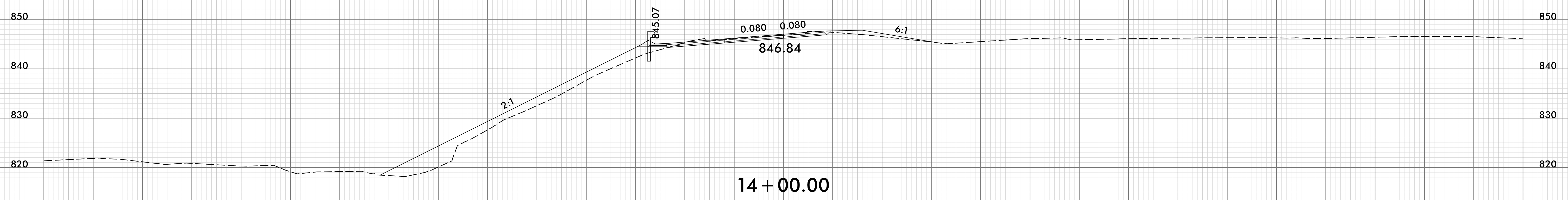
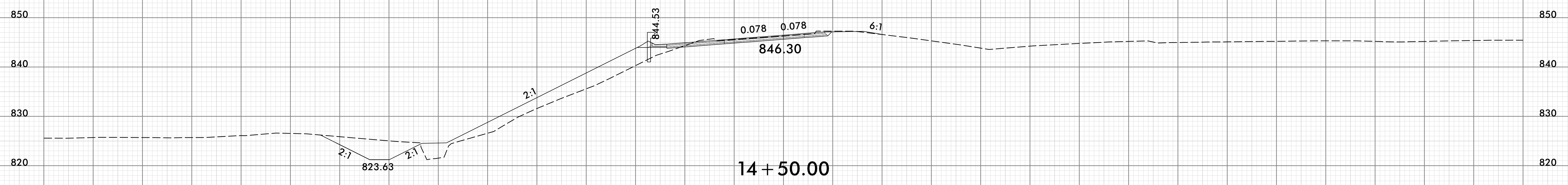
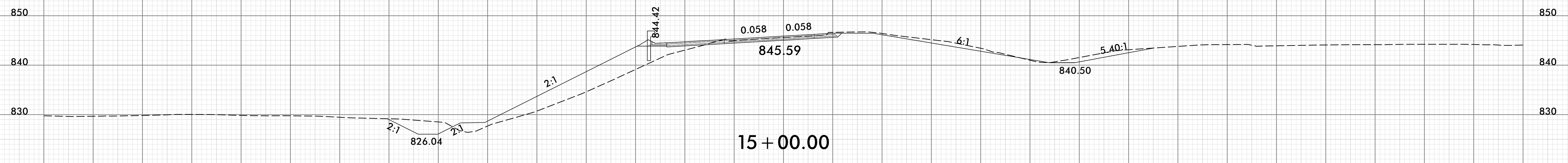

-RPA REV-

150 140 130 120 110 100 90 80 70 60 50 40 30 20 10 0 10 20 30 40 50 60 70 80 90 100 110 120 130 140 150

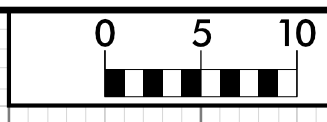

150 140 130 120 110 100 90 80 70 60 50 40 30 20 10 0 10 20 30 40 50 60 70 80 90 100 110 120 130 140 150

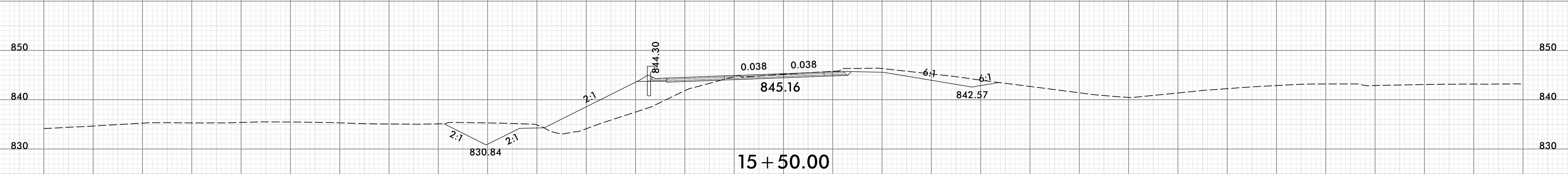
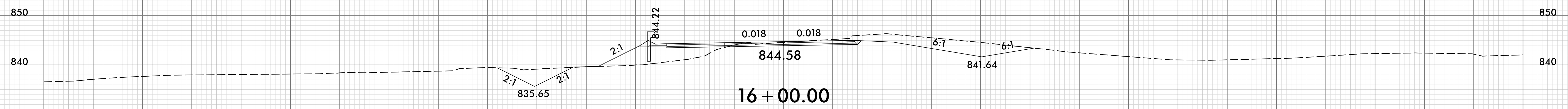
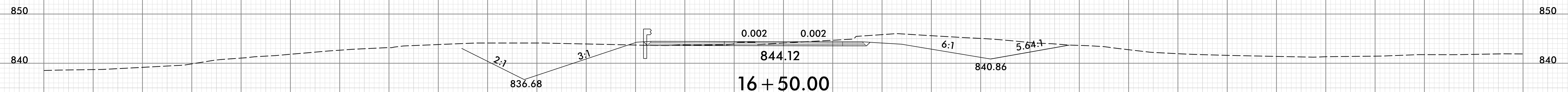
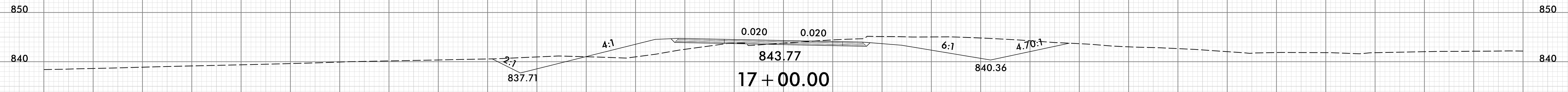
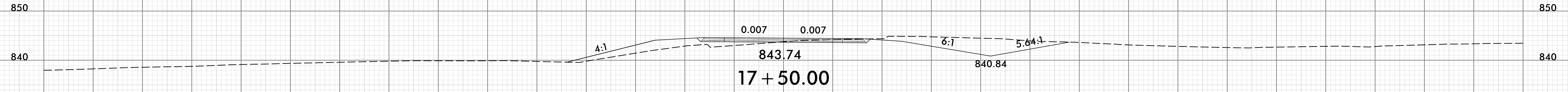

-RPA\_REV-

150 140 130 120 110 100 90 80 70 60 50 40 30 20 10 0 10 20 30 40 50 60 70 80 90 100 110 120 130 140 150

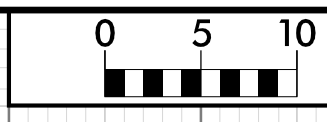

150 140 130 120 110 100 90 80 70 60 50 40 30 20 10 0 10 20 30 40 50 60 70 80 90 100 110 120 130 140 150

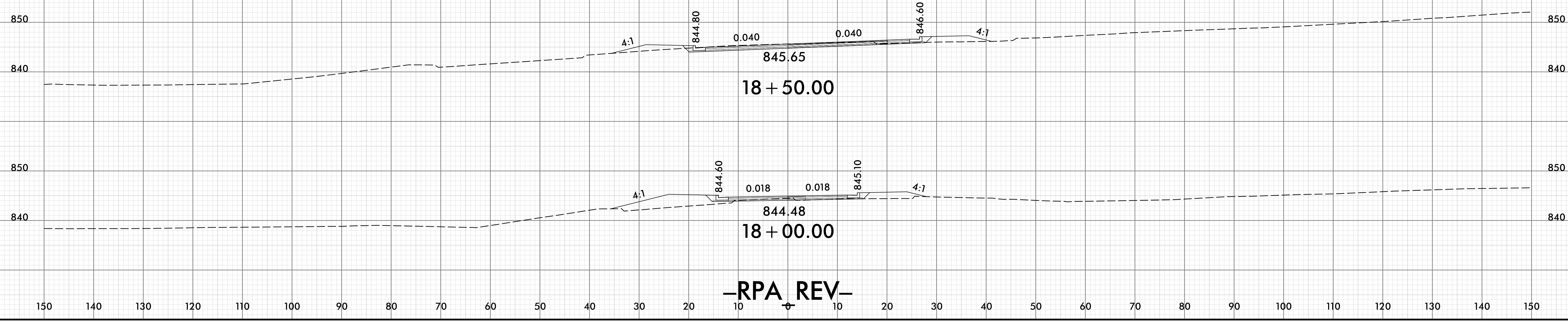

8/23/99



PROJ. REFERENCE NO.	SHEET NO.
U-5813	X-175

150 140 130 120 110 100 90 80 70 60 50 40 30 20 10 0 10 20 30 40 50 60 70 80 90 100 110 120 130 140 150

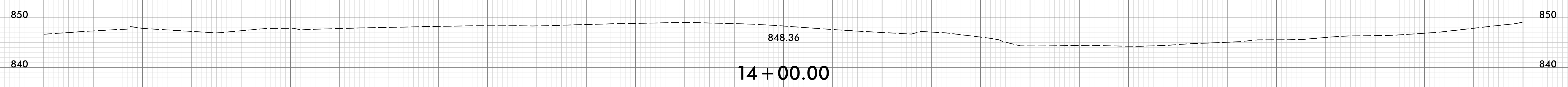
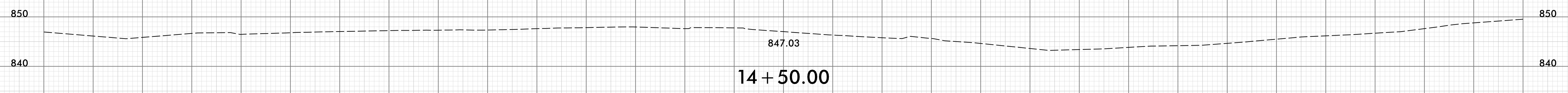
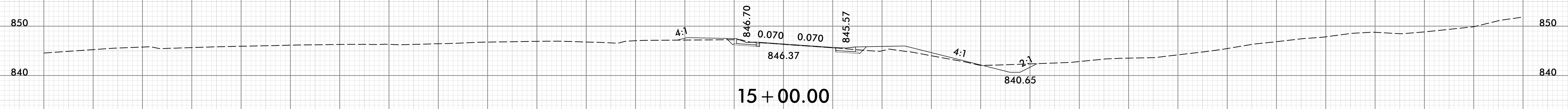
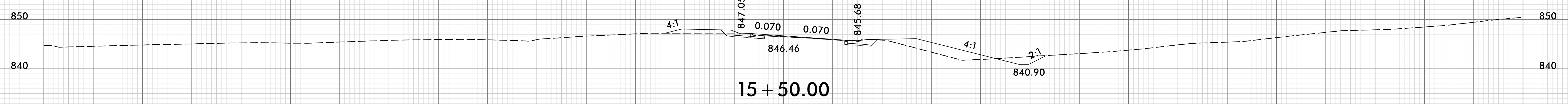
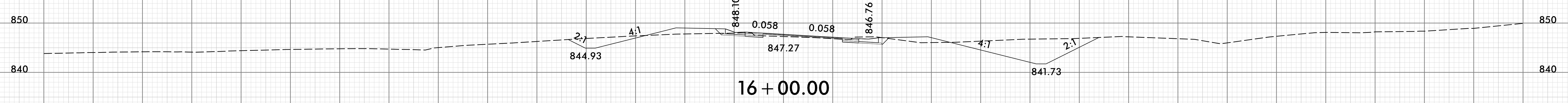
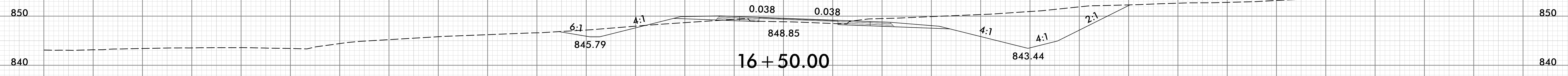

-RPB REV-

150 140 130 120 110 100 90 80 70 60 50 40 30 20 10 0 10 20 30 40 50 60 70 80 90 100 110 120 130 140 150

25-APR-2024 18:00  
 \\redway\CorridorModeling\U5813\_RDY\_RPB\_REV\_XPL.dgn  
 HNTB





150 140 130 120 110 100 90 80 70 60 50 40 30 20 10 0 10 20 30 40 50 60 70 80 90 100 110 120 130 140 150

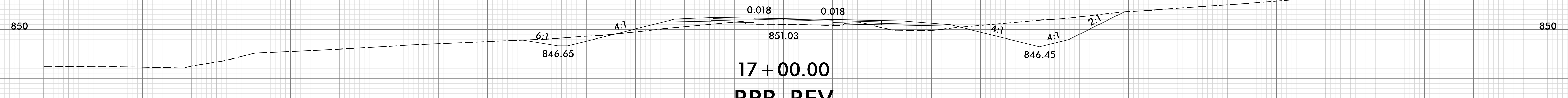
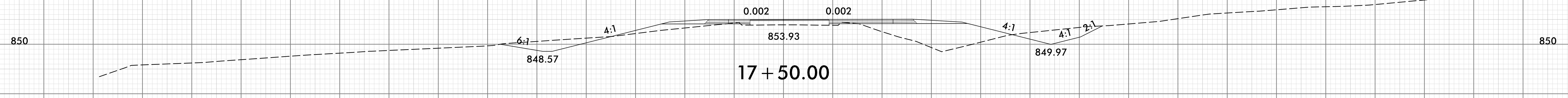
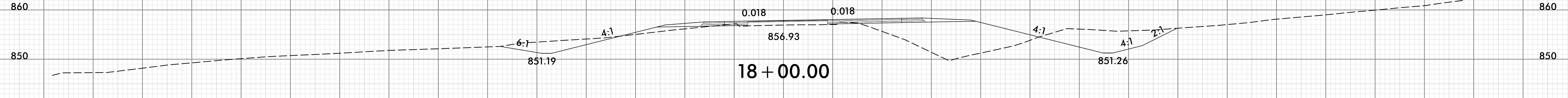
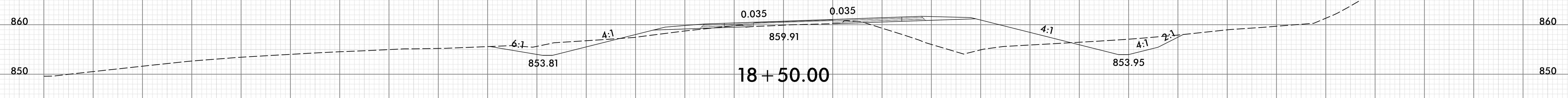
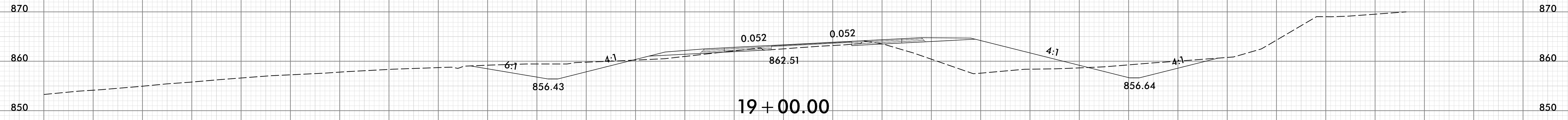
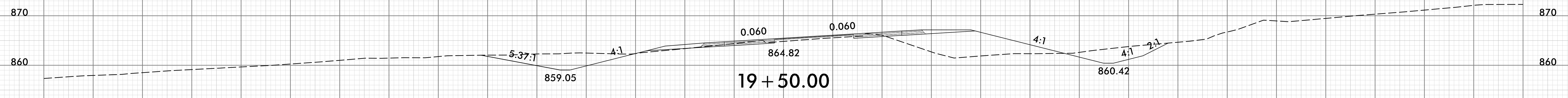

-RPB REV-

150 140 130 120 110 100 90 80 70 60 50 40 30 20 10 0 10 20 30 40 50 60 70 80 90 100 110 120 130 140 150

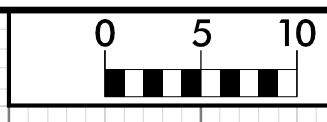

150 140 130 120 110 100 90 80 70 60 50 40 30 20 10 0 10 20 30 40 50 60 70 80 90 100 110 120 130 140 150

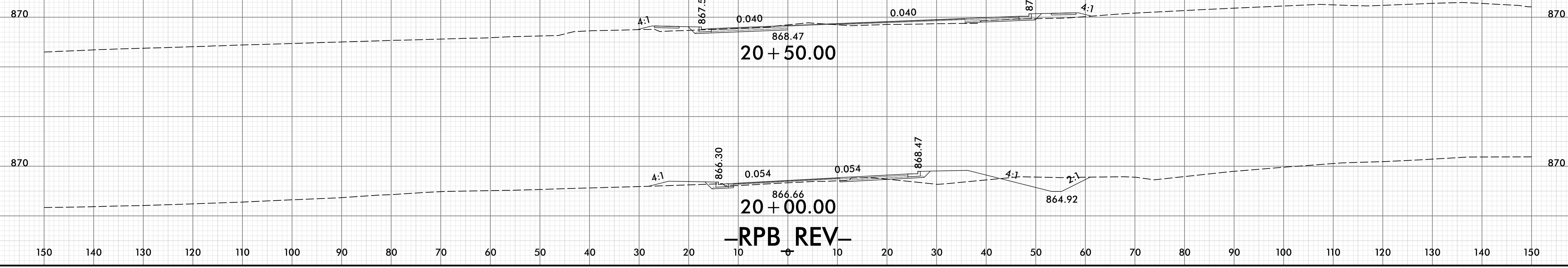

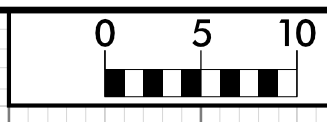

150 140 130 120 110 100 90 80 70 60 50 40 30 20 10 0 10 20 30 40 50 60 70 80 90 100 110 120 130 140 150

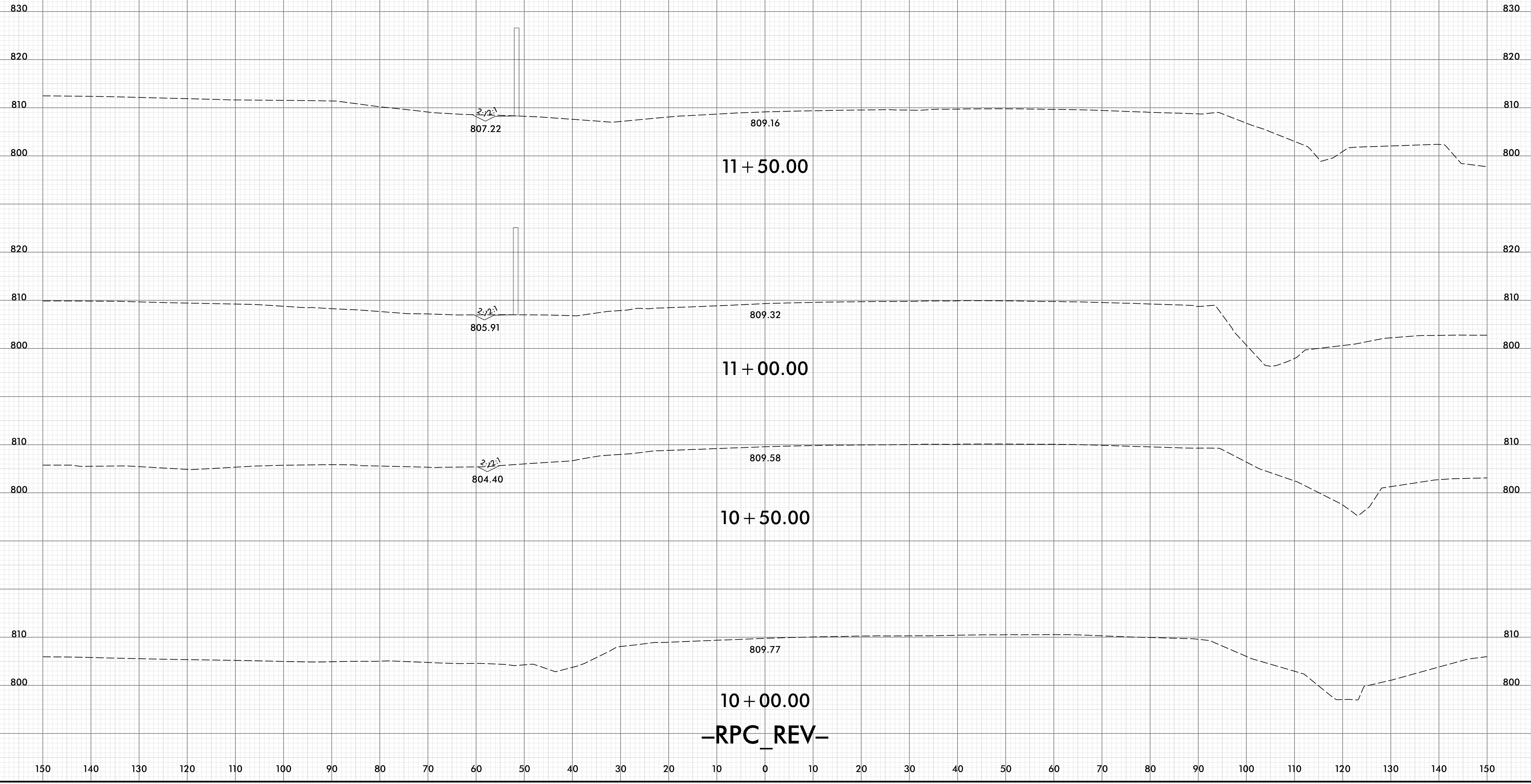

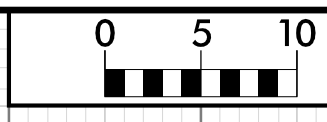

150 140 130 120 110 100 90 80 70 60 50 40 30 20 10 0 10 20 30 40 50 60 70 80 90 100 110 120 130 140 150

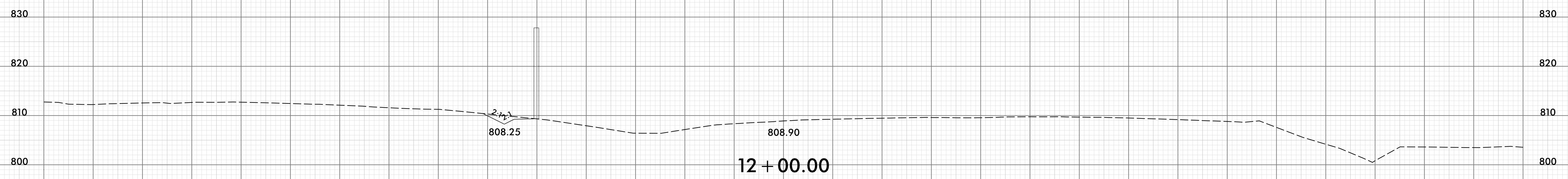
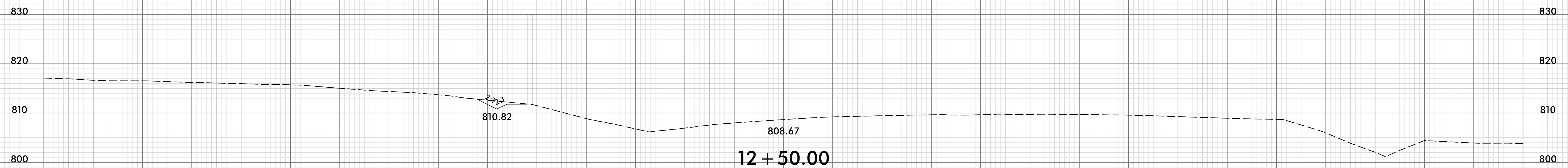
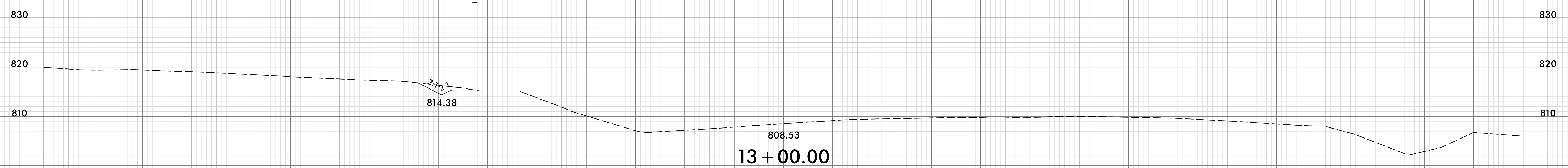
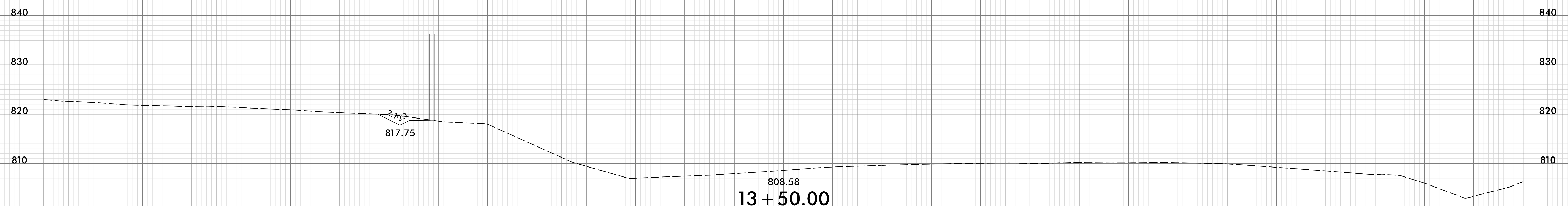

-RPC\_REV-

150 140 130 120 110 100 90 80 70 60 50 40 30 20 10 0 10 20 30 40 50 60 70 80 90 100 110 120 130 140 150

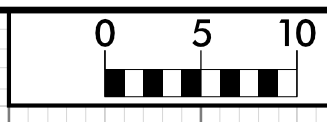

150 140 130 120 110 100 90 80 70 60 50 40 30 20 10 0 10 20 30 40 50 60 70 80 90 100 110 120 130 140 150

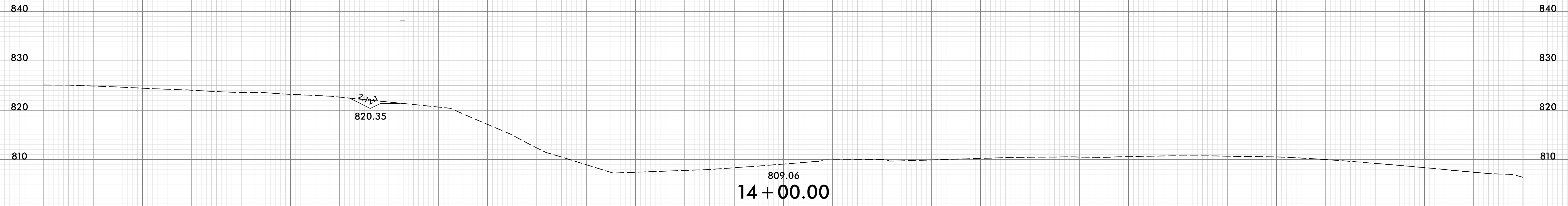
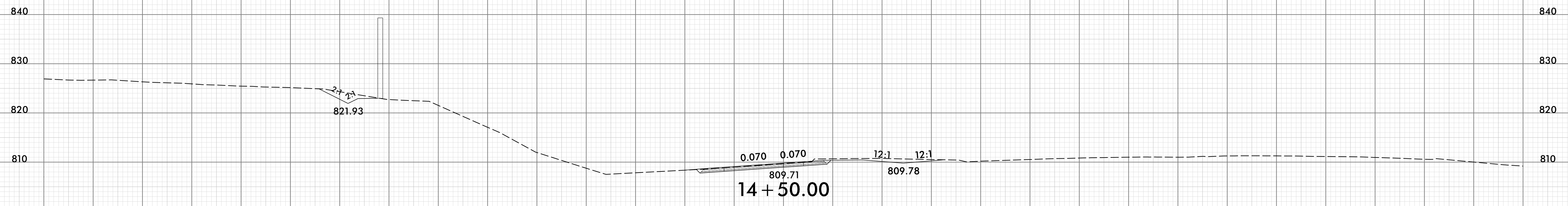
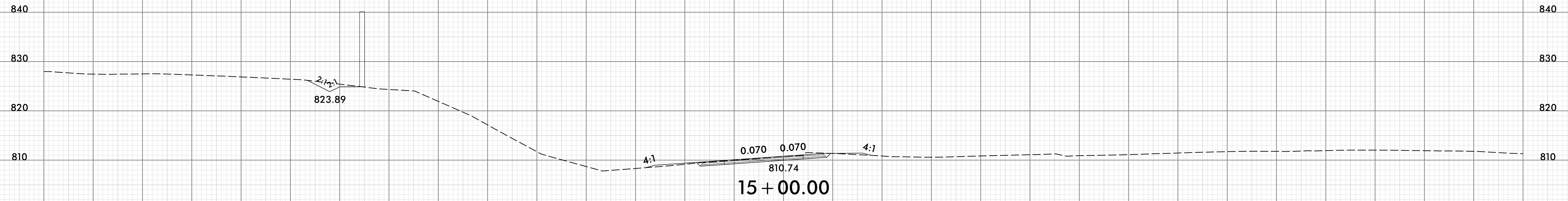

-RPC\_REV-

150 140 130 120 110 100 90 80 70 60 50 40 30 20 10 0 10 20 30 40 50 60 70 80 90 100 110 120 130 140 150

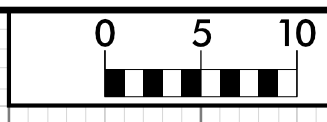

150 140 130 120 110 100 90 80 70 60 50 40 30 20 10 0 10 20 30 40 50 60 70 80 90 100 110 120 130 140 150

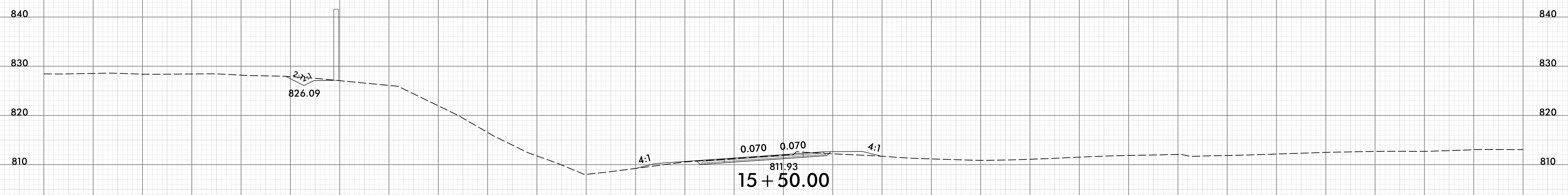
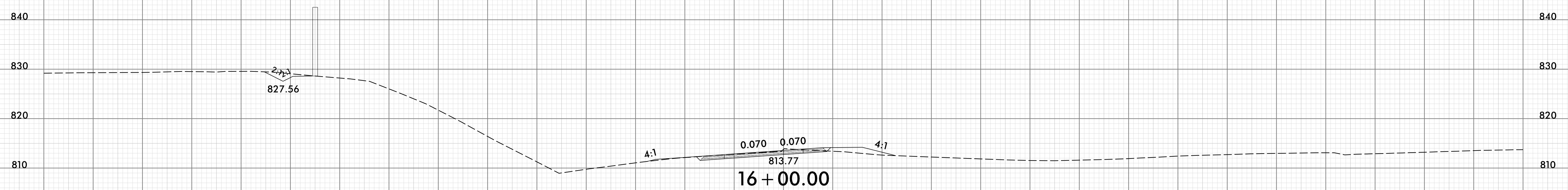
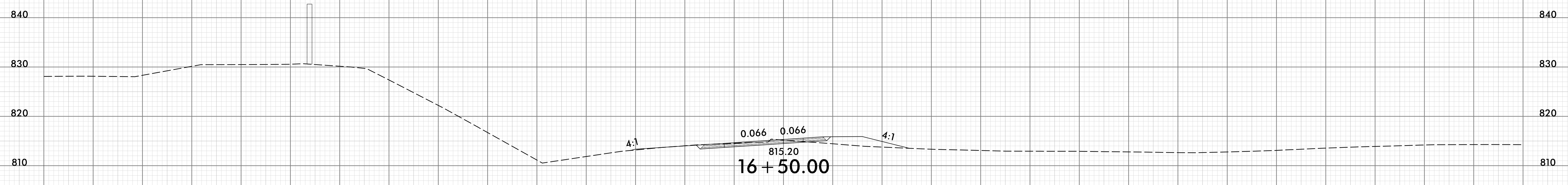

-RPC\_REV-

150 140 130 120 110 100 90 80 70 60 50 40 30 20 10 0 10 20 30 40 50 60 70 80 90 100 110 120 130 140 150

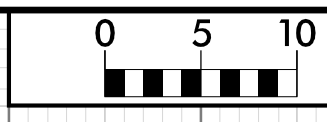

150 140 130 120 110 100 90 80 70 60 50 40 30 20 10 0 10 20 30 40 50 60 70 80 90 100 110 120 130 140 150

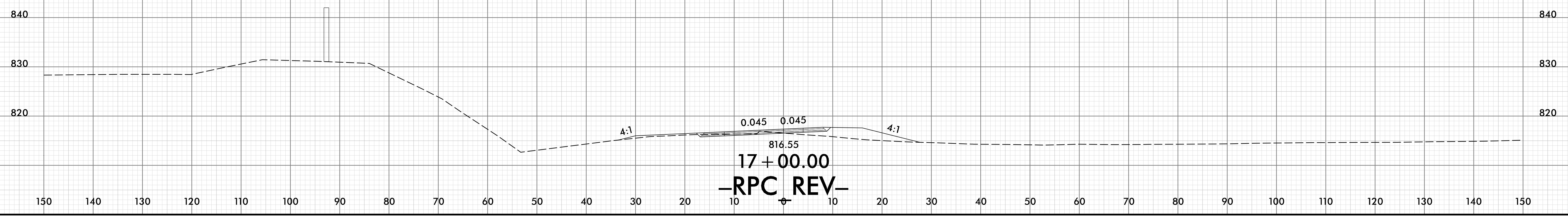
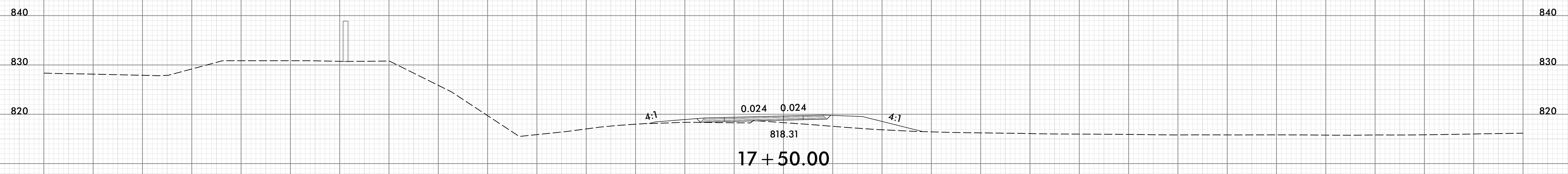
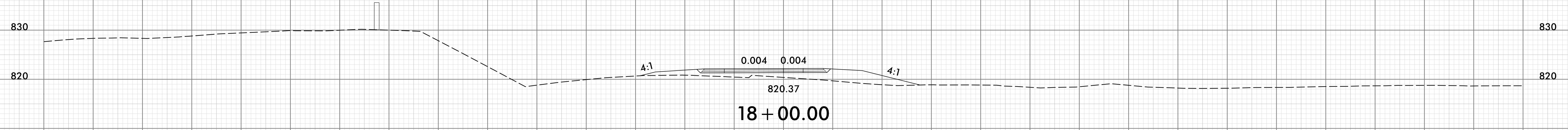
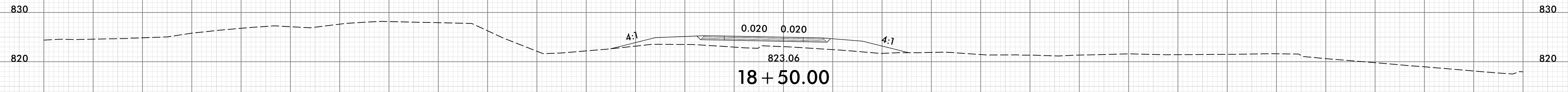
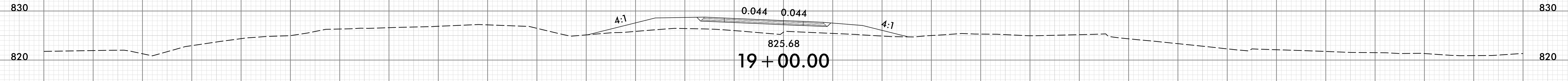

150 140 130 120 110 100 90 80 70 60 50 40 30 20 10 0 10 20 30 40 50 60 70 80 90 100 110 120 130 140 150

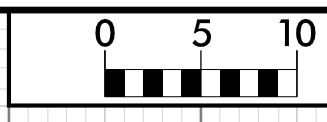

150 140 130 120 110 100 90 80 70 60 50 40 30 20 10 0 10 20 30 40 50 60 70 80 90 100 110 120 130 140 150

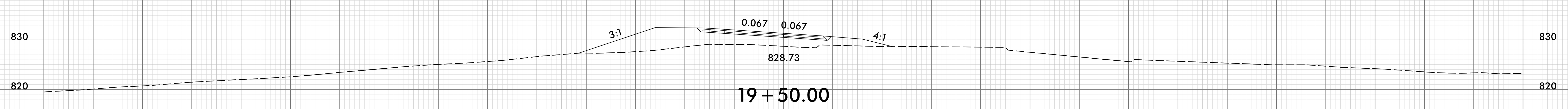
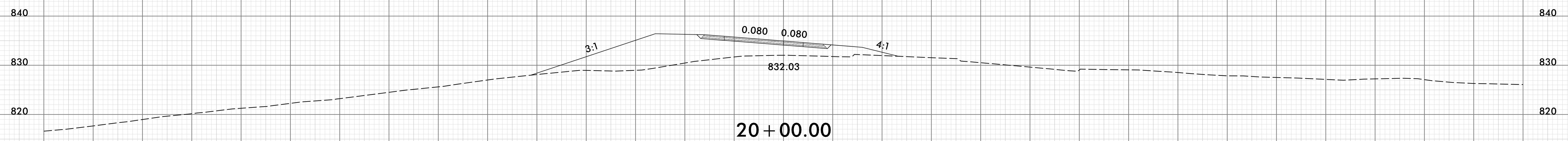
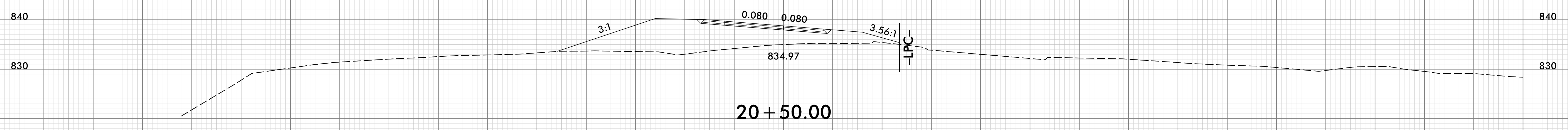
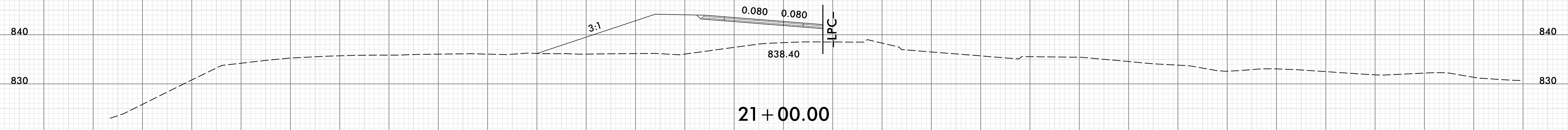
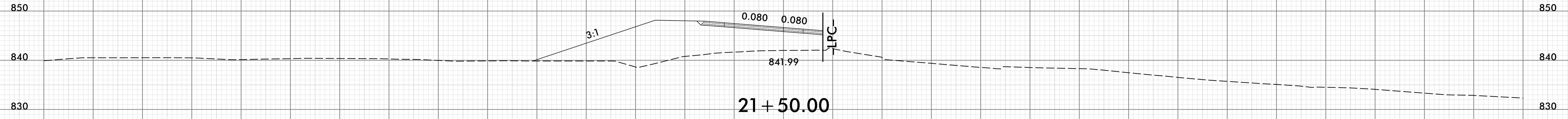

-RPC\_REV-

150 140 130 120 110 100 90 80 70 60 50 40 30 20 10 0 10 20 30 40 50 60 70 80 90 100 110 120 130 140 150



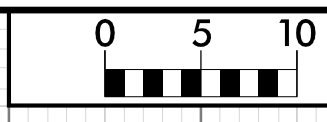

150 140 130 120 110 100 90 80 70 60 50 40 30 20 10 0 10 20 30 40 50 60 70 80 90 100 110 120 130 140 150

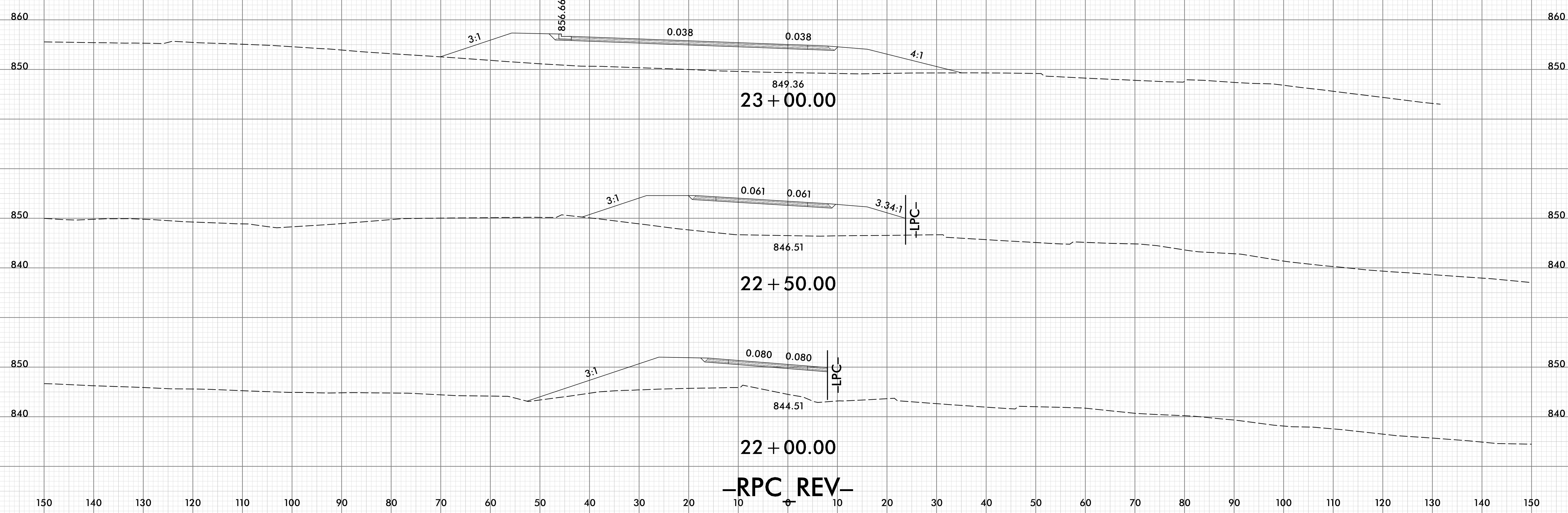

150 140 130 120 110 100 90 80 70 60 50 40 30 20 10 0 10 20 30 40 50 60 70 80 90 100 110 120 130 140 150

8/23/99

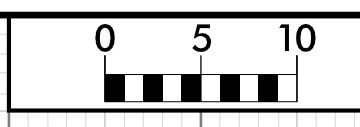

PROJ. REFERENCE NO.	SHEET NO.
U-5813	X-185

150 140 130 120 110 100 90 80 70 60 50 40 30 20 10 0 10 20 30 40 50 60 70 80 90 100 110 120 130 140 150

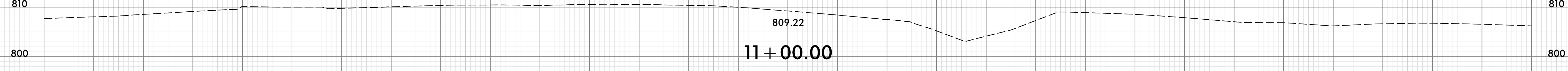
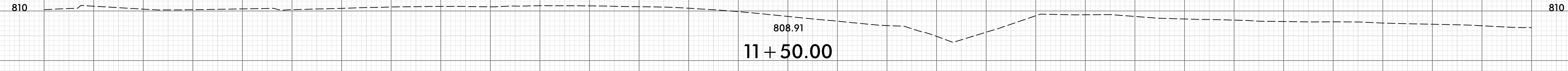
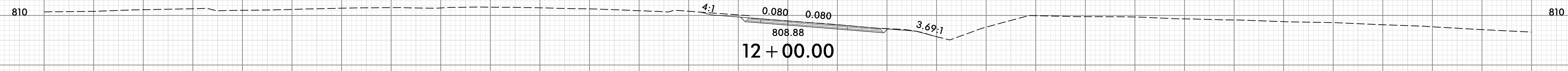
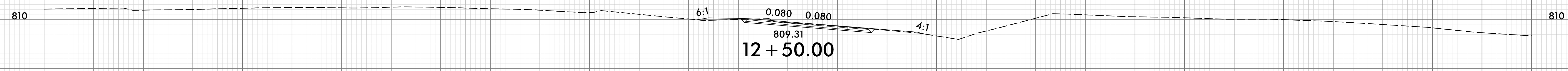
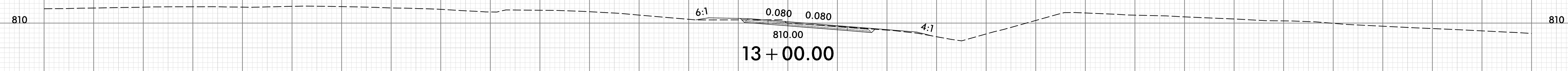
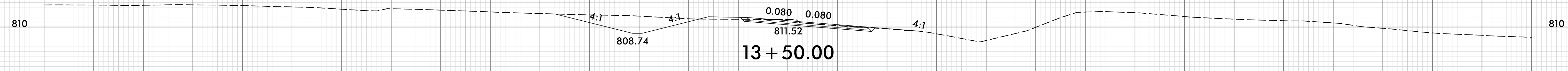

**-RPD REV-**

150 140 130 120 110 100 90 80 70 60 50 40 30 20 10 0 10 20 30 40 50 60 70 80 90 100 110 120 130 140 150

25-APR-2024 18:00  
 \\redway\CorridorModeling\U5813\_RDY\_RPD\_REV\_XPL.dgn  
 HNTB

150 140 130 120 110 100 90 80 70 60 50 40 30 20 10 0 10 20 30 40 50 60 70 80 90 100 110 120 130 140 150

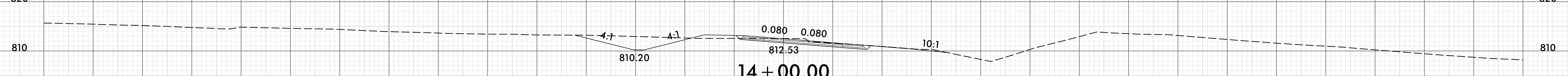
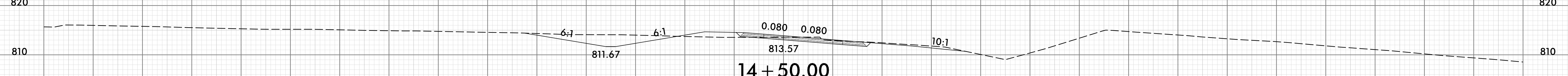
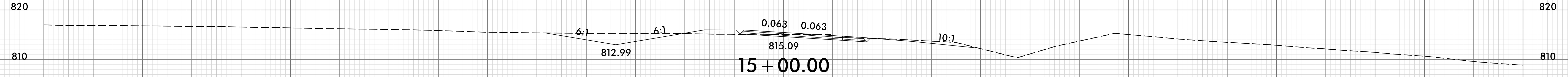
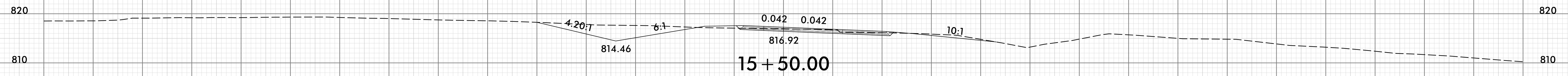
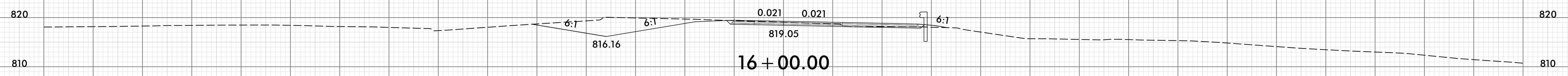
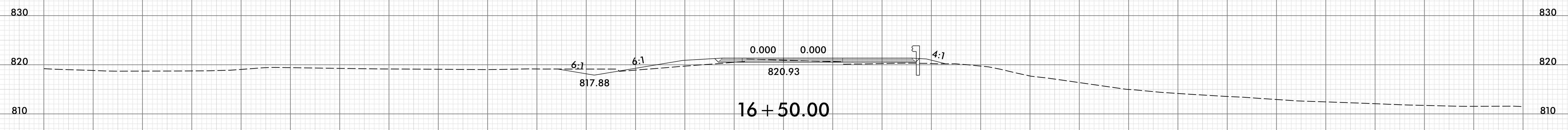

-RPD REV-

150 140 130 120 110 100 90 80 70 60 50 40 30 20 10 0 10 20 30 40 50 60 70 80 90 100 110 120 130 140 150

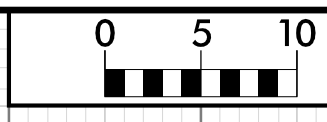

150 140 130 120 110 100 90 80 70 60 50 40 30 20 10 0 10 20 30 40 50 60 70 80 90 100 110 120 130 140 150

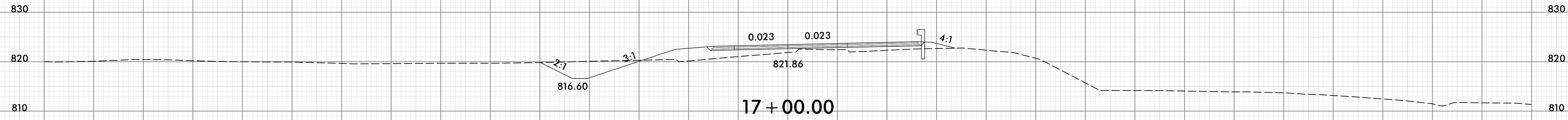
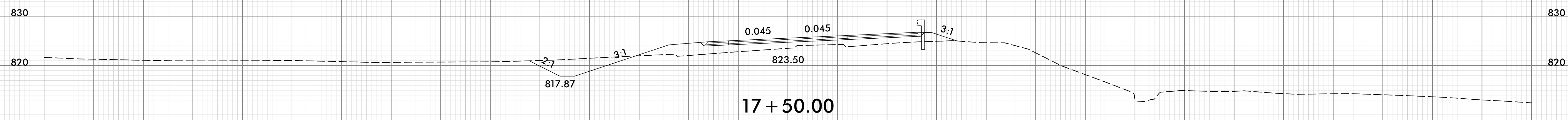
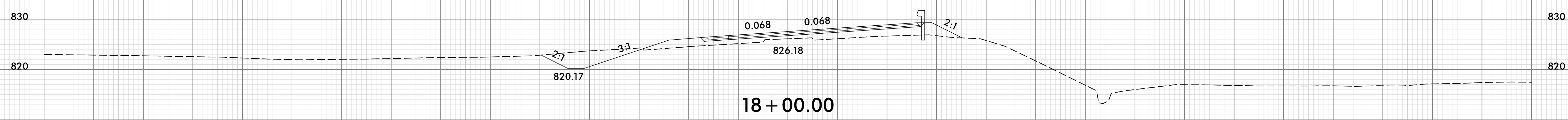
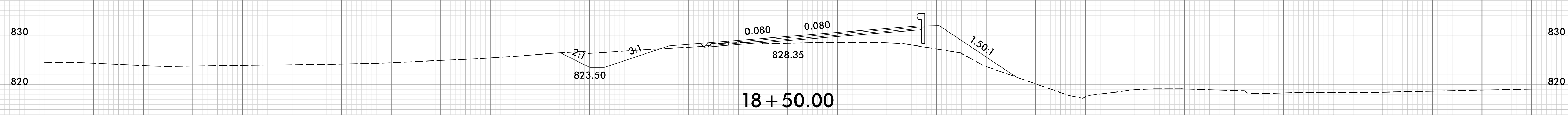
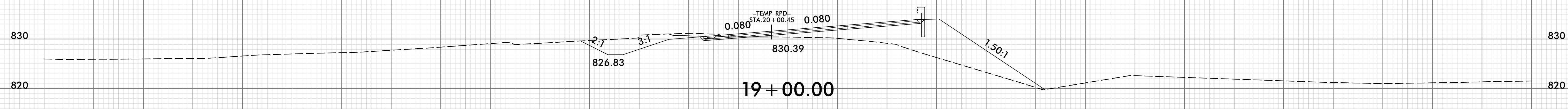

-RPD REV-

150 140 130 120 110 100 90 80 70 60 50 40 30 20 10 0 10 20 30 40 50 60 70 80 90 100 110 120 130 140 150

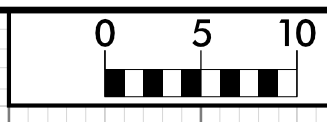

150 140 130 120 110 100 90 80 70 60 50 40 30 20 10 0 10 20 30 40 50 60 70 80 90 100 110 120 130 140 150

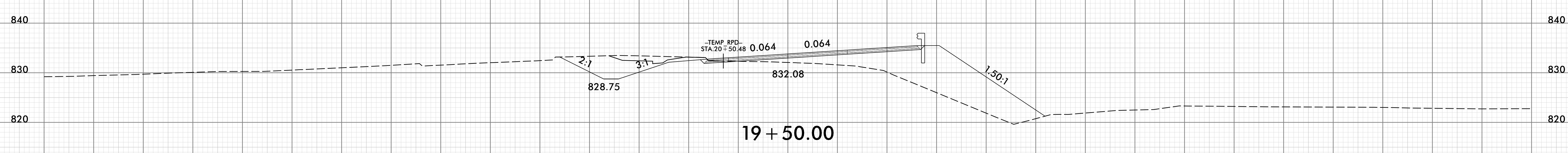
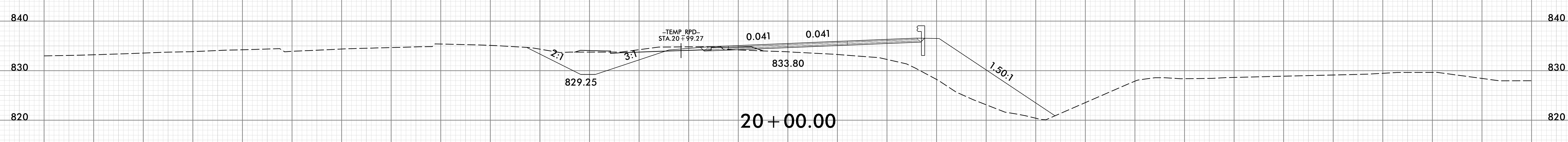
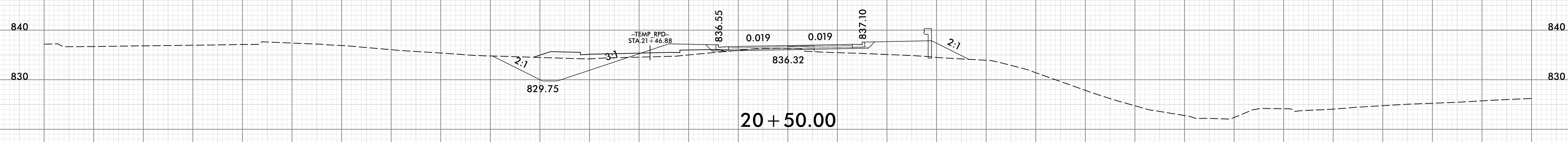
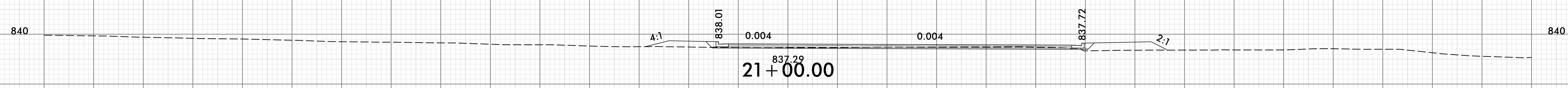

-RPD REV-

150 140 130 120 110 100 90 80 70 60 50 40 30 20 10 0 10 20 30 40 50 60 70 80 90 100 110 120 130 140 150

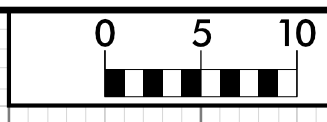

150 140 130 120 110 100 90 80 70 60 50 40 30 20 10 0 10 20 30 40 50 60 70 80 90 100 110 120 130 140 150

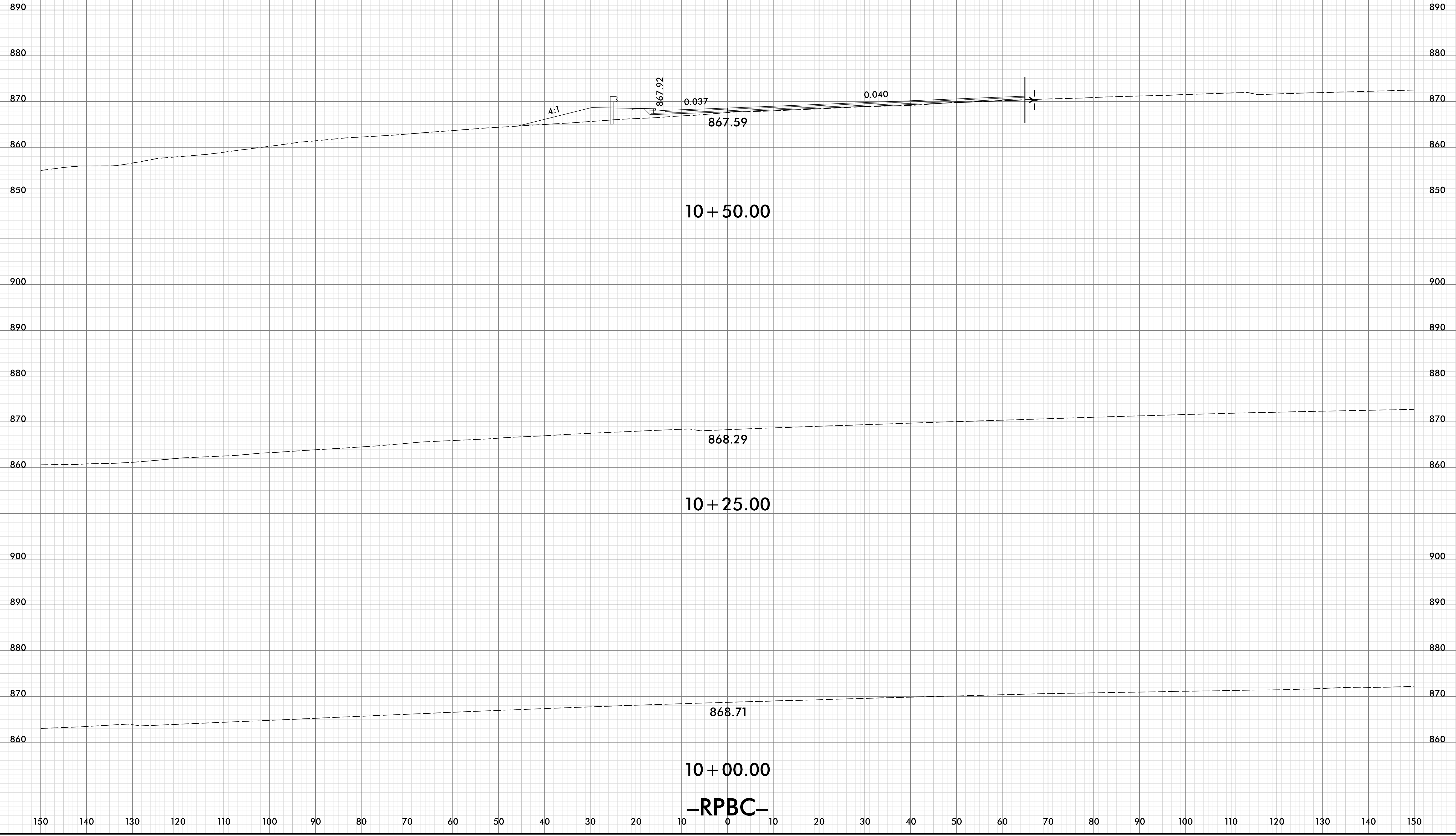

10 + 50.00

10 + 25.00

10 + 00.00

-RPBC-

4:1

867.92

0.037

867.59

0.040

868.29

868.71

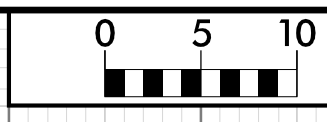

150 140 130 120 110 100 90 80 70 60 50 40 30 20 10 0 10 20 30 40 50 60 70 80 90 100 110 120 130 140 150

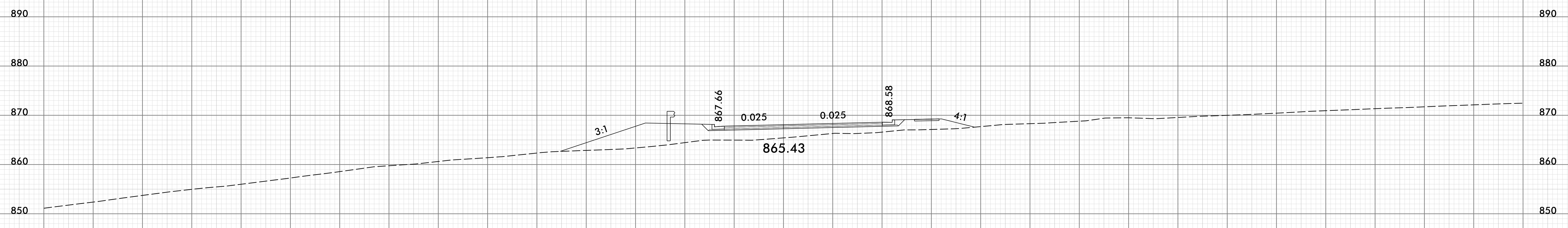
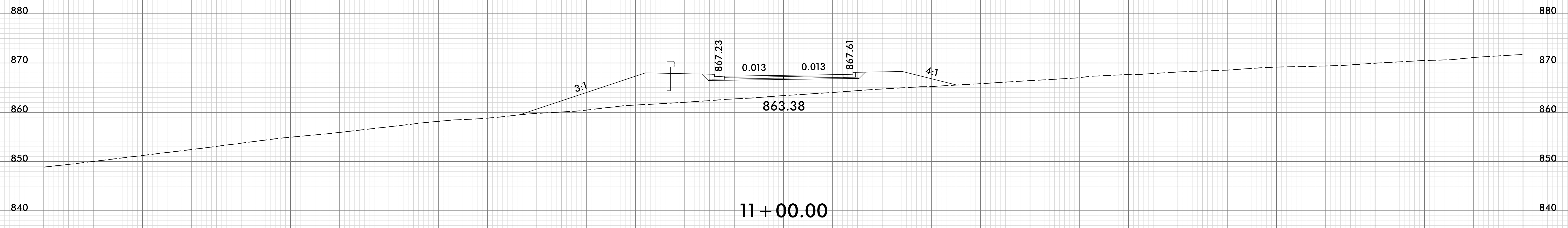
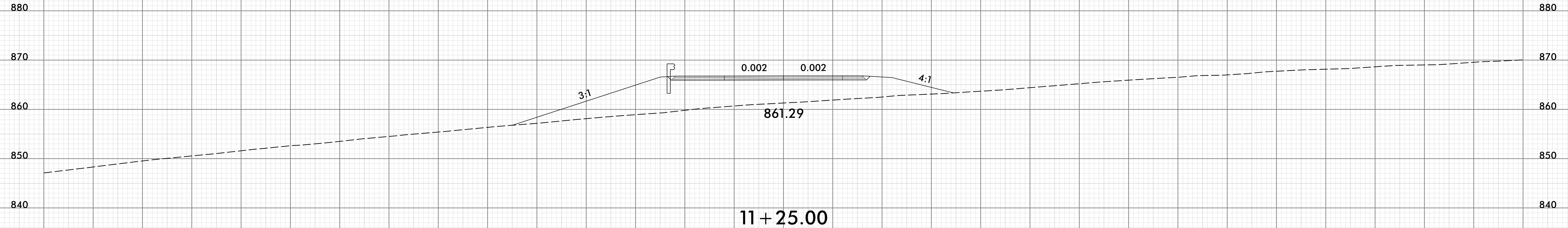

-RPBC-

150 140 130 120 110 100 90 80 70 60 50 40 30 20 10 0 10 20 30 40 50 60 70 80 90 100 110 120 130 140 150



150 140 130 120 110 100 90 80 70 60 50 40 30 20 10 0 10 20 30 40 50 60 70 80 90 100 110 120 130 140 150

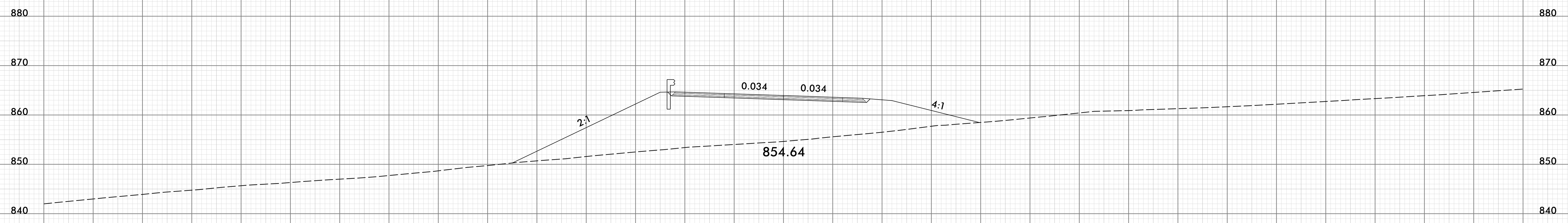

12 + 00.00

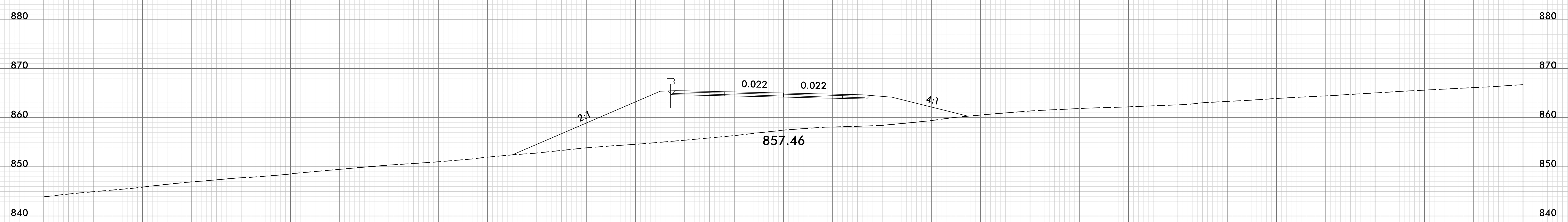

11 + 75.00

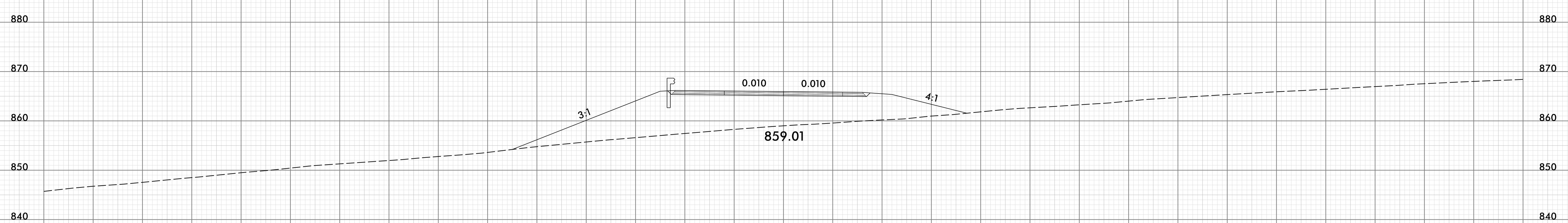

11 + 50.00

-RPBC-

150 140 130 120 110 100 90 80 70 60 50 40 30 20 10 0 10 20 30 40 50 60 70 80 90 100 110 120 130 140 150