

MATCH LINE SHEET TMP-34
-Y- STA. 47+50

MATCH LINE SHEET TMP-36
-Y- STA. 61+00



-Y- STA 56+40 +/-
TEMP SIGN

VERIFY SIGN LOCATION
WITH ENGINEER

SIGNS SHALL BE PROTECTED
WITH POSITIVE PROTECTION

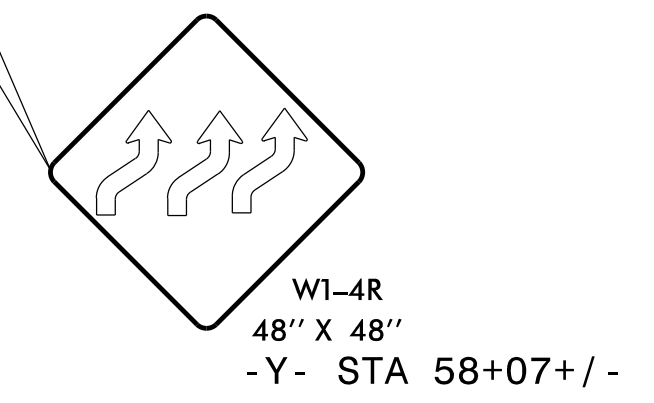

LEGEND	
	NEW TEMPORARY MARKINGS
	EXISTING MARKINGS (GRAY)
	NEW CONSTRUCTION AREAS
	TEMPORARY PAVEMENT
	ON-GOING CONSTRUCTION
	REMOVAL
	OVERLAY/WEDGING

NOTE: THE CONTRACTOR SHALL RELOCATE INFORMATION SIGNS BEFORE CONSTRUCTION REMOVES THEM.
NOTE: ALL LANE WIDTHS ARE 11' UNLESS OTHERWISE SHOWN.



ICE of Carolinas, PLLC
4505 Falls of Neuse Road, Suite 110
Raleigh, North Carolina 27609
Phone: 803-822-0333
License #: P-0999

APPROVED: *J. Stuart Course*
DATE: 1/4/2024

SEAL

DOCUMENT NOT CONSIDERED FINAL
UNLESS ALL SIGNATURES COMPLETED

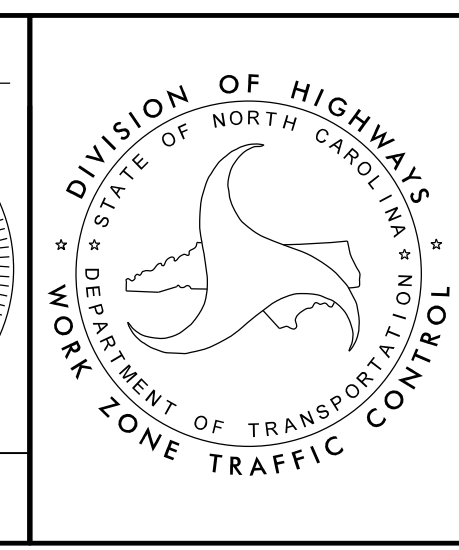

DIVISION OF HIGHWAYS
STATE OF NORTH CAROLINA
DEPARTMENT OF TRANSPORTATION
WORK ZONE TRAFFIC CONTROL

TEMPORARY TRAFFIC CONTROL
PHASE IV DETAIL
AREA 1

04-JAN-2024 09:26 R:\Projects\2513AA\08_01-I-2513AA_Work Zone Traffic Control\TrafficControl\CP\ProjectWise\Phase 4\I-2513AA_PHASE_4_TMP-35.dgn

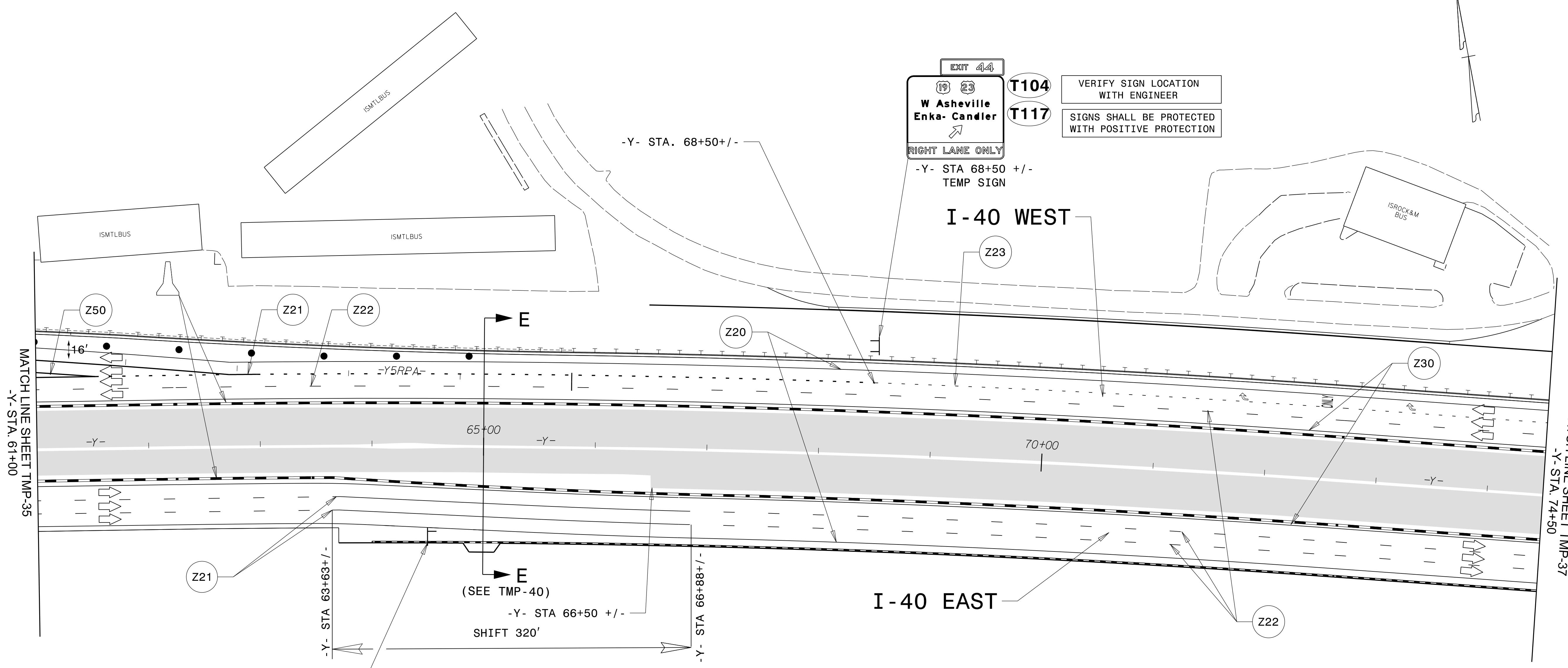

MATCH LINE SHEET TMP-35
-Y- STA. 61+00

MATCH LINE SHEET TMP-37
-Y- STA. 74+50

LEGEND

	NEW TEMPORARY MARKINGS
	EXISTING MARKINGS (GRAY)
	NEW CONSTRUCTION AREAS
	TEMPORARY PAVEMENT
	ON-GOING CONSTRUCTION
	REMOVAL
	OVERLAY/WEDGING

NOTE: THE CONTRACTOR SHALL RELOCATE INFORMATION SIGNS BEFORE CONSTRUCTION REMOVES THEM.
 NOTE: ALL LANE WIDTHS ARE 11' UNLESS OTHERWISE SHOWN.

VERIFY SIGN LOCATION WITH ENGINEER
 SIGNS SHALL BE PROTECTED WITH POSITIVE PROTECTION

APPROVED: *J. Stuart Bourne*
 DATE: 1/4/2024
 SEAL
 DOCUMENT NOT CONSIDERED FINAL UNLESS ALL SIGNATURES COMPLETED

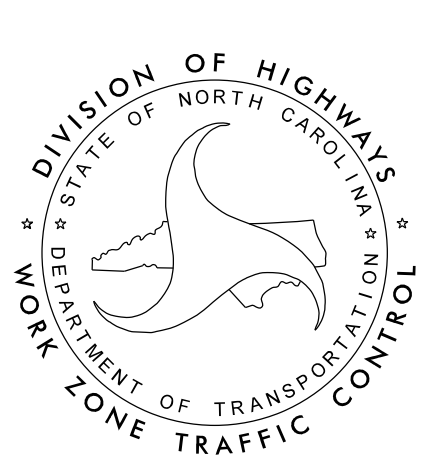

TEMPORARY TRAFFIC CONTROL PHASE IV DETAIL AREA 1

ICE of CAROLINAS, PLLC
 ICE of Carolinas, PLLC
 4505 Falls of Neuse Road, Suite 110
 Raleigh, North Carolina 27609
 Phone: 803-822-0333
 License #: P-0999

04-JAN-2024 09:27 R:\Projects\I-2513AA-Work Zone Traffic Control\Traffic Control\CP\ProjectWise\Phase 4\I-2513AA-Phase-4_TMP-36.dgn

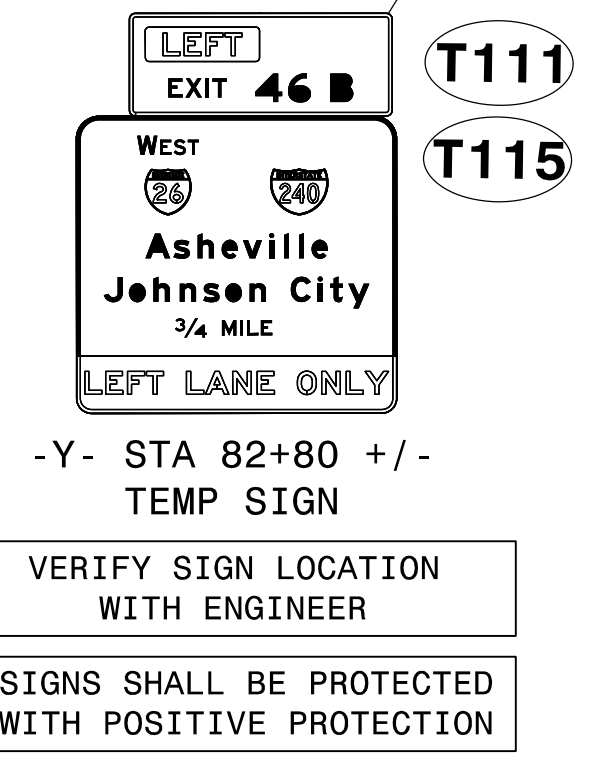
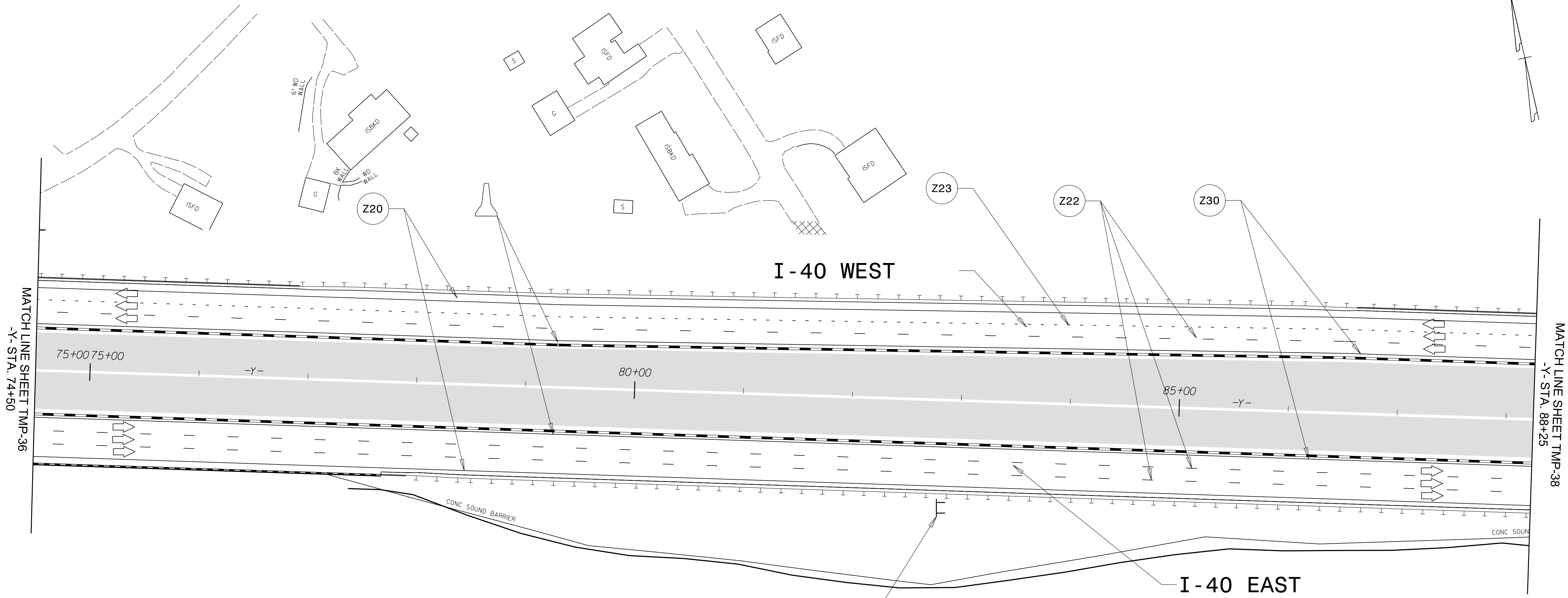

LEGEND	
	NEW TEMPORARY MARKINGS
	EXISTING MARKINGS (GRAY)
	NEW CONSTRUCTION AREAS
	TEMPORARY PAVEMENT
	ON- GOING CONSTRUCTION
	REMOVAL
	OVERLAY/WEDGING

NOTE: THE CONTRACTOR SHALL RELOCATE INFORMATION SIGNS BEFORE CONSTRUCTION REMOVES THEM.
 NOTE: ALL LANE WIDTHS ARE 11' UNLESS OTHERWISE SHOWN.

04-JAN-2024 09:28
 R:\Projects\1-2513A-Work Zone Traffic Control\Traffic\TrafficControl\CP\ProjectWise\Phase 4\I-2513AA-PHASE_4_TMP-37.dgn
 ZG09141412K AT C1F5103

ICE of Carolinas, PLLC
 4505 Falls of Neuse Road, Suite 110
 Raleigh, North Carolina 27609
 Phone: 803-822-0333
 License #: P-0999

APPROVED:
 DATE: 1/4/2024
 SEAL

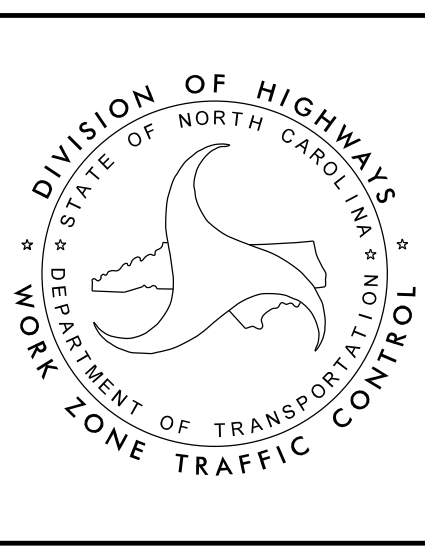

TEMPORARY TRAFFIC CONTROL
PHASE IV DETAIL
AREA 1

A-A

I-40 PHASE 4

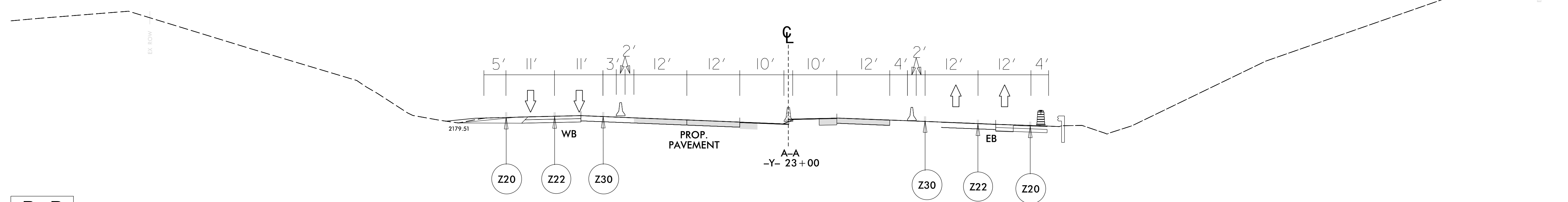

B-B

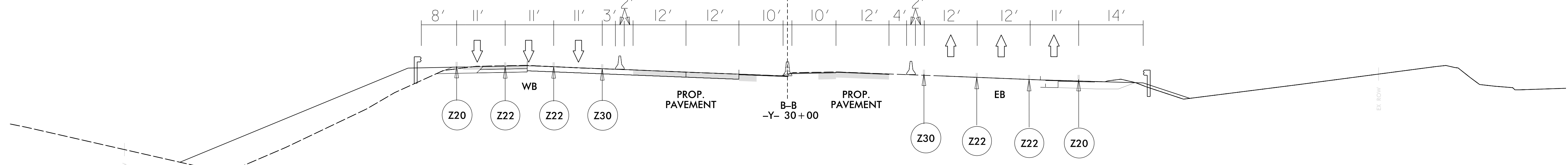

C-C

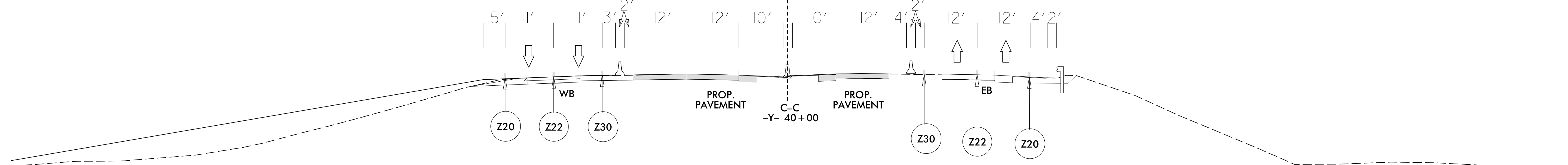

D-D

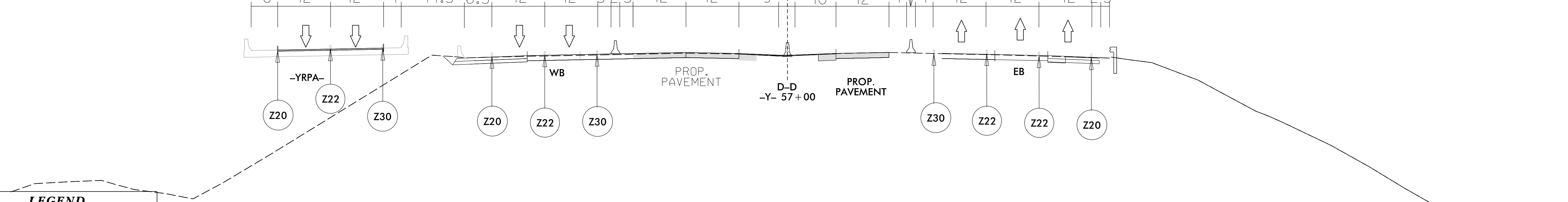

LEGEND

- NEW TEMPORARY MARKINGS
- EXISTING MARKINGS (GRAY)
- NEW CONSTRUCTION AREAS
- TEMPORARY PAVEMENT
- ON-GOING CONSTRUCTION
- REMOVAL
- OVERLAY/WEDGING

NOTE: THE CONTRACTOR SHALL RELOCATE INFORMATION SIGNS BEFORE CONSTRUCTION REMOVES THEM.
 NOTE: ALL LANE WIDTHS ARE 11' UNLESS OTHERWISE SHOWN.

04-JAN-2024 09:30
 R:\Projects\I-40-2513A-Work Zone Traffic Control\TrafficControl\CP\ProjectWise\Phase 4\I-2513AA-Phase-4-TMP-39.dgn
 ZG09141712K AT C1F5103



ICE of Carolinas, PLLC
 4505 Falls of Neuse Road, Suite 110
 Raleigh, North Carolina 27609
 Phone: 803-822-0333
 License #: P-0999

APPROVED: *J. Stuart Bourne*
 DATE: 1/4/2024

SEAL

DOCUMENT NOT CONSIDERED FINAL
 UNLESS ALL SIGNATURES COMPLETED

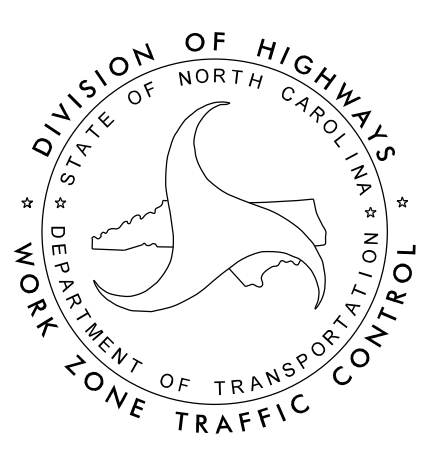

TEMPORARY TRAFFIC CONTROL
 PHASE IV DETAIL
 AREA 1

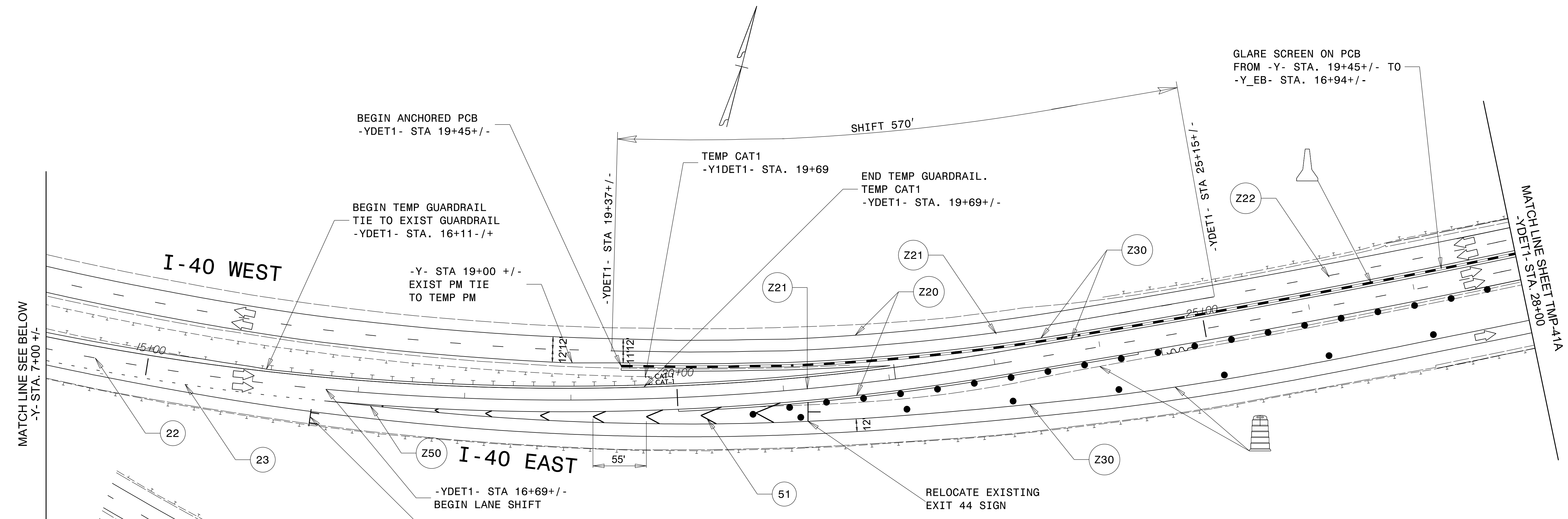

MESSAGE NO. 1	MESSAGE NO. 2
TRAFFIC SHIFT	I-40 EB KEEP LEFT
1 MILE	

CHANGEABLE MESSAGE SIGN

PLACED 1 MILE FROM START OF LANE SHIFT ON I-40 EAST

MESSAGE NO. 1	MESSAGE NO. 2
TRAFFIC SHIFT	I-40 EB KEEP LEFT
1000 FT	

CHANGEABLE MESSAGE SIGN

PLACED 1000 FT FROM START OF LANE SHIFT ON I-40 EAST

NOTE: THE CONTRACTOR SHALL RELOCATE INFORMATION SIGNS BEFORE CONSTRUCTION REMOVES THEM.
NOTE: ALL LANE WIDTHS ARE 11' UNLESS OTHERWISE SHOWN.

LEGEND

	NEW TEMPORARY MARKINGS
	EXISTING MARKINGS (GRAY)
	NEW CONSTRUCTION AREAS
	TEMPORARY PAVEMENT
	ON-GOING CONSTRUCTION
	REMOVAL
	OVERLAY/WEDGING

EXIT 44

T103

T119

W Asheville Enka- Candler

TEMP SIGN
-YDET1- STA 16+50 +/-
SIGN SHALL BE PROTECTED WITH POSITIVE PROTECTION

EXIT 44

T102

T118

W Asheville Enka- Candler

1/2 MILE

TEMP SIGN

EXIT 44

T106

T120

W Asheville Enka- Candler

1 MILE

TEMP SIGN

VERIFY SIGN LOCATION WITH ENGINEER

SIGNS SHALL BE PROTECTED WITH POSITIVE PROTECTION

PLACE 2640 FT AHEAD OF TEMP. GUID SIGN T119

SEE SIGN PHASING SHEET TMP-2F

VERIFY SIGN LOCATION WITH ENGINEER

SIGNS SHALL BE PROTECTED WITH POSITIVE PROTECTION

PLACE 2640 FT AHEAD OF TEMP. GUIDE SIGN T118

SEE SIGN PHASING SHEET TMP-2F

W1-4L
48" X 48"

-YDET1- STA 10+00 +/-

ICE of CAROLINAS, PLLC

ICE of Carolinas, PLLC
4505 Falls of Neuse Road, Suite 110
Raleigh, North Carolina 27609
Phone: 803-822-0333
License #: P-0999

MATCH LINE SEE ABOVE
-Y- STA. 7 + 00 +/-

APPROVED:

DATE: 1/4/2024

SEAL

DOCUMENT NOT CONSIDERED FINAL UNLESS ALL SIGNATURES COMPLETED

DIVISION OF HIGHWAYS
STATE OF NORTH CAROLINA
DEPARTMENT OF TRANSPORTATION
WORK ZONE TRAFFIC CONTROL

TEMPORARY TRAFFIC CONTROL PHASE V DETAIL AREA 1

04-JAN-2024 09:34 R:\Projects\2024\01-2513AA\Work Zone Traffic Control\Traffic\TrafficControl\CPA\ProjectWise\Phase 5\I-2513AA_PHASE_5_TMP-41.dgn

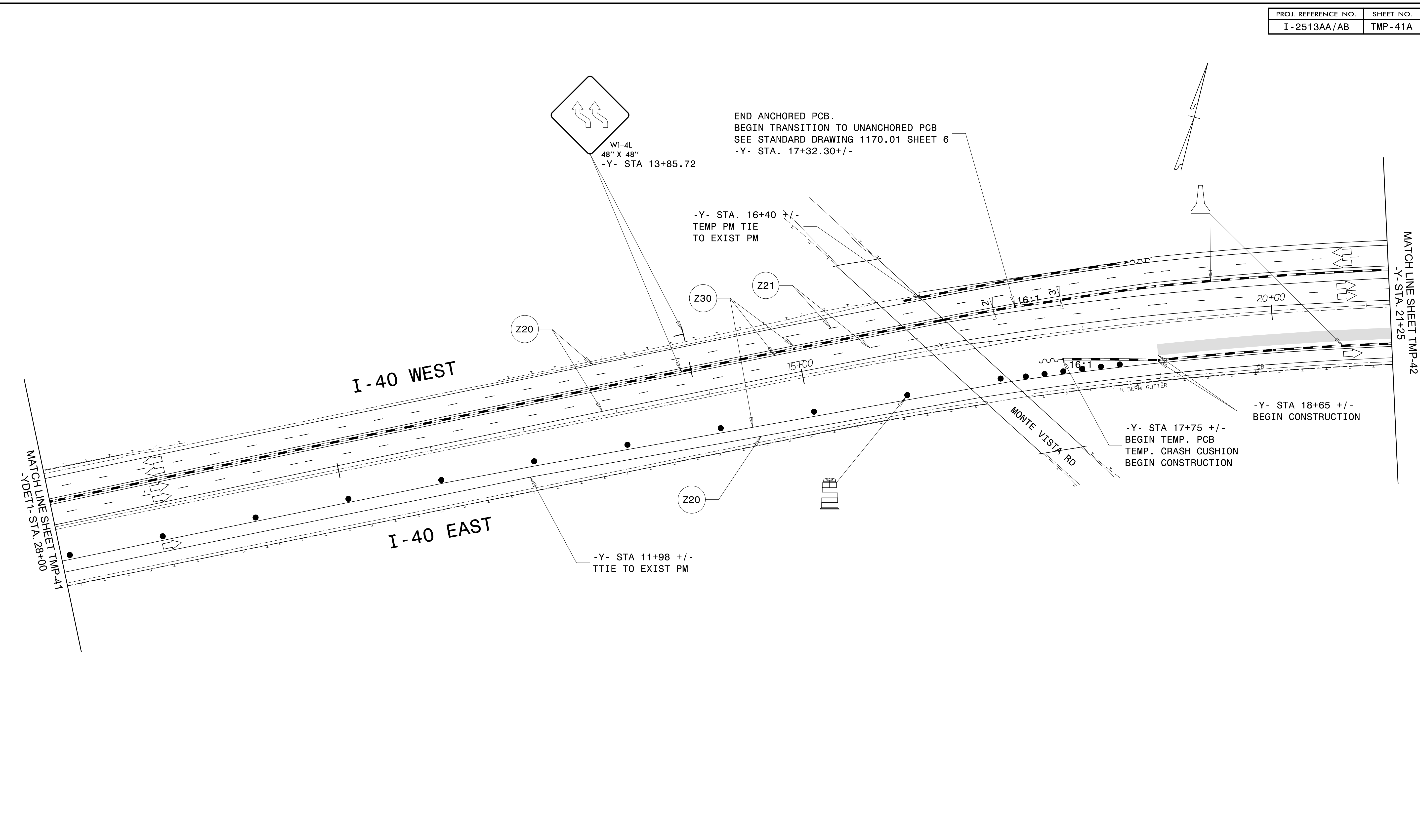

LEGEND

	NEW TEMPORARY MARKINGS
	EXISTING MARKINGS (GRAY)
	NEW CONSTRUCTION AREAS
	TEMPORARY PAVEMENT
	ON-GOING CONSTRUCTION
	REMOVAL
	OVERLAY/WEDGING

NOTE: THE CONTRACTOR SHALL RELOCATE INFORMATION SIGNS BEFORE CONSTRUCTION REMOVES THEM.
 NOTE: ALL LANE WIDTHS ARE 11' UNLESS OTHERWISE SHOWN.

04-JAN-2024 09:35
 R:\Projects\I-2513AA\Work Zone Traffic Control\Traffic Control\CP\ProjectWise\Phase 5\I-2513AA_PHASE_5_TMP-41A.dgn
 Z:\C:\Users\jstuart\Documents\AT_C1F5103

ICE of CAROLINAS, PLLC
 4505 Falls of Neuse Road, Suite 110
 Raleigh, North Carolina 27609
 Phone: 803-822-0333
 License #: P-0999

APPROVED: *J. Stuart Bourne*
 DATE: 1/4/2024
 SEAL
 DOCUMENT NOT CONSIDERED FINAL
 UNLESS ALL SIGNATURES COMPLETED

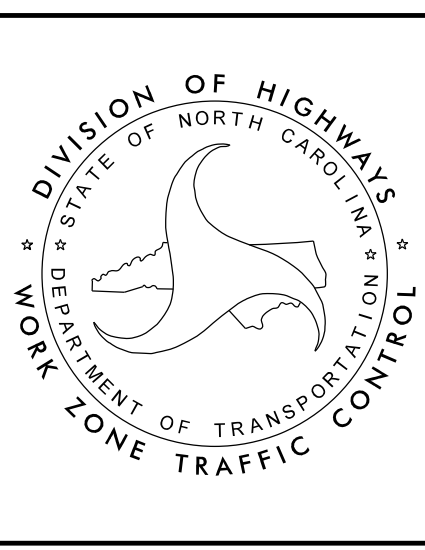

TEMPORARY TRAFFIC CONTROL PHASE V DETAIL AREA 1

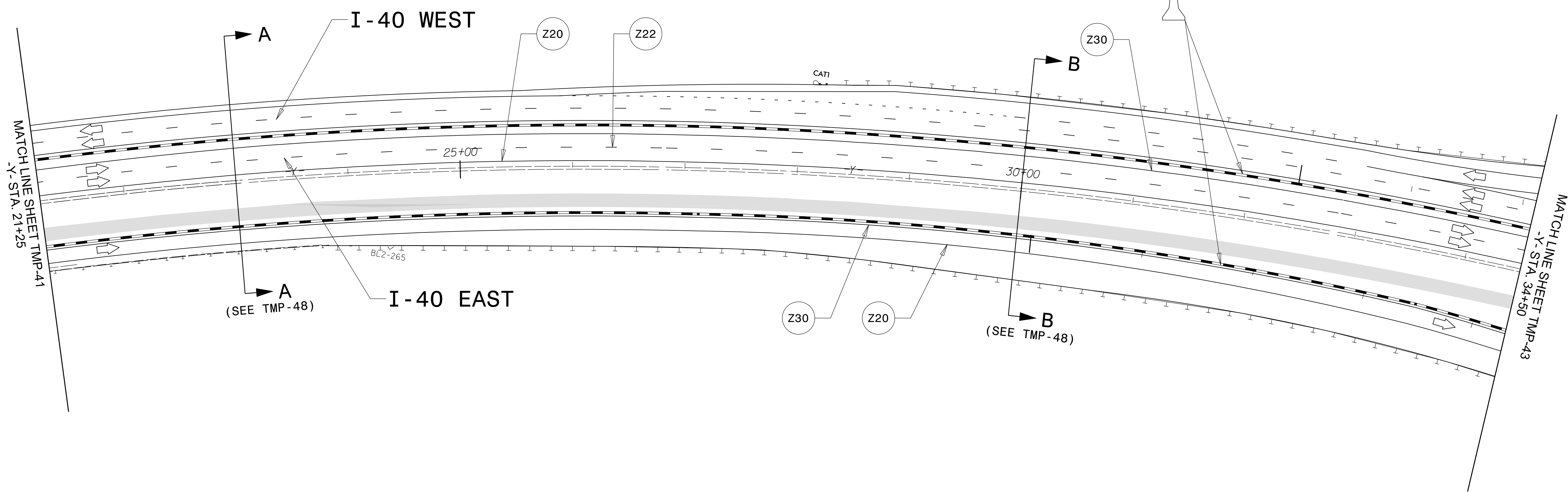

04-JAN-2024 09:36
 R:\Projects\I-25\01-2513A_Work Zone Traffic Control\Traffic Control\CP\ProjectWise\Phase 5\I-2513AA-Phase_5_TMP-42.dgn
 Z:\CP\I-25\I-2513A-Work Zone Traffic Control\Traffic Control\CP\ProjectWise\Phase 5\I-2513AA-Phase_5_TMP-42.dgn

LEGEND	
	NEW TEMPORARY MARKINGS
	EXISTING MARKINGS (GRAY)
	NEW CONSTRUCTION AREAS
	TEMPORARY PAVEMENT
	ON-GOING CONSTRUCTION
	REMOVAL
	OVERLAY/WEDGING

NOTE: THE CONTRACTOR SHALL RELOCATE INFORMATION SIGNS BEFORE CONSTRUCTION REMOVES THEM.

NOTE: ALL LANE WIDTHS ARE 11' UNLESS OTHERWISE SHOWN.

ICE of Carolinas, PLLC
 4505 Falls of Neuse Road, Suite 110
 Raleigh, North Carolina 27609
 Phone: 803-822-0333
 License #: P-0999

APPROVED:
 DATE: 1/4/2024
 SEAL

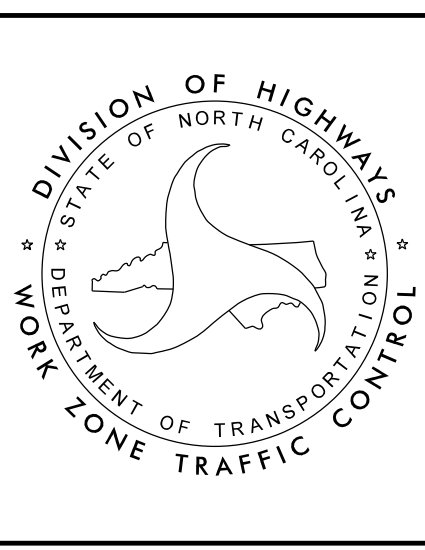

TEMPORARY TRAFFIC CONTROL
PHASE V DETAIL
AREA 1

DOCUMENT NOT CONSIDERED FINAL UNLESS ALL SIGNATURES COMPLETED

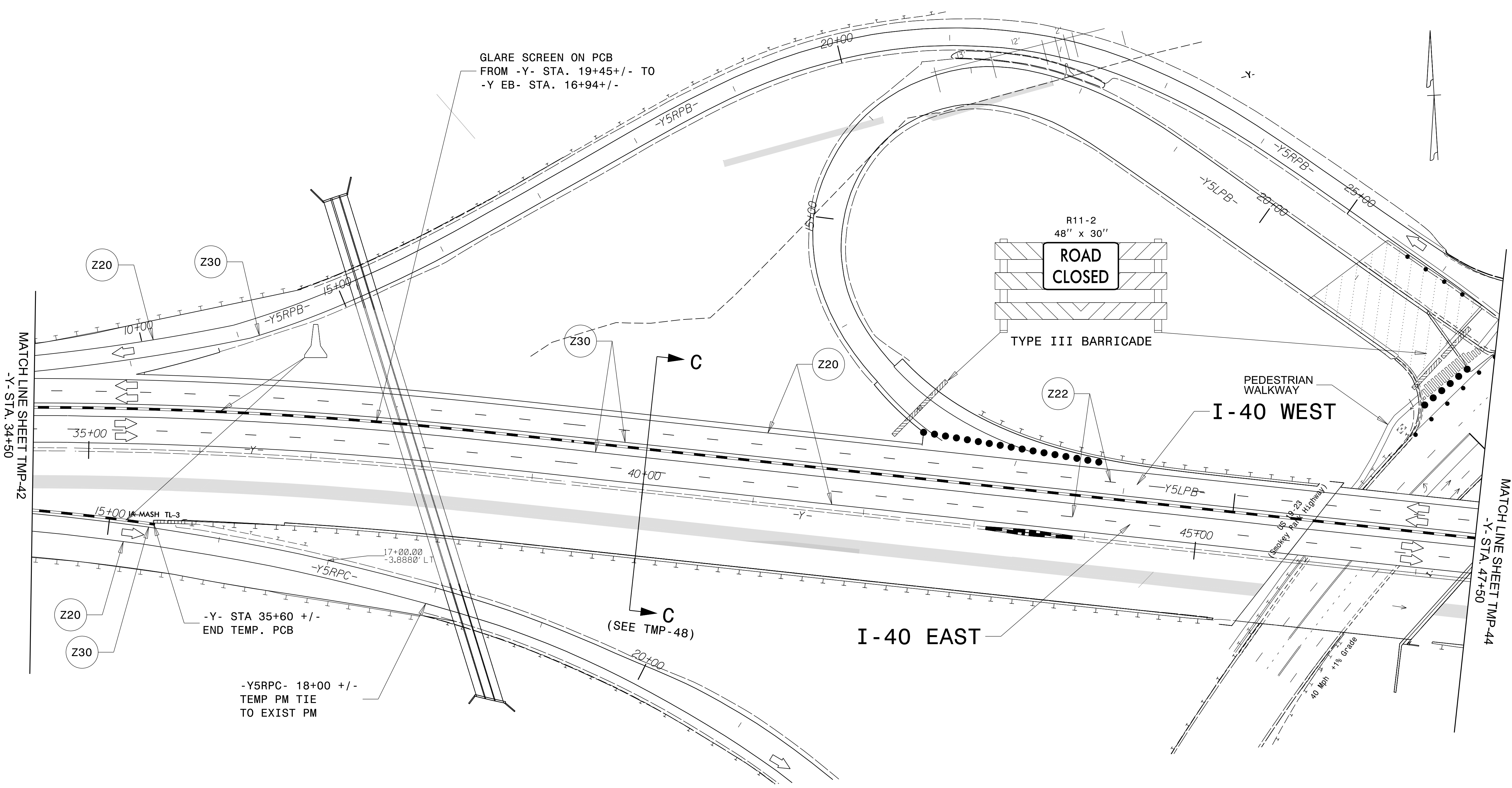

LEGEND

	NEW TEMPORARY MARKINGS
	EXISTING MARKINGS (GRAY)
	NEW CONSTRUCTION AREAS
	TEMPORARY PAVEMENT
	ON-GOING CONSTRUCTION
	REMOVAL
	OVERLAY/WEDGING

NOTE: THE CONTRACTOR SHALL RELOCATE INFORMATION SIGNS BEFORE CONSTRUCTION REMOVES THEM.

NOTE: ALL LANE WIDTHS ARE 11' UNLESS OTHERWISE SHOWN.

ICE of CAROLINAS, PLLC

ICE of Carolinas, PLLC
4505 Falls of Neuse Road, Suite 110
Raleigh, North Carolina 27609
Phone: 803-822-0333
License #: P-0999

APPROVED:

DATE: 1/4/2024

SEAL

**DOCUMENT NOT CONSIDERED FINAL
UNLESS ALL SIGNATURES COMPLETED**

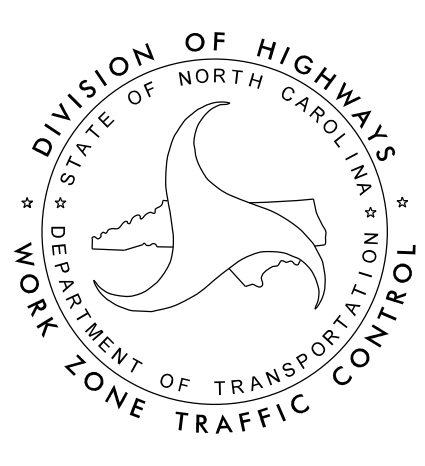

**TEMPORARY TRAFFIC CONTROL
PHASE V DETAIL
AREA 1**

04-JAN-2024 09:50 R:\Projects\1-2513A Work Zone Traffic Control\Traffic Control\Traffic Control\Phase 5 TMP-43.dgn

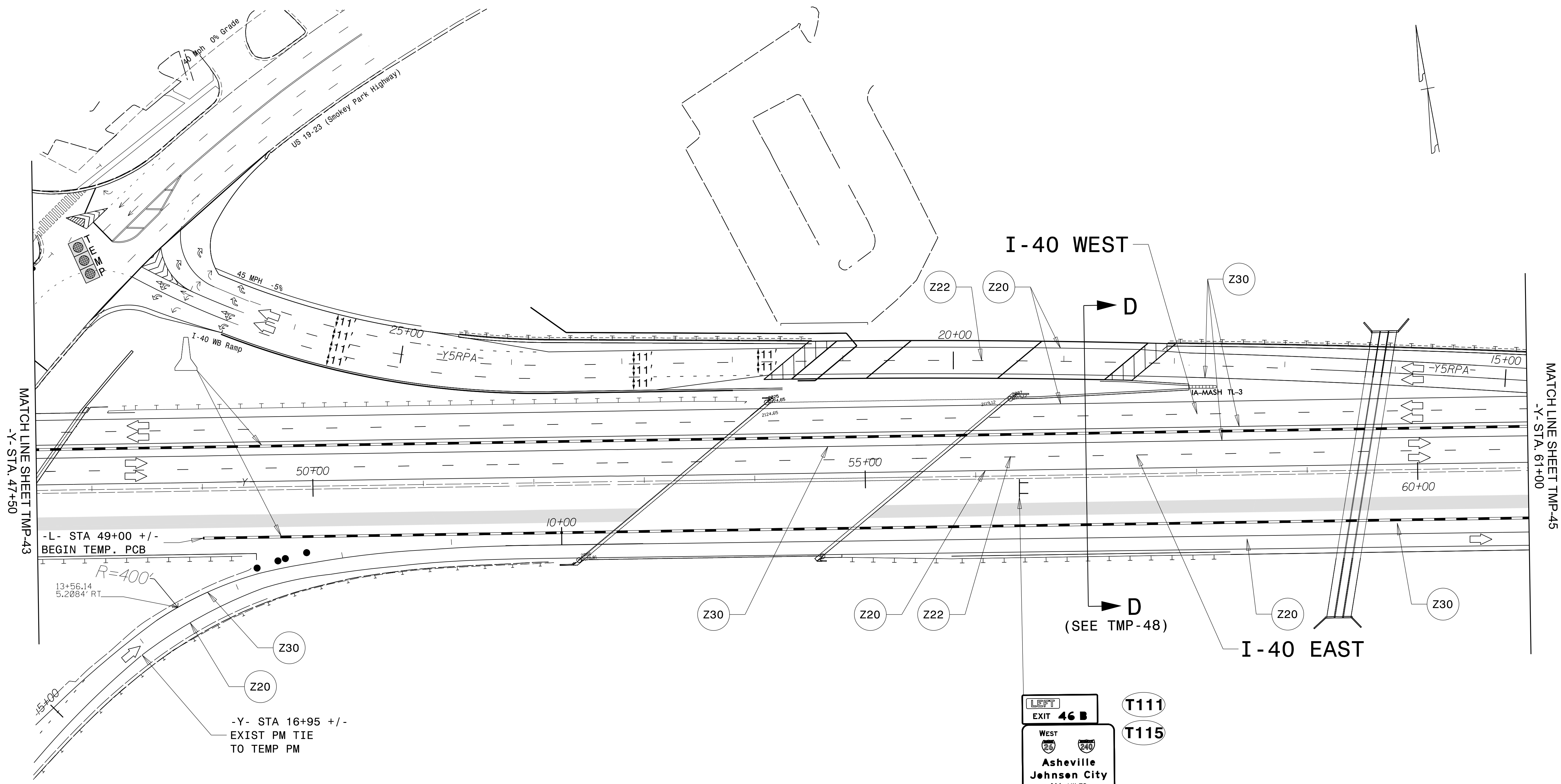

MATCH LINE SHEET TMP-43
-Y- STA. 47+50

MATCH LINE SHEET TMP-45
-Y- STA. 61+00

-L- STA 49+00 +/-
BEGIN TEMP. PCB

-Y- STA 16+95 +/-
EXIST PM TIE
TO TEMP PM

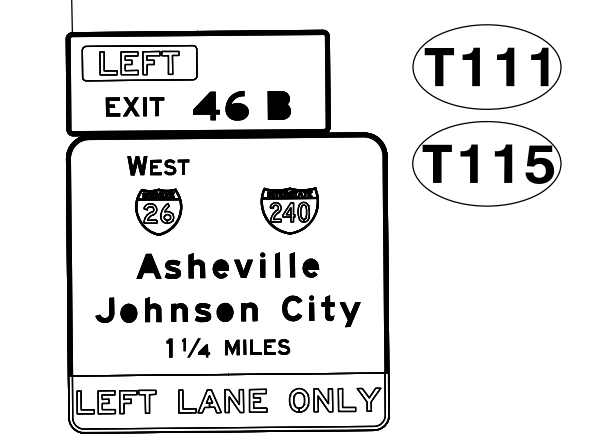

-Y- STA 56+40 +/-
TEMP SIGN

VERIFY SIGN LOCATION
WITH ENGINEER

SIGNS SHALL BE PROTECTED
WITH POSITIVE PROTECTION

LEGEND

	NEW TEMPORARY MARKINGS
	EXISTING MARKINGS (GRAY)
	NEW CONSTRUCTION AREAS
	TEMPORARY PAVEMENT
	ON-GOING CONSTRUCTION
	REMOVAL
	OVERLAY/WEDGING

NOTE: THE CONTRACTOR SHALL RELOCATE INFORMATION SIGNS BEFORE CONSTRUCTION REMOVES THEM.

NOTE: ALL LANE WIDTHS ARE 11' UNLESS OTHERWISE SHOWN.

04-JAN-2024 09:51
R:\Projects\18-08-01-253A_Work Zone Traffic Control\Traffic\TrafficControl\CP\ProjectWise\Phase 5\I-2513AA-Phase-5-TMP-44.dgn
ZG08011212K AT C1F5103

ICE of CAROLINAS, PLLC

ICE of Carolinas, PLLC
4505 Falls of Neuse Road, Suite 110
Raleigh, North Carolina 27609
Phone: 803-822-0333
License #: P-0999

APPROVED:

DATE: 1/4/2024

SEAL

**DOCUMENT NOT CONSIDERED FINAL
UNLESS ALL SIGNATURES COMPLETED**

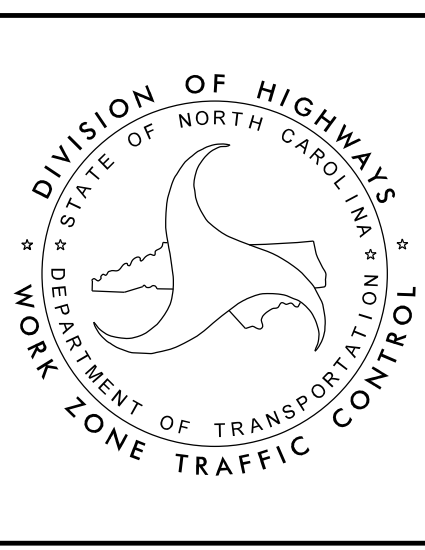

**TEMPORARY TRAFFIC CONTROL
PHASE V DETAIL
AREA 1**

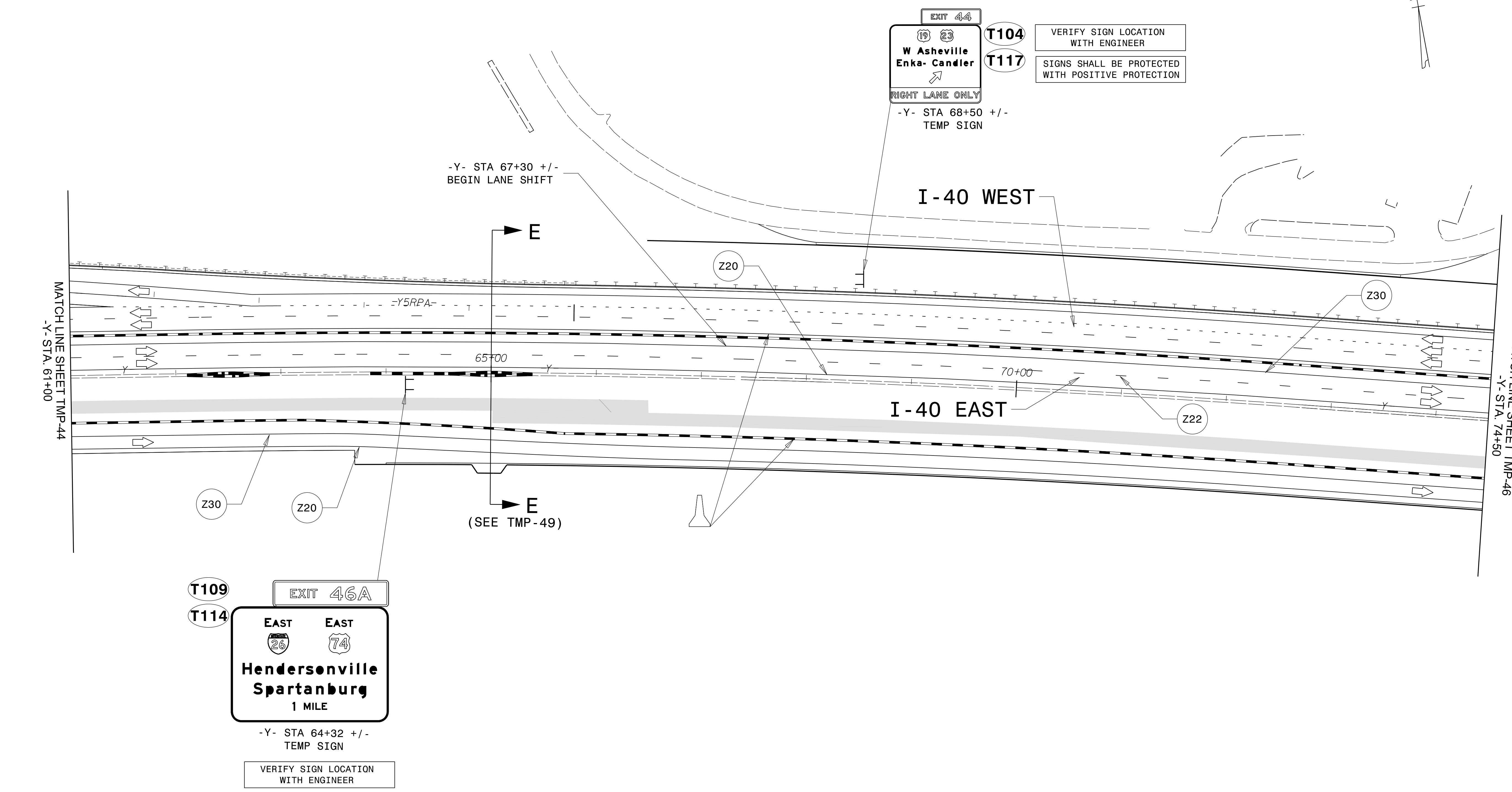

LEGEND

	NEW TEMPORARY MARKINGS
	EXISTING MARKINGS (GRAY)
	NEW CONSTRUCTION AREAS
	TEMPORARY PAVEMENT
	ON-GOING CONSTRUCTION
	REMOVAL
	OVERLAY/WEDGING

NOTE: THE CONTRACTOR SHALL RELOCATE INFORMATION SIGNS BEFORE CONSTRUCTION REMOVES THEM.
NOTE: ALL LANE WIDTHS ARE 11' UNLESS OTHERWISE SHOWN.

04-JAN-2024 09:52
R:\Projects\11-08-01-253A_WorkZone_TrafficControl\TrafficControl\CP\ProjectWise\Phase 5\I-2513AA-Phase_5_TMP-45.dgn
ZG00101111ZK AT C1F5103

ICE of Carolinas, PLLC
4505 Falls of Neuse Road, Suite 110
Raleigh, North Carolina 27609
Phone: 803-822-0333
License #: P-0999

APPROVED:
DATE: 1/4/2024
SEAL:

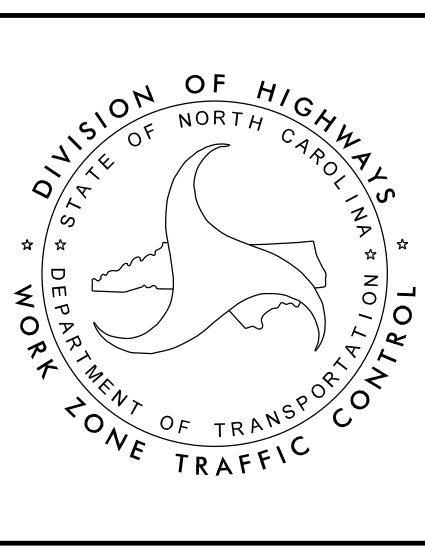

TEMPORARY TRAFFIC CONTROL
PHASE V DETAIL
AREA 1

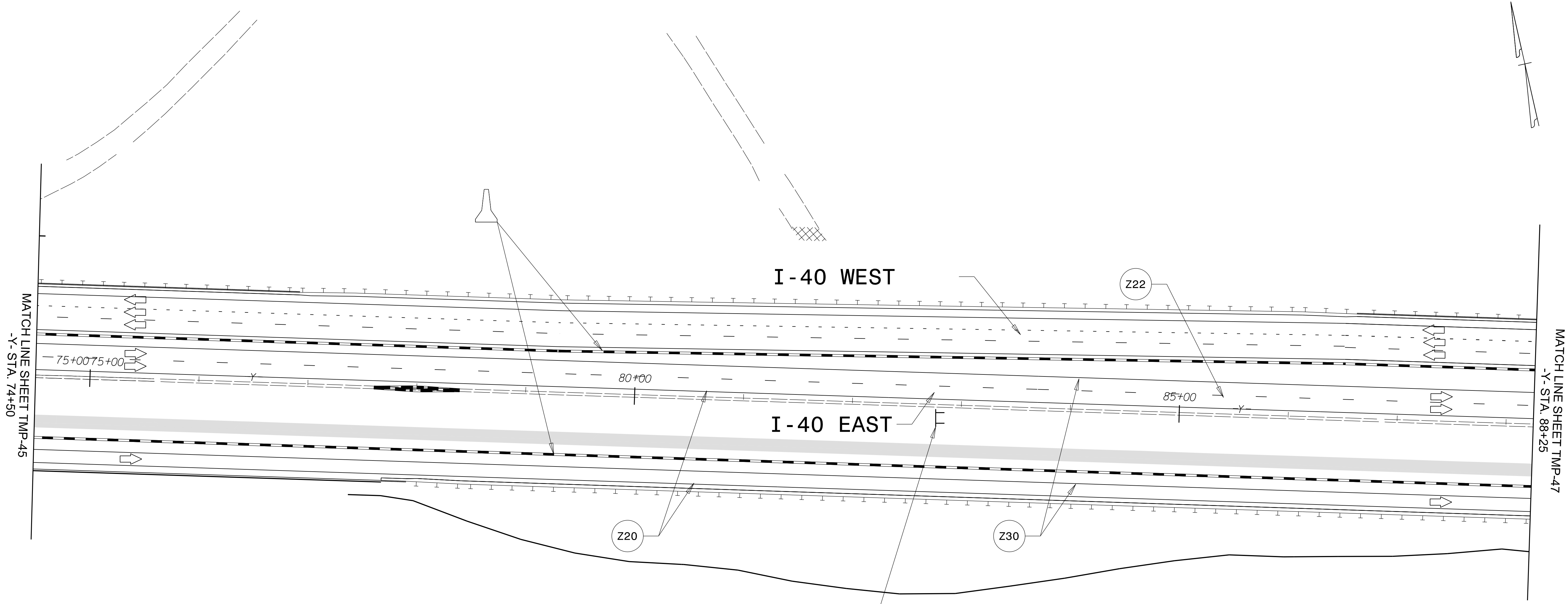

LEGEND	
	NEW TEMPORARY MARKINGS
	EXISTING MARKINGS (GRAY)
	NEW CONSTRUCTION AREAS
	TEMPORARY PAVEMENT
	ON- GOING CONSTRUCTION
	REMOVAL
	OVERLAY/ WEDGING

NOTE: THE CONTRACTOR SHALL RELOCATE INFORMATION SIGNS BEFORE CONSTRUCTION REMOVES THEM.

NOTE: ALL LANE WIDTHS ARE 11' UNLESS OTHERWISE SHOWN.

04-JAN-2024 01:53 R:\Projects\1-08-01-2513A-Work Zone Traffic Control\Traffic\TrafficControl\CP\ProjectWise\Phase 5\I-2513AA-Phase-5-TMP-46.dgn

ICE of Carolinas, PLLC
 4505 Falls of Neuse Road, Suite 110
 Raleigh, North Carolina 27609
 Phone: 803-822-0333
 License #: P-0999

APPROVED:

DATE: 1/4/2024

SEAL

DOCUMENT NOT CONSIDERED FINAL UNLESS ALL SIGNATURES COMPLETED

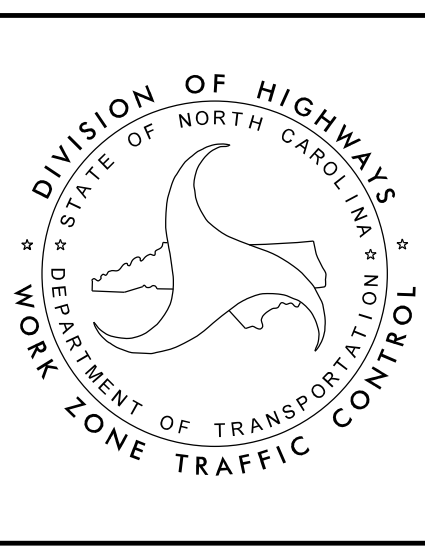

TEMPORARY TRAFFIC CONTROL PHASE V DETAIL AREA 1

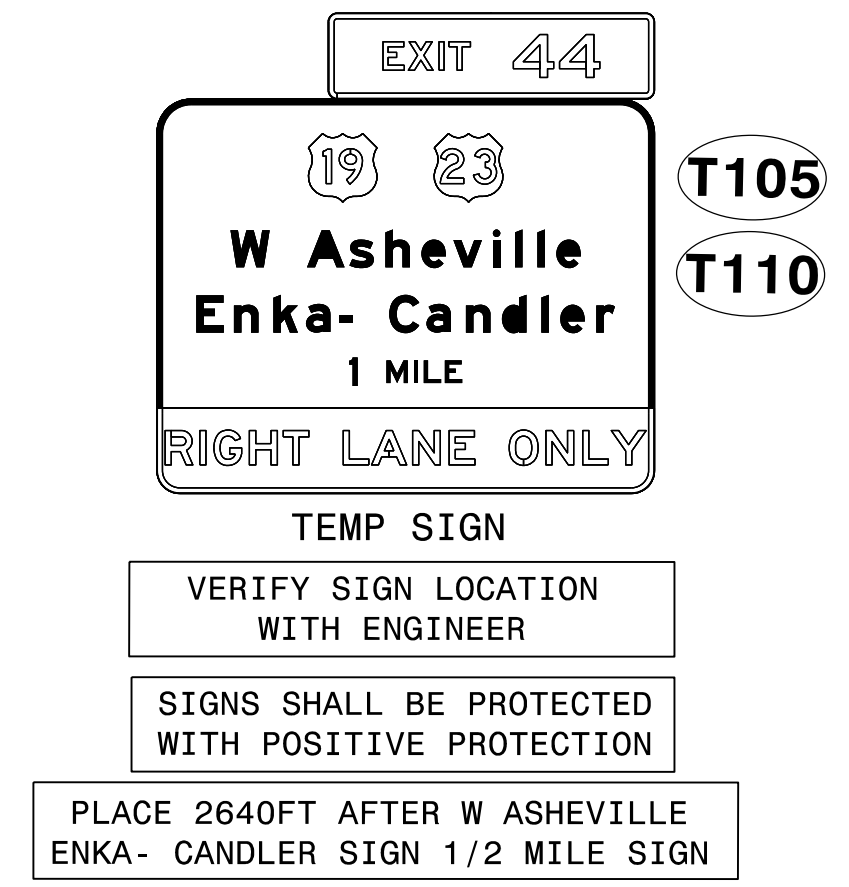
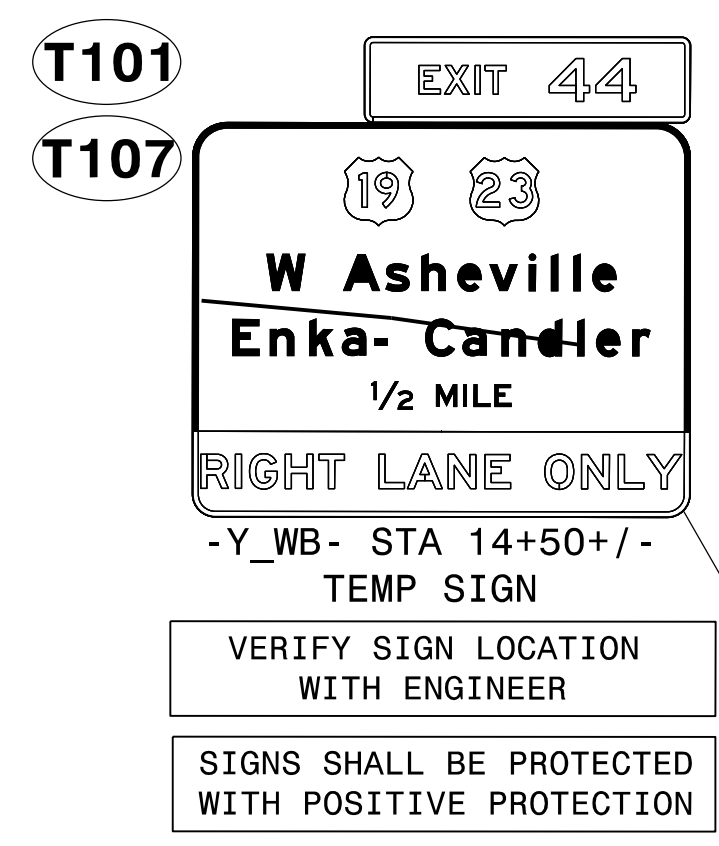
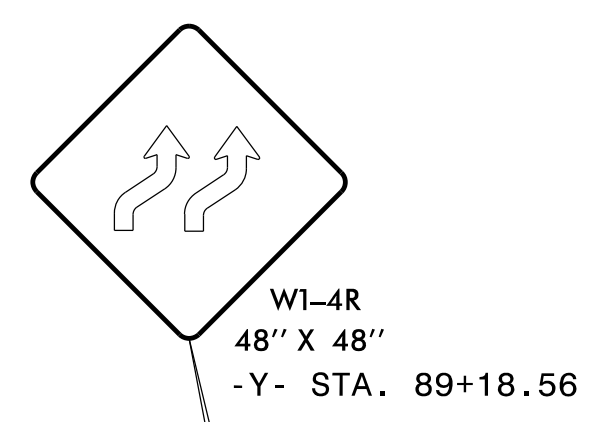

MATCH LINE SHEET TMP-46 -Y- STA. 88+25

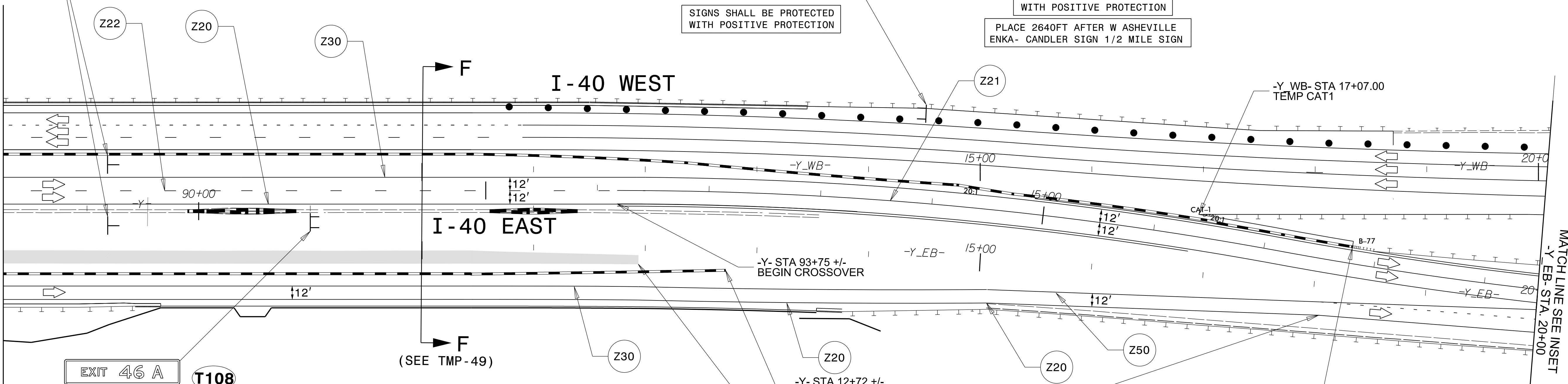

MATCH LINE SEE INSET -Y- EB- STA. 20+00

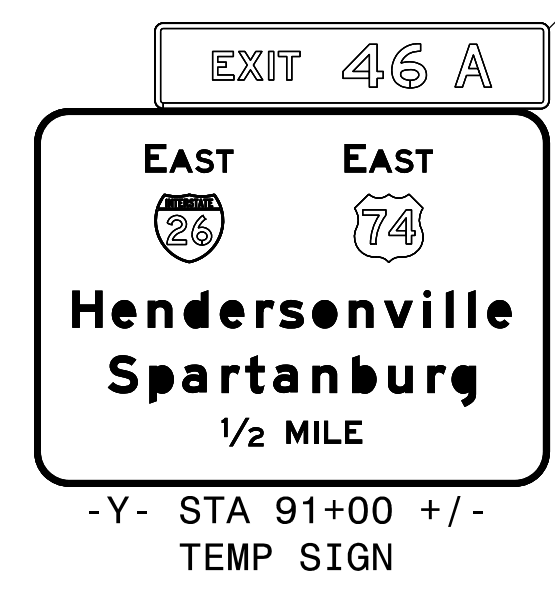

VERIFY SIGN LOCATION WITH ENGINEER
SIGNS SHALL BE PROTECTED WITH POSITIVE PROTECTION

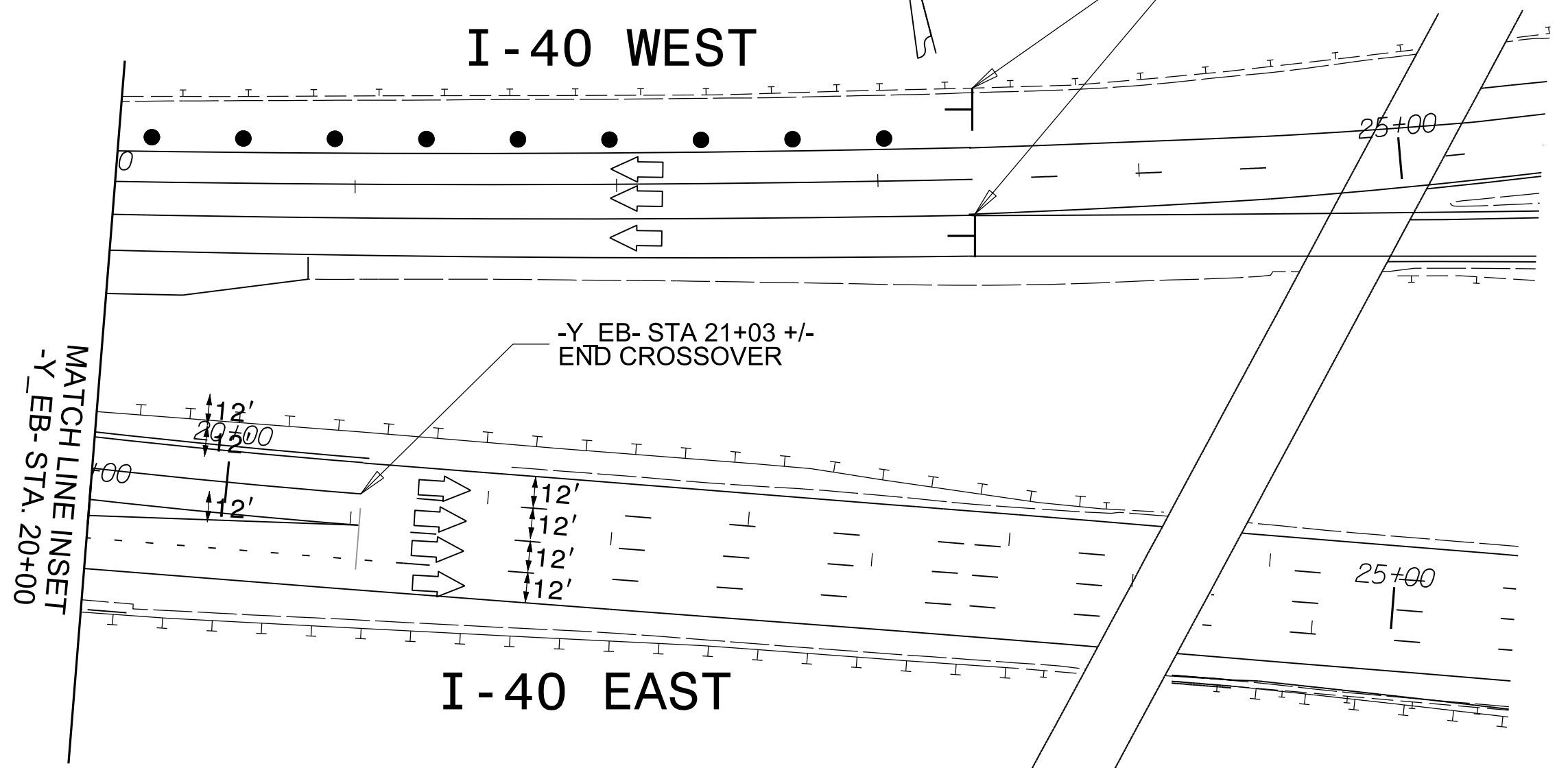
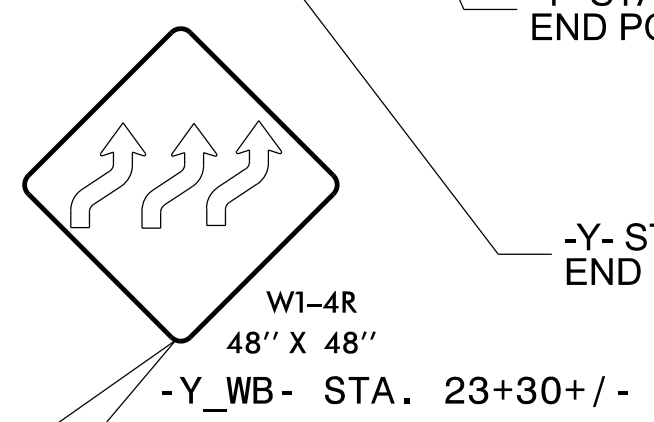

LEGEND

	NEW TEMPORARY MARKINGS
	EXISTING MARKINGS (GRAY)
	NEW CONSTRUCTION AREAS
	TEMPORARY PAVEMENT
	ON- GOING CONSTRUCTION
	REMOVAL
	OVERLAY/ WEDGING

NOTE: THE CONTRACTOR SHALL RELOCATE INFORMATION SIGNS BEFORE CONSTRUCTION REMOVES THEM.
NOTE: ALL LANE WIDTHS ARE 11' UNLESS OTHERWISE SHOWN.

ICE of CAROLINAS, PLLC

ICE of Carolinas, PLLC
4505 Falls of Neuse Road, Suite 110
Raleigh, North Carolina 27609
Phone: 803-822-0333
License #: P-0999

APPROVED: *J. Stuart Bourne*
DATE: 1/4/2024

SEAL

DOCUMENT NOT CONSIDERED FINAL UNLESS ALL SIGNATURES COMPLETED

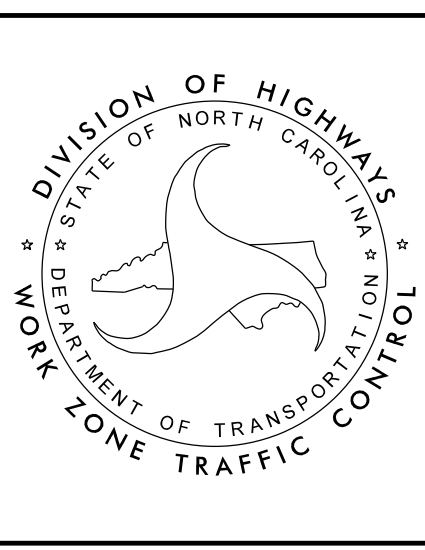

DIVISION OF HIGHWAYS
STATE OF NORTH CAROLINA
DEPARTMENT OF TRANSPORTATION
WORK ZONE TRAFFIC CONTROL

TEMPORARY TRAFFIC CONTROL PHASE V DETAIL AREA 1

04-JAN-2024 09:54 R:\Projects\I-2513AA-08-01-2513AA-Work Zone Traffic Control\Traffic Control\I-2513AA-Phase 5-TMP-47.dgn

A-A

I-40 PHASE 5

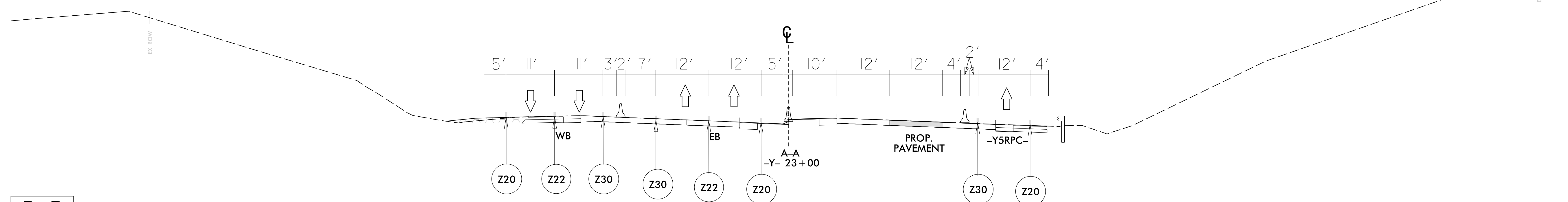

B-B

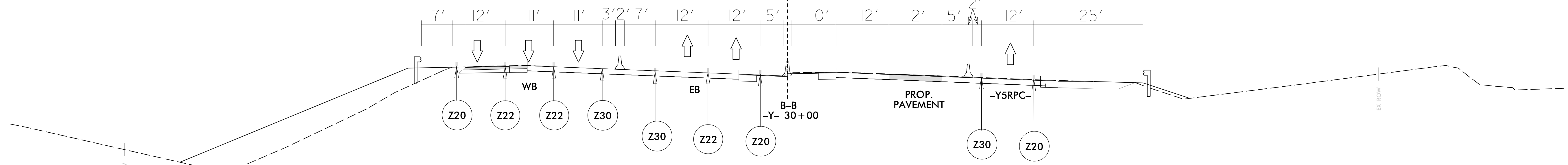

C-C

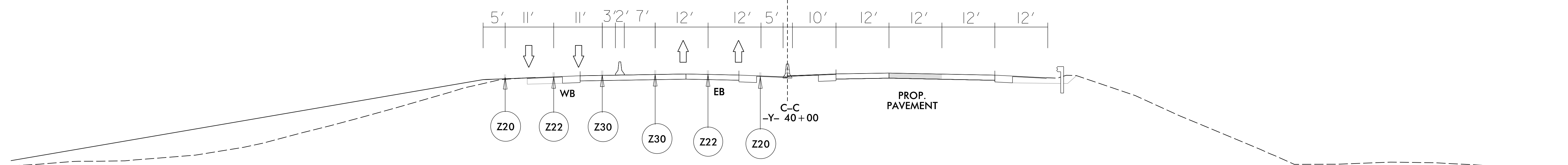

D-D

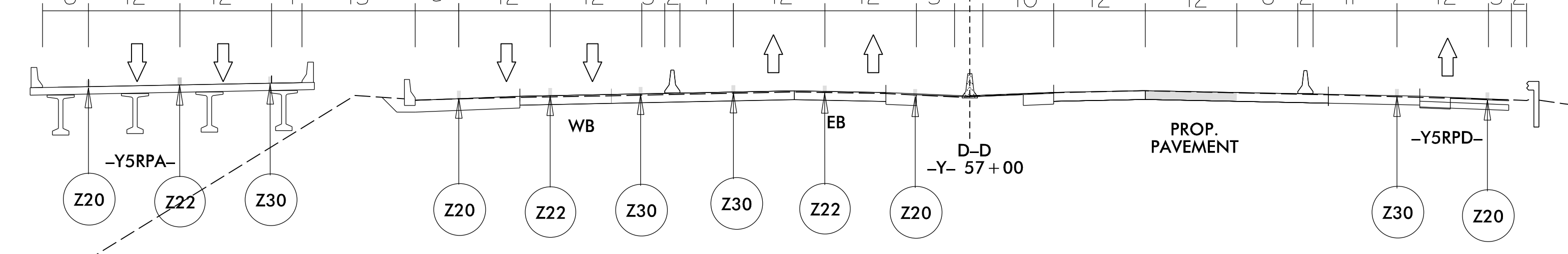

LEGEND

- NEW TEMPORARY MARKINGS
- EXISTING MARKINGS (GRAY)
- NEW CONSTRUCTION AREAS
- TEMPORARY PAVEMENT
- ON-GOING CONSTRUCTION
- REMOVAL
- OVERLAY/WEDGING

NOTE: THE CONTRACTOR SHALL RELOCATE INFORMATION SIGNS BEFORE CONSTRUCTION REMOVES THEM.

NOTE: ALL LANE WIDTHS ARE 11' UNLESS OTHERWISE SHOWN.

04-JAN-2024 09:55
 R:\Projects\I-40-2513A_Work Zone Traffic Control\Traffic\TrafficControl\CP\ProjectWise\Phase 5\I-2513AA_PHASE_5_TMP-48.dgn
 ZG00010112K AT C1F5103



ICE of Carolinas, PLLC
 4505 Falls of Neuse Road, Suite 110
 Raleigh, North Carolina 27609
 Phone: 803-822-0333
 License #: P-0999

APPROVED:
 DATE: 1/4/2024

SEAL

**DOCUMENT NOT CONSIDERED FINAL
 UNLESS ALL SIGNATURES COMPLETED**

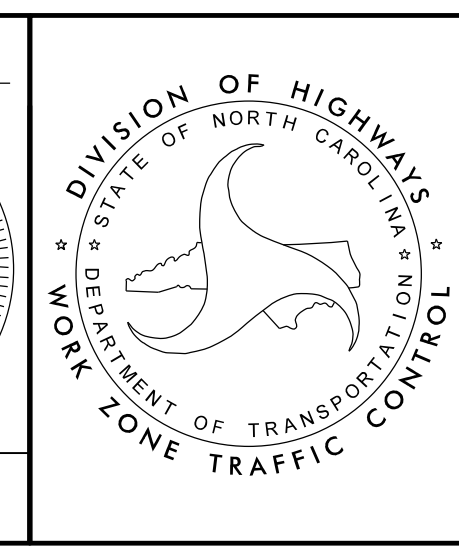

**TEMPORARY TRAFFIC CONTROL
 PHASE V DETAIL
 AREA 1**

I-25 PHASE 5

E-E

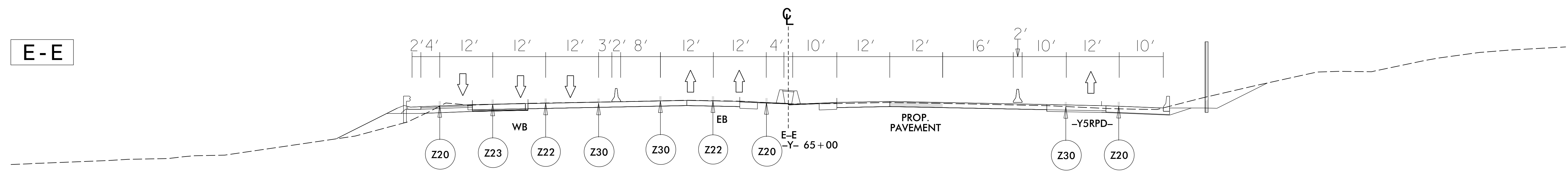

F-F

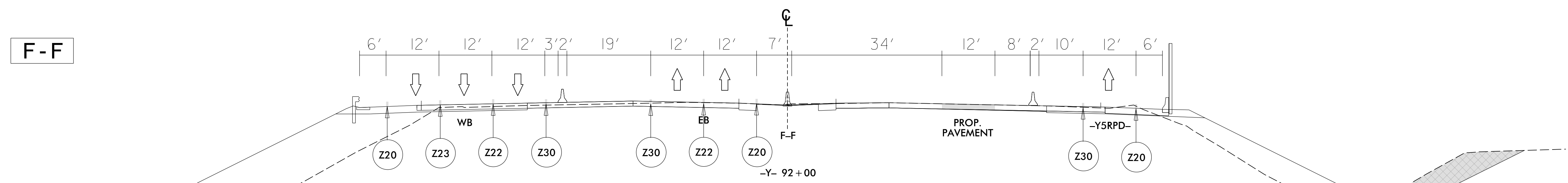

04-JAN-2024 01:55 R:\Projects\I-25\01-2513A_Work Zone Traffic Control\Traffic Control\CP\ProjectWise\Phase 5\I-2513AA_PHASE_5_TMP-49.dgn

LEGEND

	NEW TEMPORARY MARKINGS
	EXISTING MARKINGS (GRAY)
	NEW CONSTRUCTION AREAS
	TEMPORARY PAVEMENT
	ON-GOING CONSTRUCTION
	REMOVAL
	OVERLAY/WEDGING

NOTE: THE CONTRACTOR SHALL RELOCATE INFORMATION SIGNS BEFORE CONSTRUCTION REMOVES THEM.

NOTE: ALL LANE WIDTHS ARE 11' UNLESS OTHERWISE SHOWN.

ICE of Carolinas, PLLC
 4505 Falls of Neuse Road, Suite 110
 Raleigh, North Carolina 27609
 Phone: 803-822-0333
 License #: P-0999

APPROVED:
 DATE: 1/4/2024

SEAL

DOCUMENT NOT CONSIDERED FINAL UNLESS ALL SIGNATURES COMPLETED

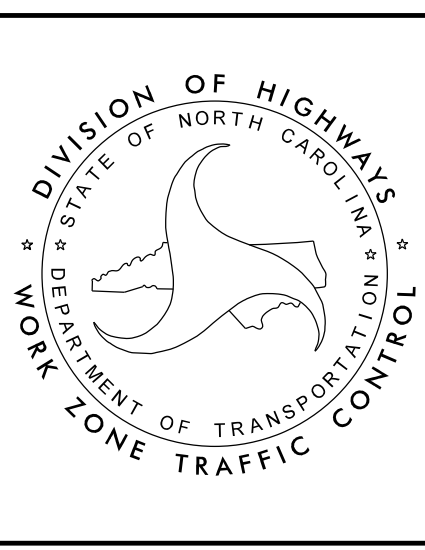

TEMPORARY TRAFFIC CONTROL PHASE V DETAIL AREA 1

NOTE: SEE FINAL PAVEMENT MARKING PLANS

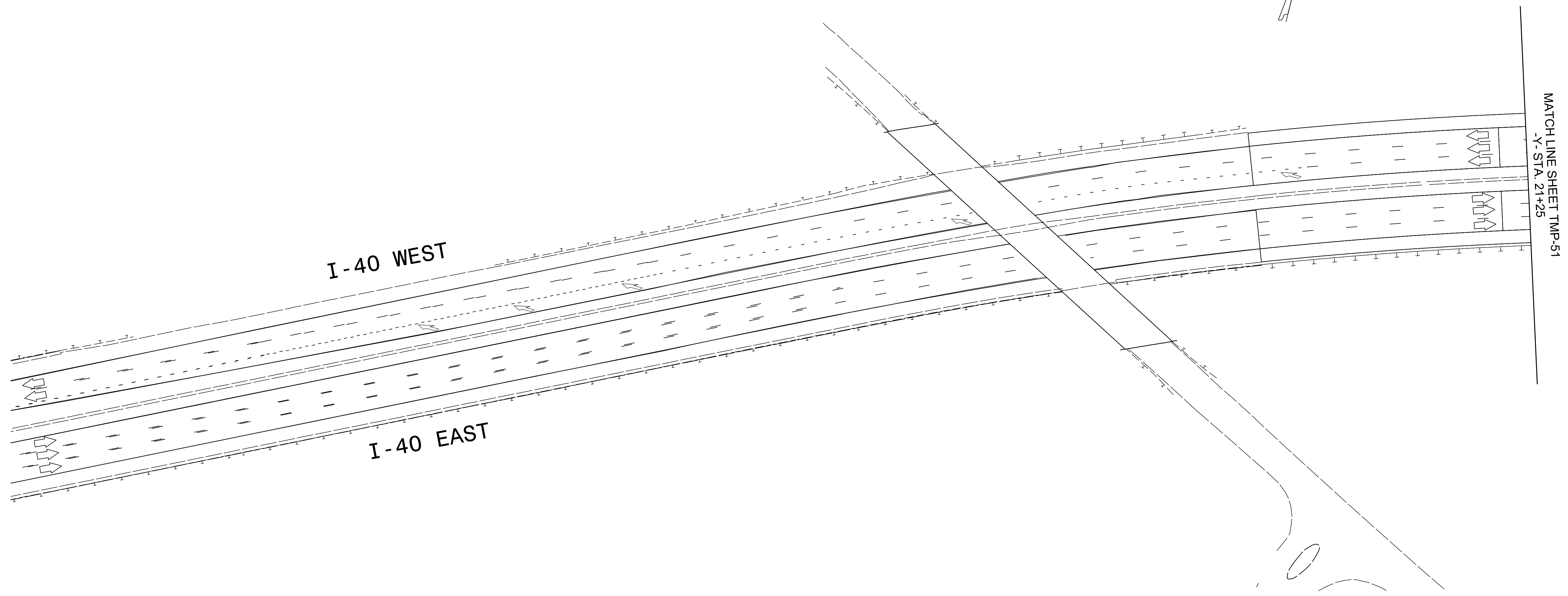

04-JAN-2024 01:58 R:\Projects\1-08-01-2513A_Work Zone Traffic Control\Traffic\TrafficControl\CP\ProjectWise\Phase 6\I-2513AA-PHASE_6_TMP-50.dgn

LEGEND	
	NEW TEMPORARY MARKINGS
	EXISTING MARKINGS (GRAY)
	NEW CONSTRUCTION AREAS
	TEMPORARY PAVEMENT
	ON- GOING CONSTRUCTION
	REMOVAL
	OVERLAY/ WEDGING

NOTE: MICRO GROOVE ALL CONCRETE PAVEMENT.



ICE of Carolinas, PLLC
 4505 Falls of Neuse Road, Suite 110
 Raleigh, North Carolina 27609
 Phone: 803-822-0333
 License #: P-0999

APPROVED:
DocuSigned by: J. Stuart Bourne E8E4093CCA254AC...

DATE: 1/4/2024

SEAL

**DOCUMENT NOT CONSIDERED FINAL
UNLESS ALL SIGNATURES COMPLETED**

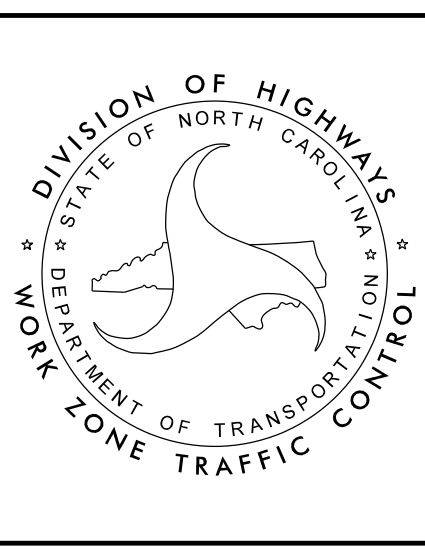

**TEMPORARY TRAFFIC CONTROL
PHASE VI DETAIL
AREA 1**

NOTE: SEE FINAL PAVEMENT MARKING PLANS

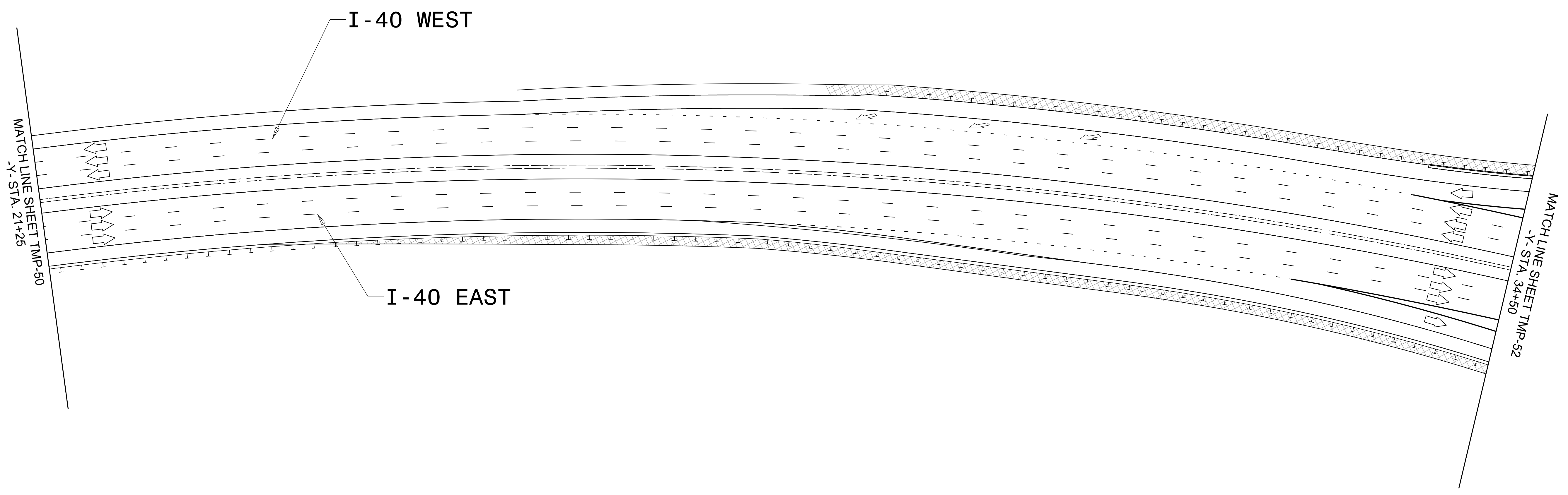
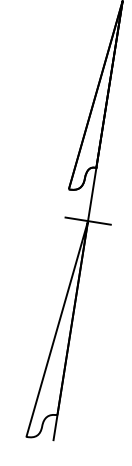

LEGEND	
	NEW TEMPORARY MARKINGS
	EXISTING MARKINGS (GRAY)
	NEW CONSTRUCTION AREAS
	TEMPORARY PAVEMENT
	ON-GOING CONSTRUCTION
	REMOVAL
	OVERLAY/WEDGING

NOTE: MICRO GROOVE ALL CONCRETE PAVEMENT.

04-JAN-2024 01:59 R:\Projects\1-08-01-2513A_Work Zone Traffic Control\Traffic Control\ProjectWise\Phase 6\I-2513AA_PHASE_6_TMP-51.dgn

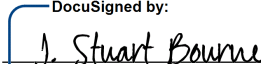

ICE of Carolinas, PLLC
 4505 Falls of Neuse Road, Suite 110
 Raleigh, North Carolina 27609
 Phone: 803-822-0333
 License #: P-0999

APPROVED: 
DocuSigned by: J. Stuart Bourne E8E4093CCA254AC...

DATE: 1/4/2024

SEAL

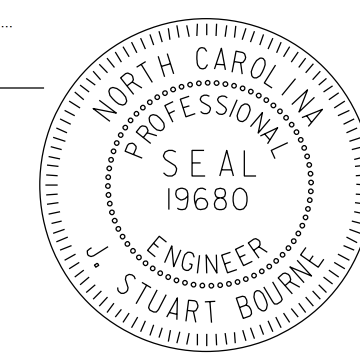

**DOCUMENT NOT CONSIDERED FINAL
UNLESS ALL SIGNATURES COMPLETED**

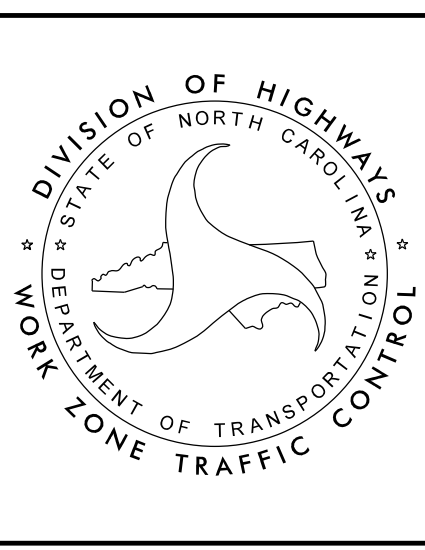

**TEMPORARY TRAFFIC CONTROL
PHASE VI DETAIL
AREA 1**

NOTE: SEE FINAL PAVEMENT MARKING PLANS

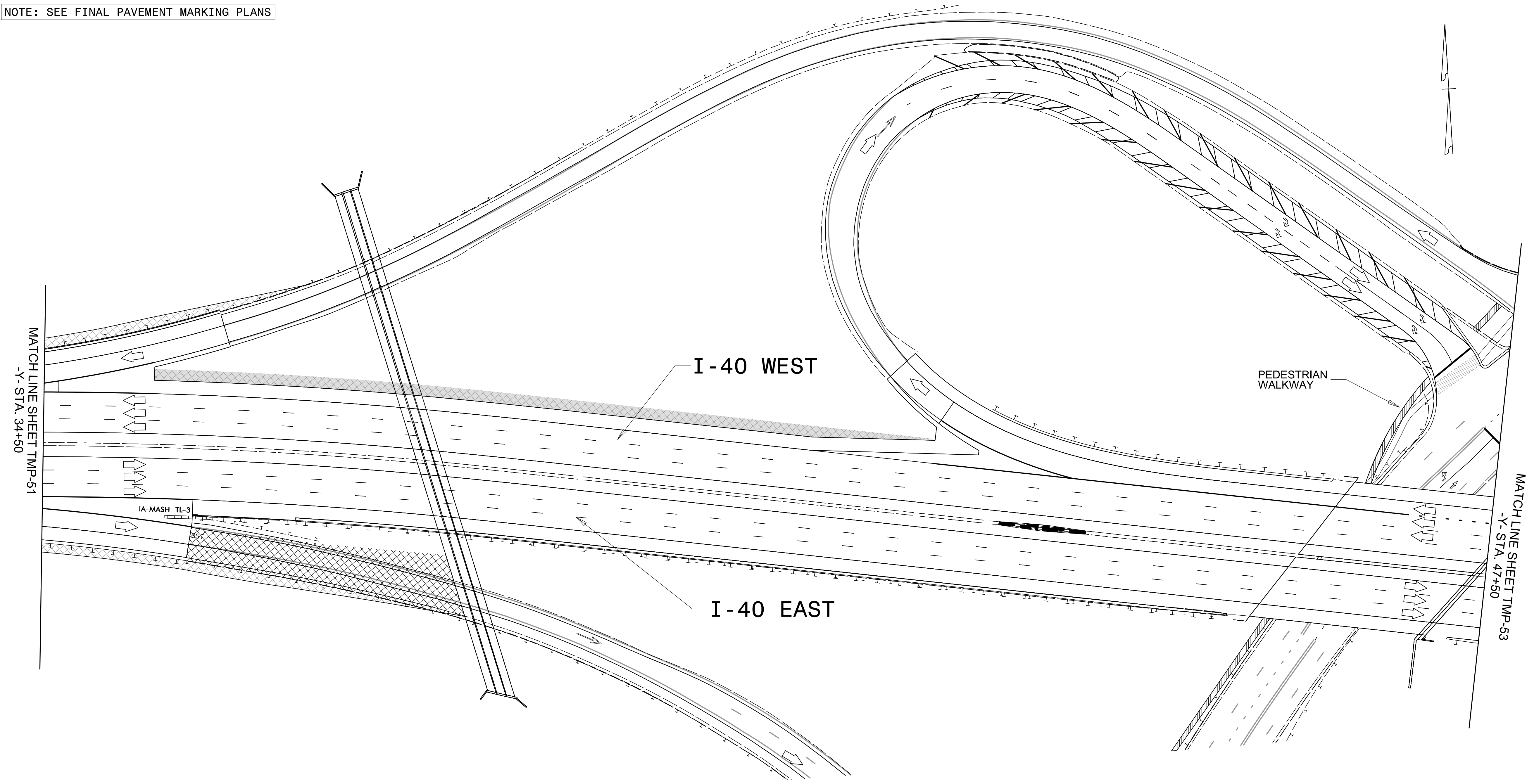

MATCH LINE SHEET TMP-51
-Y- STA. 34+50

MATCH LINE SHEET TMP-53
-Y- STA. 47+50

LEGEND

	NEW TEMPORARY MARKINGS
	EXISTING MARKINGS (GRAY)
	NEW CONSTRUCTION AREAS
	TEMPORARY PAVEMENT
	ON- GOING CONSTRUCTION
	REMOVAL
	OVERLAY/ WEDGING

NOTE: MICRO GROOVE ALL CONCRETE PAVEMENT.

04-JAN-2024 09:00
R:\PROJECTS\I-25\I-253A_Work Zone Traffic Control\Traffic\TrafficControl\CP\ProjectWise\Phase 6\I-253AA_PHASE_6_TMP-52.dgn
ZGON\jstuart



ICE of Carolinas, PLLC
 4505 Falls of Neuse Road, Suite 110
 Raleigh, North Carolina 27609
 Phone: 803-822-0333
 License #: P-0999

APPROVED:
 DATE: 1/4/2024

SEAL

**DOCUMENT NOT CONSIDERED FINAL
UNLESS ALL SIGNATURES COMPLETED**

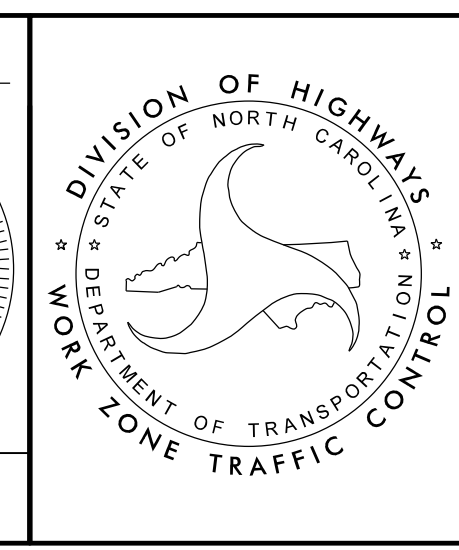

**TEMPORARY TRAFFIC CONTROL
PHASE VI DETAIL
AREA 1**

NOTE: SEE FINAL PAVEMENT MARKING PLANS

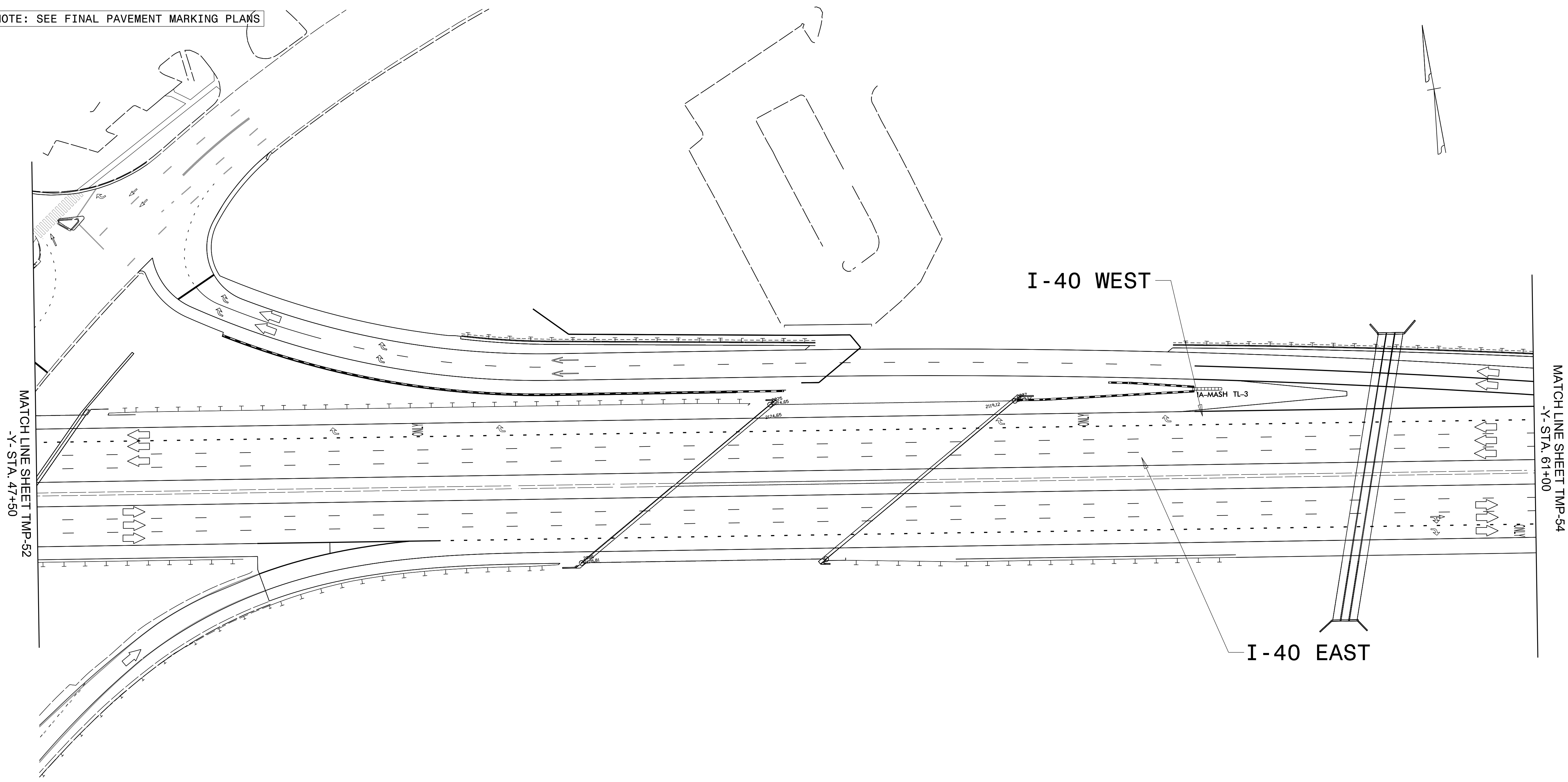

MATCH LINE SHEET TMP-52
-Y- STA. 47+50

MATCH LINE SHEET TMP-54
-Y- STA. 61+00

I-40 WEST

I-40 EAST

IA-MASH TL-3

LEGEND

- NEW TEMPORARY MARKINGS
- EXISTING MARKINGS (GRAY)
- NEW CONSTRUCTION AREAS
- TEMPORARY PAVEMENT
- ON-GOING CONSTRUCTION
- REMOVAL
- OVERLAY/WEDGING

NOTE: MICRO GROOVE ALL CONCRETE PAVEMENT.

04-JAN-2024 09:02
R:\Projects\I-2513A_WorkZone_TrafficControl\TrafficControl\CP\ProjectWise\Phase 6\I-2513AA_PHASE_6_TMP-53.dgn
ZG00101112K AT C1F5103



ICE of Carolinas, PLLC
4505 Falls of Neuse Road, Suite 110
Raleigh, North Carolina 27609
Phone: 803-822-0333
License #: P-0999

APPROVED:
DATE: 1/4/2024

SEAL

**DOCUMENT NOT CONSIDERED FINAL
UNLESS ALL SIGNATURES COMPLETED**

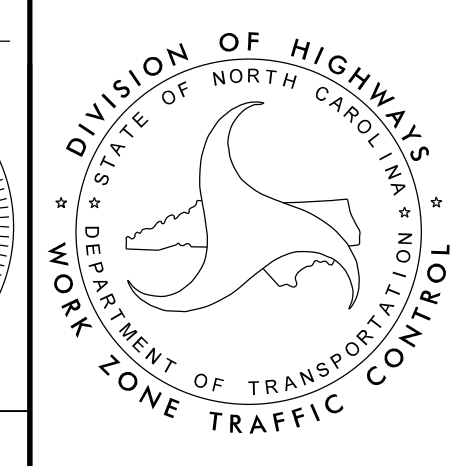
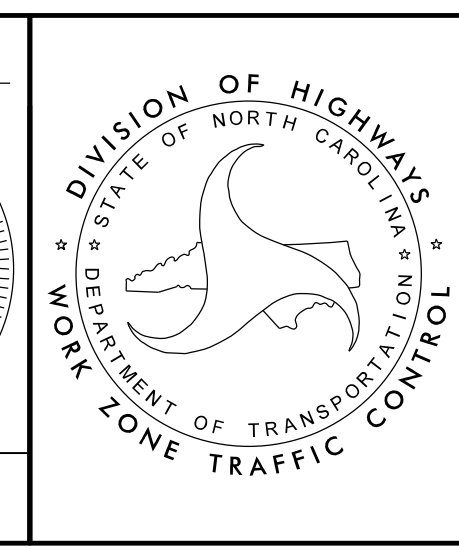

**TEMPORARY TRAFFIC CONTROL
PHASE VI DETAIL
AREA 1**

NOTE: SEE FINAL PAVEMENT MARKING PLANS

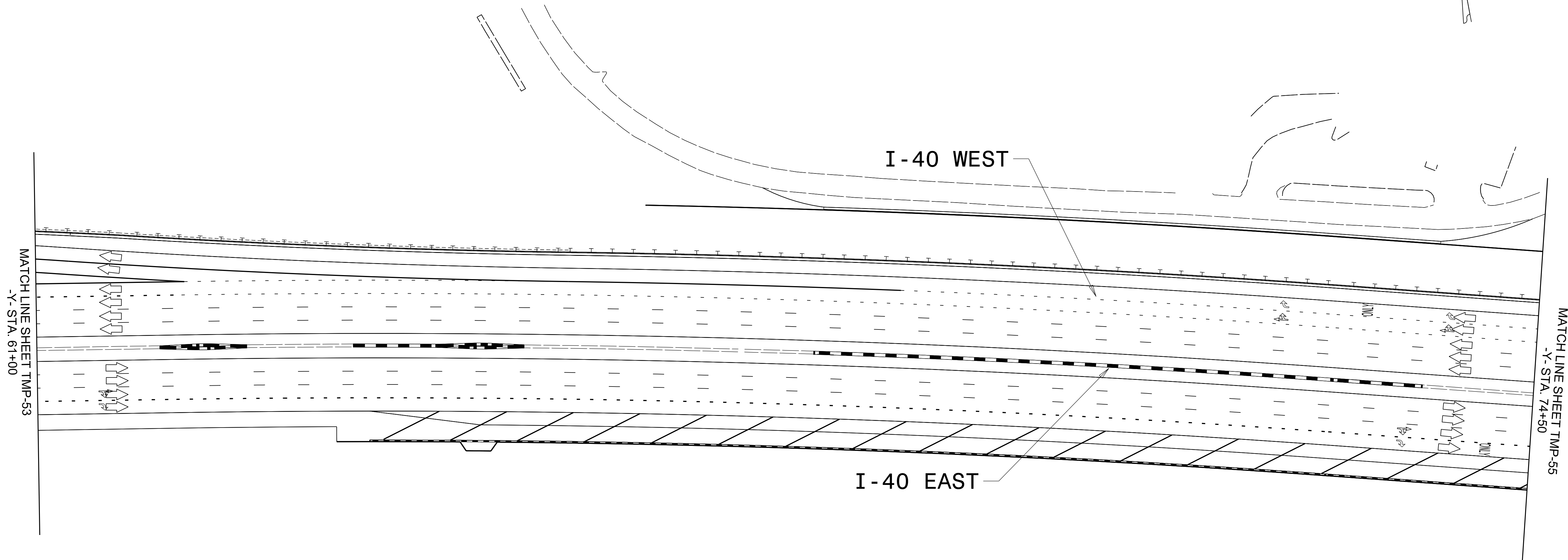
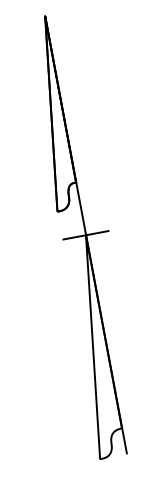

MATCH LINE SHEET TMP-53
-Y- STA. 61+00

MATCH LINE SHEET TMP-55
-Y- STA. 74+50

I-40 WEST

I-40 EAST

LEGEND	
	NEW TEMPORARY MARKINGS
	EXISTING MARKINGS (GRAY)
	NEW CONSTRUCTION AREAS
	TEMPORARY PAVEMENT
	ON- GOING CONSTRUCTION
	REMOVAL
	OVERLAY/ WEDGING

NOTE: MICRO GROOVE ALL CONCRETE PAVEMENT.

04-JAN-2024 09:02
R:\PROJECTS\I-2513A_Work Zone Traffic Control\Traffic\TrafficControl\TCP\ProjectWise\Phase 6\I-2513AA-Phase_6_TMP-54.dgn
ZG00010112K AT C1F5103



ICE of Carolinas, PLLC
4505 Falls of Neuse Road, Suite 110
Raleigh, North Carolina 27609
Phone: 803-822-0333
License #: P-0999

APPROVED:
DATE: 1/4/2024

SEAL

**DOCUMENT NOT CONSIDERED FINAL
UNLESS ALL SIGNATURES COMPLETED**

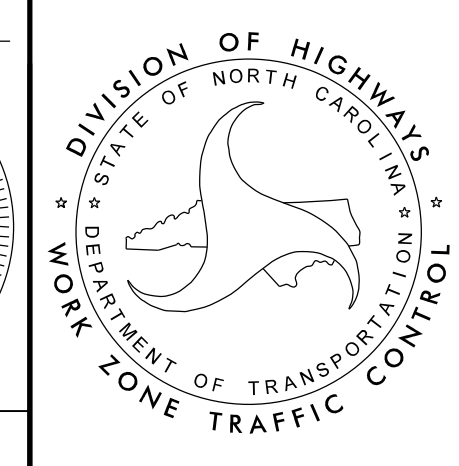
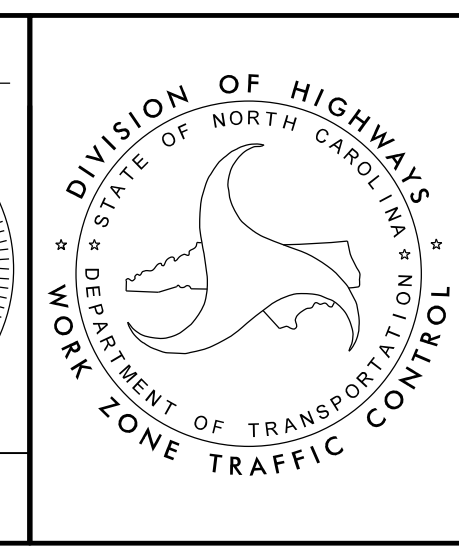

**TEMPORARY TRAFFIC CONTROL
PHASE VI DETAIL
AREA 1**

NOTE: SEE FINAL PAVEMENT MARKING PLANS

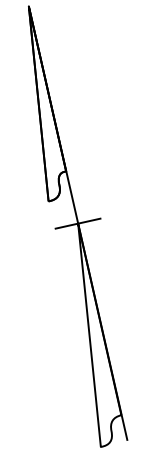

MATCH LINE SHEET TMP-54
-Y- STA. 74+50





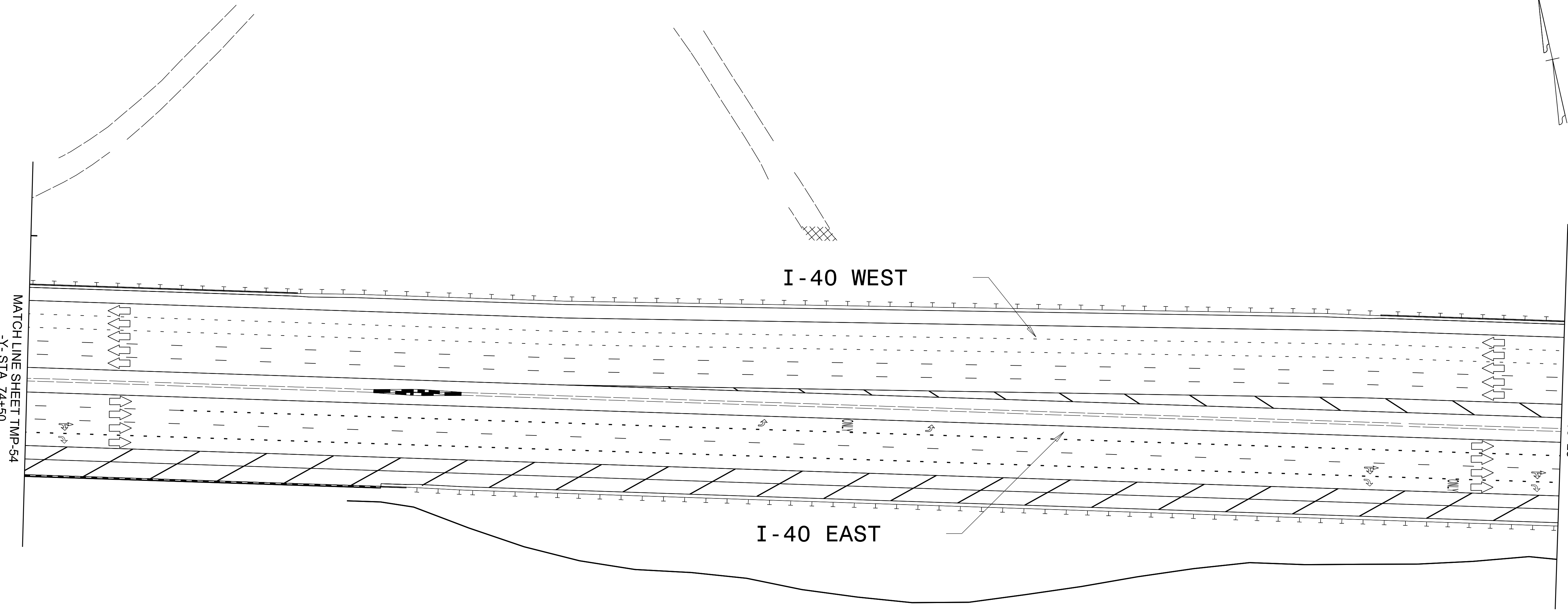

MATCH LINE SHEET TMP-56
-Y- STA. 88+25

I-40 WEST

I-40 EAST



LEGEND

-  NEW TEMPORARY MARKINGS
-  EXISTING MARKINGS (GRAY)
-  NEW CONSTRUCTION AREAS
-  TEMPORARY PAVEMENT
-  ON- GOING CONSTRUCTION
-  REMOVAL
-  OVERLAY/ WEDGING

NOTE: MICRO GROOVE ALL CONCRETE PAVEMENT.

04-JAN-2024 09:04
R:\PROJECTS\I-2513A_Work_Zone_Traffic_Control\TrafficControl\CP\ProjectWise\Phase 6\I-2513AA-Phase_6_TMP-55.dgn
ZG08101172K AT C1F5103

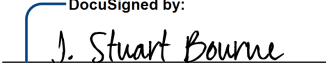

ICE of Carolinas, PLLC
4505 Falls of Neuse Road, Suite 110
Raleigh, North Carolina 27609
Phone: 803-822-0333
License #: P-0999

APPROVED: 
DATE: 1/4/2024

SEAL

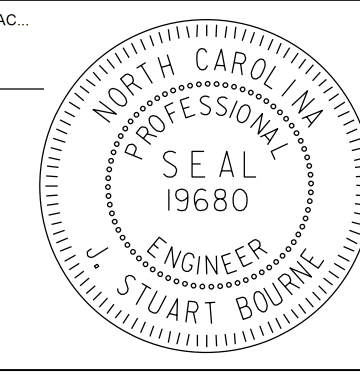

**DOCUMENT NOT CONSIDERED FINAL
UNLESS ALL SIGNATURES COMPLETED**

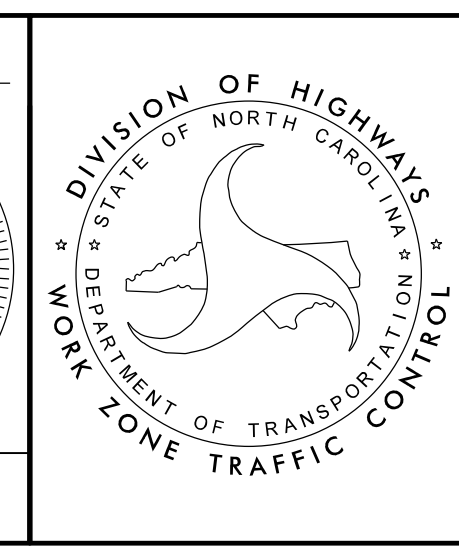

**TEMPORARY TRAFFIC CONTROL
PHASE VI DETAIL
AREA 1**

NOTE: SEE FINAL PAVEMENT MARKING PLANS

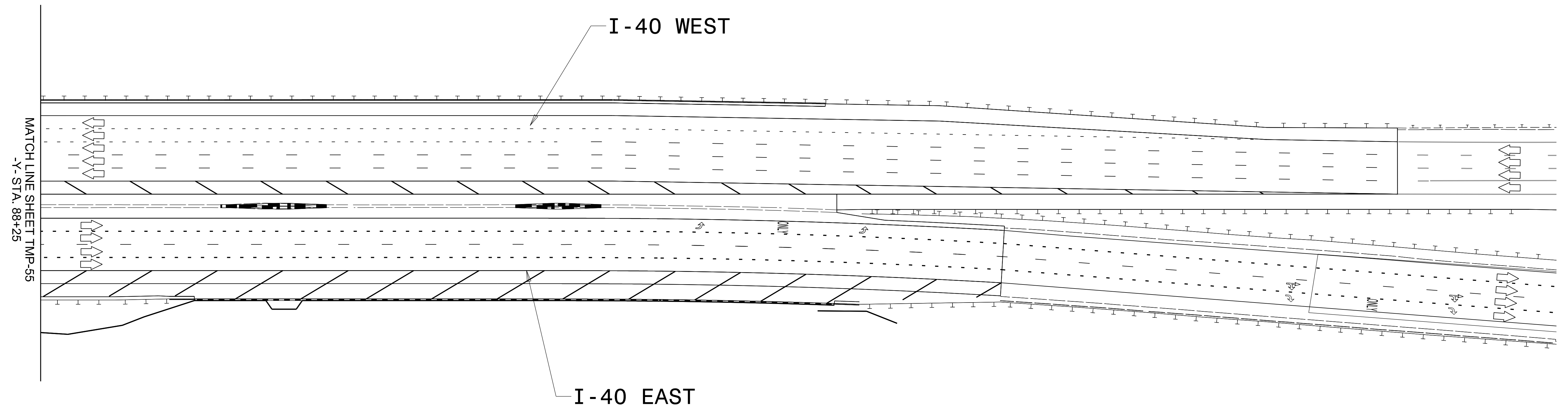
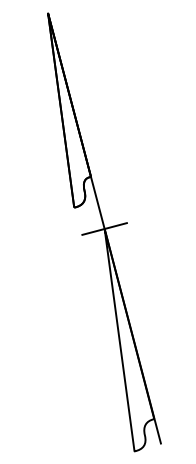

LEGEND

- NEW TEMPORARY MARKINGS
- EXISTING MARKINGS (GRAY)
- NEW CONSTRUCTION AREAS
- TEMPORARY PAVEMENT
- ON- GOING CONSTRUCTION
- REMOVAL
- OVERLAY/ WEDGING

NOTE: MICRO GROOVE ALL CONCRETE PAVEMENT.

04-JAN-2024 01:57
R:\Projects\I-25\08-01-253A_Work Zone Traffic Control\Traffic Control\CP\ProjectWise\Phase 6\I-253AA-Phase_6_TMP-56.dgn
ZG00010112K AT C1F5103



ICE of Carolinas, PLLC
 4505 Falls of Neuse Road, Suite 110
 Raleigh, North Carolina 27609
 Phone: 803-822-0333
 License #: P-0999

APPROVED:
DocuSigned by: J. Stuart Bourne EBE4083CA284AC

DATE: 1/4/2024

SEAL

**DOCUMENT NOT CONSIDERED FINAL
UNLESS ALL SIGNATURES COMPLETED**

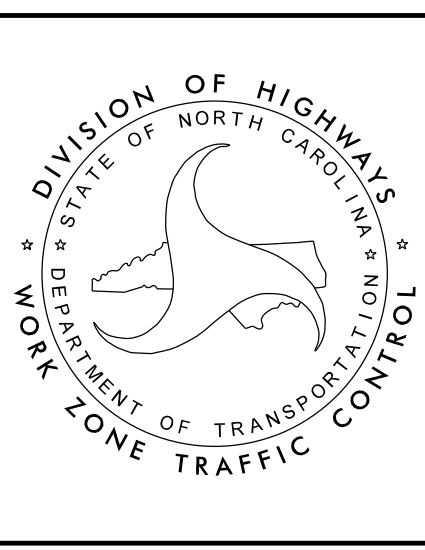

**TEMPORARY TRAFFIC CONTROL
PHASE VI DETAIL
AREA 1**

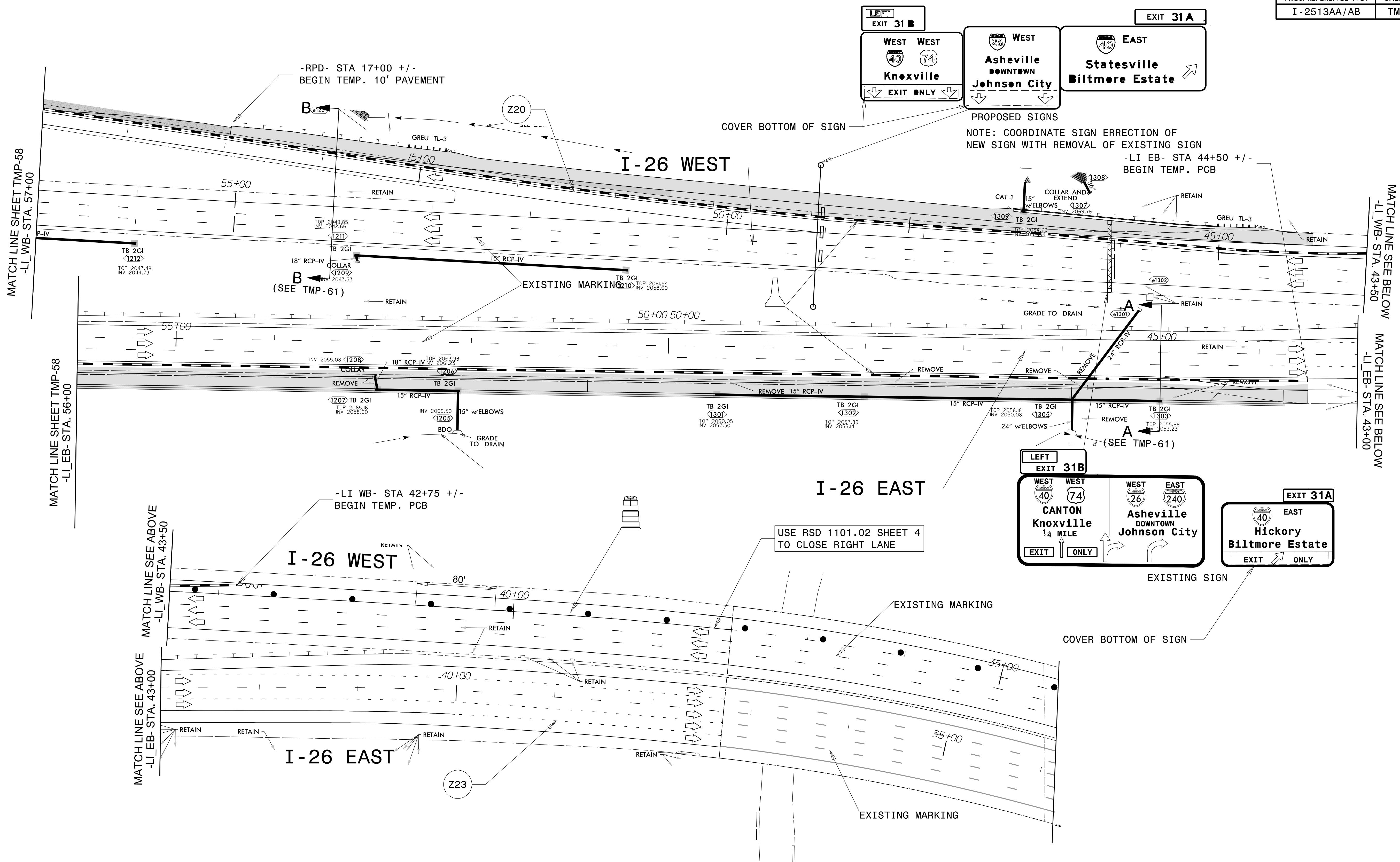

MATCH LINE SHEET TMP-58
-LI_WB- STA. 57+00

MATCH LINE SHEET TMP-58
-LI_EB- STA. 56+00

MATCH LINE SEE BELOW
-LI_WB- STA. 43+50

MATCH LINE SEE BELOW
-LI_EB- STA. 43+00

MATCH LINE SEE ABOVE
-LI_WB- STA. 43+50

MATCH LINE SEE ABOVE
-LI_EB- STA. 43+00

LEGEND

	NEW TEMPORARY MARKINGS
	EXISTING MARKINGS (GRAY)
	NEW CONSTRUCTION AREAS
	TEMPORARY PAVEMENT
	ON- GOING CONSTRUCTION
	REMOVAL
	OVERLAY/ WEDGING/OVERLAY

NOTE: THE CONTRACTOR SHALL RELOCATE INFORMATION SIGNS BEFORE CONSTRUCTION REMOVES THEM.
NOTE: ALL LANE WIDTHS ARE 11' UNLESS OTHERWISE SHOWN.

04-JAN-2024 10:48
R:\Projects\24-08-01-2513A_Work Zone Traffic Control\Traffic\TrafficControl\CP\ProjectWise\Area 2\Phase 1\I-2513AA_PHASE1.LTMP-57.dgn
Z:\gondim\12K_AT_C1F5103

ICE of CAROLINAS, PLLC
ICE of Carolinas, PLLC
4505 Falls of Neuse Road, Suite 110
Raleigh, North Carolina 27609
Phone: 803-822-0333
License #: P-0999

APPROVED: *J. Stuart Bourne*
DATE: 1/4/2024
SEAL
DOCUMENT NOT CONSIDERED FINAL
UNLESS ALL SIGNATURES COMPLETED

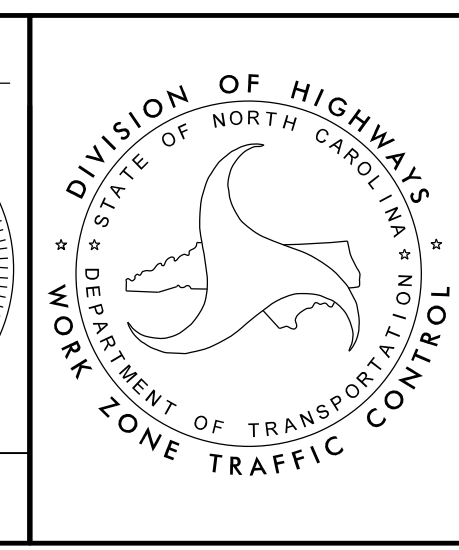

TEMPORARY TRAFFIC CONTROL PHASE I DETAIL AREA 2

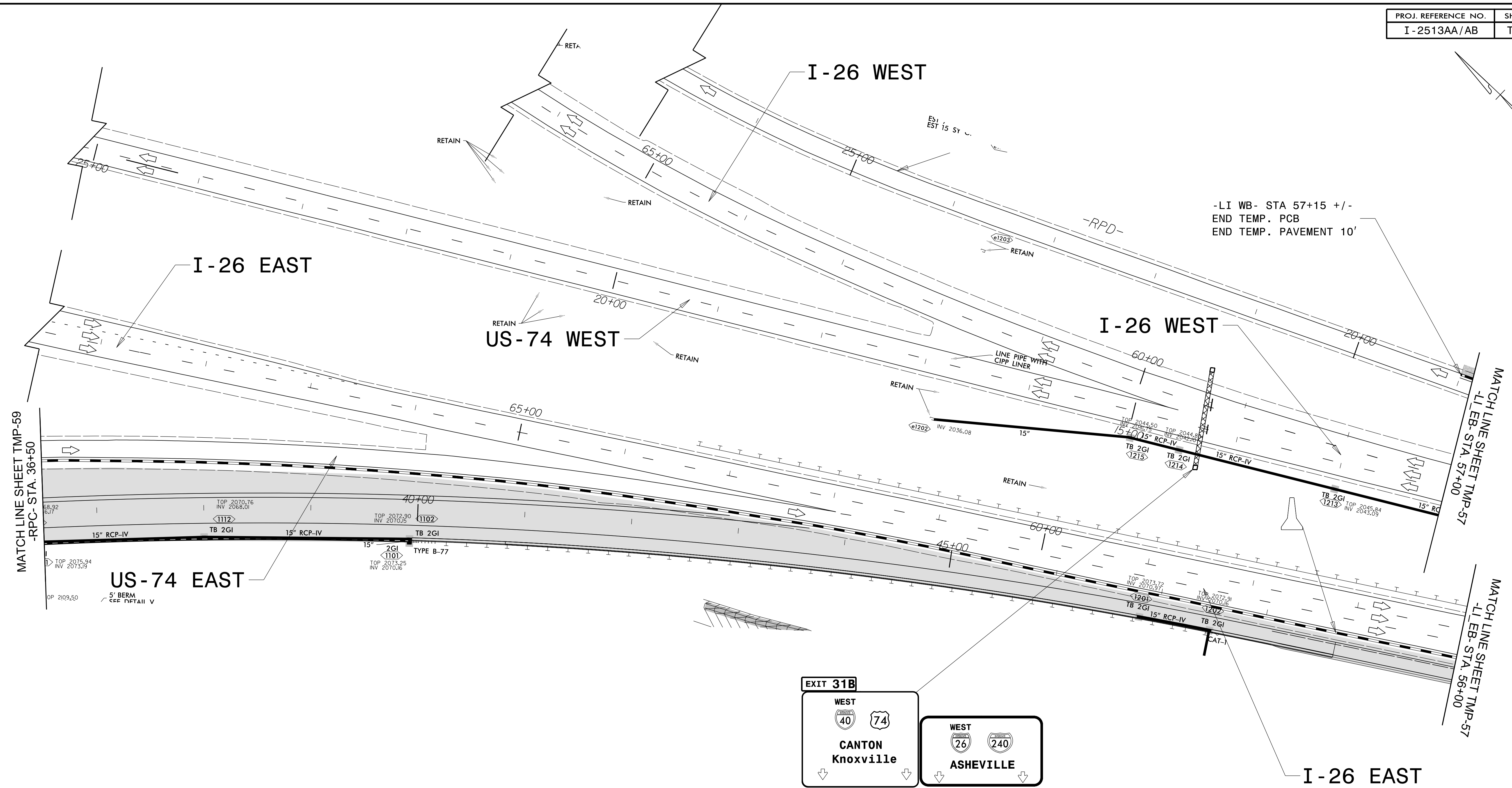

MATCH LINE SHEET TMP-59
-RPC- STA. 36+50

MATCH LINE SHEET TMP-57
-LI EB- STA. 57+00

MATCH LINE SHEET TMP-57
-LI EB- STA. 56+00

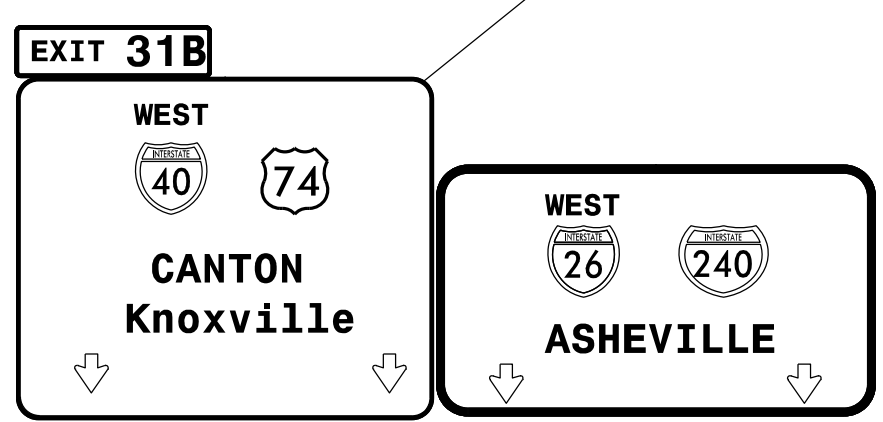

LEGEND

	NEW TEMPORARY MARKINGS
	EXISTING MARKINGS (GRAY)
	NEW CONSTRUCTION AREAS
	TEMPORARY PAVEMENT
	ON- GOING CONSTRUCTION
	REMOVAL
	OVERLAY/ WEDGING/OVERLAY

NOTE: THE CONTRACTOR SHALL RELOCATE INFORMATION SIGNS BEFORE CONSTRUCTION REMOVES THEM.
NOTE: ALL LANE WIDTHS ARE 11' UNLESS OTHERWISE SHOWN.

ICE of Carolinas, PLLC
4505 Falls of Neuse Road, Suite 110
Raleigh, North Carolina 27609
Phone: 803-822-0333
License #: P-0999

APPROVED: *J. Stuart Course*
DATE: 1/4/2024

SEAL

DOCUMENT NOT CONSIDERED FINAL UNLESS ALL SIGNATURES COMPLETED

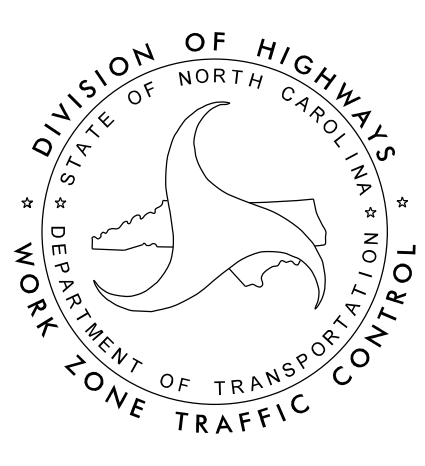

TEMPORARY TRAFFIC CONTROL PHASE I DETAIL AREA 2

04-JAN-2024 10:57
R:\Projects\2024\08-01-2513A-Work Zone Traffic Control\Traffic\TrafficControl\CP\ProjectWise\Area 2\Phase I\I-2513AA-Phase I\TMP-58.dgn
Z:\08012513A

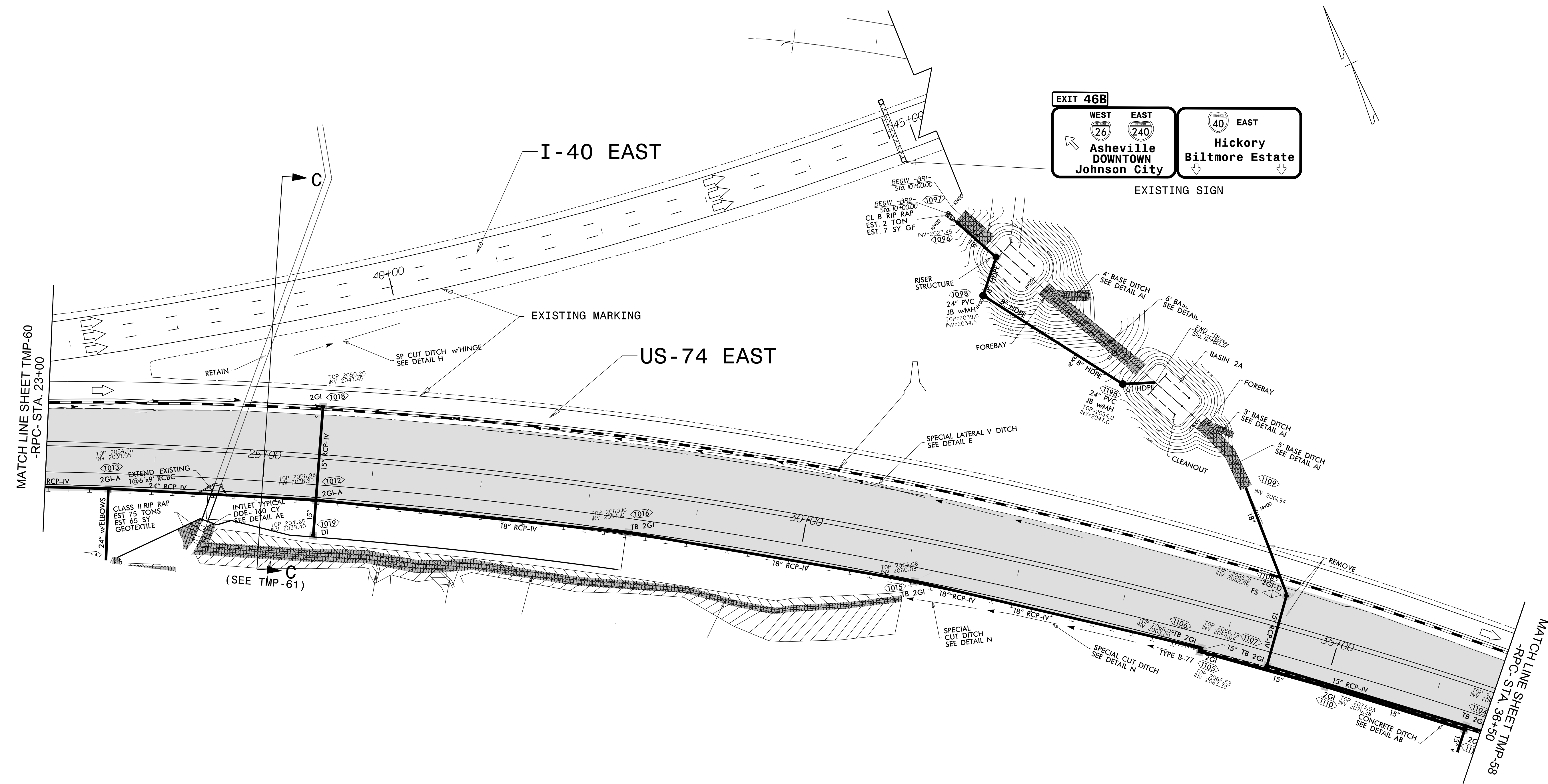

MATCH LINE SHEET TMP-60
-RPC- STA. 23+00

MATCH LINE SHEET TMP-58
-RPC- STA. 36+50

LEGEND	
	NEW TEMPORARY MARKINGS
	EXISTING MARKINGS (GRAY)
	NEW CONSTRUCTION AREAS
	TEMPORARY PAVEMENT
	ON- GOING CONSTRUCTION
	REMOVAL
	OVERLAY/WEDGING/OVERLAY

NOTE: THE CONTRACTOR SHALL RELOCATE INFORMATION SIGNS BEFORE CONSTRUCTION REMOVES THEM.
NOTE: ALL LANE WIDTHS ARE 11' UNLESS OTHERWISE SHOWN.

ICE of CAROLINAS, PLLC
ICE of Carolinas, PLLC
4505 Falls of Neuse Road, Suite 110
Raleigh, North Carolina 27609
Phone: 803-822-0333
License #: P-0999

APPROVED:
DATE: 1/4/2024
SEAL
NORTH CAROLINA PROFESSIONAL ENGINEER SEAL 19680
J. STUART BOURNE
DOCUMENT NOT CONSIDERED FINAL UNLESS ALL SIGNATURES COMPLETED

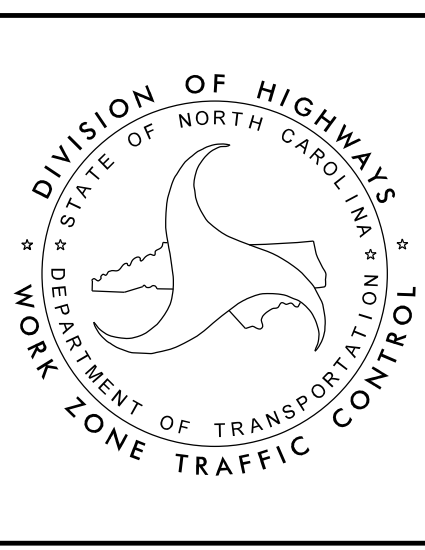

TEMPORARY TRAFFIC CONTROL PHASE I DETAIL AREA 2

04-JAN-2024 11:15
R:\Projects\I-25\08-01-2513A-Work Zone Traffic Control\TrafficControl\CP\ProjectWise\Area 2\Phase I\I-2513AA-Phase I\TMP-59.dgn
Z:\G001\112K AT C1F5103

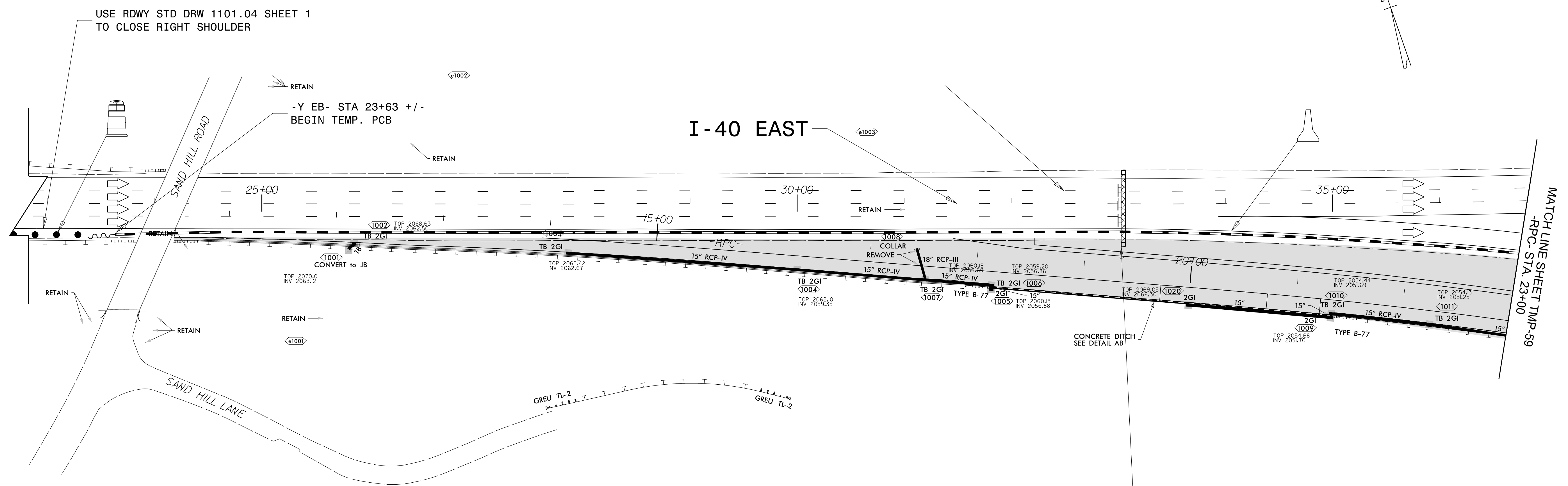

USE RDWY STD DRW 1101.04 SHEET 1
TO CLOSE RIGHT SHOULDER

-Y EB- STA 23+63 +/-
BEGIN TEMP. PCB

I - 40 EAST

MATCH LINE SHEET TMP-59
-RPC- STA. 23+00

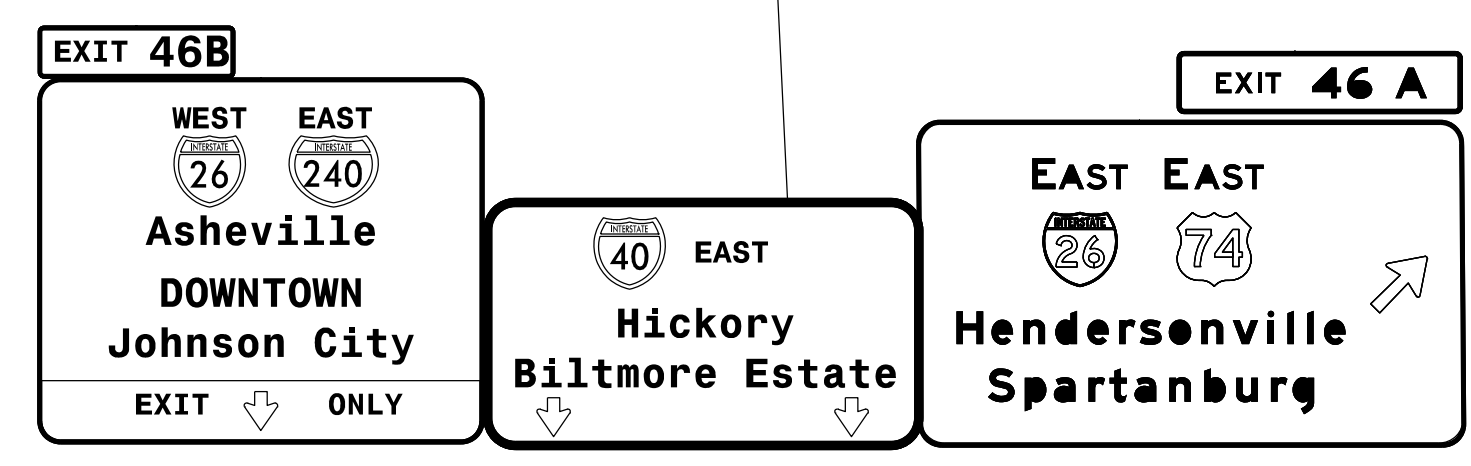

EXISTING SIGN
NOTE: MAINTAIN EXISTING SIGN UNTIL RAMP -RPC- IS OPEN TO TRAFFIC

LEGEND	
	NEW TEMPORARY MARKINGS
	EXISTING MARKINGS (GRAY)
	NEW CONSTRUCTION AREAS
	TEMPORARY PAVEMENT
	ON- GOING CONSTRUCTION
	REMOVAL
	OVERLAY/ WEDGING/OVERLAY

NOTE: THE CONTRACTOR SHALL RELOCATE INFORMATION SIGNS BEFORE CONSTRUCTION REMOVES THEM.
NOTE: ALL LANE WIDTHS ARE 11' UNLESS OTHERWISE SHOWN.

04-JAN-2024 11:17 AM PROJECTS\1-08-01-2513A-Work Zone Traffic Control\Traffic\TrafficControl\CP\ProjectWise\Area 2\Phase I-2513AA-Phase-I-TMP-60.dgn

ICE of Carolinas, PLLC
4505 Falls of Neuse Road, Suite 110
Raleigh, North Carolina 27609
Phone: 803-822-0333
License #: P-0999

APPROVED: *J. Stuart Bourne*
DATE: 1/4/2024

SEAL

DOCUMENT NOT CONSIDERED FINAL
UNLESS ALL SIGNATURES COMPLETED

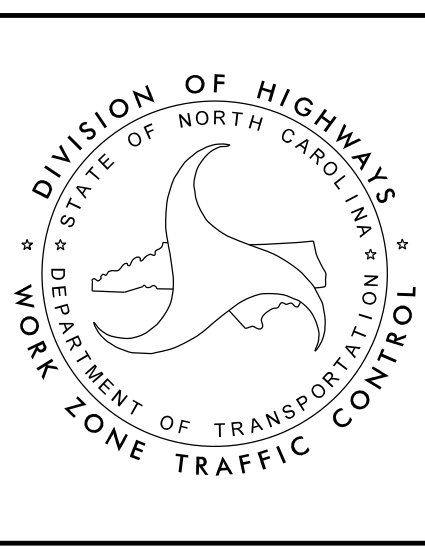

TEMPORARY TRAFFIC CONTROL PHASE I DETAIL AREA 2

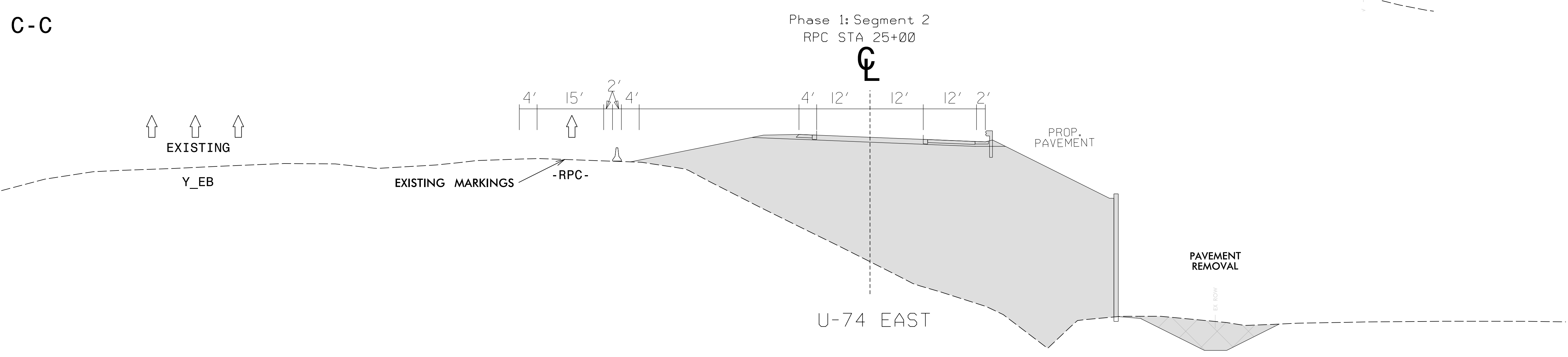
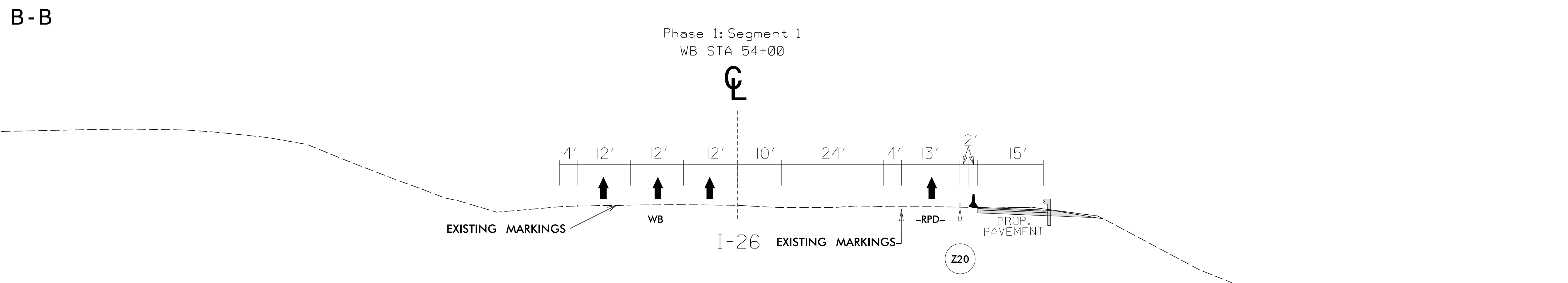
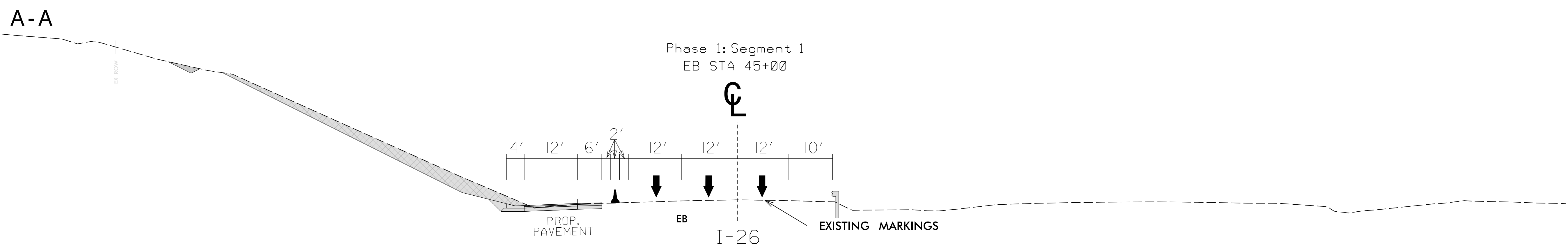

LEGEND

	NEW TEMPORARY MARKINGS
	EXISTING MARKINGS (GRAY)
	NEW CONSTRUCTION AREAS
	TEMPORARY PAVEMENT
	ON-GOING CONSTRUCTION
	REMOVAL
	OVERLAY/WEDGING/OVERLAY

NOTE: THE CONTRACTOR SHALL RELOCATE INFORMATION SIGNS BEFORE CONSTRUCTION REMOVES THEM.

NOTE: ALL LANE WIDTHS ARE 11' UNLESS OTHERWISE SHOWN.

ICE of Carolinas, PLLC

ICE of Carolinas, PLLC
4505 Falls of Neuse Road, Suite 110
Raleigh, North Carolina 27609
Phone: 803-822-0333
License #: P-0999

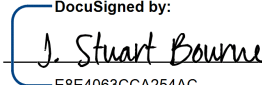
APPROVED: 

DATE: 1/4/2024

SEAL

DOCUMENT NOT CONSIDERED FINAL UNLESS ALL SIGNATURES COMPLETED

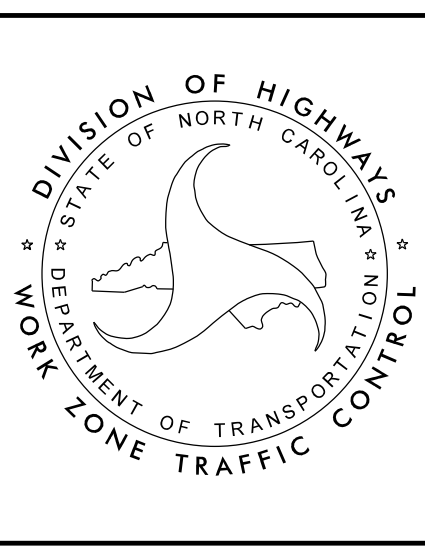

TEMPORARY TRAFFIC CONTROL PHASE I DETAIL AREA 2

04-JAN-2024 11:18
R:\PROJECTS\I-25\08-01-2513A_Work Zone Traffic Control\Traffic\TrafficControl\CP\ProjectWise\Area 2\Phase I-2513AA_PHASE1-TMP-61.dgn
ZG00141412X AT C1F5103

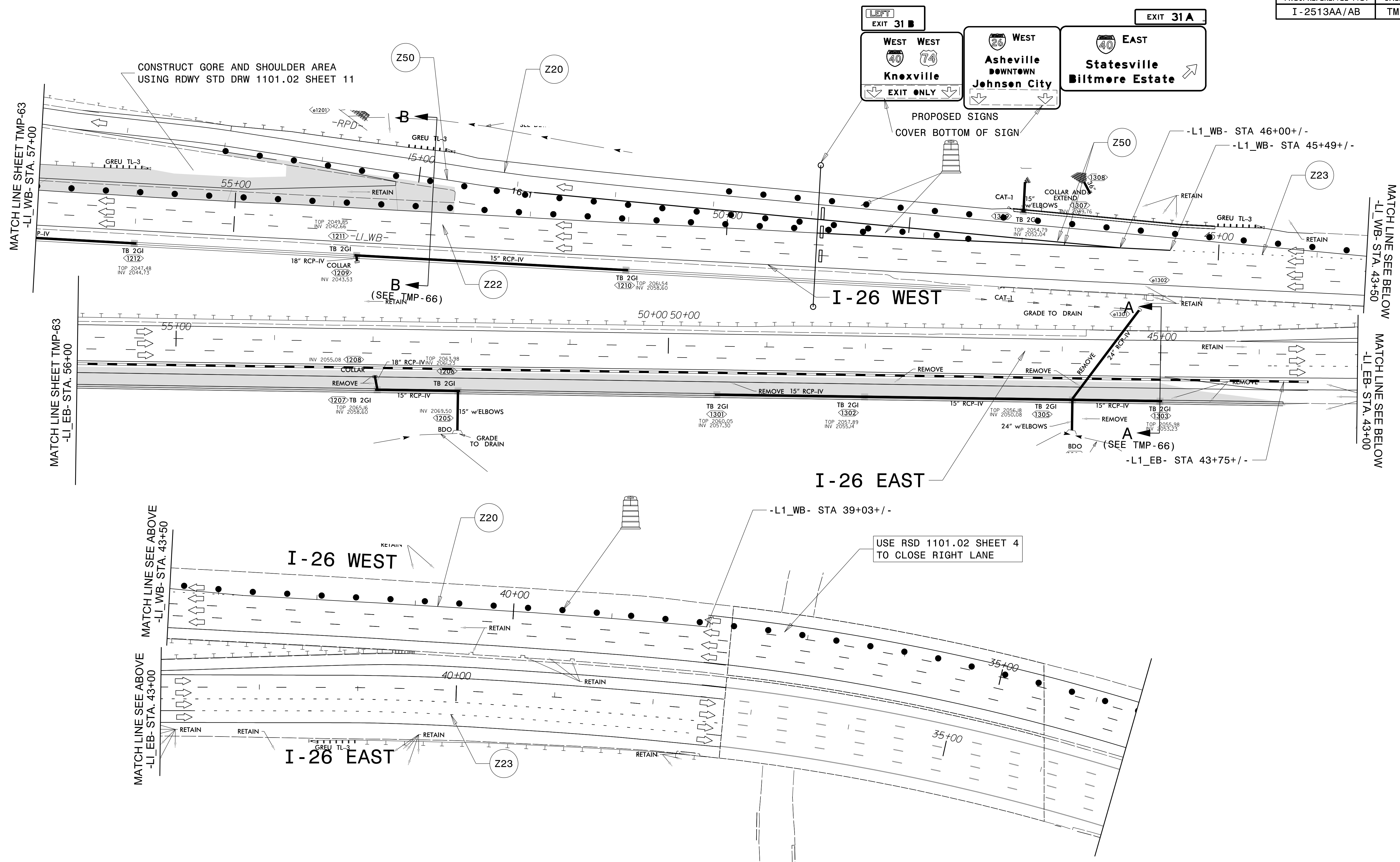

LEGEND	
	NEW TEMPORARY MARKINGS
	EXISTING MARKINGS (GRAY)
	NEW CONSTRUCTION AREAS
	TEMPORARY PAVEMENT
	ON-GOING CONSTRUCTION
	REMOVAL
	OVERLAY/WEDGING

NOTE: CONTRACTOR SHALL RELOCATE INFORMATION SIGNS BEFORE CONSTRUCTION REMOVES THEM.
 NOTE: ALL LANE WIDTHS ARE 11' UNLESS OTHERWISE SHOWN.

ICE of CAROLINAS, PLLC
 ICE of Carolinas, PLLC
 4505 Falls of Neuse Road, Suite 110
 Raleigh, North Carolina 27609
 Phone: 803-822-0333
 License #: P-0999

APPROVED: *J. Stuart Bourne*
 DATE: 1/4/2024
 SEAL
 NORTH CAROLINA PROFESSIONAL SEAL 19680
 J. STUART BOURNE
 ENGINEER

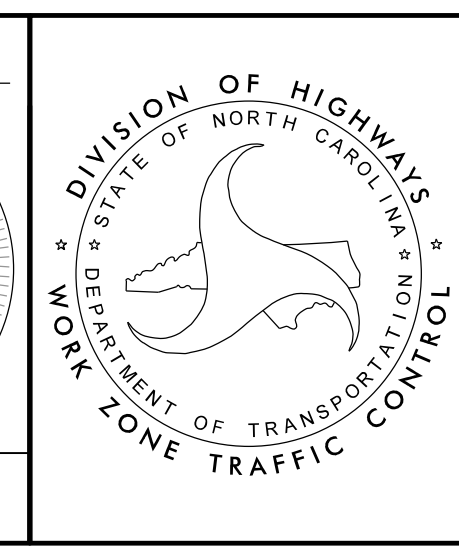

TEMPORARY TRAFFIC CONTROL PHASE II DETAIL AREA 2

04-JAN-2024 11:45 R:\Projects\21-08-01-2513A_Work Zone Traffic Control\Traffic\TrafficControl\CP\ProjectWise\Area 2\Phase 2\I-2513AA_Phase_2_TMP-62.dgn Z:\gord\11212\11212.dwg

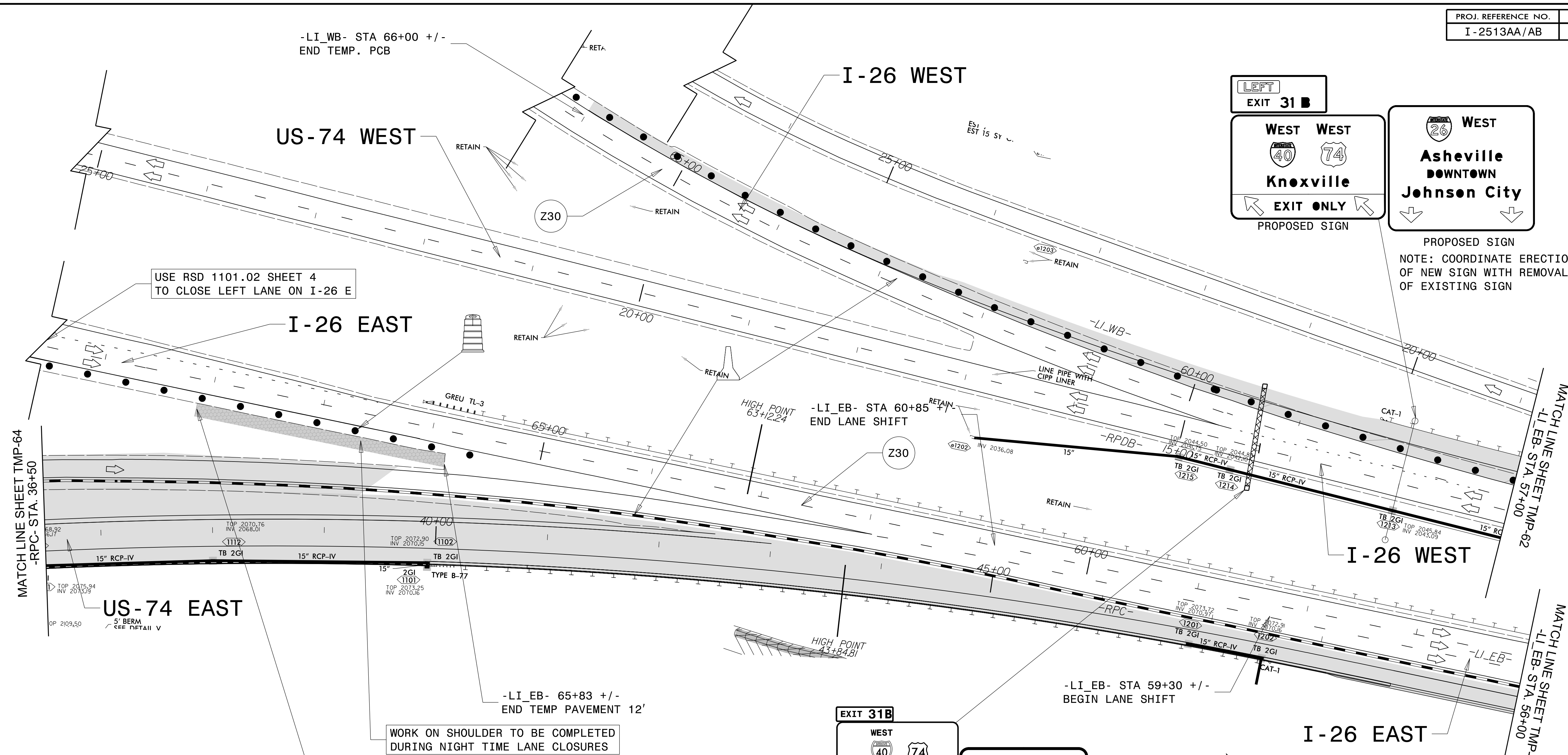

USE RSD 1101.02 SHEET 4 TO CLOSE LEFT LANE ON I-26 E

WORK ON SHOULDER TO BE COMPLETED DURING NIGHT TIME LANE CLOSURES

LEGEND	
	NEW TEMPORARY MARKINGS
	EXISTING MARKINGS (GRAY)
	NEW CONSTRUCTION AREAS
	TEMPORARY PAVEMENT
	ON-GOING CONSTRUCTION
	REMOVAL
	OVERLAY/WEDGING

NOTE: CONTRACTOR SHALL RELOCATE INFORMATION SIGNS BEFORE CONSTRUCTION REMOVES THEM.
 NOTE: ALL LANE WIDTHS ARE 11' UNLESS OTHERWISE SHOWN.

ICE of CAROLINAS, PLLC
 ICE of Carolinas, PLLC
 4505 Falls of Neuse Road, Suite 110
 Raleigh, North Carolina 27609
 Phone: 803-822-0333
 License #: P-0999

APPROVED: *J. Stuart Bourne*
 DATE: 1/4/2024
 SEAL
 DOCUMENT NOT CONSIDERED FINAL UNLESS ALL SIGNATURES COMPLETED

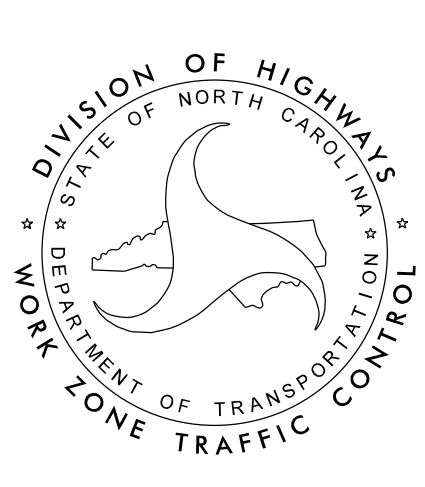

TEMPORARY TRAFFIC CONTROL PHASE II DETAIL AREA 2

04-JAN-2024 11:49 AM R:\Projects\21-08-01-2513AA-Work Zone Traffic Control\Traffic\TrafficControl\CP\ProjectWise\Area 2\Phase 2\I-2513AA_PHASE.2_TMP-63.dgn

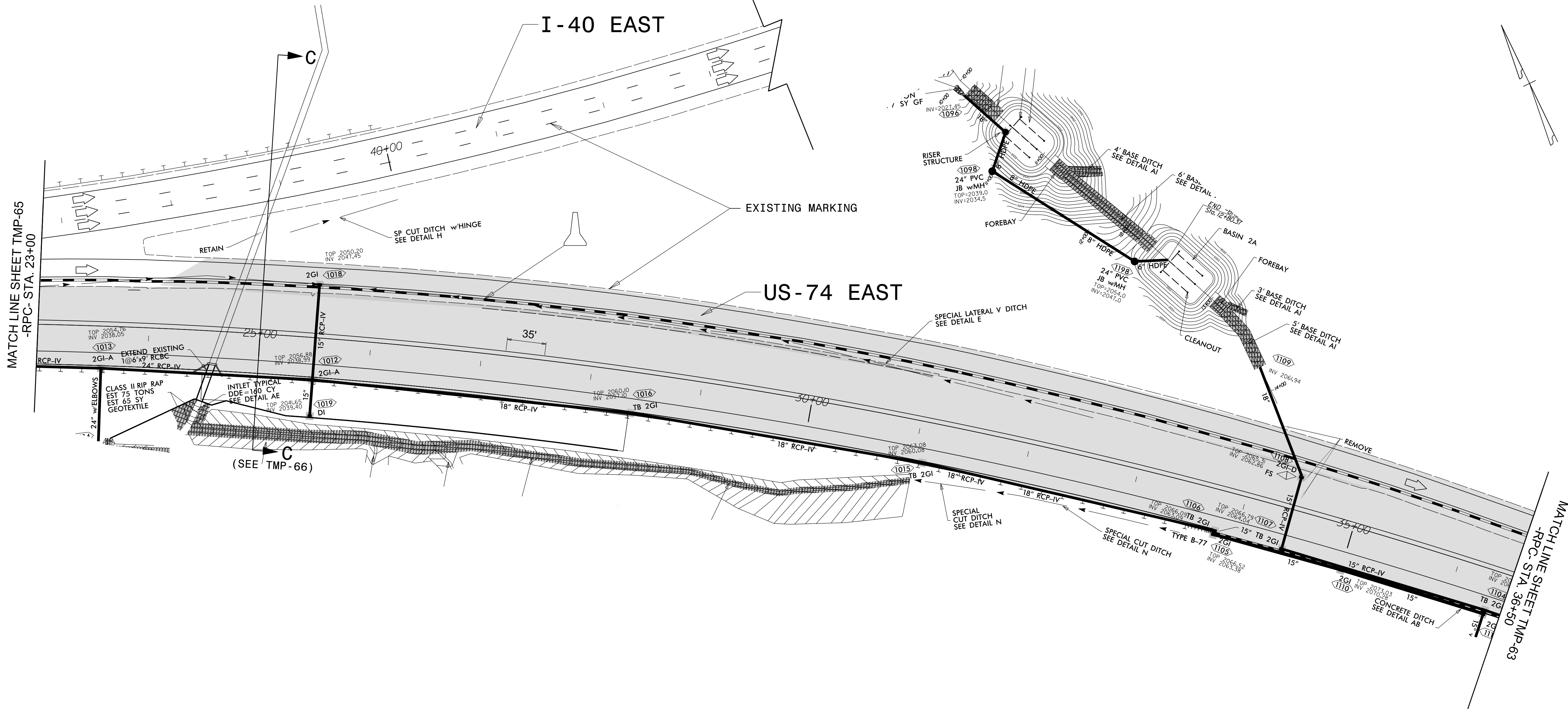

MATCH LINE SHEET TMP-65
-RPC- STA. 23+00

MATCH LINE SHEET TMP-63
-RPC- STA. 36+50

LEGEND	
	NEW TEMPORARY MARKINGS
	EXISTING MARKINGS (GRAY)
	NEW CONSTRUCTION AREAS
	TEMPORARY PAVEMENT
	ON- GOING CONSTRUCTION
	REMOVAL
	OVERLAY/WEDGING

NOTE: CONTRACTOR SHALL RELOCATE INFORMATION SIGNS BEFORE CONSTRUCTION REMOVES THEM.
NOTE: ALL LANE WIDTHS ARE 11' UNLESS OTHERWISE SHOWN.

ICE of CAROLINAS, PLLC

ICE of Carolinas, PLLC
4505 Falls of Neuse Road, Suite 110
Raleigh, North Carolina 27609
Phone: 803-822-0333
License #: P-0999

APPROVED:

DATE: 1/4/2024

SEAL

**DOCUMENT NOT CONSIDERED FINAL
UNLESS ALL SIGNATURES COMPLETED**

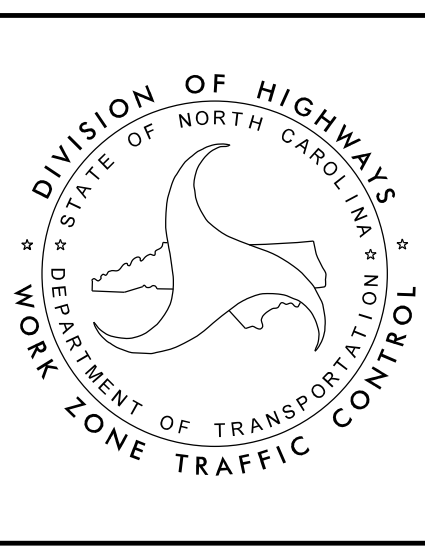

**TEMPORARY TRAFFIC CONTROL
PHASE II DETAIL
AREA 2**

04-JAN-2024 11:51
R:\Projects\21-08-01-I-2513A_Work Zone Traffic Control\Traffic Control\TrafficControl\CP\ProjectWise\Area 2\Phase 2\I-2513AA_Phase 2 TMP-64.dgn
Z:\CP\111212K_AT_C1F5103

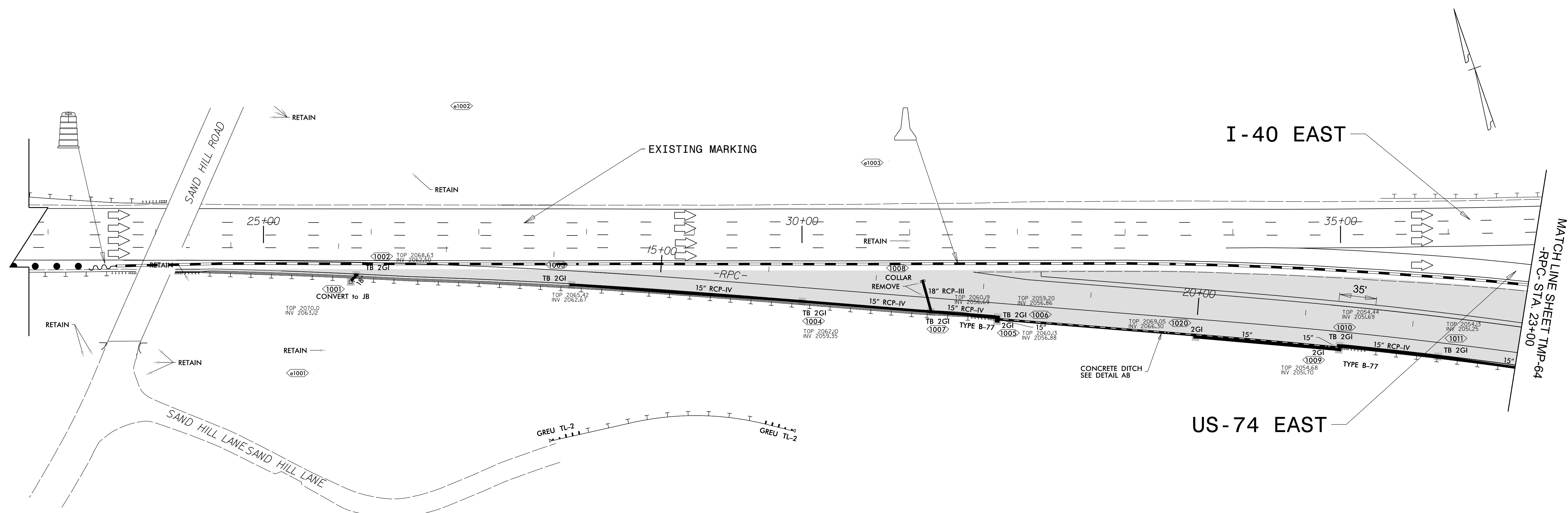

04-JAN-2024 11:52 AM C:\Projects\I-2513AA\Work Zone Traffic Control\Traffic\TrafficControl\CP\ProjectWise\Area 2\Phase 2\I-2513AA_PHASE.2.TMP-65.dgn

LEGEND	
	NEW TEMPORARY MARKINGS
	EXISTING MARKINGS (GRAY)
	NEW CONSTRUCTION AREAS
	TEMPORARY PAVEMENT
	ON-GOING CONSTRUCTION
	REMOVAL
	OVERLAY/WEDGING

NOTE: CONTRACTOR SHALL RELOCATE INFORMATION SIGNS BEFORE CONSTRUCTION REMOVES THEM.

NOTE: ALL LANE WIDTHS ARE 11' UNLESS OTHERWISE SHOWN.

ICE of Carolinas, PLLC
4505 Falls of Neuse Road, Suite 110
Raleigh, North Carolina 27609
Phone: 803-822-0333
License #: P-0999

APPROVED:

DATE: 1/4/2024

SEAL

DOCUMENT NOT CONSIDERED FINAL UNLESS ALL SIGNATURES COMPLETED

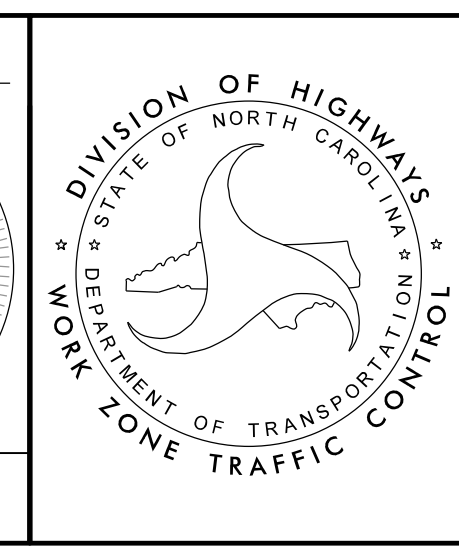

TEMPORARY TRAFFIC CONTROL PHASE II DETAIL AREA 2

MATCH LINE SHEET TMP-64
-RPC- STA. 23+00

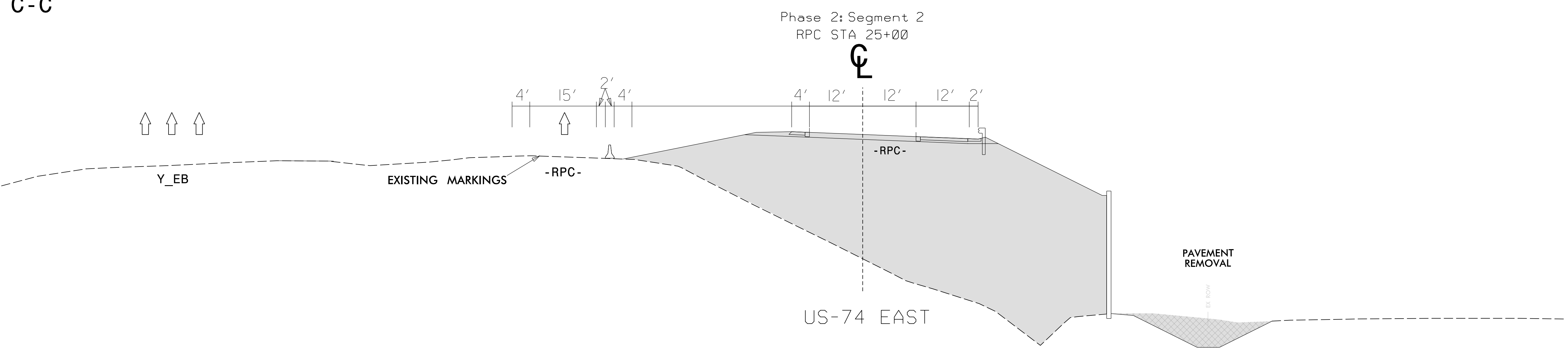
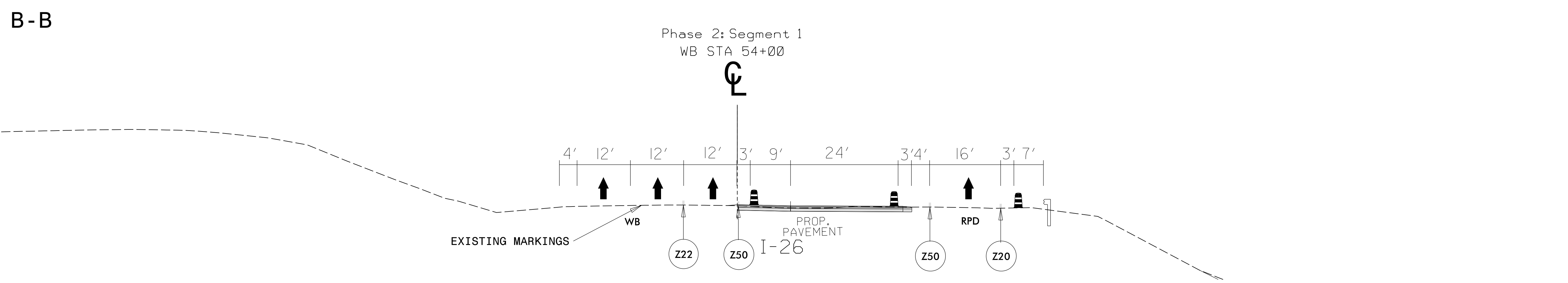
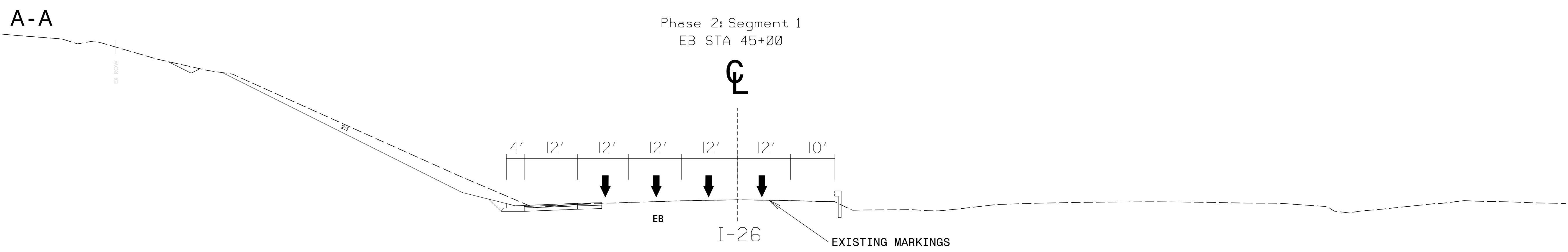

04-JAN-2024 11:54 AM
 R:\Projects\I-25\I-2513AA\Work Zone Traffic Control\Traffic\TrafficControl\CP\ProjectWise\Area 2\Phase 2\I-2513AA_PHASE.2.TMP-66.dgn
 Z:\C:\Users\jstuart\OneDrive\Documents\AT_CTF5103

LEGEND	
	NEW TEMPORARY MARKINGS
	EXISTING MARKINGS (GRAY)
	NEW CONSTRUCTION AREAS
	TEMPORARY PAVEMENT
	ON-GOING CONSTRUCTION
	REMOVAL
	OVERLAY/WEDGING

NOTE: CONTRACTOR SHALL RELOCATE INFORMATION SIGNS BEFORE CONSTRUCTION REMOVES THEM.
 NOTE: ALL LANE WIDTHS ARE 11' UNLESS OTHERWISE SHOWN.

ICE of CAROLINAS, PLLC
 ICE of Carolinas, PLLC
 4505 Falls of Neuse Road, Suite 110
 Raleigh, North Carolina 27609
 Phone: 803-822-0333
 License #: P-0999

APPROVED:
 DATE: 1/4/2024
 SEAL
 NORTH CAROLINA PROFESSIONAL SEAL 19680
 J. STUART BOURNE ENGINEER

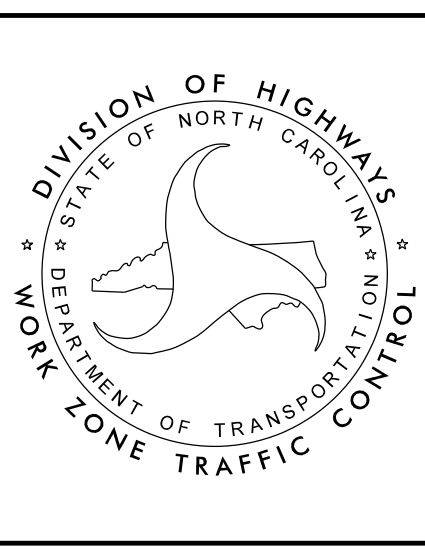

TEMPORARY TRAFFIC CONTROL PHASE II DETAIL AREA 2

DOCUMENT NOT CONSIDERED FINAL UNLESS ALL SIGNATURES COMPLETED

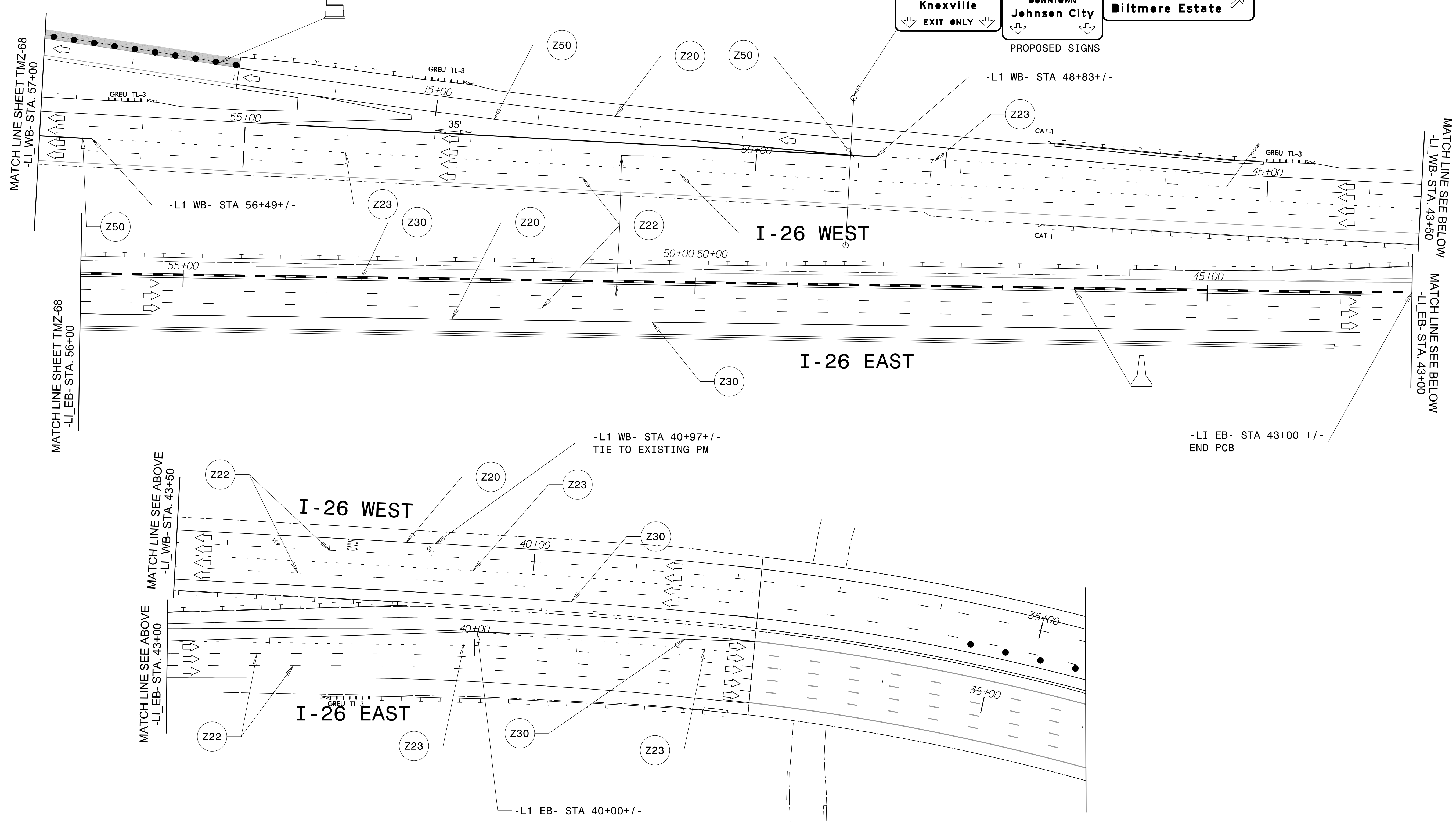
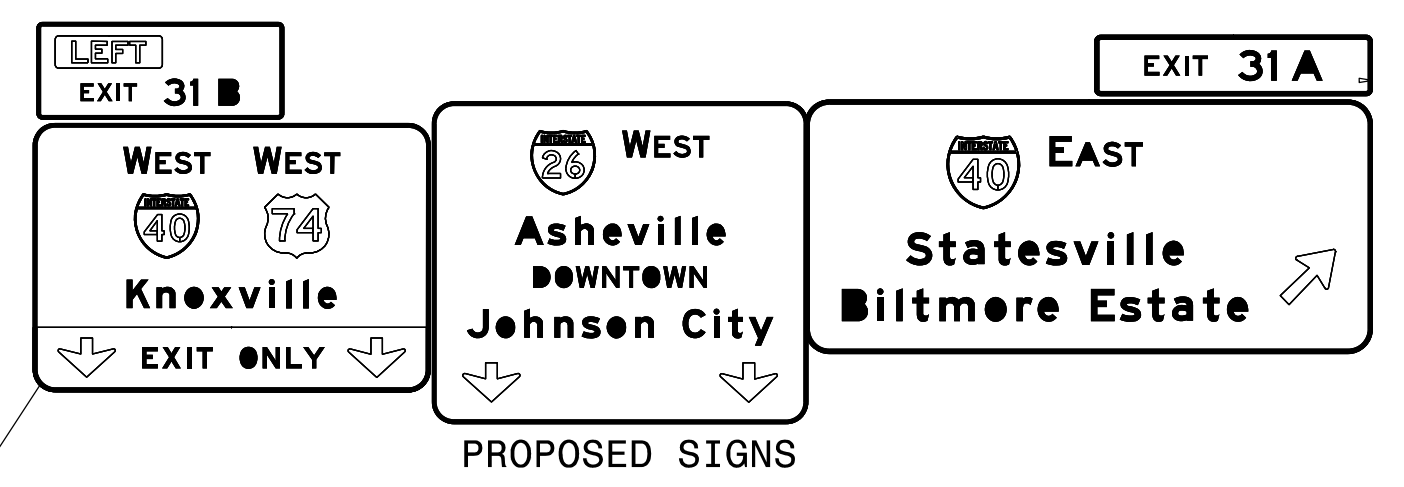

LEGEND	
	NEW TEMPORARY MARKINGS
	EXISTING MARKINGS (GRAY)
	NEW CONSTRUCTION AREAS
	TEMPORARY PAVEMENT
	ON-GOING CONSTRUCTION
	REMOVAL
	OVERLAY/WEDGING

NOTE: THE CONTRACTOR SHALL RELOCATE INFORMATION SIGNS BEFORE CONSTRUCTION REMOVES THEM.
 NOTE: ALL LANE WIDTHS ARE 11' UNLESS OTHERWISE SHOWN.

ICE of CAROLINAS, PLLC
 ICE of Carolinas, PLLC
 4505 Falls of Neuse Road, Suite 110
 Raleigh, North Carolina 27609
 Phone: 803-822-0333
 License #: P-0999

APPROVED: *J. Stuart Bourne*
 DATE: 1/4/2024
 SEAL
 NORTH CAROLINA PROFESSIONAL SEAL 19680 ENGINEER J. STUART BOURNE

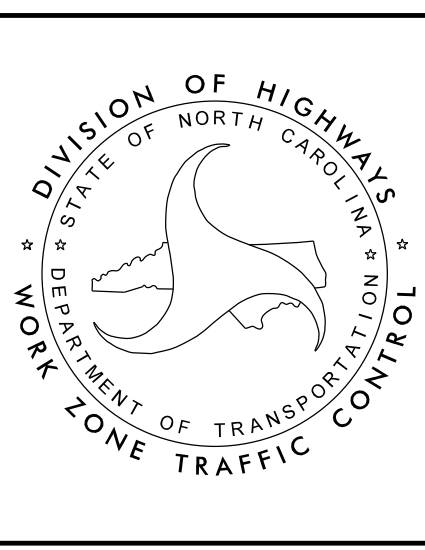

TEMPORARY TRAFFIC CONTROL PHASE III DETAIL AREA 2

DOCUMENT NOT CONSIDERED FINAL UNLESS ALL SIGNATURES COMPLETED

04-JAN-2024 12:01
 R:\Projects\2024\08-01-253A_Work Zone Traffic Control\TrafficControl\CP\ProjectWise\Area 2\Phase 3\I-2513AA_PHASE.3.TMP-67.dgn
 ZG0810112K AT C1F5103

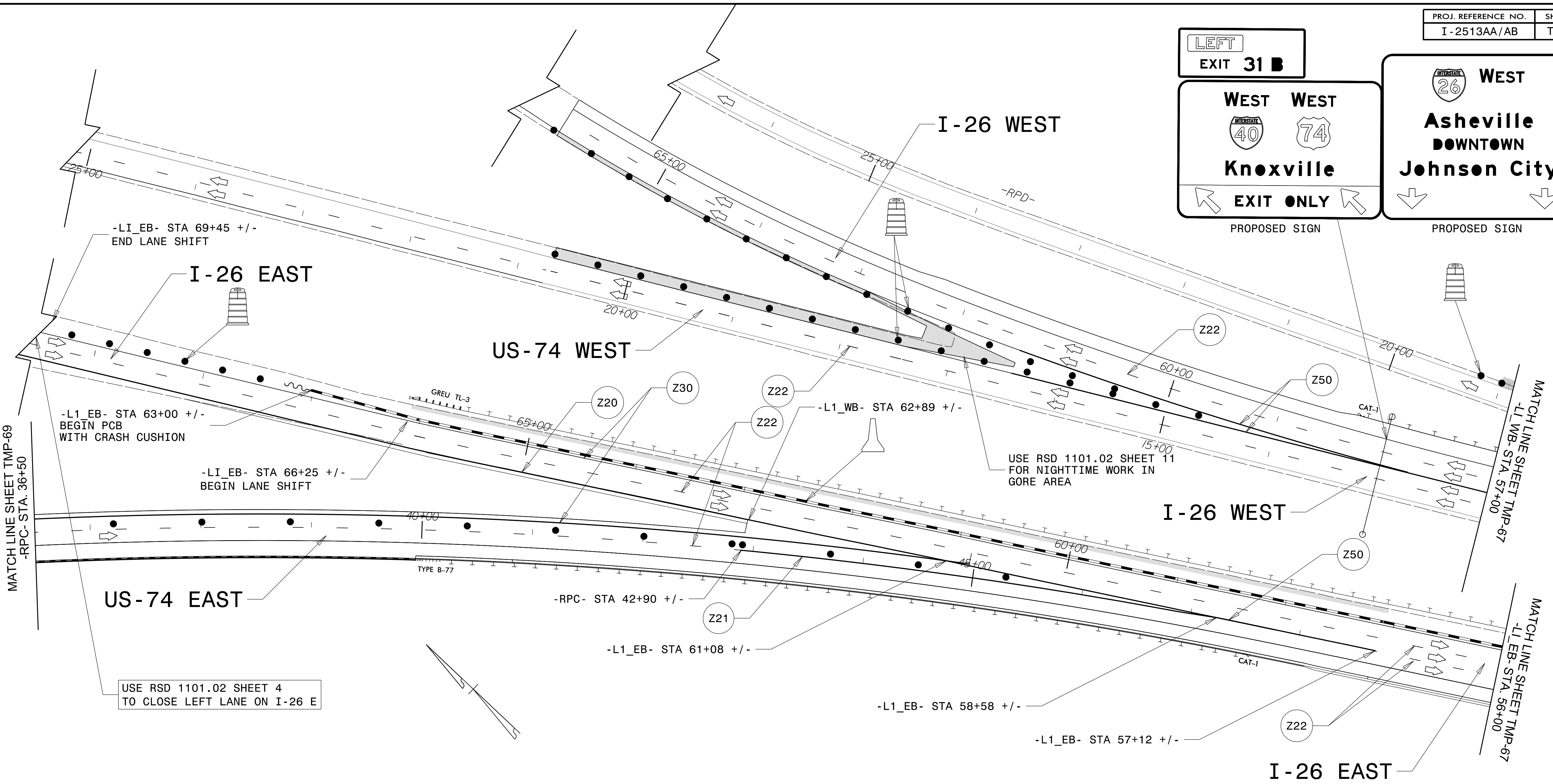

04-JAN-2024 12:08
 R:\Projects\11-08-01-2513A_Work Zone Traffic Control\Traffic Control\ProjectWise\Area 2\Phase 3\I-2513AA_PHASE.3_TMP-68.dgn
 zgon@ndh.ark AT CTF5103

LEGEND	
	NEW TEMPORARY MARKINGS
	EXISTING MARKINGS (GRAY)
	NEW CONSTRUCTION AREAS
	TEMPORARY PAVEMENT
	ON-GOING CONSTRUCTION
	REMOVAL
	OVERLAY/WEDGING

NOTE: THE CONTRACTOR SHALL RELOCATE INFORMATION SIGNS BEFORE CONSTRUCTION REMOVES THEM.
 NOTE: ALL LANE WIDTHS ARE 11' UNLESS OTHERWISE SHOWN.

ICE of Carolinas, PLLC
 4505 Falls of Neuse Road, Suite 110
 Raleigh, North Carolina 27609
 Phone: 803-822-0333
 License #: P-0999

APPROVED: *J. Stuart Bourne*
 DATE: 1/4/2024

SEAL

DOCUMENT NOT CONSIDERED FINAL UNLESS ALL SIGNATURES COMPLETED

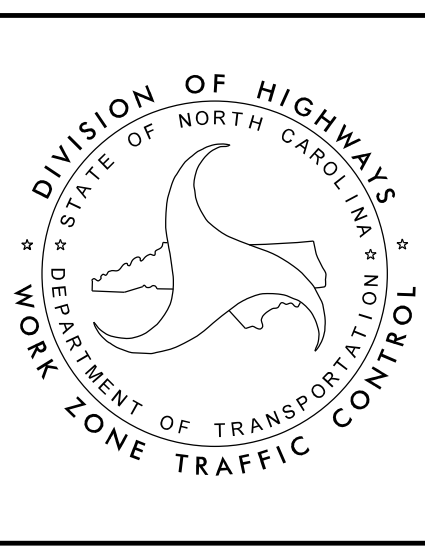

TEMPORARY TRAFFIC CONTROL PHASE III DETAIL AREA 2

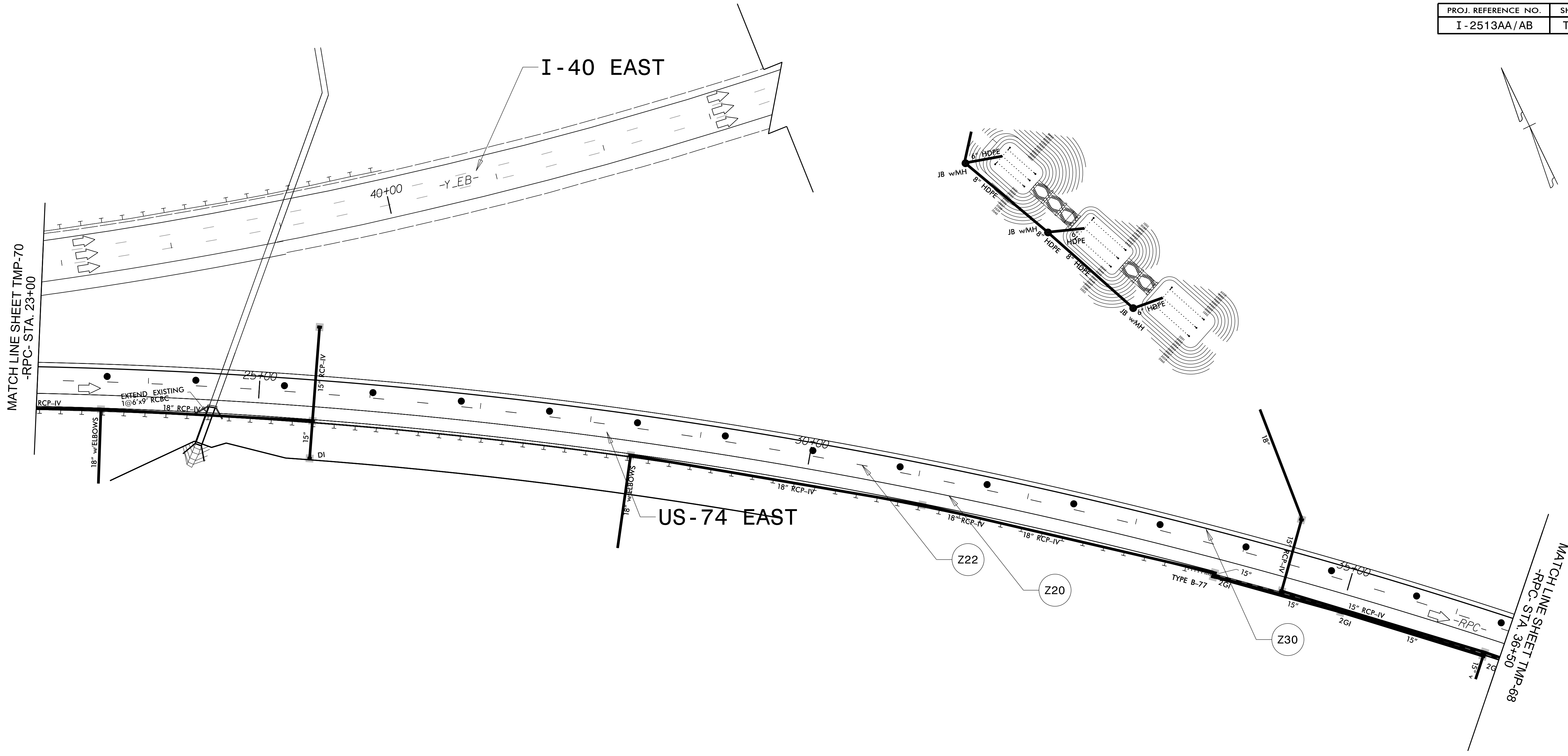

LEGEND

	NEW TEMPORARY MARKINGS
	EXISTING MARKINGS (GRAY)
	NEW CONSTRUCTION AREAS
	TEMPORARY PAVEMENT
	ON-GOING CONSTRUCTION
	REMOVAL
	OVERLAY/WEDGING

NOTE: THE CONTRACTOR SHALL RELOCATE INFORMATION SIGNS BEFORE CONSTRUCTION REMOVES THEM.
 NOTE: ALL LANE WIDTHS ARE 11' UNLESS OTHERWISE SHOWN.

04-JAN-2024 12:10
 R:\Projects\I-25\1-08_01I-253A_WorkZone_TrafficControl\TrafficControl\ProjectWise\Area 2\Phase 3\I-2513AA_PHASE.3_TMP-69.dgn
 ZG081117ZK AT 11:51:03



ICE of Carolinas, PLLC
 4505 Falls of Neuse Road, Suite 110
 Raleigh, North Carolina 27609
 Phone: 803-822-0333
 License #: P-0999

APPROVED:
 DATE: 1/4/2024
 SEAL:

DOCUMENT NOT CONSIDERED FINAL UNLESS ALL SIGNATURES COMPLETED

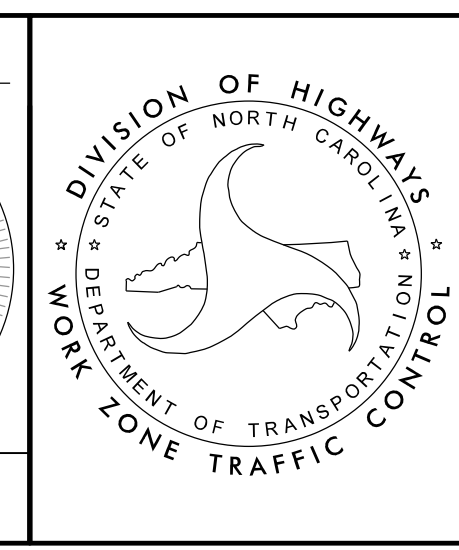

TEMPORARY TRAFFIC CONTROL PHASE III DETAIL AREA 2

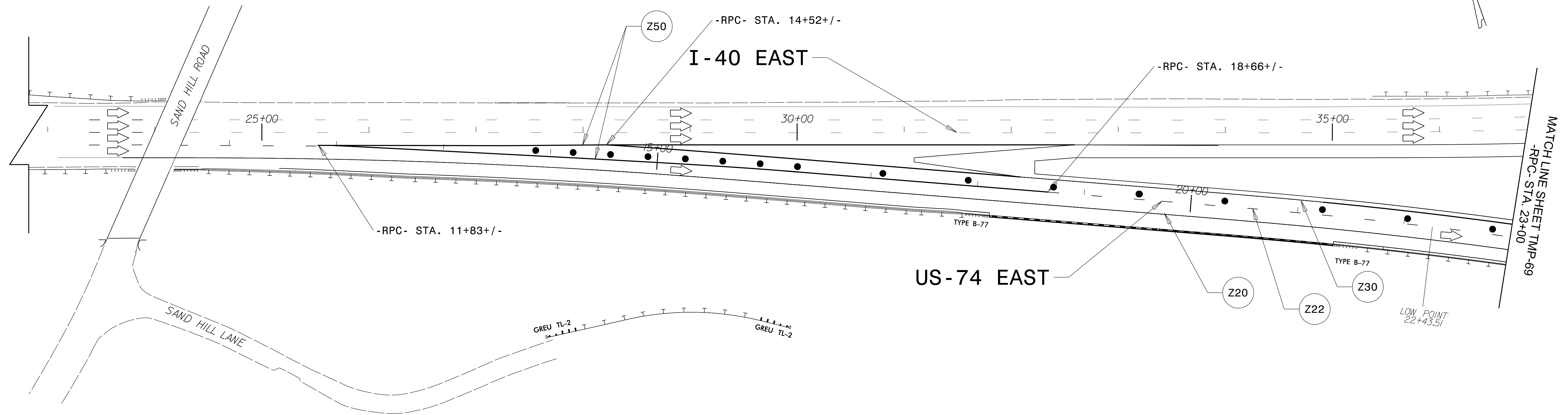

04-JAN-2024 12:42
 R:\Projects\I-2513AA\Work Zone Traffic Control\Traffic Control\ProjectWise\Area 2\Phase 3\I-2513AA_PHASE.3_TMP-70.dgn
 ZG09141412K AT C1F5103

LEGEND	
	NEW TEMPORARY MARKINGS
	EXISTING MARKINGS (GRAY)
	NEW CONSTRUCTION AREAS
	TEMPORARY PAVEMENT
	ON-GOING CONSTRUCTION
	REMOVAL
	OVERLAY/WEDGING

NOTE: THE CONTRACTOR SHALL RELOCATE INFORMATION SIGNS BEFORE CONSTRUCTION REMOVES THEM.
 NOTE: ALL LANE WIDTHS ARE 11' UNLESS OTHERWISE SHOWN.

ICE of Carolinas, PLLC
 4505 Falls of Neuse Road, Suite 110
 Raleigh, North Carolina 27609
 Phone: 803-822-0333
 License #: P-0999

APPROVED:
 DATE: 1/4/2024
 SEAL

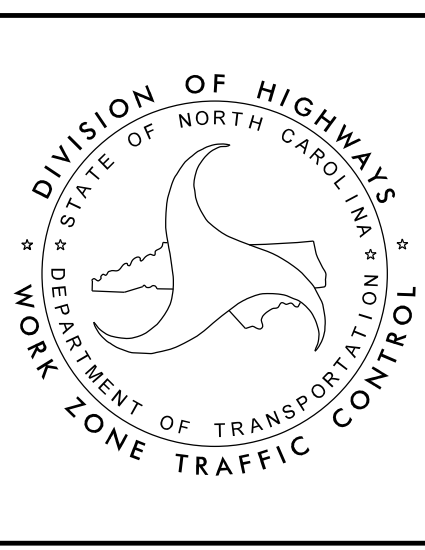

TEMPORARY TRAFFIC CONTROL
PHASE III DETAIL
AREA 2

DOCUMENT NOT CONSIDERED FINAL UNLESS ALL SIGNATURES COMPLETED

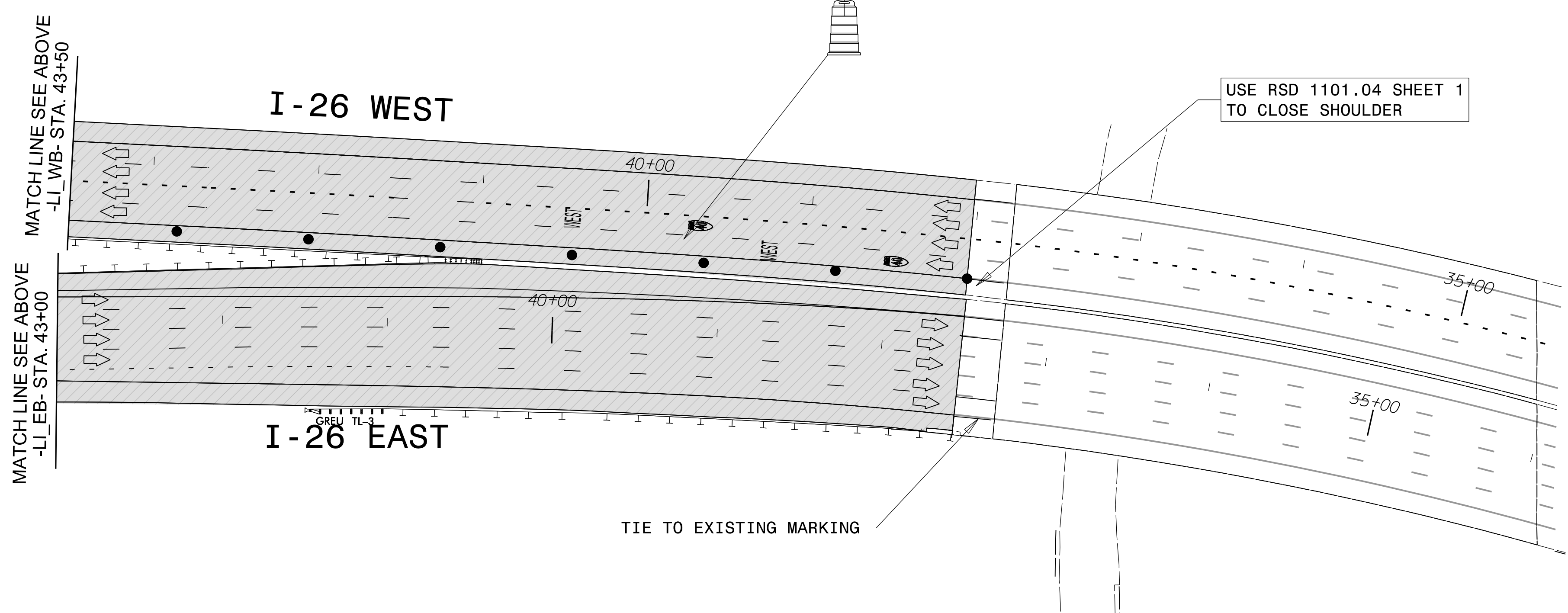
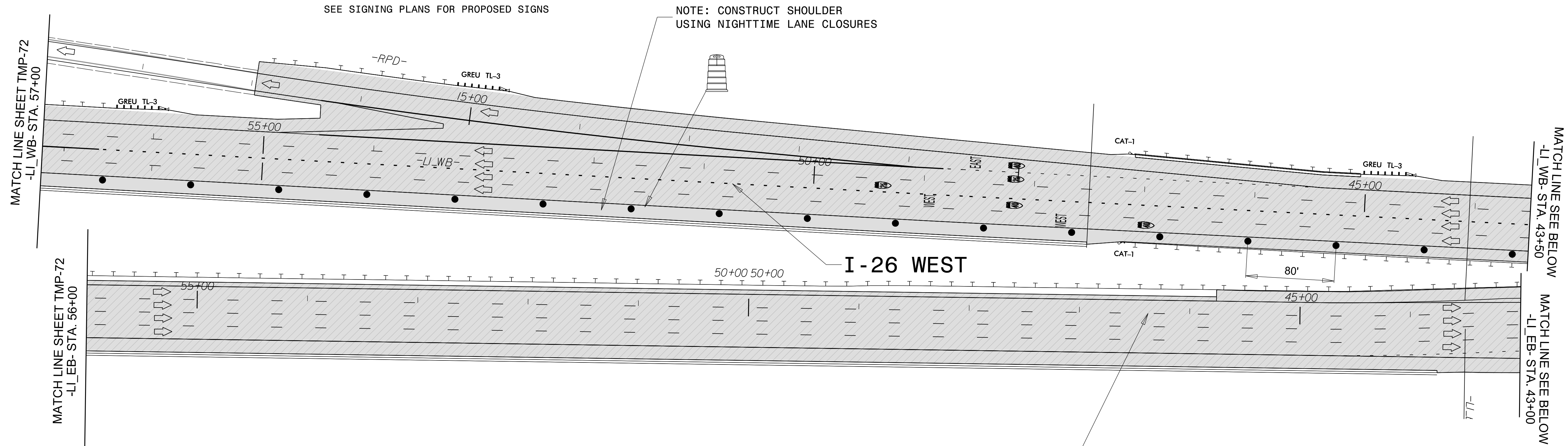

LEGEND

	NEW TEMPORARY MARKINGS
	EXISTING MARKINGS (GRAY)
	NEW CONSTRUCTION AREAS
	TEMPORARY PAVEMENT
	ON-GOING CONSTRUCTION
	REMOVAL
	MILLING/WEDGING/OVERLAY

- NOTES:**
- SEE PAVEMENT MARKING PLANS OF FINAL PAVEMENT MARKING FOR PHASE 4
 - ALL TEMPORARY LANE WIDTHS ARE 11' UNLESS OTHERWISE NOTED.
 - THE CONTRACTOR SHALL RELOCATE INFORMATION SIGNS BEFORE CONSTRUCTION REMOVES THEM.



ICE of Carolinas, PLLC
 4505 Falls of Neuse Road, Suite 110
 Raleigh, North Carolina 27609
 Phone: 803-822-0333
 License #: P-0999

APPROVED:

DATE: 1/4/2024

SEAL

DOCUMENT NOT CONSIDERED FINAL UNLESS ALL SIGNATURES COMPLETED

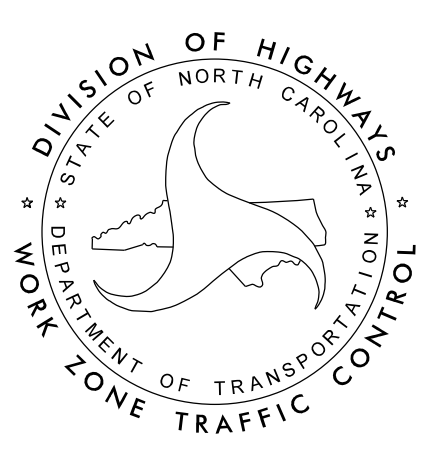

TEMPORARY TRAFFIC CONTROL PHASE IV DETAIL AREA 2

04-JAN-2024 12:44
 R:\Projects\2024\01-2513A_WorkZone_TrafficControl\TrafficControl\CP\ProjectWise\Area 2\Phase 4\I-2513AA_PHASE.4_TMP-71.dgn
 ZG09101112K AT C1F5103

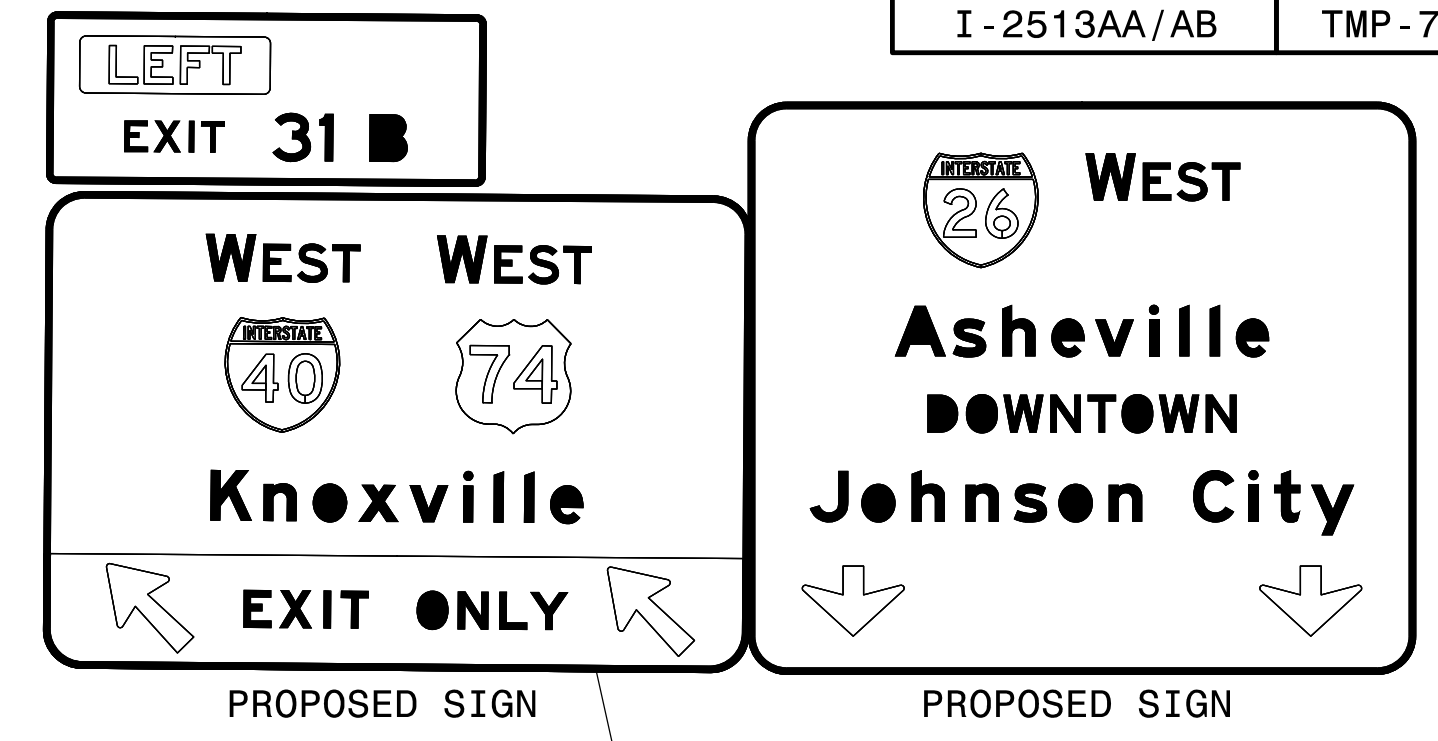
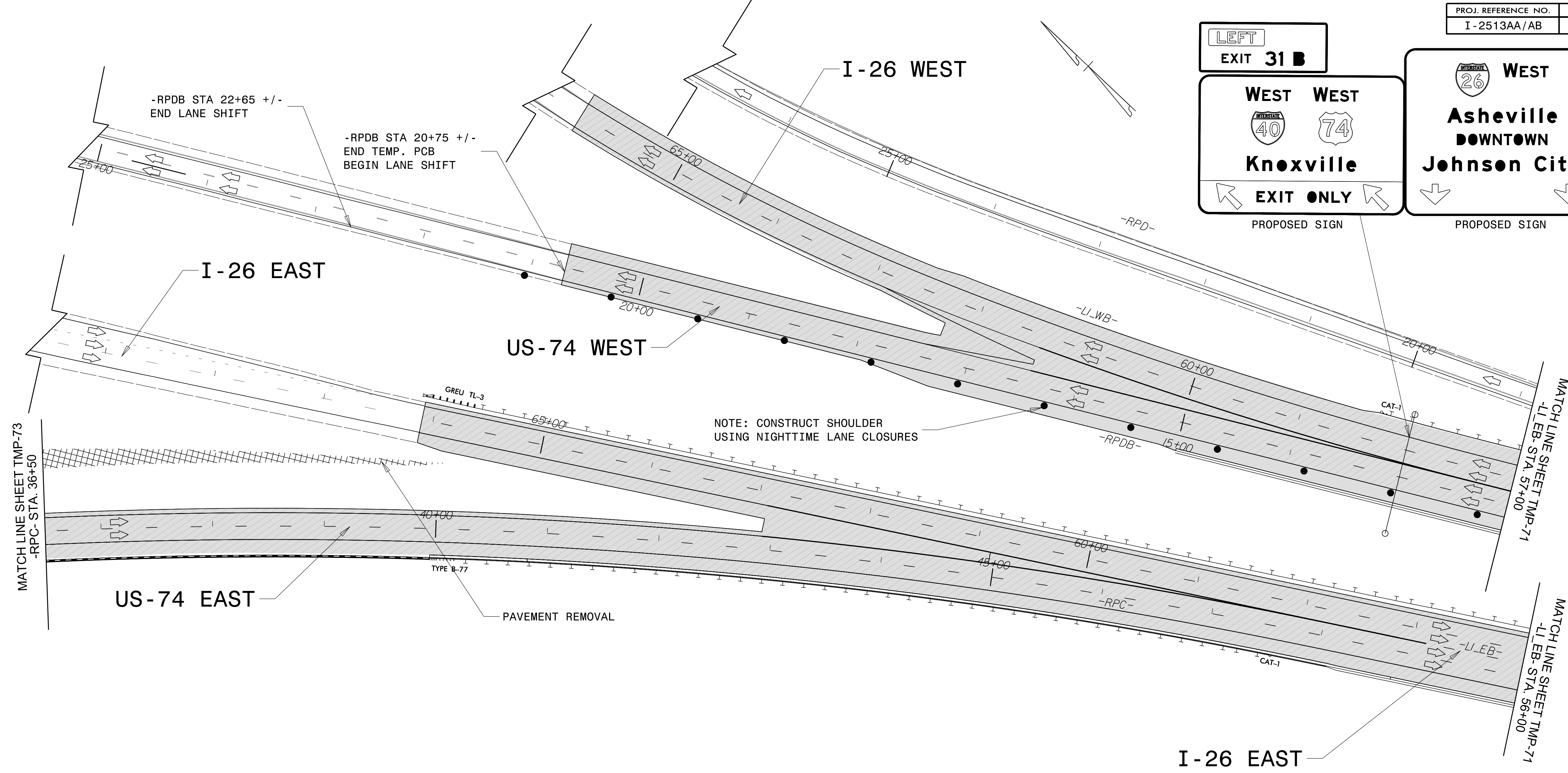

MATCH LINE SHEET TMP-73
-RPC- STA. 36+50

MATCH LINE SHEET TMP-71
-LI.EB- STA. 57+00

MATCH LINE SHEET TMP-71
-LI.EB- STA. 56+00

LEGEND	
	NEW TEMPORARY MARKINGS
	EXISTING MARKINGS (GRAY)
	NEW CONSTRUCTION AREAS
	TEMPORARY PAVEMENT
	ON-GOING CONSTRUCTION
	REMOVAL
	MILLING/WEDGING/OVERLAY

- NOTES:
- 1) SEE PAVEMENT MARKING PLANS OF FINAL PAVEMENT MARKING FOR PHASE 4
 - 2) ALL TEMPORARY LANE WIDTHS ARE 11' UNLESS OTHERWISE NOTED.
 - 3) THE CONTRACTOR SHALL RELOCATE INFORMATION SIGNS BEFORE CONSTRUCTION REMOVES THEM.

04-JAN-2024 12:50 R:\Projects\I-2513AA-Work Zone Traffic Control\Traffic Control\CP\ProjectWise\Area 2\Phase 4\I-2513AA_PHASE.4_TMP-72.dgn

ICE of CAROLINAS, PLLC
 ICE of Carolinas, PLLC
 4505 Falls of Neuse Road, Suite 110
 Raleigh, North Carolina 27609
 Phone: 803-822-0333
 License #: P-0999

APPROVED: *J. Stuart Bourne*
 DATE: 1/4/2024
 SEAL
 NORTH CAROLINA PROFESSIONAL ENGINEER SEAL 19680
 J. STUART BOURNE

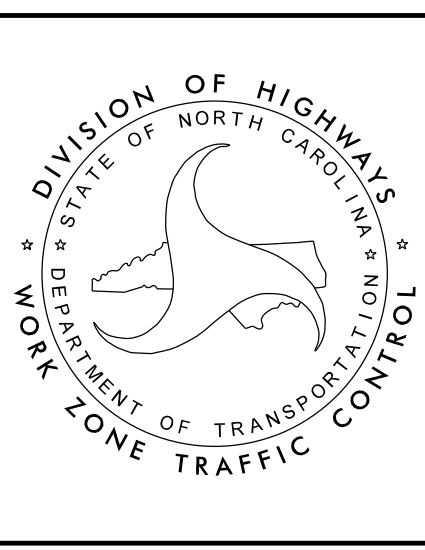

TEMPORARY TRAFFIC CONTROL PHASE IV DETAIL AREA 2

DOCUMENT NOT CONSIDERED FINAL UNLESS ALL SIGNATURES COMPLETED

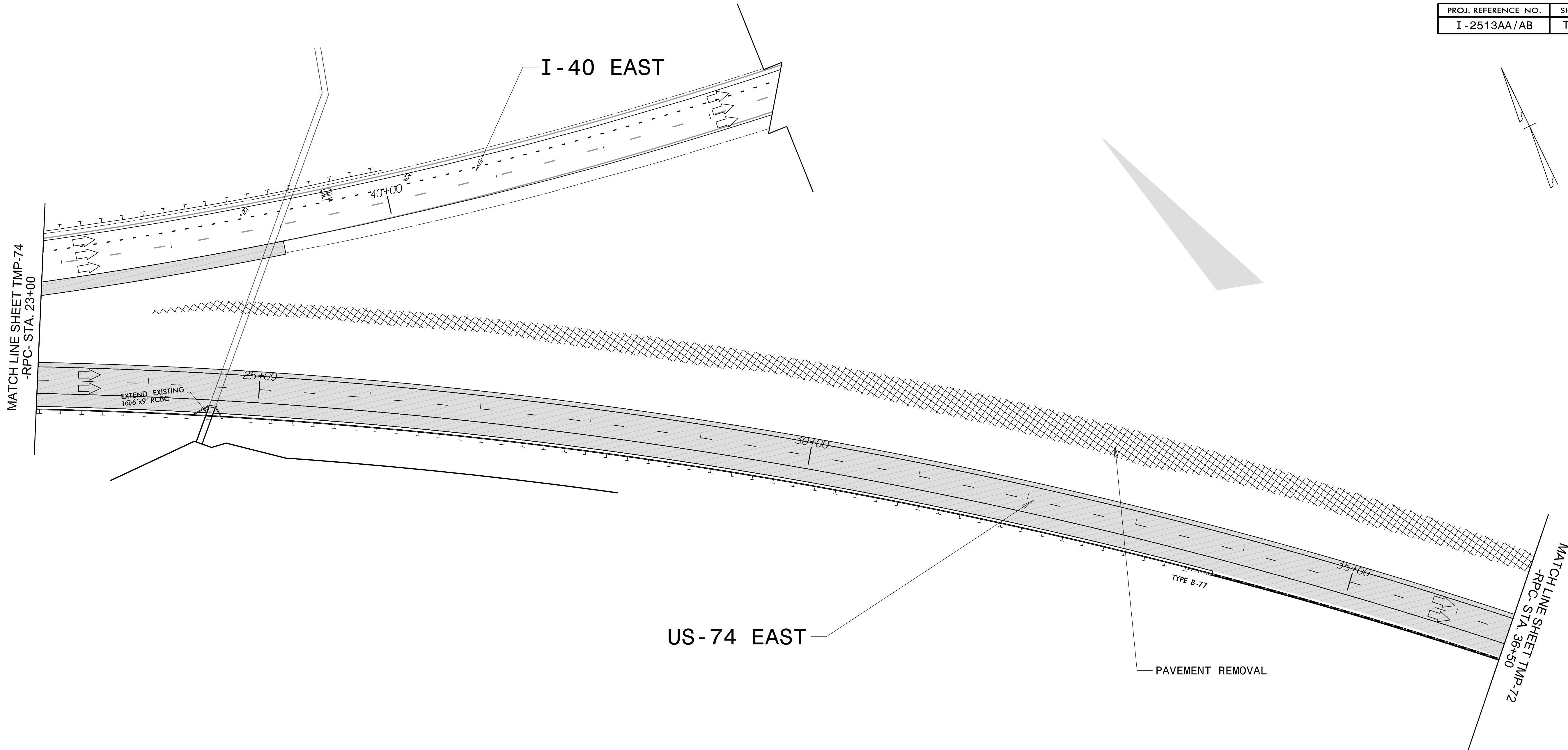

04-JAN-2024 12:53
 R:\Projects\1-08-01-2513A_Work Zone Traffic Control\Traffic Control\CP\ProjectWise\Area 2\Phase 4\I-2513AA_PHASE_4_TMP-73.dgn
 zgonch@ncdot.gov AT C1F5103

LEGEND	
	NEW TEMPORARY MARKINGS
	EXISTING MARKINGS (GRAY)
	NEW CONSTRUCTION AREAS
	TEMPORARY PAVEMENT
	ON-GOING CONSTRUCTION
	REMOVAL
	MILLING/WEDGING/OVERLAY

NOTES:

- 1) SEE PAVEMENT MARKING PLANS OF FINAL PAVEMENT MARKING FOR PHASE 4
- 2) ALL TEMPORARY LANE WIDTHS ARE 11' UNLESS OTHERWISE NOTED.
- 3) THE CONTRACTOR SHALL RELOCATE INFORMATION SIGNS BEFORE CONSTRUCTION REMOVES THEM.

ICE of Carolinas, PLLC
 4505 Falls of Neuse Road, Suite 110
 Raleigh, North Carolina 27609
 Phone: 803-822-0333
 License #: P-0999

APPROVED:
 DATE: 1/4/2024
 SEAL

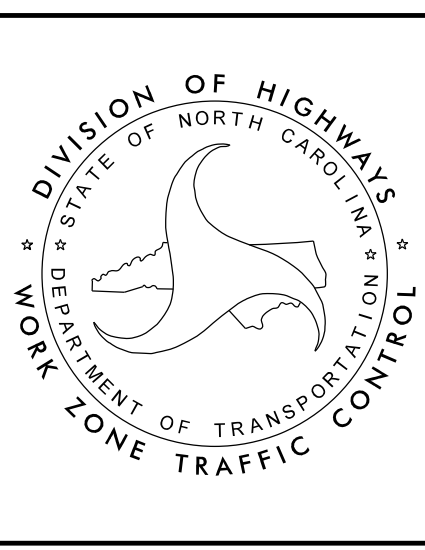

TEMPORARY TRAFFIC CONTROL
PHASE IV DETAIL
AREA 2

DOCUMENT NOT CONSIDERED FINAL UNLESS ALL SIGNATURES COMPLETED

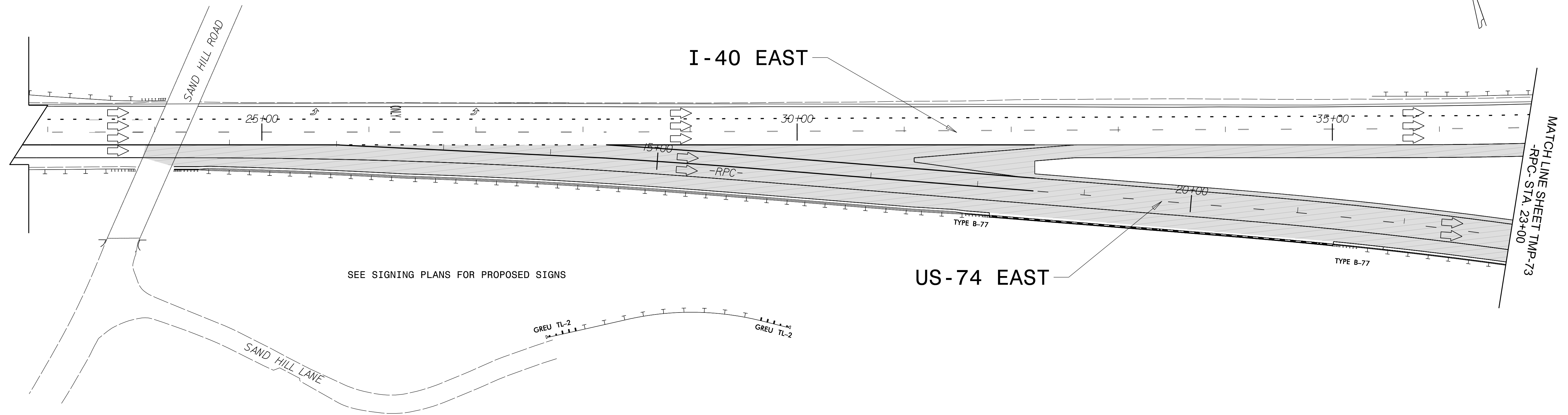

SEE SIGNING PLANS FOR PROPOSED SIGNS

04-JAN-2024 12:55 P:\Projects\11-08-01-2513A_Work Zone Traffic Control\Traffic Control\CP\ProjectWise\Area 2\Phase 4\I-2513AA_PHASE.4_TMP-74.dgn

LEGEND	
	NEW TEMPORARY MARKINGS
	EXISTING MARKINGS (GRAY)
	NEW CONSTRUCTION AREAS
	TEMPORARY PAVEMENT
	ON- GOING CONSTRUCTION
	REMOVAL
	MILLING/WEDGING/OVERLAY

- NOTES:
- 1) SEE PAVEMENT MARKING PLANS OF FINAL PAVEMENT MARKING FOR PHASE 4
 - 2) ALL TEMPORARY LANE WIDTHS ARE 11' UNLESS OTHERWISE NOTED.
 - 3) THE CONTRACTOR SHALL RELOCATE INFORMATION SIGNS BEFORE CONSTRUCTION REMOVES THEM.

ICE of Carolinas, PLLC
 4505 Falls of Neuse Road, Suite 110
 Raleigh, North Carolina 27609
 Phone: 803-822-0333
 License #: P-0999

APPROVED:
 DATE: 1/4/2024

SEAL

**DOCUMENT NOT CONSIDERED FINAL
UNLESS ALL SIGNATURES COMPLETED**

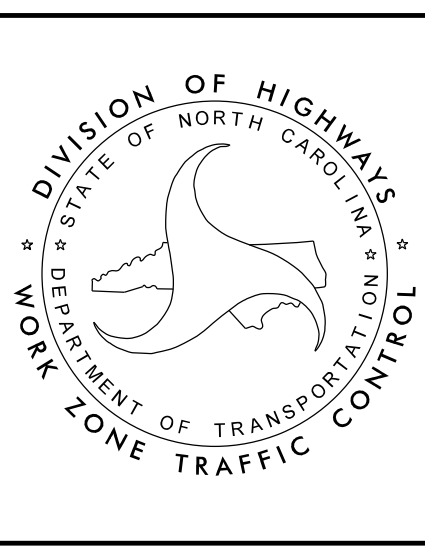

**TEMPORARY TRAFFIC CONTROL
PHASE IV DETAIL
AREA 2**