

### High Speed Detection (≥40 mph)

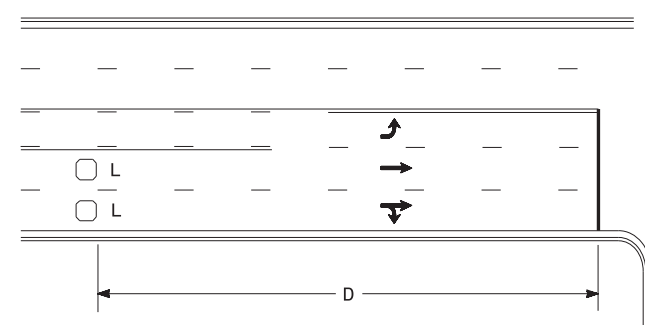

Speed Limit mph	D ft
40	250
45	300
50	355
55	420

L = 6ft X 6ft  
Wired separately

Volume Density Operation

OR

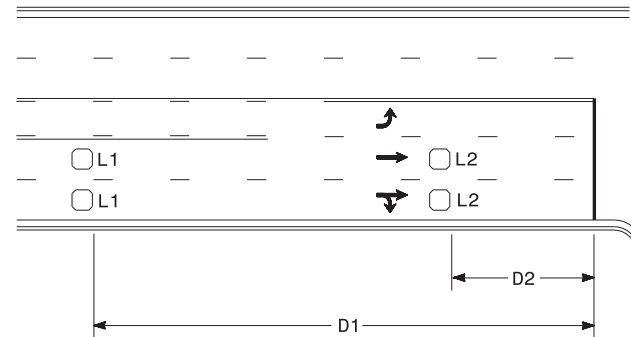

Speed Limit mph	D1 ft	D2 ft
40	250	80
45	300	90
50	355	100
55	420	110

L1 = 6ft X 6ft  
Wired in series  
L2 = 6ft X 6ft  
Wired in series

"Stretch" Operation

### Low Speed Detection (≤35 mph)

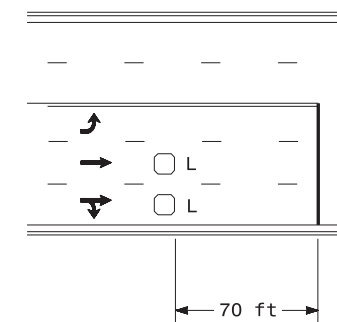

L = 6ft X 6ft  
Wired in series

OR

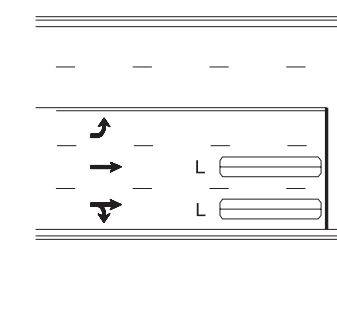

L = 6ft X 40ft  
Quadrupole loop, wired separately

### Left Turn Lane Detection

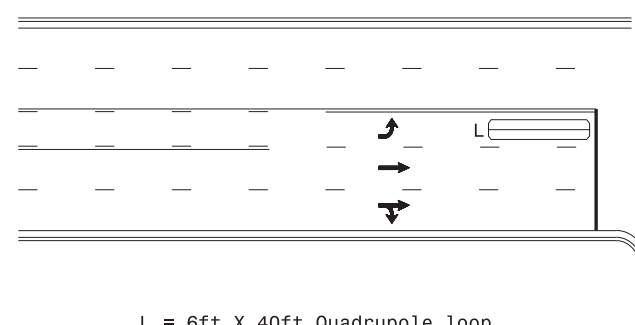

L = 6ft X 40ft Quadrupole loop

Presence Loop Detection

OR

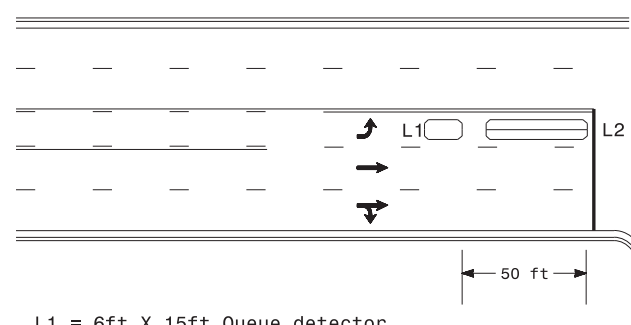

L1 = 6ft X 15ft Queue detector  
L2 = 6ft X 40ft Quadrupole loop

Queue Loop Detection

### Right Turn Lane Detection

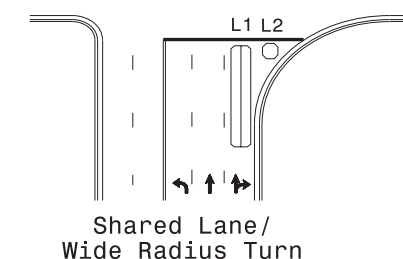

L1 = 6ft X 40ft Quadrupole loop  
L2 = 6ft X 6ft [Minimum] Presence loop  
Wired separately

Shared Lane/  
Wide Radius Turn

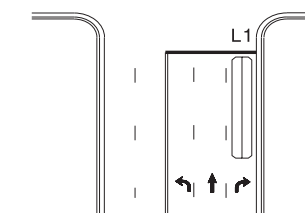

Standard Turn

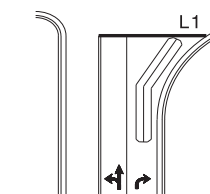

Wide Radius Turn

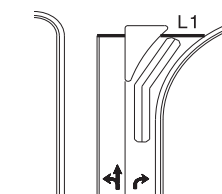

Channelized Turn

### Side Street Detection

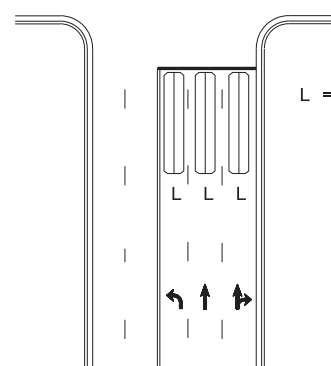

L = 6ft X 40ft  
Quadrupole loop  
Wired to separate  
detectors/channels

### Presence Loop Placement at Stop Lines

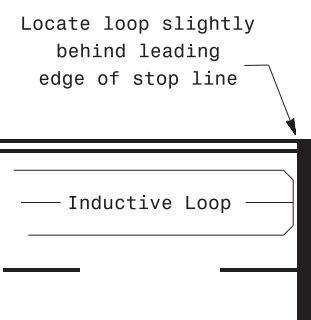

Note:  
Loop may be located in advance of stop line under any of the following conditions:  
1) stop line is greater than 15' from edge of intersecting roadway  
2) loop detects a permissive or protected/permissive left turn  
3) for an exclusive right turn lane

### Recommended Number of Turns

Single 6' X 6' loop  
(when wired separately):

Length of Lead-in ft	Number of Turns
< 250	3
250-375	4
375-525	5
> 525	6

Quadrupole loops: Use 2-4-2 turns

6' X 15' Loops:  
Lead-in < 150', use 2 turns  
Lead-in > 150', use 3 turns

	<p>Prepared In the Offices of:</p> <p>PLANNING, MOBILITY AND SAFETY DIVISION STATE OF NORTH CAROLINA SIGNAL DESIGN SECTION 750 N. Greenfield Pkwy, Garner, NC 27529</p>		<p>SEAL NORTH CAROLINA PROFESSIONAL ENGINEER 029904 JASON P. GALLOWAY</p>	
	<p>PLAN DATE: September 2020</p>		<p>REVIEWED BY: JPG</p>	
<p>PREPARED BY: PLA</p>		<p>REVIEWED BY:</p>		
<p>SCALE N/A</p>	<p>REVISIONS</p>	<p>INIT.</p>	<p>DATE</p>	
<p>9/8/2020</p>		<p>DATE</p>		