

QUANTITIES ARE APPROXIMATE ONLY. THE RESIDENT ENGINEER WILL RE-CROSS-SECTION THE WORK ACCURATELY WHEN THE PROJECT IS STAKED OUT. THESE CROSS-SECTION NOTES WILL BE USED IN COMPUTING THE FINAL QUANTITIES FOR WHICH THE CONTRACTOR WILL BE PAID.

CHEROKEE COUNTY

T.I.P. PROJECT R-5861

STATE PROJECT # 35993.1.1

CROSS SECTION	LINE	SHEET NO.	LINE	SHEET NO.
		X-1A THRU X-1G	-DR11-	X-280 THRU X-281
	-L-	X-1 THRU X-200	-DR12-	X-282 THRU X-284
	-Y1-	X-201 THRU X-207	-DR13-	X-285
	-Y2-	X-208 THRU X-212	-DR14-	X-286 THRU X-288
	-Y3-	X-213 THRU X-218	-DR15-	X-289 THRU X-295
	-Y3A-	X-219	-DR16-	X-296
	-Y4-	X-220 THRU X-221	-DR17-	X-297
	-Y5-	X-222	-DR18-	X-298
	-Y6-	X-223 THRU X-228	-DR19-	X-299
	-Y7-	X-229 THRU X-232	-DR20-	X-300
	-Y8-	X-233 THRU X-235	-DR21-	X-301
	-Y9-	X-236 THRU X-239	-DR22-	X-302 THRU X-303
	-Y10A-	X-240 THRU X-243	-L_DET1-	X-304 THRU X-331
	-Y10B-	X-244 THRU X-248	-L_DET2-	X-332 THRU X-363
	-Y11-	X-249 THRU X-252	-L_DET3-	X-364 THRU X-374
	-Y11A-	X-253 THRU X-256	-L_DET4-	X-375 THRU X-403
	-Y12-	X-257 THRU X-263	-L_DET6-	X-404 THRU X-431
	-Y13-	X-264 THRU X-266	-DET_DR18-	X-432 THRU X-435
	-DR1-	X-267	-DET_DR18B-	X-436 THRU X-437
	-DR2-	X-268 THRU X-269	-DET_DR19-	X-438 THRU X-440
	-DR5-	X-270	-DET_DR22-	X-441 THRU X-446
	-DR6-	X-271 THRU X-272	-DR18B-	X-447 THRU X-448
	-DR7-	X-273 THRU X-276	-DR25-	X-449 THRU X-451
	-DR8-	X-277	-DR26-	X-452 THRU X-453
	-DR9-	X-278	-DR27-	X-454 THRU X-455
	-DR10-	X-279	-DR28-	X-456 THRU X-460
			-DR29-	X-461 THRU X-464
			-DET_Y1-	X-465 THRU X-466



UNDERCUT EXCAVATION



SHALLOW UNDERCUT EXCAVATION

8/23/99

STATE OF NORTH CAROLINA DIVISION OF HIGHWAYS

CROSS-SECTION SUMMARY

NOTE: EMBANKMENT DOES NOT INCLUDE BACKFILL FOR UNDERCUT

Table with columns for Station, Uncl. Exc., Embt, and L RT. It lists construction data for various stations including Det_Dr19, Det_Dr22, Dr29, Dr26, Dr28, Dr14, Dr17, Dr16, Y10A, Y7, Y11, Y11A, and L (REMOVE L_DET1). Each row provides values for uncultivated excavation, embankment, and right-of-way for different stationing points.

STATE OF NORTH CAROLINA
DIVISION OF HIGHWAYS

CROSS-SECTION SUMMARY

NOTE: EMBANKMENT DOES NOT INCLUDE BACKFILL FOR UNDERCUT

Table with columns for Station, Uncl. Exc., and Embt, repeated for multiple cross-sections (L LT, Y12 RT, Dr15, Y13). It lists stationing and corresponding excavation and embankment volumes in cubic yards.

8/23/99

9/27/2023
F:\Roadway\XSC\XPLs\RS661_Rdy_XPL_INDEX.dgn
Johnson

STATE OF NORTH CAROLINA
DIVISION OF HIGHWAYS
CROSS-SECTION SUMMARY

NOTE: EMBANKMENT DOES NOT INCLUDE BACKFILL FOR UNDERCUT

Station	Uncl. Exc.	Embt
L	(cu. yd.)	(cu. yd.)
198+00.00	226	39
198+50.00	81	51
199+00.00	34	69
199+50.00	23	51

Station	Uncl. Exc.	Embt
Dr22	(cu. yd.)	(cu. yd.)
10+12.00	0	0
10+20.00	82	0
10+40.00	347	0
10+60.00	247	0
10+80.00	3	0
11+00.00	4	0

Station	Undercut
L	(cu. yd.)
126+90.00	0
127+00.00	46
127+50.00	232
128+00.00	233
128+25.00	115

Station	Undercut
L	(cu. yd.)
190+75.00	0
191+00.00	120
191+50.00	188
192+00.00	153
192+25.00	85

Station	Undercut
L (L_DET3)	(cu. yd.)
14+43.00	0
14+77.61	196
15+29.13	322
15+80.50	331
16+55.00	449

Station	Undercut
Y9	(cu. yd.)
12+60.00	0
13+00.00	40
13+20.00	20

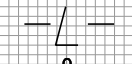
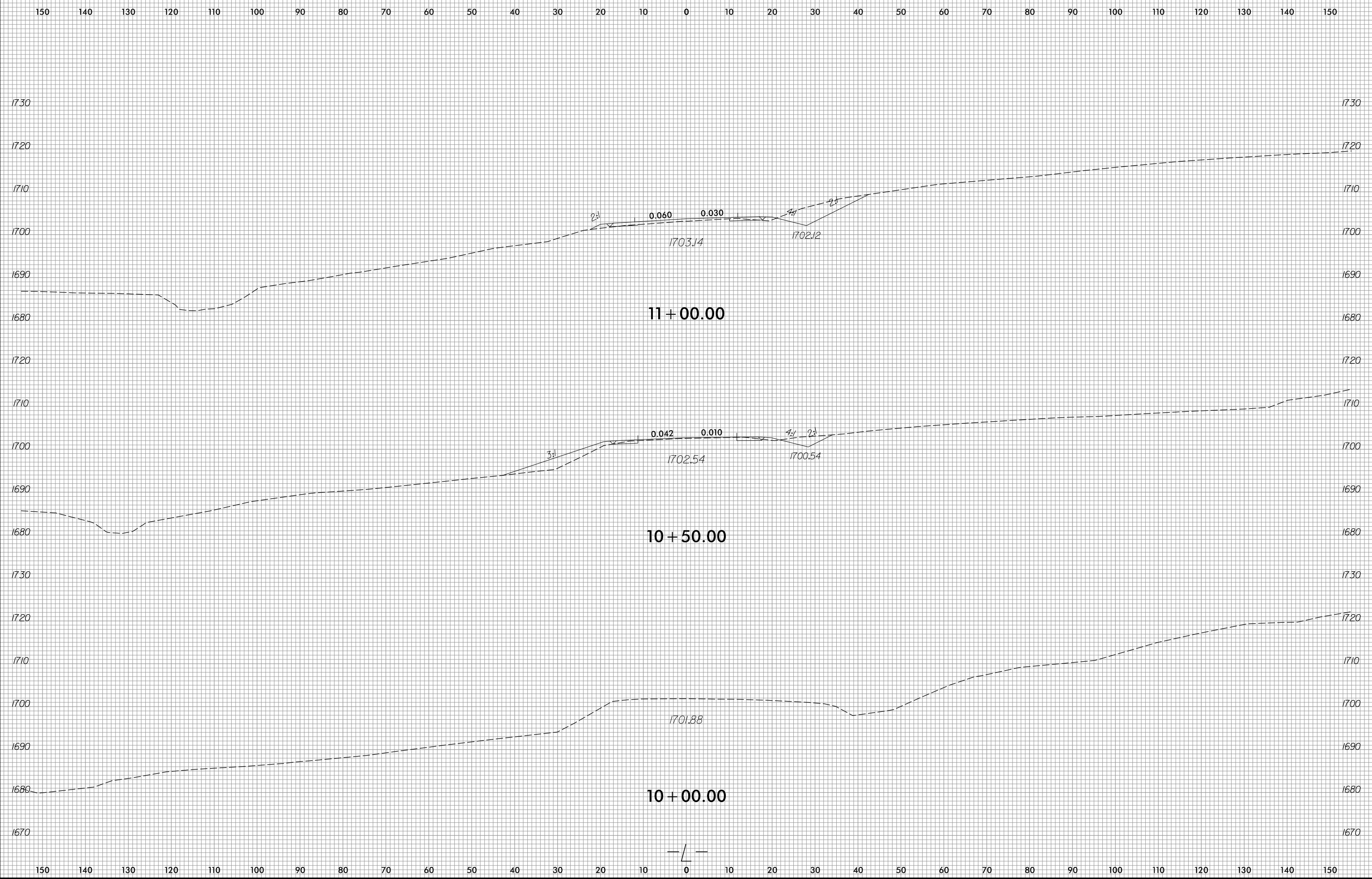



150 140 130 120 110 100 90 80 70 60 50 40 30 20 10 0 10 20 30 40 50 60 70 80 90 100 110 120 130 140 150

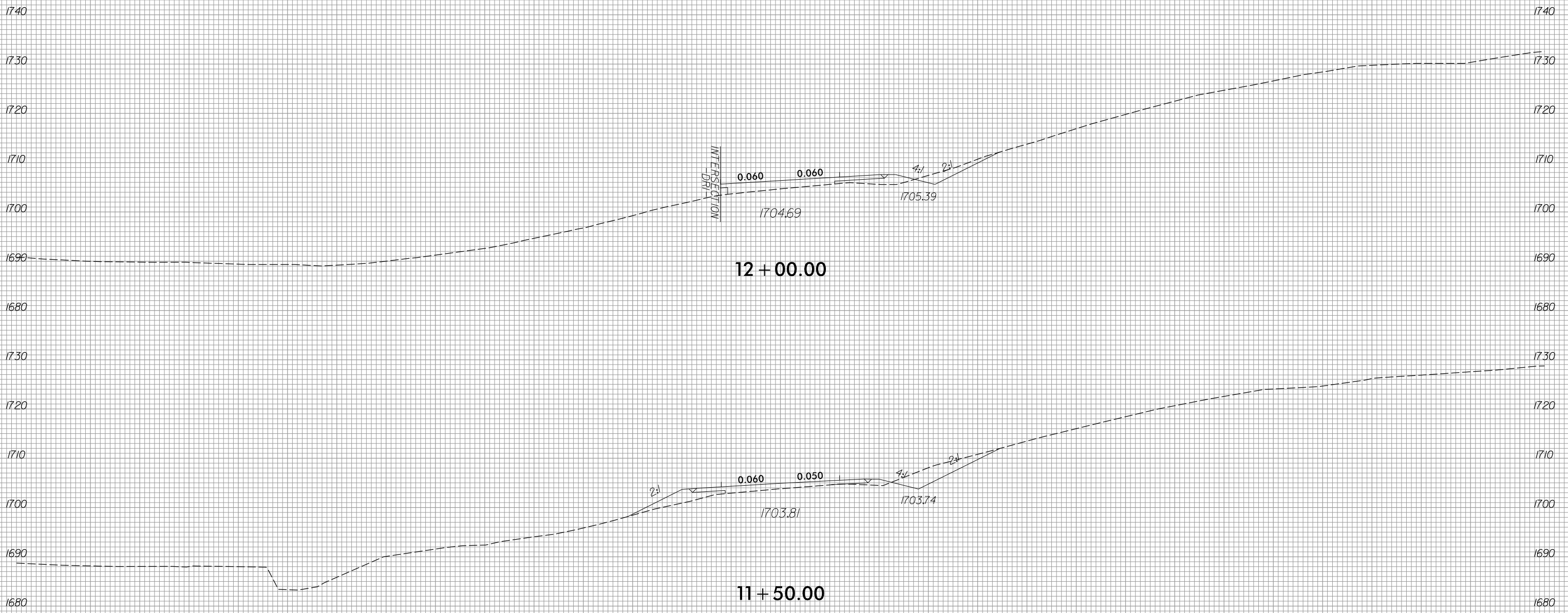

150 140 130 120 110 100 90 80 70 60 50 40 30 20 10 0 10 20 30 40 50 60 70 80 90 100 110 120 130 140 150

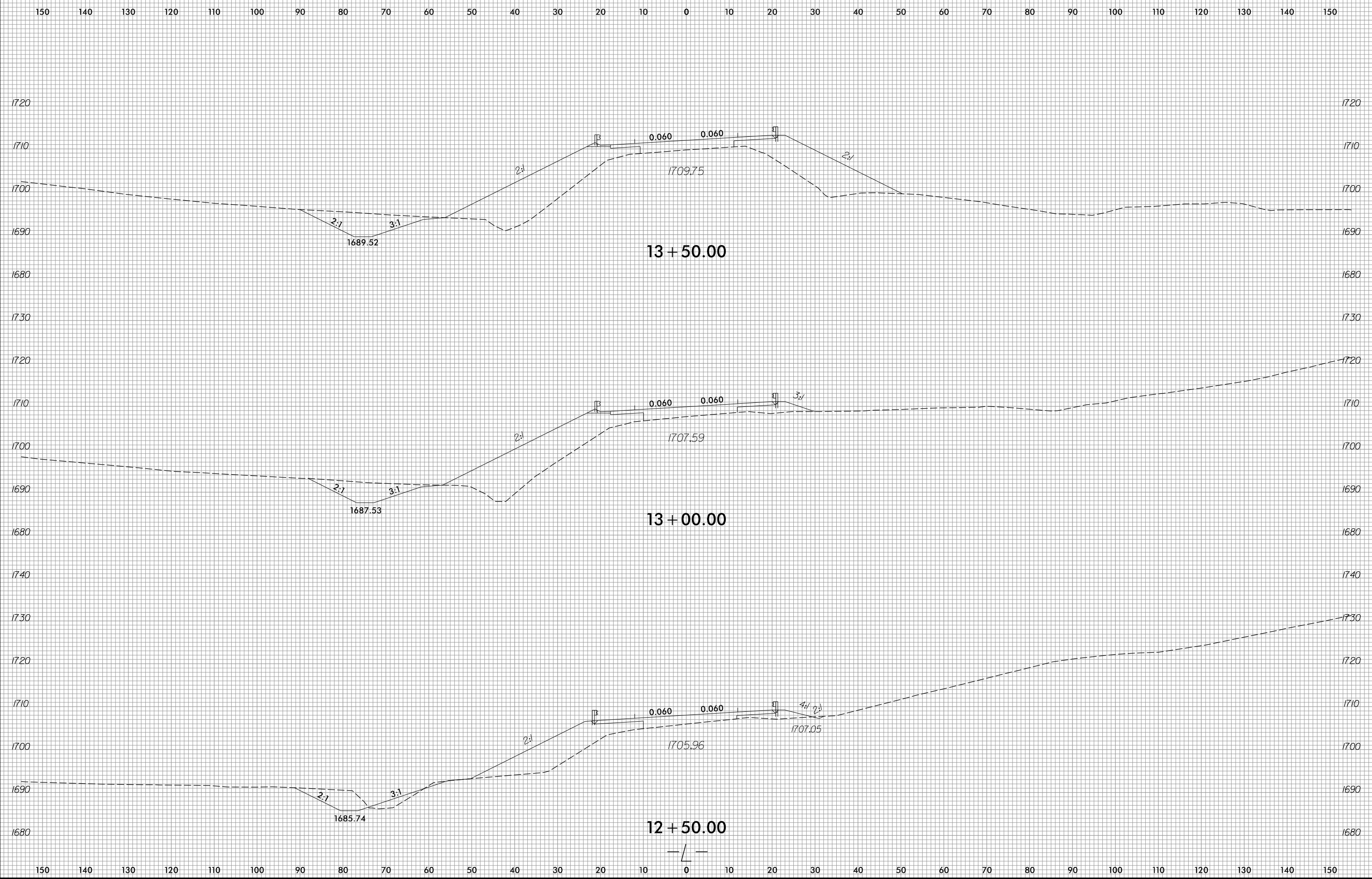



150 140 130 120 110 100 90 80 70 60 50 40 30 20 10 0 10 20 30 40 50 60 70 80 90 100 110 120 130 140 150

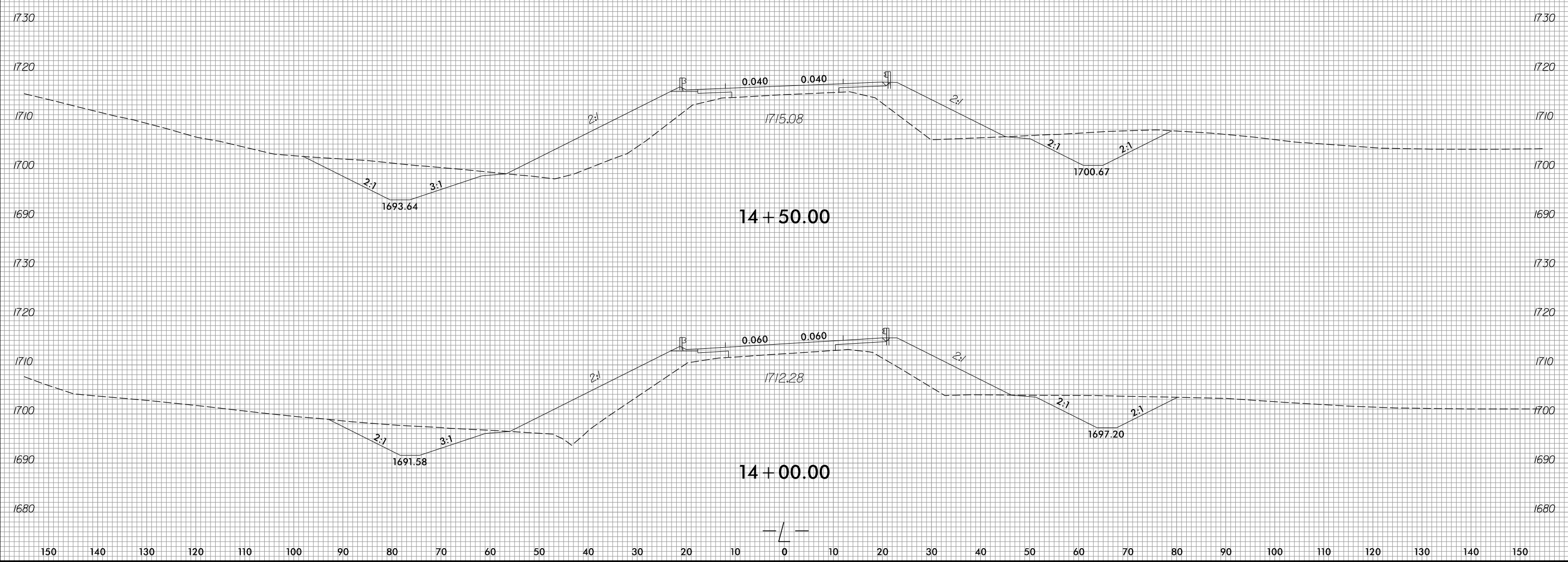



160 150 140 130 120 110 100 90 80 70 60 50 40 30 20 10 0 10 20 30 40 50 60 70 80 90 100 110 120 130 140

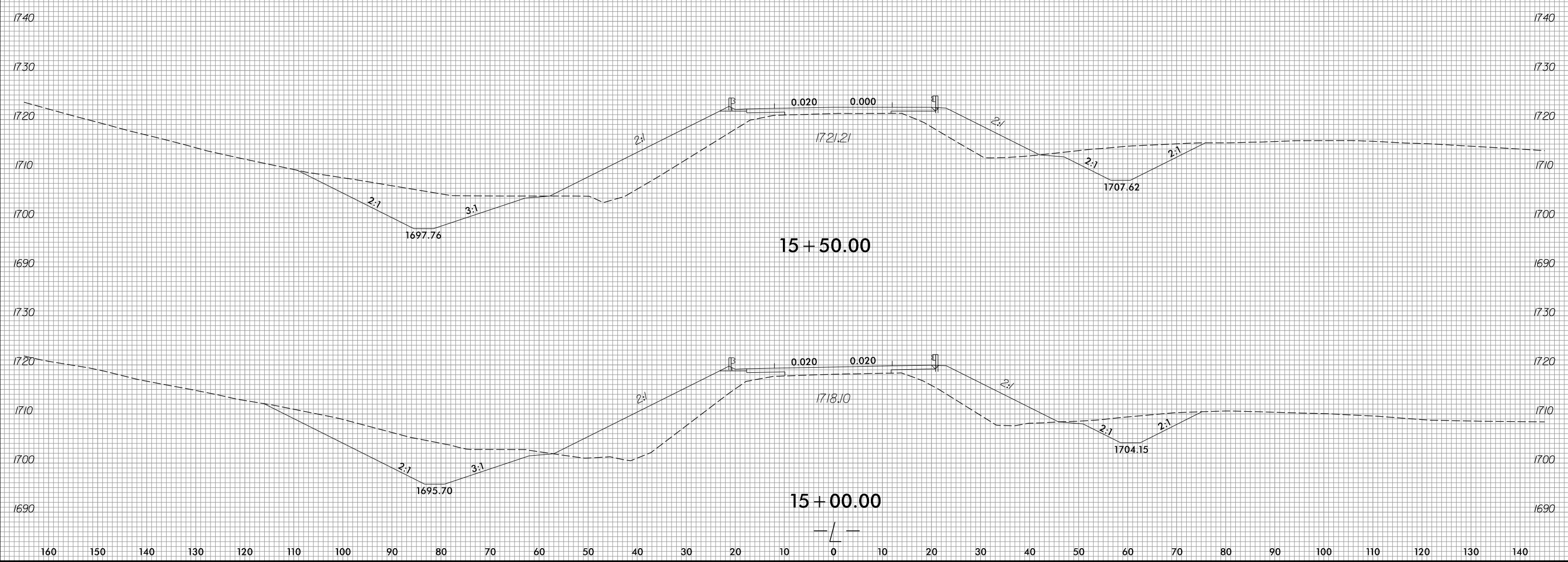

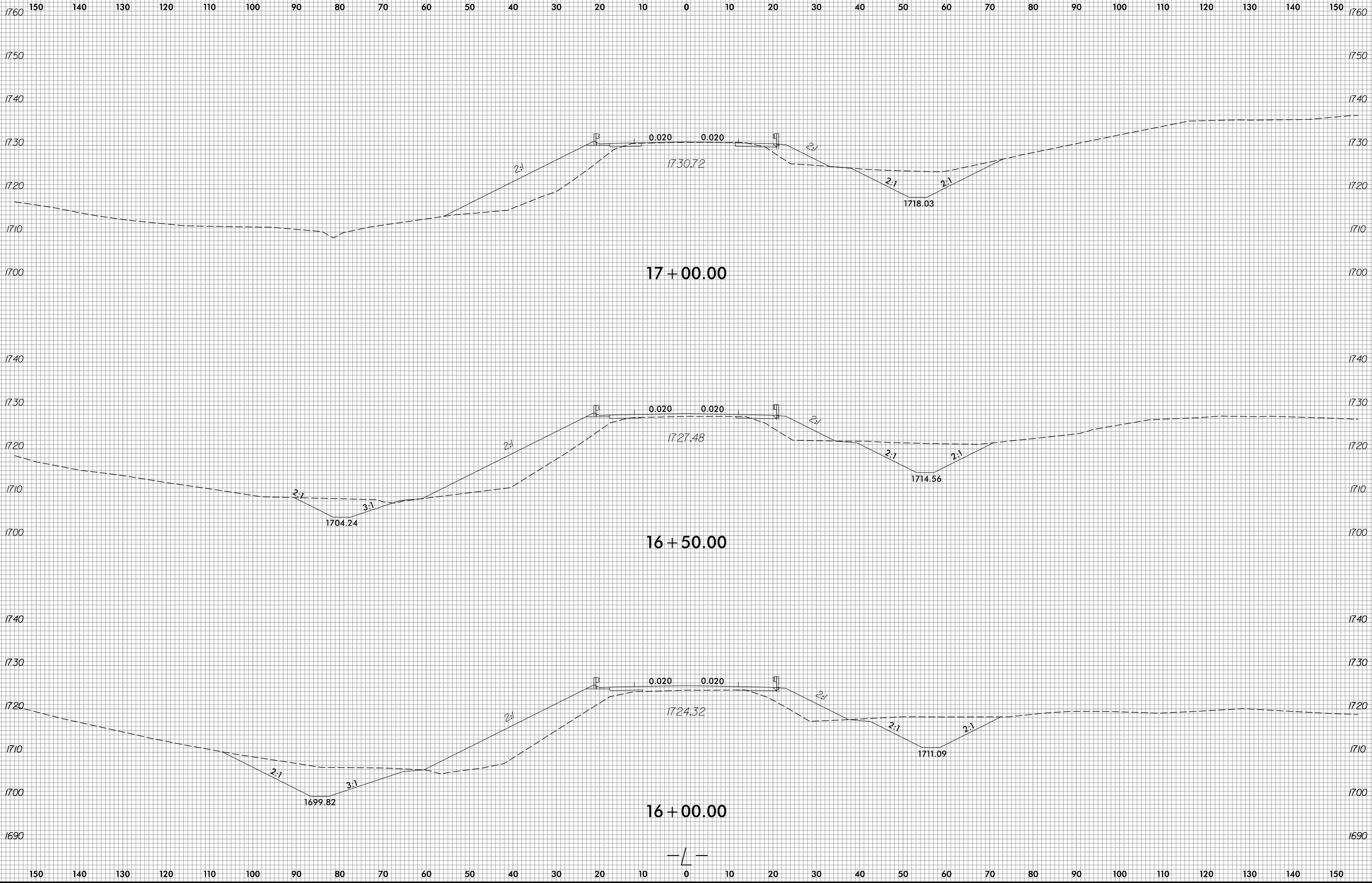

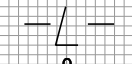
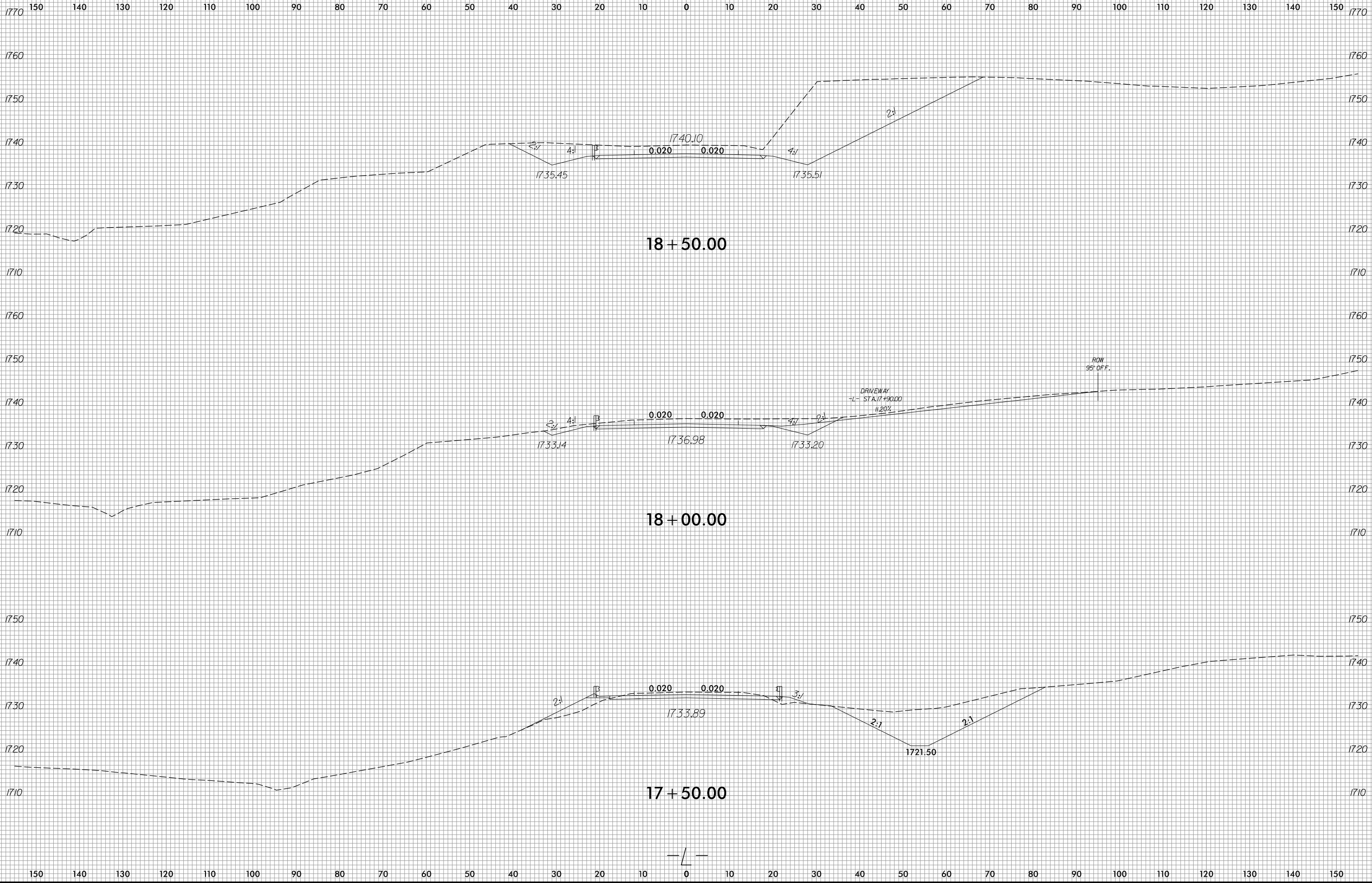

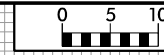

150 140 130 120 110 100 90 80 70 60 50 40 30 20 10 0 10 20 30 40 50 60 70 80 90 100 110 120 130 140 150

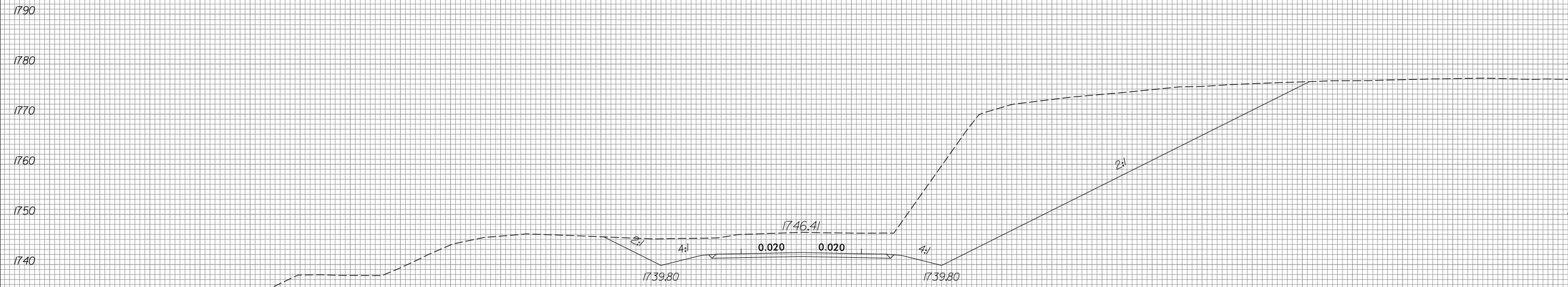

19 + 50.00

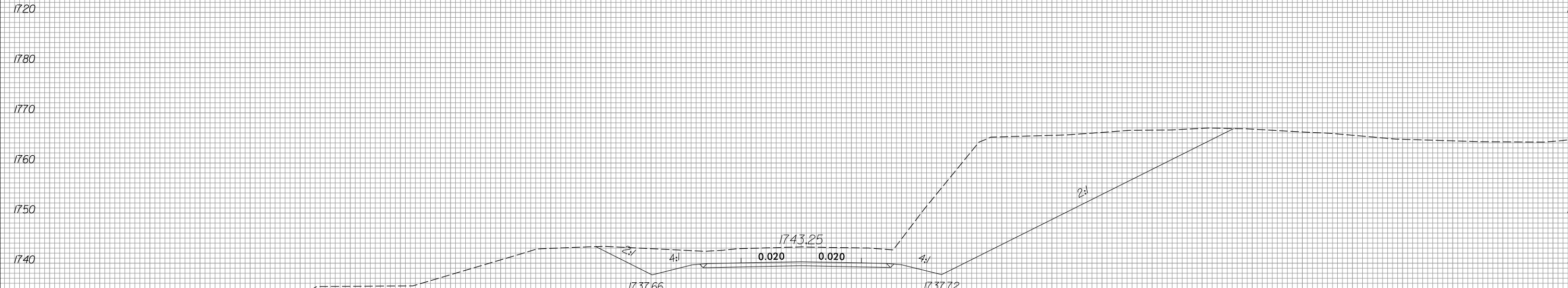

19 + 00.00

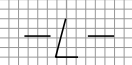

150 140 130 120 110 100 90 80 70 60 50 40 30 20 10 0 10 20 30 40 50 60 70 80 90 100 110 120 130 140 150

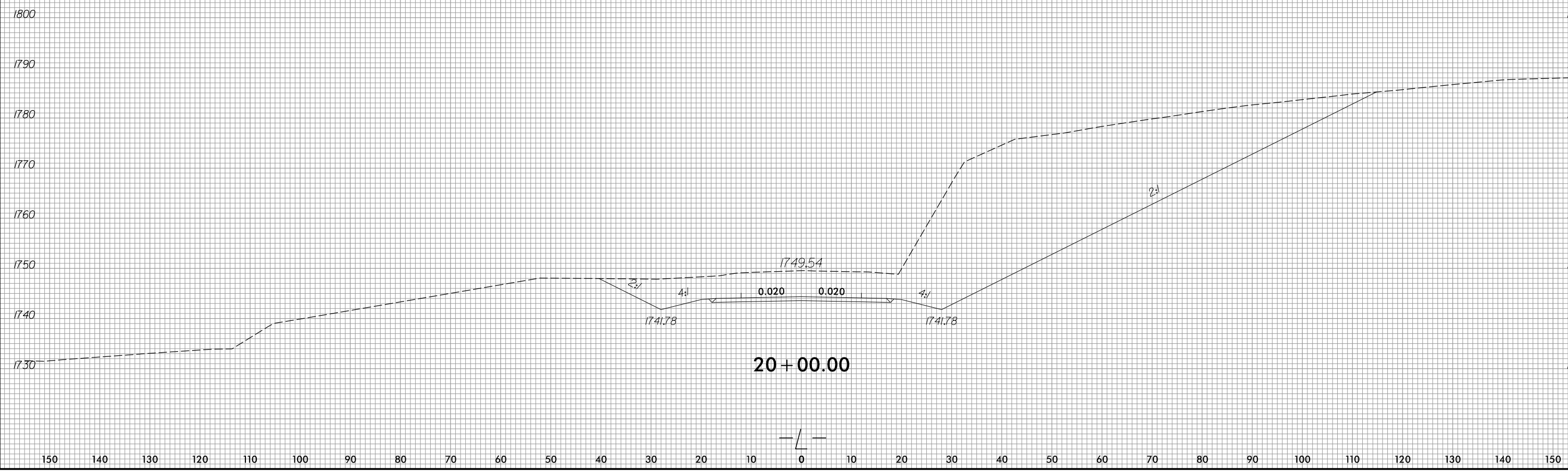
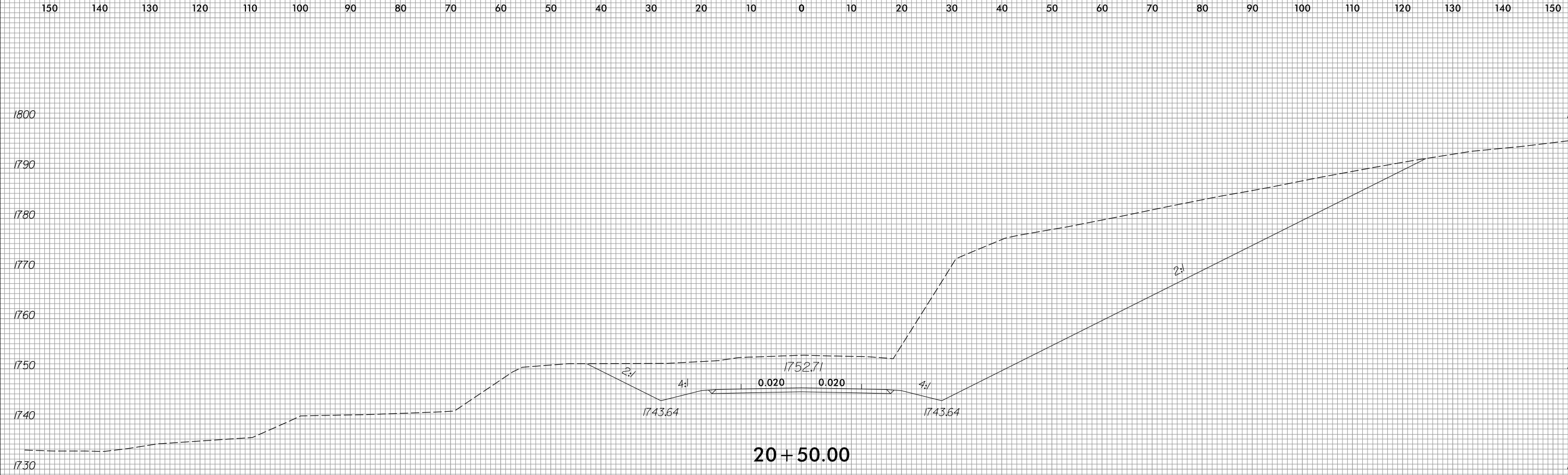

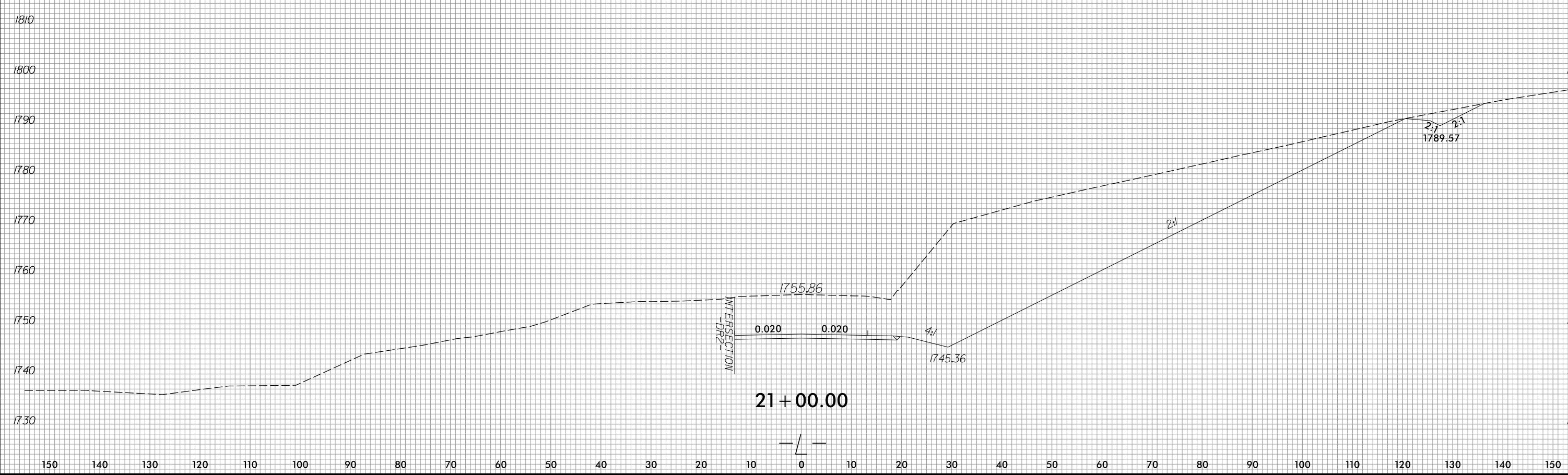
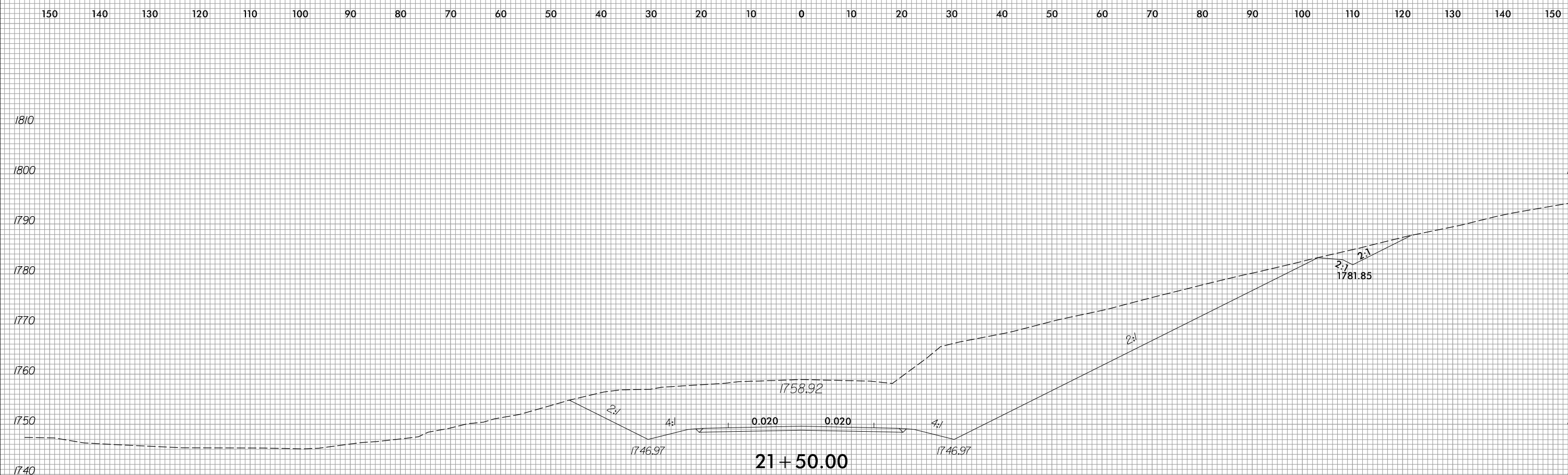



150 140 130 120 110 100 90 80 70 60 50 40 30 20 10 0 10 20 30 40 50 60 70 80 90 100 110 120 130 140 150

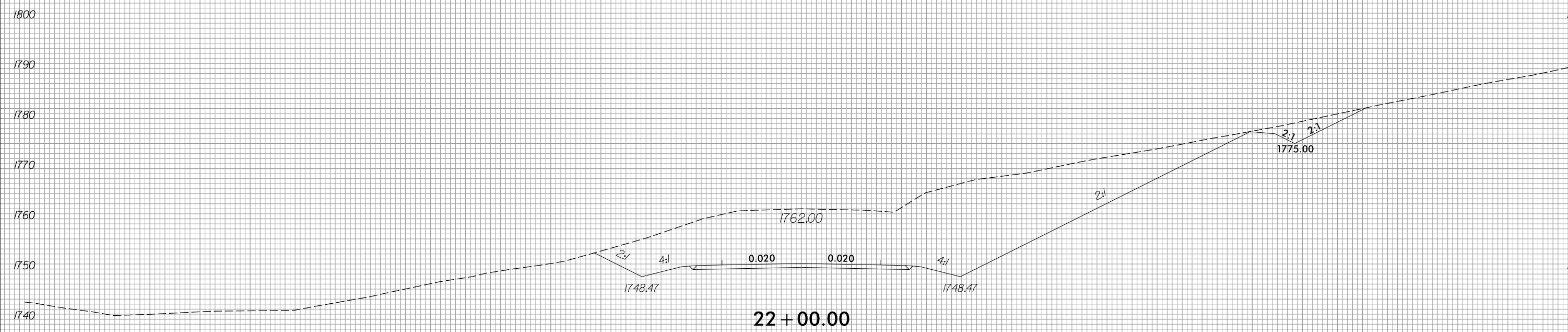
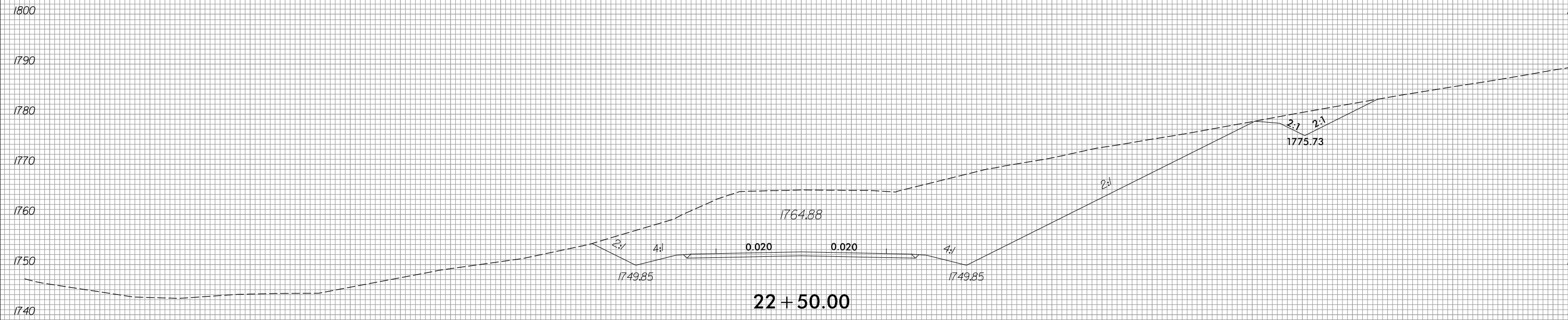

150 140 130 120 110 100 90 80 70 60 50 40 30 20 10 0 10 20 30 40 50 60 70 80 90 100 110 120 130 140 150



150 140 130 120 110 100 90 80 70 60 50 40 30 20 10 0 10 20 30 40 50 60 70 80 90 100 110 120 130 140 150

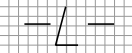
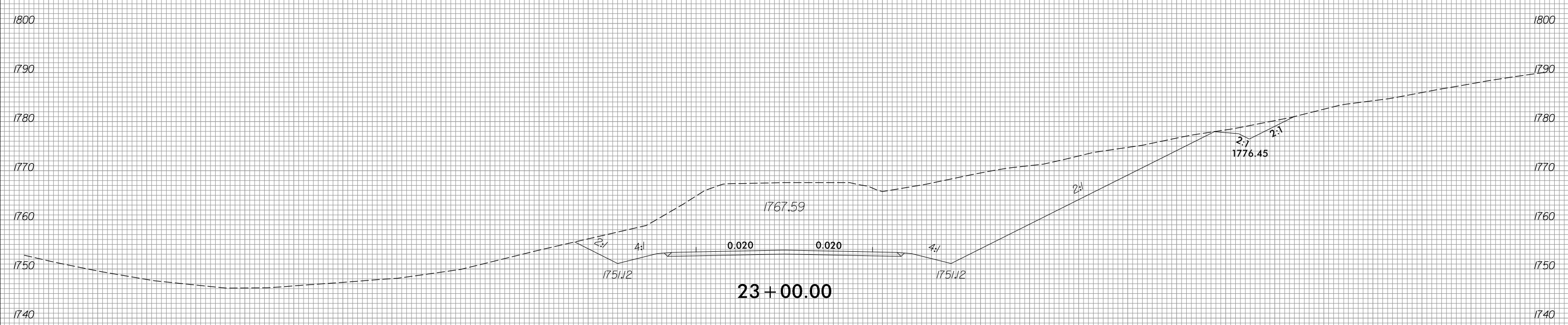
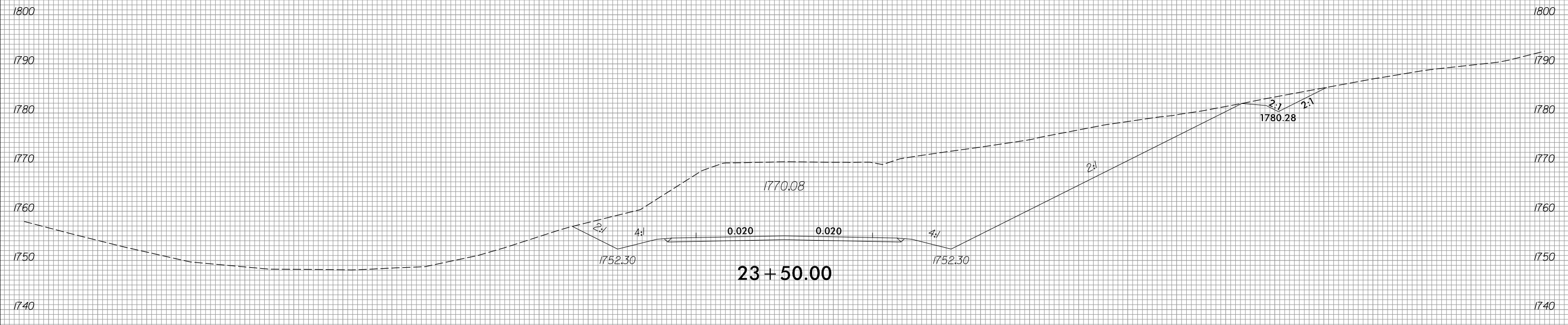

150 140 130 120 110 100 90 80 70 60 50 40 30 20 10 0 10 20 30 40 50 60 70 80 90 100 110 120 130 140 150

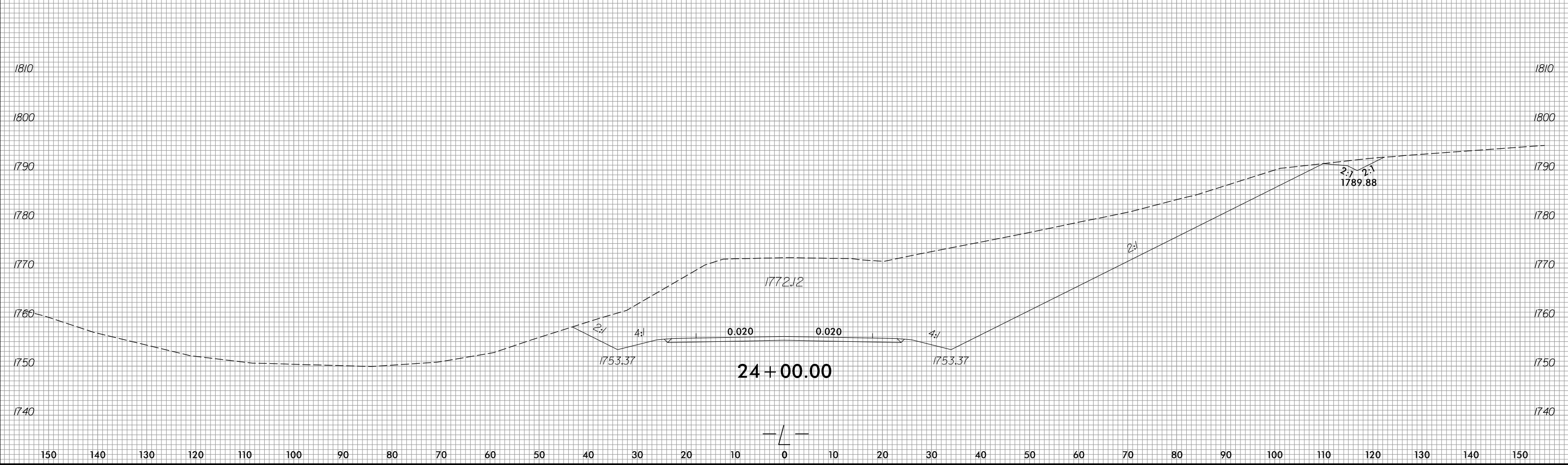
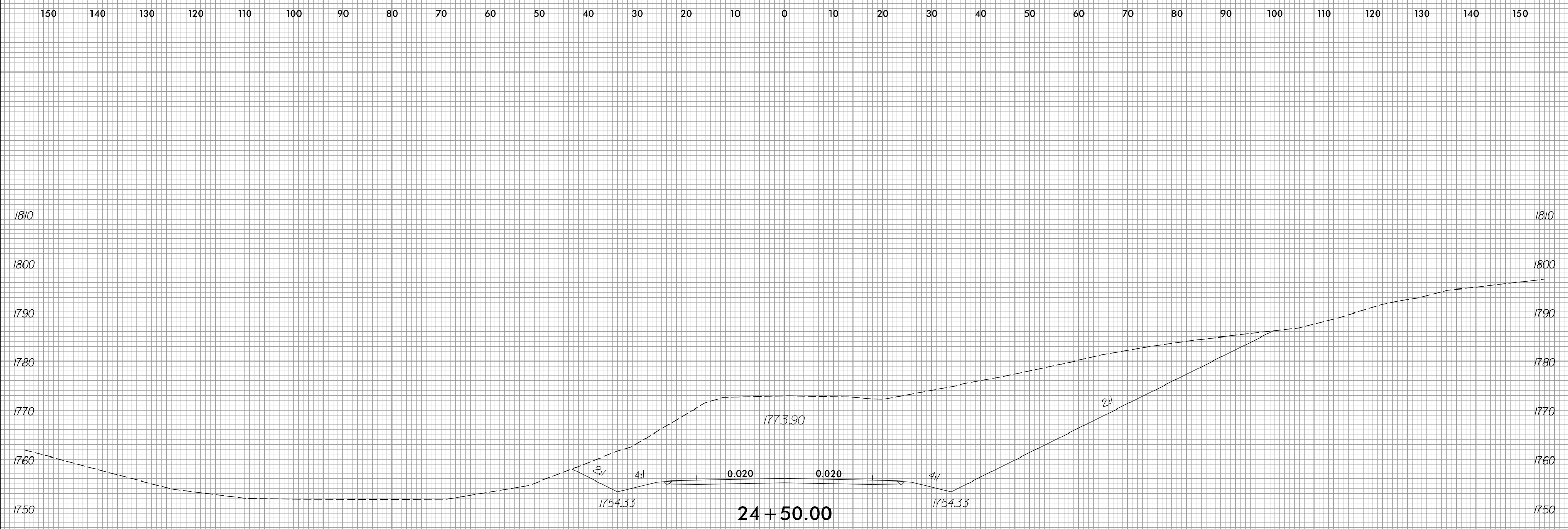
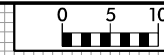



150 140 130 120 110 100 90 80 70 60 50 40 30 20 10 0 10 20 30 40 50 60 70 80 90 100 110 120 130 140 150

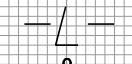
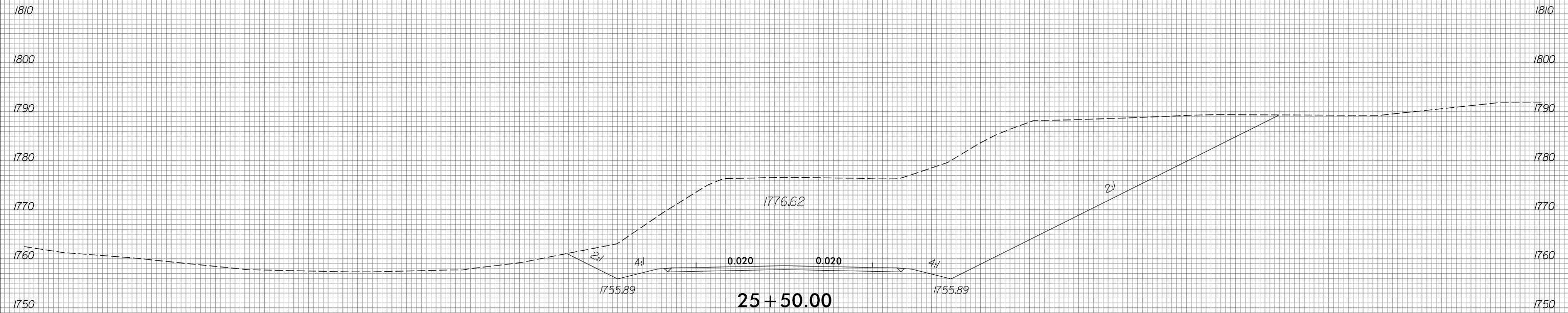

150 140 130 120 110 100 90 80 70 60 50 40 30 20 10 0 10 20 30 40 50 60 70 80 90 100 110 120 130 140 150



150 140 130 120 110 100 90 80 70 60 50 40 30 20 10 0 10 20 30 40 50 60 70 80 90 100 110 120 130 140 150

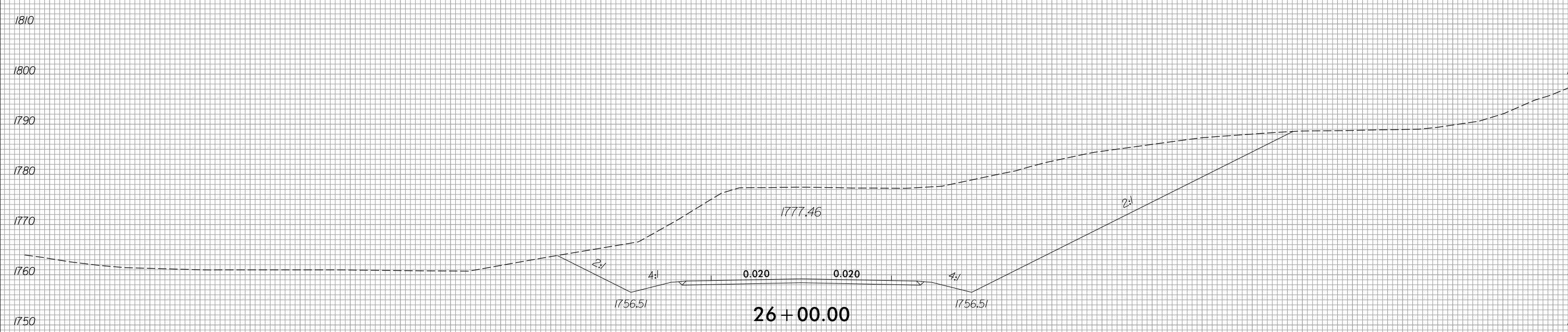
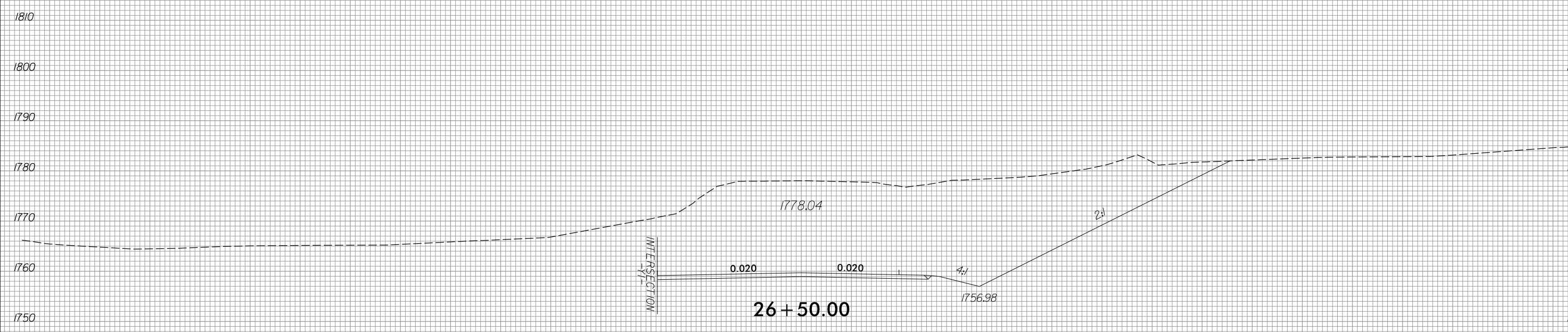

150 140 130 120 110 100 90 80 70 60 50 40 30 20 10 0 10 20 30 40 50 60 70 80 90 100 110 120 130 140 150

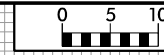

150 140 130 120 110 100 90 80 70 60 50 40 30 20 10 0 10 20 30 40 50 60 70 80 90 100 110 120 130 140 150

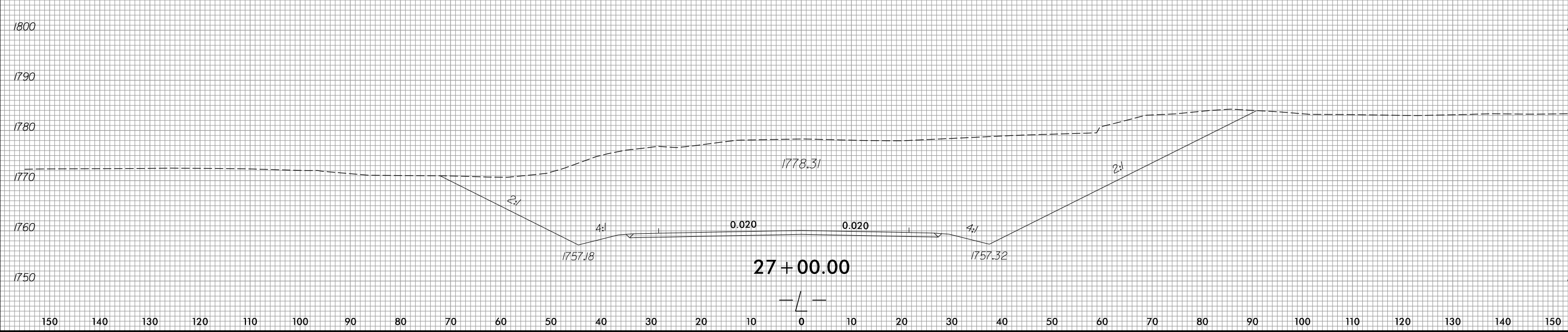
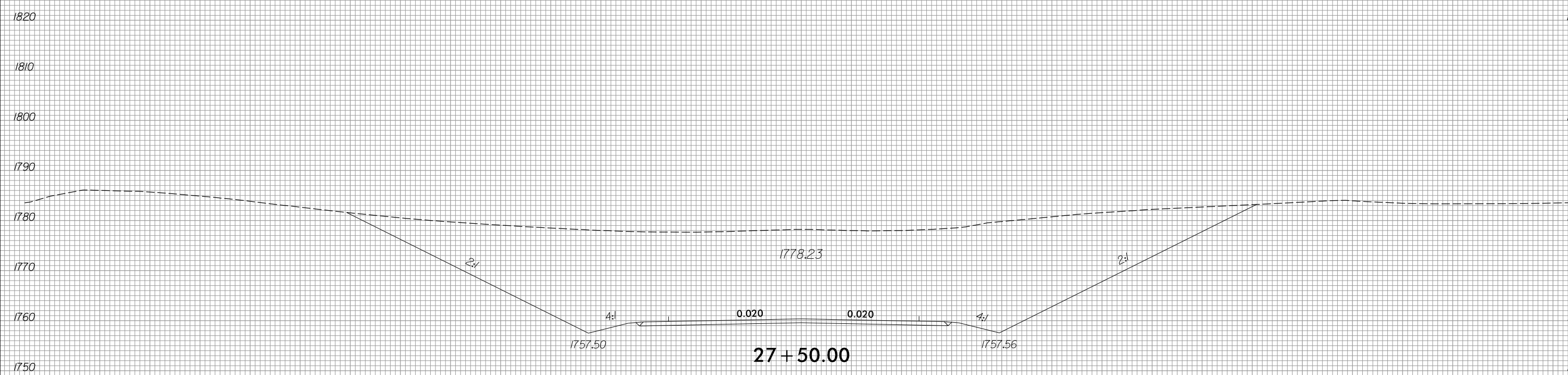

150 140 130 120 110 100 90 80 70 60 50 40 30 20 10 0 10 20 30 40 50 60 70 80 90 100 110 120 130 140 150



150 140 130 120 110 100 90 80 70 60 50 40 30 20 10 0 10 20 30 40 50 60 70 80 90 100 110 120 130 140 150

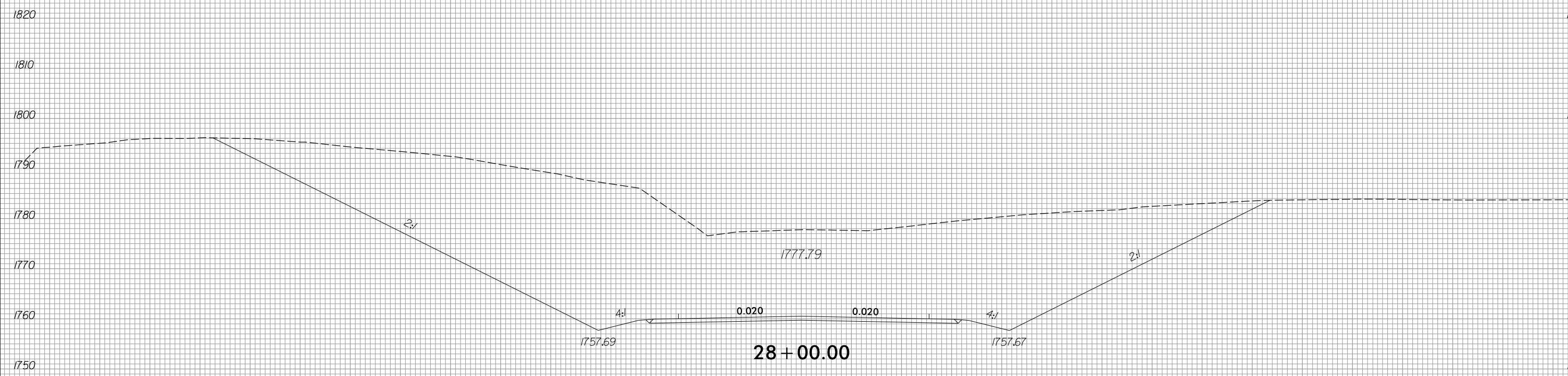

150 140 130 120 110 100 90 80 70 60 50 40 30 20 10 0 10 20 30 40 50 60 70 80 90 100 110 120 130 140 150



150 140 130 120 110 100 90 80 70 60 50 40 30 20 10 0 10 20 30 40 50 60 70 80 90 100 110 120 130 140 150

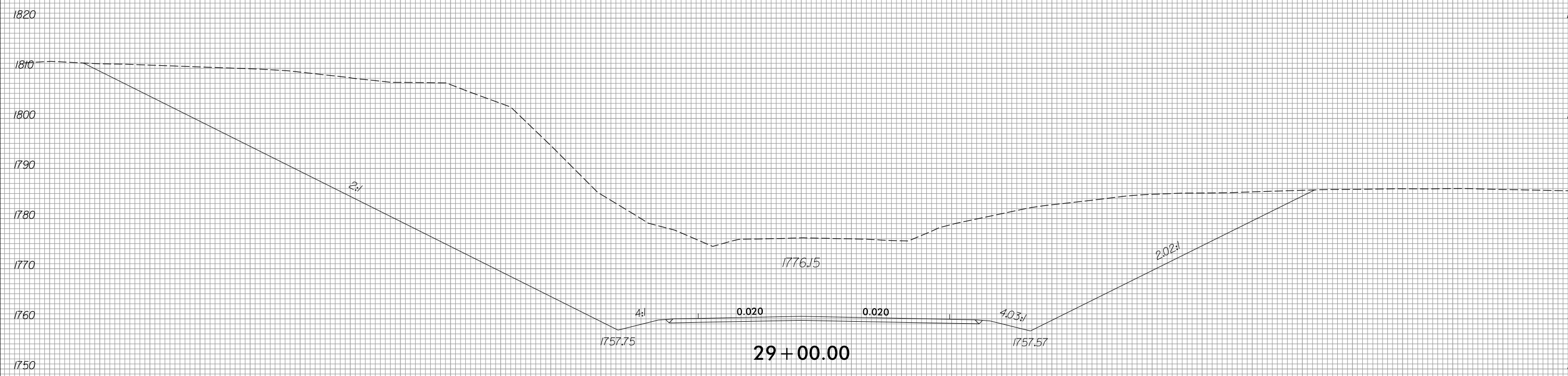

150 140 130 120 110 100 90 80 70 60 50 40 30 20 10 0 10 20 30 40 50 60 70 80 90 100 110 120 130 140 150

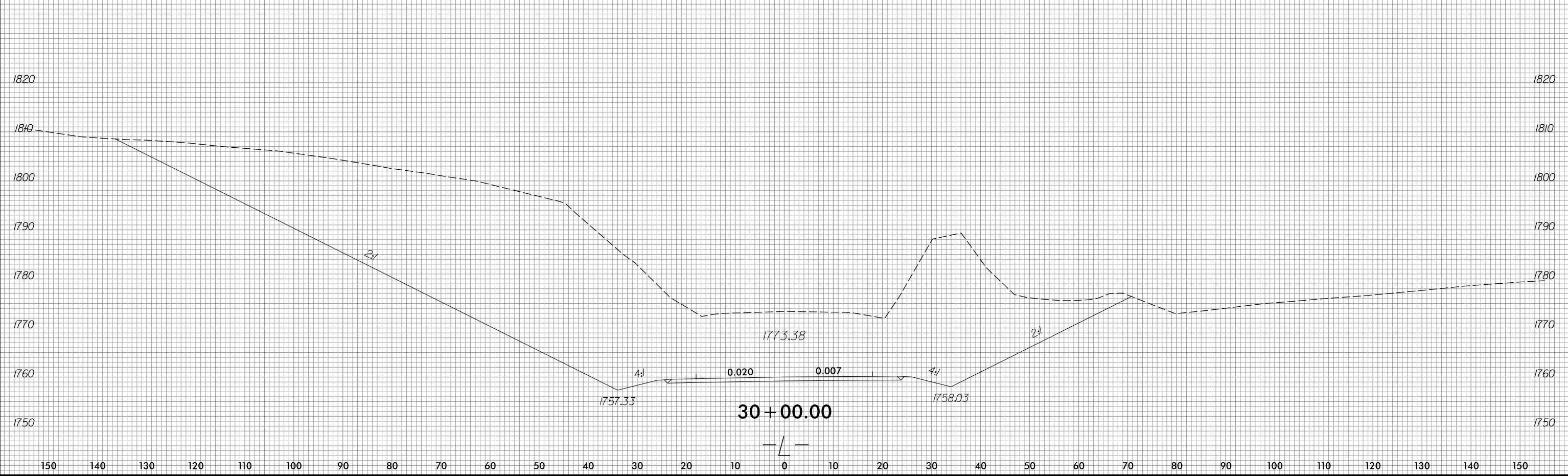
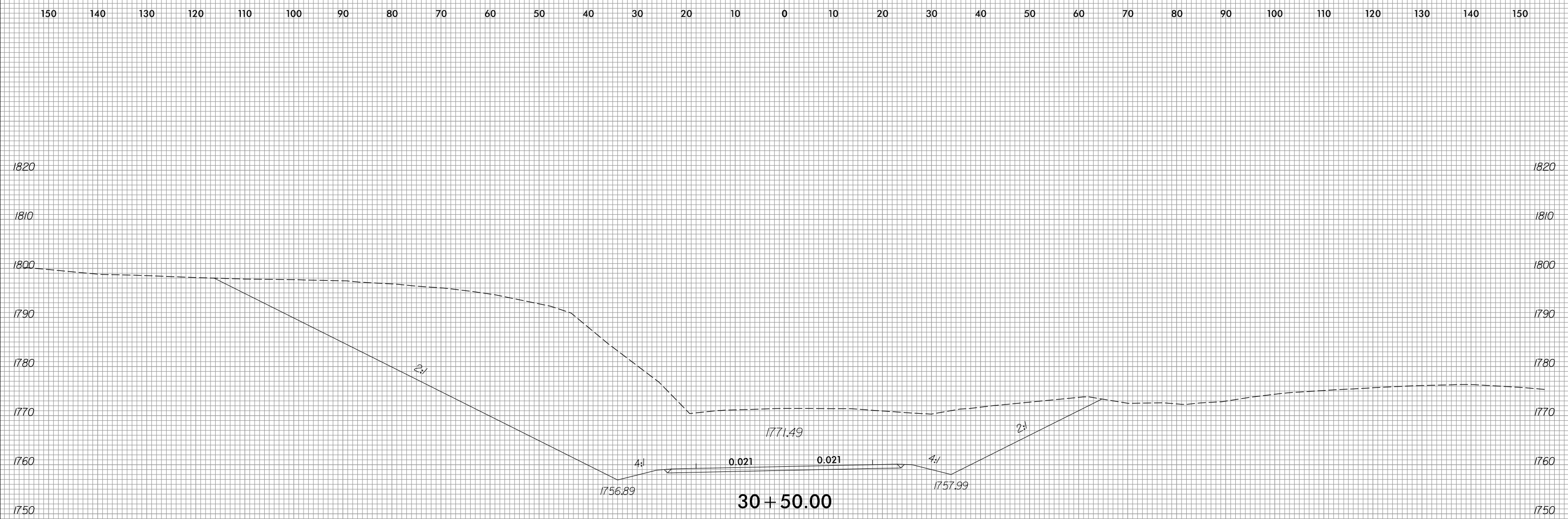



150 140 130 120 110 100 90 80 70 60 50 40 30 20 10 0 10 20 30 40 50 60 70 80 90 100 110 120 130 140 150

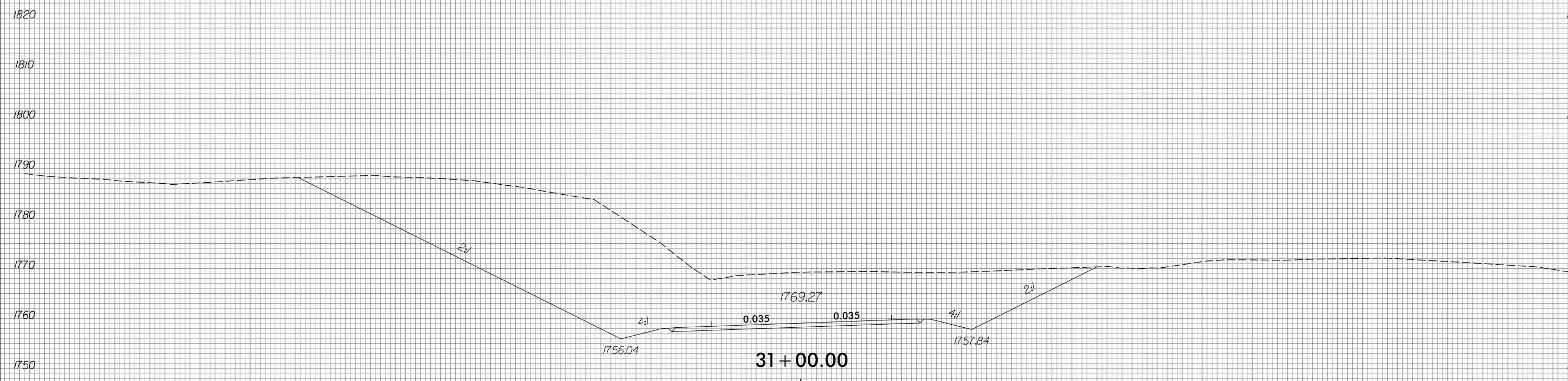
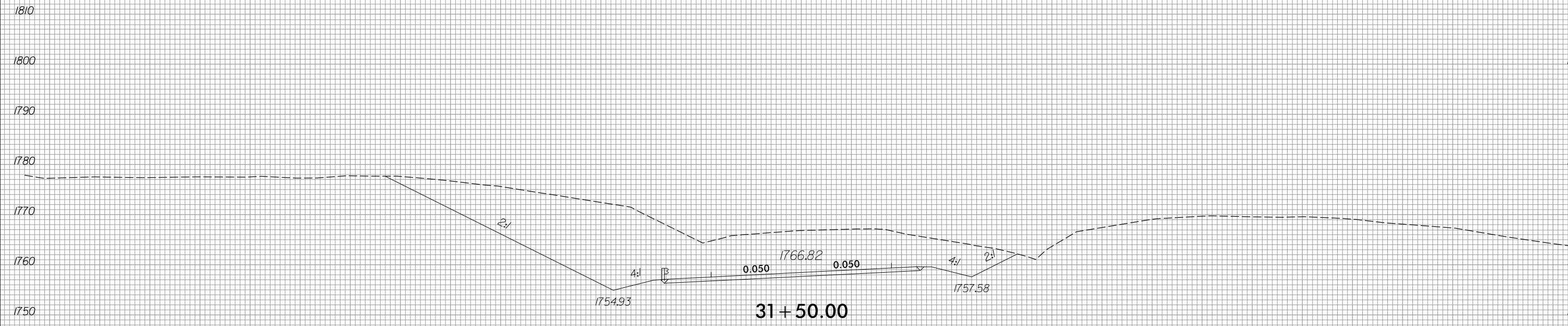

150 140 130 120 110 100 90 80 70 60 50 40 30 20 10 0 10 20 30 40 50 60 70 80 90 100 110 120 130 140 150



150 140 130 120 110 100 90 80 70 60 50 40 30 20 10 0 10 20 30 40 50 60 70 80 90 100 110 120 130 140 150

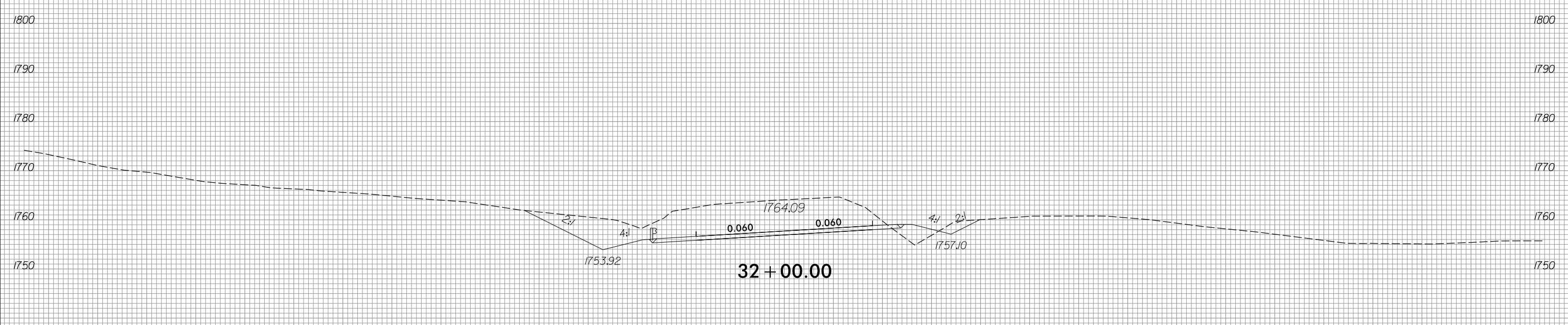
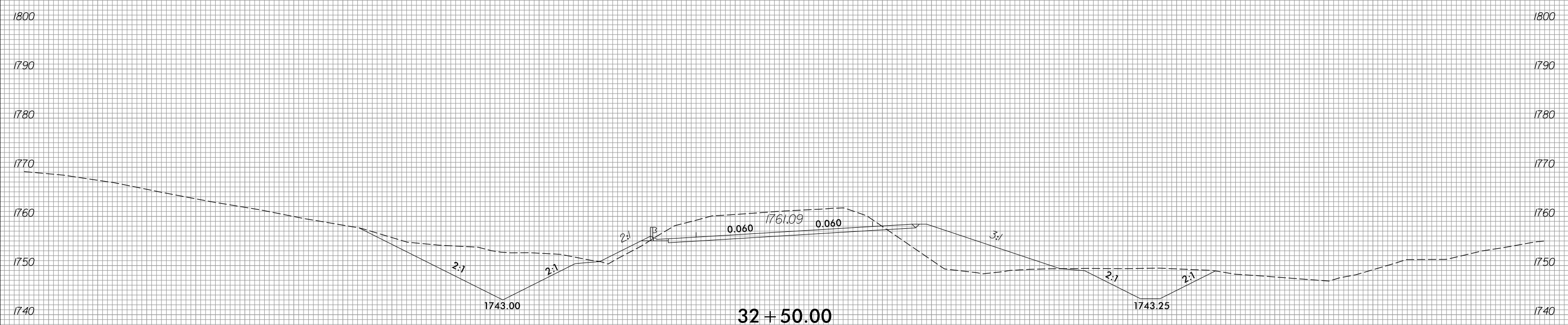

150 140 130 120 110 100 90 80 70 60 50 40 30 20 10 0 10 20 30 40 50 60 70 80 90 100 110 120 130 140 150



150 140 130 120 110 100 90 80 70 60 50 40 30 20 10 0 10 20 30 40 50 60 70 80 90 100 110 120 130 140 150

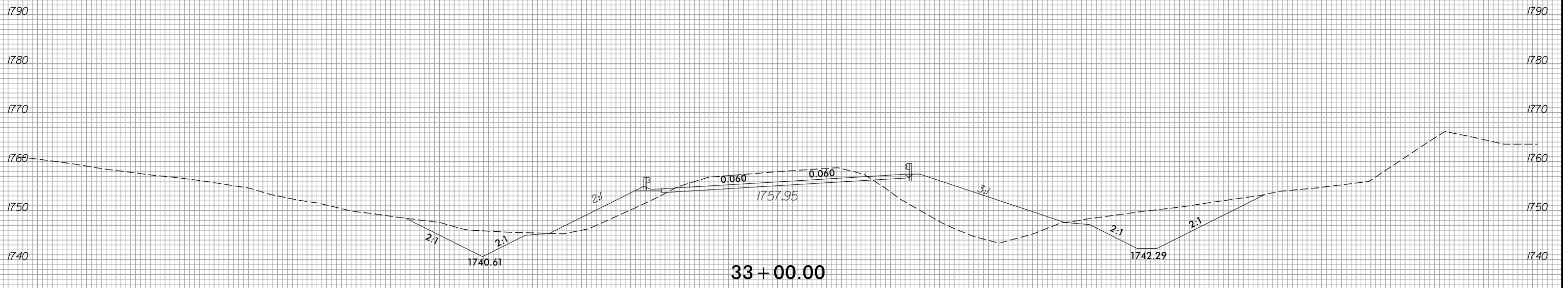
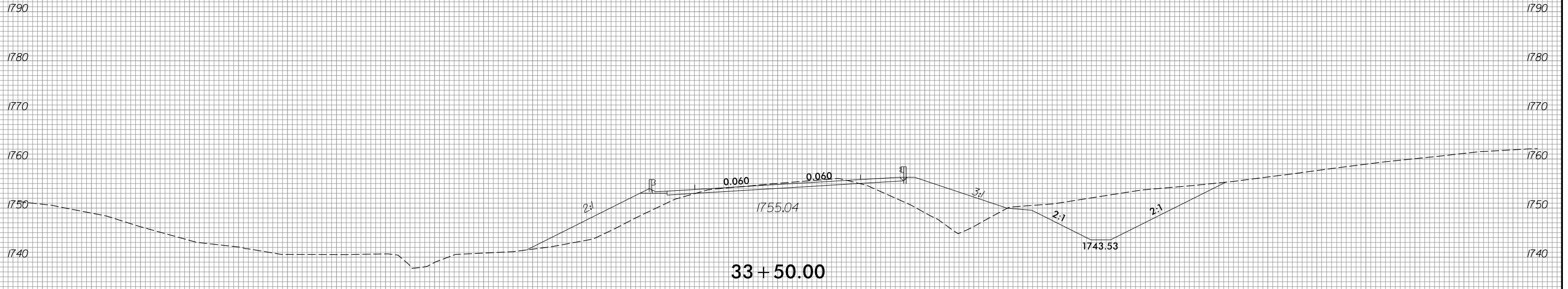



150 140 130 120 110 100 90 80 70 60 50 40 30 20 10 0 10 20 30 40 50 60 70 80 90 100 110 120 130 140 150

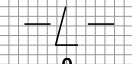
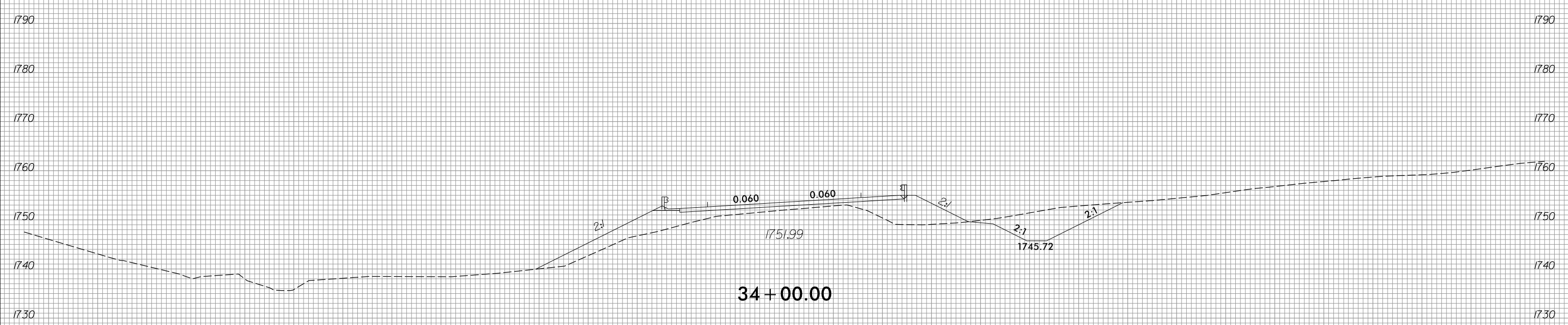
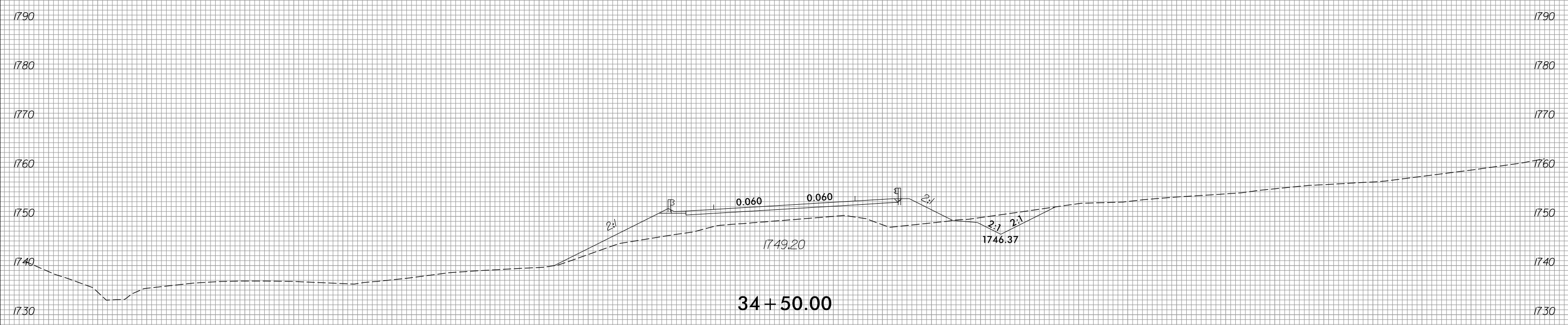

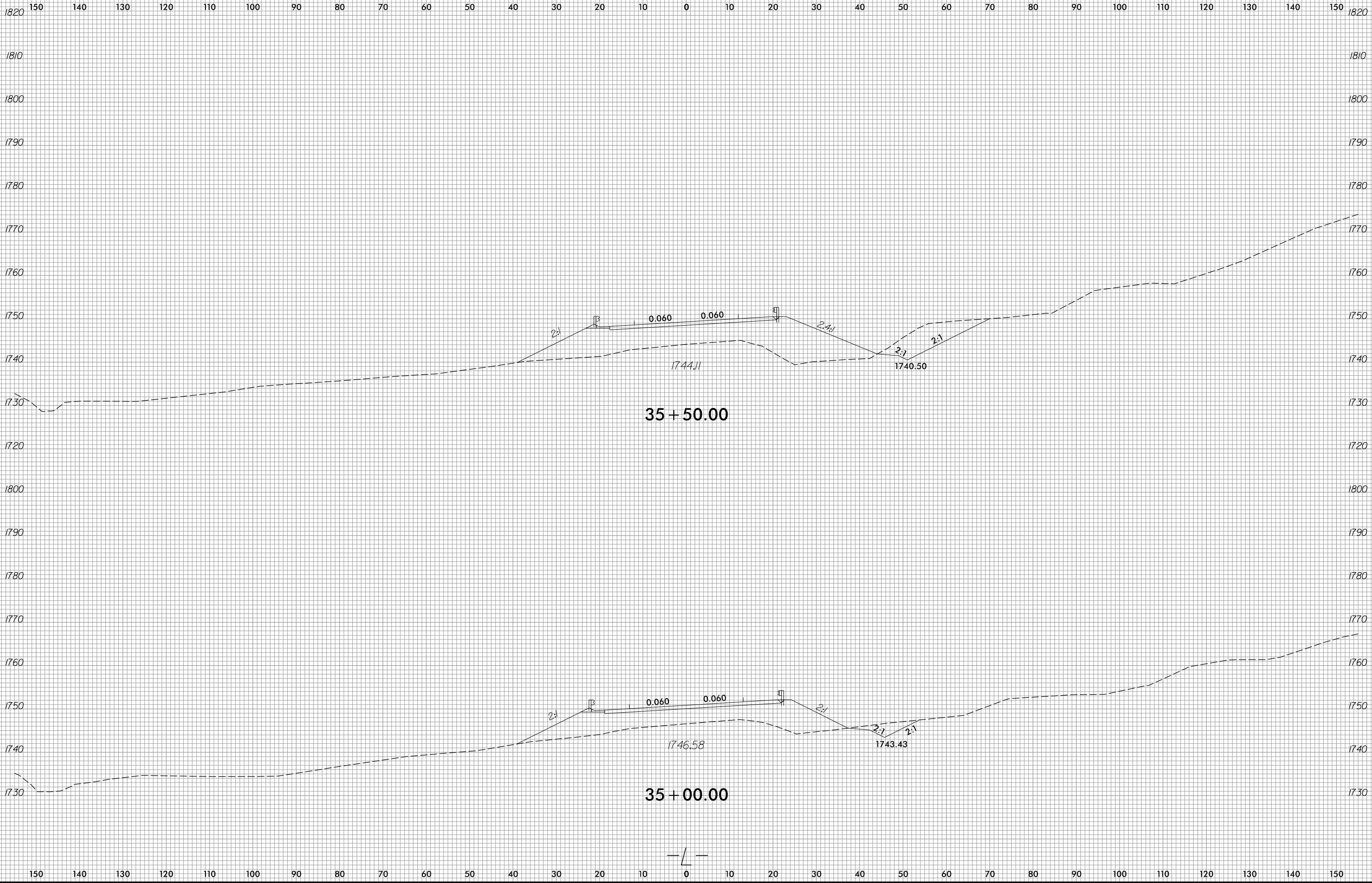

35 + 50.00

35 + 00.00





150 140 130 120 110 100 90 80 70 60 50 40 30 20 10 0 10 20 30 40 50 60 70 80 90 100 110 120 130 140 150

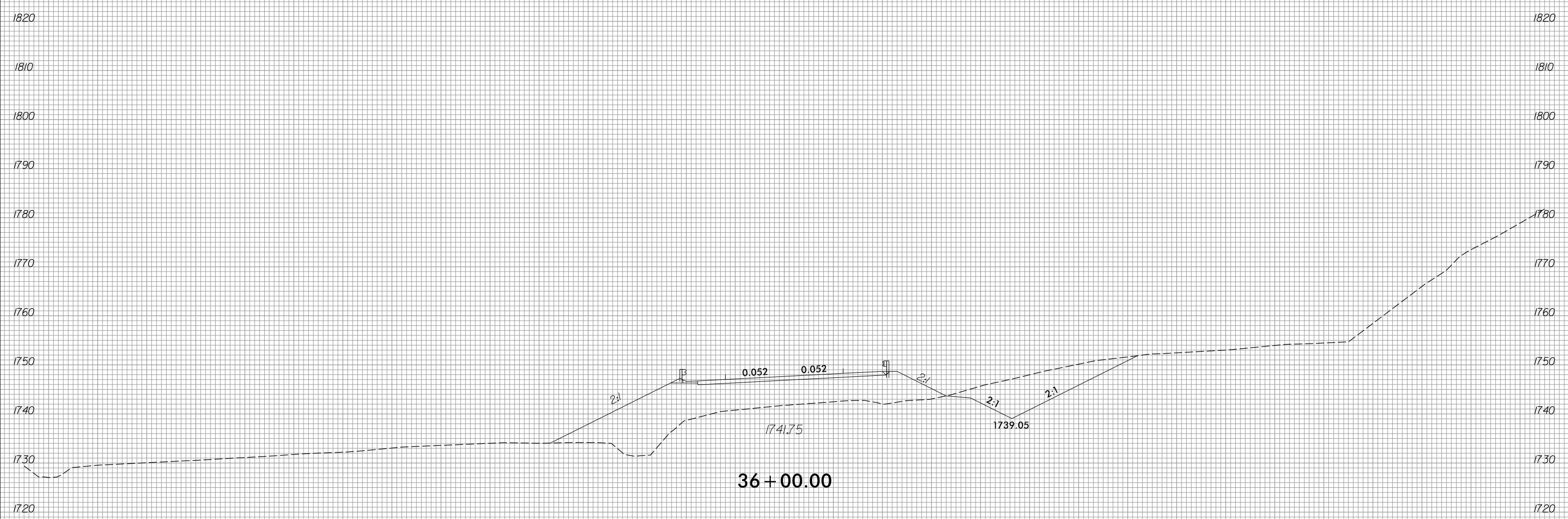

150 140 130 120 110 100 90 80 70 60 50 40 30 20 10 0 10 20 30 40 50 60 70 80 90 100 110 120 130 140 150



150 140 130 120 110 100 90 80 70 60 50 40 30 20 10 0 10 20 30 40 50 60 70 80 90 100 110 120 130 140 150

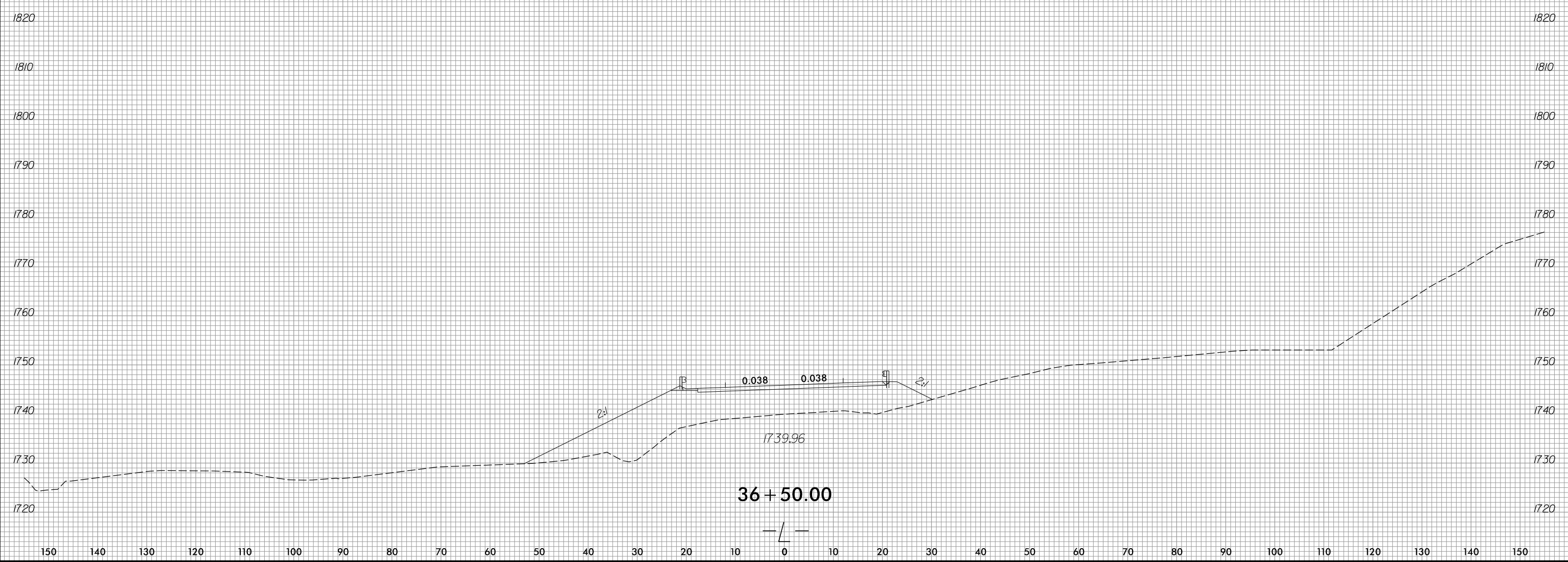

150 140 130 120 110 100 90 80 70 60 50 40 30 20 10 0 10 20 30 40 50 60 70 80 90 100 110 120 130 140 150

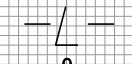
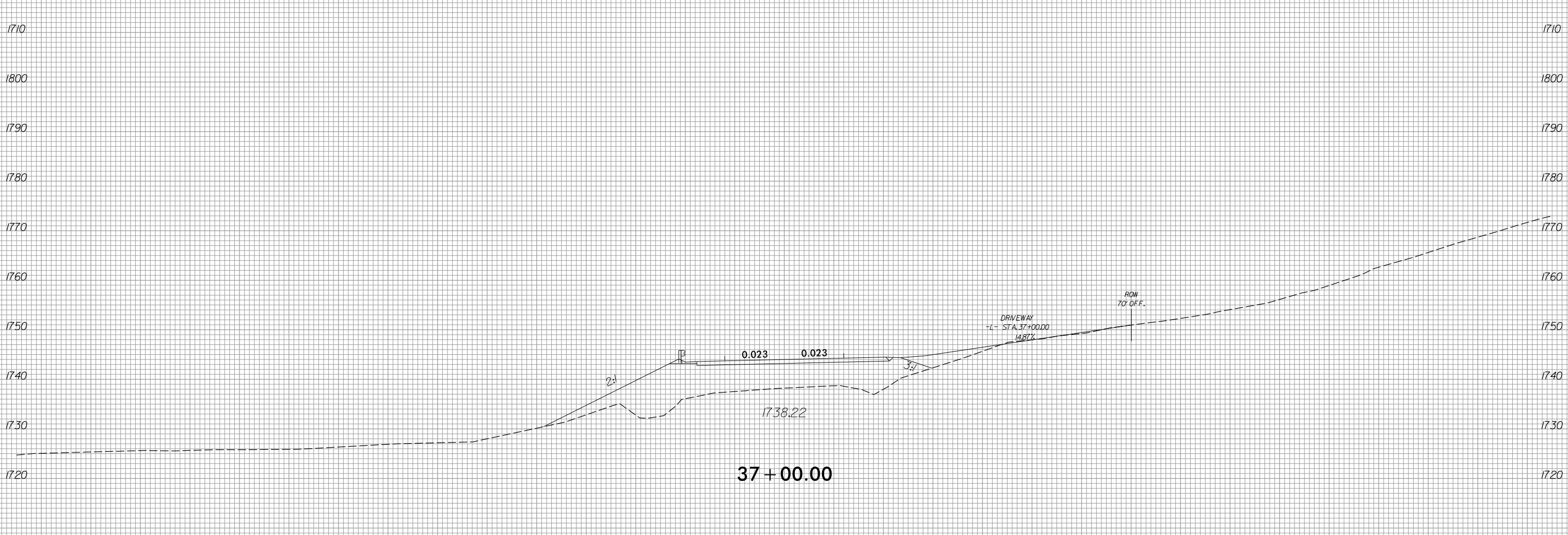
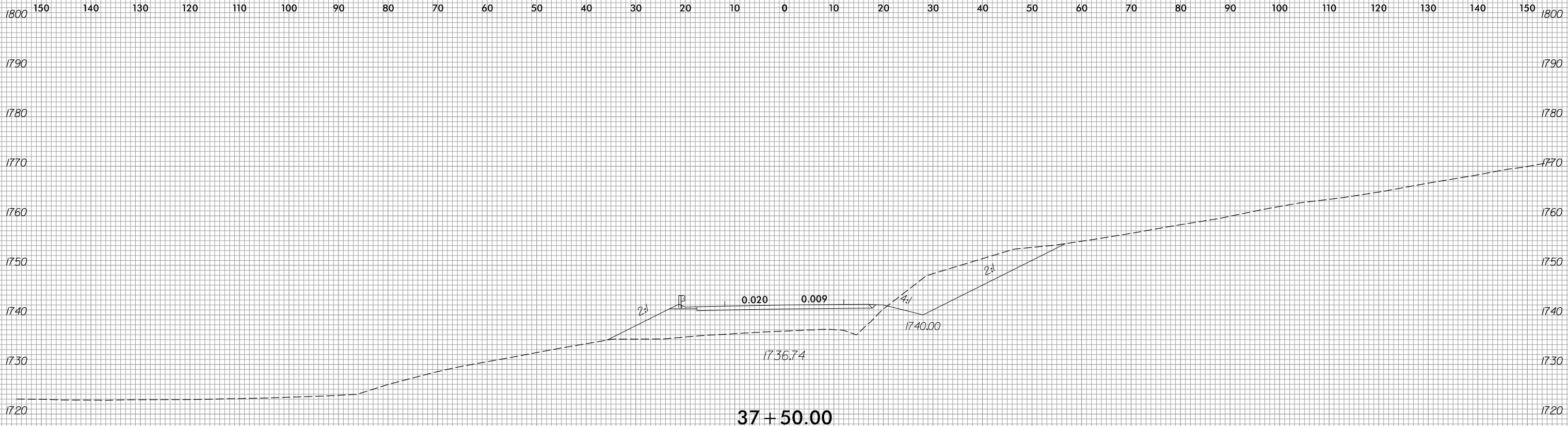



150 140 130 120 110 100 90 80 70 60 50 40 30 20 10 0 10 20 30 40 50 60 70 80 90 100 110 120 130 140 150

1780 1780

1770 1770

1760 1760

1750 1750

1740 1740

1730 1730

1720 1720

1790 1790

1780 1780

1770 1770

1760 1760

1750 1750

1740 1740

1730 1730

1720 1720

1710 1710

150 140 130 120 110 100 90 80 70 60 50 40 30 20 10 0 10 20 30 40 50 60 70 80 90 100 110 120 130 140 150

INTERSECTION
DPS

0.020 0.020

4:1 2:1

1736.00

1734.23

38 + 50.00

2:1

0.020 0.005

4:1

1737.83

1735.39

38 + 00.00

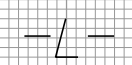

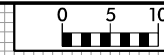

150 140 130 120 110 100 90 80 70 60 50 40 30 20 10 0 10 20 30 40 50 60 70 80 90 100 110 120 130 140 150

1770 1770

1760 1760

1750 1750

1740 1740

1730 1730

1720 1720

1710 1710

1700 1700

1770 1770

1760 1760

1750 1750

1740 1740

1730 1730

1720 1720

1710 1710

1770 1770

1760 1760

1750 1750

1740 1740

1730 1730

1720 1720

1710 1710

150 140 130 120 110 100 90 80 70 60 50 40 30 20 10 0 10 20 30 40 50 60 70 80 90 100 110 120 130 140 150

39 + 50.00

39 + 00.00

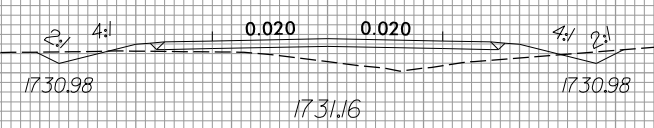

1730.98

1731.16

1730.98

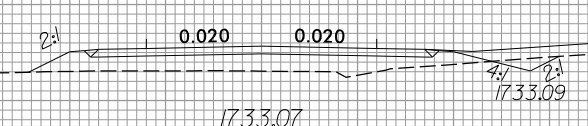

1733.07

1733.09

DRIVEWAY
L STA 39+20.00
6.75%

ROW
70' OFF.

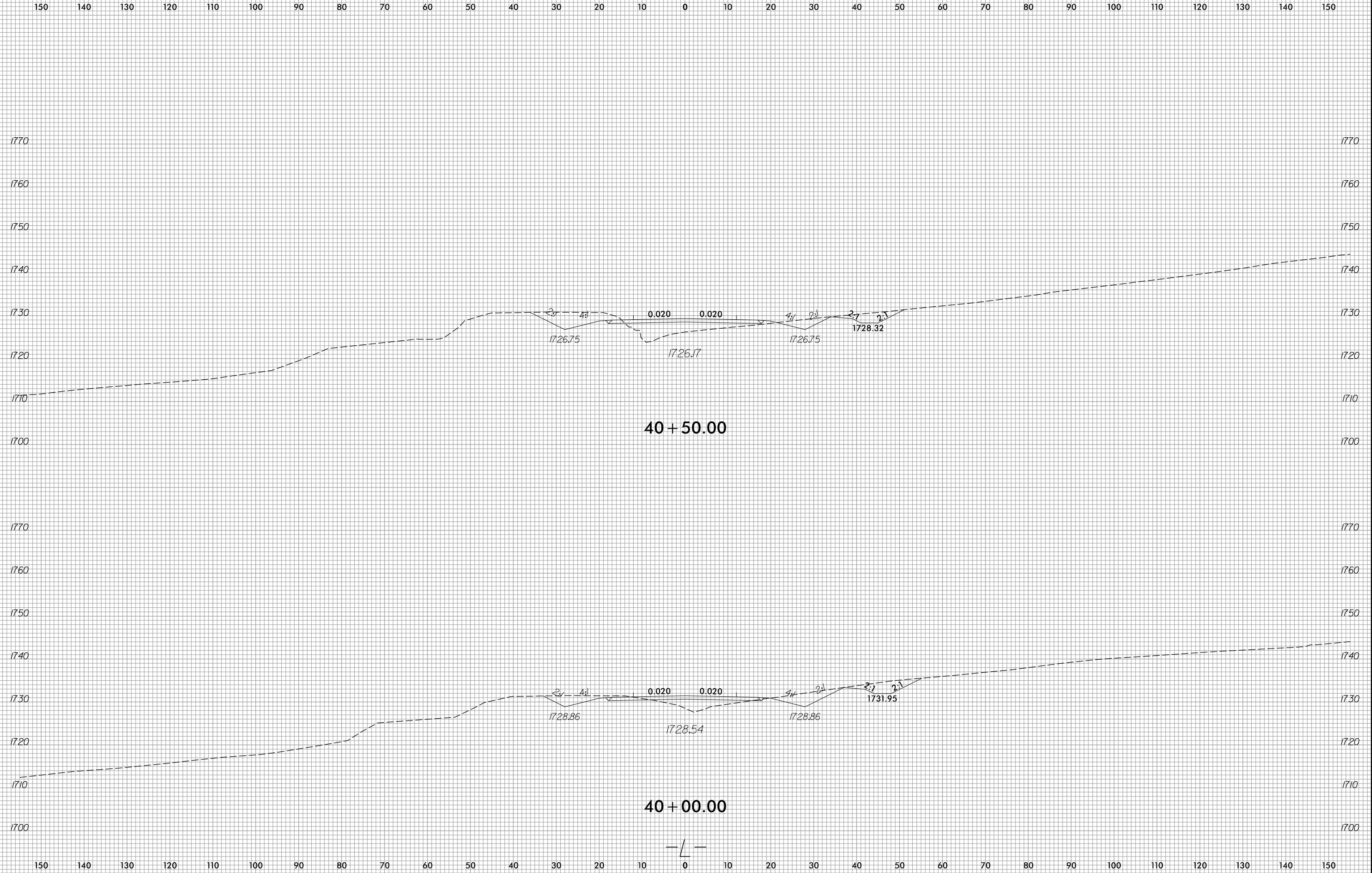



150 140 130 120 110 100 90 80 70 60 50 40 30 20 10 0 10 20 30 40 50 60 70 80 90 100 110 120 130 140 150

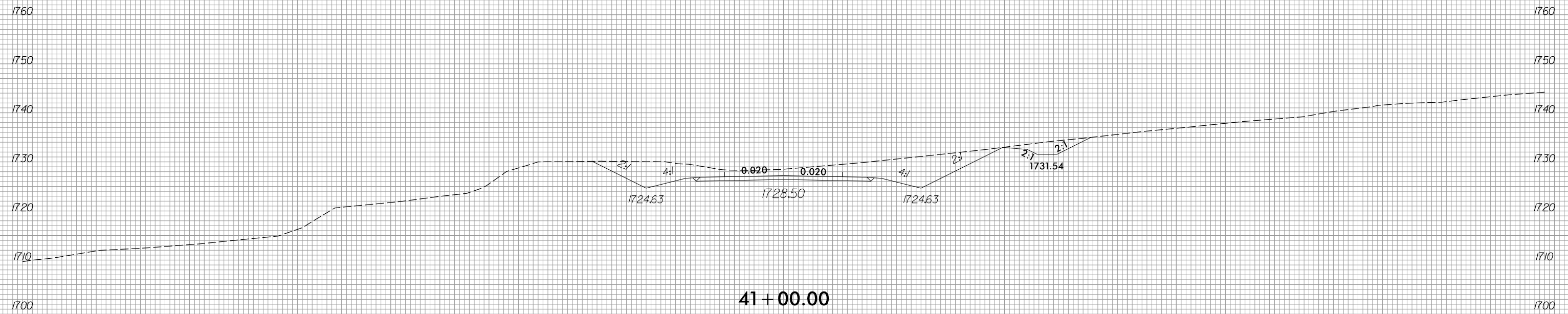
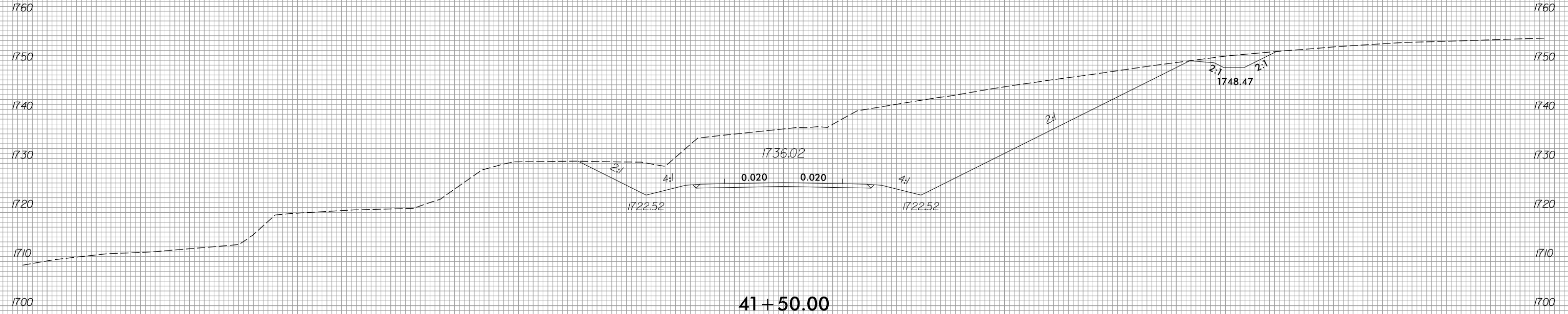

150 140 130 120 110 100 90 80 70 60 50 40 30 20 10 0 10 20 30 40 50 60 70 80 90 100 110 120 130 140 150

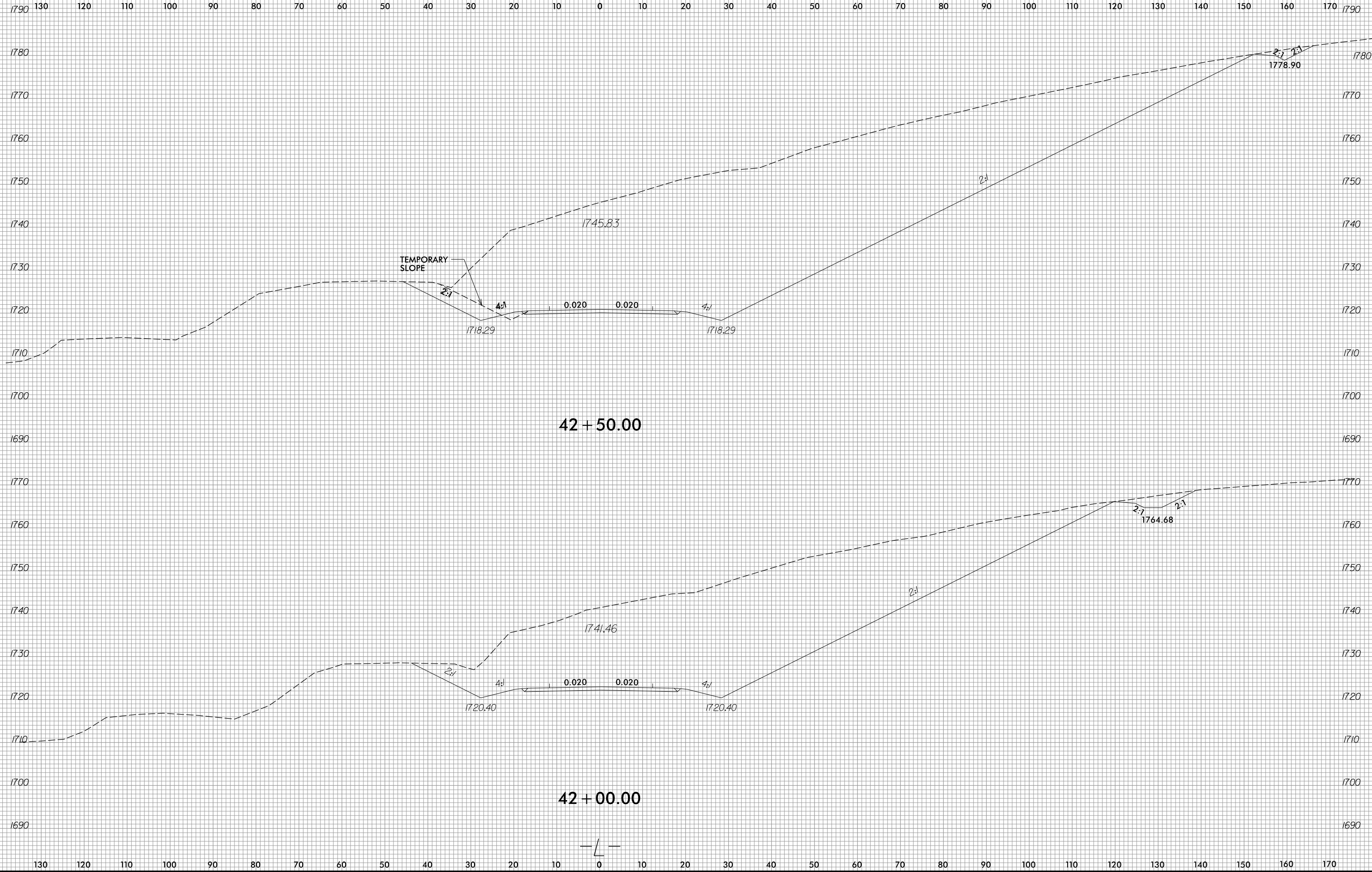
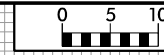

6/23/16



PROJ. REFERENCE NO.
R-5861

SHEET NO.
X-33

100 90 80 70 60 50 40 30 20 10 0 10 20 30 40 50 60 70 80 90 100 110 120 130 140 150 160 170 180 190 200

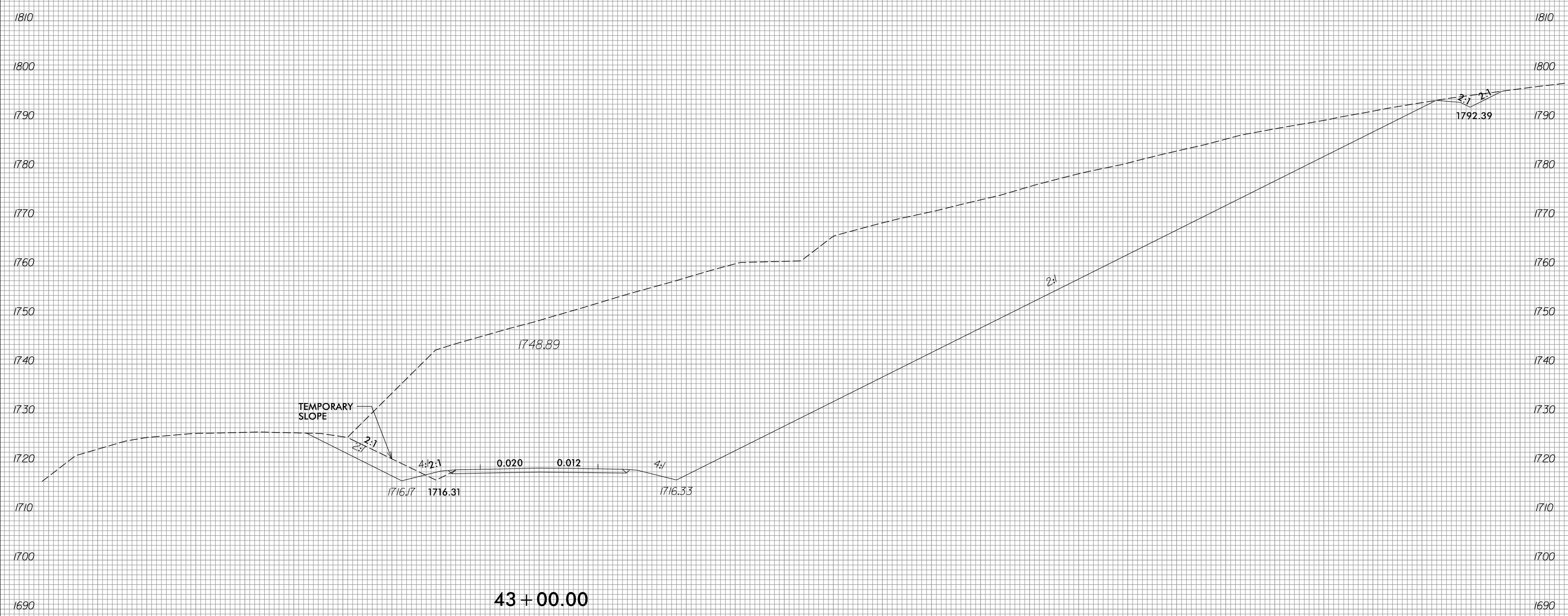

43 + 00.00

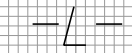

100 90 80 70 60 50 40 30 20 10 0 10 20 30 40 50 60 70 80 90 100 110 120 130 140 150 160 170 180 190 200

8/3/2023
R:\Roadway\XSC\XPLs\15861_Rd\XPL_L.dgn
P:\mason



80 70 60 50 40 30 20 10 0 10 20 30 40 50 60 70 80 90 100 110 120 130 140 150 160 170 180 190 200 210 220

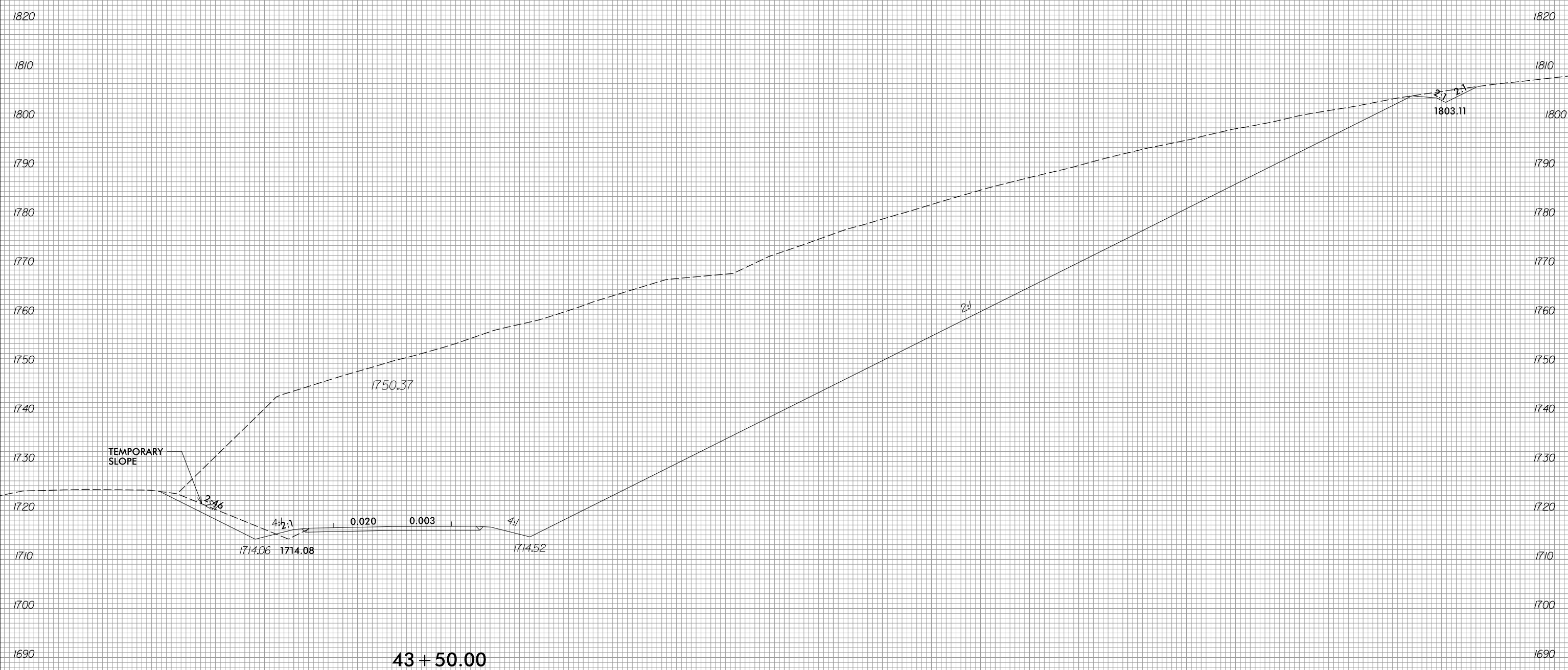

80 70 60 50 40 30 20 10 0 10 20 30 40 50 60 70 80 90 100 110 120 130 140 150 160 170 180 190 200 210 220

8/3/2023
R:\Roadway\XSC\XPLs\15861_Rdj_XPL_L.dgn
P:\mason

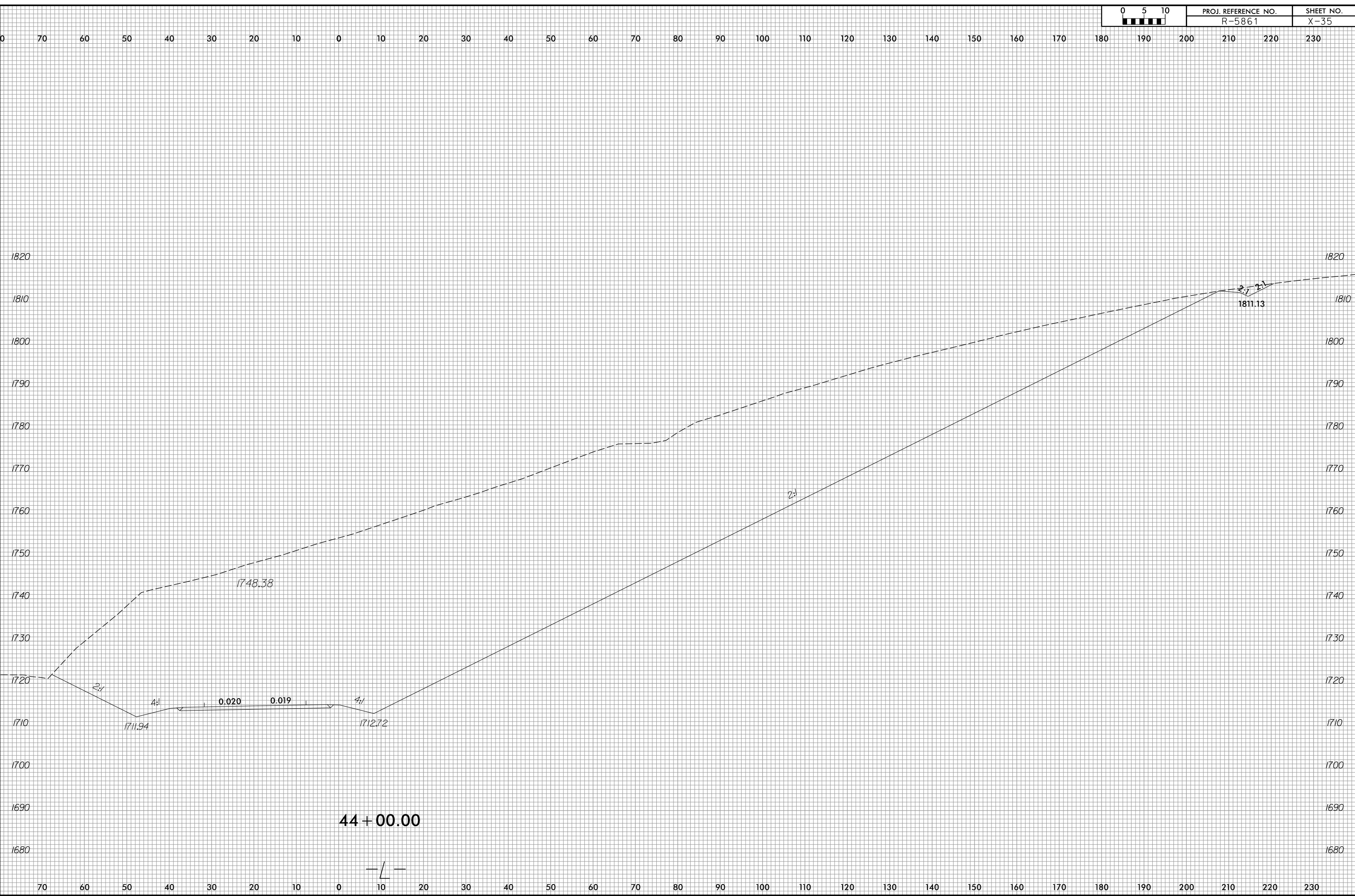

44 + 00.00

6/23/16

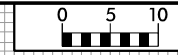

PROJ. REFERENCE NO. R-5861

SHEET NO. X-36

60 50 40 30 20 10 0 10 20 30 40 50 60 70 80 90 100 110 120 130 140 150 160 170 180 190 200 210 220 230 240

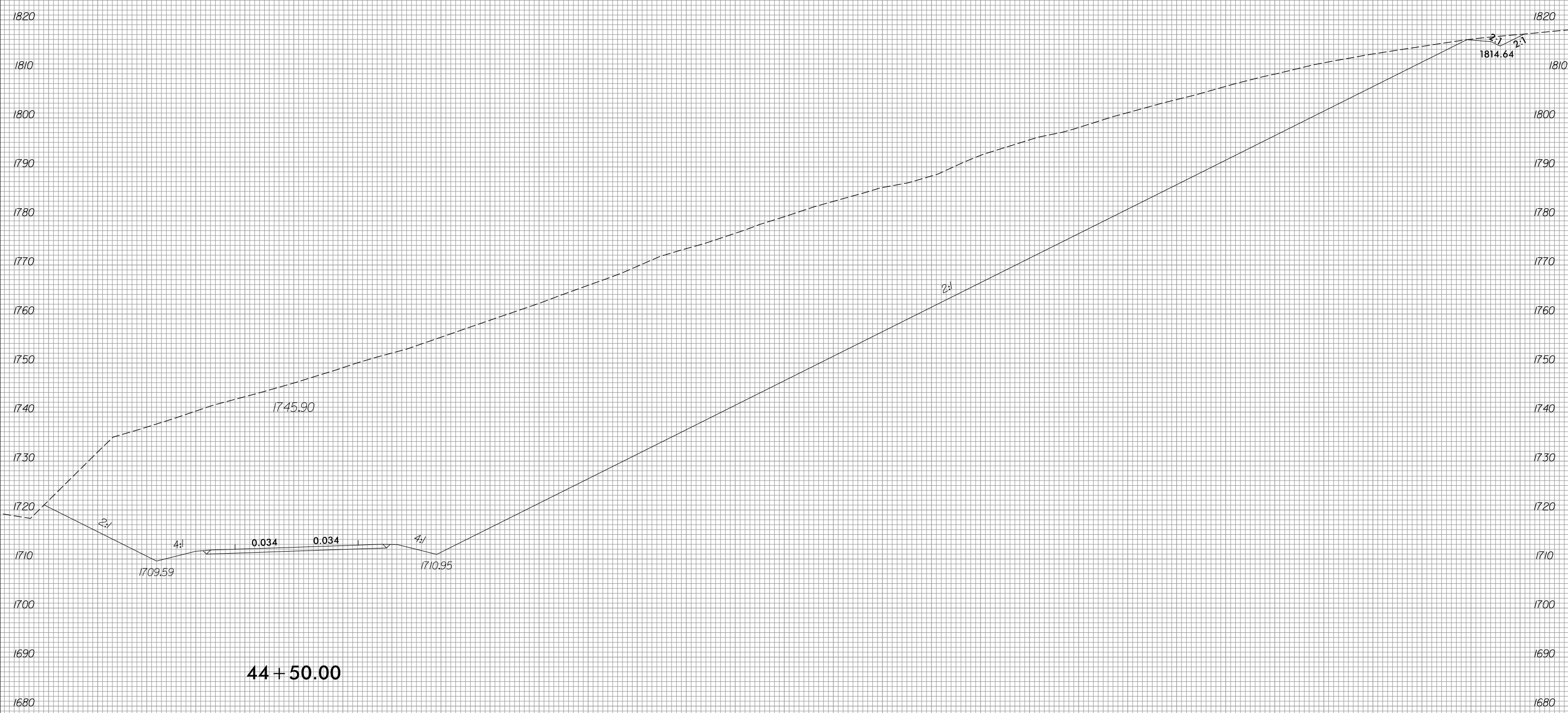

44 + 50.00

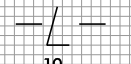

8/3/2023
R:\Roadway\XSC\XPLs\R5861_Rdj_XPL_L.dgn
rjason

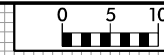

100 90 80 70 60 50 40 30 20 10 0 10 20 30 40 50 60 70 80 90 100 110 120 130 140 150 160 170 180 190 200

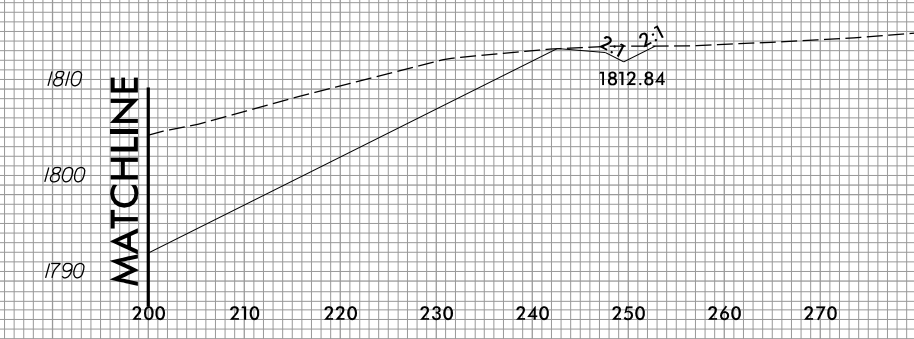
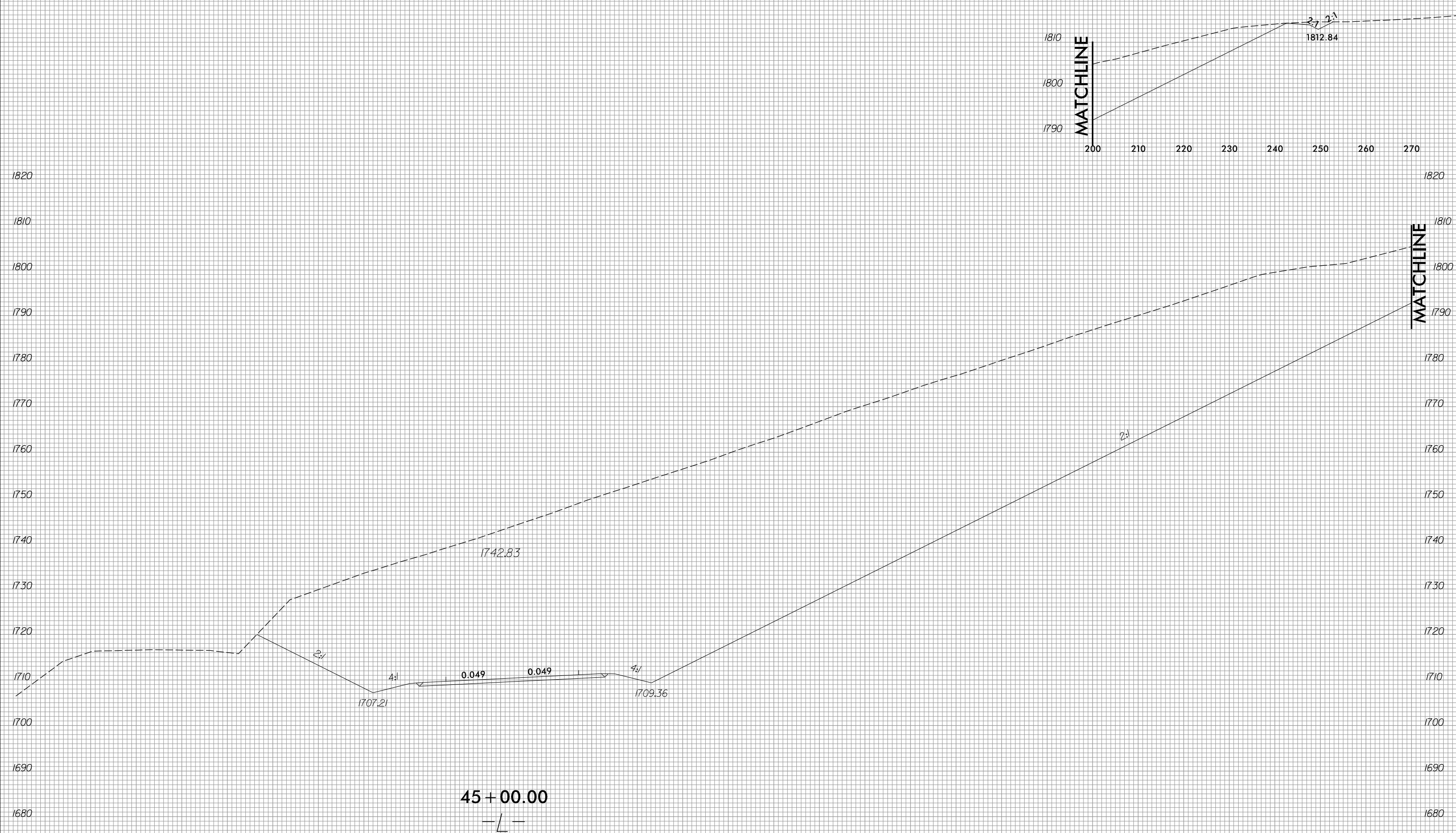

45 + 00.00
—L—



100 90 80 70 60 50 40 30 20 10 0 10 20 30 40 50 60 70 80 90 100 110 120 130 140 150 160 170 180 190 200

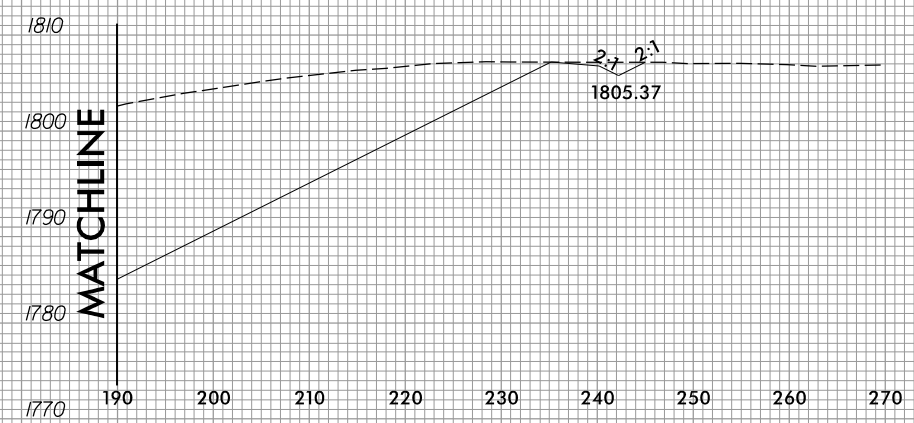



100 90 80 70 60 50 40 30 20 10 0 10 20 30 40 50 60 70 80 90 100 110 120 130 140 150 160 170 180 190 200

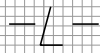
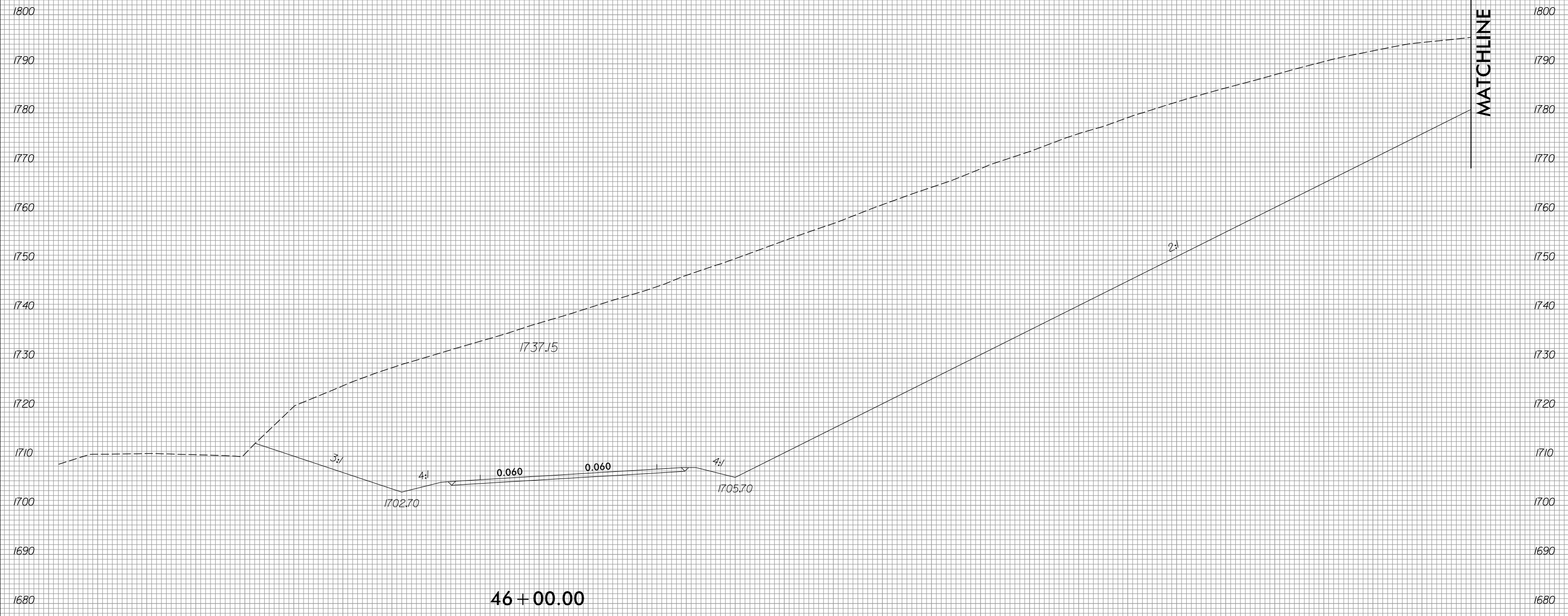
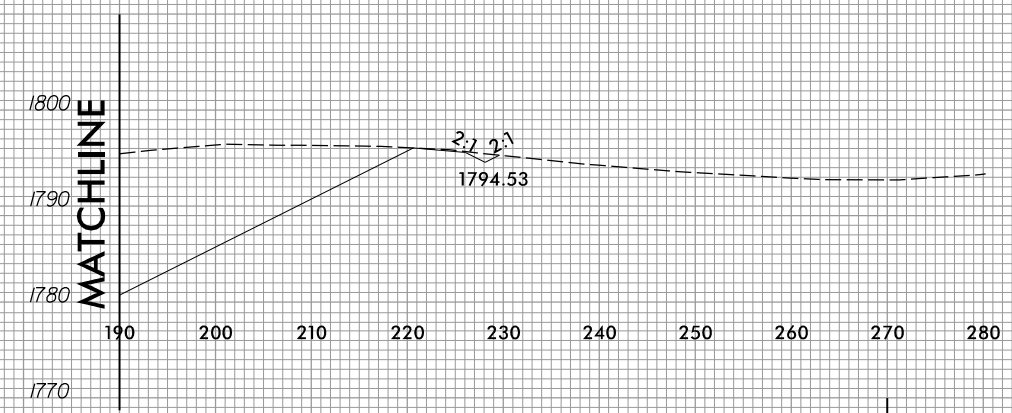



100 90 80 70 60 50 40 30 20 10 0 10 20 30 40 50 60 70 80 90 100 110 120 130 140 150 160 170 180 190 200

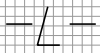
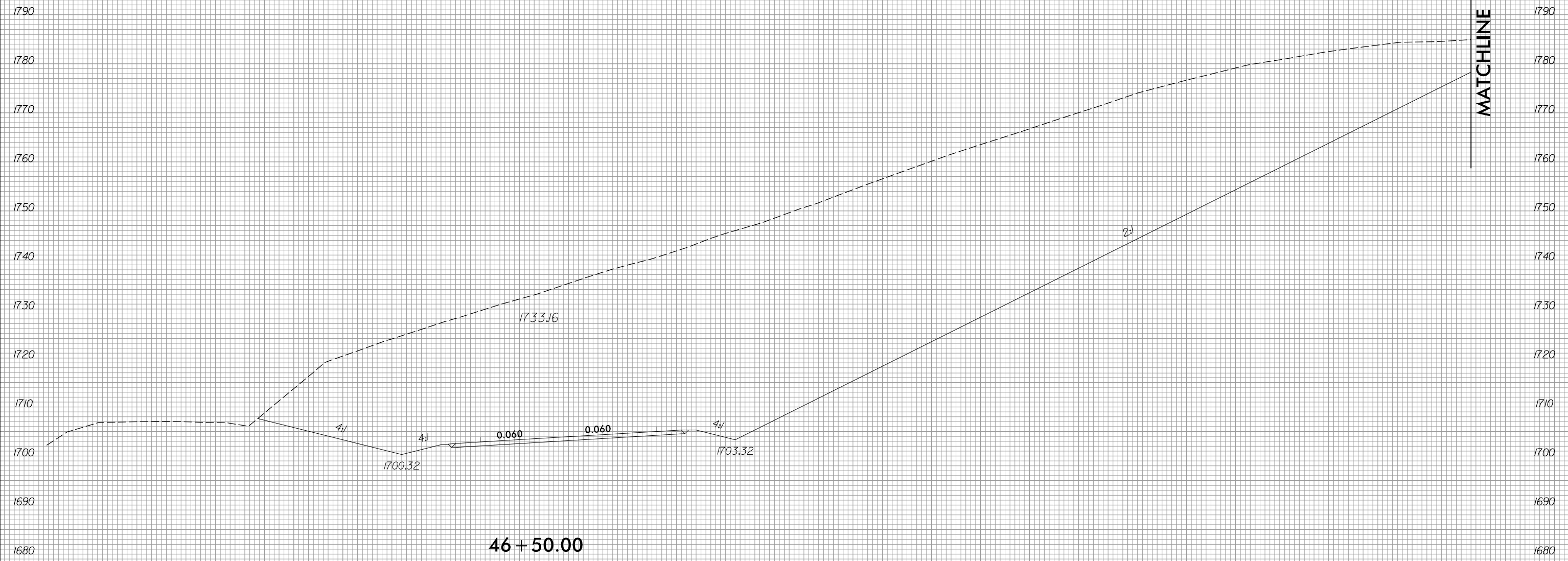
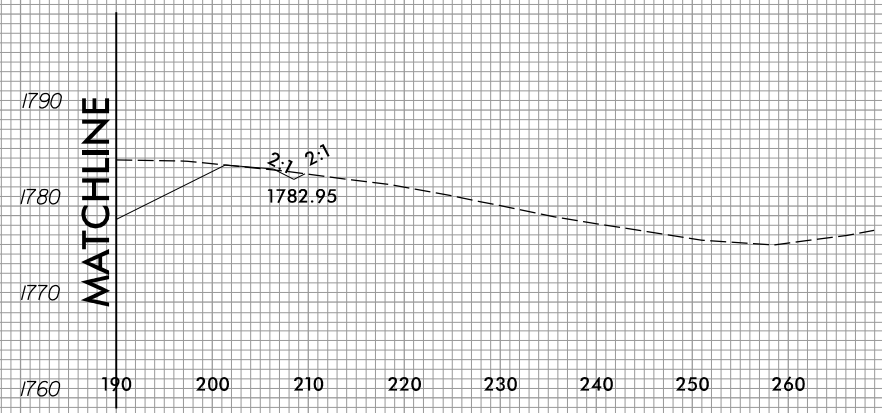



100 90 80 70 60 50 40 30 20 10 0 10 20 30 40 50 60 70 80 90 100 110 120 130 140 150 160 170 180 190 200

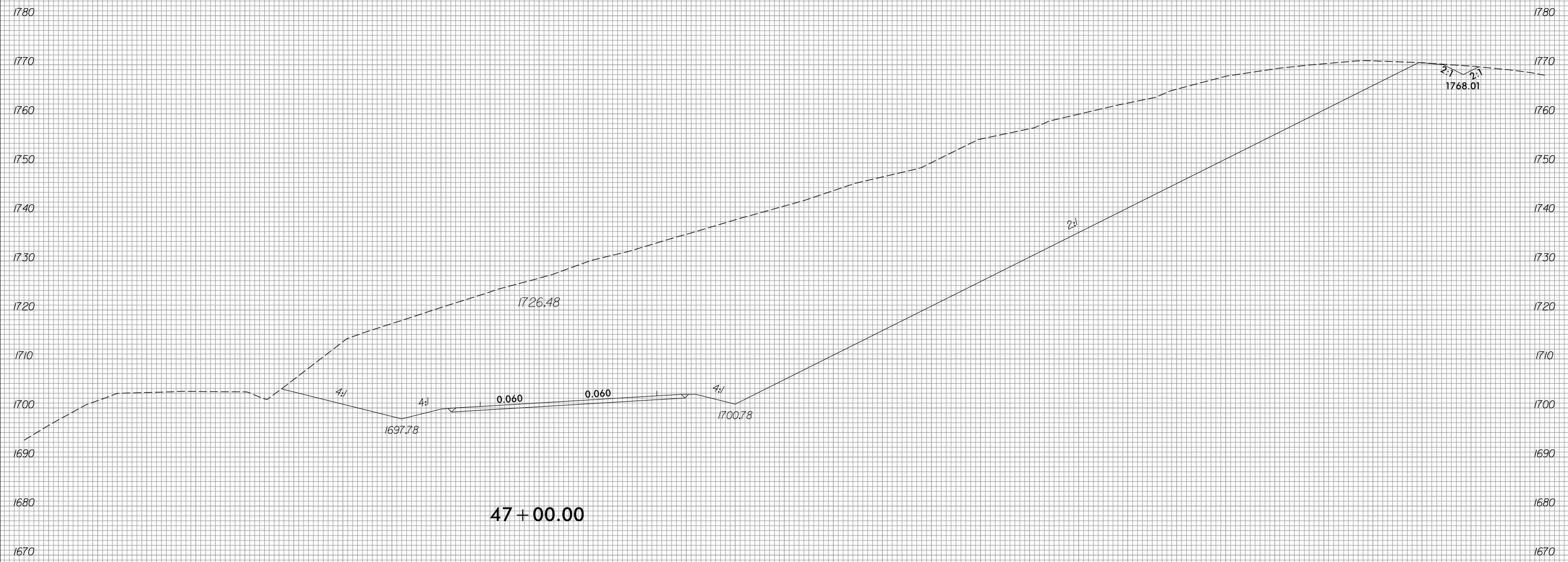

47 + 00.00

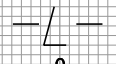

100 90 80 70 60 50 40 30 20 10 0 10 20 30 40 50 60 70 80 90 100 110 120 130 140 150 160 170 180 190 200

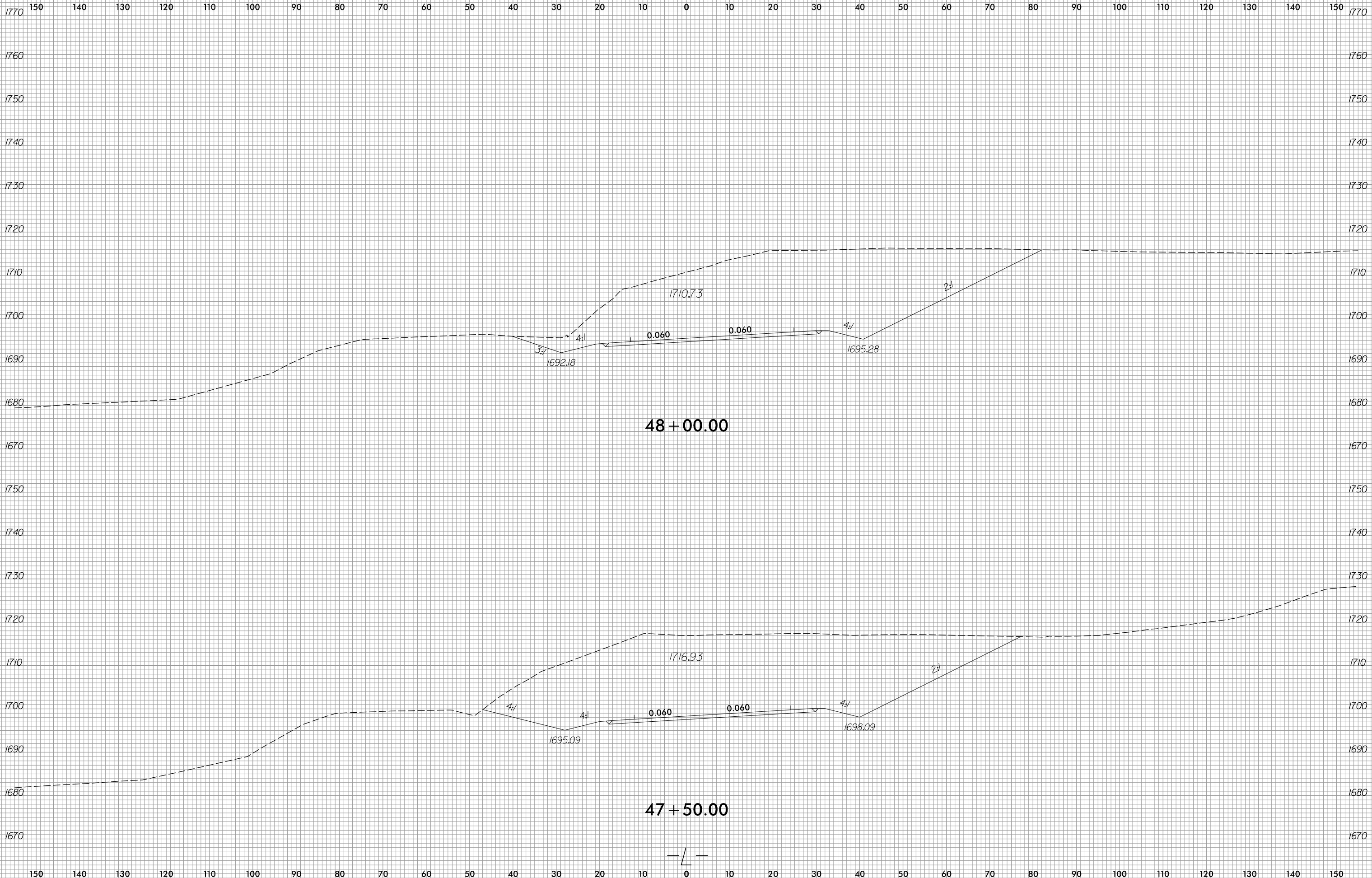

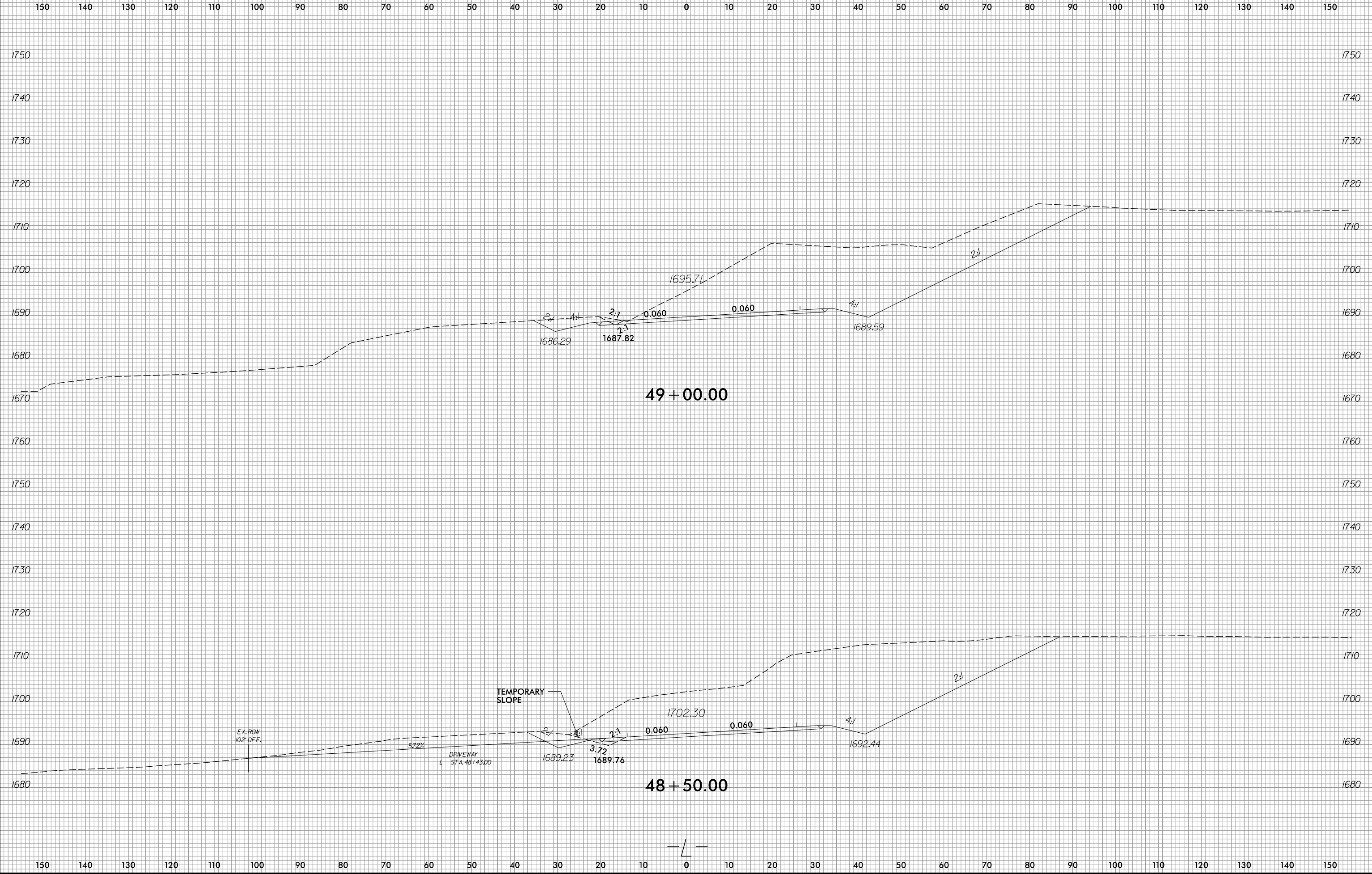



150 140 130 120 110 100 90 80 70 60 50 40 30 20 10 0 10 20 30 40 50 60 70 80 90 100 110 120 130 140 150

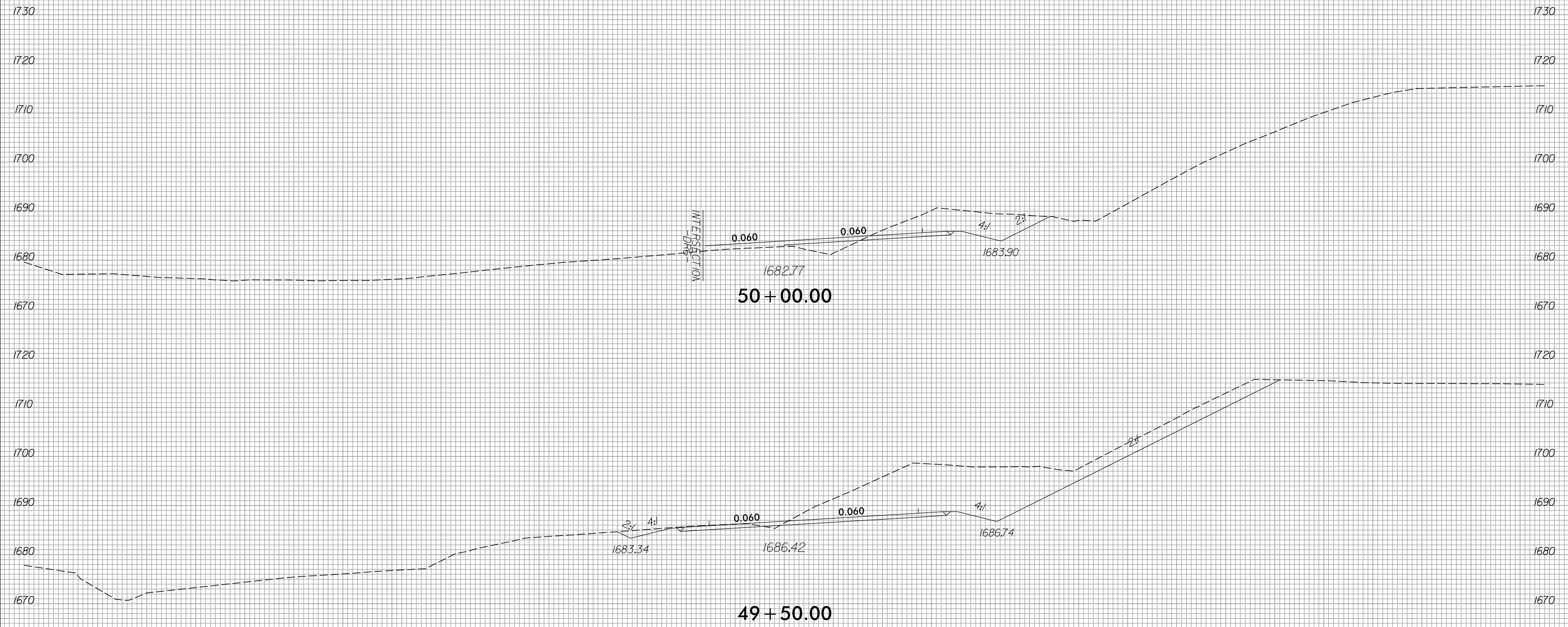

150 140 130 120 110 100 90 80 70 60 50 40 30 20 10 0 10 20 30 40 50 60 70 80 90 100 110 120 130 140 150

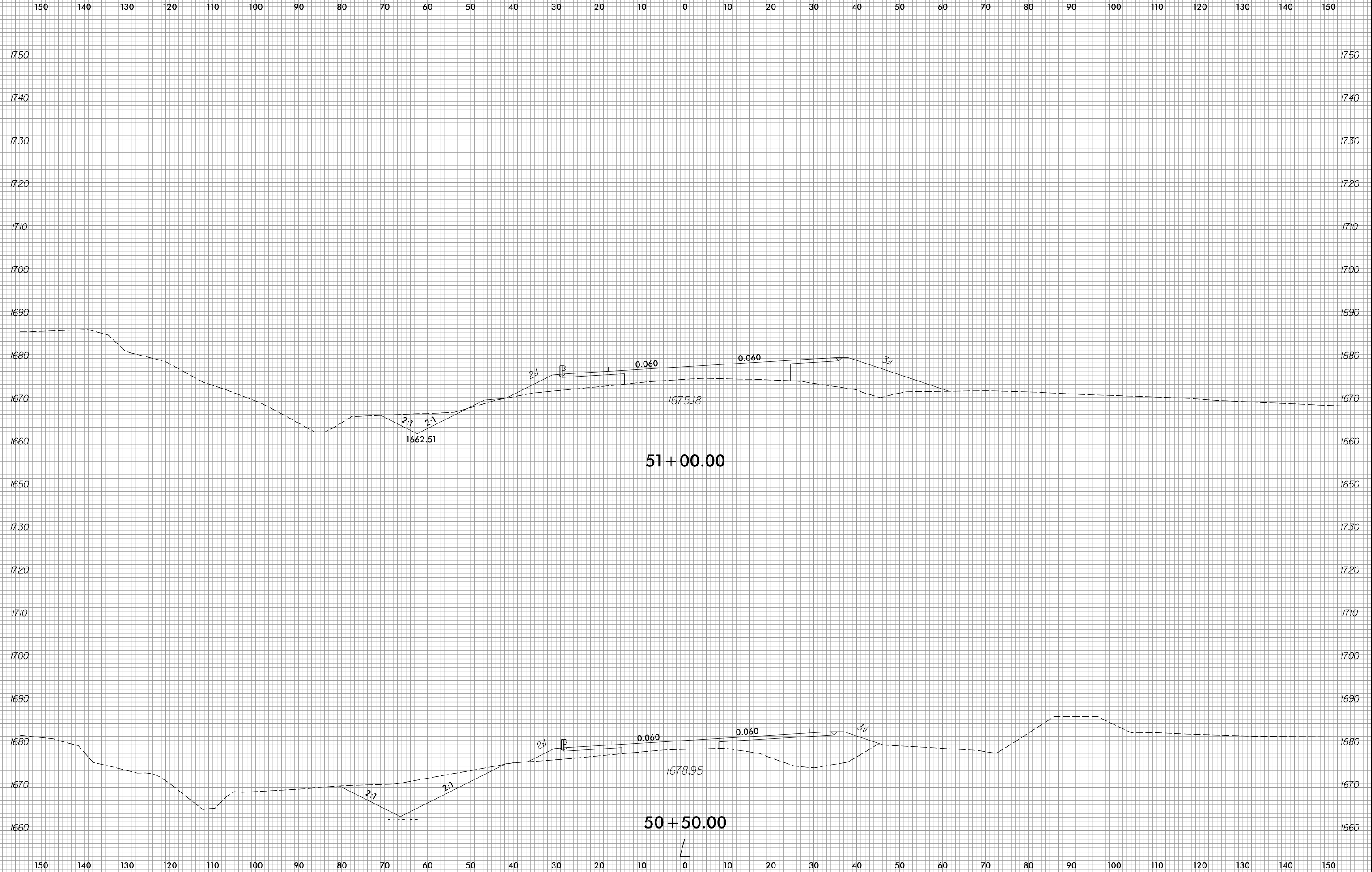



150 140 130 120 110 100 90 80 70 60 50 40 30 20 10 0 10 20 30 40 50 60 70 80 90 100 110 120 130 140 150

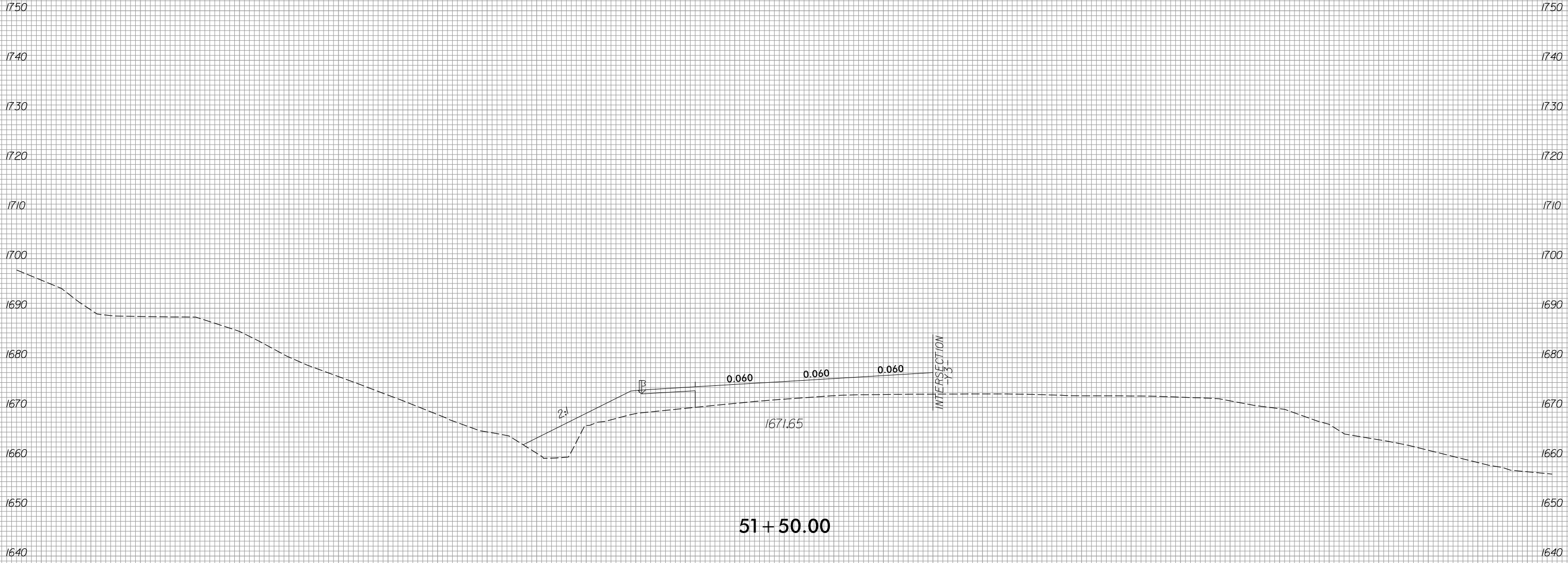

150 140 130 120 110 100 90 80 70 60 50 40 30 20 10 0 10 20 30 40 50 60 70 80 90 100 110 120 130 140 150

6/23/16



PROJ. REFERENCE NO.
R-5861

SHEET NO.
X-47

150 140 130 120 110 100 90 80 70 60 50 40 30 20 10 0 10 20 30 40 50 60 70 80 90 100 110 120 130 140 150

1750
1740
1730
1720
1710
1700
1690
1680
1670
1660
1650
1640

1750
1740
1730
1720
1710
1700
1690
1680
1670
1660
1650
1640

8/3/2023
R:\Roadway\XSC\XPLs\15861_Rd\XPL_L.dgn
P:\mason

150 140 130 120 110 100 90 80 70 60 50 40 30 20 10 0 10 20 30 40 50 60 70 80 90 100 110 120 130 140 150



6/23/16

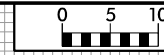

PROJ. REFERENCE NO.
R-5861

SHEET NO.
X-48

150 140 130 120 110 100 90 80 70 60 50 40 30 20 10 0 10 20 30 40 50 60 70 80 90 100 110 120 130 140 150

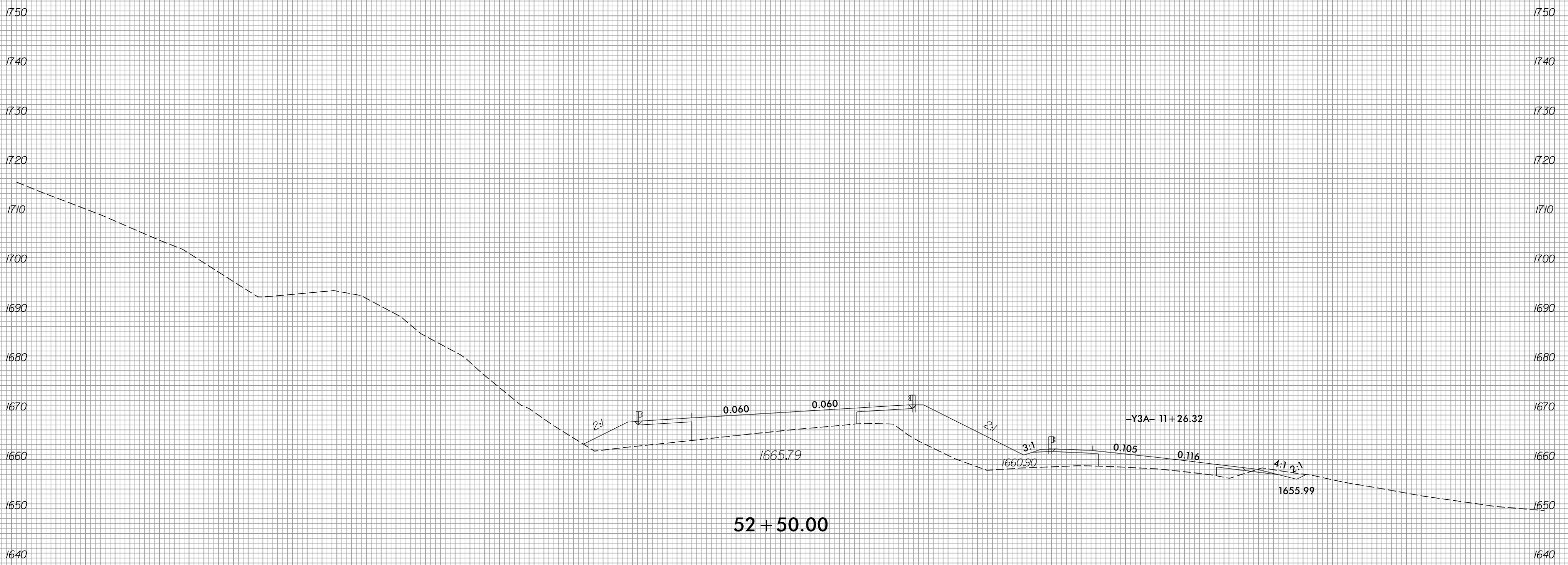

52 + 50.00

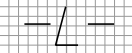

8/3/2023
R:\Roadway\XSC\XPLs\15861_Rd\XPL_L.dgn
P:\mason



150 140 130 120 110 100 90 80 70 60 50 40 30 20 10 0 10 20 30 40 50 60 70 80 90 100 110 120 130 140 150

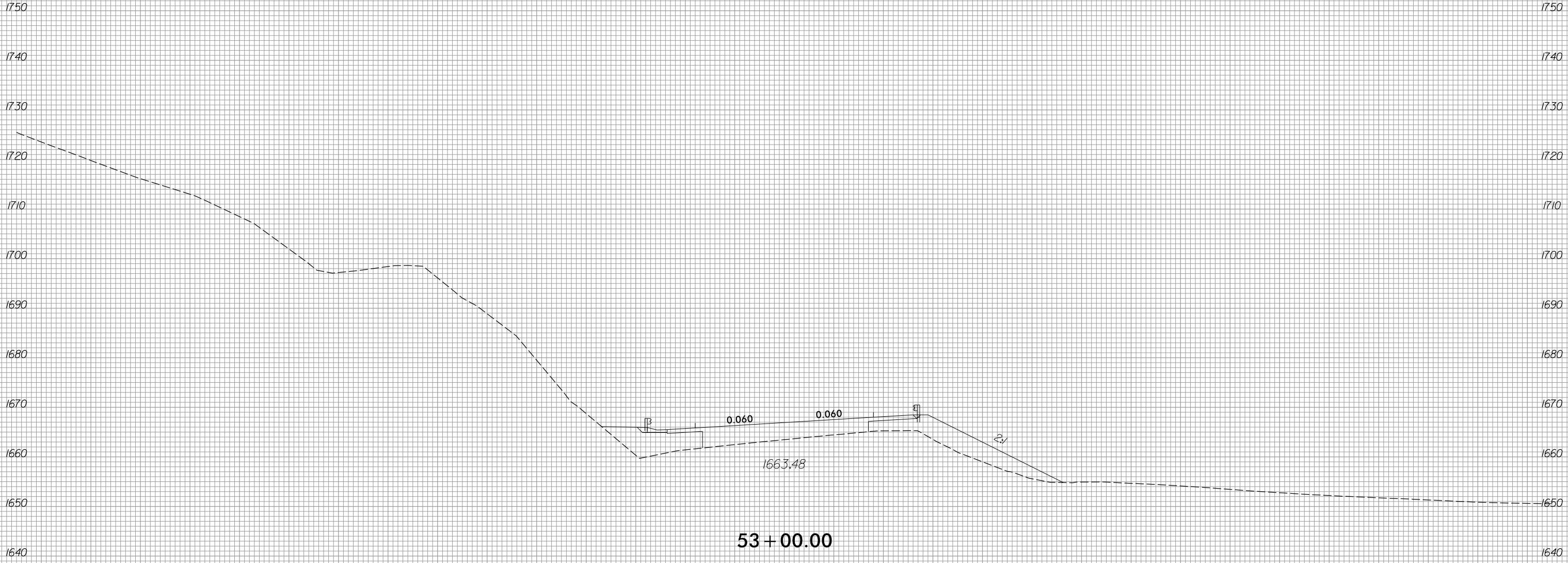

150 140 130 120 110 100 90 80 70 60 50 40 30 20 10 0 10 20 30 40 50 60 70 80 90 100 110 120 130 140 150

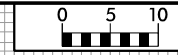

150 140 130 120 110 100 90 80 70 60 50 40 30 20 10 0 10 20 30 40 50 60 70 80 90 100 110 120 130 140 150

1750

1750

1740

1740

1730

1730

1720

1720

1710

1710

1700

1700

1690

1690

1680

1680

1670

1670

1660

1660

1650

1650

1640

1640

150 140 130 120 110 100 90 80 70 60 50 40 30 20 10 0 10 20 30 40 50 60 70 80 90 100 110 120 130 140 150

53 + 50.00

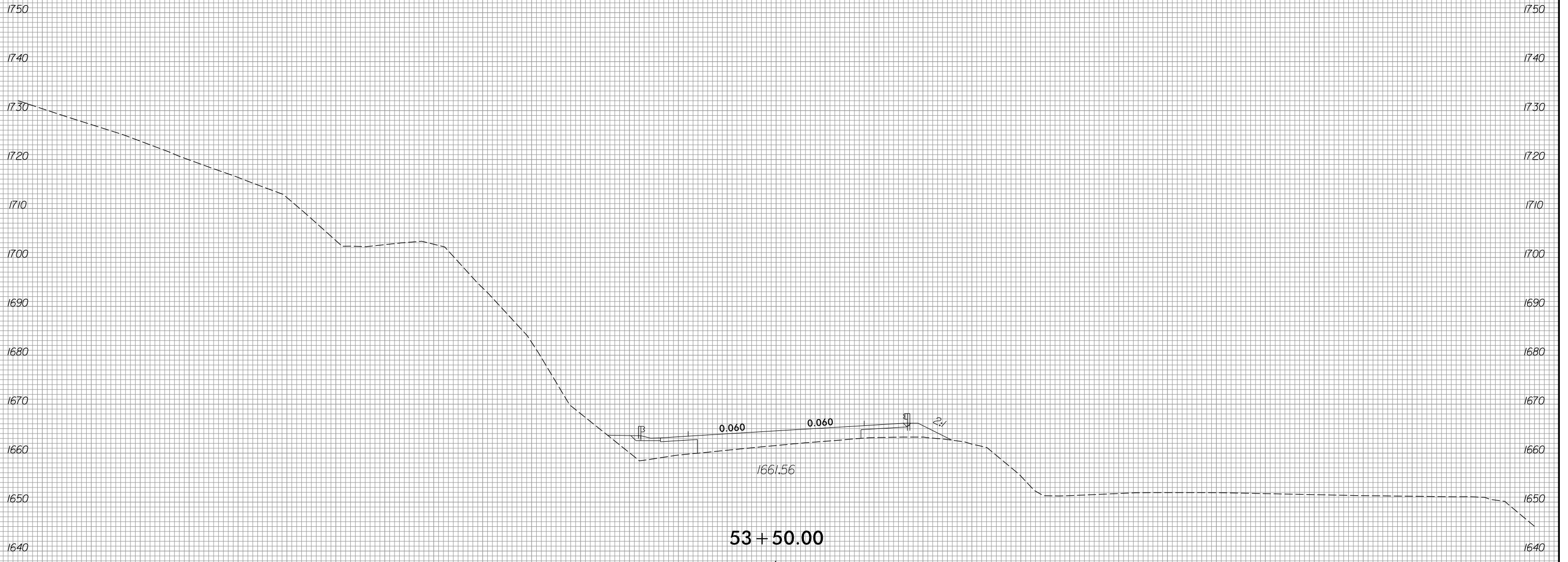

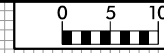

150 140 130 120 110 100 90 80 70 60 50 40 30 20 10 0 10 20 30 40 50 60 70 80 90 100 110 120 130 140 150

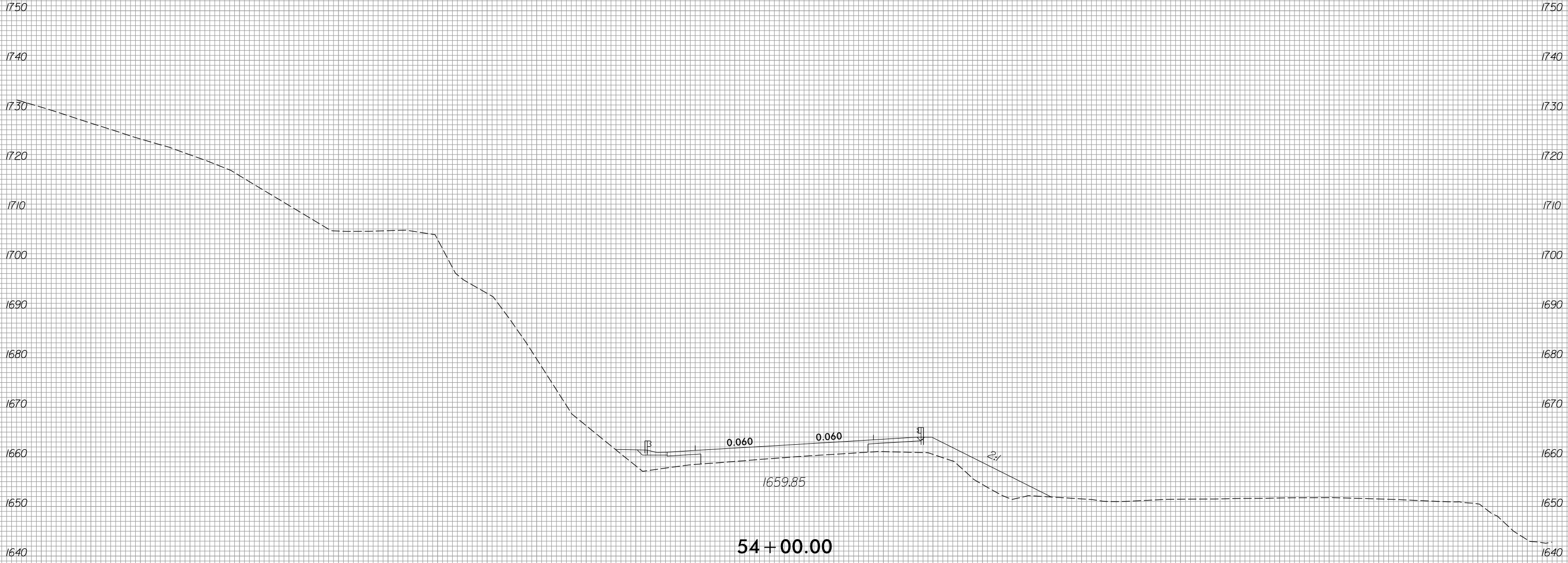

150 140 130 120 110 100 90 80 70 60 50 40 30 20 10 0 10 20 30 40 50 60 70 80 90 100 110 120 130 140 150



150 140 130 120 110 100 90 80 70 60 50 40 30 20 10 0 10 20 30 40 50 60 70 80 90 100 110 120 130 140 150

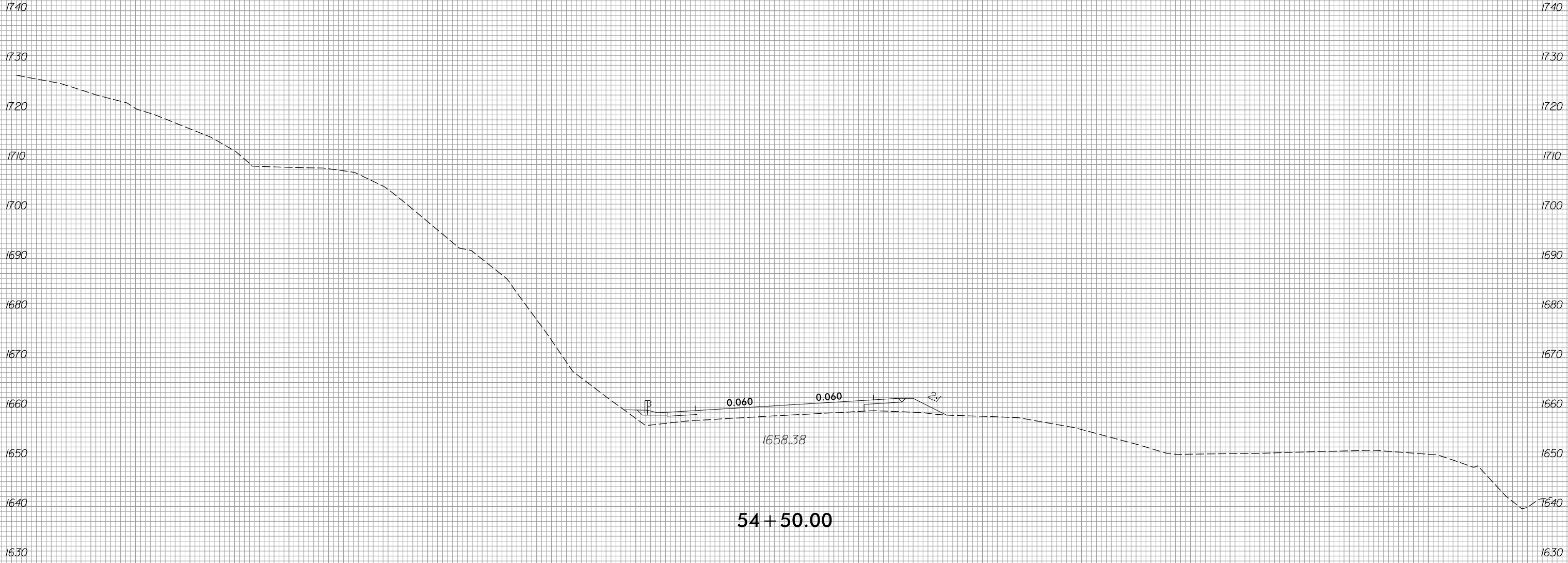

54 + 50.00

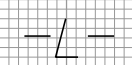

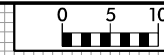

150 140 130 120 110 100 90 80 70 60 50 40 30 20 10 0 10 20 30 40 50 60 70 80 90 100 110 120 130 140 150

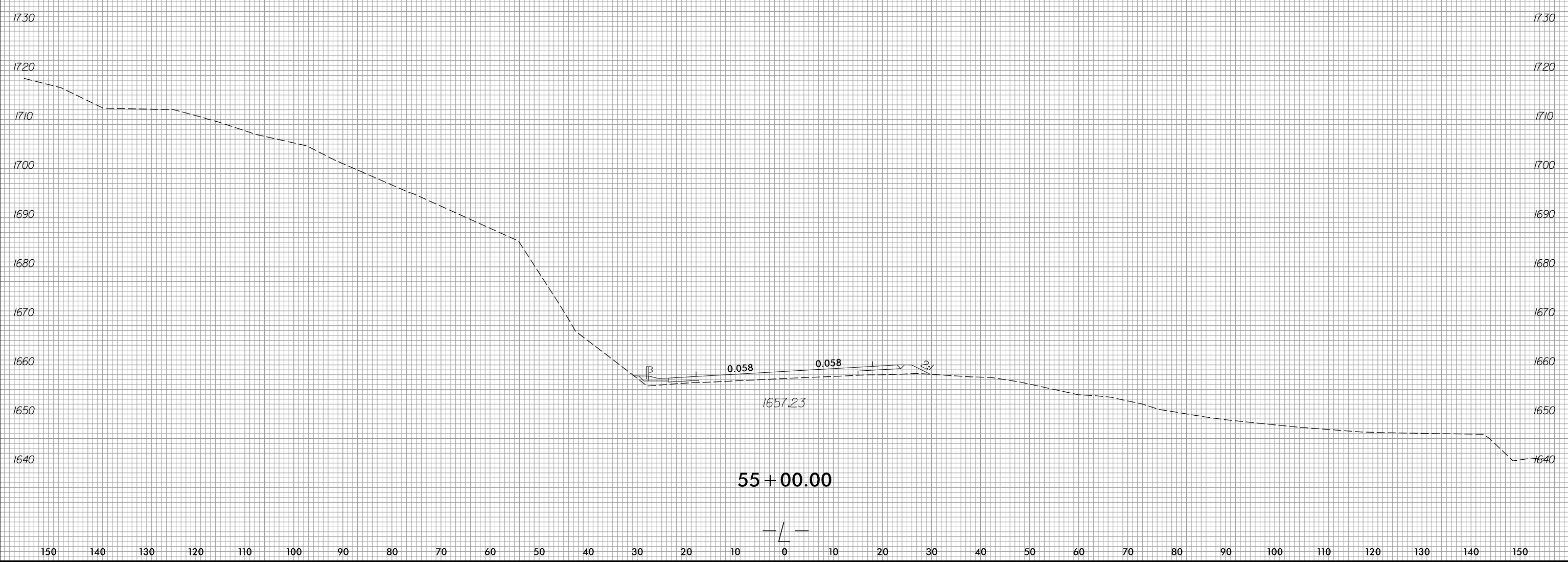



150 140 130 120 110 100 90 80 70 60 50 40 30 20 10 0 10 20 30 40 50 60 70 80 90 100 110 120 130 140 150

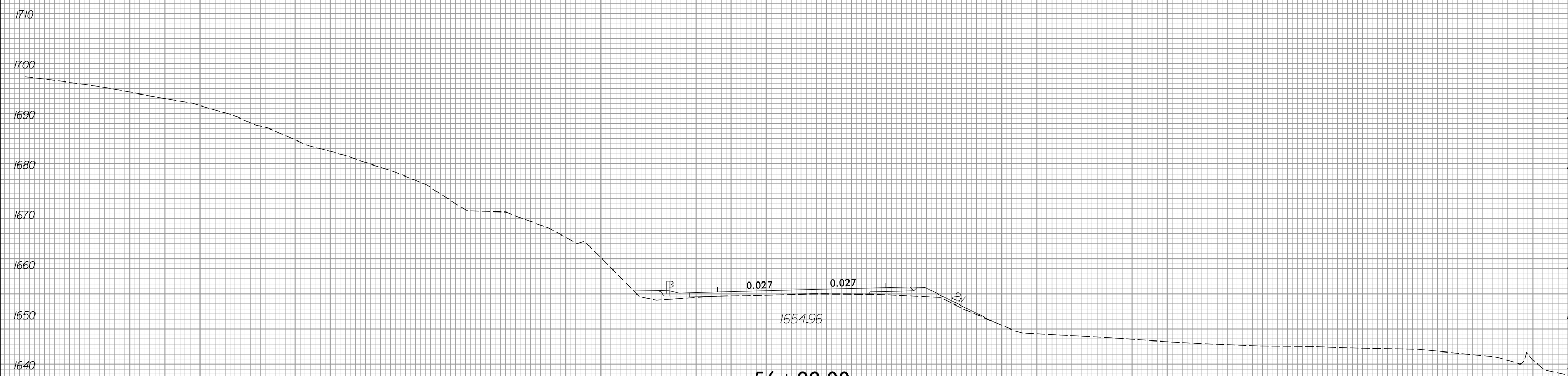

56 + 00.00

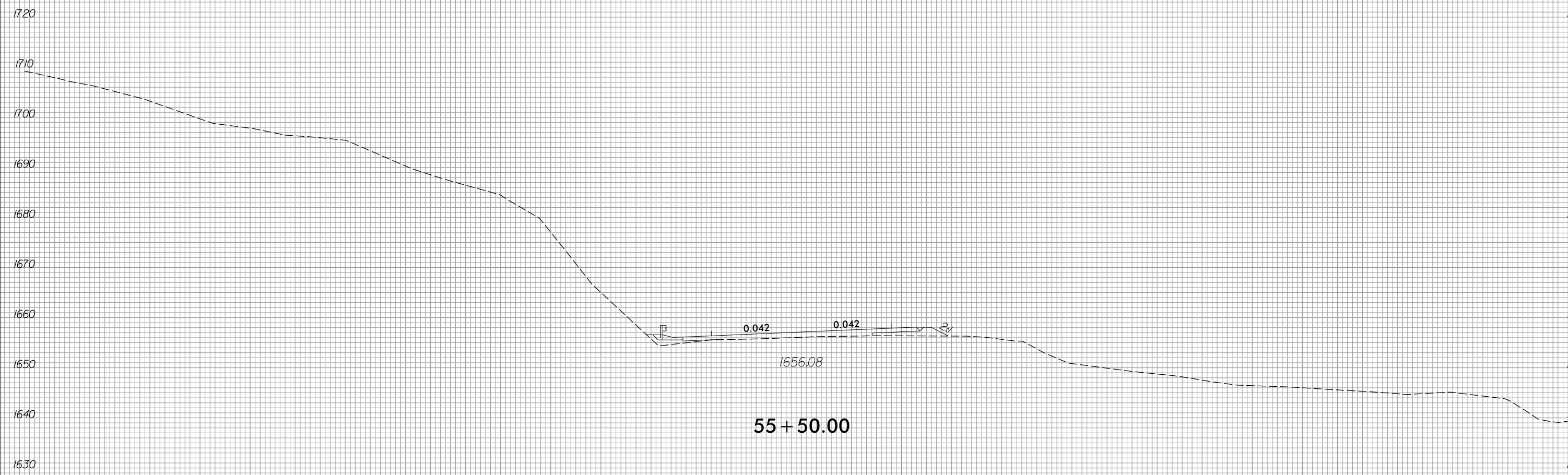

55 + 50.00

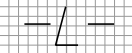



150 140 130 120 110 100 90 80 70 60 50 40 30 20 10 0 10 20 30 40 50 60 70 80 90 100 110 120 130 140 150

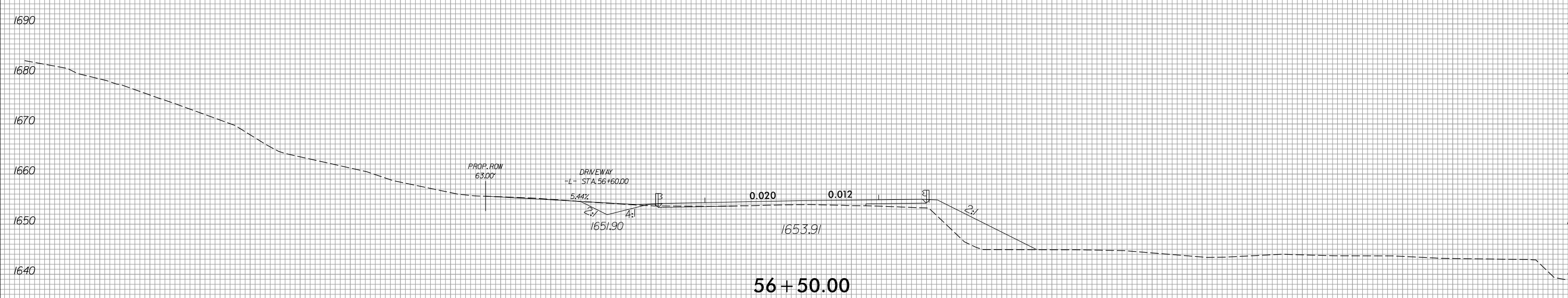
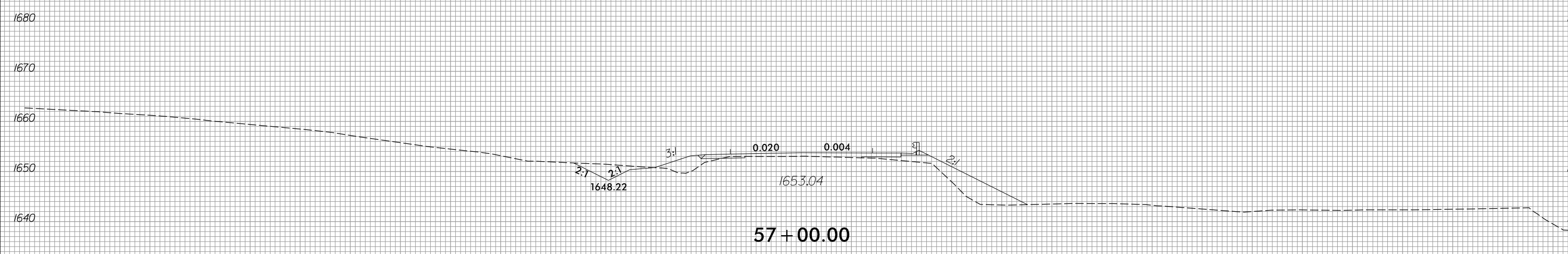
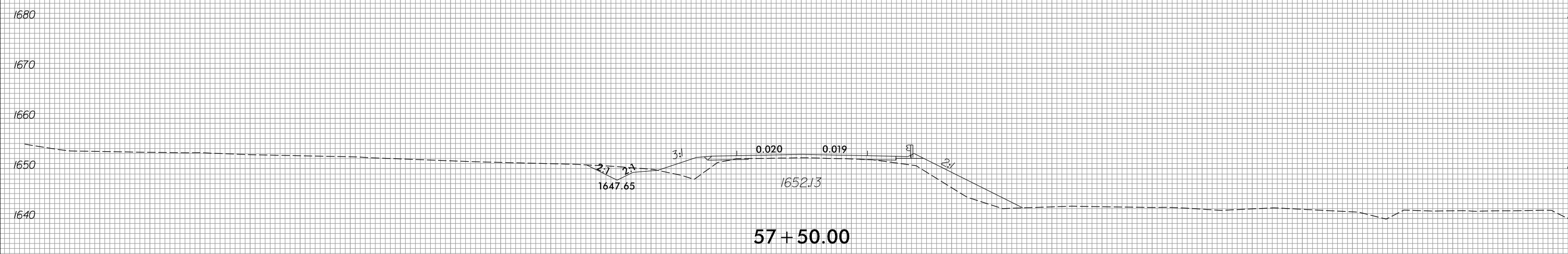

150 140 130 120 110 100 90 80 70 60 50 40 30 20 10 0 10 20 30 40 50 60 70 80 90 100 110 120 130 140 150

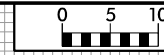

150 140 130 120 110 100 90 80 70 60 50 40 30 20 10 0 10 20 30 40 50 60 70 80 90 100 110 120 130 140 150

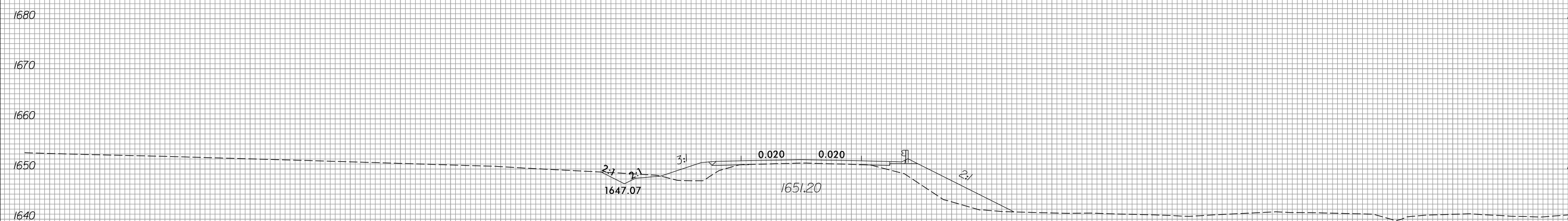
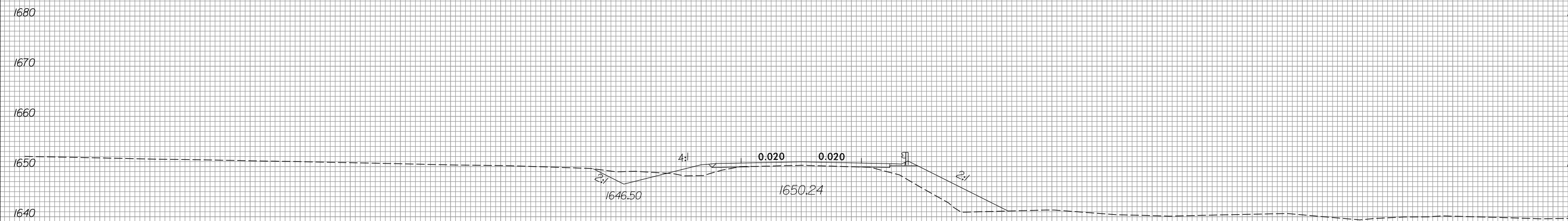
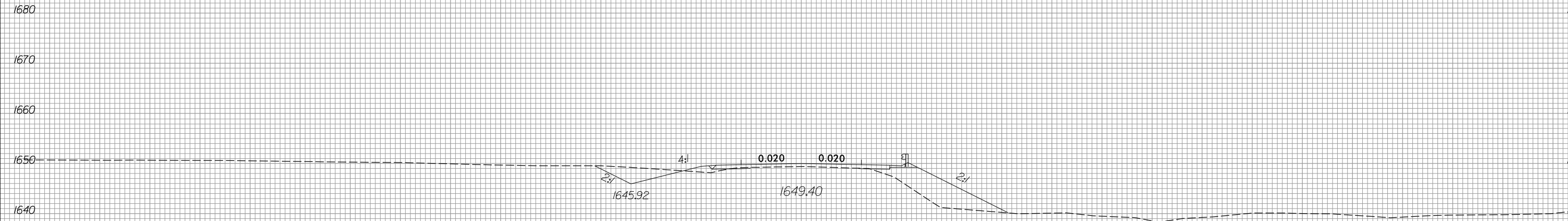

150 140 130 120 110 100 90 80 70 60 50 40 30 20 10 0 10 20 30 40 50 60 70 80 90 100 110 120 130 140 150



150 140 130 120 110 100 90 80 70 60 50 40 30 20 10 0 10 20 30 40 50 60 70 80 90 100 110 120 130 140 150

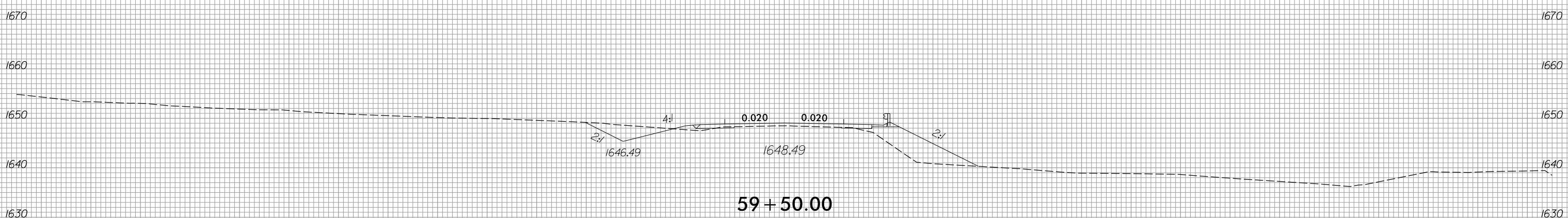
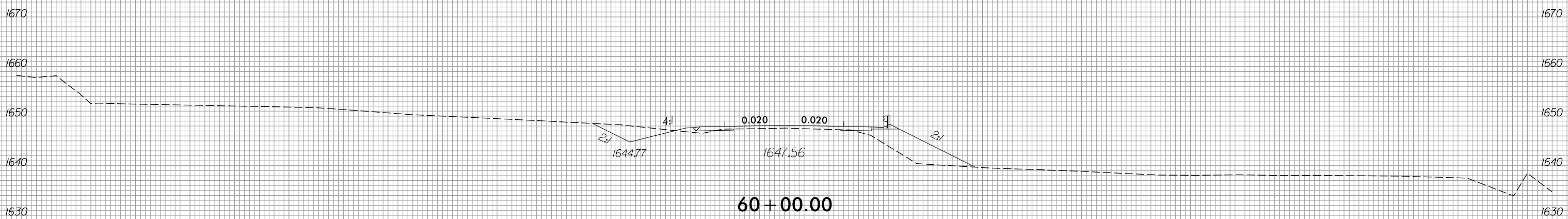
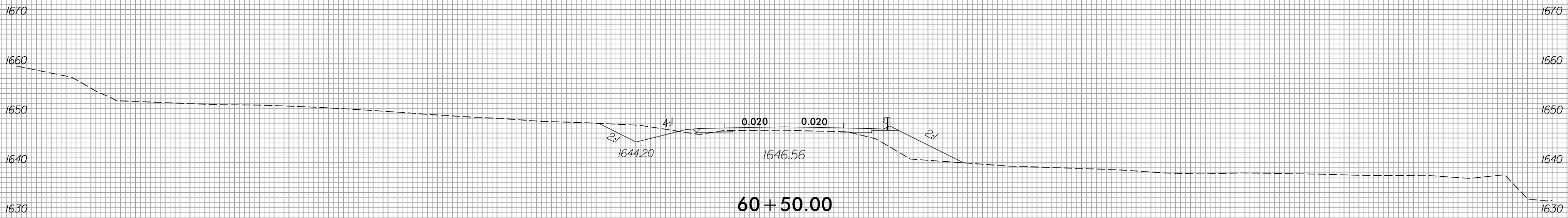
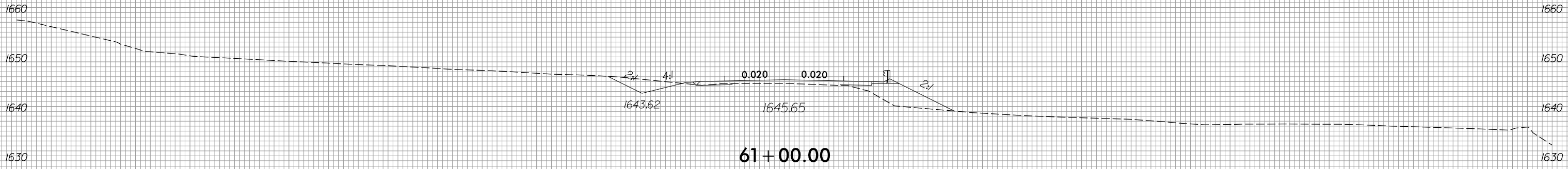

150 140 130 120 110 100 90 80 70 60 50 40 30 20 10 0 10 20 30 40 50 60 70 80 90 100 110 120 130 140 150

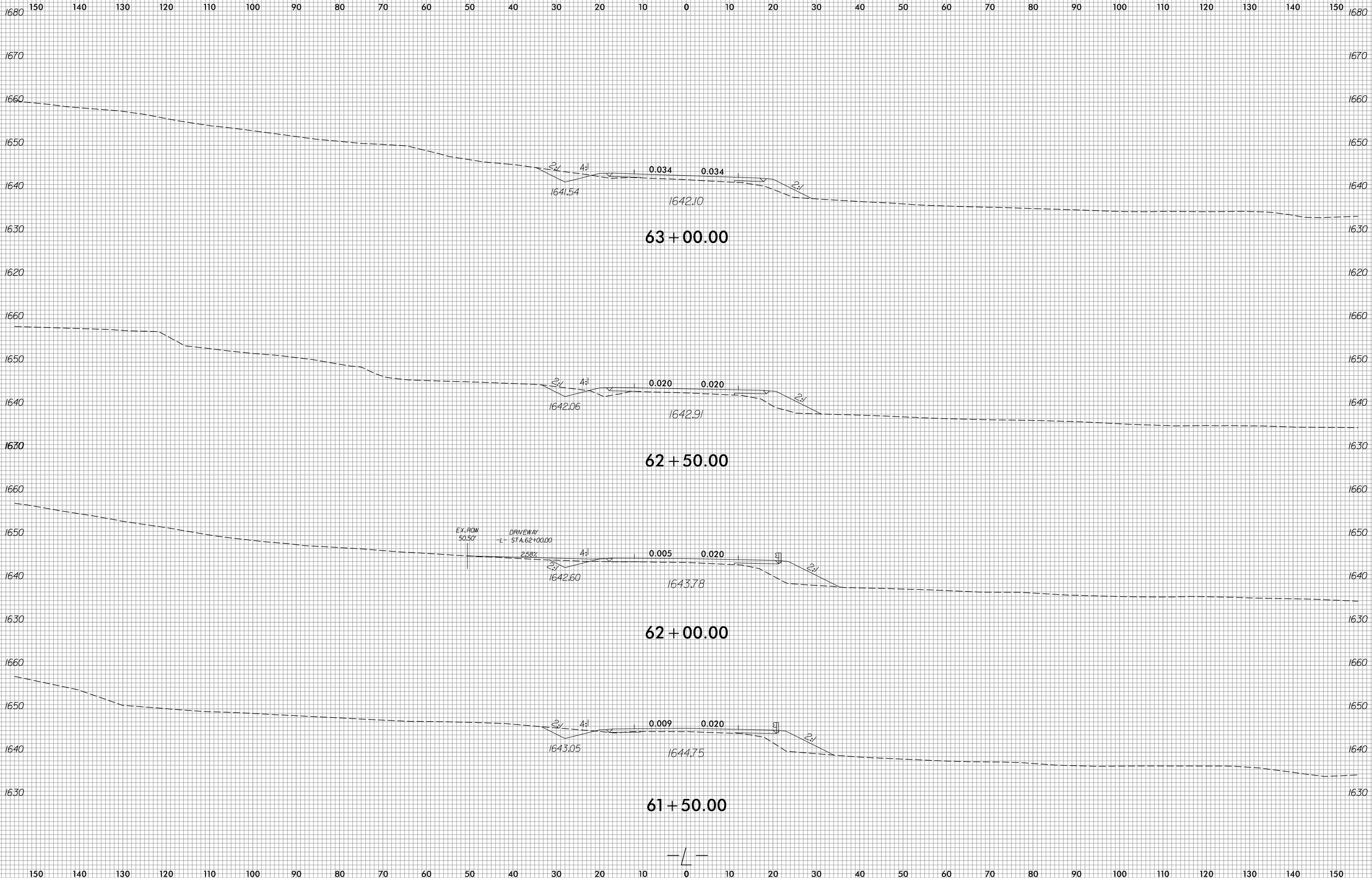
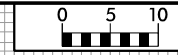

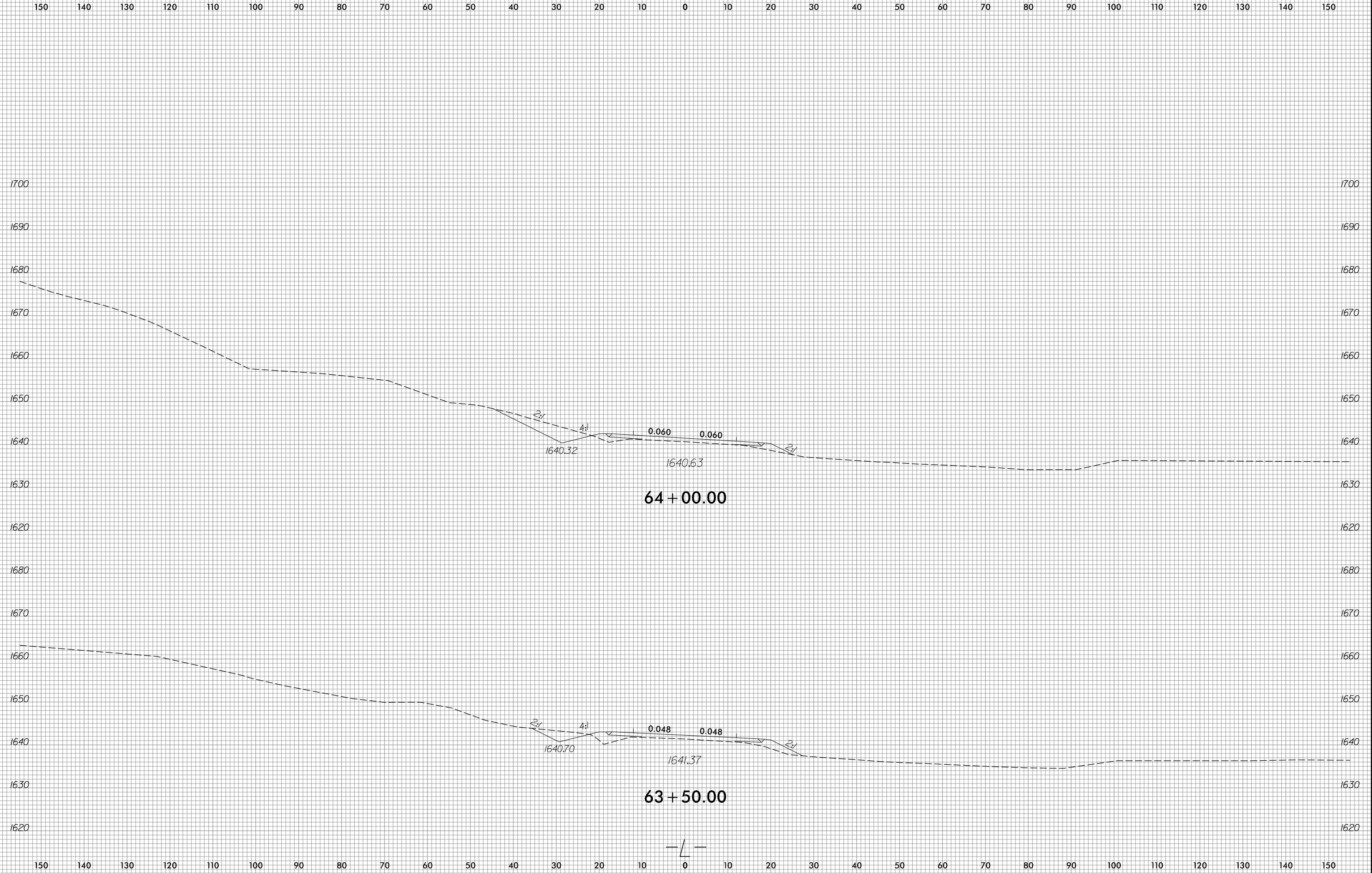



150 140 130 120 110 100 90 80 70 60 50 40 30 20 10 0 10 20 30 40 50 60 70 80 90 100 110 120 130 140 150

1720

1720

1710

1710

1700

1700

1690

1690

1680

1680

1670

1670

1660

1660

1650

1650

1640

1640

1630

1630

1620

1620

150 140 130 120 110 100 90 80 70 60 50 40 30 20 10 0 10 20 30 40 50 60 70 80 90 100 110 120 130 140 150

64 + 50.00

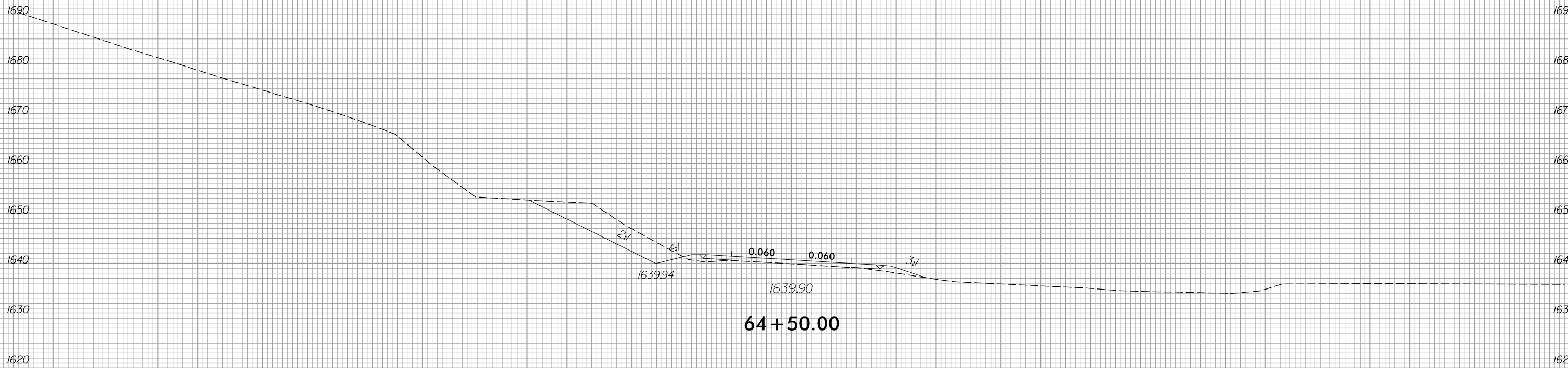
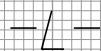

1639.94

1639.90

2:1

4:1

0.060

0.060

3:1



150 140 130 120 110 100 90 80 70 60 50 40 30 20 10 0 10 20 30 40 50 60 70 80 90 100 110 120 130 140 150

1730
1720
1710
1700
1690
1680
1670
1660
1650
1640
1630
1620

1730
1720
1710
1700
1690
1680
1670
1660
1650
1640
1630
1620

150 140 130 120 110 100 90 80 70 60 50 40 30 20 10 0 10 20 30 40 50 60 70 80 90 100 110 120 130 140 150

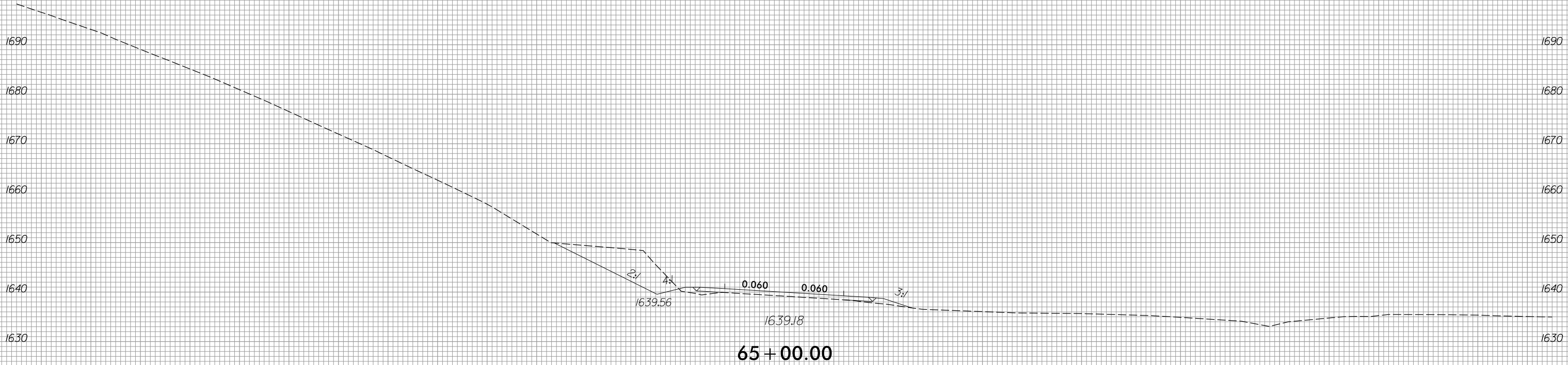



150 140 130 120 110 100 90 80 70 60 50 40 30 20 10 0 10 20 30 40 50 60 70 80 90 100 110 120 130 140 150

1730

1730

1720

1720

1710

1710

1700

1700

1690

1690

1680

1680

1670

1670

1660

1660

1650

1650

1640

1640

1630

1630

1620

1620

65 + 50.00

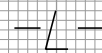

1638.52

1638.70

1635.98

2:1

0.060

0.060

4:1

2:1

DRIVEWAY
-L- STA. 65+30.00

7.94%

EX. ROW
51.00'



150 140 130 120 110 100 90 80 70 60 50 40 30 20 10 0 10 20 30 40 50 60 70 80 90 100 110 120 130 140 150

1730

1730

1720

1720

1710

1710

1700

1700

1690

1690

1680

1680

1670

1670

1660

1660

1650

1650

1640

1640

1630

1630

1620

1620

66 + 00.00

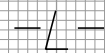

150 140 130 120 110 100 90 80 70 60 50 40 30 20 10 0 10 20 30 40 50 60 70 80 90 100 110 120 130 140 150



150 140 130 120 110 100 90 80 70 60 50 40 30 20 10 0 10 20 30 40 50 60 70 80 90 100 110 120 130 140 150

1720

1720

1710

1710

1700

1700

1690

1690

1680

1680

1670

1670

1660

1660

1650

1650

1640

1640

1630

1630

1620

1620

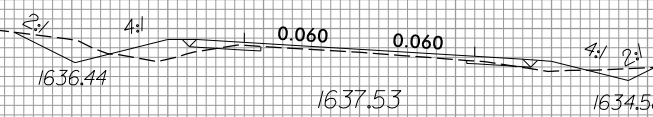

66 + 50.00

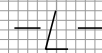

150 140 130 120 110 100 90 80 70 60 50 40 30 20 10 0 10 20 30 40 50 60 70 80 90 100 110 120 130 140 150

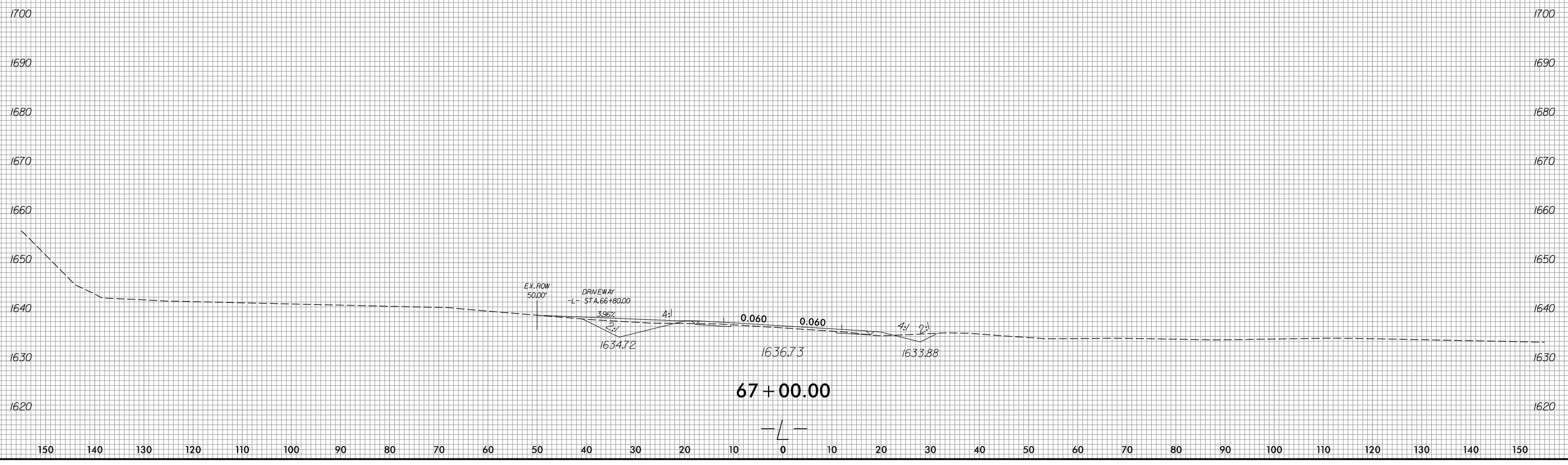
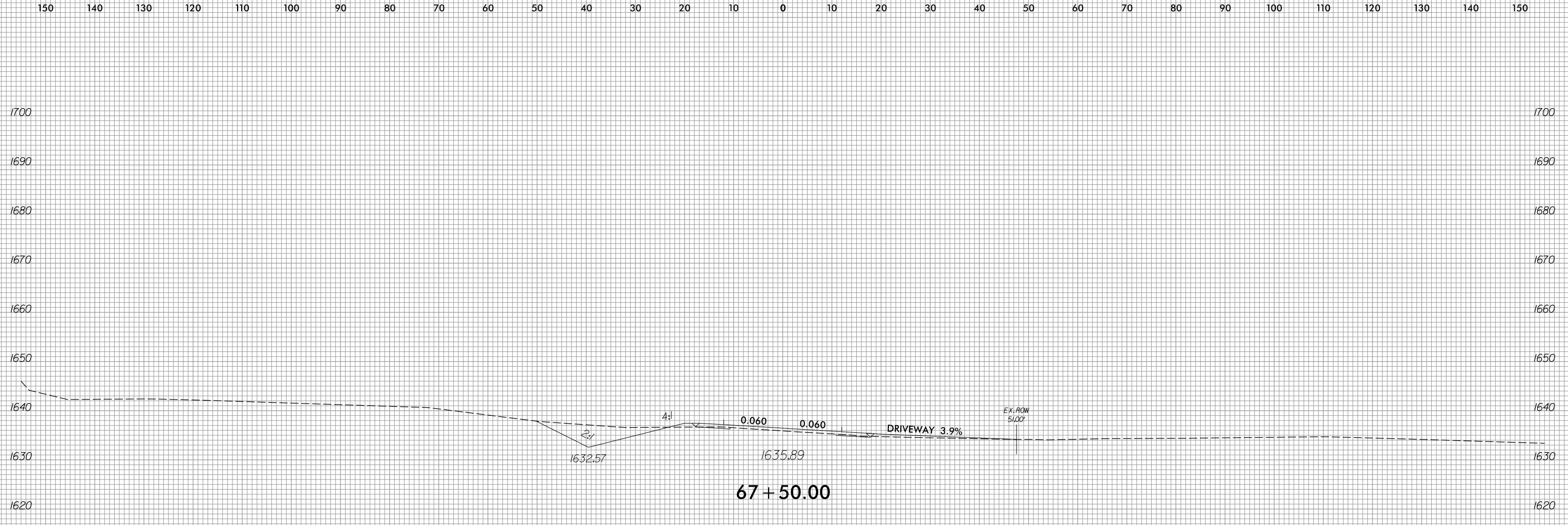

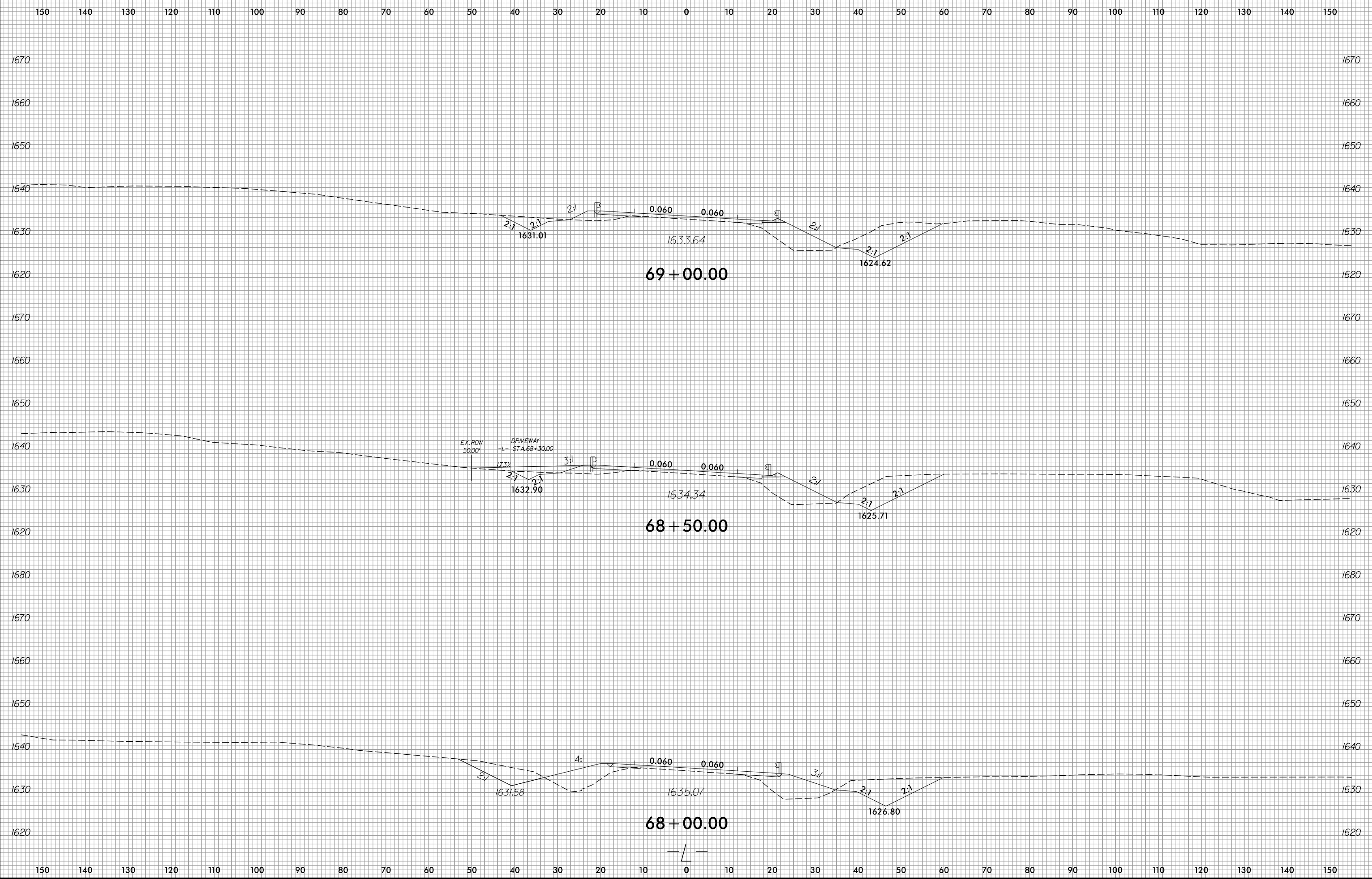

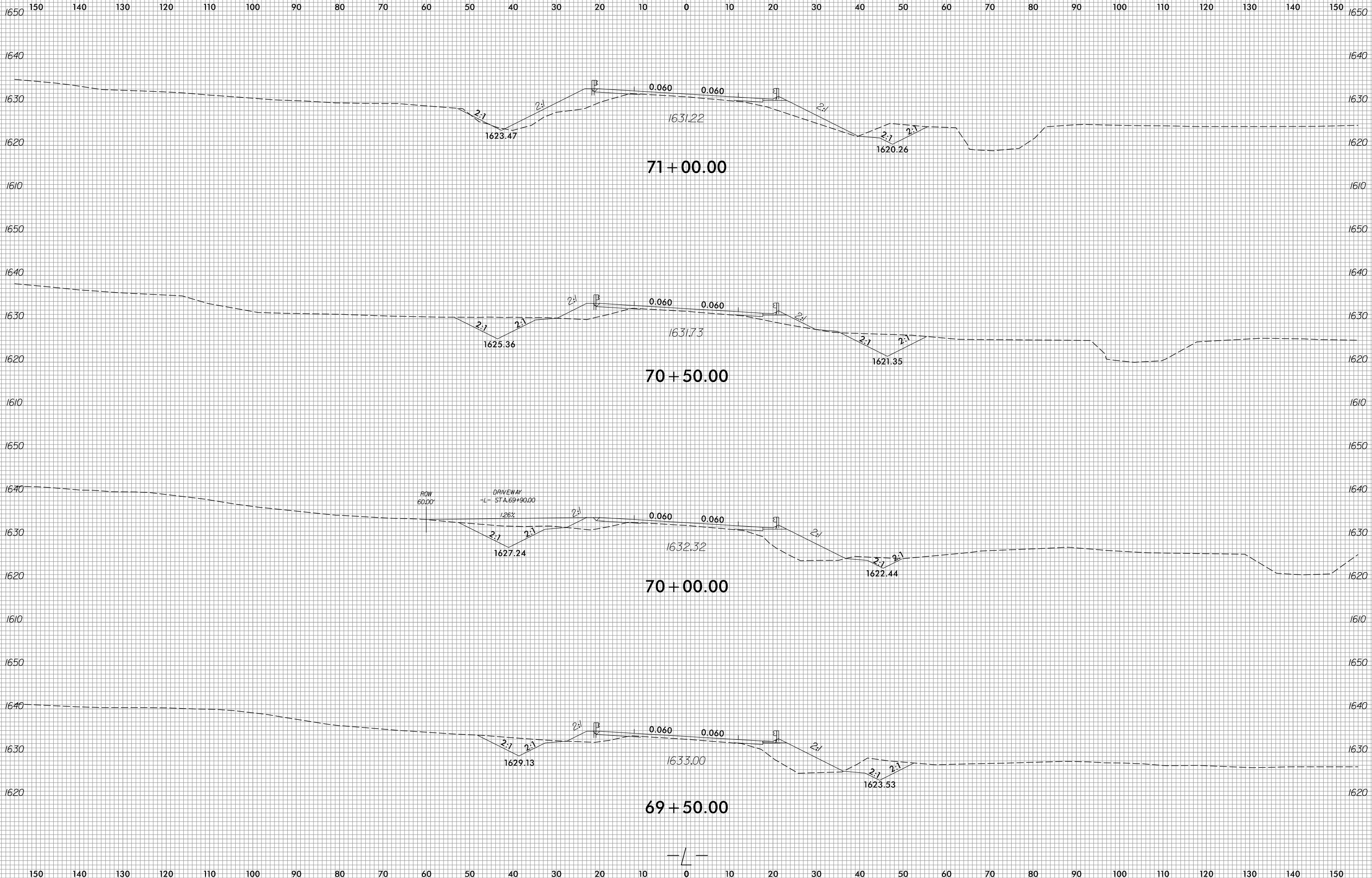



150 140 130 120 110 100 90 80 70 60 50 40 30 20 10 0 10 20 30 40 50 60 70 80 90 100 110 120 130 140 150

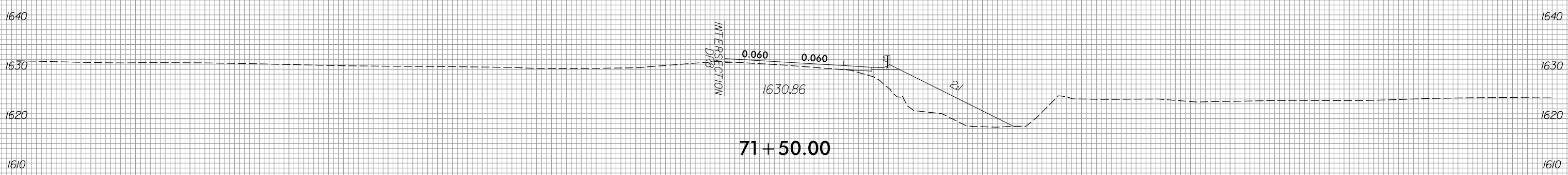
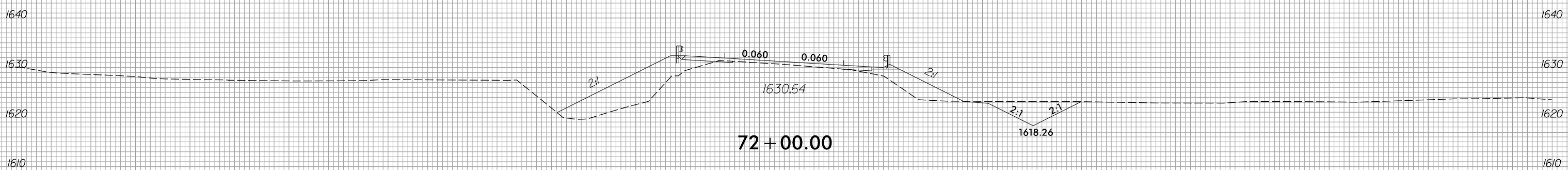
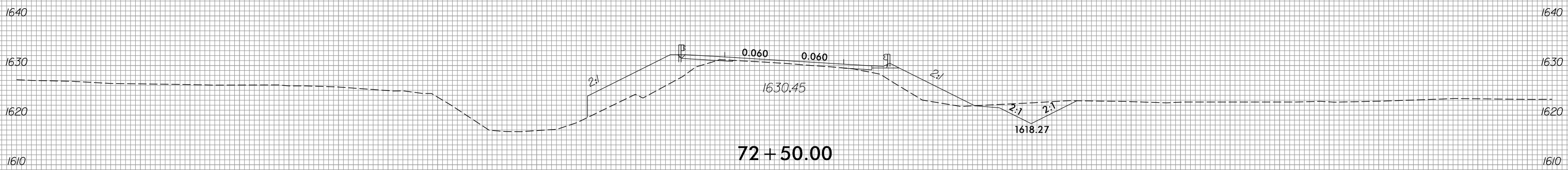
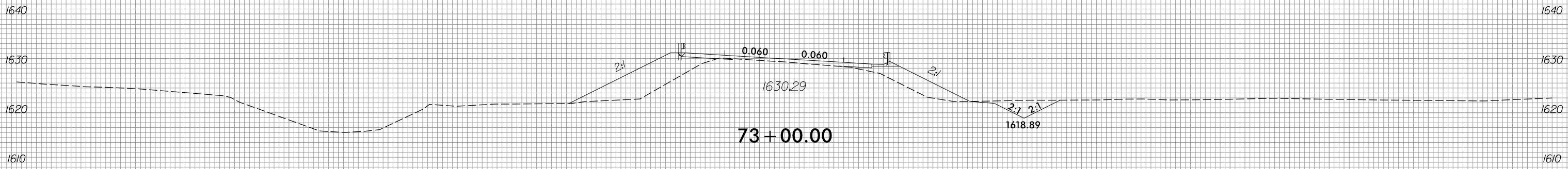
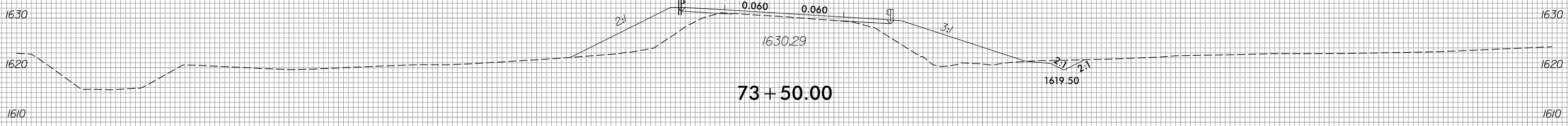

150 140 130 120 110 100 90 80 70 60 50 40 30 20 10 0 10 20 30 40 50 60 70 80 90 100 110 120 130 140 150



150 140 130 120 110 100 90 80 70 60 50 40 30 20 10 0 10 20 30 40 50 60 70 80 90 100 110 120 130 140 150

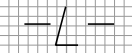
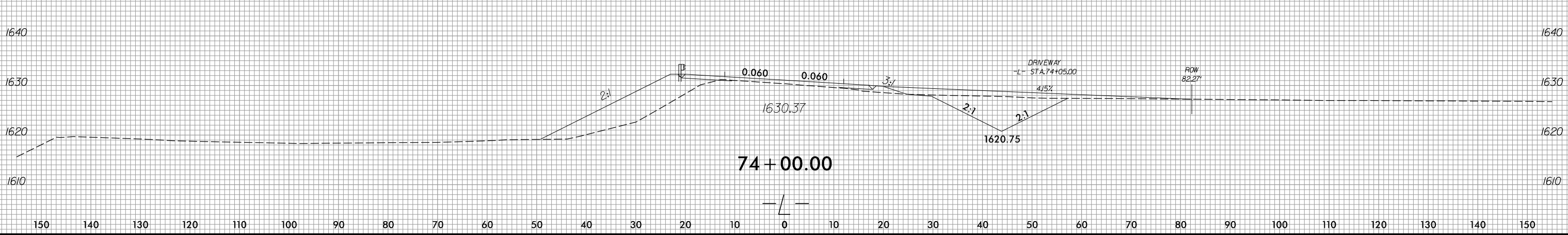
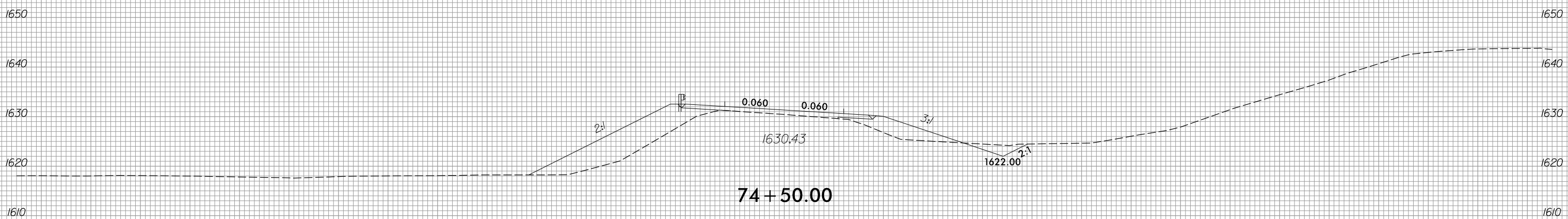
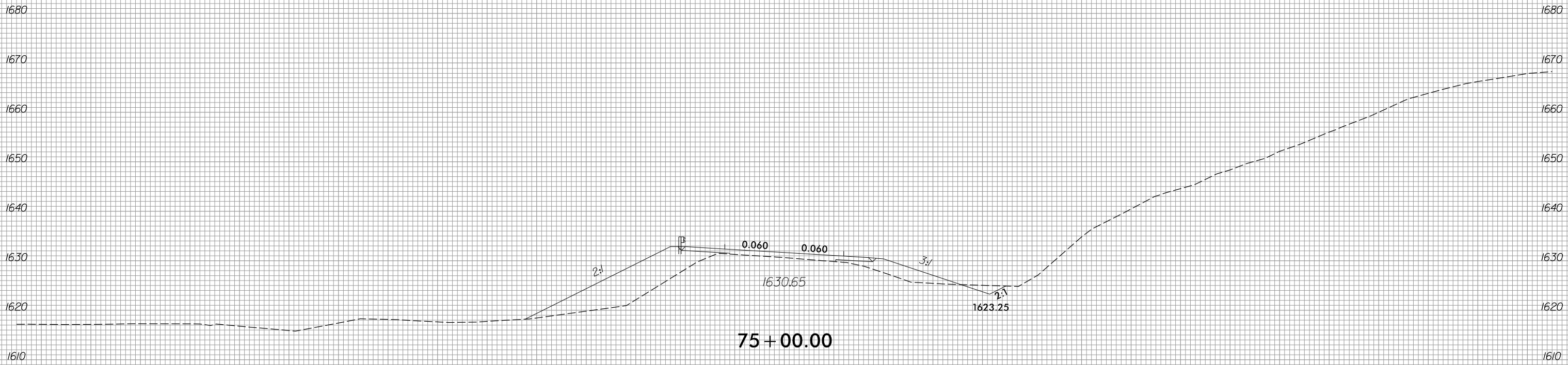



150 140 130 120 110 100 90 80 70 60 50 40 30 20 10 0 10 20 30 40 50 60 70 80 90 100 110 120 130 140 150

1700 1700

1690 1690

1680 1680

1670 1670

1660 1660

1650 1650

1640 1640

1630 1630

1620 1620

1610 1610

1690 1690

1680 1680

1670 1670

1660 1660

1650 1650

1640 1640

1630 1630

1620 1620

1610 1610

150 140 130 120 110 100 90 80 70 60 50 40 30 20 10 0 10 20 30 40 50 60 70 80 90 100 110 120 130 140 150

76 + 00.00

75 + 50.00

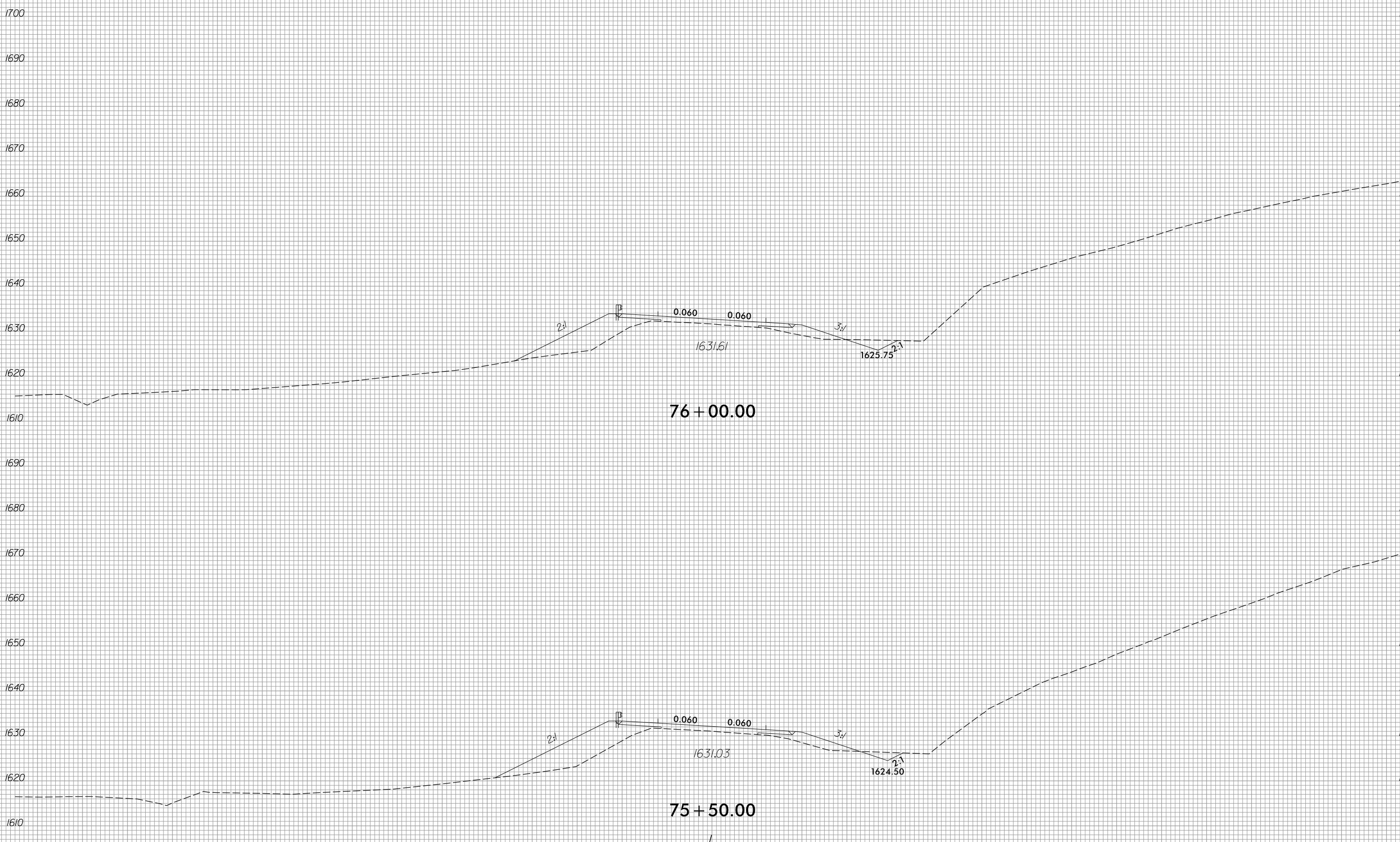
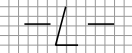

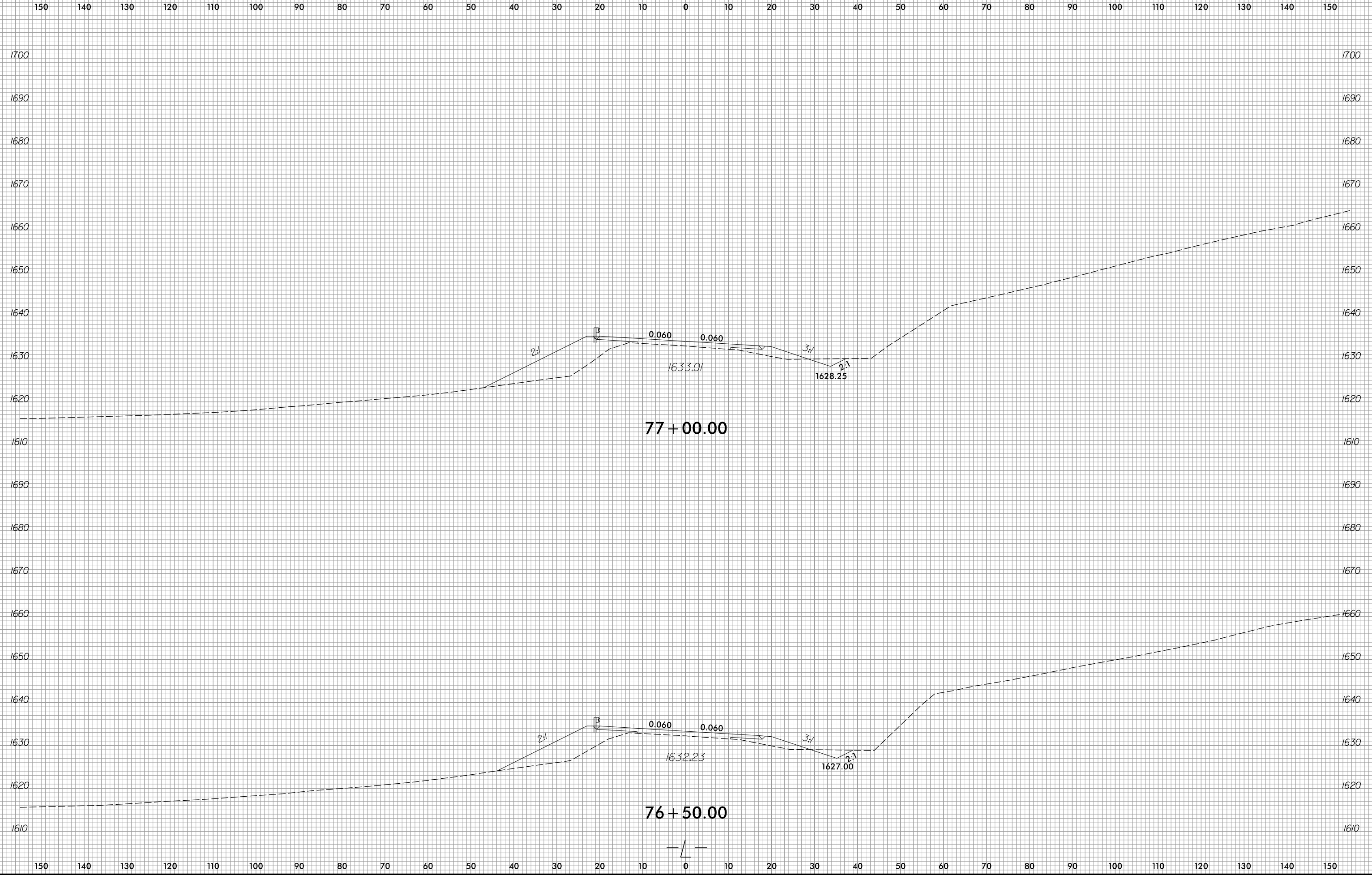
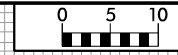

6/23/16



PROJ. REFERENCE NO.	SHEET NO.
R-5861	X-72

150 140 130 120 110 100 90 80 70 60 50 40 30 20 10 0 10 20 30 40 50 60 70 80 90 100 110 120 130 140 150

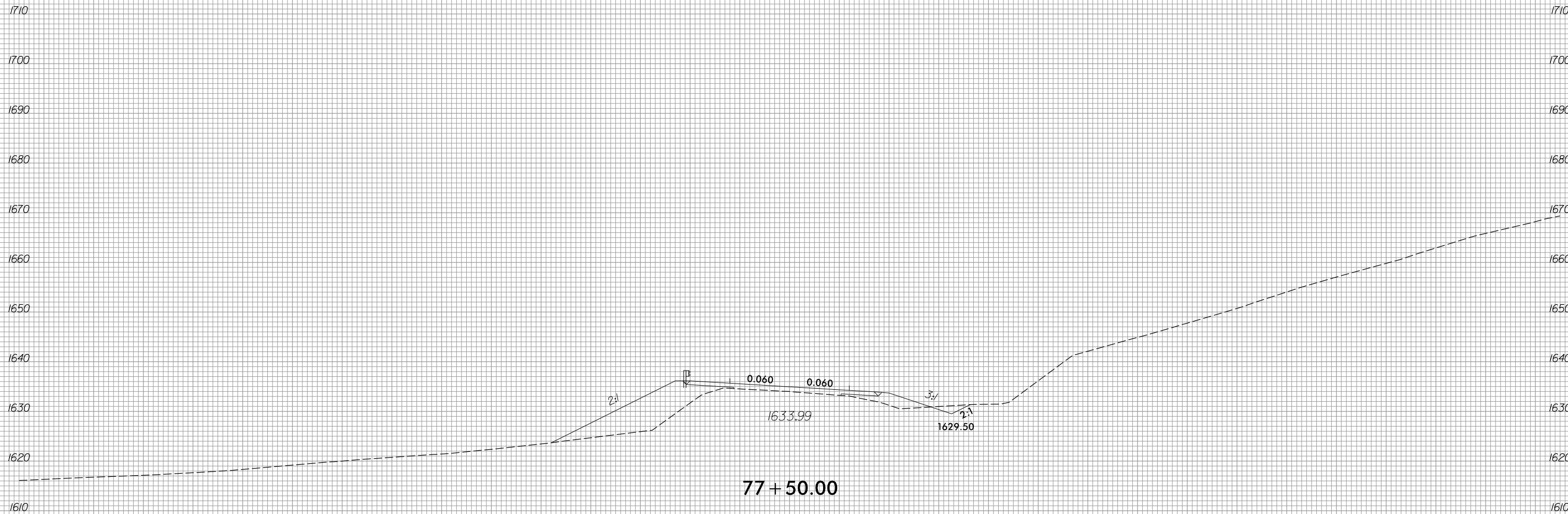

8/3/2023
 R:\Roadway\XSC\XPLs\RB861.Rdy.XPL.dgn
 jinson

150 140 130 120 110 100 90 80 70 60 50 40 30 20 10 0 10 20 30 40 50 60 70 80 90 100 110 120 130 140 150



150 140 130 120 110 100 90 80 70 60 50 40 30 20 10 0 10 20 30 40 50 60 70 80 90 100 110 120 130 140 150

1710
1700
1690
1680
1670
1660
1650
1640
1630
1620
1610

1710
1700
1690
1680
1670
1660
1650
1640
1630
1620
1610

150 140 130 120 110 100 90 80 70 60 50 40 30 20 10 0 10 20 30 40 50 60 70 80 90 100 110 120 130 140 150

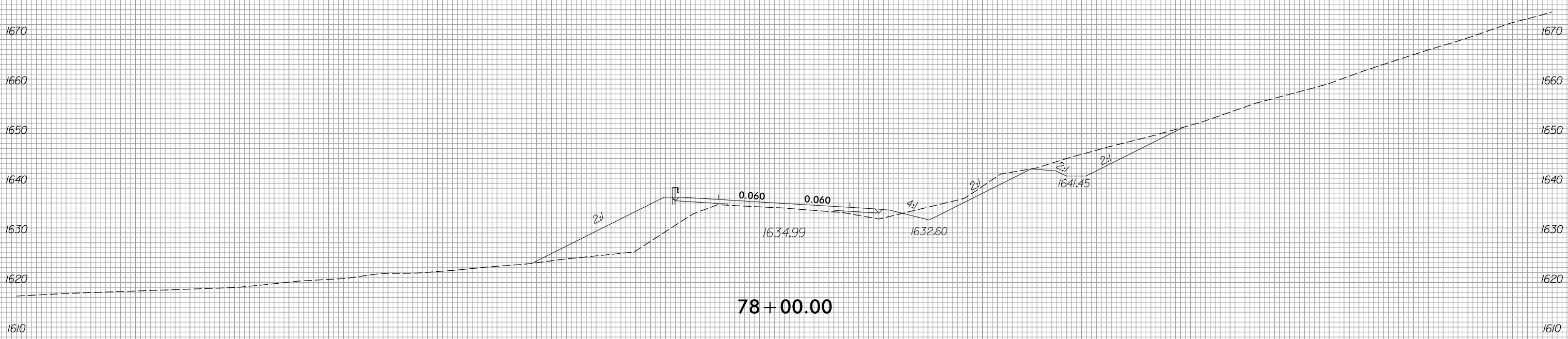



150 140 130 120 110 100 90 80 70 60 50 40 30 20 10 0 10 20 30 40 50 60 70 80 90 100 110 120 130 140 150

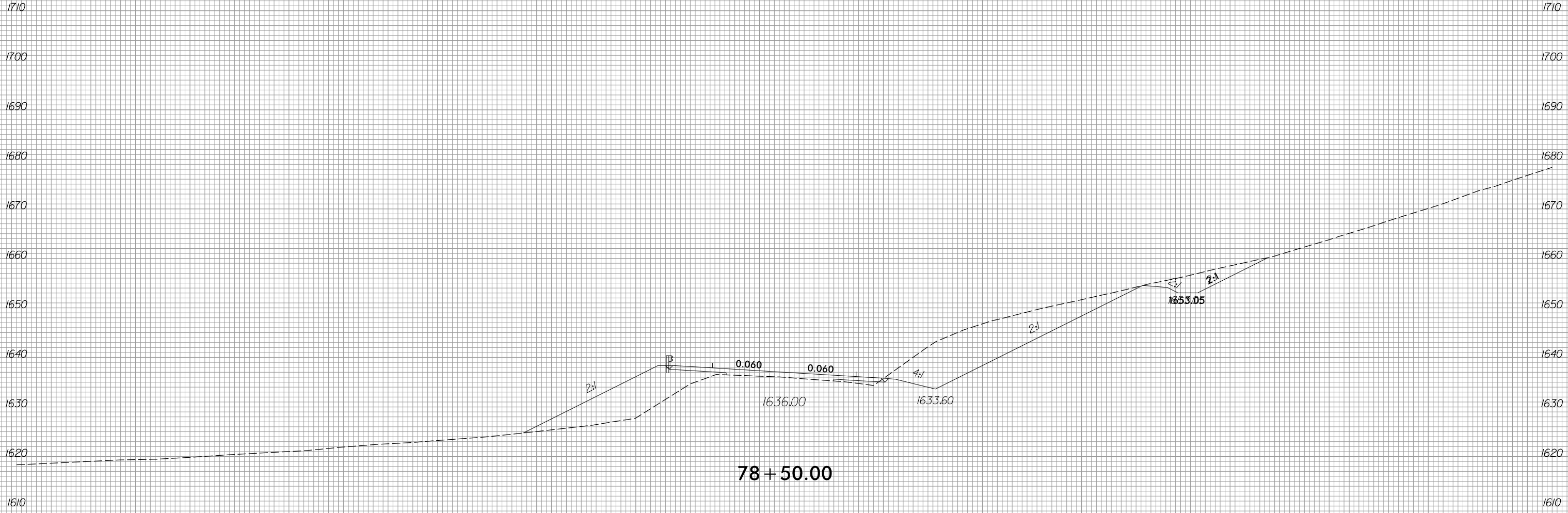

150 140 130 120 110 100 90 80 70 60 50 40 30 20 10 0 10 20 30 40 50 60 70 80 90 100 110 120 130 140 150

6/23/16



PROJ. REFERENCE NO.
R-5861

SHEET NO.
X-75

150 140 130 120 110 100 90 80 70 60 50 40 30 20 10 0 10 20 30 40 50 60 70 80 90 100 110 120 130 140 150

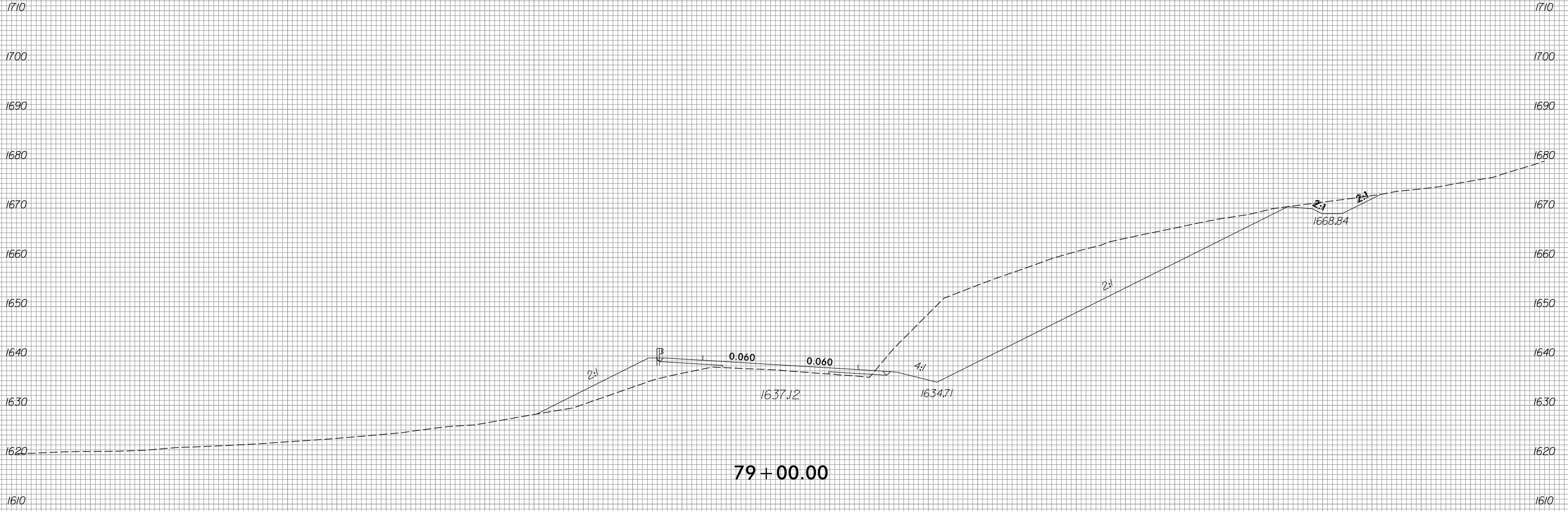

8/3/2023
R:\Roadway\XSC\XPLs\15861_Rd\XPL_L.dgn
P:\mason

150 140 130 120 110 100 90 80 70 60 50 40 30 20 10 0 10 20 30 40 50 60 70 80 90 100 110 120 130 140 150



100 90 80 70 60 50 40 30 20 10 0 10 20 30 40 50 60 70 80 90 100 110 120 130 140 150 160 170 180 190 200



100 90 80 70 60 50 40 30 20 10 0 10 20 30 40 50 60 70 80 90 100 110 120 130 140 150 160 170 180 190 200

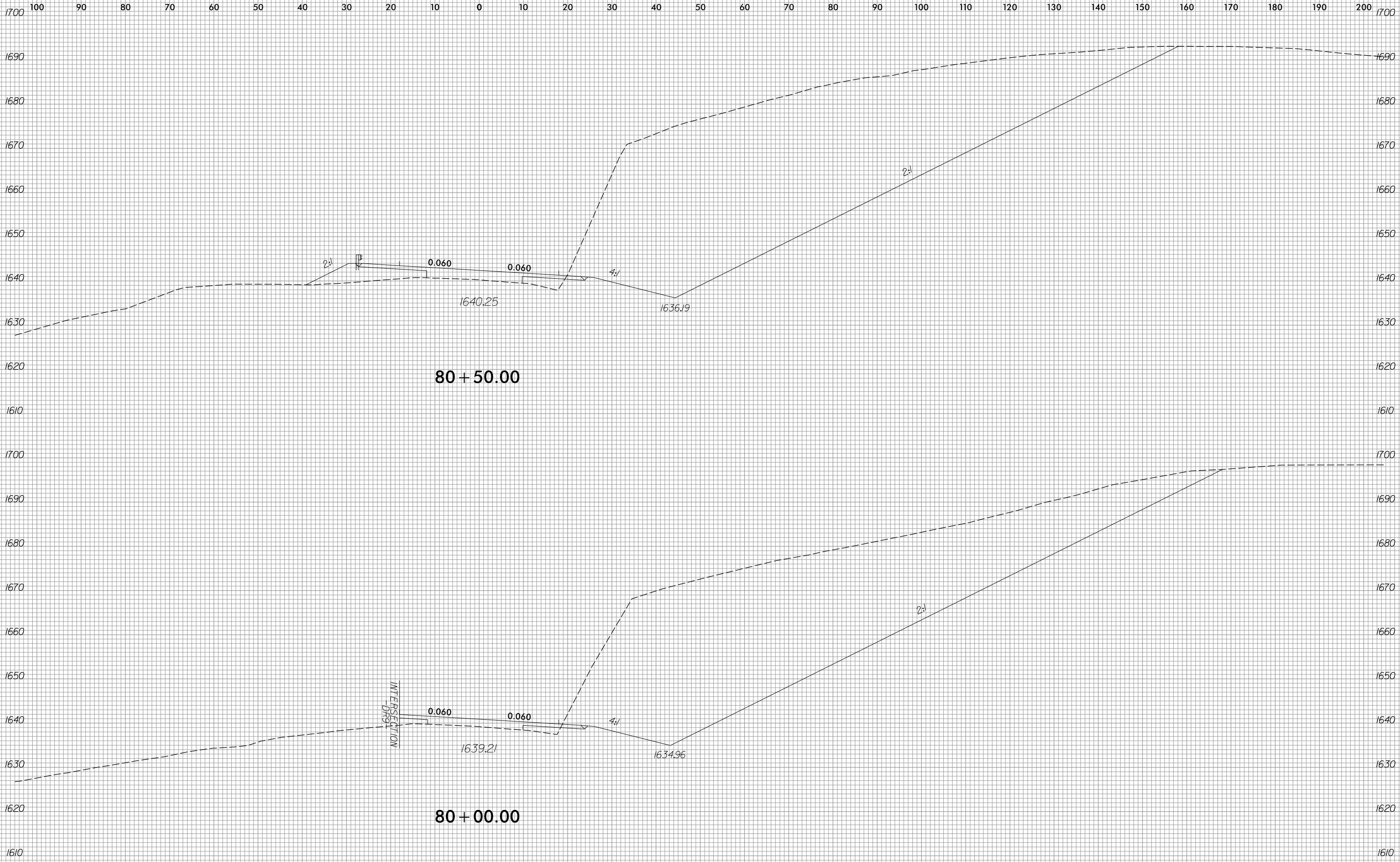
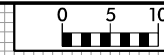



100 90 80 70 60 50 40 30 20 10 0 10 20 30 40 50 60 70 80 90 100 110 120 130 140 150 160 170 180 190 200

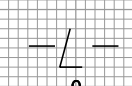
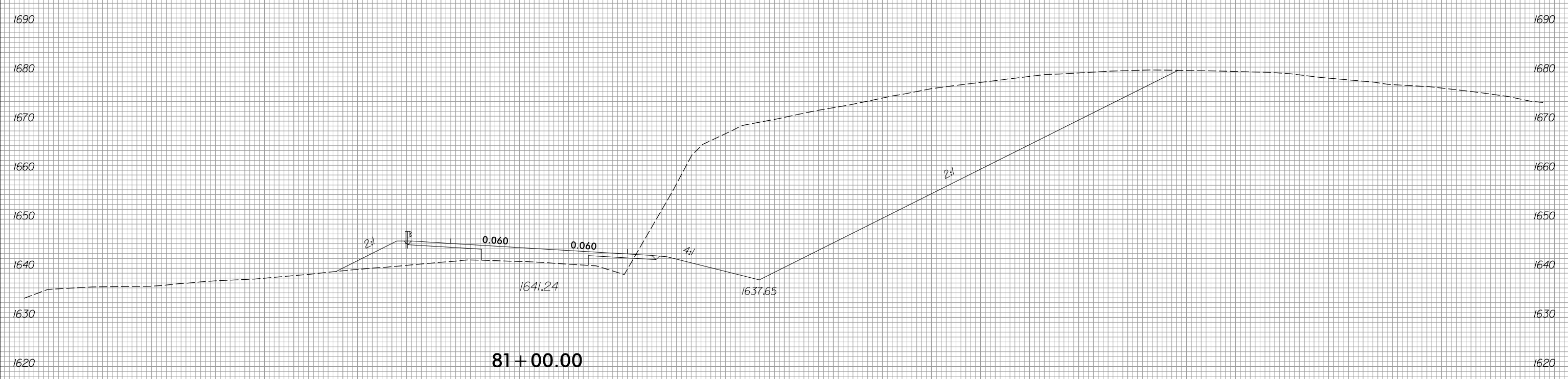

100 90 80 70 60 50 40 30 20 10 0 10 20 30 40 50 60 70 80 90 100 110 120 130 140 150 160 170 180 190 200



150 140 130 120 110 100 90 80 70 60 50 40 30 20 10 0 10 20 30 40 50 60 70 80 90 100 110 120 130 140 150

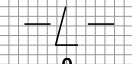
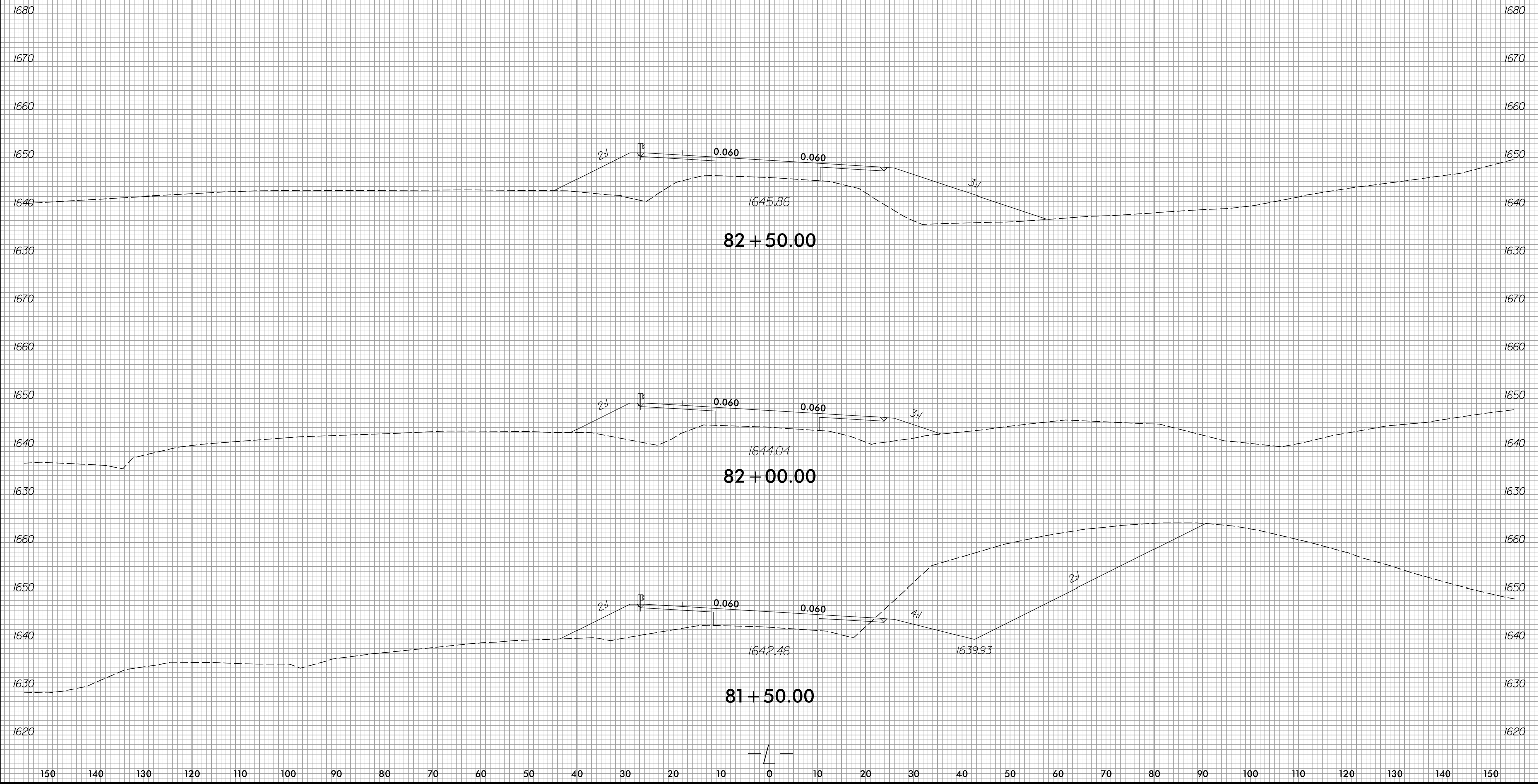



150 140 130 120 110 100 90 80 70 60 50 40 30 20 10 0 10 20 30 40 50 60 70 80 90 100 110 120 130 140 150

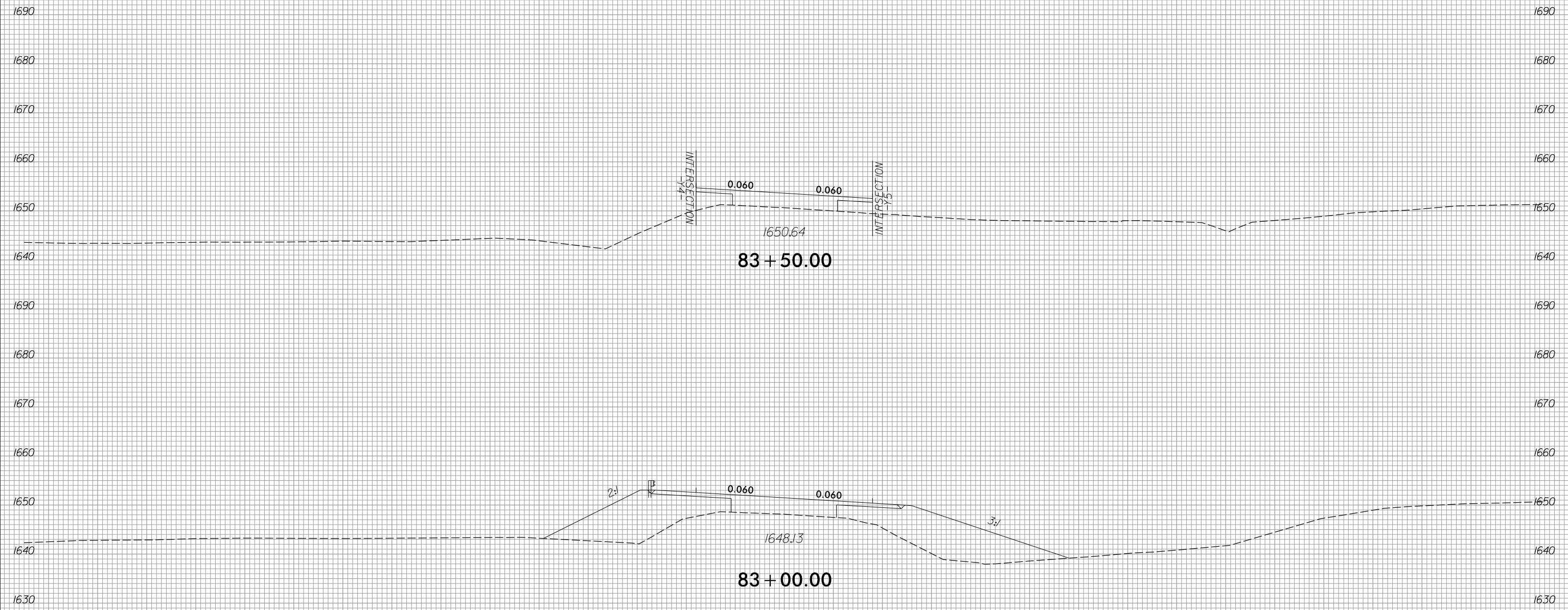

150 140 130 120 110 100 90 80 70 60 50 40 30 20 10 0 10 20 30 40 50 60 70 80 90 100 110 120 130 140 150



150 140 130 120 110 100 90 80 70 60 50 40 30 20 10 0 10 20 30 40 50 60 70 80 90 100 110 120 130 140 150

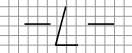
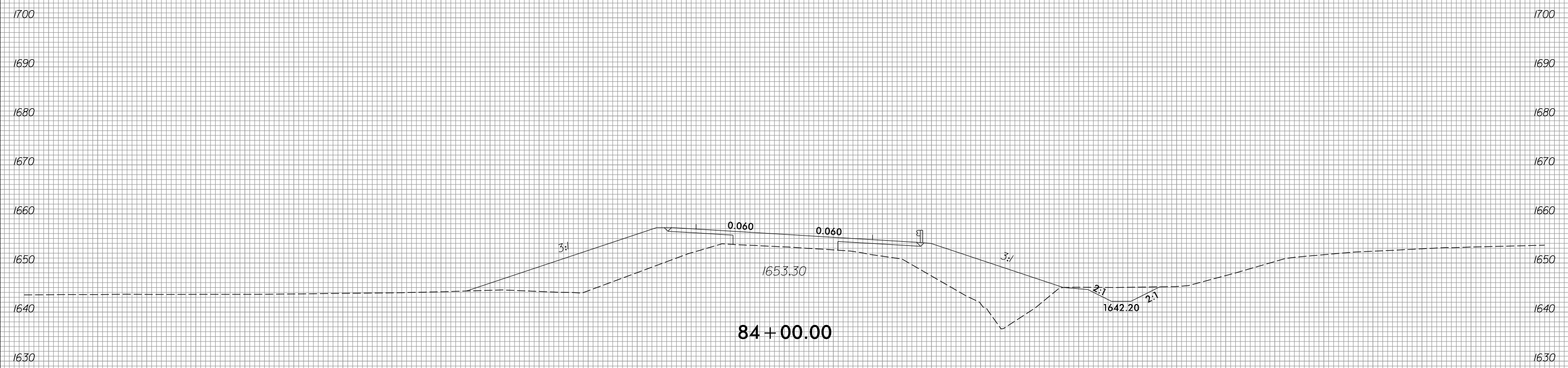
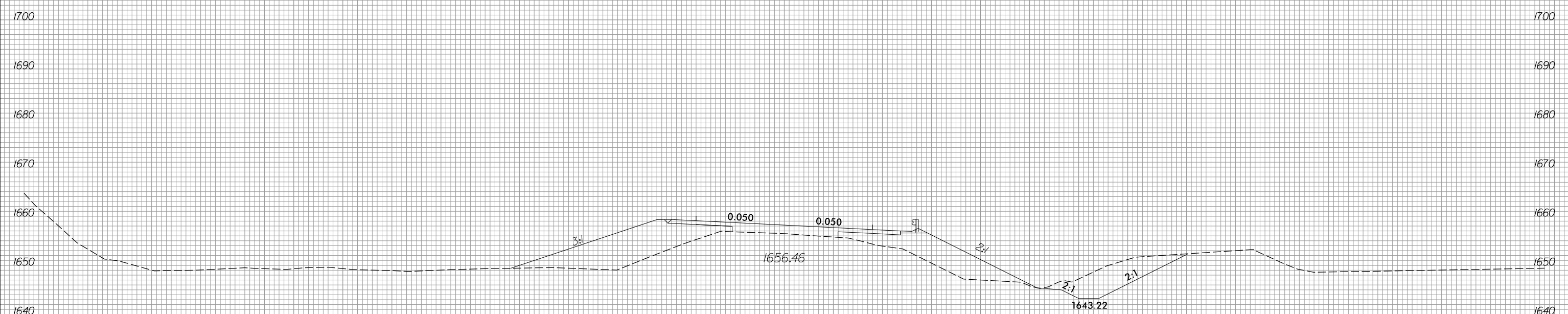

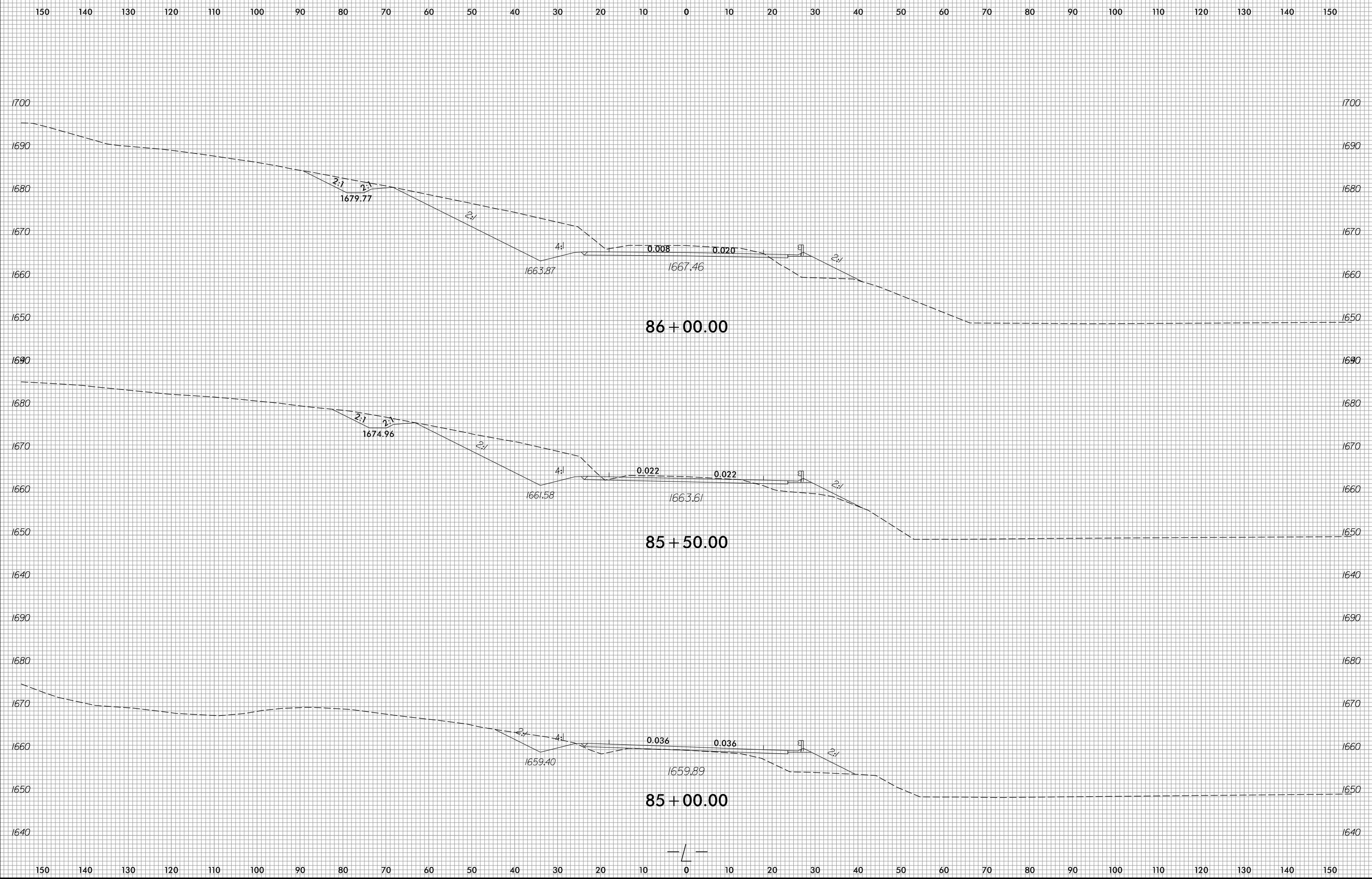



150 140 130 120 110 100 90 80 70 60 50 40 30 20 10 0 10 20 30 40 50 60 70 80 90 100 110 120 130 140 150

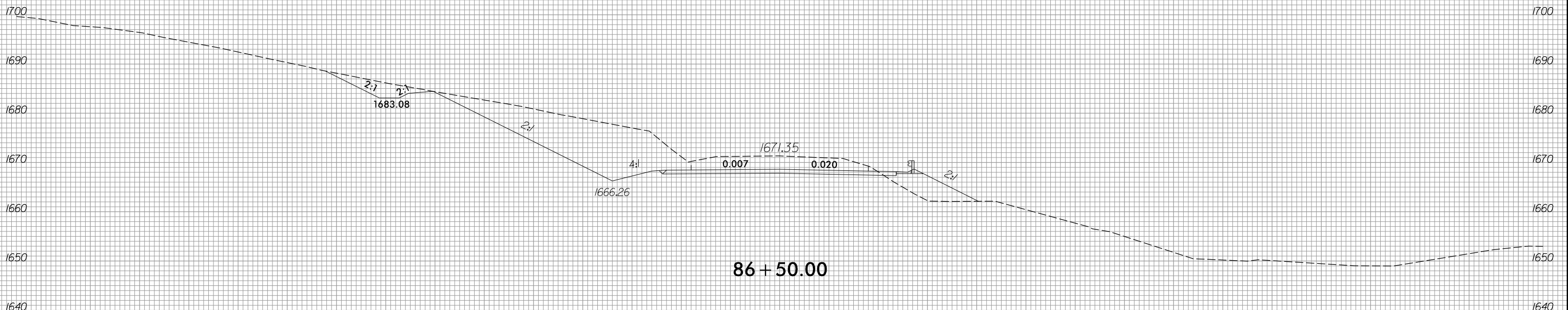
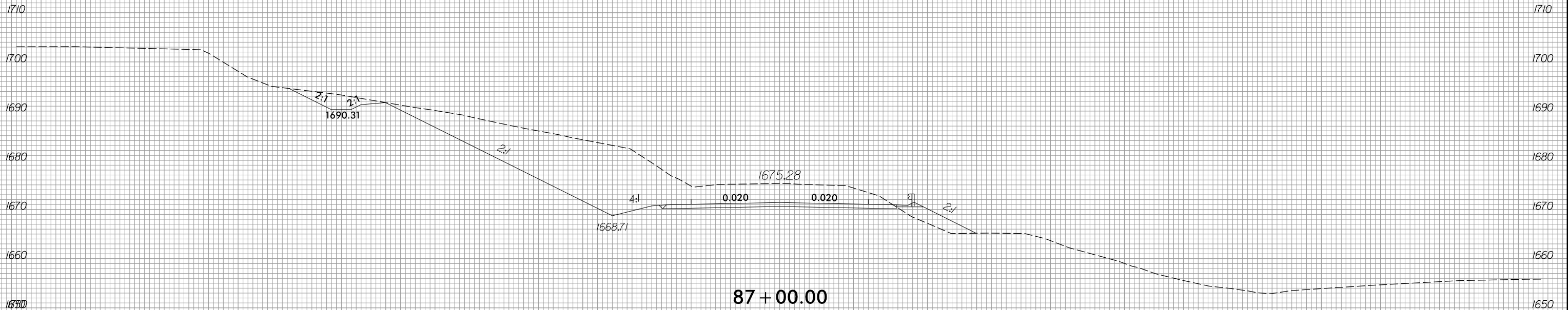



150 140 130 120 110 100 90 80 70 60 50 40 30 20 10 0 10 20 30 40 50 60 70 80 90 100 110 120 130 140 150

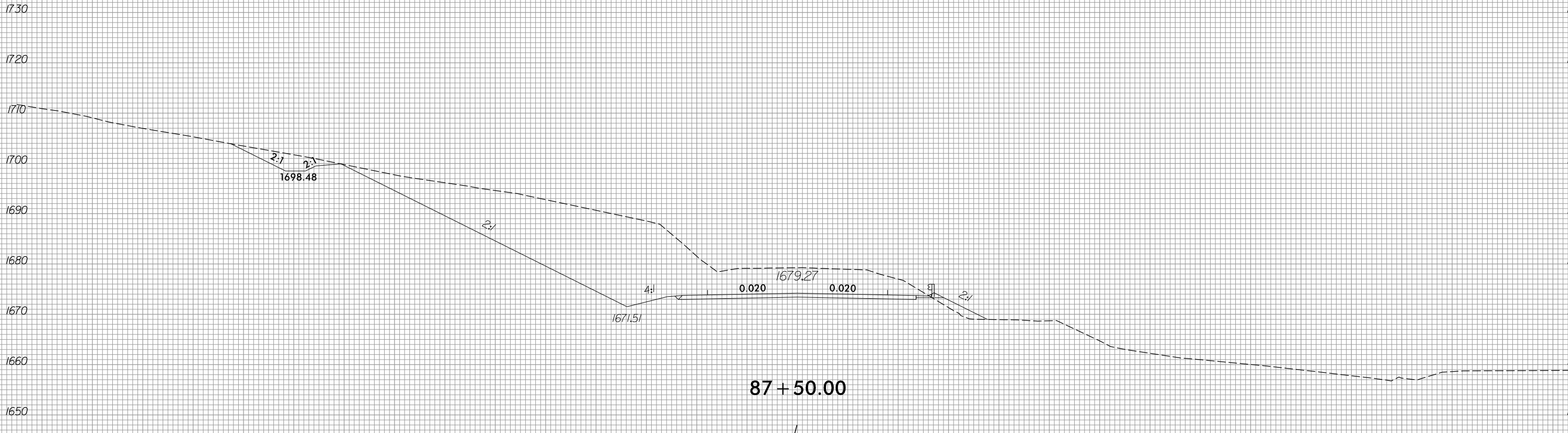
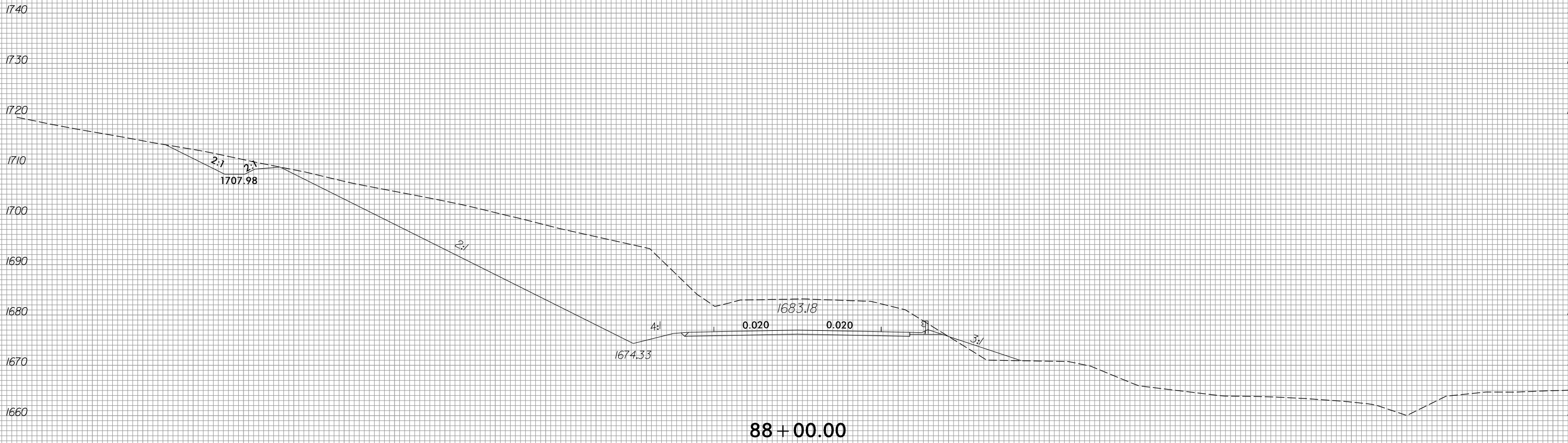

150 140 130 120 110 100 90 80 70 60 50 40 30 20 10 0 10 20 30 40 50 60 70 80 90 100 110 120 130 140 150

8/23/16

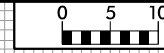

PROJ. REFERENCE NO.
R-5861

SHEET NO.
X-85

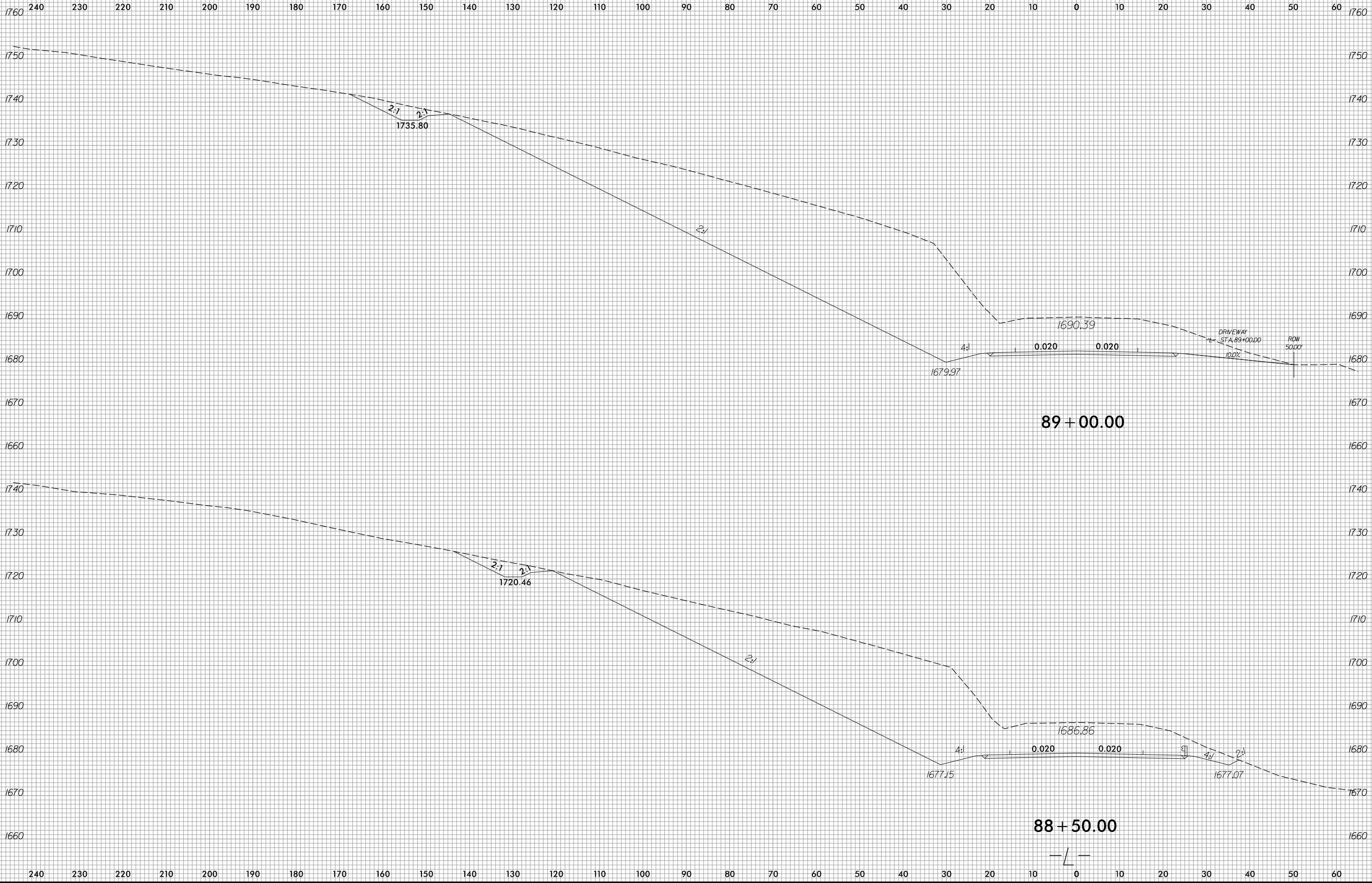

8/3/2023
R:\Roadway\XSC\XPLs\R5861_RdJ_XPL_L.dgn
Pinson



260 250 240 230 220 210 200 190 180 170 160 150 140 130 120 110 100 90 80 70 60 50 40 30 20 10 0 10 20 30 40

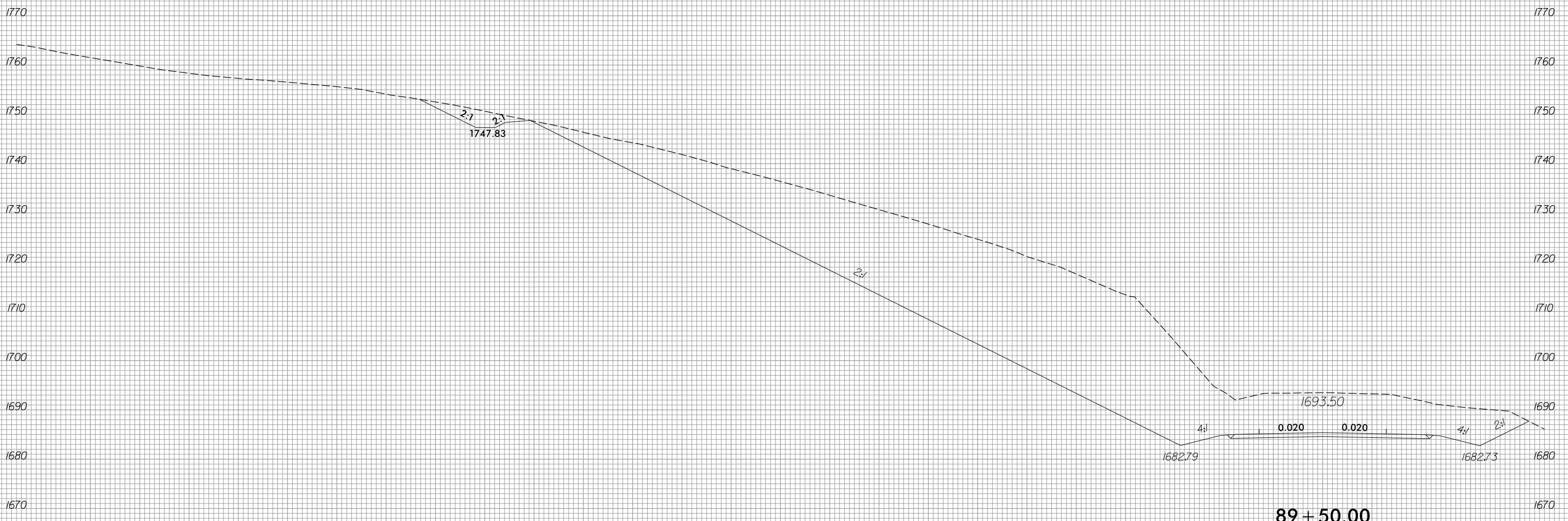

89+50.00

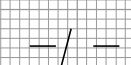

260 250 240 230 220 210 200 190 180 170 160 150 140 130 120 110 100 90 80 70 60 50 40 30 20 10 0 10 20 30 40



260 250 240 230 220 210 200 190 180 170 160 150 140 130 120 110 100 90 80 70 60 50 40 30 20 10 0 10 20 30 40

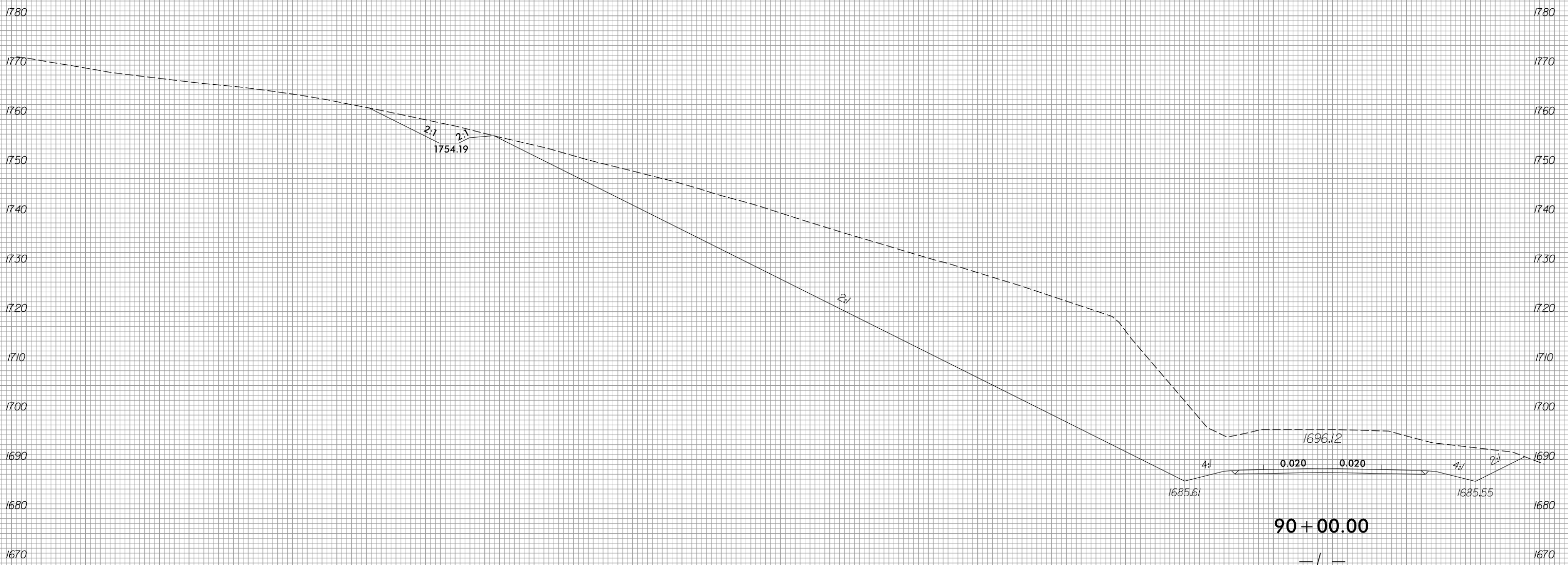

260 250 240 230 220 210 200 190 180 170 160 150 140 130 120 110 100 90 80 70 60 50 40 30 20 10 0 10 20 30 40

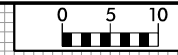

260 250 240 230 220 210 200 190 180 170 160 150 140 130 120 110 100 90 80 70 60 50 40 30 20 10 0 10 20 30 40

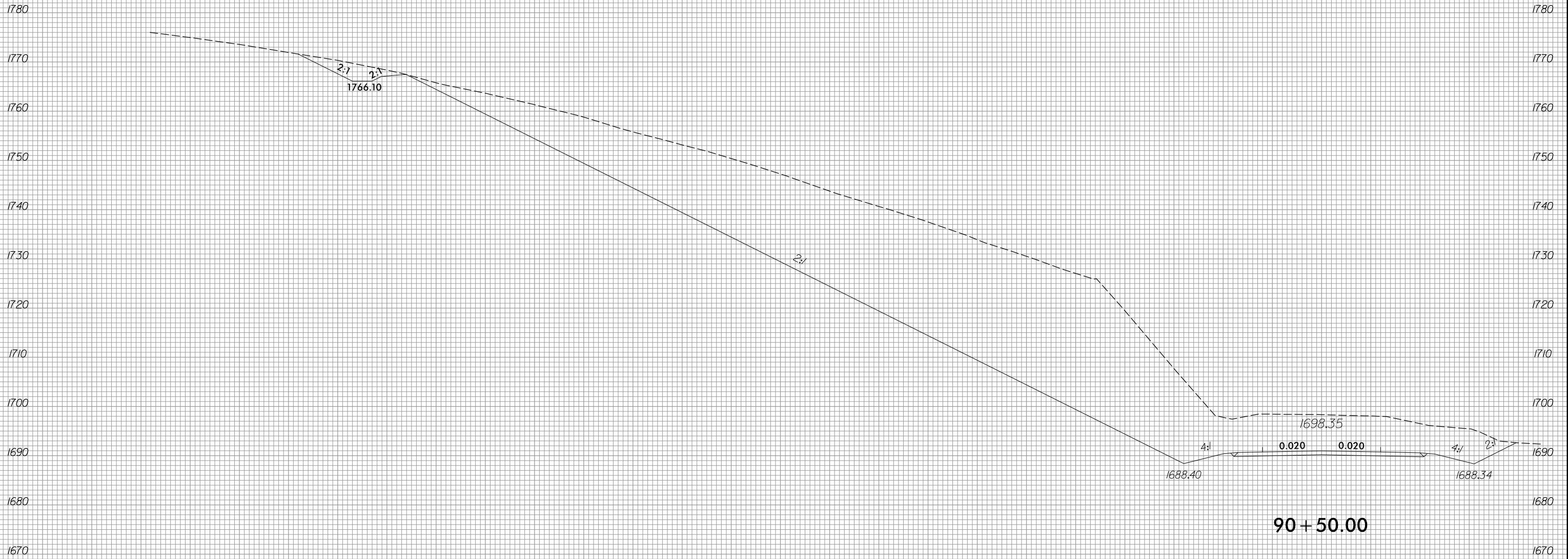

260 250 240 230 220 210 200 190 180 170 160 150 140 130 120 110 100 90 80 70 60 50 40 30 20 10 0 10 20 30 40

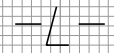

6/23/16

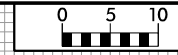

PROJ. REFERENCE NO.	SHEET NO.
R-5861	X-89

260 250 240 230 220 210 200 190 180 170 160 150 140 130 120 110 100 90 80 70 60 50 40 30 20 10 0 10 20 30 40

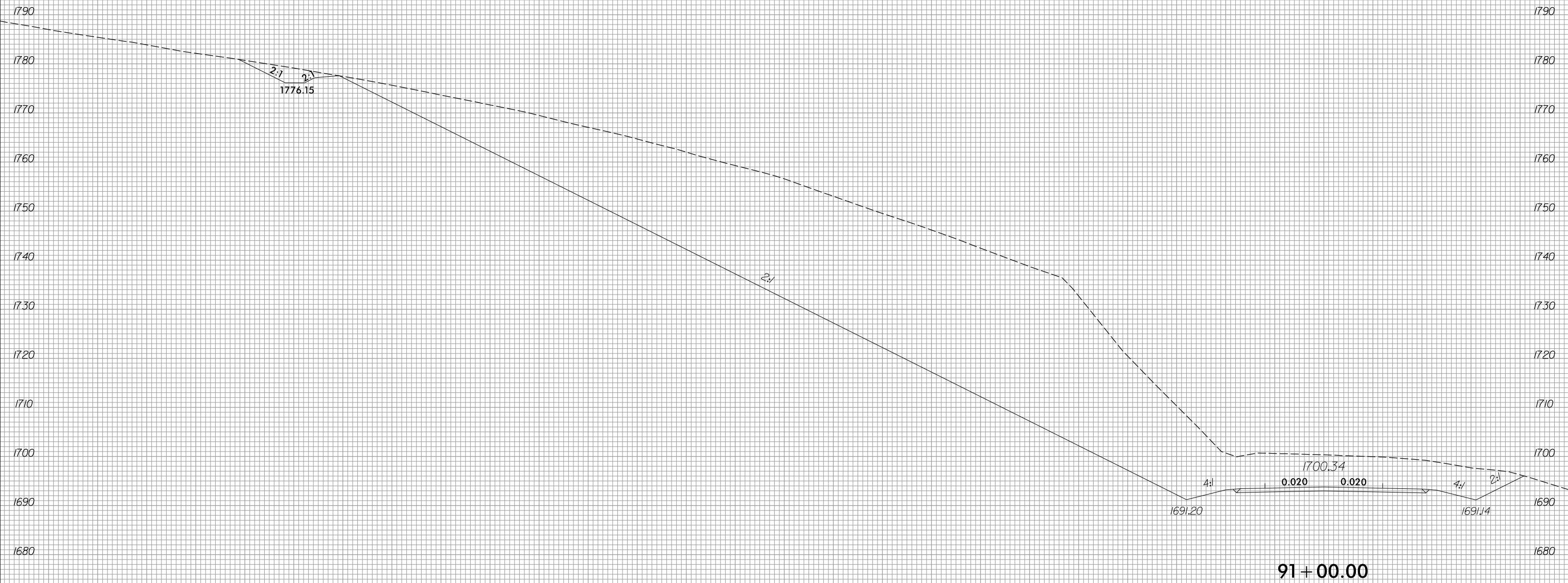

8/3/2023
 R:\Roadway\XSC\XPLs\15861_Rd\XPL_L.dgn
 P:\mason

260 250 240 230 220 210 200 190 180 170 160 150 140 130 120 110 100 90 80 70 60 50 40 30 20 10 0 10 20 30 40

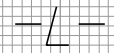

6/23/16

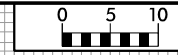

PROJ. REFERENCE NO. R-5861

SHEET NO. X-90

260 250 240 230 220 210 200 190 180 170 160 150 140 130 120 110 100 90 80 70 60 50 40 30 20 10 0 10 20 30 40

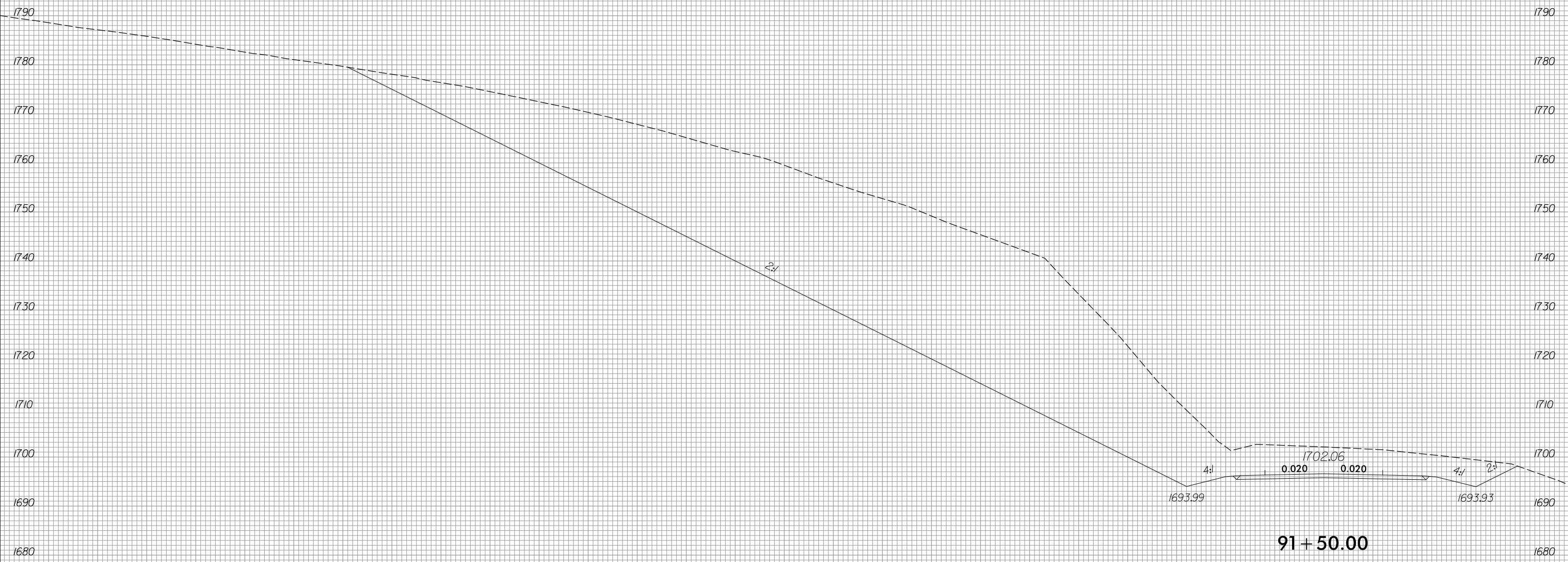

91 + 50.00

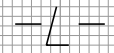

8/3/2023
R:\Roadway\XSC\XPLs\R5861_RdJ_XPL_L.dgn
P:\mason

8/23/16

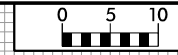

PROJ. REFERENCE NO. R-5861

SHEET NO. X-91

260 250 240 230 220 210 200 190 180 170 160 150 140 130 120 110 100 90 80 70 60 50 40 30 20 10 0 10 20 30 40

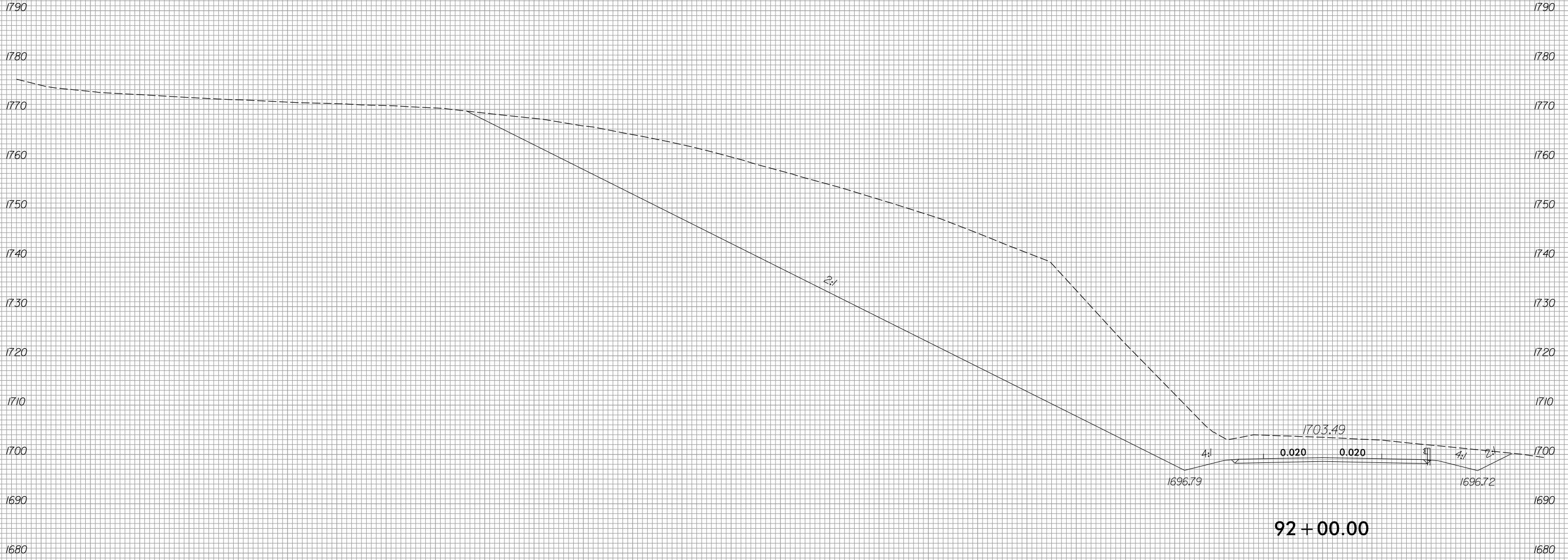

8/3/2023
R:\Roadway\XSC\XPLs\R5861_Rd\XPL_L.dgn
Pinson

260 250 240 230 220 210 200 190 180 170 160 150 140 130 120 110 100 90 80 70 60 50 40 30 20 10 0 10 20 30 40

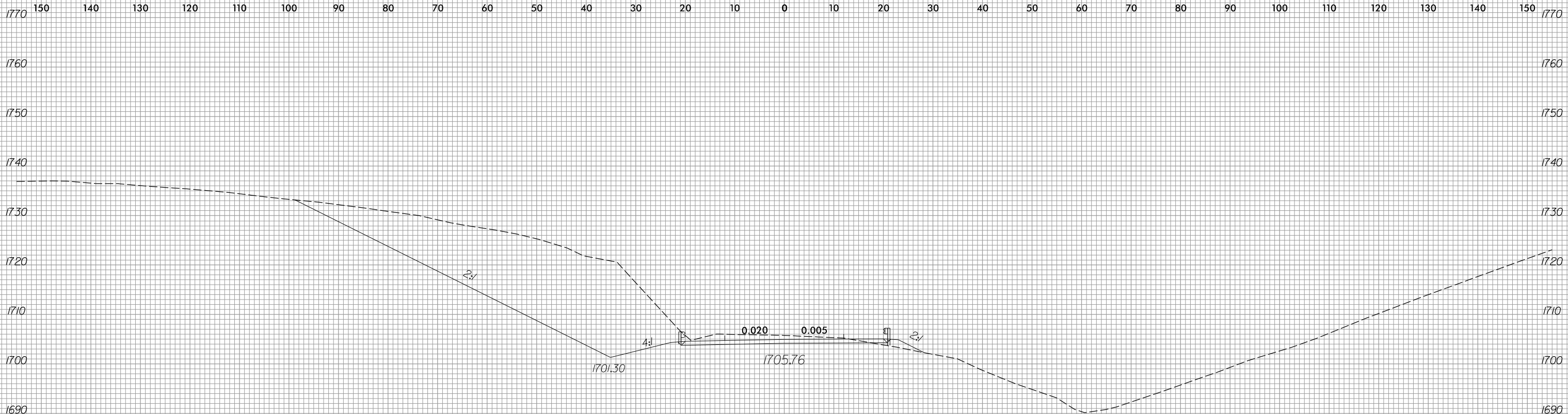
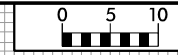

93 + 00.00

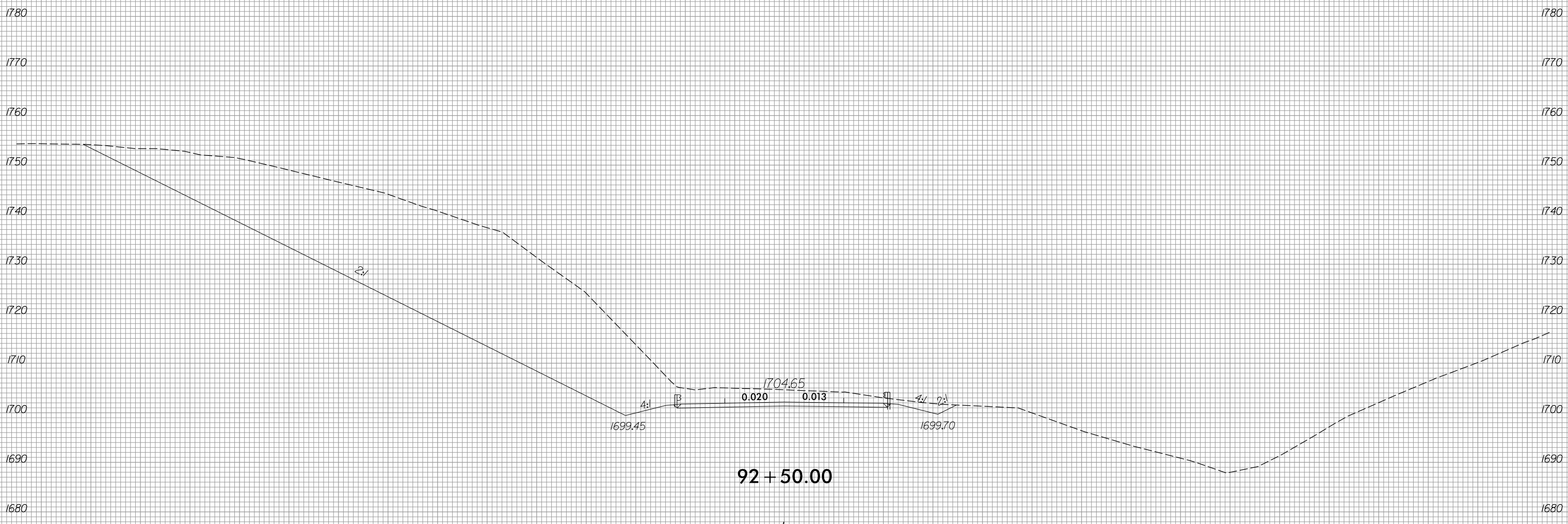

92 + 50.00





150 140 130 120 110 100 90 80 70 60 50 40 30 20 10 0 10 20 30 40 50 60 70 80 90 100 110 120 130 140 150

1770 1770

1760 1760

1750 1750

1740 1740

1730 1730

1720 1720

1710 1710

1700 1700

1690 1690

1770 1770

1760 1760

1750 1750

1740 1740

1730 1730

1720 1720

1710 1710

1700 1700

1690 1690

150 140 130 120 110 100 90 80 70 60 50 40 30 20 10 0 10 20 30 40 50 60 70 80 90 100 110 120 130 140 150

94 + 00.00

93 + 50.00

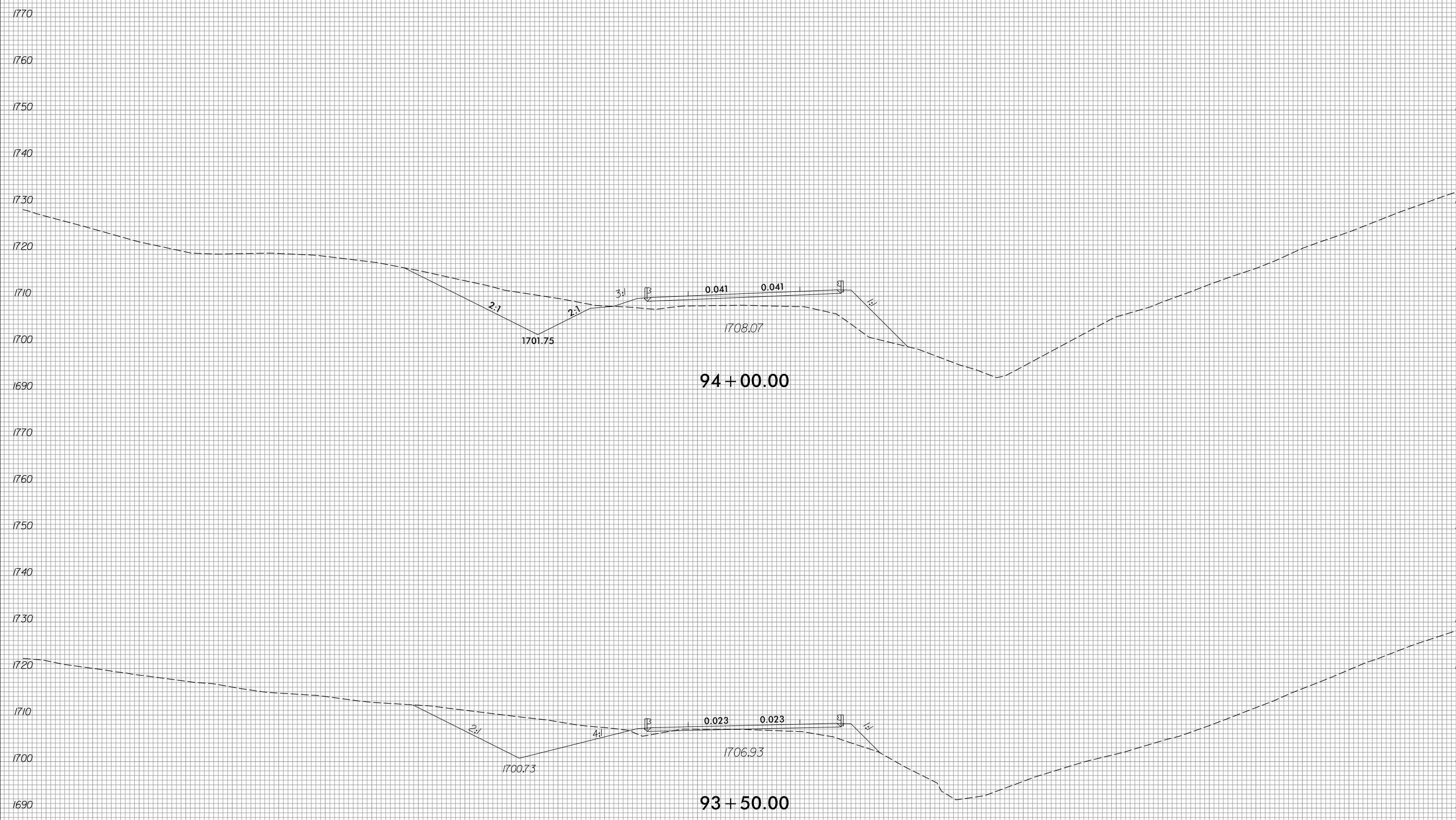
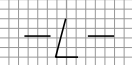



150 140 130 120 110 100 90 80 70 60 50 40 30 20 10 0 10 20 30 40 50 60 70 80 90 100 110 120 130 140 150

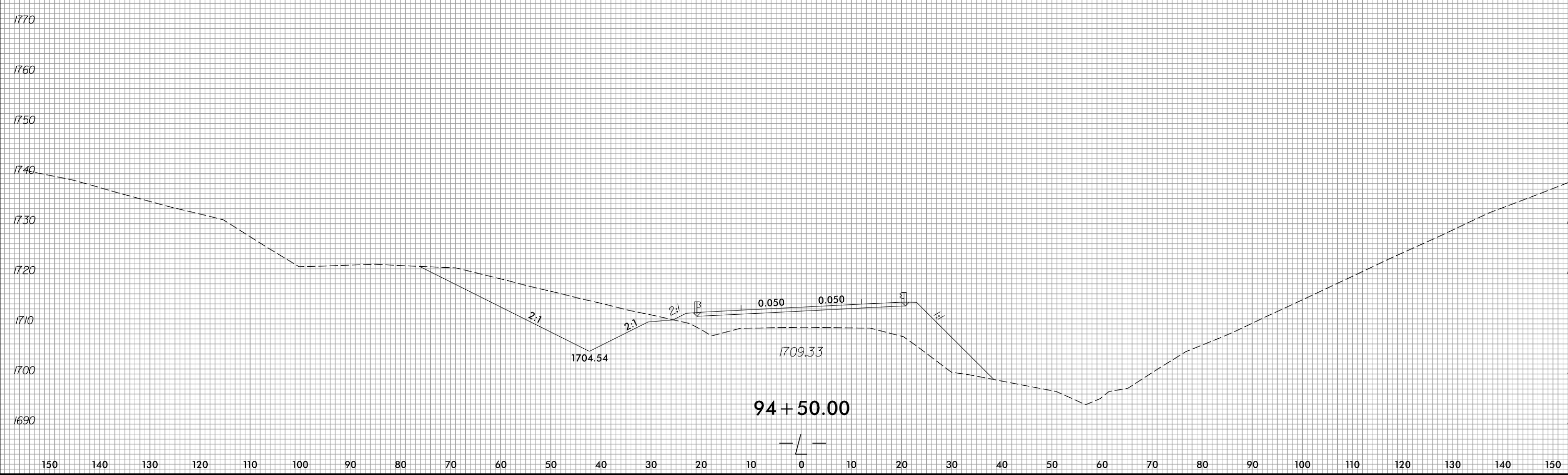
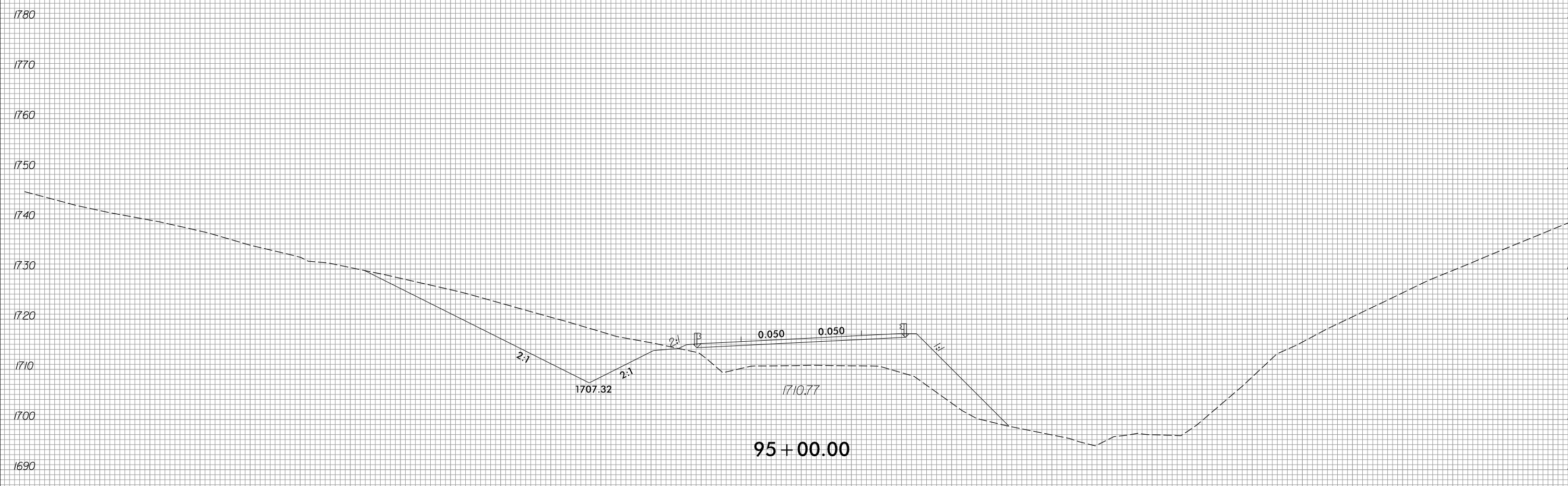



150 140 130 120 110 100 90 80 70 60 50 40 30 20 10 0 10 20 30 40 50 60 70 80 90 100 110 120 130 140 150

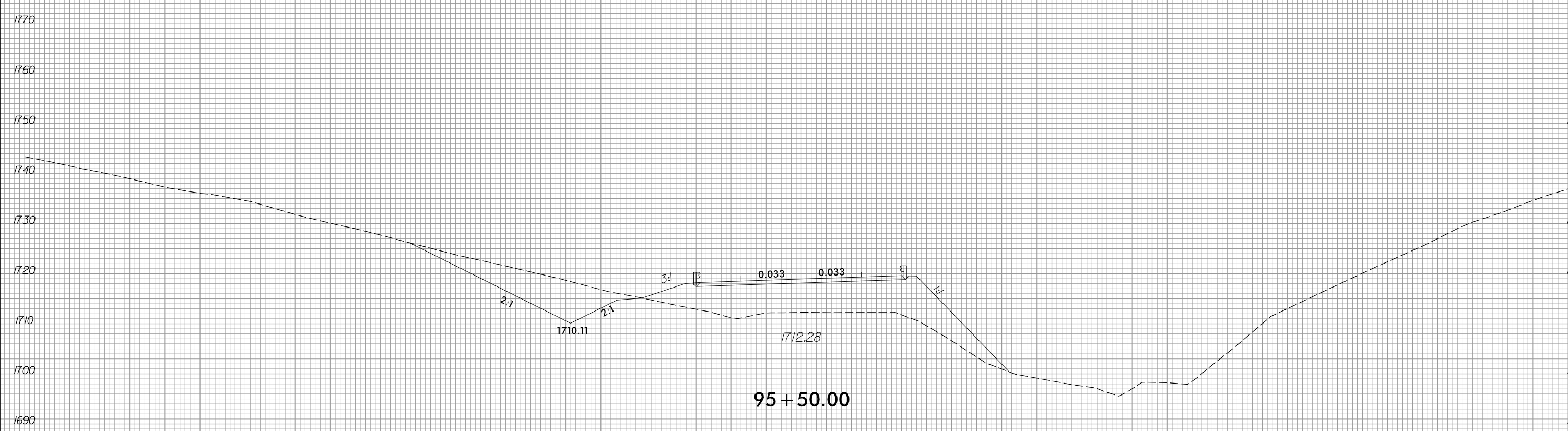
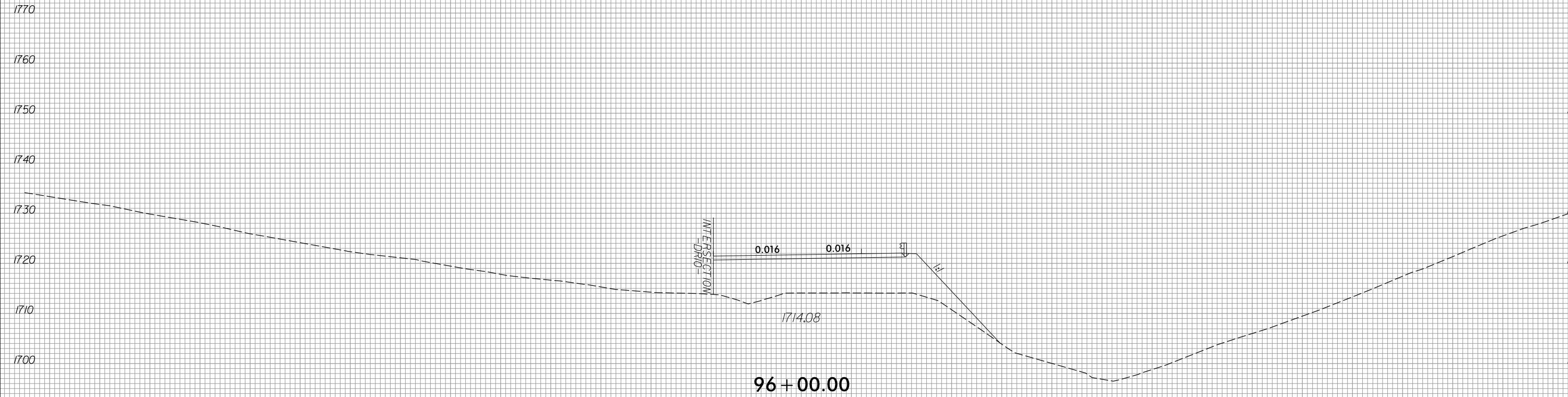

150 140 130 120 110 100 90 80 70 60 50 40 30 20 10 0 10 20 30 40 50 60 70 80 90 100 110 120 130 140 150

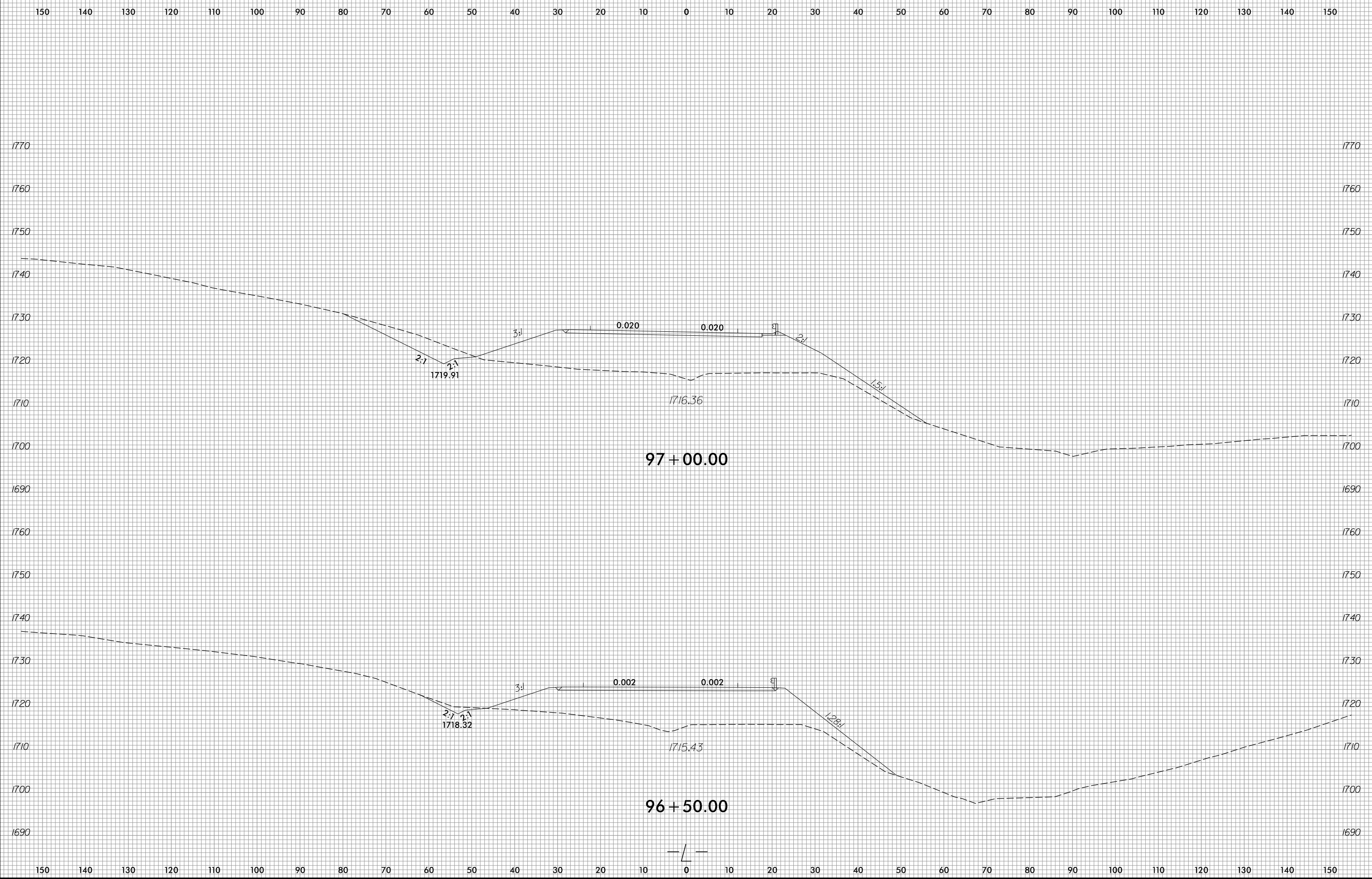



150 140 130 120 110 100 90 80 70 60 50 40 30 20 10 0 10 20 30 40 50 60 70 80 90 100 110 120 130 140 150

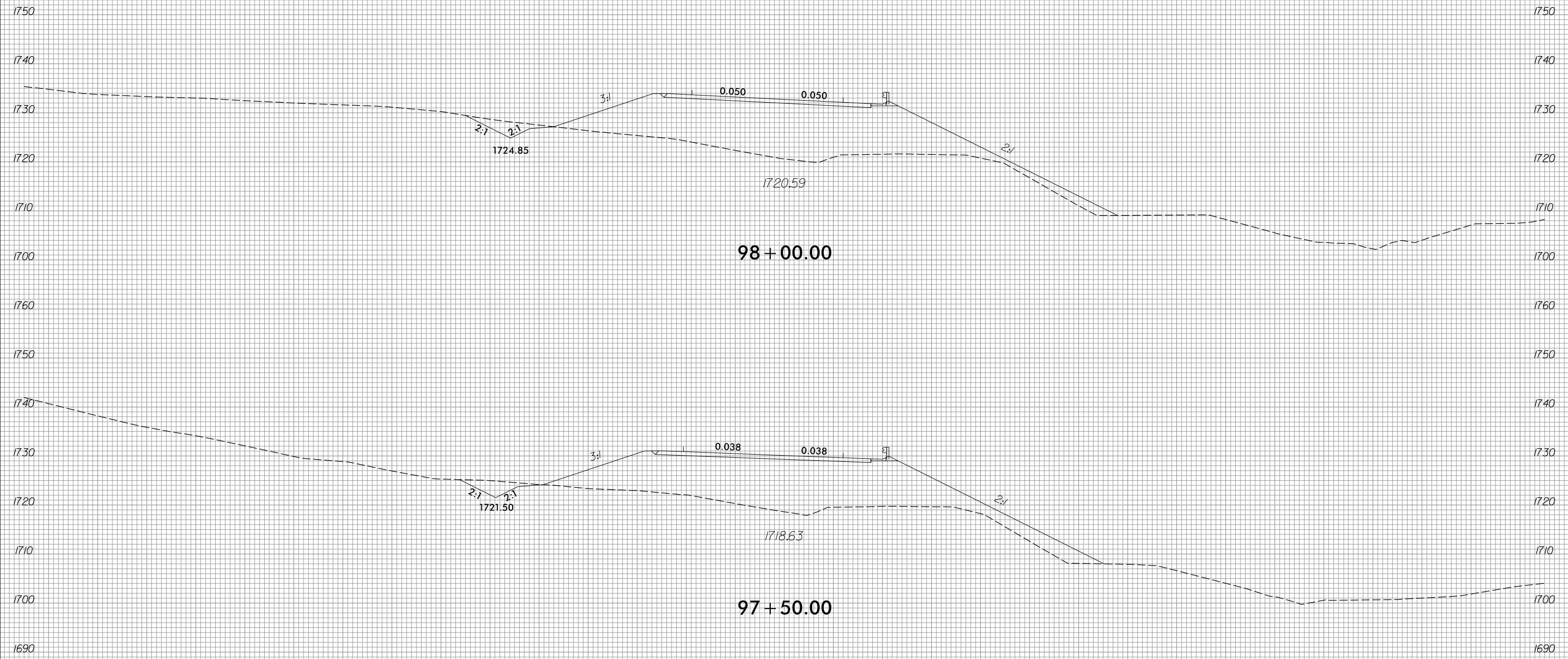

150 140 130 120 110 100 90 80 70 60 50 40 30 20 10 0 10 20 30 40 50 60 70 80 90 100 110 120 130 140 150

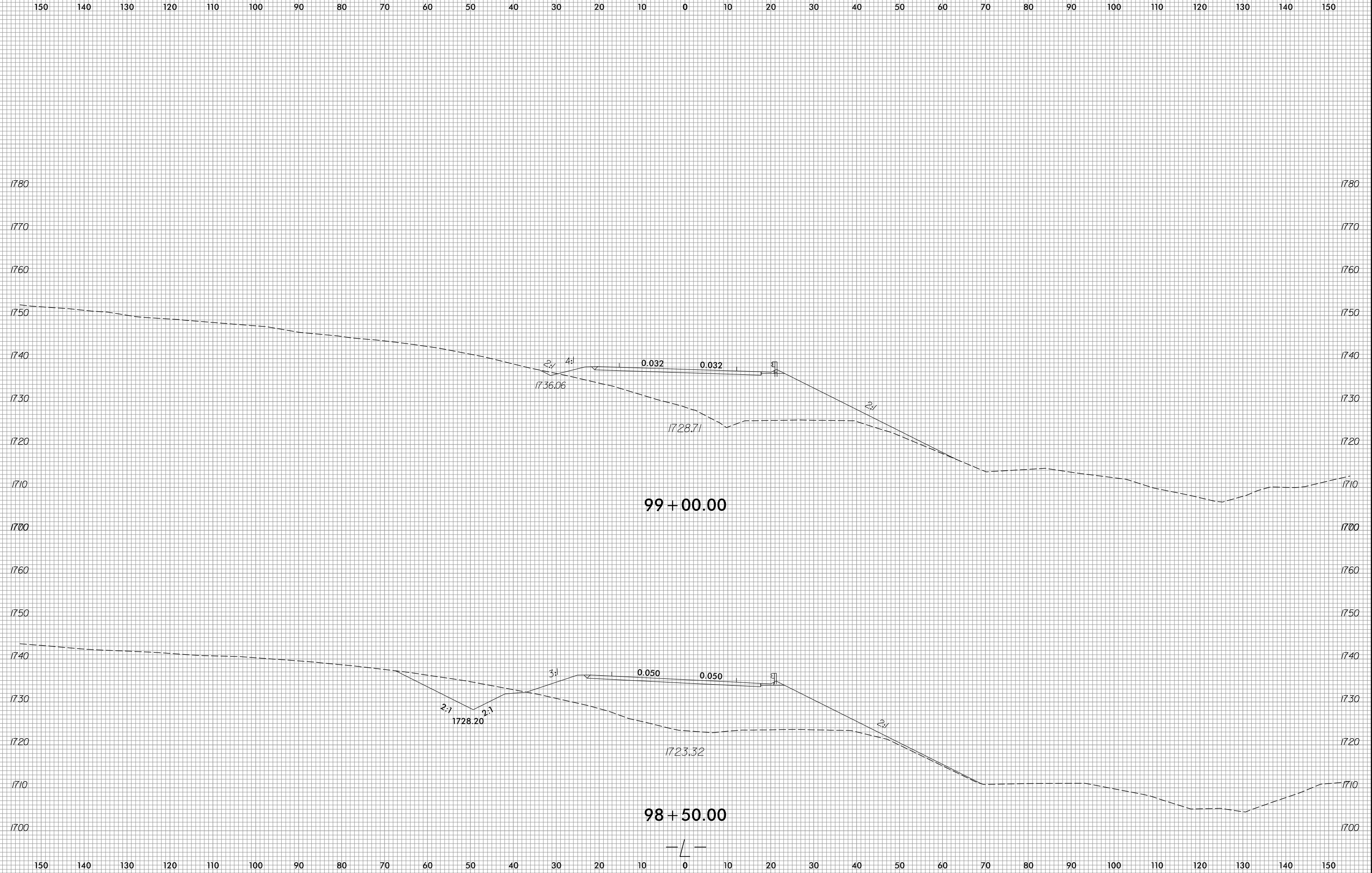
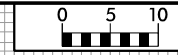



150 140 130 120 110 100 90 80 70 60 50 40 30 20 10 0 10 20 30 40 50 60 70 80 90 100 110 120 130 140 150

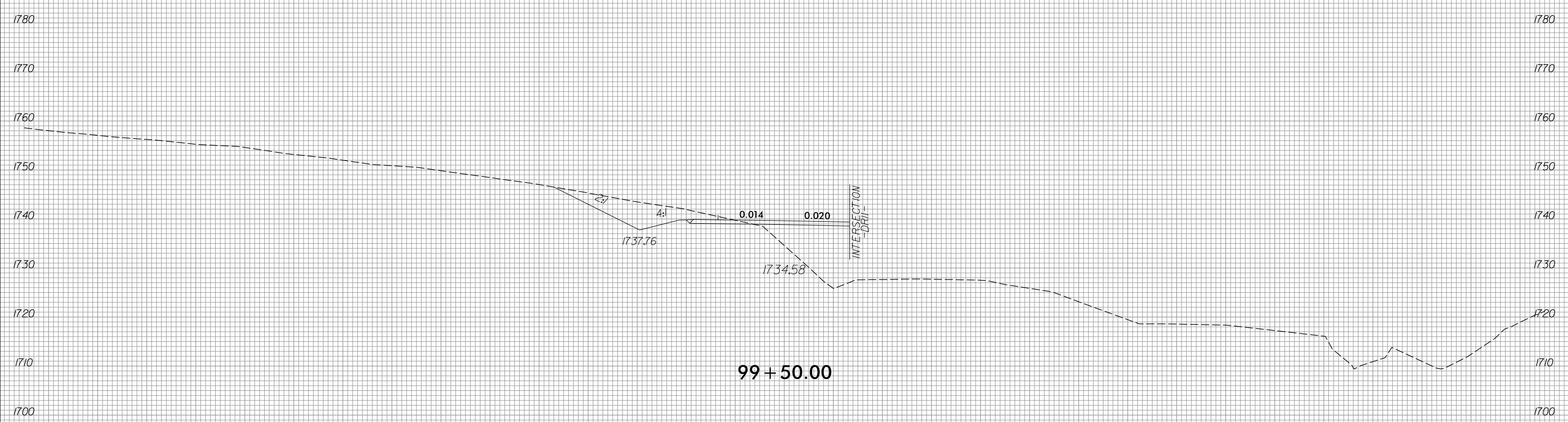
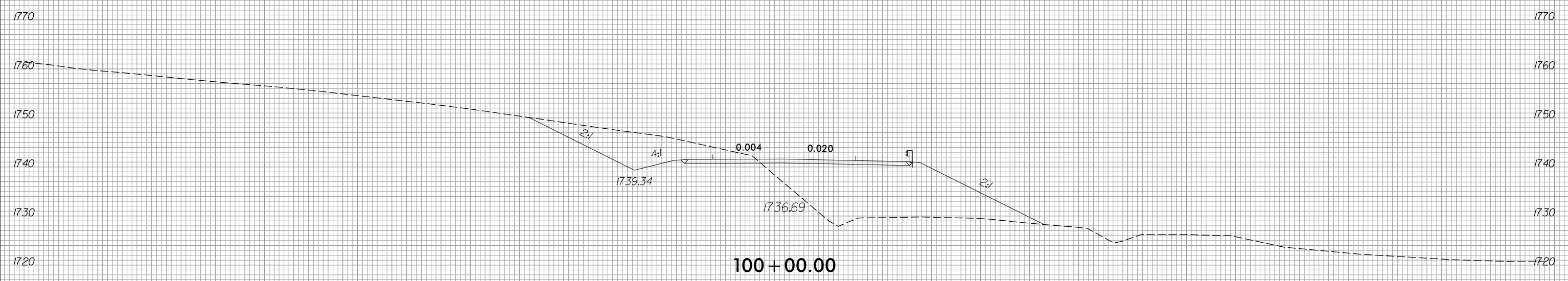

150 140 130 120 110 100 90 80 70 60 50 40 30 20 10 0 10 20 30 40 50 60 70 80 90 100 110 120 130 140 150



150 140 130 120 110 100 90 80 70 60 50 40 30 20 10 0 10 20 30 40 50 60 70 80 90 100 110 120 130 140 150

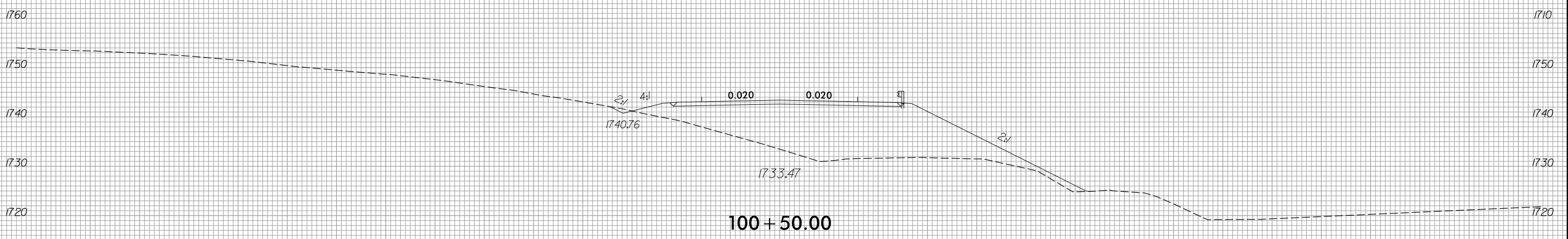
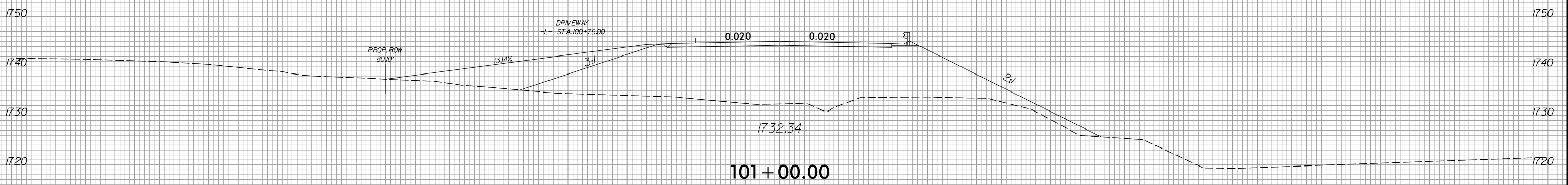
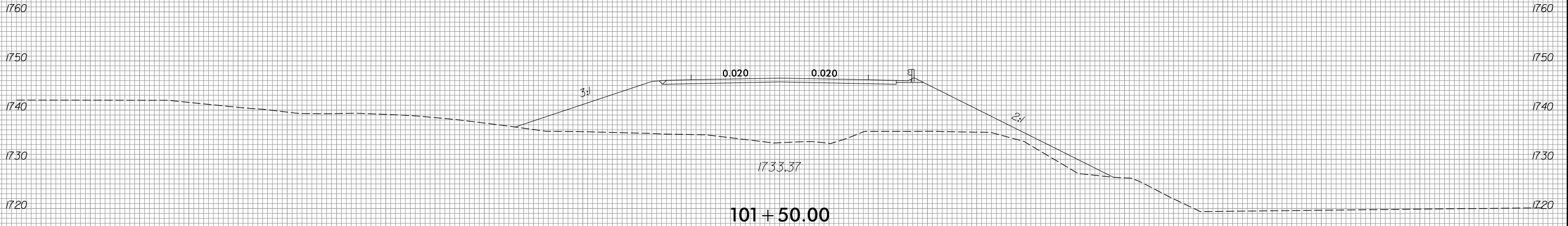

150 140 130 120 110 100 90 80 70 60 50 40 30 20 10 0 10 20 30 40 50 60 70 80 90 100 110 120 130 140 150

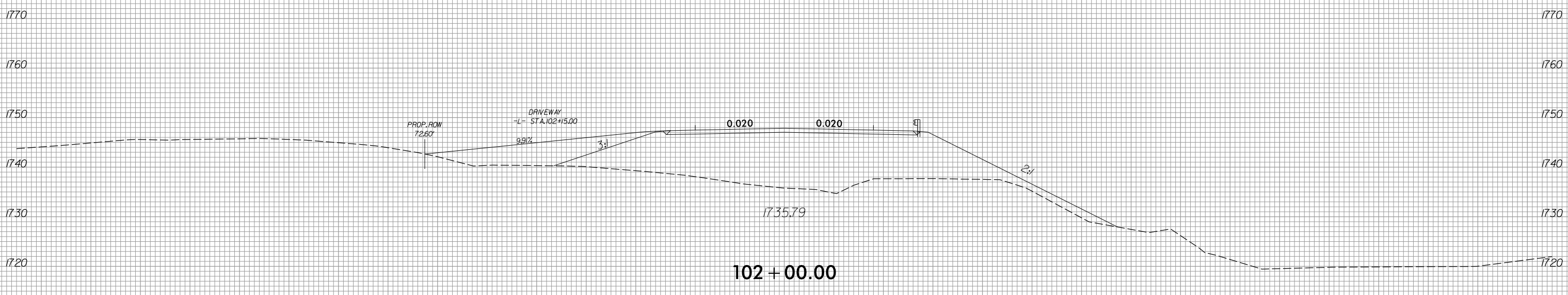
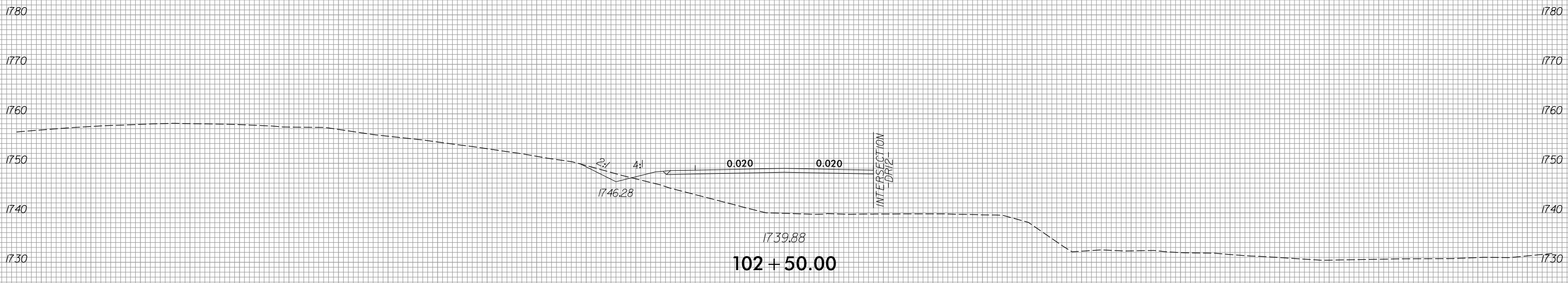
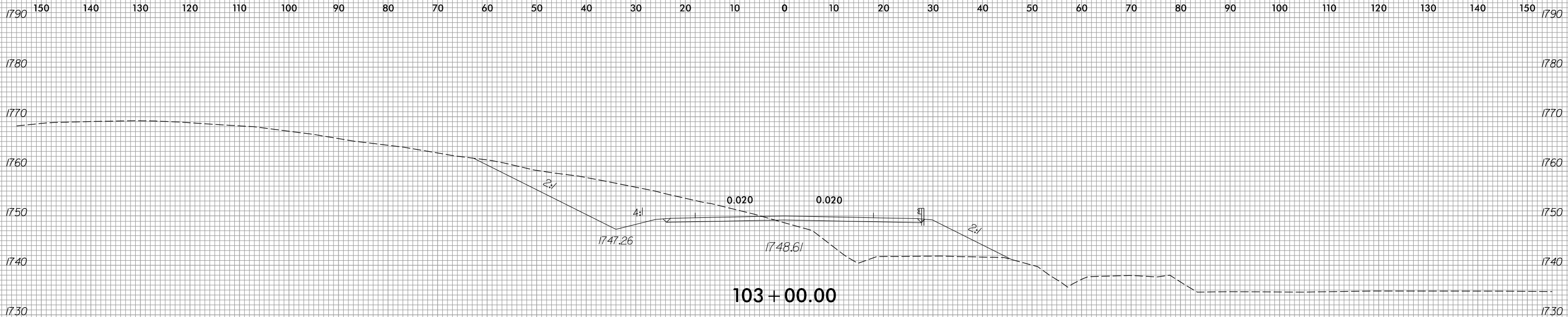



150 140 130 120 110 100 90 80 70 60 50 40 30 20 10 0 10 20 30 40 50 60 70 80 90 100 110 120 130 140 150

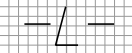
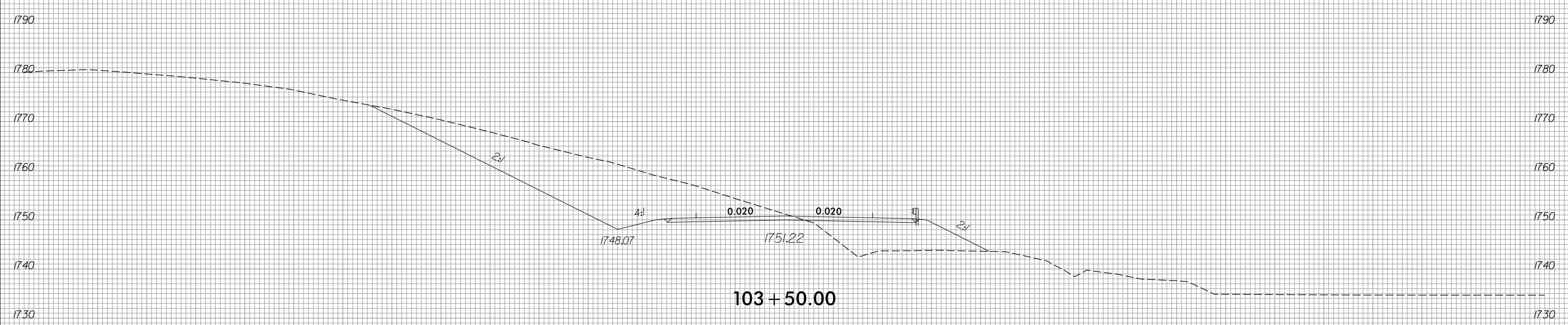
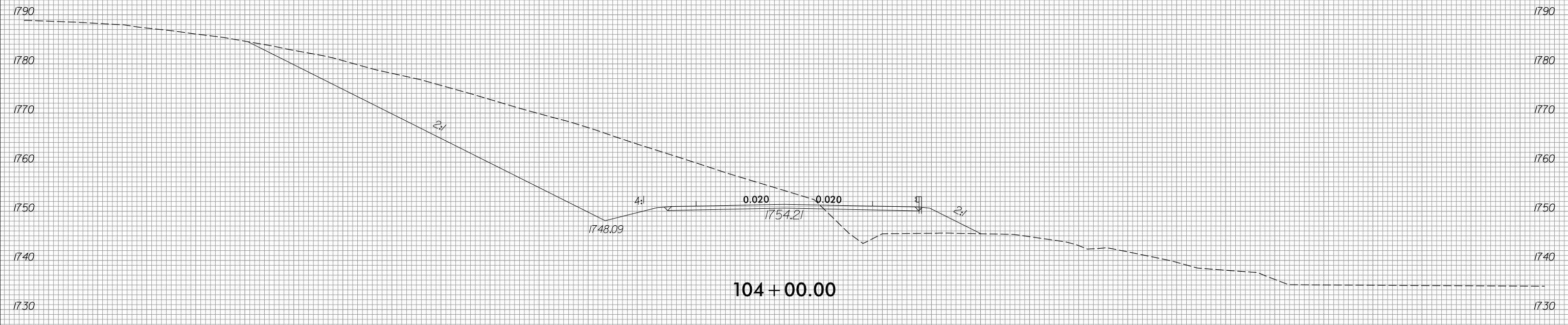



150 140 130 120 110 100 90 80 70 60 50 40 30 20 10 0 10 20 30 40 50 60 70 80 90 100 110 120 130 140 150

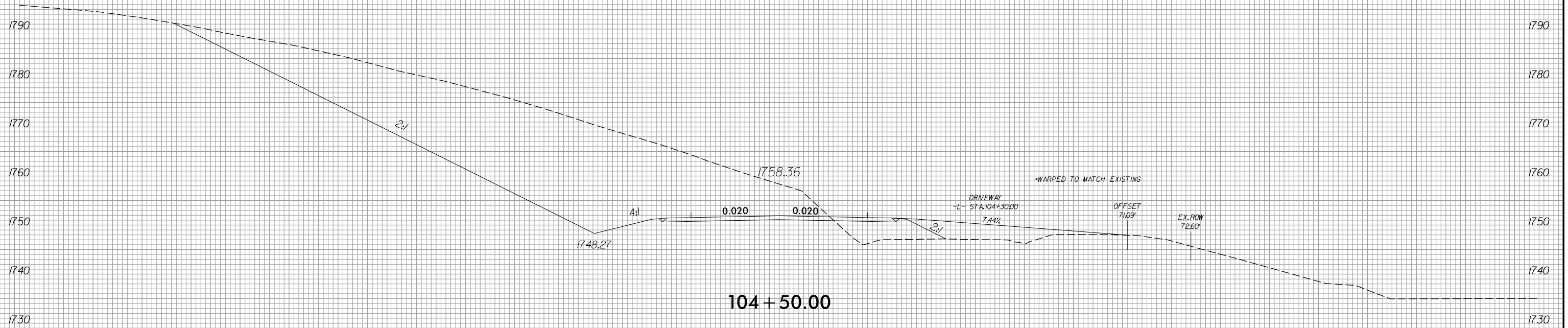
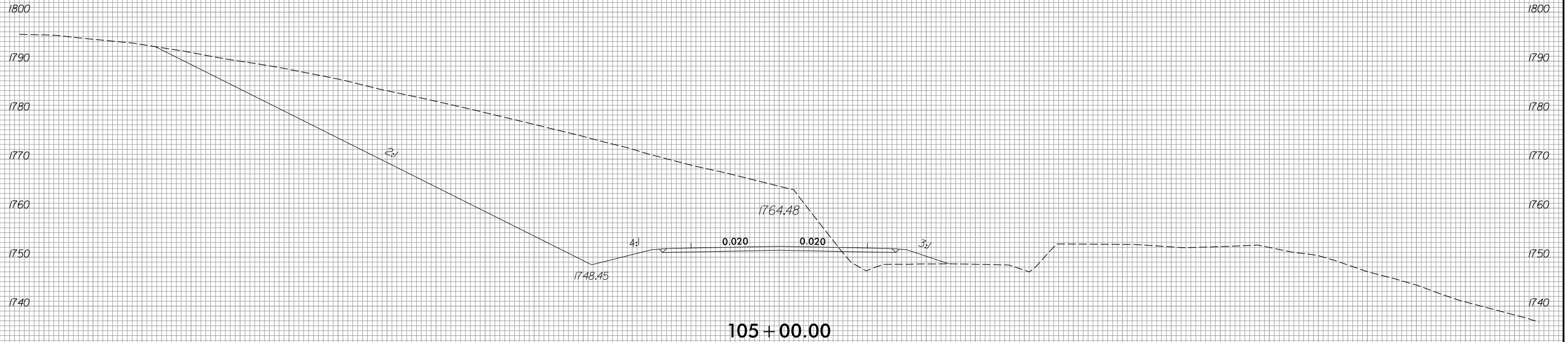

150 140 130 120 110 100 90 80 70 60 50 40 30 20 10 0 10 20 30 40 50 60 70 80 90 100 110 120 130 140 150

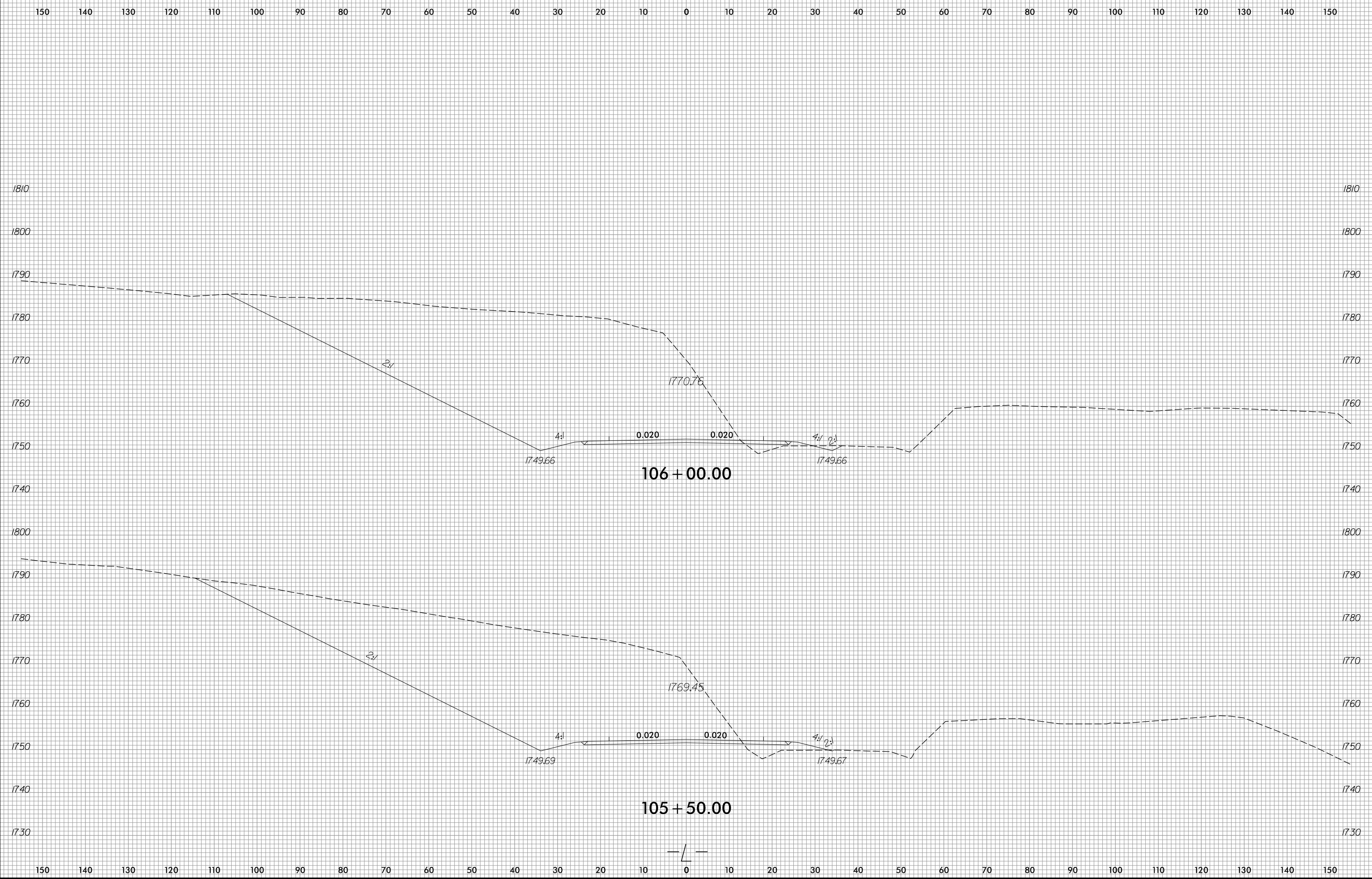



150 140 130 120 110 100 90 80 70 60 50 40 30 20 10 0 10 20 30 40 50 60 70 80 90 100 110 120 130 140 150

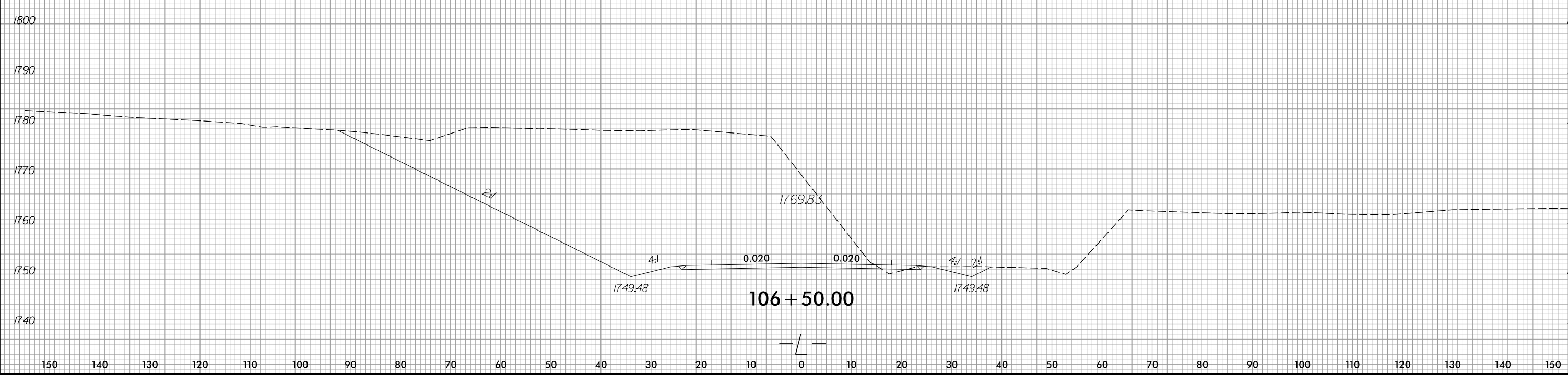
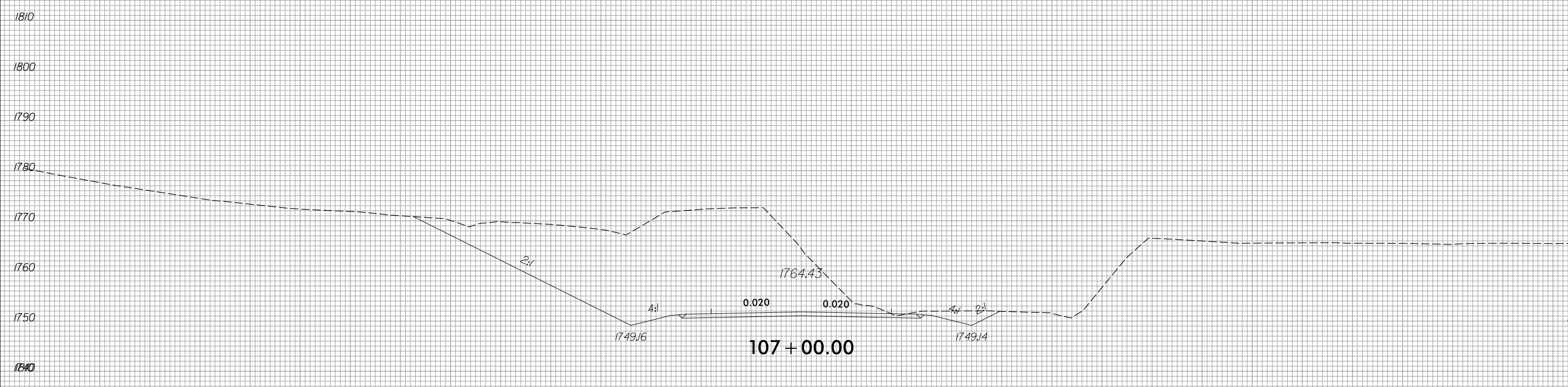

150 140 130 120 110 100 90 80 70 60 50 40 30 20 10 0 10 20 30 40 50 60 70 80 90 100 110 120 130 140 150



150 140 130 120 110 100 90 80 70 60 50 40 30 20 10 0 10 20 30 40 50 60 70 80 90 100 110 120 130 140 150

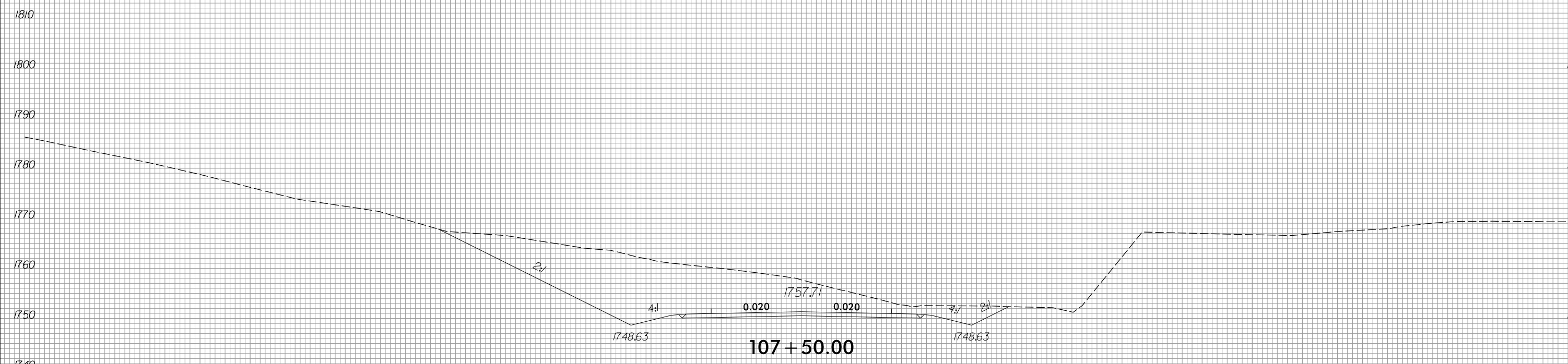
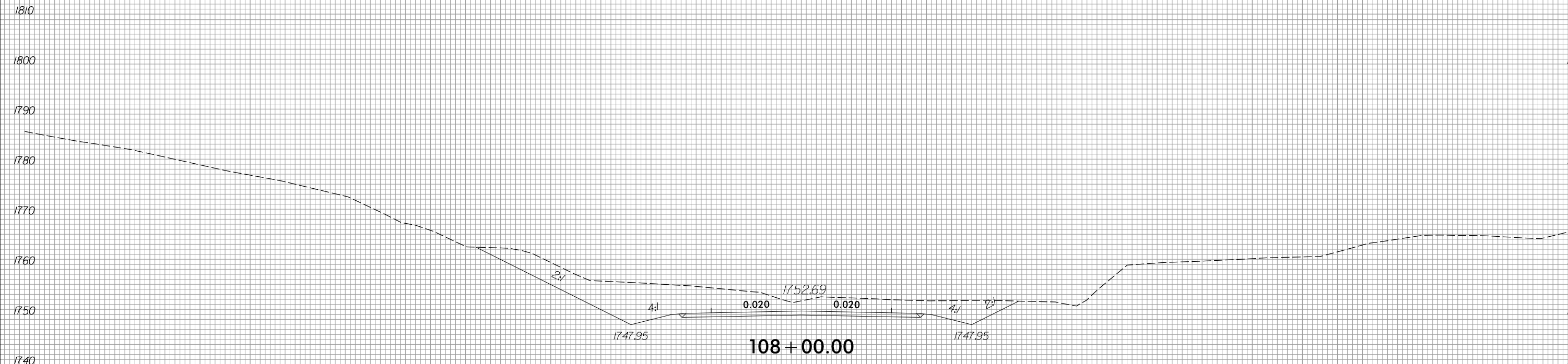

150 140 130 120 110 100 90 80 70 60 50 40 30 20 10 0 10 20 30 40 50 60 70 80 90 100 110 120 130 140 150



150 140 130 120 110 100 90 80 70 60 50 40 30 20 10 0 10 20 30 40 50 60 70 80 90 100 110 120 130 140 150

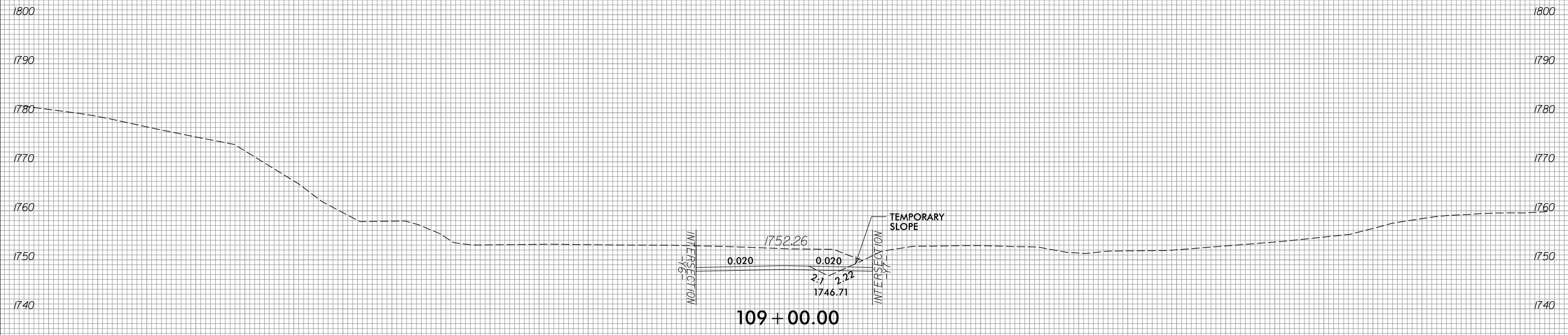

109 + 00.00

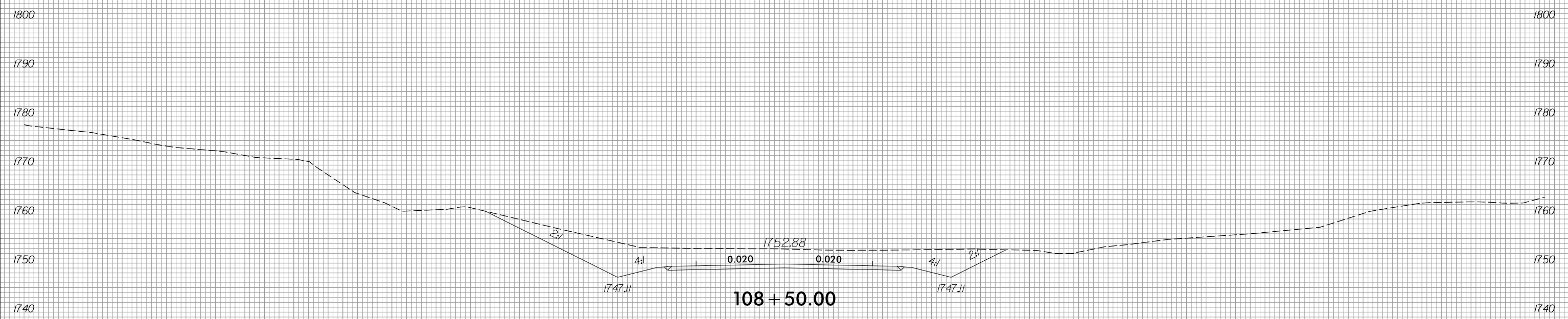

108 + 50.00

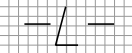

150 140 130 120 110 100 90 80 70 60 50 40 30 20 10 0 10 20 30 40 50 60 70 80 90 100 110 120 130 140 150

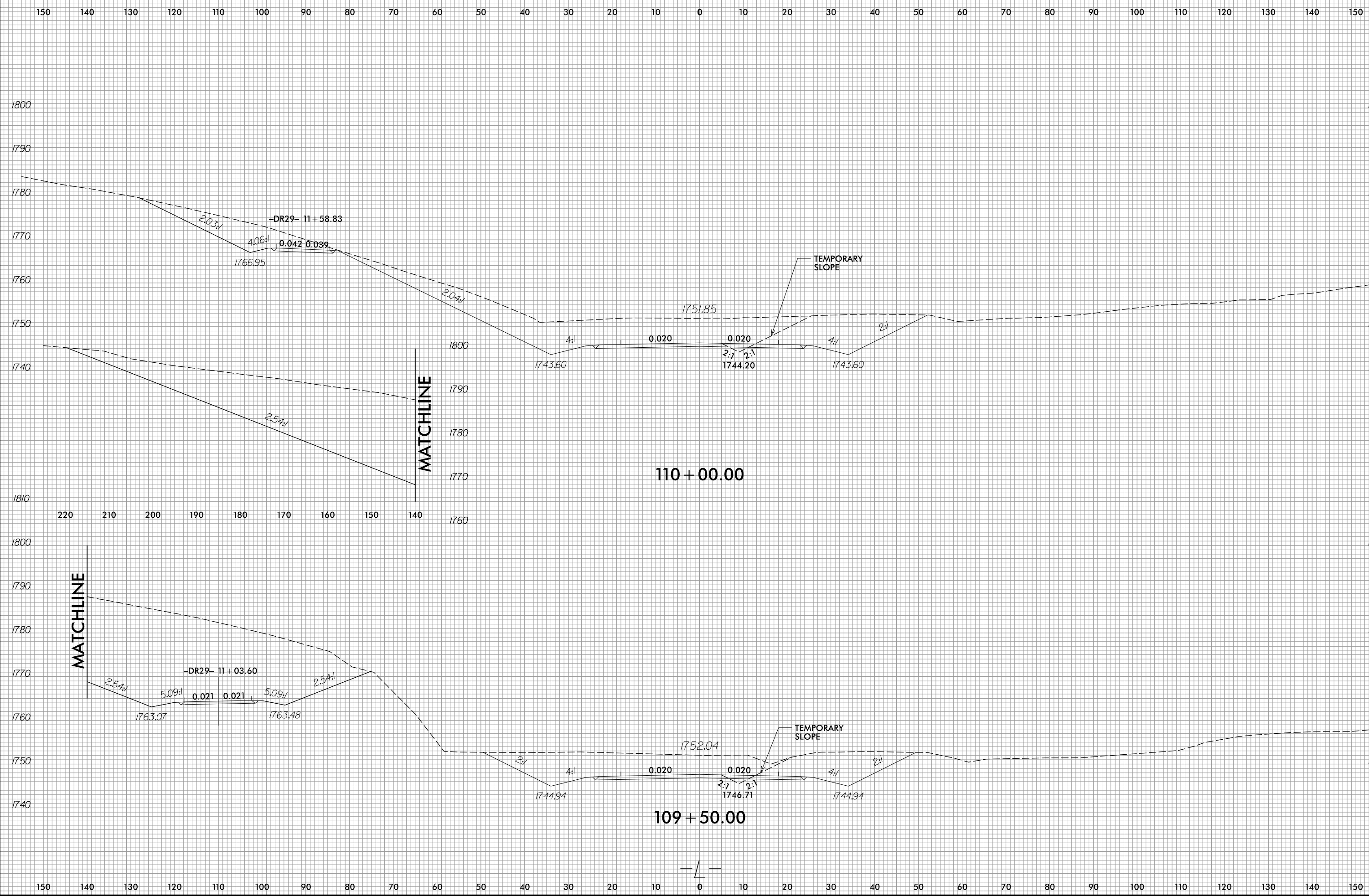



150 140 130 120 110 100 90 80 70 60 50 40 30 20 10 0 10 20 30 40 50 60 70 80 90 100 110 120 130 140 150

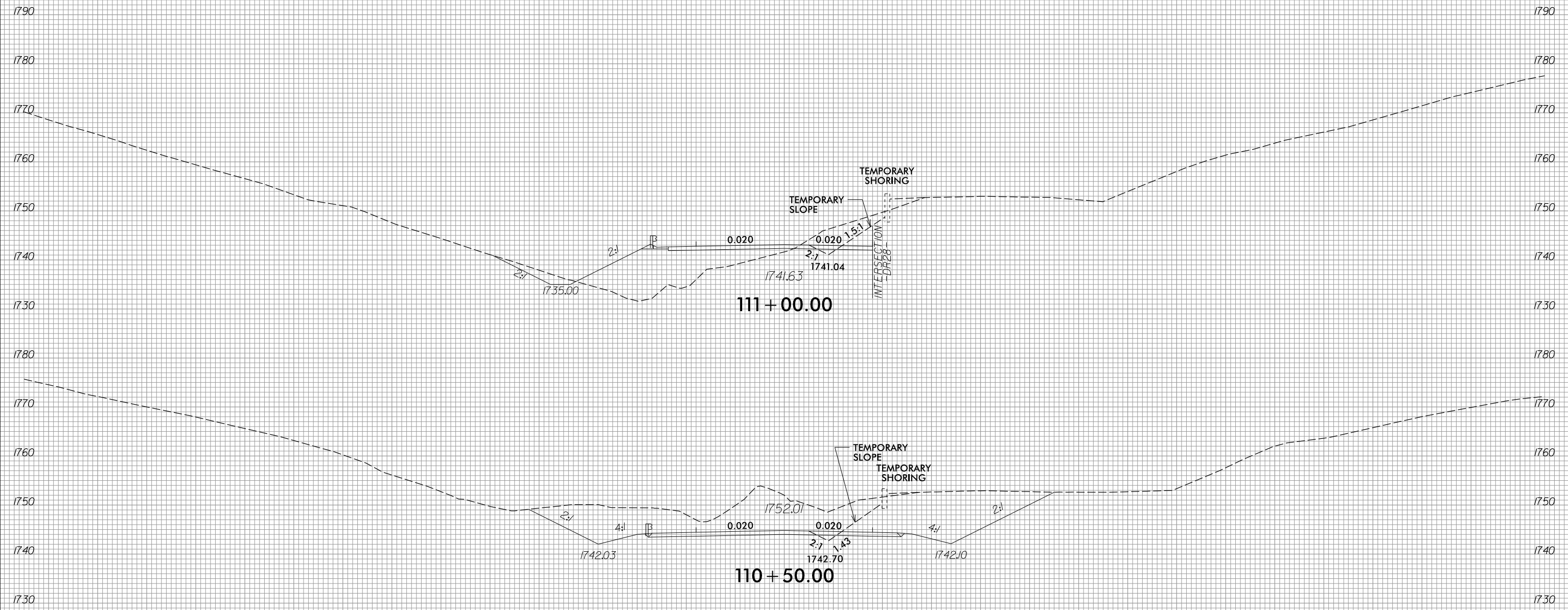



150 140 130 120 110 100 90 80 70 60 50 40 30 20 10 0 10 20 30 40 50 60 70 80 90 100 110 120 130 140 150

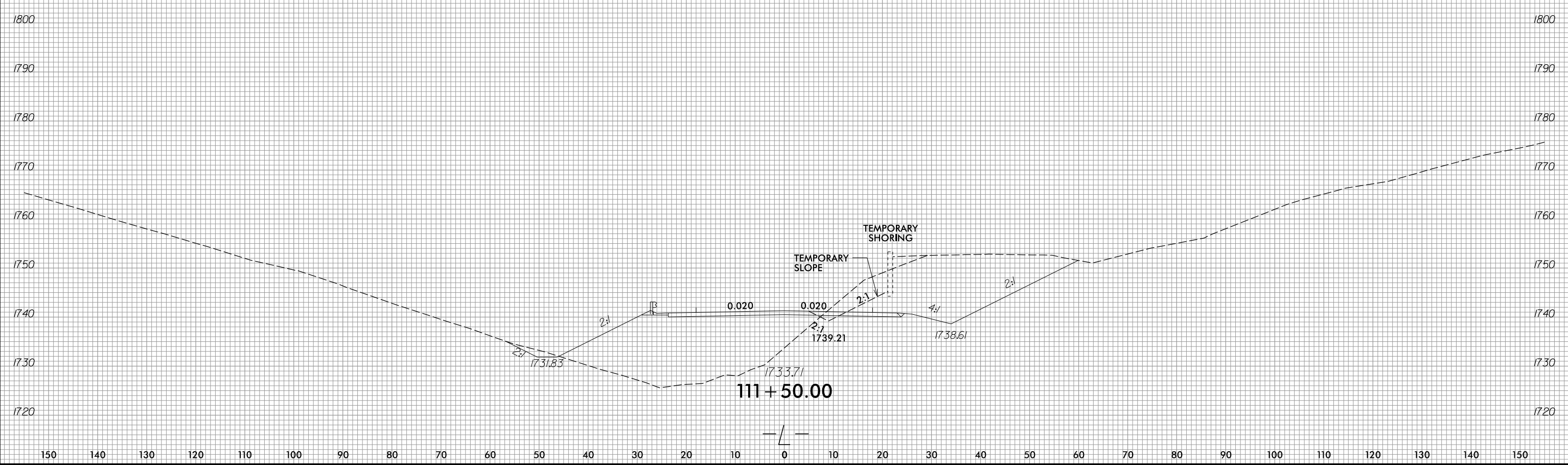

1800
1790
1780
1770
1760
1750
1740
1730
1720

1800
1790
1780
1770
1760
1750
1740
1730
1720

111+50.00

TEMPORARY SHORING

TEMPORARY SLOPE

2:1

2:1
1731.83

0.020

0.020

2:1

1739.21

4:1
1738.61

2:1





170 160 150 140 130 120 110 100 90 80 70 60 50 40 30 20 10 0 10 20 30 40 50 60 70 80 90 100 110 120 130

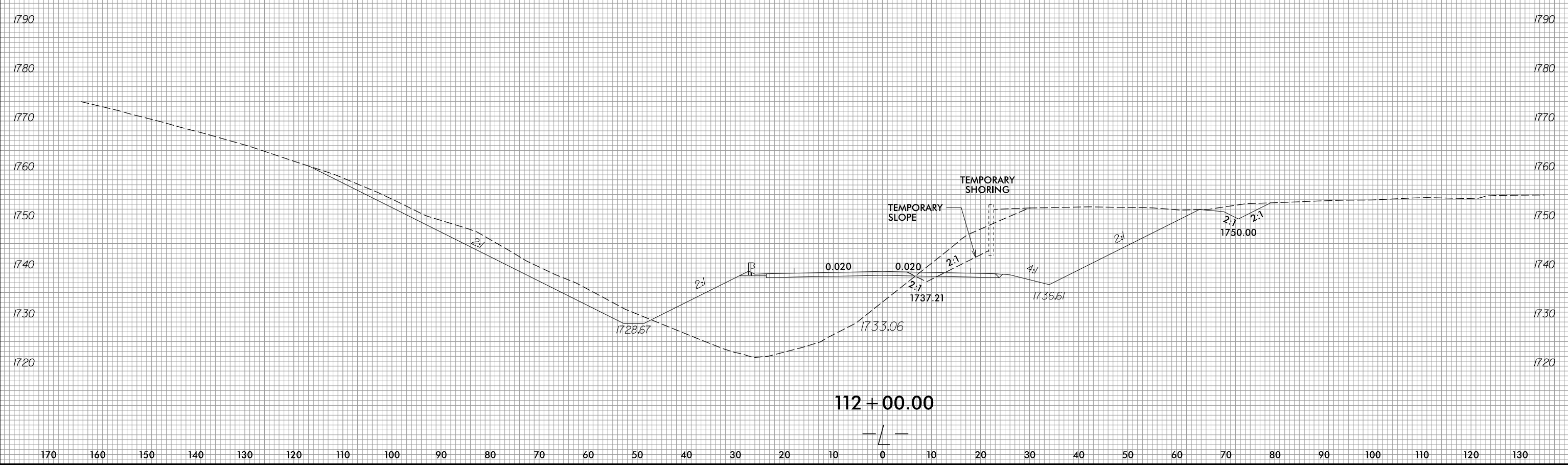
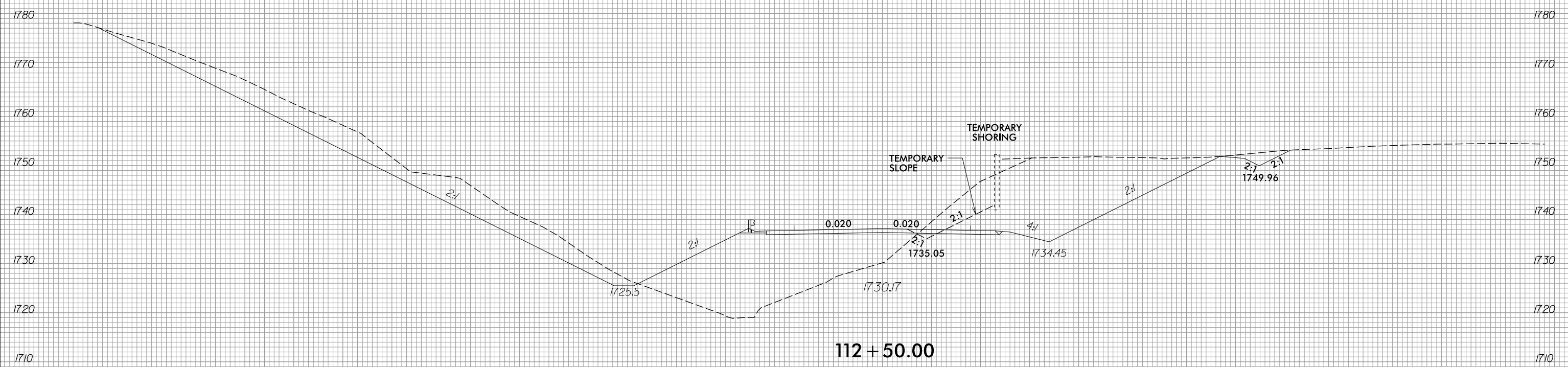

170 160 150 140 130 120 110 100 90 80 70 60 50 40 30 20 10 0 10 20 30 40 50 60 70 80 90 100 110 120 130

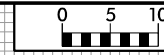

170 160 150 140 130 120 110 100 90 80 70 60 50 40 30 20 10 0 10 20 30 40 50 60 70 80 90 100 110 120 130

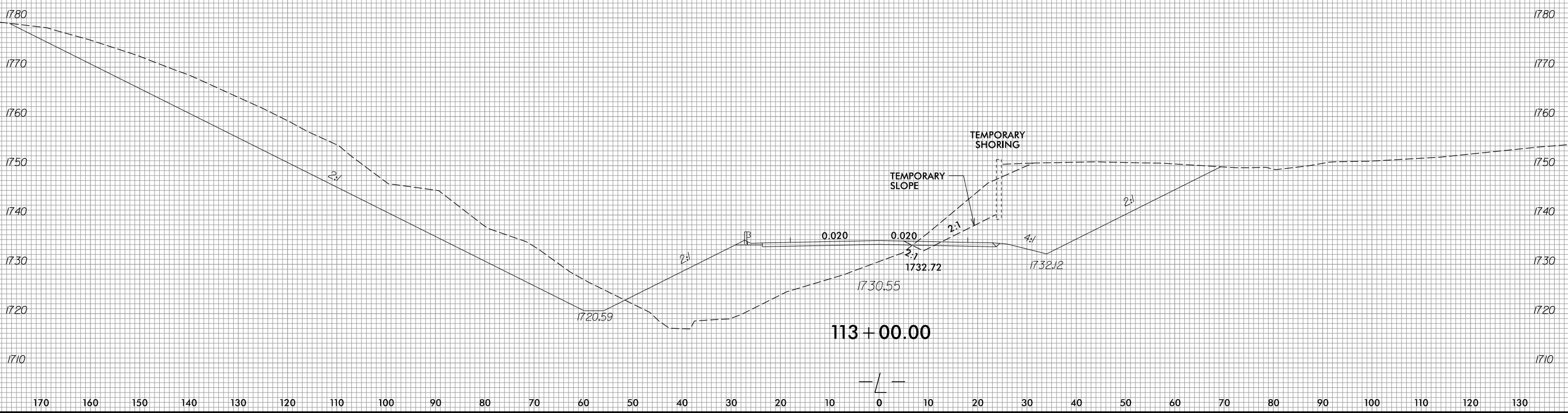
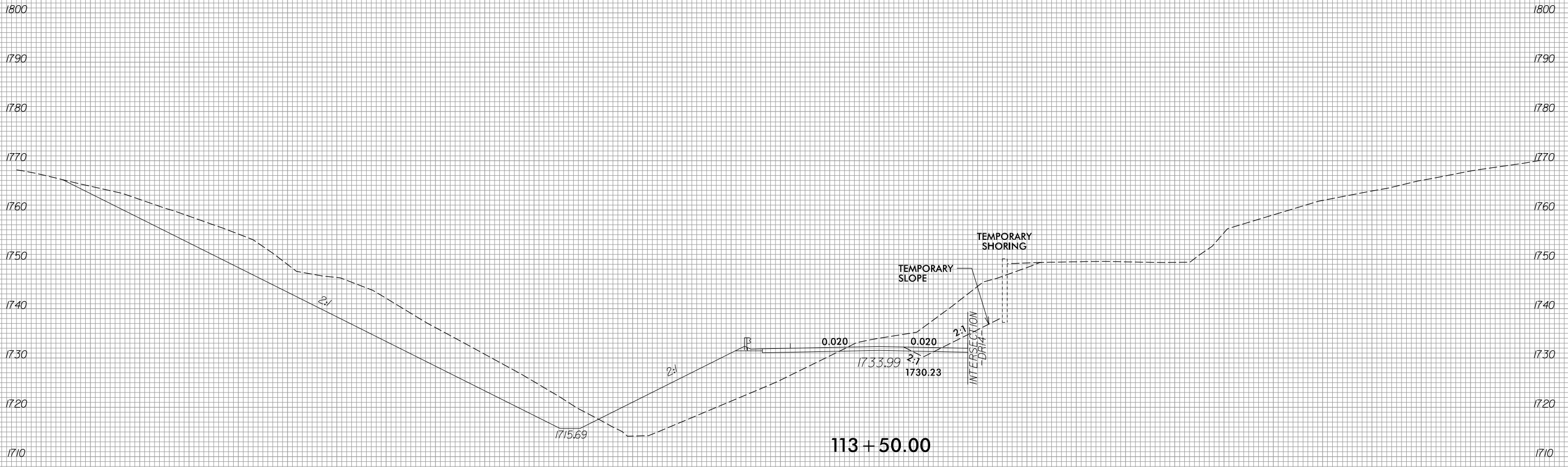



150 140 130 120 110 100 90 80 70 60 50 40 30 20 10 0 10 20 30 40 50 60 70 80 90 100 110 120 130 140 150

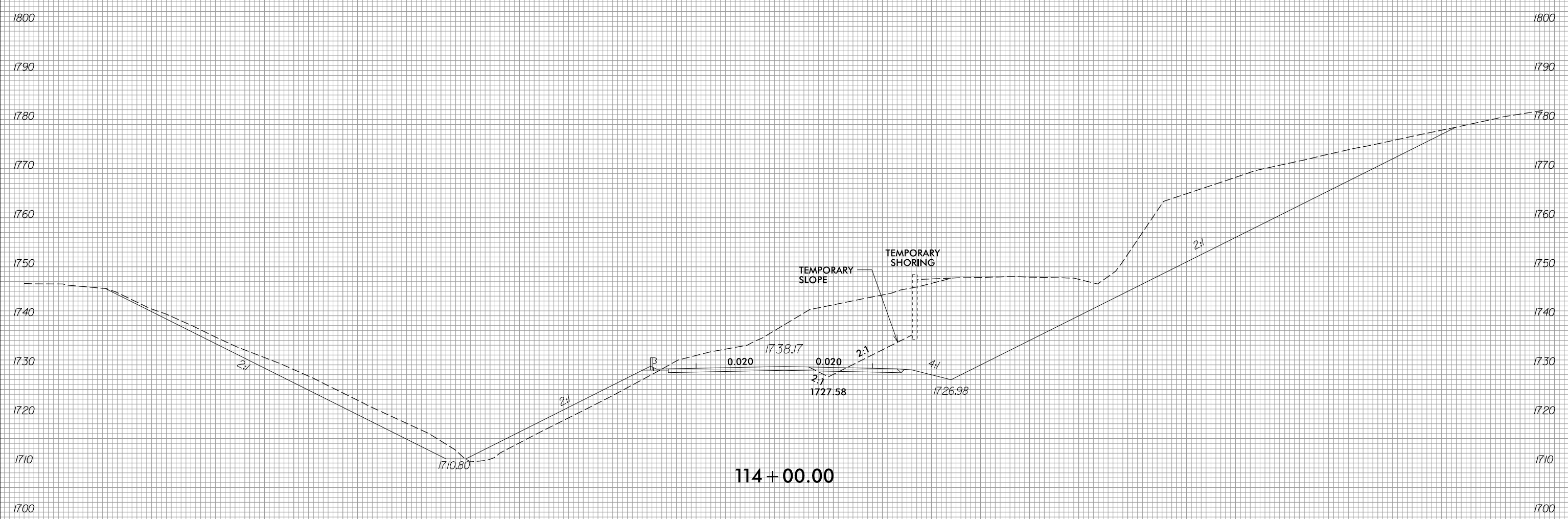

114 + 00.00

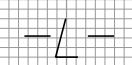

150 140 130 120 110 100 90 80 70 60 50 40 30 20 10 0 10 20 30 40 50 60 70 80 90 100 110 120 130 140 150



150 140 130 120 110 100 90 80 70 60 50 40 30 20 10 0 10 20 30 40 50 60 70 80 90 100 110 120 130 140 150

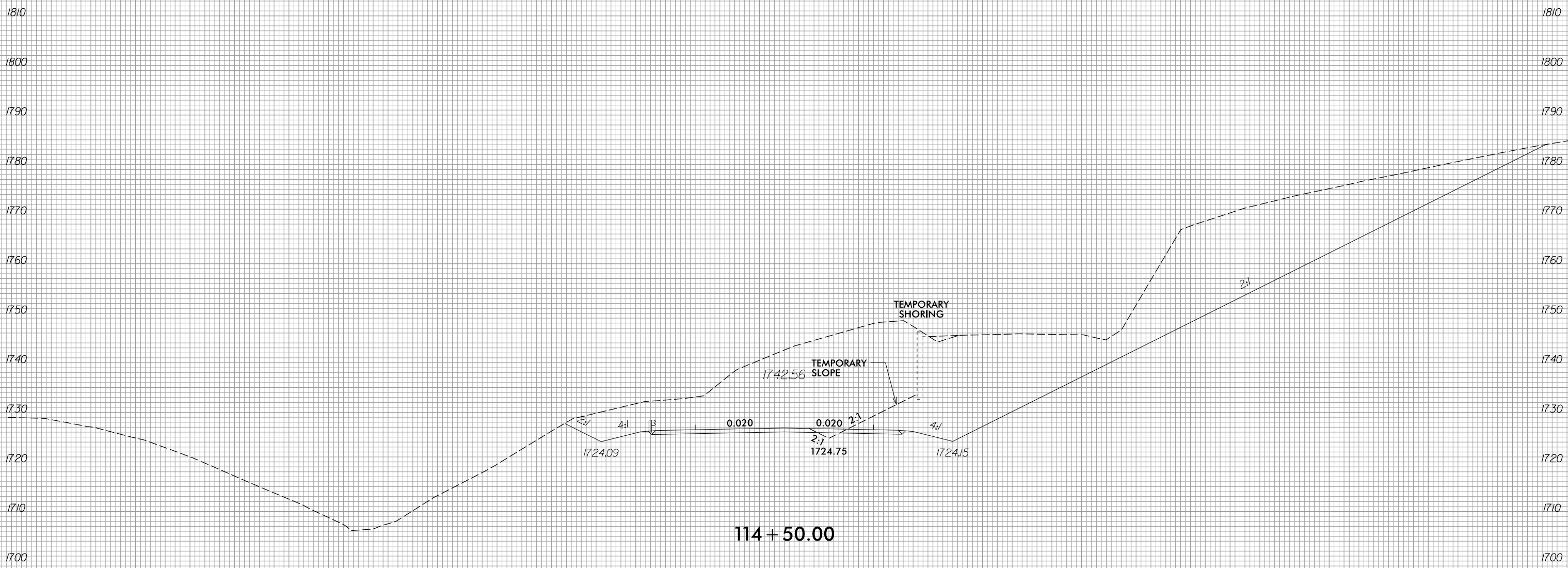

114 + 50.00

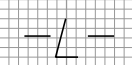

150 140 130 120 110 100 90 80 70 60 50 40 30 20 10 0 10 20 30 40 50 60 70 80 90 100 110 120 130 140 150



150 140 130 120 110 100 90 80 70 60 50 40 30 20 10 0 10 20 30 40 50 60 70 80 90 100 110 120 130 140 150

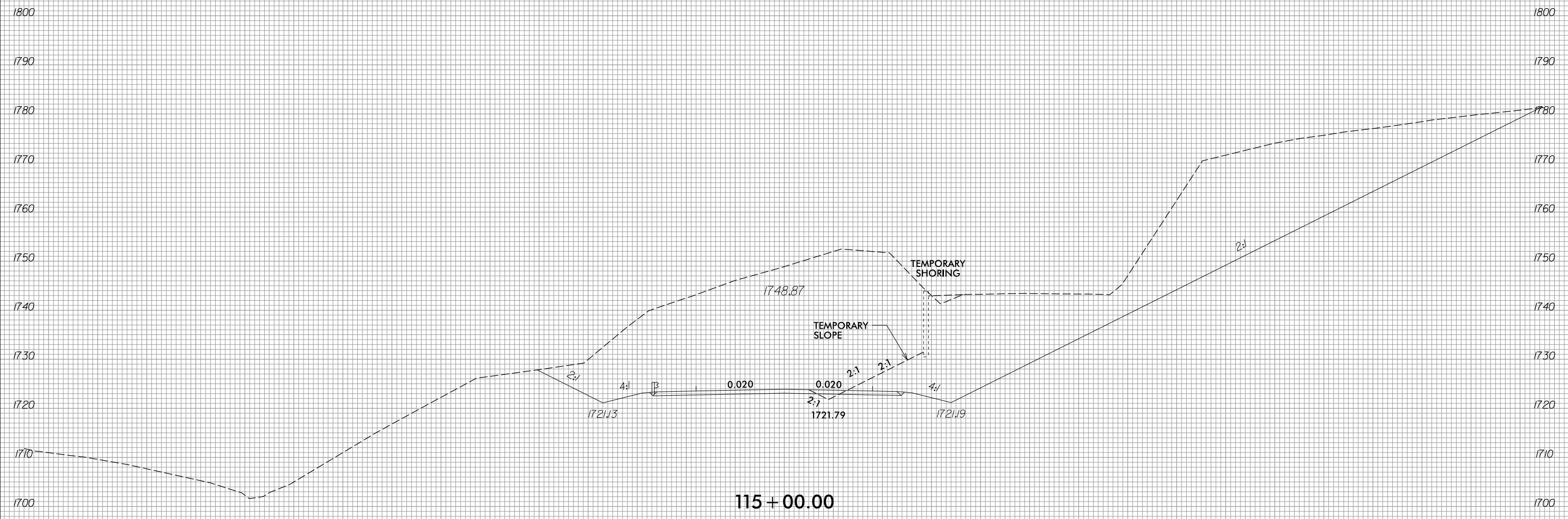

115 + 00.00

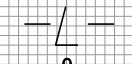

150 140 130 120 110 100 90 80 70 60 50 40 30 20 10 0 10 20 30 40 50 60 70 80 90 100 110 120 130 140 150



150 140 130 120 110 100 90 80 70 60 50 40 30 20 10 0 10 20 30 40 50 60 70 80 90 100 110 120 130 140 150

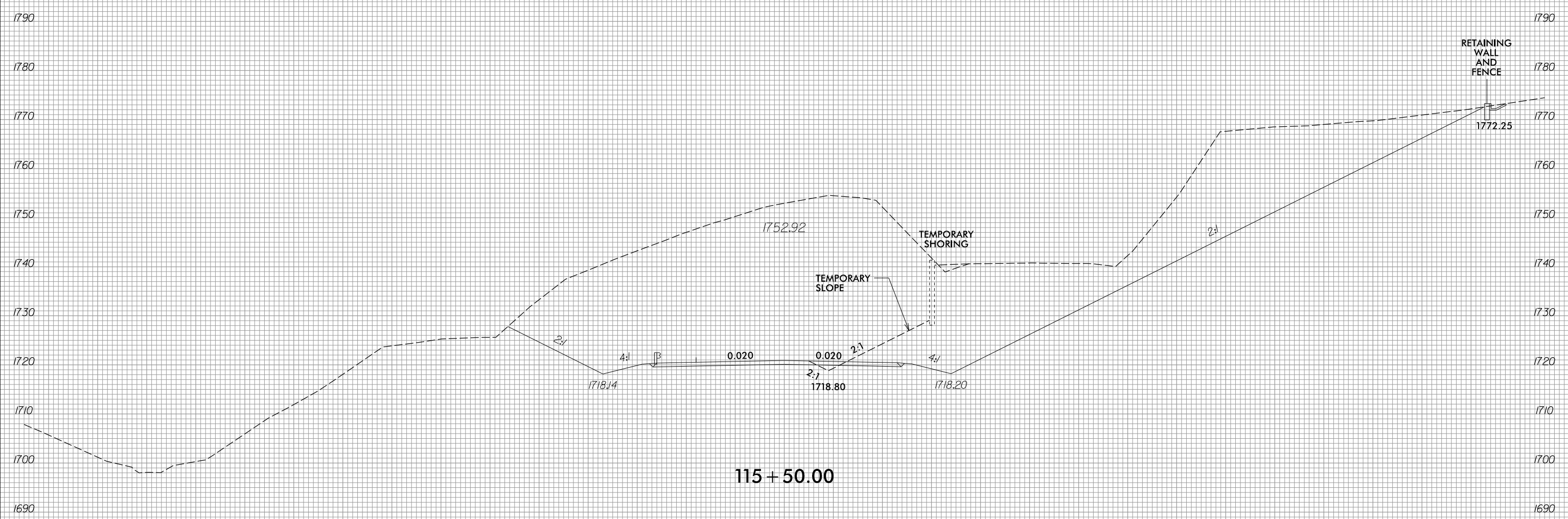

115 + 50.00

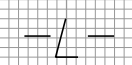

150 140 130 120 110 100 90 80 70 60 50 40 30 20 10 0 10 20 30 40 50 60 70 80 90 100 110 120 130 140 150



150 140 130 120 110 100 90 80 70 60 50 40 30 20 10 0 10 20 30 40 50 60 70 80 90 100 110 120 130 140 150

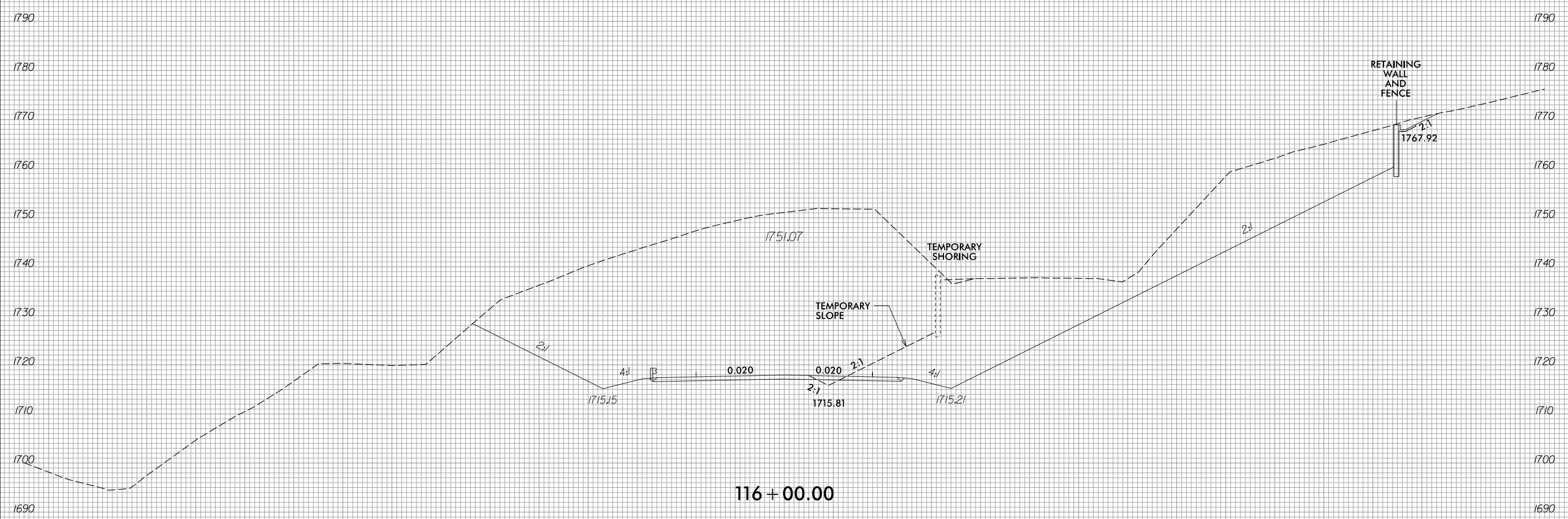

116 + 00.00

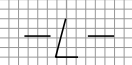

150 140 130 120 110 100 90 80 70 60 50 40 30 20 10 0 10 20 30 40 50 60 70 80 90 100 110 120 130 140 150



150 140 130 120 110 100 90 80 70 60 50 40 30 20 10 0 10 20 30 40 50 60 70 80 90 100 110 120 130 140 150

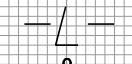
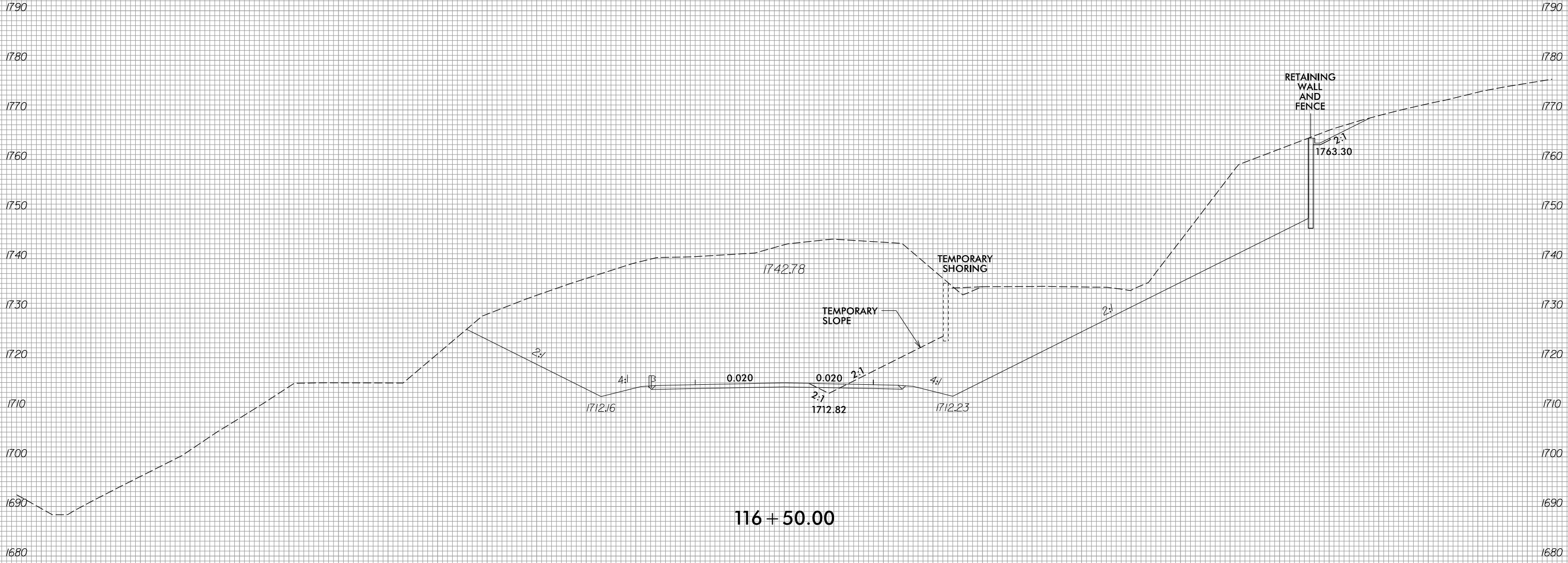



150 140 130 120 110 100 90 80 70 60 50 40 30 20 10 0 10 20 30 40 50 60 70 80 90 100 110 120 130 140 150

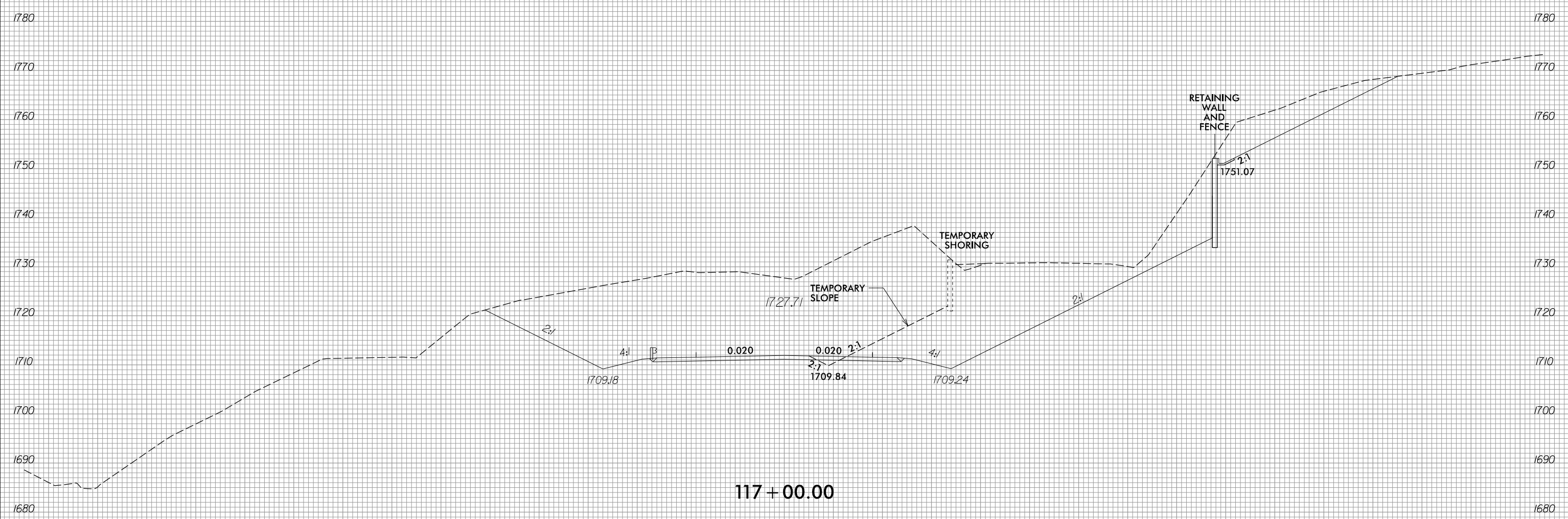

117 + 00.00

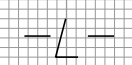

150 140 130 120 110 100 90 80 70 60 50 40 30 20 10 0 10 20 30 40 50 60 70 80 90 100 110 120 130 140 150

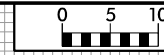

150 140 130 120 110 100 90 80 70 60 50 40 30 20 10 0 10 20 30 40 50 60 70 80 90 100 110 120 130 140 150

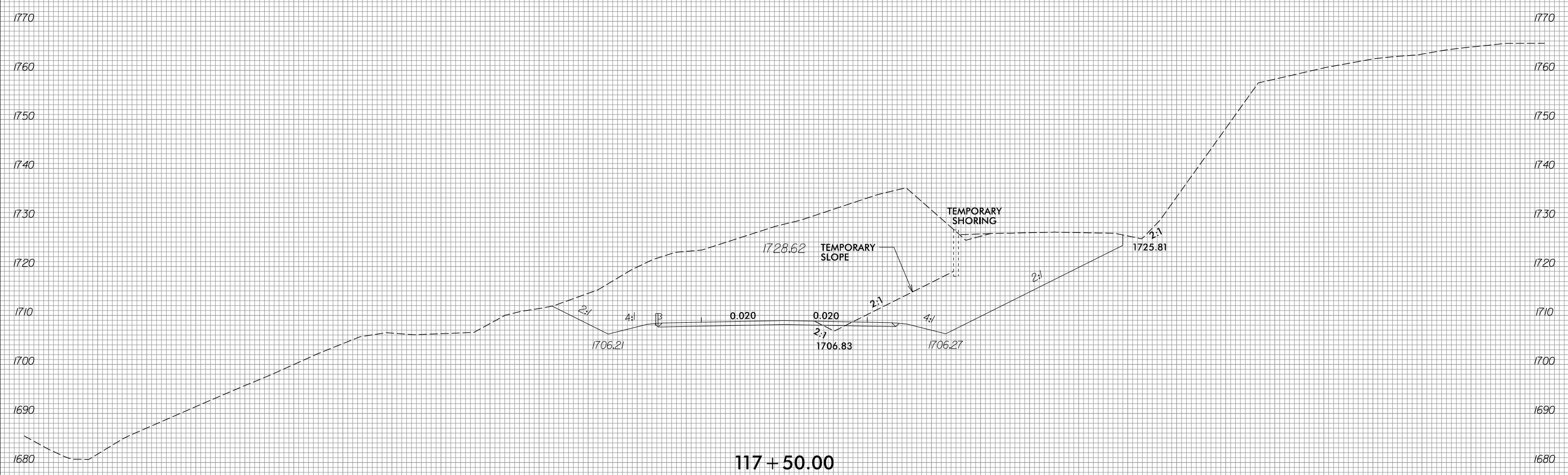

117 + 50.00

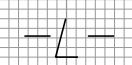

150 140 130 120 110 100 90 80 70 60 50 40 30 20 10 0 10 20 30 40 50 60 70 80 90 100 110 120 130 140 150

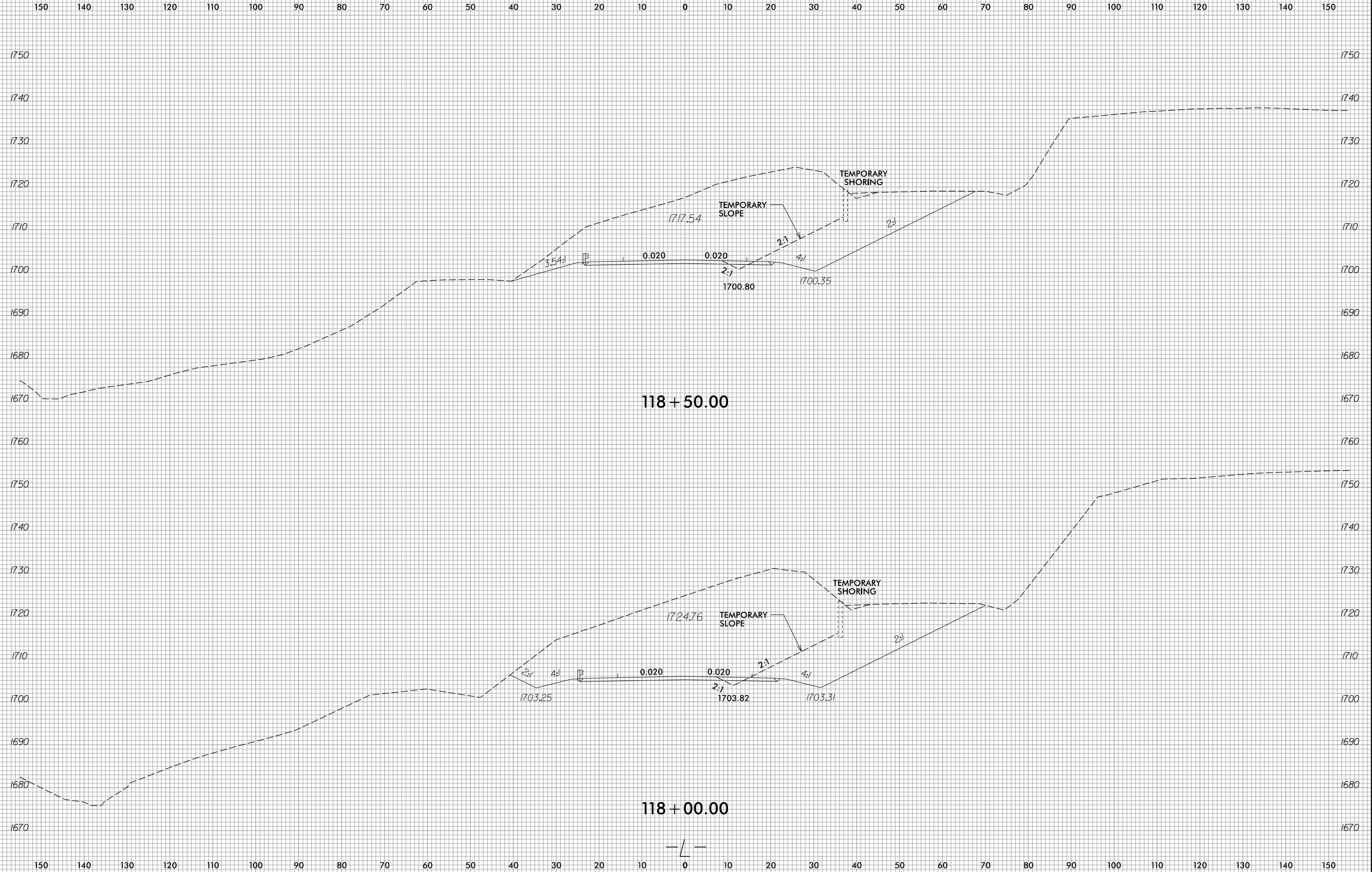



150 140 130 120 110 100 90 80 70 60 50 40 30 20 10 0 10 20 30 40 50 60 70 80 90 100 110 120 130 140 150

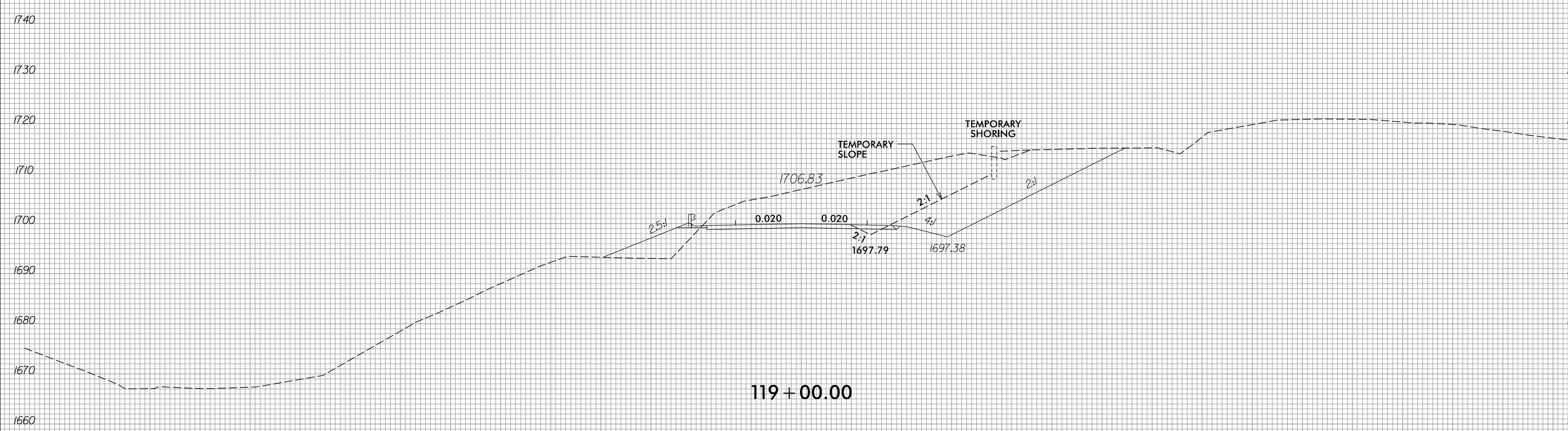
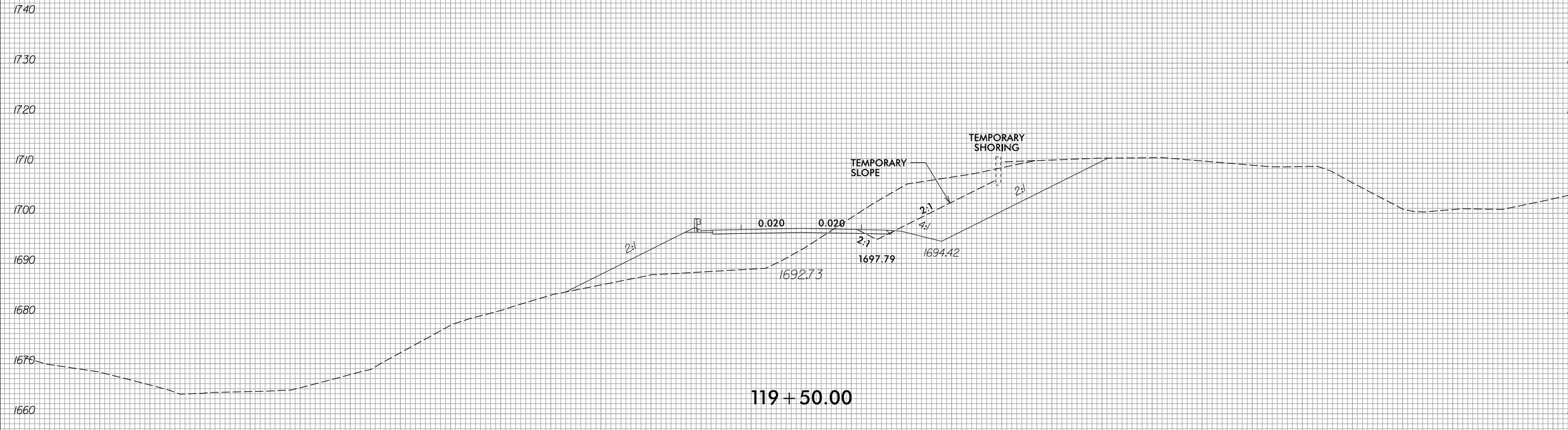

150 140 130 120 110 100 90 80 70 60 50 40 30 20 10 0 10 20 30 40 50 60 70 80 90 100 110 120 130 140 150

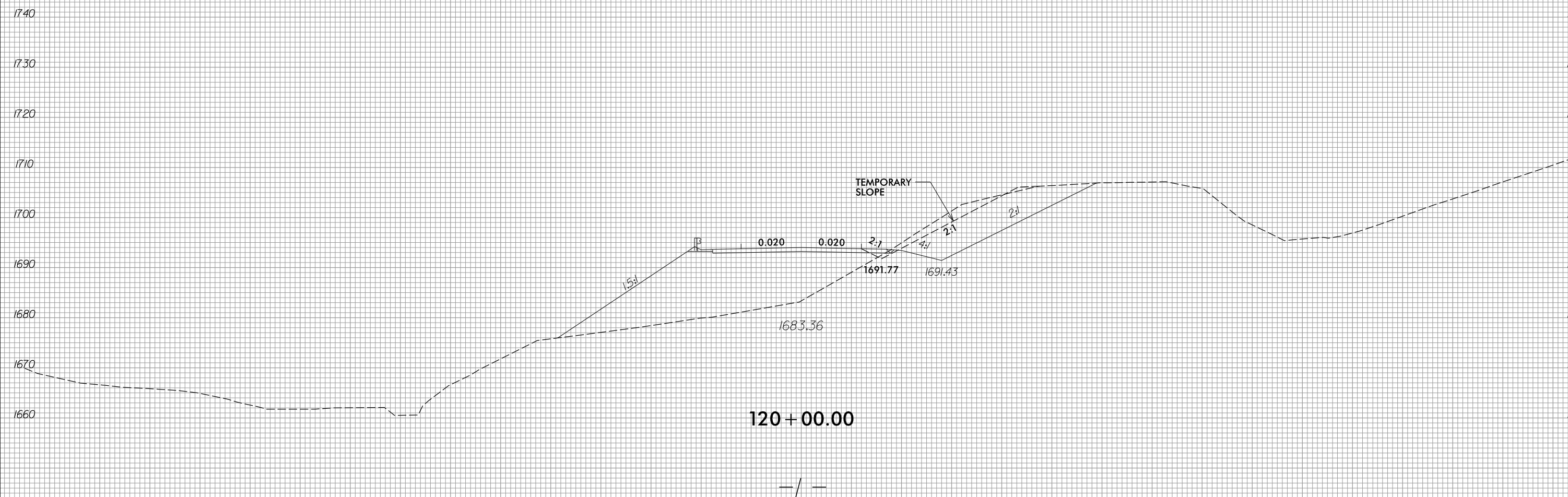
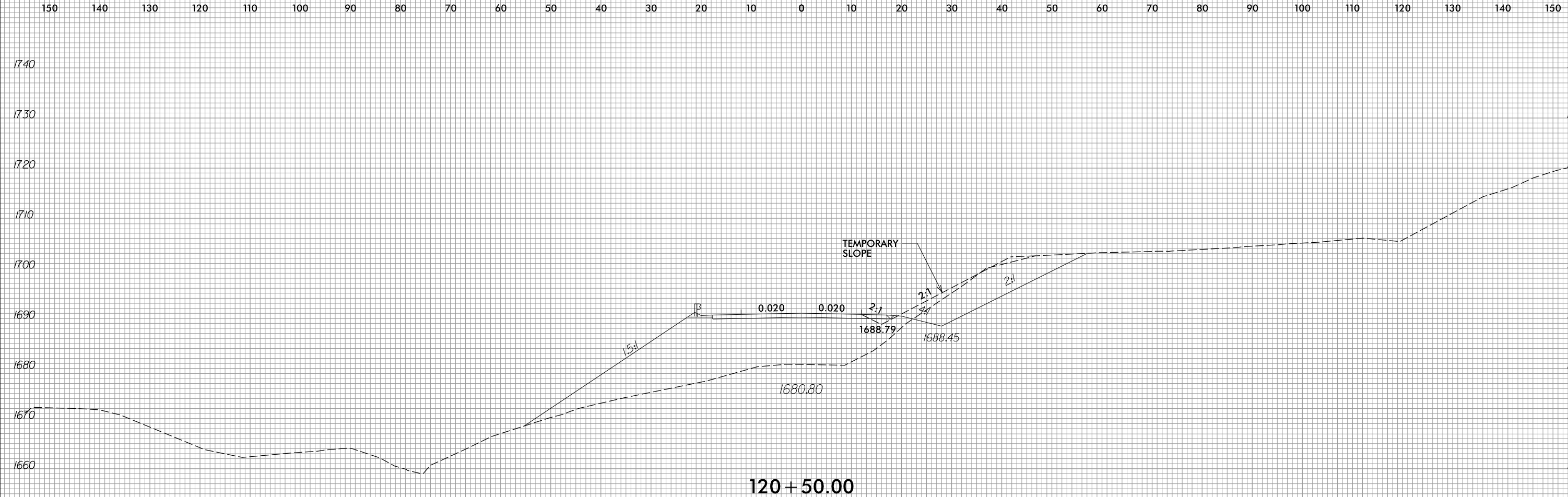



150 140 130 120 110 100 90 80 70 60 50 40 30 20 10 0 10 20 30 40 50 60 70 80 90 100 110 120 130 140 150

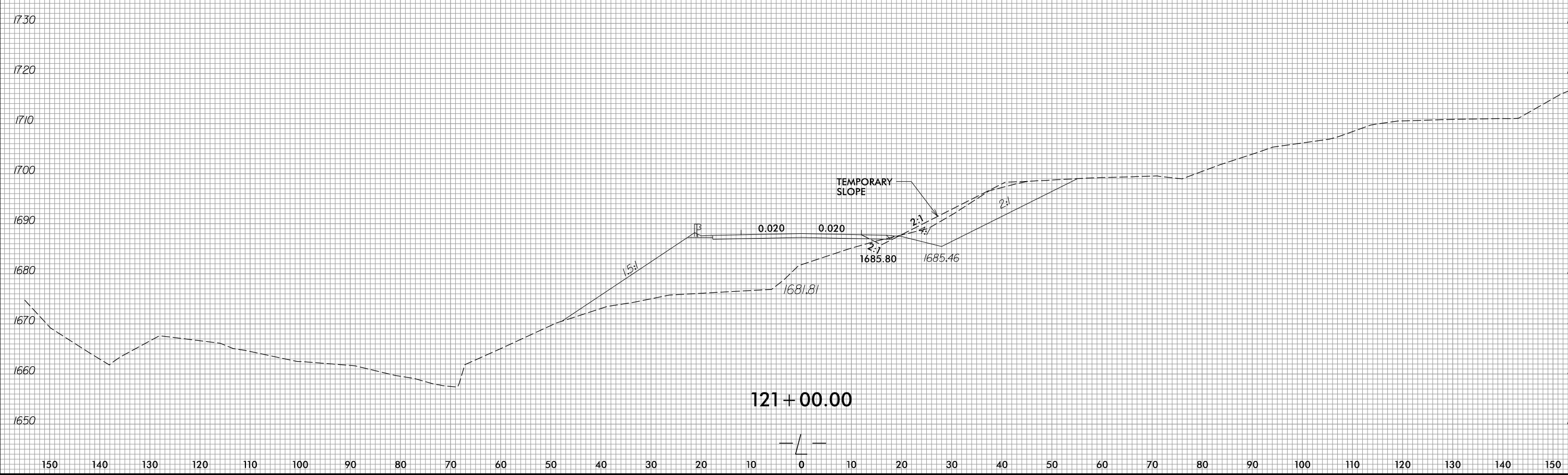
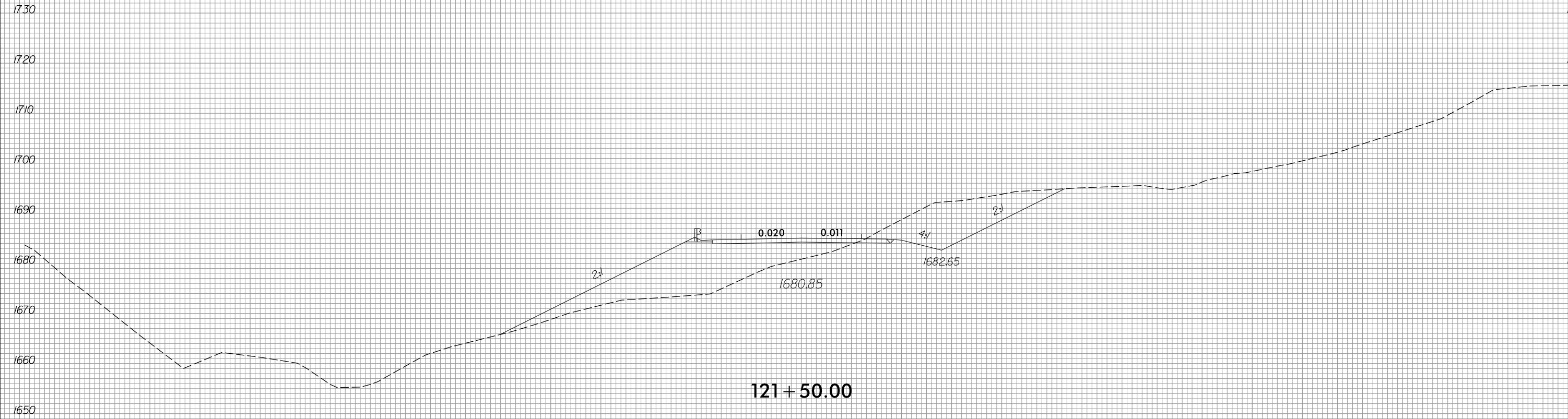

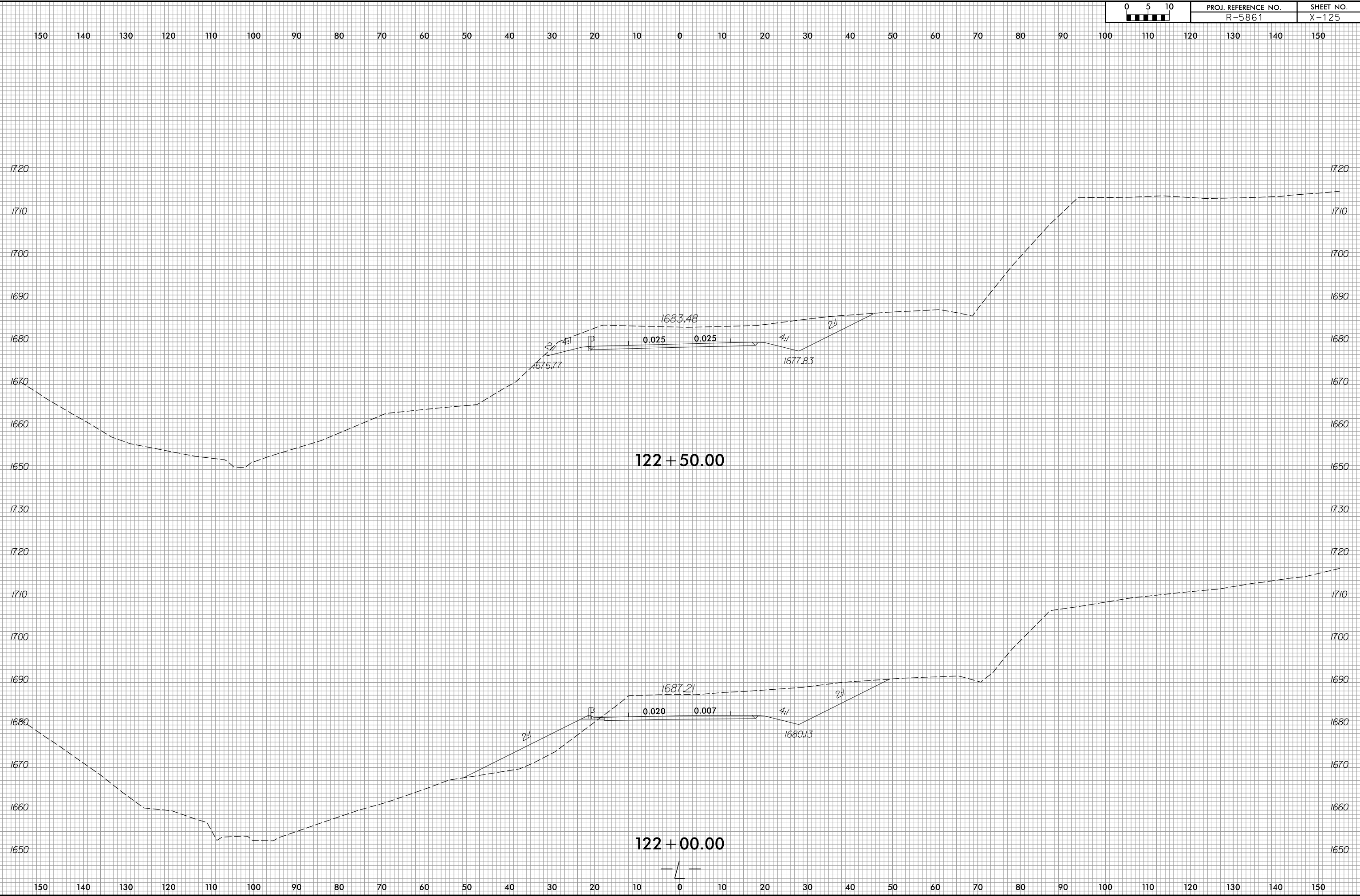



150 140 130 120 110 100 90 80 70 60 50 40 30 20 10 0 10 20 30 40 50 60 70 80 90 100 110 120 130 140 150

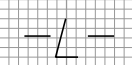
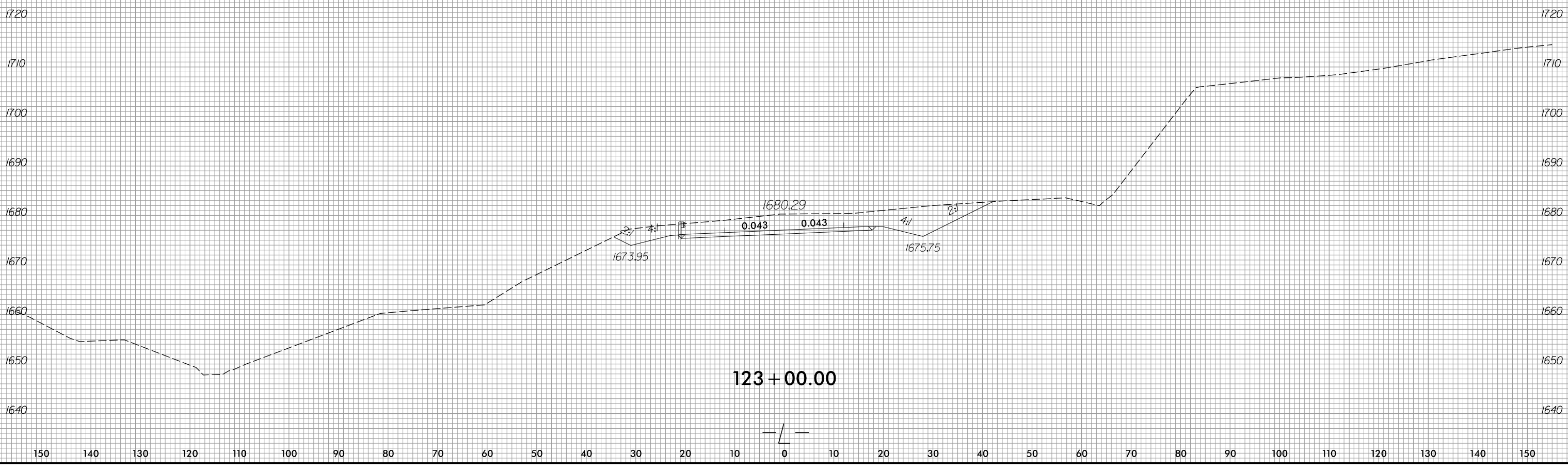
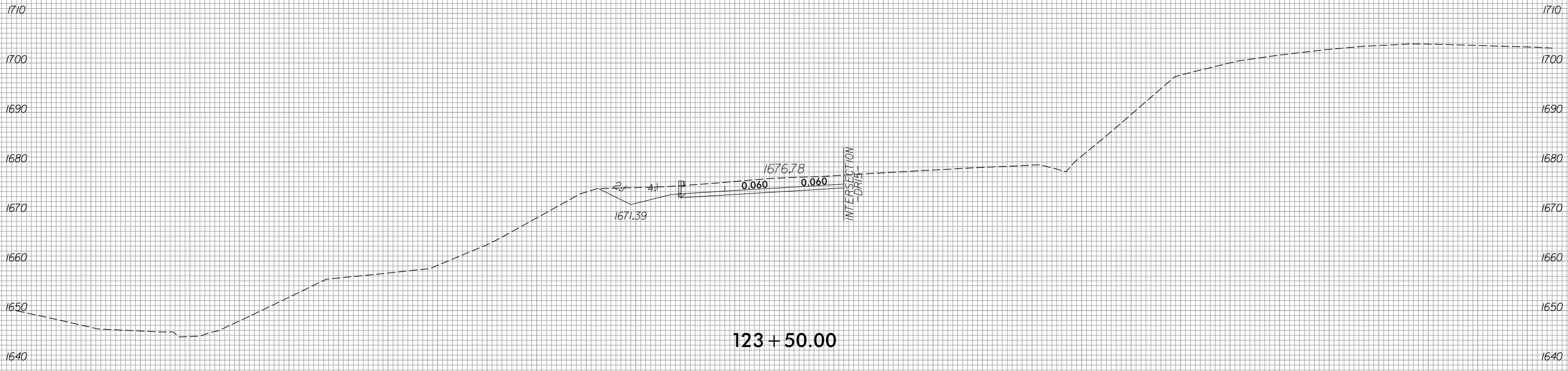



150 140 130 120 110 100 90 80 70 60 50 40 30 20 10 0 10 20 30 40 50 60 70 80 90 100 110 120 130 140 150

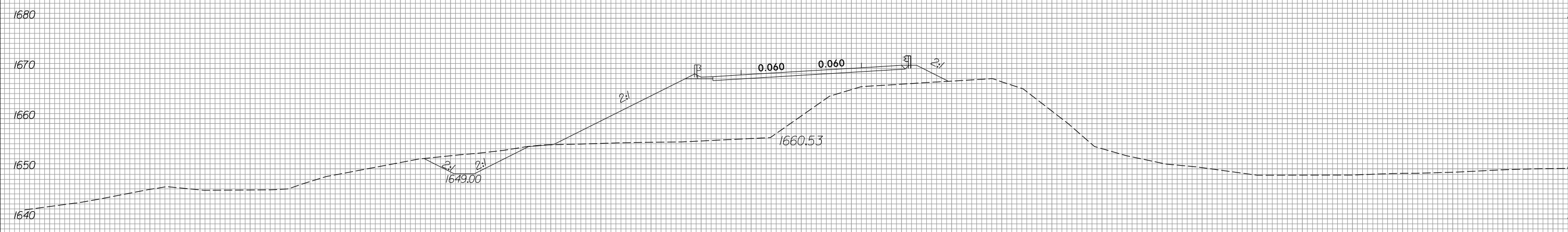

125 + 00.00

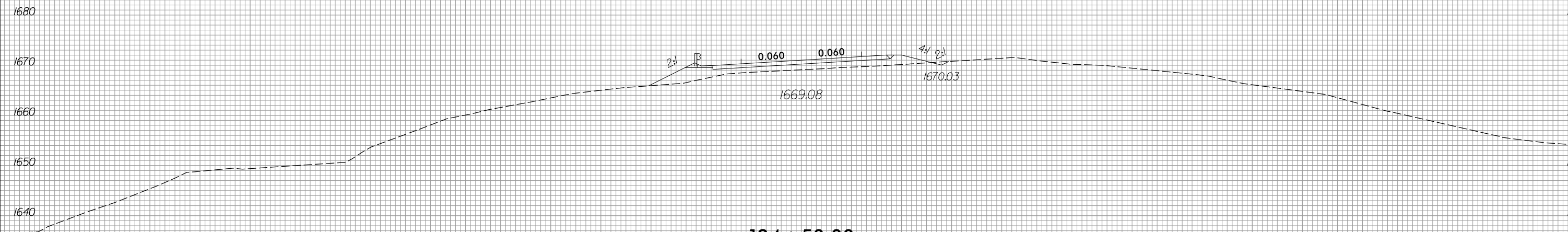

124 + 50.00

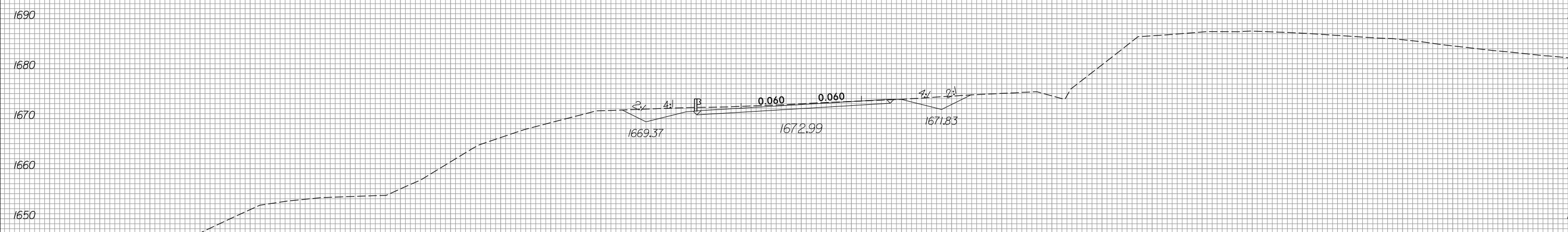

124 + 00.00

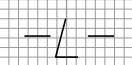

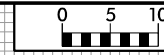

150 140 130 120 110 100 90 80 70 60 50 40 30 20 10 0 10 20 30 40 50 60 70 80 90 100 110 120 130 140 150

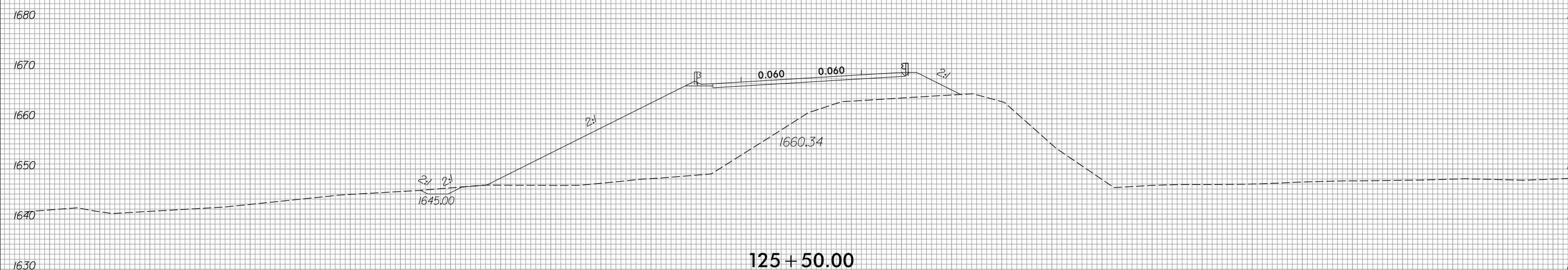
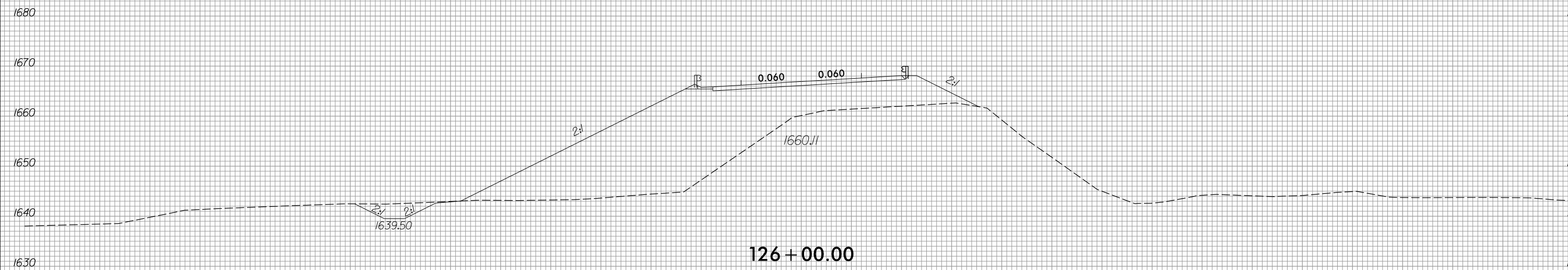
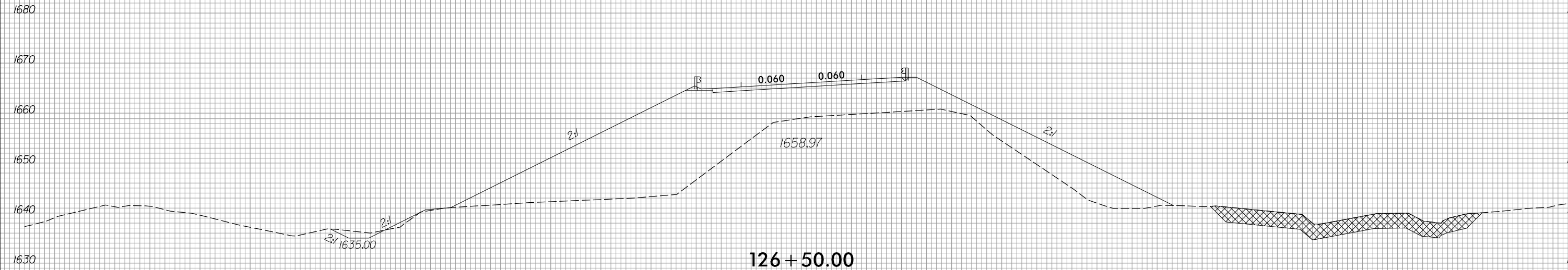

150 140 130 120 110 100 90 80 70 60 50 40 30 20 10 0 10 20 30 40 50 60 70 80 90 100 110 120 130 140 150



150 140 130 120 110 100 90 80 70 60 50 40 30 20 10 0 10 20 30 40 50 60 70 80 90 100 110 120 130 140 150

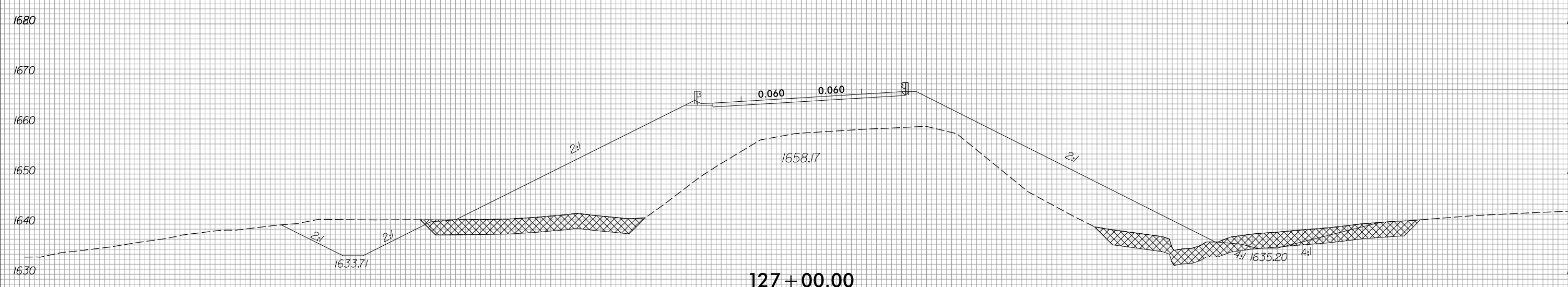
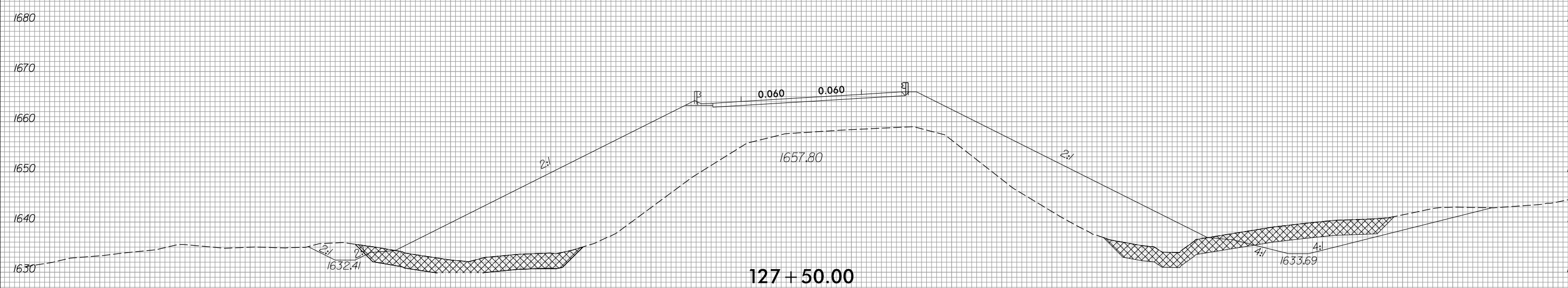
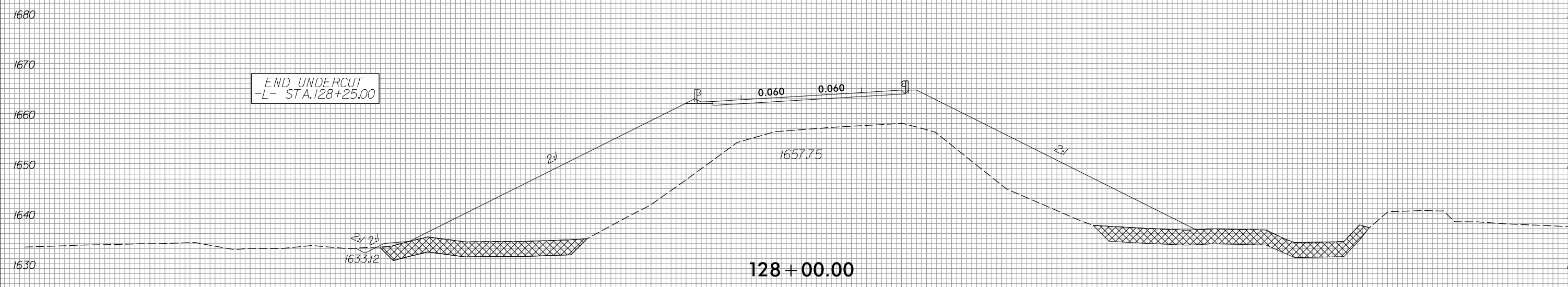

150 140 130 120 110 100 90 80 70 60 50 40 30 20 10 0 10 20 30 40 50 60 70 80 90 100 110 120 130 140 150

BEGIN UNDERCUT
-L- STA. 126+90.00



150 140 130 120 110 100 90 80 70 60 50 40 30 20 10 0 10 20 30 40 50 60 70 80 90 100 110 120 130 140 150

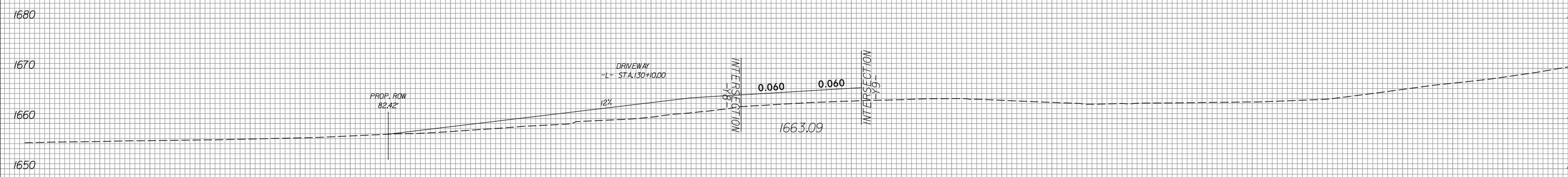

130 + 00.00

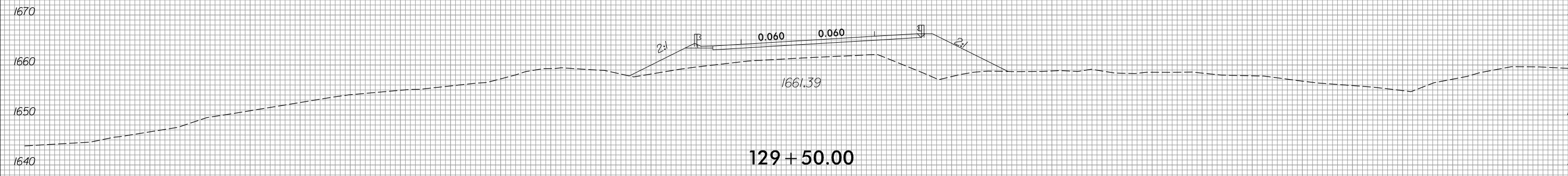

129 + 50.00

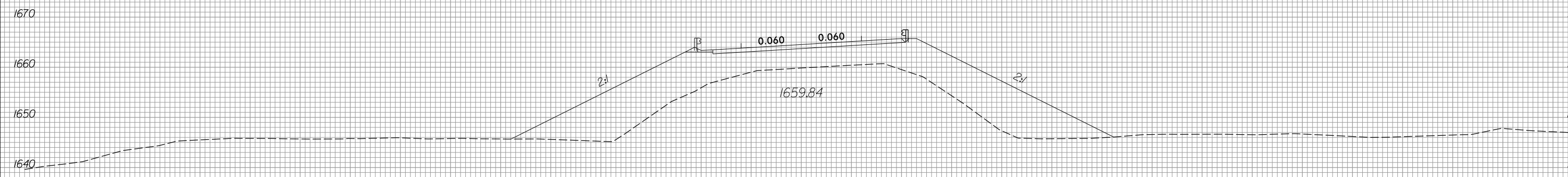

129 + 00.00

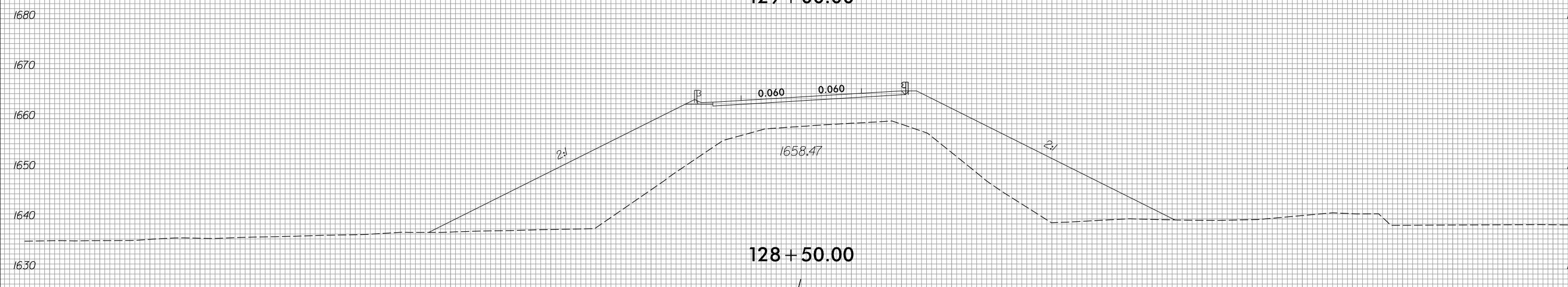

128 + 50.00

150 140 130 120 110 100 90 80 70 60 50 40 30 20 10 0 10 20 30 40 50 60 70 80 90 100 110 120 130 140 150



150 140 130 120 110 100 90 80 70 60 50 40 30 20 10 0 10 20 30 40 50 60 70 80 90 100 110 120 130 140 150

1710 1710

1700 1700

1690 1690

1680 1680

1670 1670

1660 1660

1650 1650

1700 1700

1690 1690

1680 1680

1670 1670

1660 1660

1650 1650

1690 1690

1680 1680

1670 1670

1660 1660

1650 1650

1640 1640

150 140 130 120 110 100 90 80 70 60 50 40 30 20 10 0 10 20 30 40 50 60 70 80 90 100 110 120 130 140 150

131 + 50.00

131 + 00.00

130 + 50.00

2:1

2:1

2:1

4:1

4:1

4:1

0.060

0.060

0.060

0.060

0.060

0.060

1667.79

1667.48

1666.16

1666.26

1664.64

1665.26

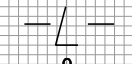
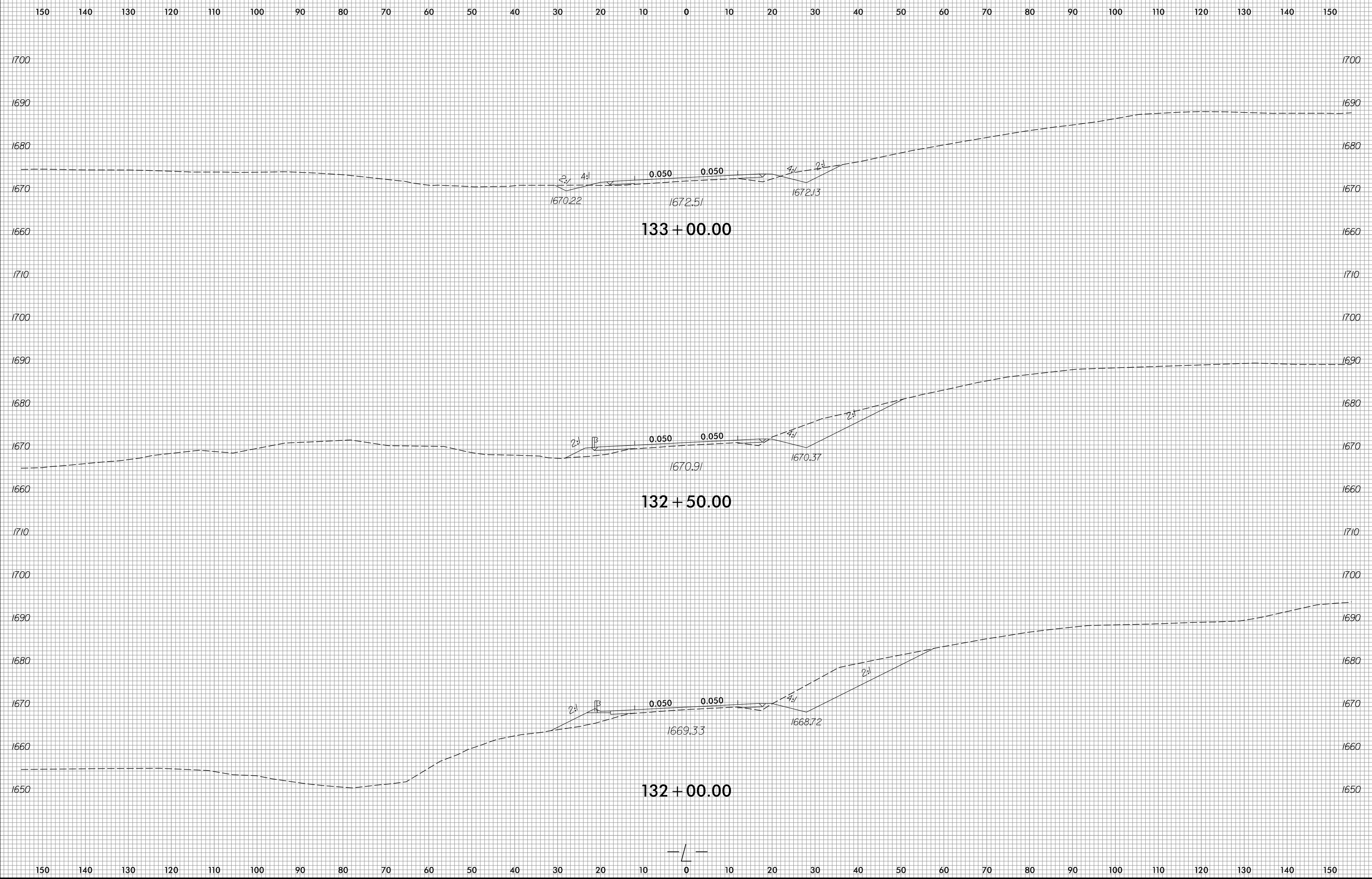

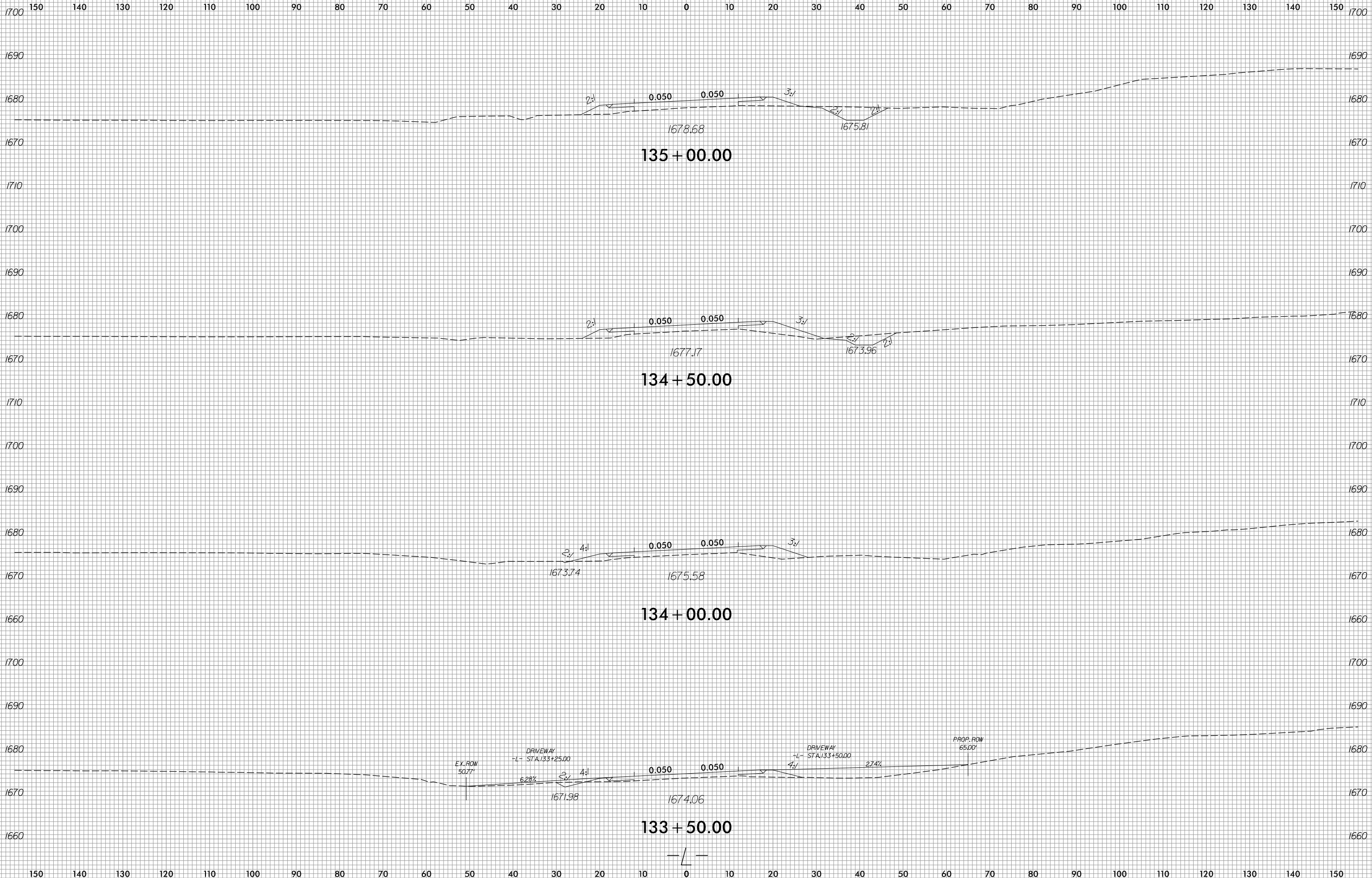



150 140 130 120 110 100 90 80 70 60 50 40 30 20 10 0 10 20 30 40 50 60 70 80 90 100 110 120 130 140 150

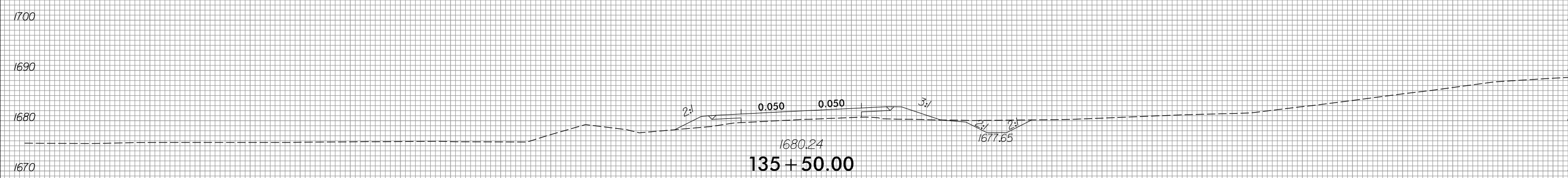
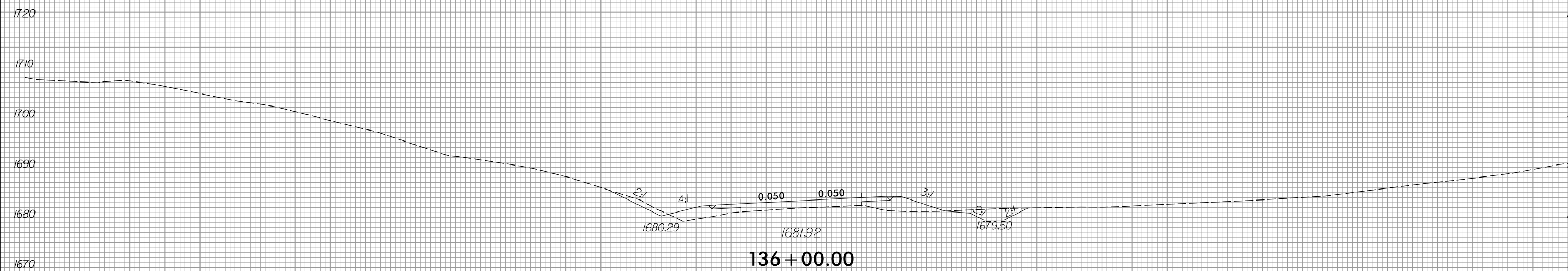
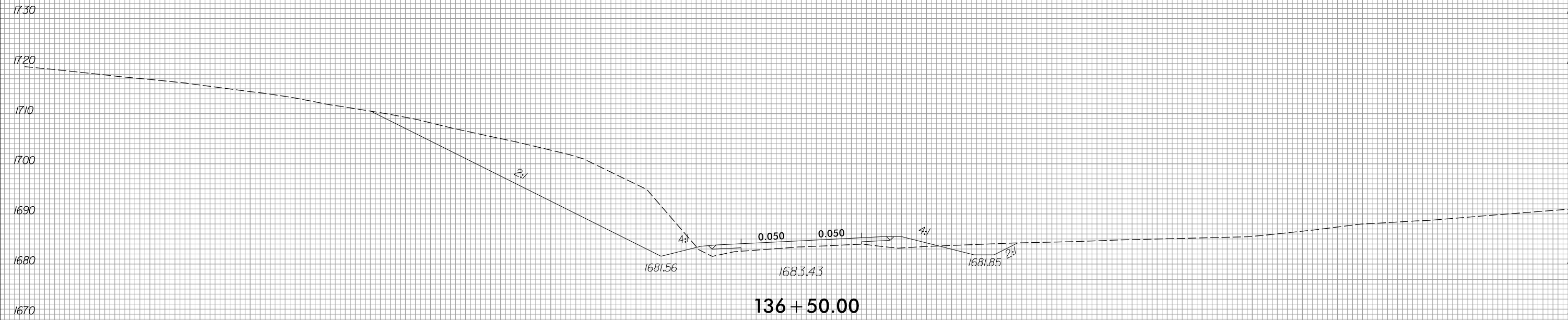

150 140 130 120 110 100 90 80 70 60 50 40 30 20 10 0 10 20 30 40 50 60 70 80 90 100 110 120 130 140 150



150 140 130 120 110 100 90 80 70 60 50 40 30 20 10 0 10 20 30 40 50 60 70 80 90 100 110 120 130 140 150

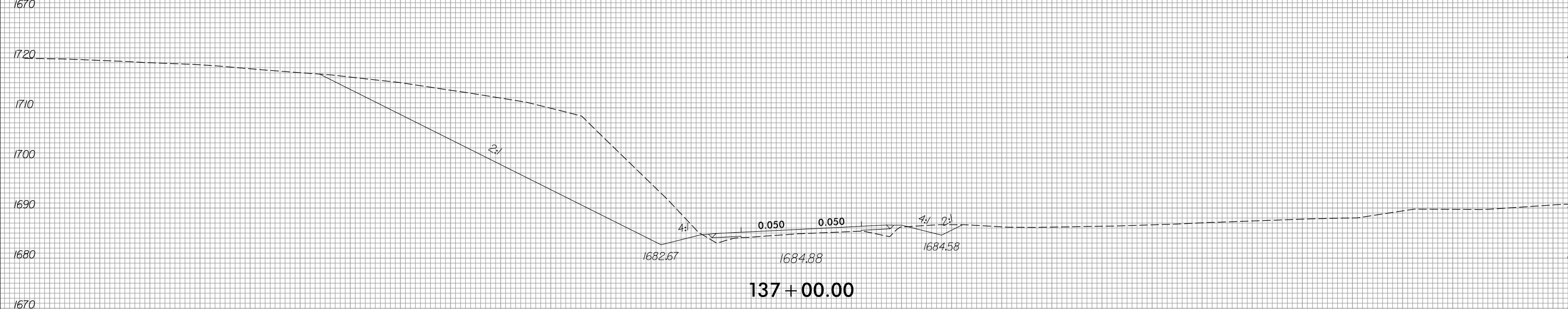
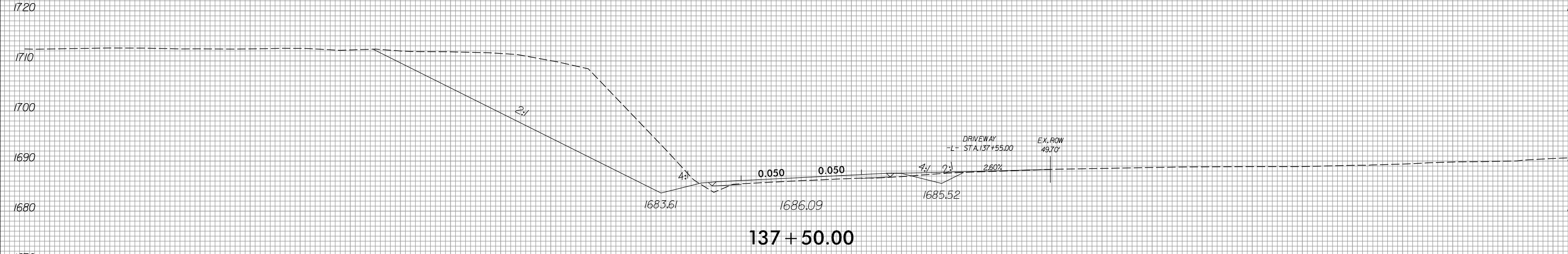
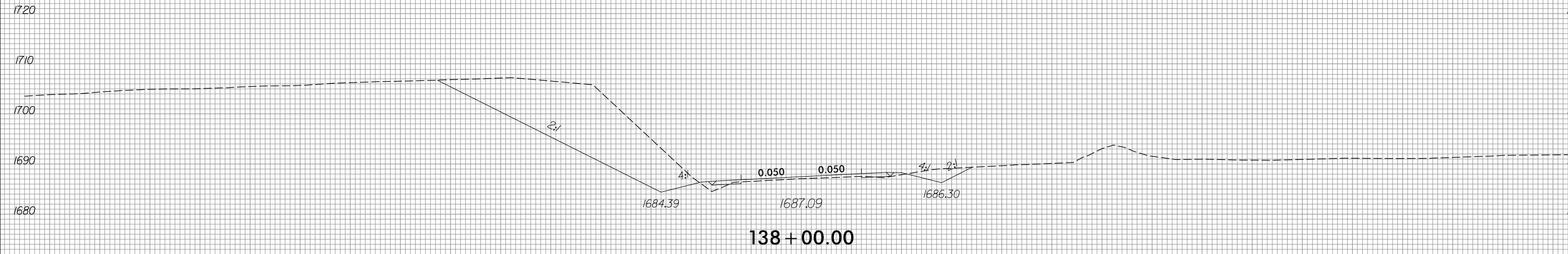

150 140 130 120 110 100 90 80 70 60 50 40 30 20 10 0 10 20 30 40 50 60 70 80 90 100 110 120 130 140 150

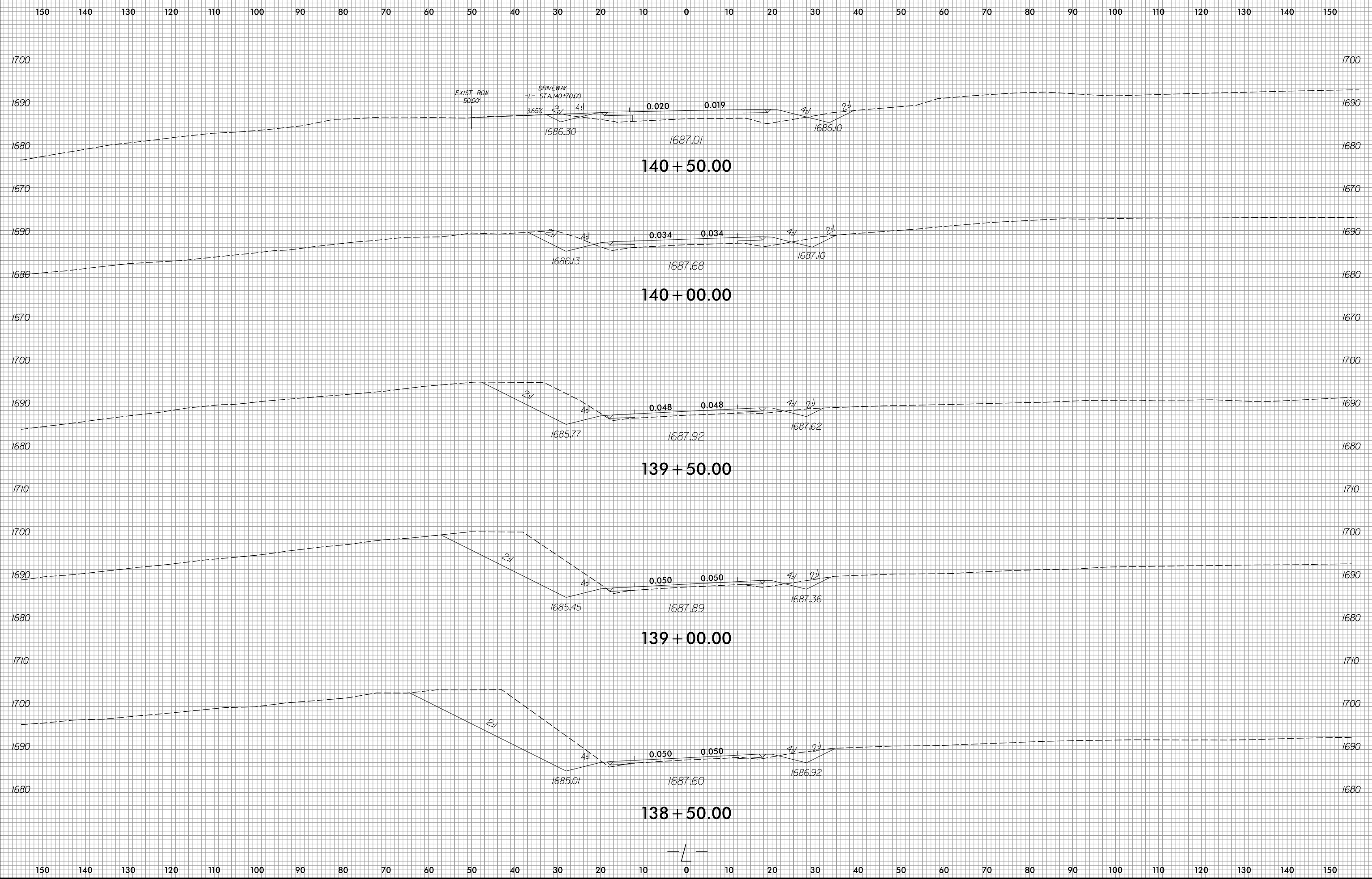



150 140 130 120 110 100 90 80 70 60 50 40 30 20 10 0 10 20 30 40 50 60 70 80 90 100 110 120 130 140 150

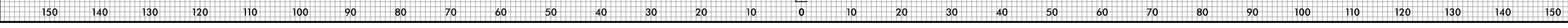
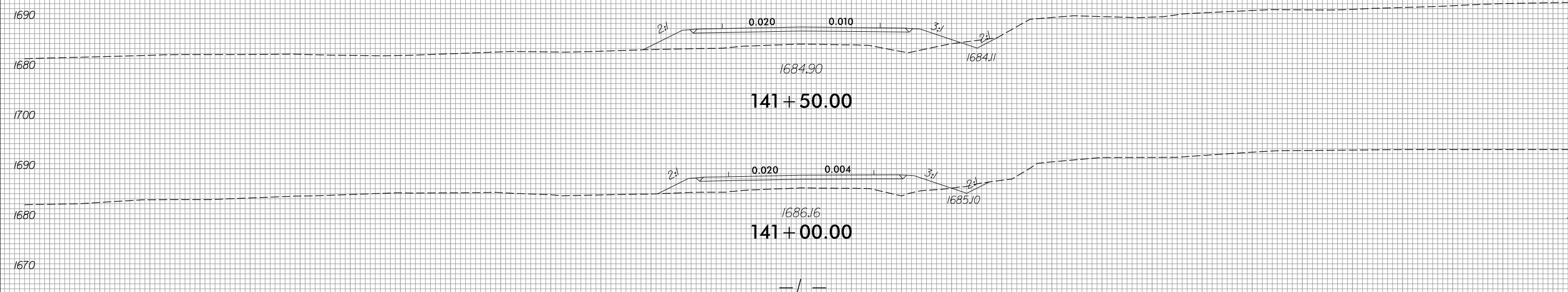
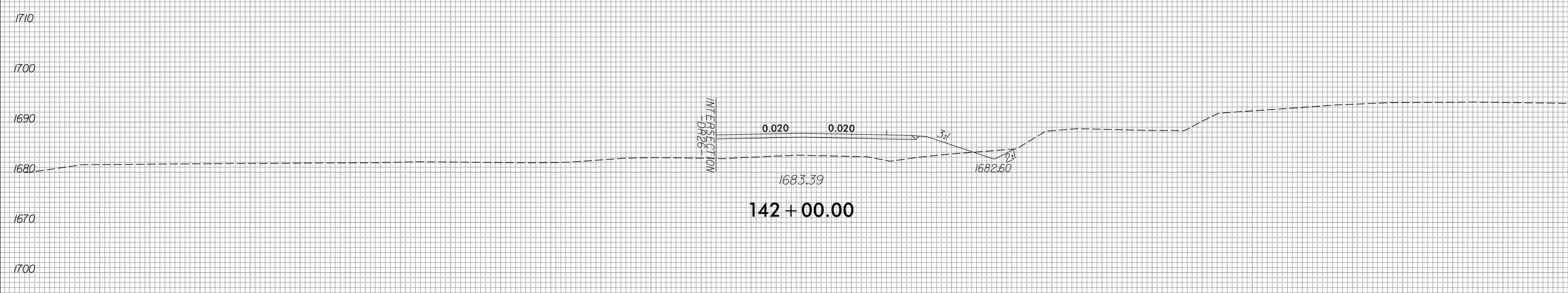
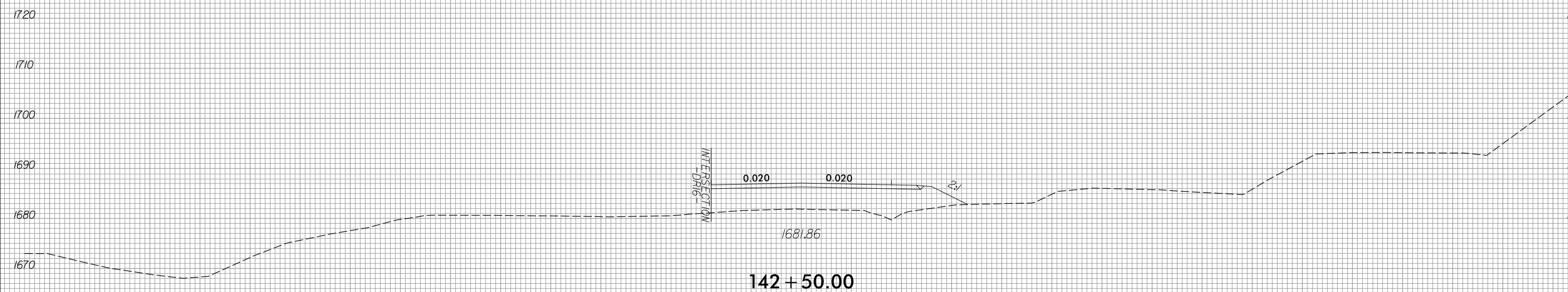

150 140 130 120 110 100 90 80 70 60 50 40 30 20 10 0 10 20 30 40 50 60 70 80 90 100 110 120 130 140 150

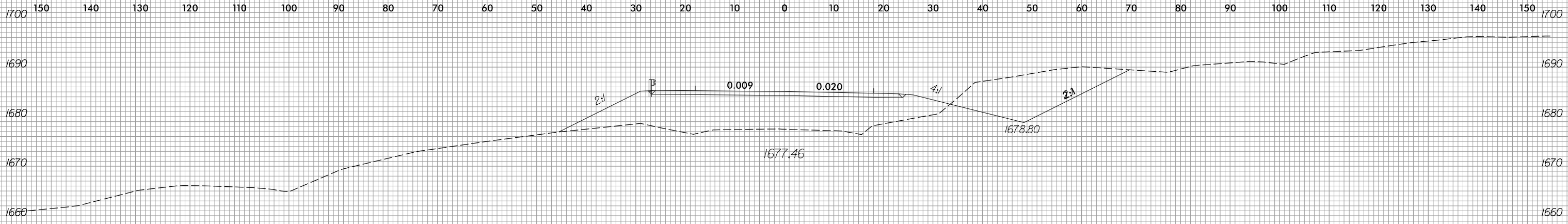

144 + 00.00

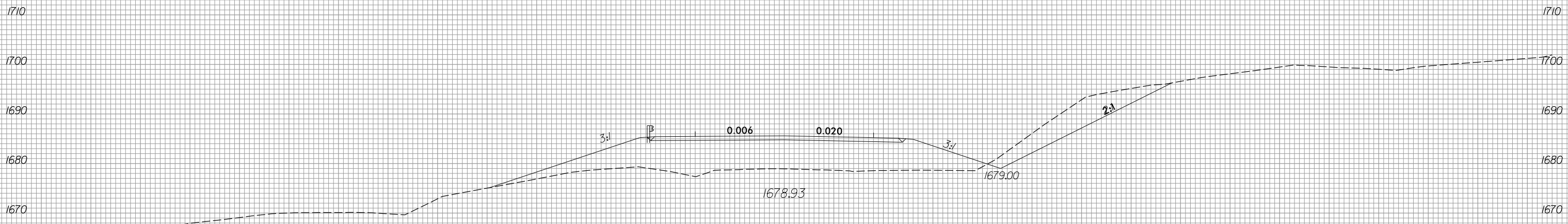

143 + 50.00

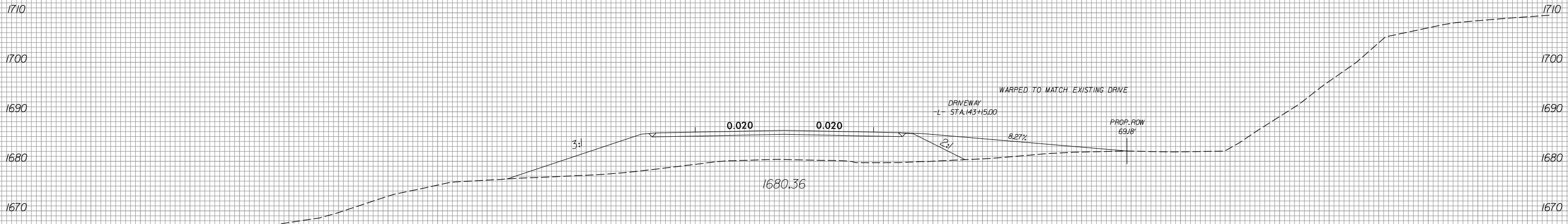

143 + 00.00



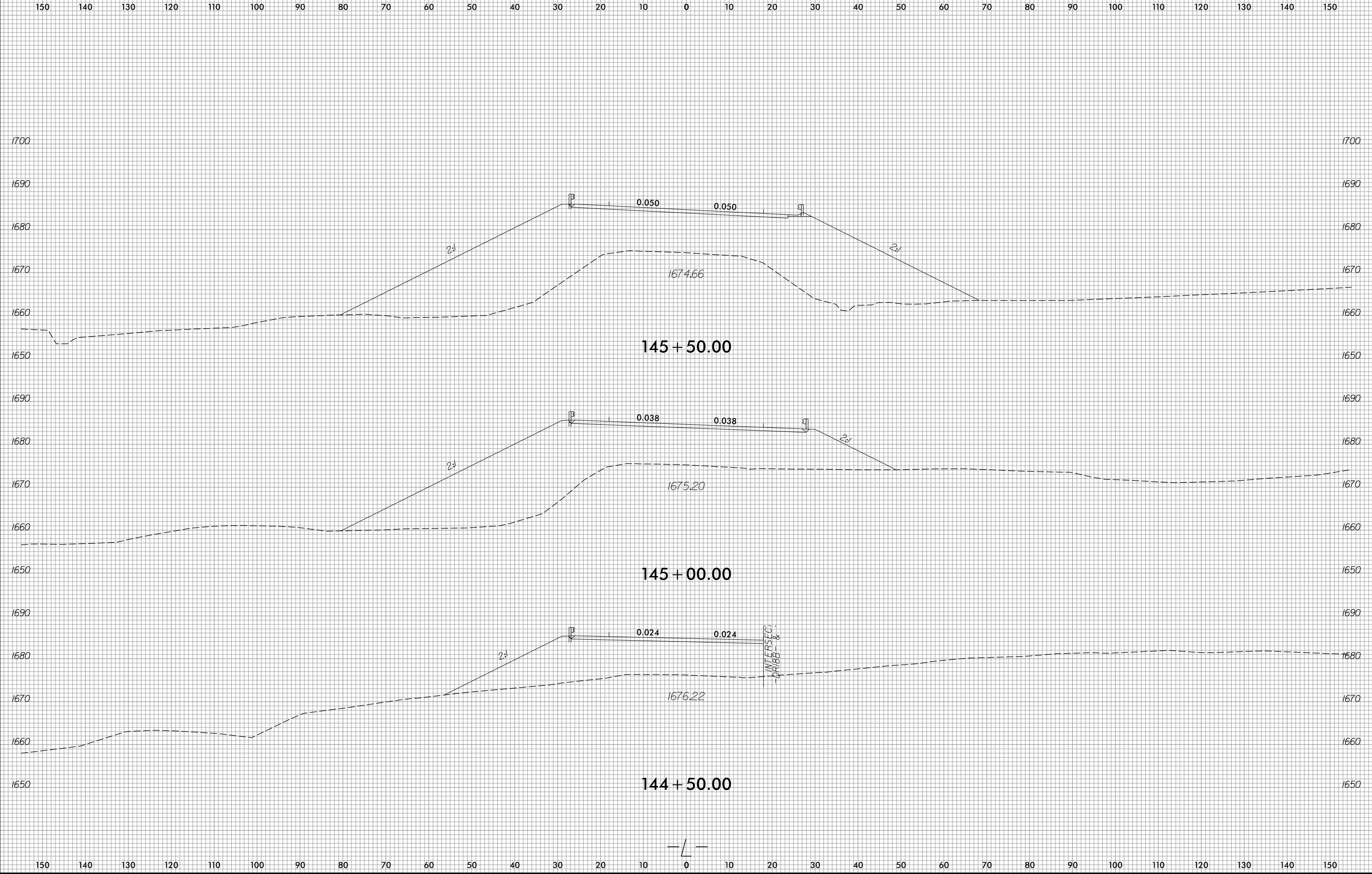



150 140 130 120 110 100 90 80 70 60 50 40 30 20 10 0 10 20 30 40 50 60 70 80 90 100 110 120 130 140 150

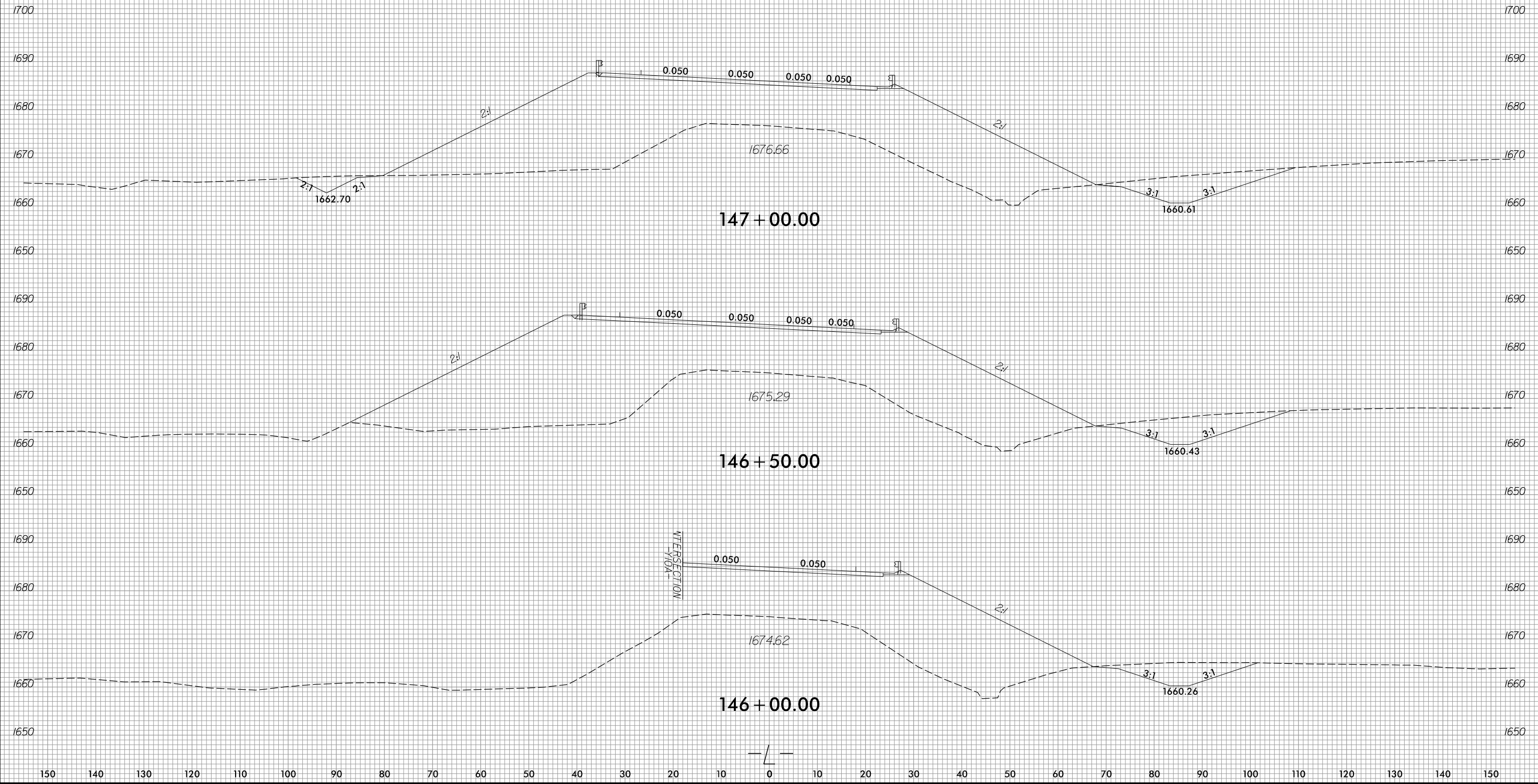

150 140 130 120 110 100 90 80 70 60 50 40 30 20 10 0 10 20 30 40 50 60 70 80 90 100 110 120 130 140 150

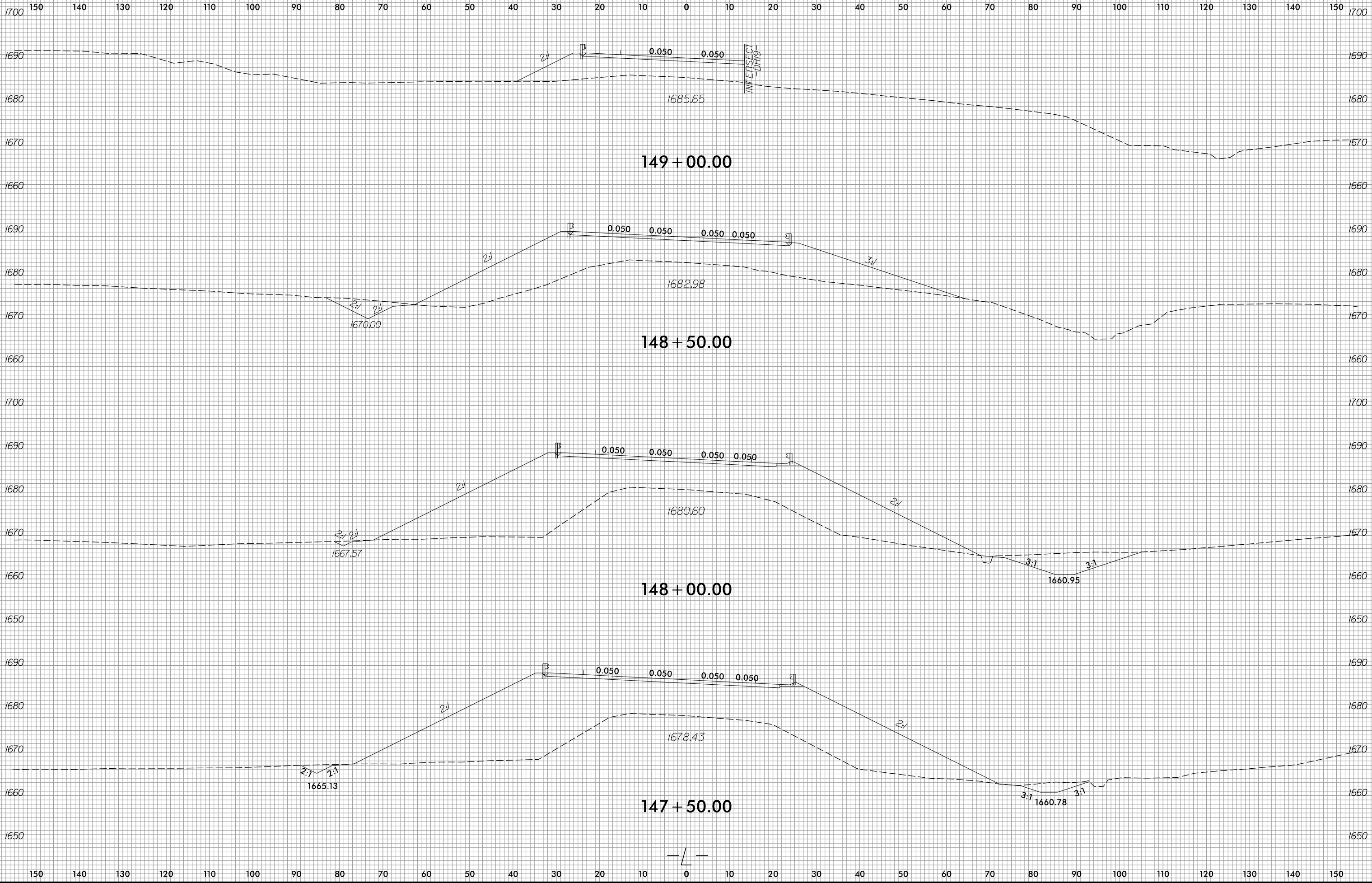
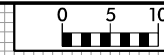

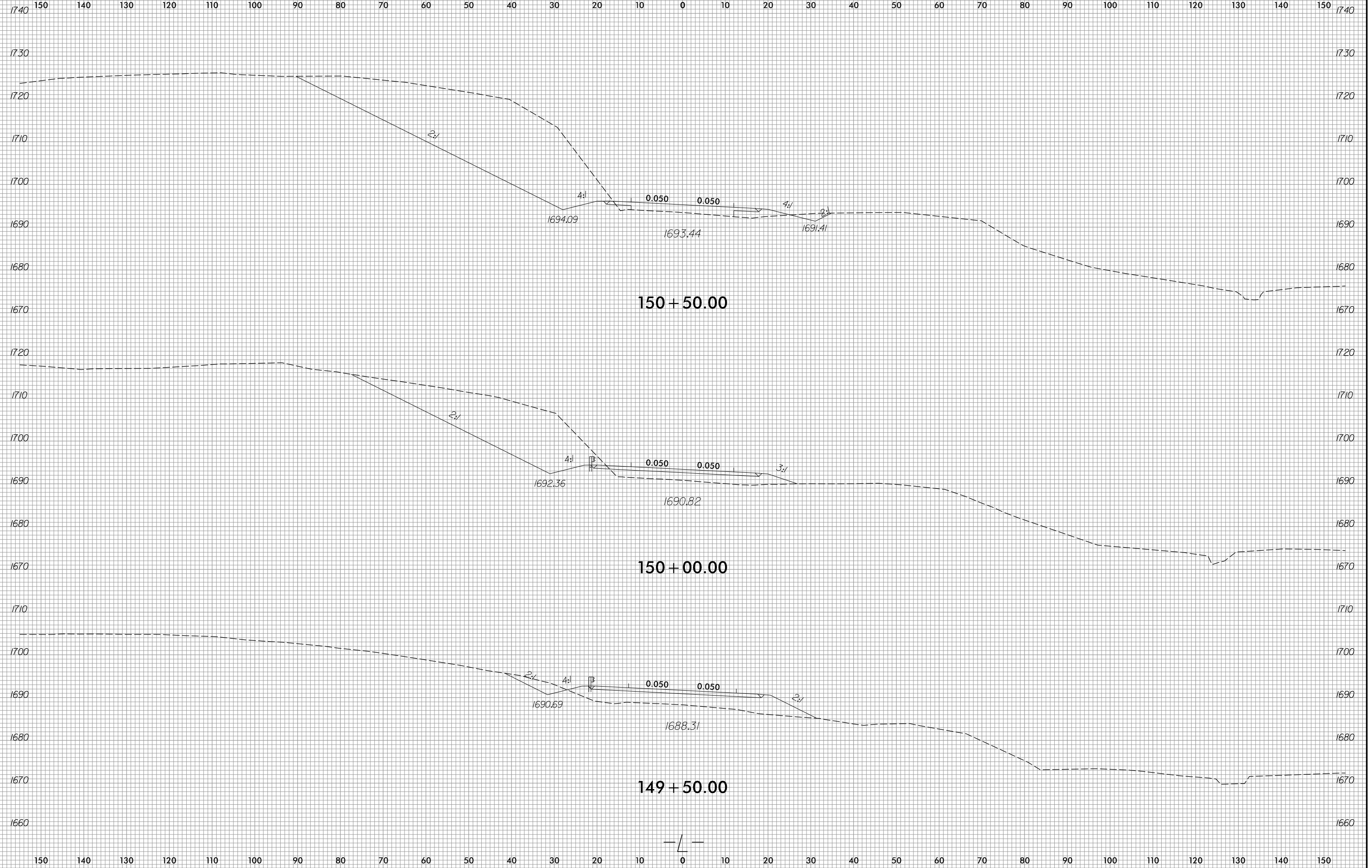
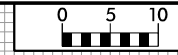

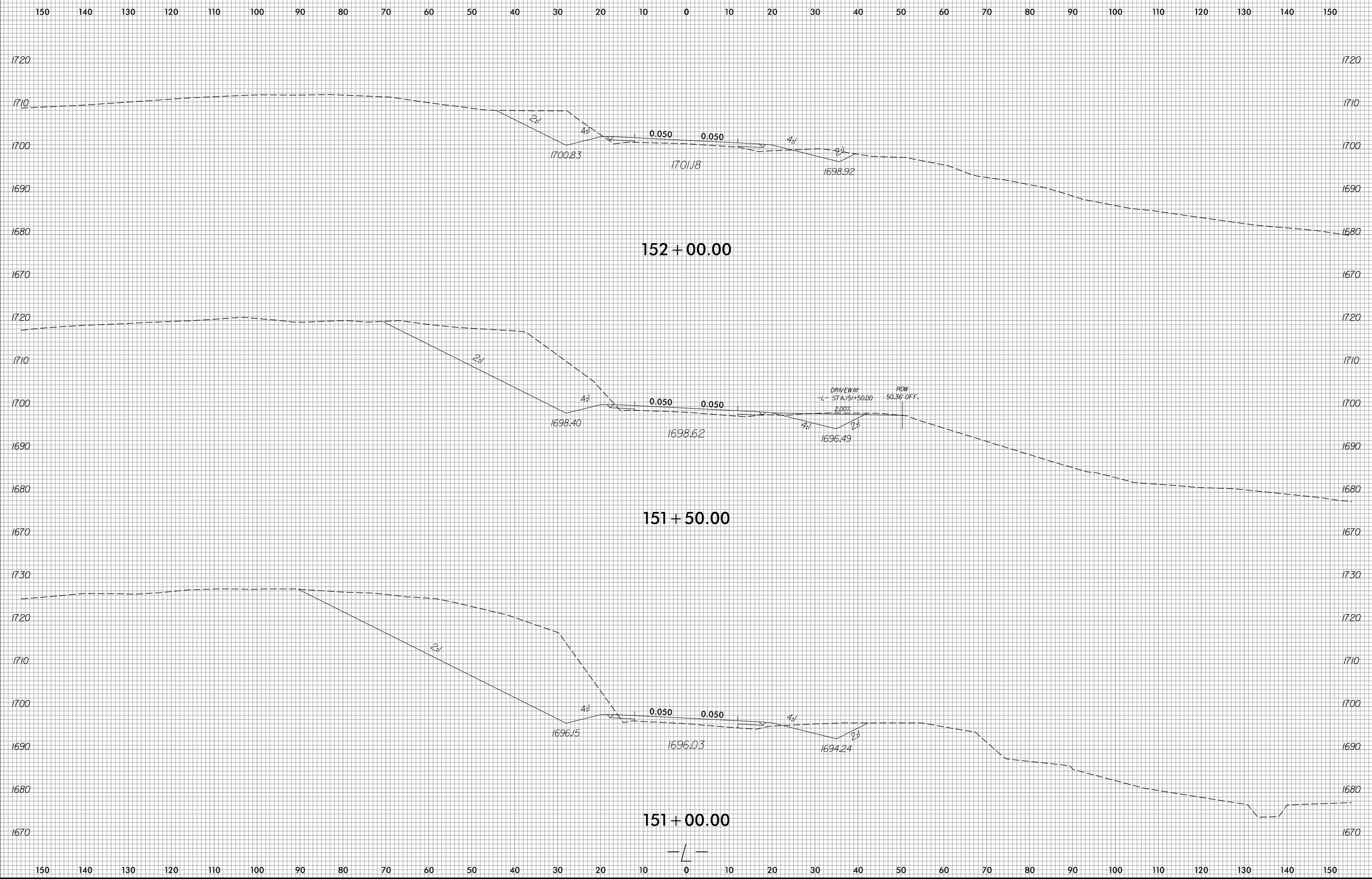



150 140 130 120 110 100 90 80 70 60 50 40 30 20 10 0 10 20 30 40 50 60 70 80 90 100 110 120 130 140 150

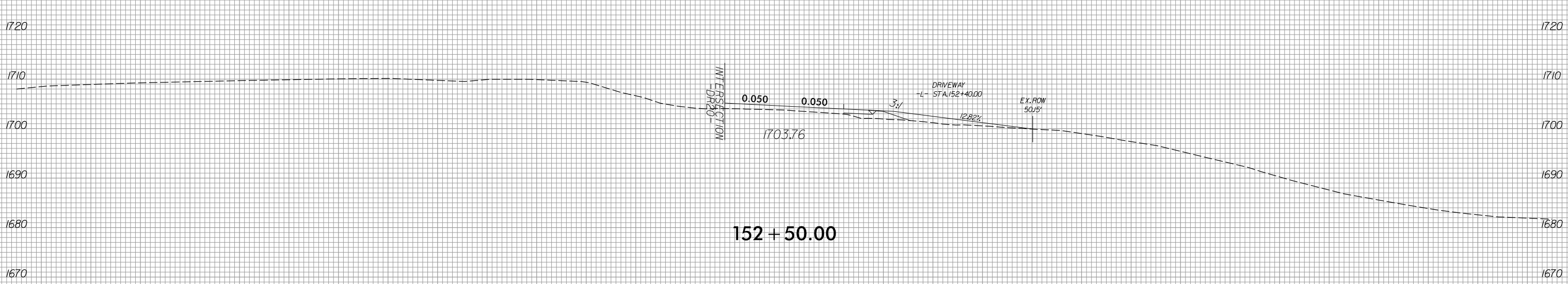
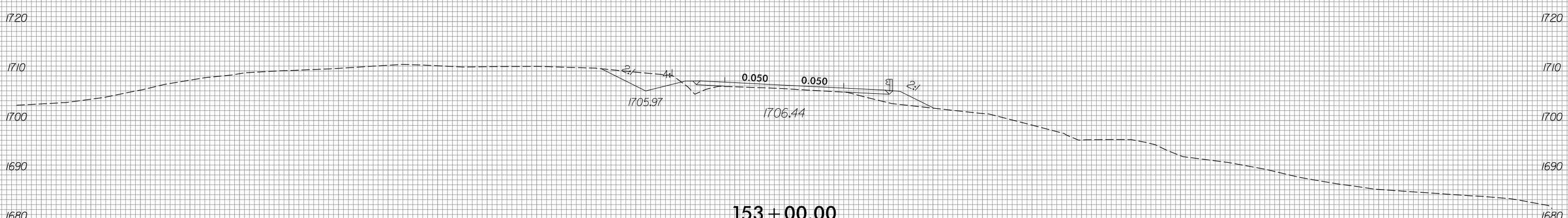
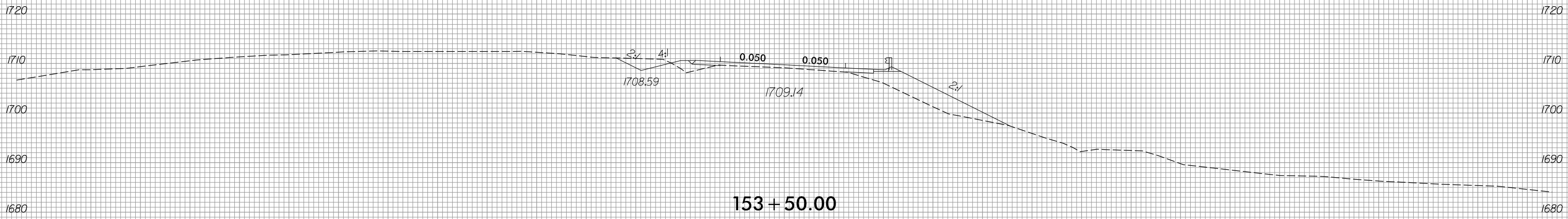

150 140 130 120 110 100 90 80 70 60 50 40 30 20 10 0 10 20 30 40 50 60 70 80 90 100 110 120 130 140 150



150 140 130 120 110 100 90 80 70 60 50 40 30 20 10 0 10 20 30 40 50 60 70 80 90 100 110 120 130 140 150

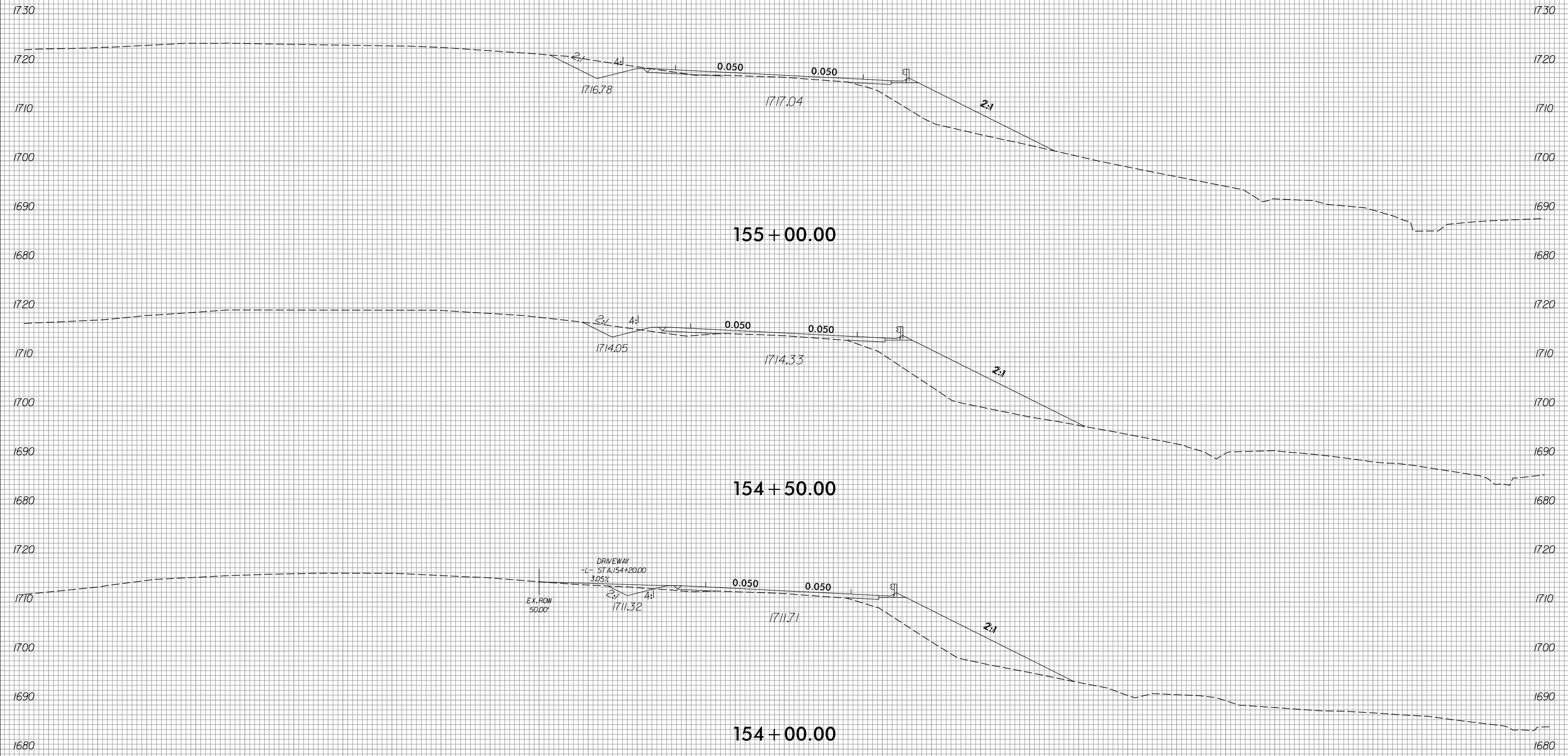

150 140 130 120 110 100 90 80 70 60 50 40 30 20 10 0 10 20 30 40 50 60 70 80 90 100 110 120 130 140 150

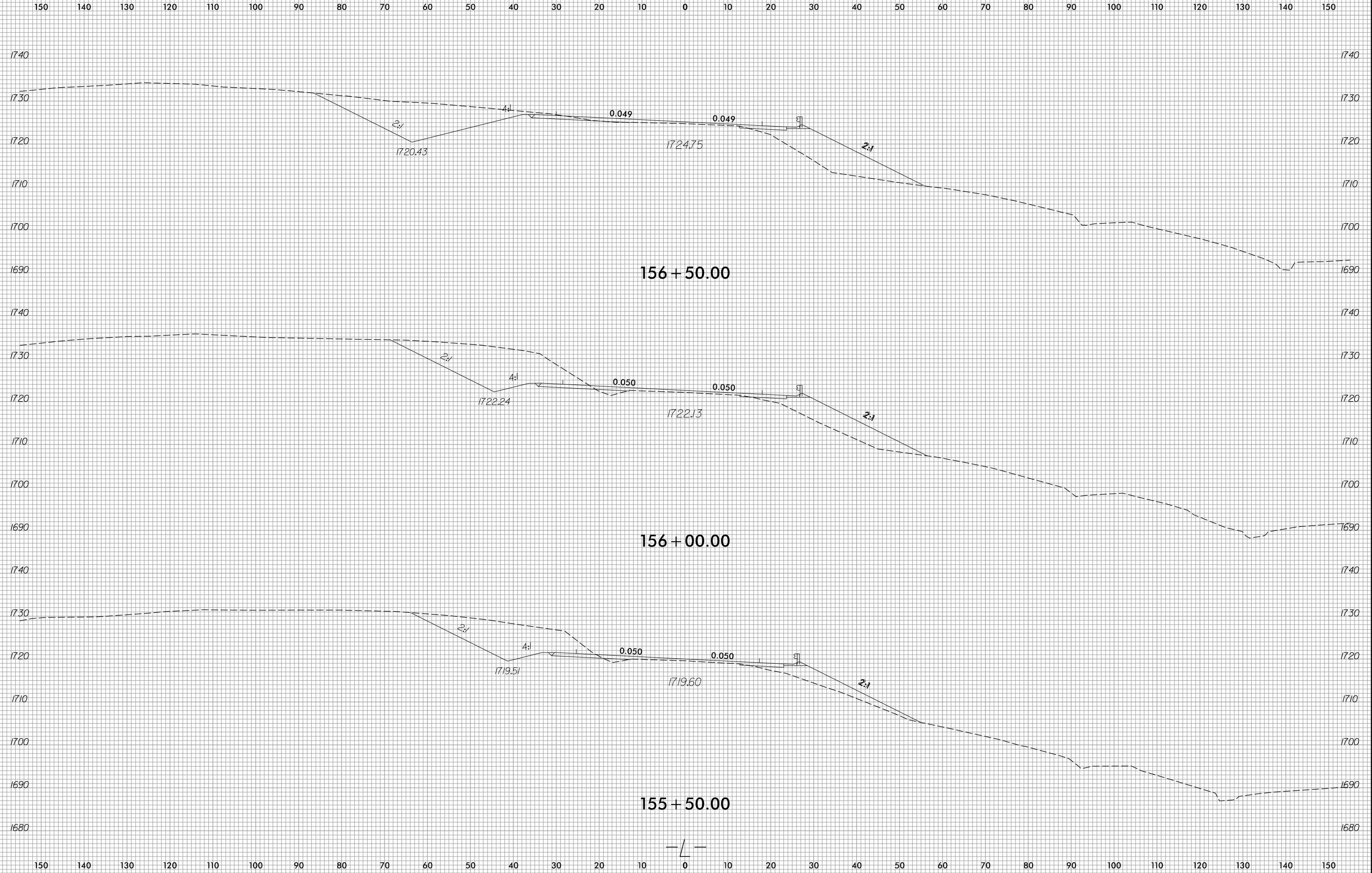



150 140 130 120 110 100 90 80 70 60 50 40 30 20 10 0 10 20 30 40 50 60 70 80 90 100 110 120 130 140 150

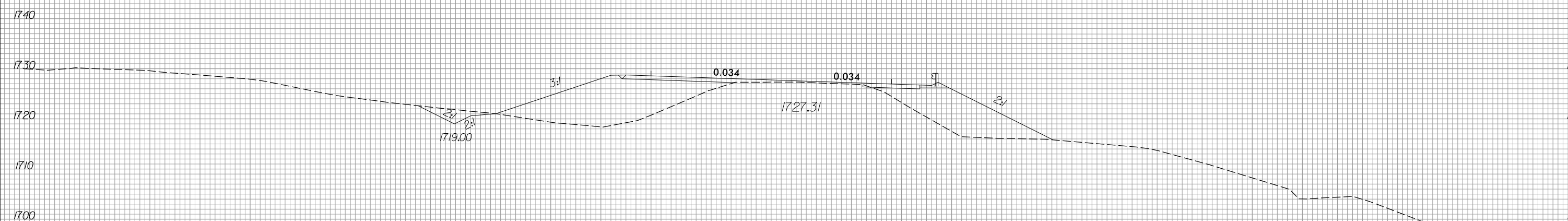
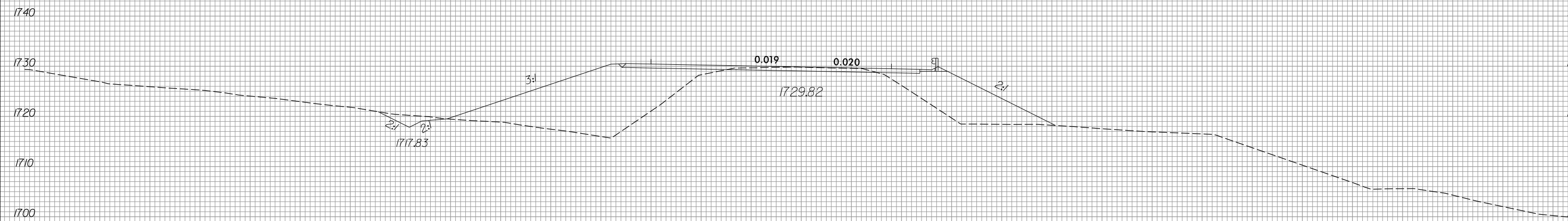
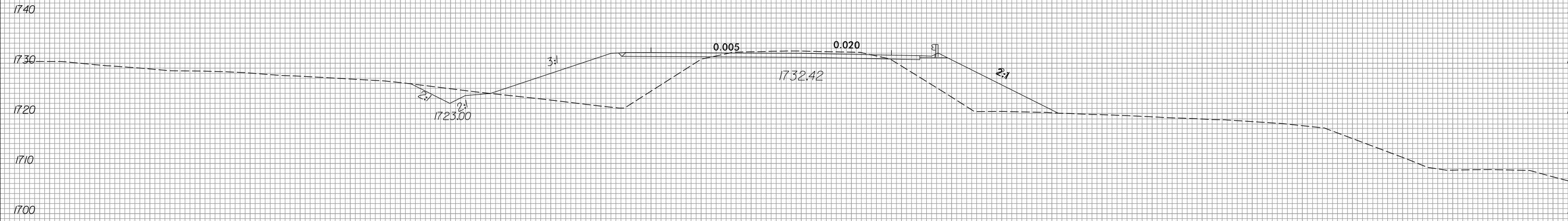

150 140 130 120 110 100 90 80 70 60 50 40 30 20 10 0 10 20 30 40 50 60 70 80 90 100 110 120 130 140 150

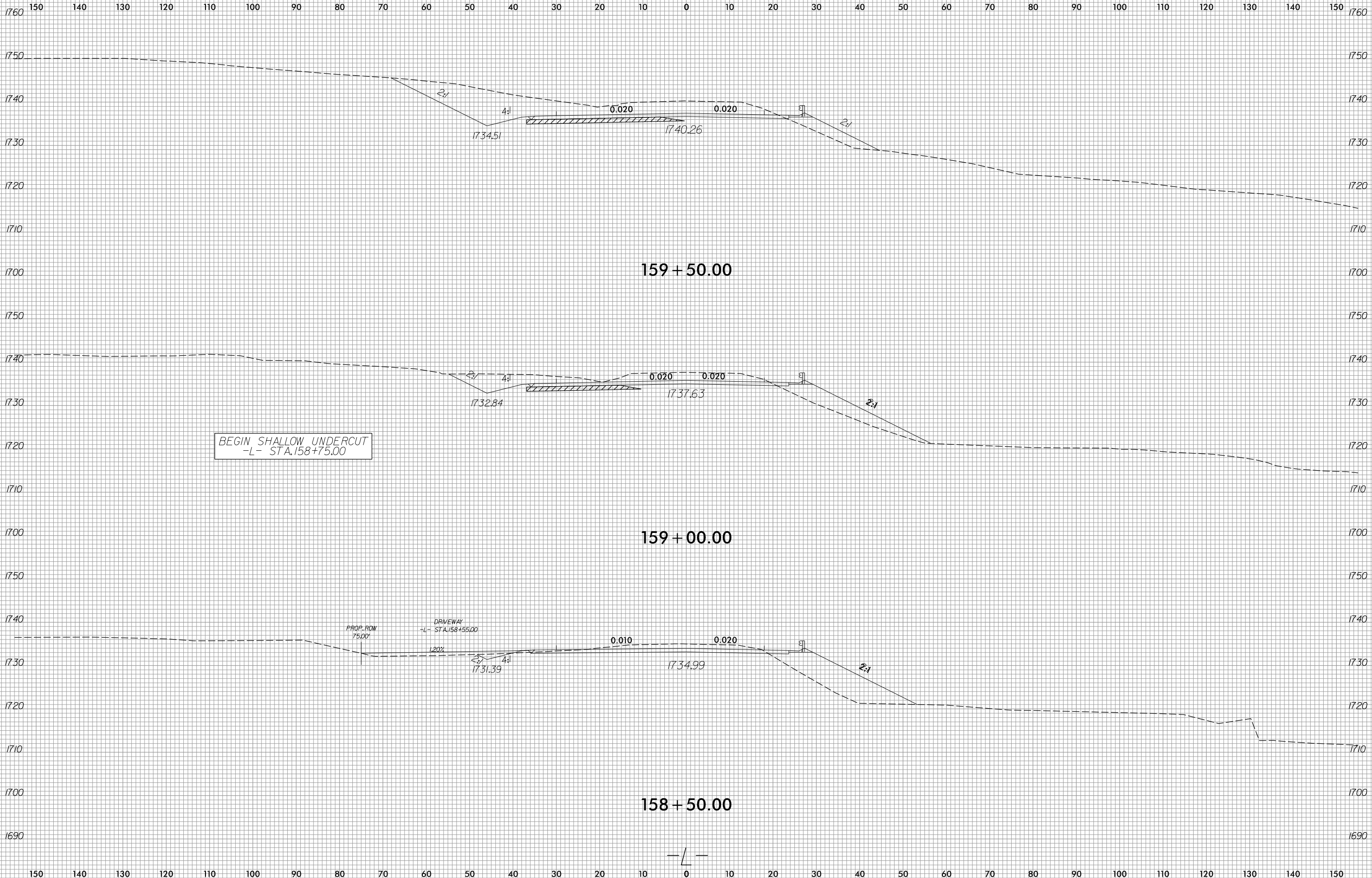



150 140 130 120 110 100 90 80 70 60 50 40 30 20 10 0 10 20 30 40 50 60 70 80 90 100 110 120 130 140 150

END SHALLOW UNDERCUT
-L- STA. 160+75.00

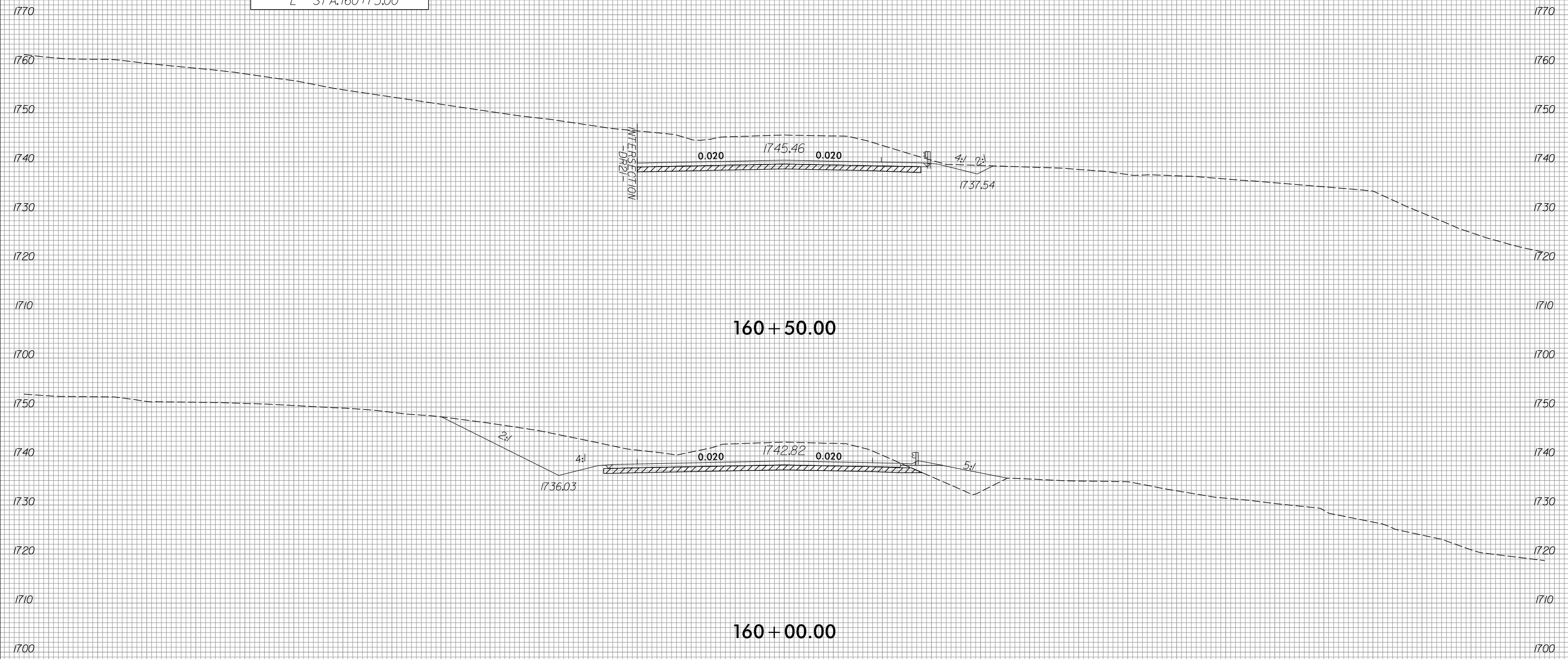

160 + 50.00

160 + 00.00





150 140 130 120 110 100 90 80 70 60 50 40 30 20 10 0 10 20 30 40 50 60 70 80 90 100 110 120 130 140 150

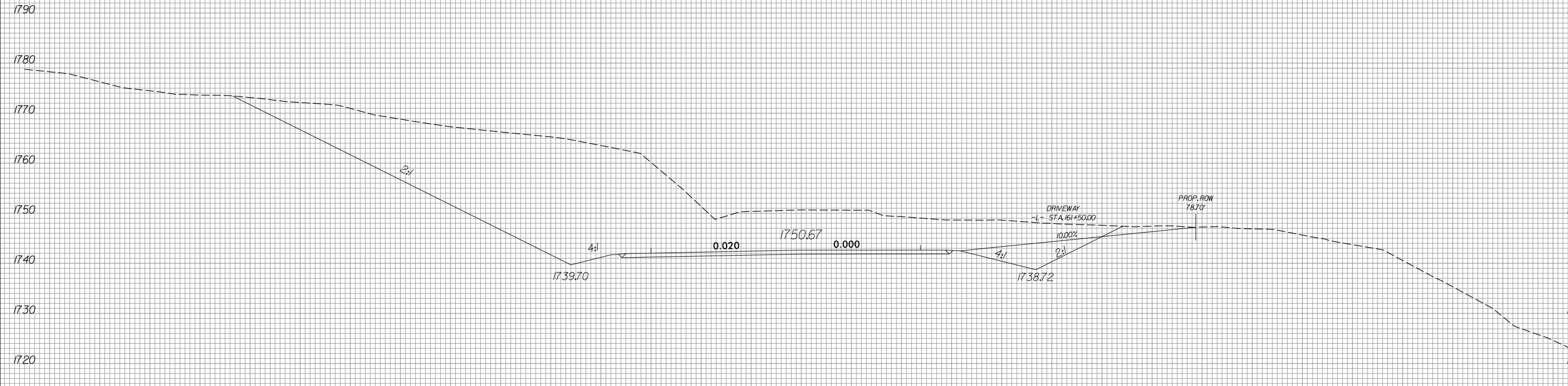

161 + 50.00

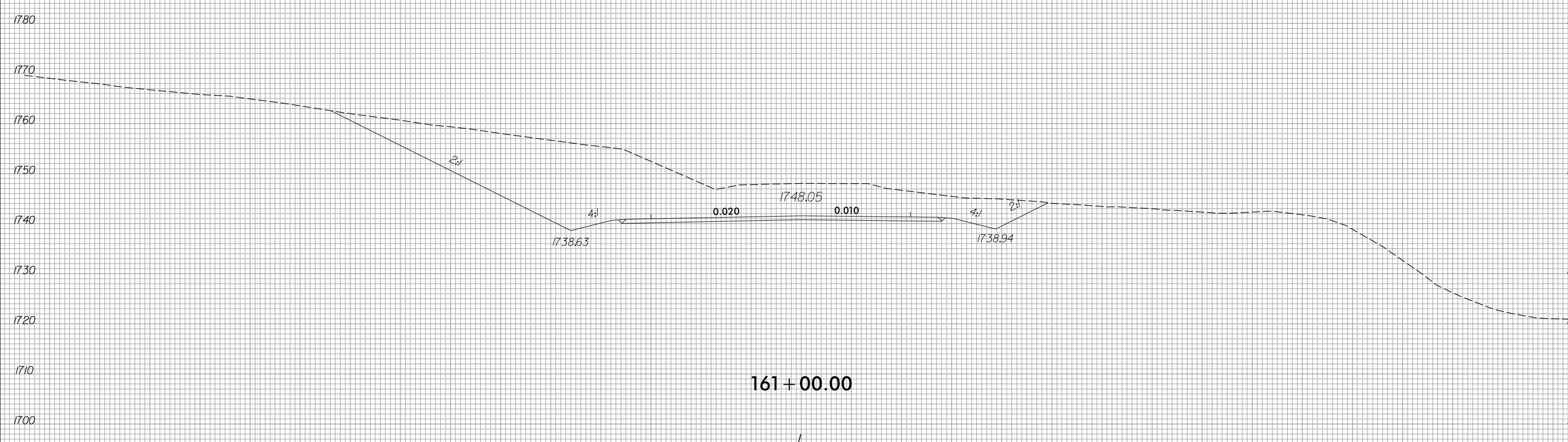

161 + 00.00

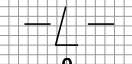

150 140 130 120 110 100 90 80 70 60 50 40 30 20 10 0 10 20 30 40 50 60 70 80 90 100 110 120 130 140 150

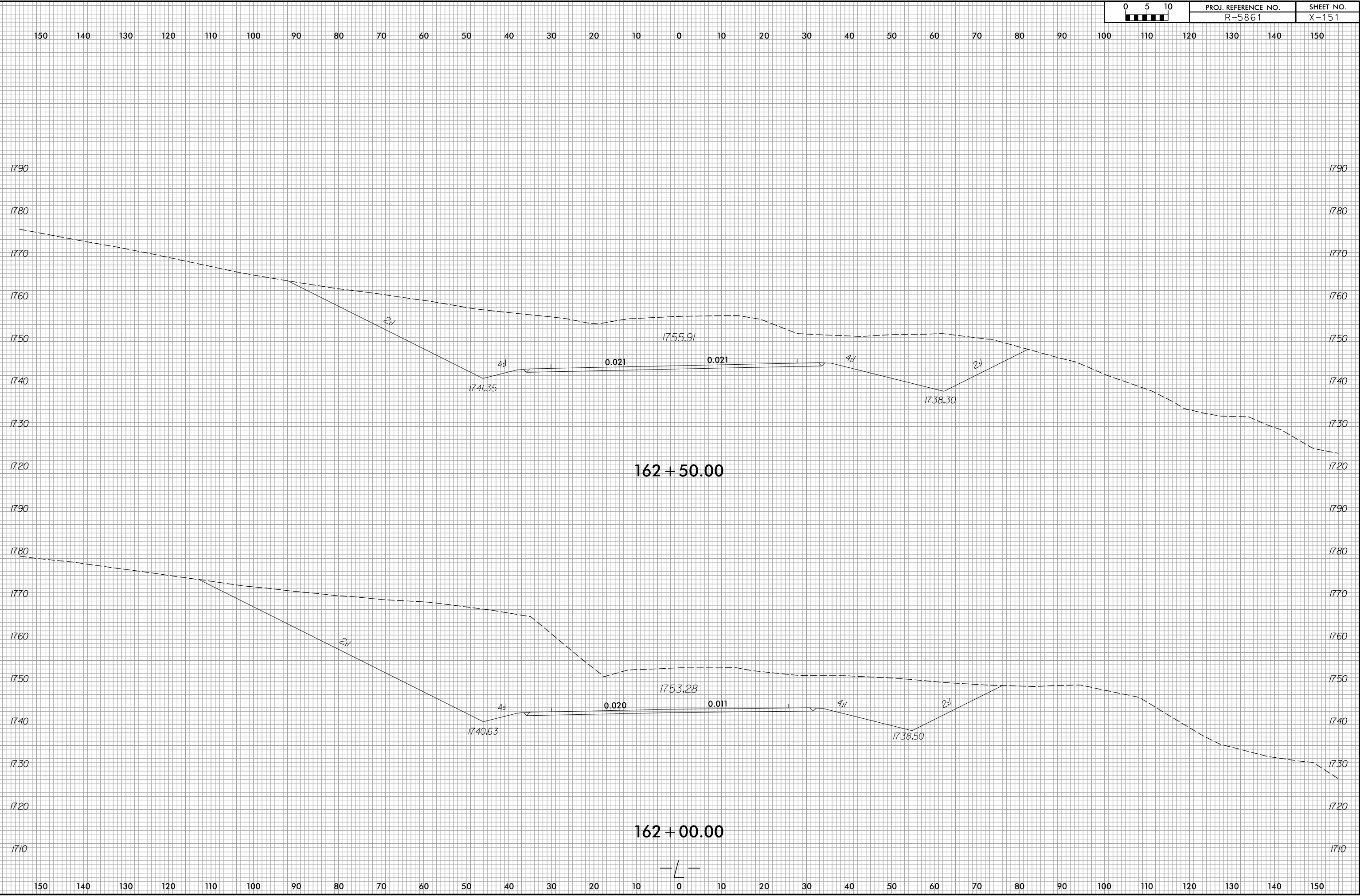



150 140 130 120 110 100 90 80 70 60 50 40 30 20 10 0 10 20 30 40 50 60 70 80 90 100 110 120 130 140 150

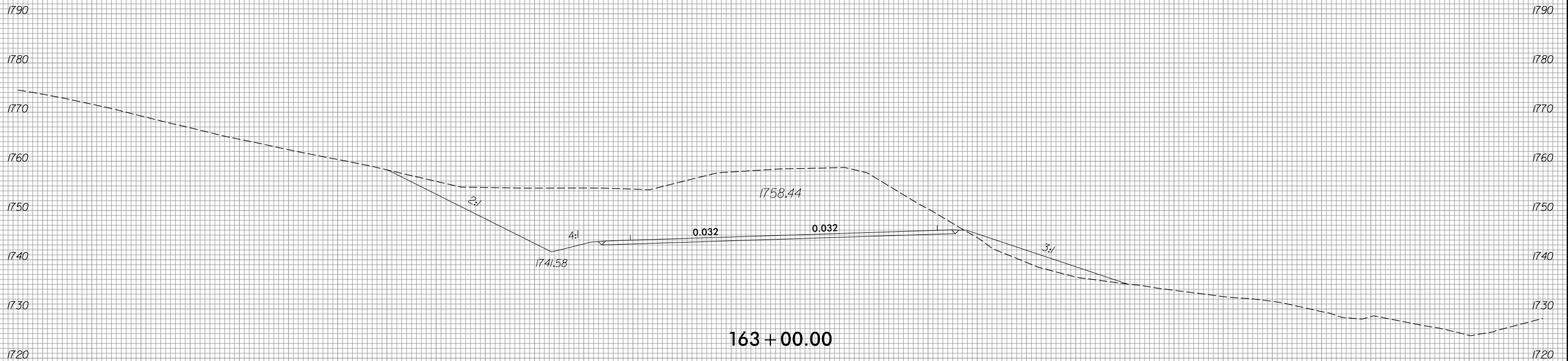
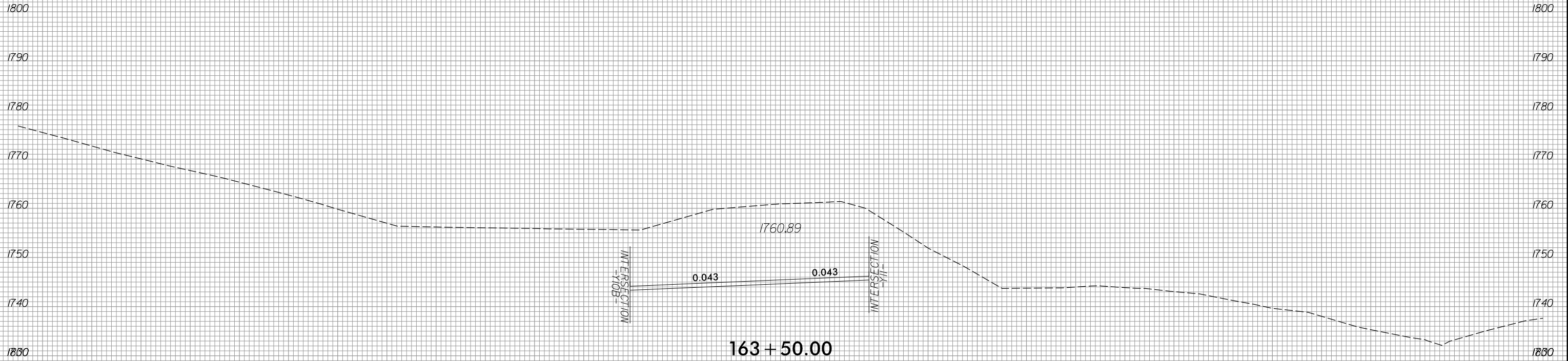

150 140 130 120 110 100 90 80 70 60 50 40 30 20 10 0 10 20 30 40 50 60 70 80 90 100 110 120 130 140 150



150 140 130 120 110 100 90 80 70 60 50 40 30 20 10 0 10 20 30 40 50 60 70 80 90 100 110 120 130 140 150

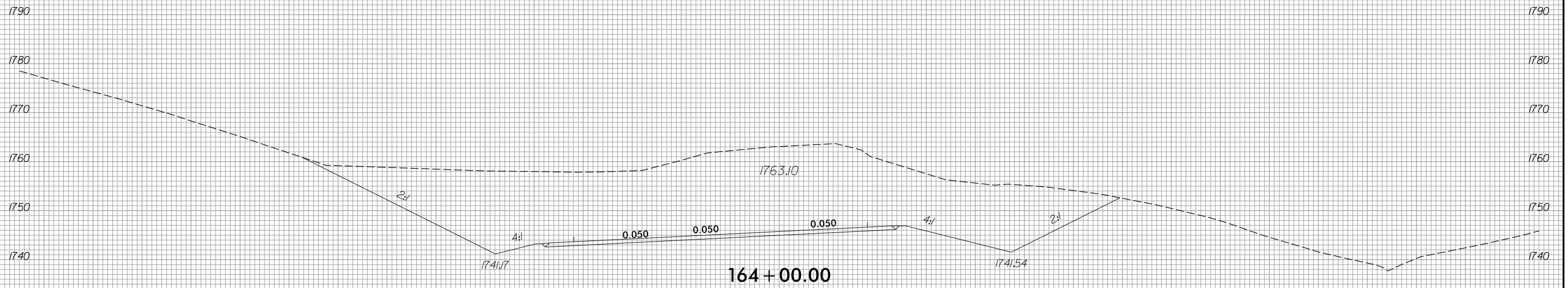
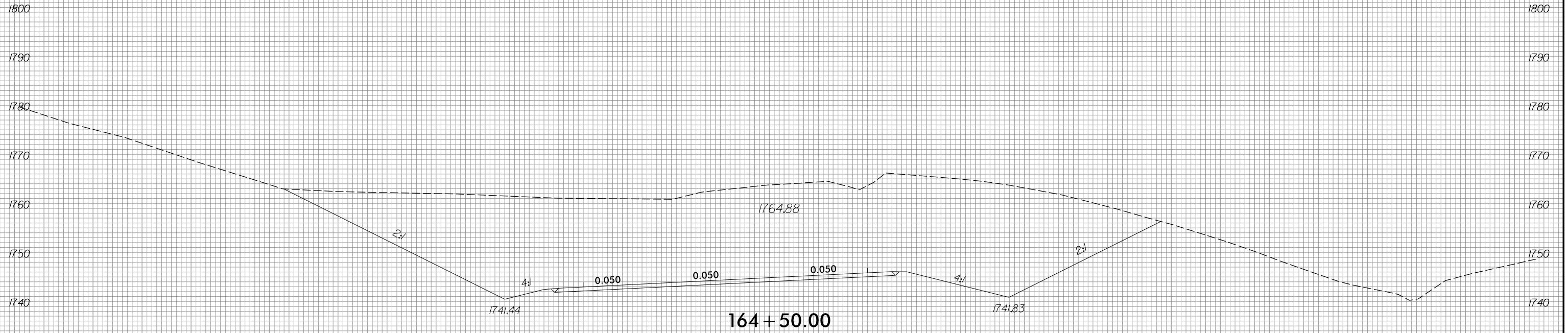



150 140 130 120 110 100 90 80 70 60 50 40 30 20 10 0 10 20 30 40 50 60 70 80 90 100 110 120 130 140 150

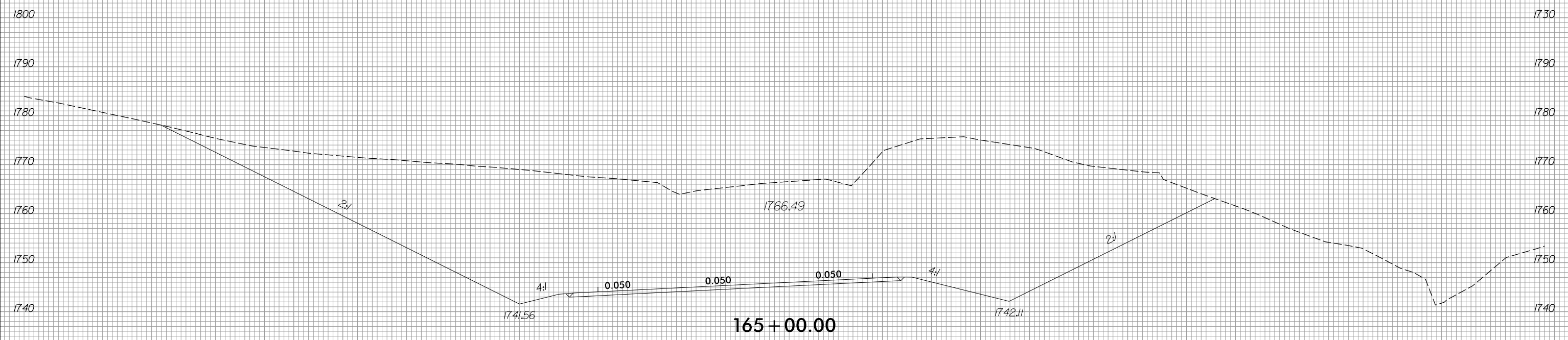
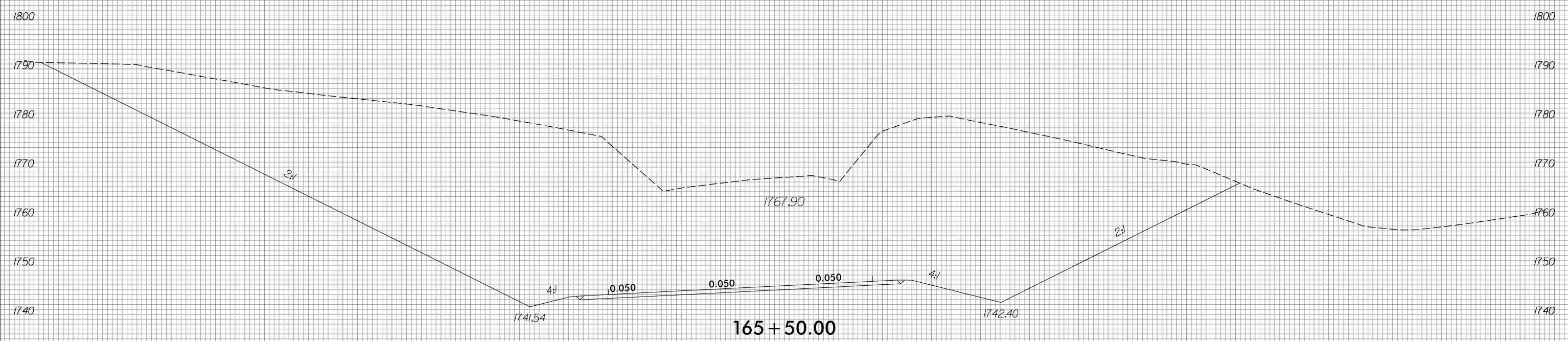

150 140 130 120 110 100 90 80 70 60 50 40 30 20 10 0 10 20 30 40 50 60 70 80 90 100 110 120 130 140 150



150 140 130 120 110 100 90 80 70 60 50 40 30 20 10 0 10 20 30 40 50 60 70 80 90 100 110 120 130 140 150

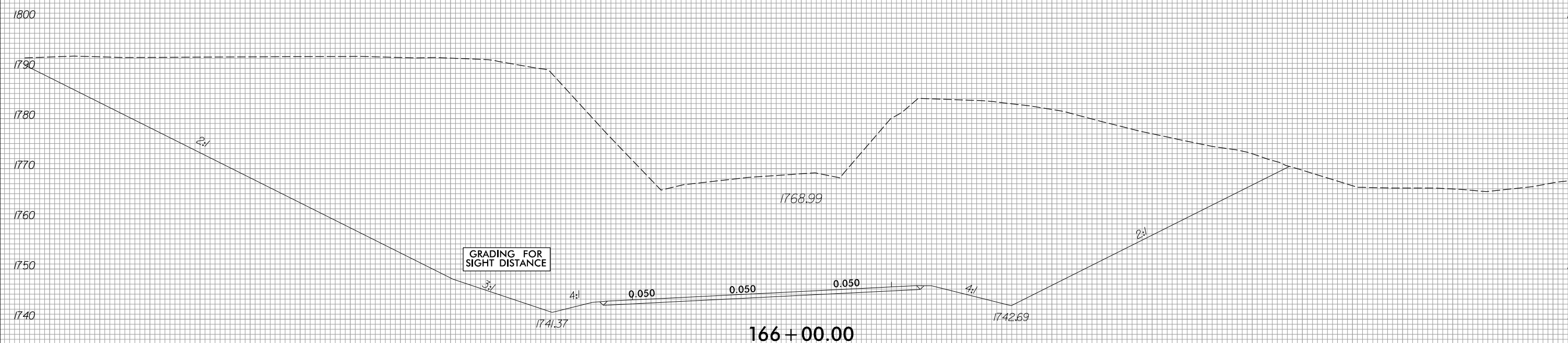
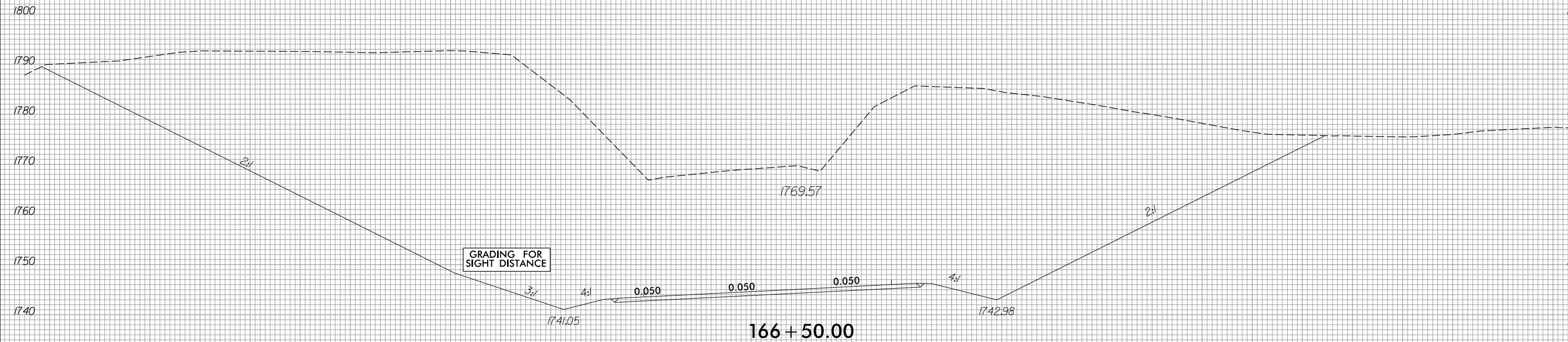

150 140 130 120 110 100 90 80 70 60 50 40 30 20 10 0 10 20 30 40 50 60 70 80 90 100 110 120 130 140 150

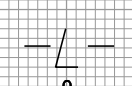
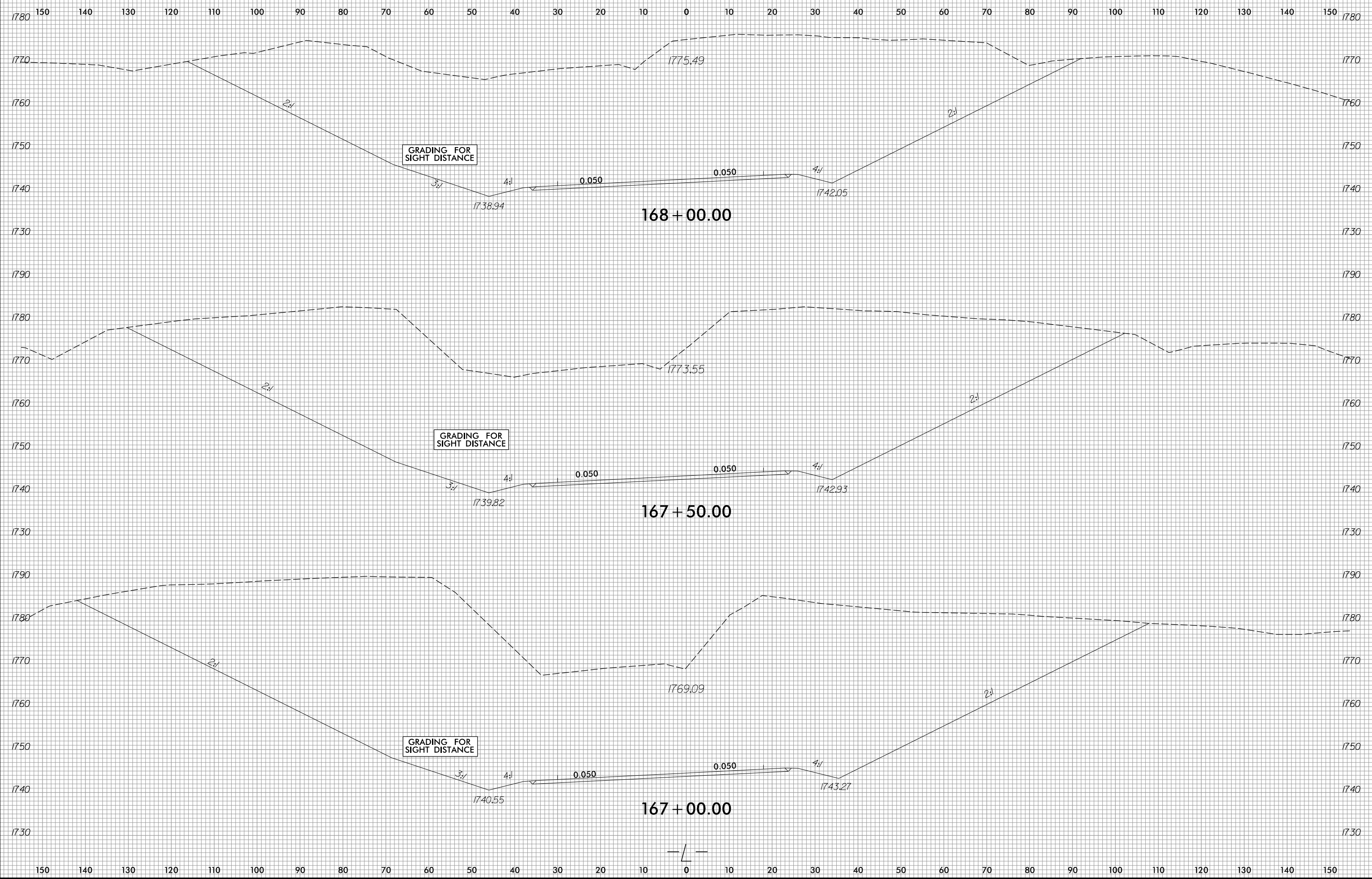

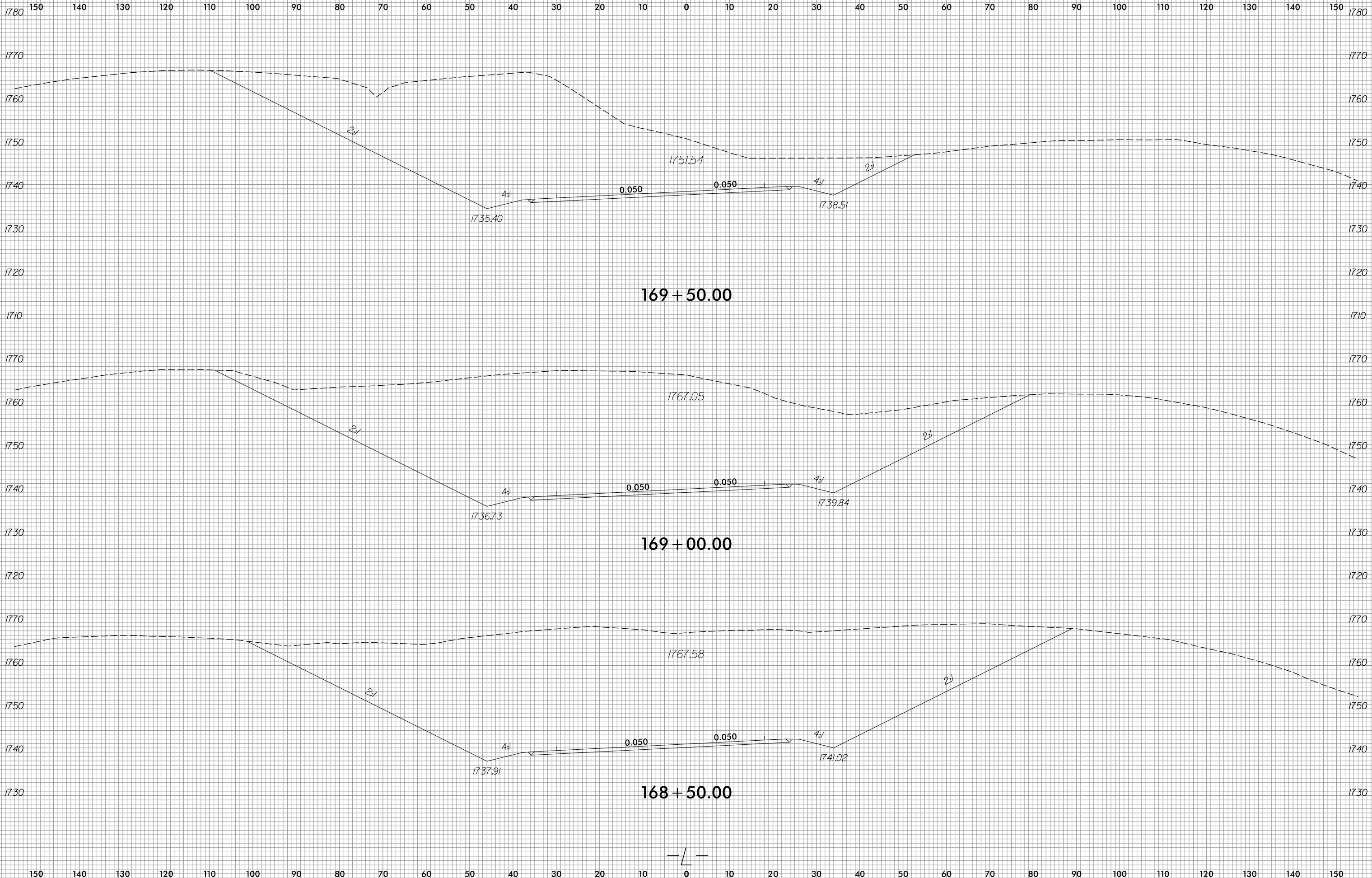



150 140 130 120 110 100 90 80 70 60 50 40 30 20 10 0 10 20 30 40 50 60 70 80 90 100 110 120 130 140 150

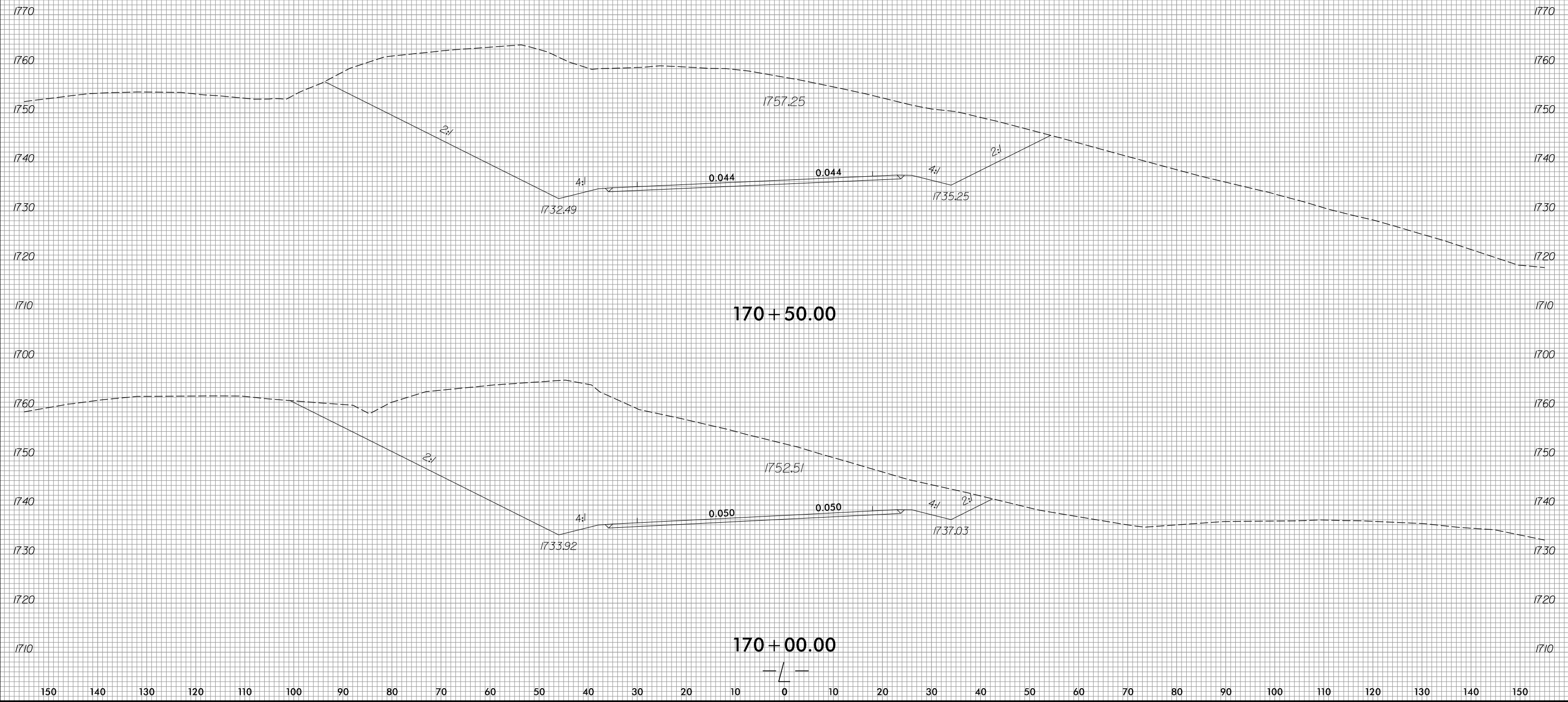



150 140 130 120 110 100 90 80 70 60 50 40 30 20 10 0 10 20 30 40 50 60 70 80 90 100 110 120 130 140 150

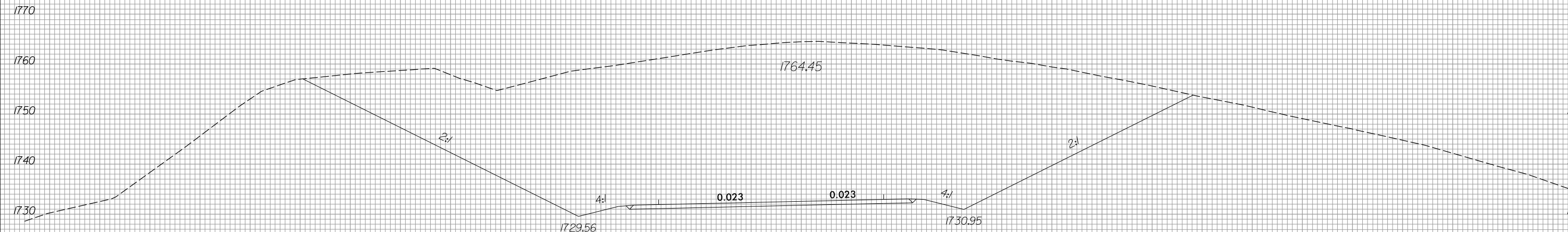

171 + 50.00



171 + 00.00

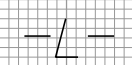

150 140 130 120 110 100 90 80 70 60 50 40 30 20 10 0 10 20 30 40 50 60 70 80 90 100 110 120 130 140 150

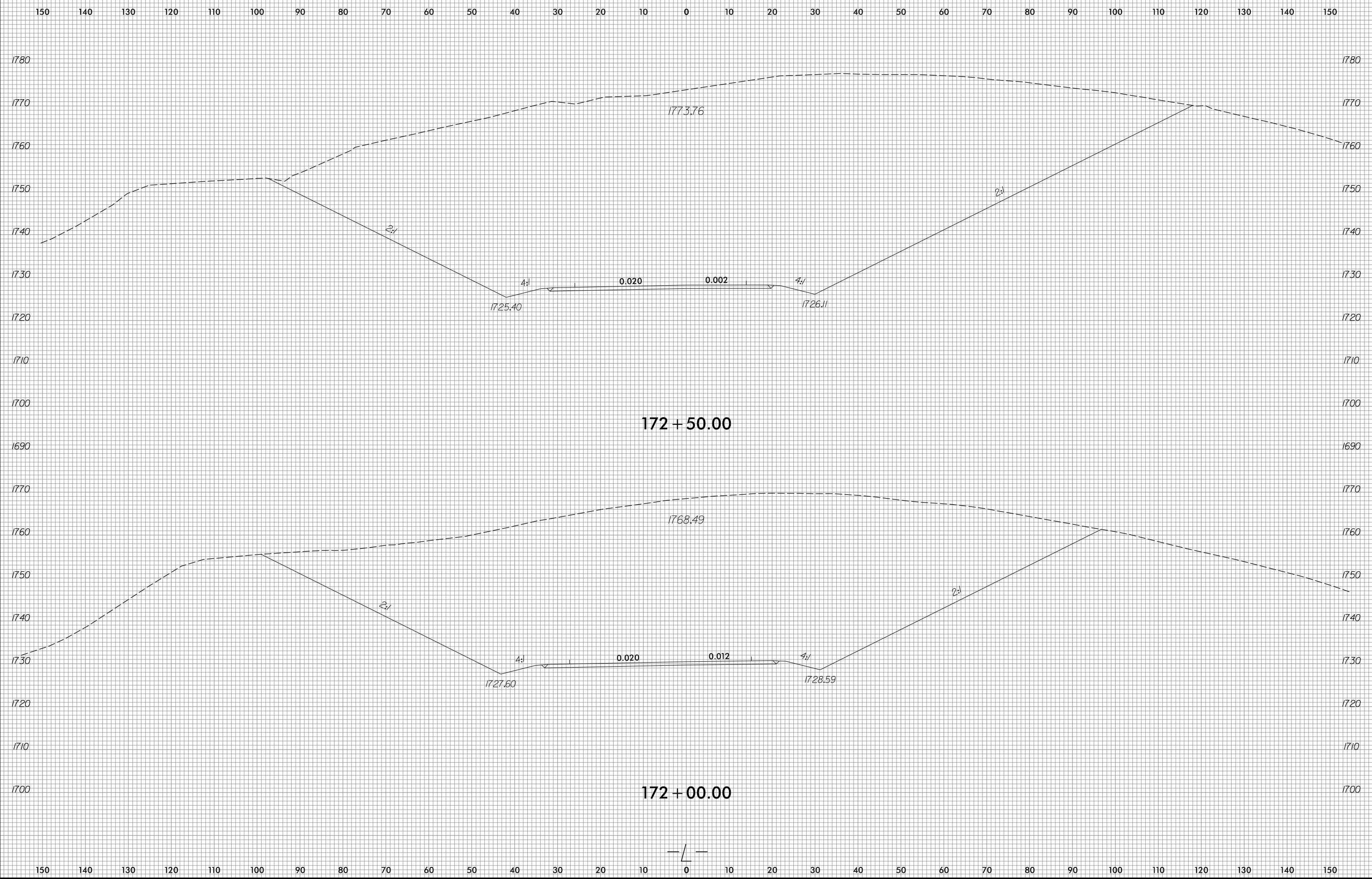



150 140 130 120 110 100 90 80 70 60 50 40 30 20 10 0 10 20 30 40 50 60 70 80 90 100 110 120 130 140 150

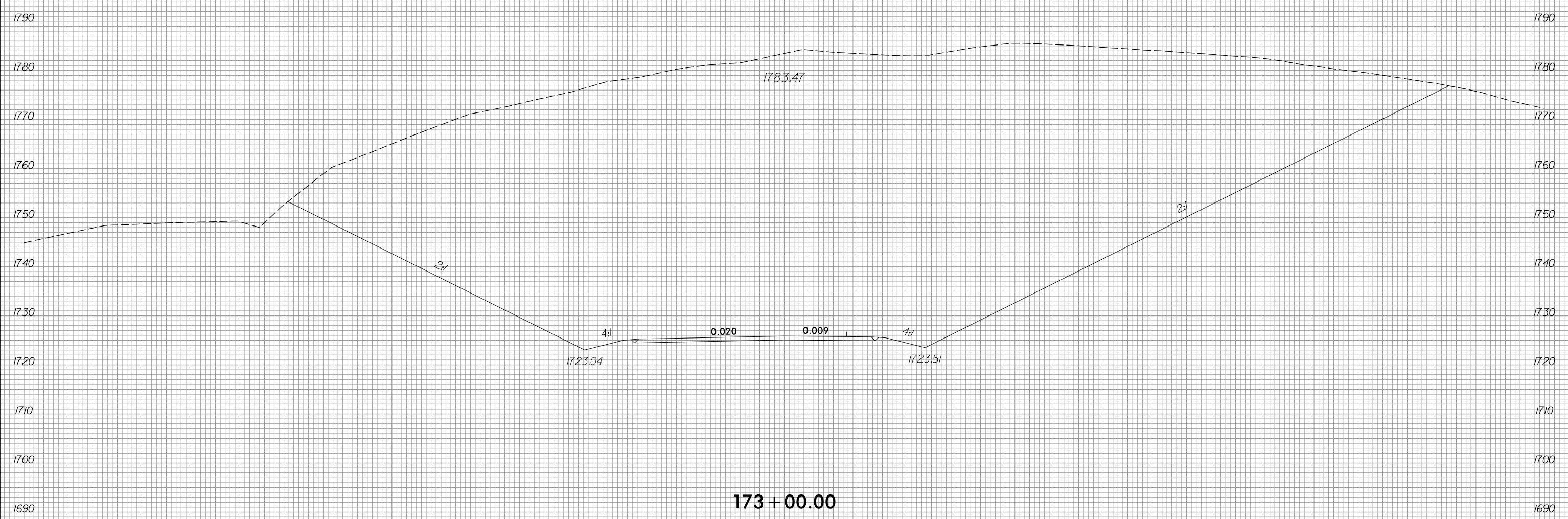

173 + 00.00

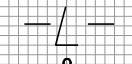

150 140 130 120 110 100 90 80 70 60 50 40 30 20 10 0 10 20 30 40 50 60 70 80 90 100 110 120 130 140 150

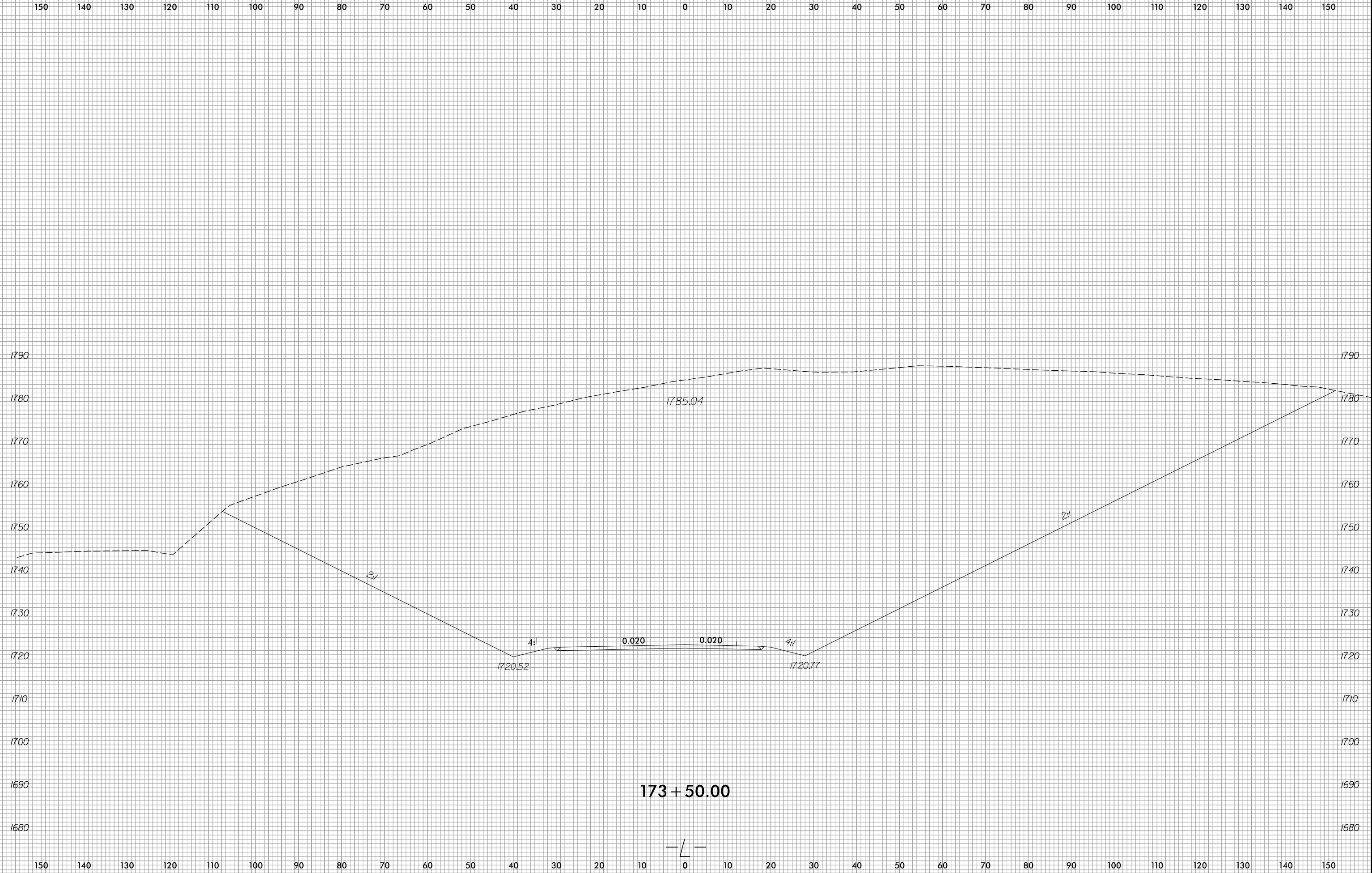
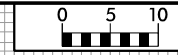



120 110 100 90 80 70 60 50 40 30 20 10 0 10 20 30 40 50 60 70 80 90 100 110 120 130 140 150 160 170 180

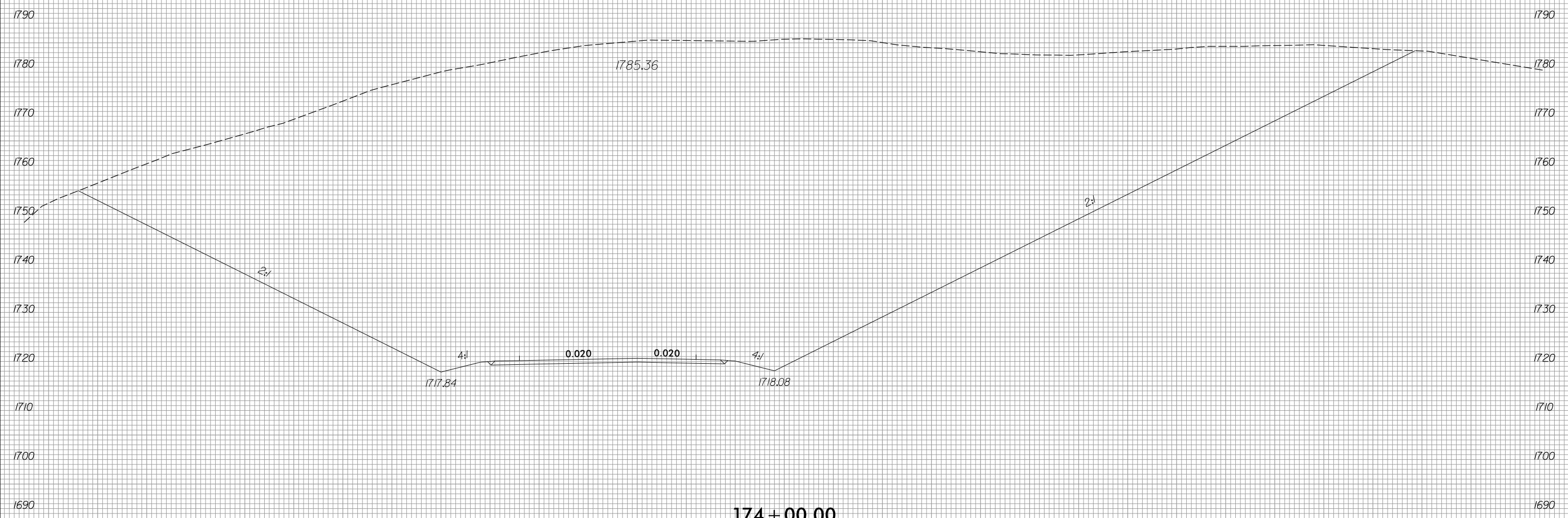

174 + 00.00

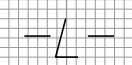

120 110 100 90 80 70 60 50 40 30 20 10 0 10 20 30 40 50 60 70 80 90 100 110 120 130 140 150 160 170 180



120 110 100 90 80 70 60 50 40 30 20 10 0 10 20 30 40 50 60 70 80 90 100 110 120 130 140 150 160 170 180

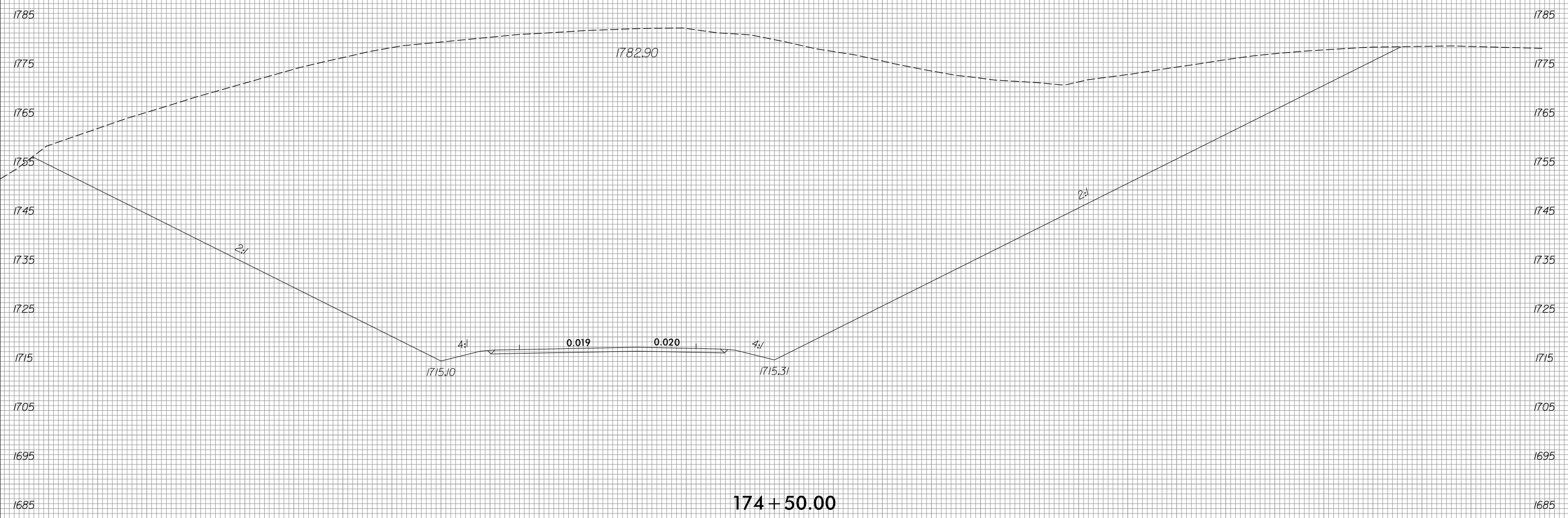

120 110 100 90 80 70 60 50 40 30 20 10 0 10 20 30 40 50 60 70 80 90 100 110 120 130 140 150 160 170 180

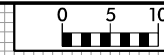

150 140 130 120 110 100 90 80 70 60 50 40 30 20 10 0 10 20 30 40 50 60 70 80 90 100 110 120 130 140 150

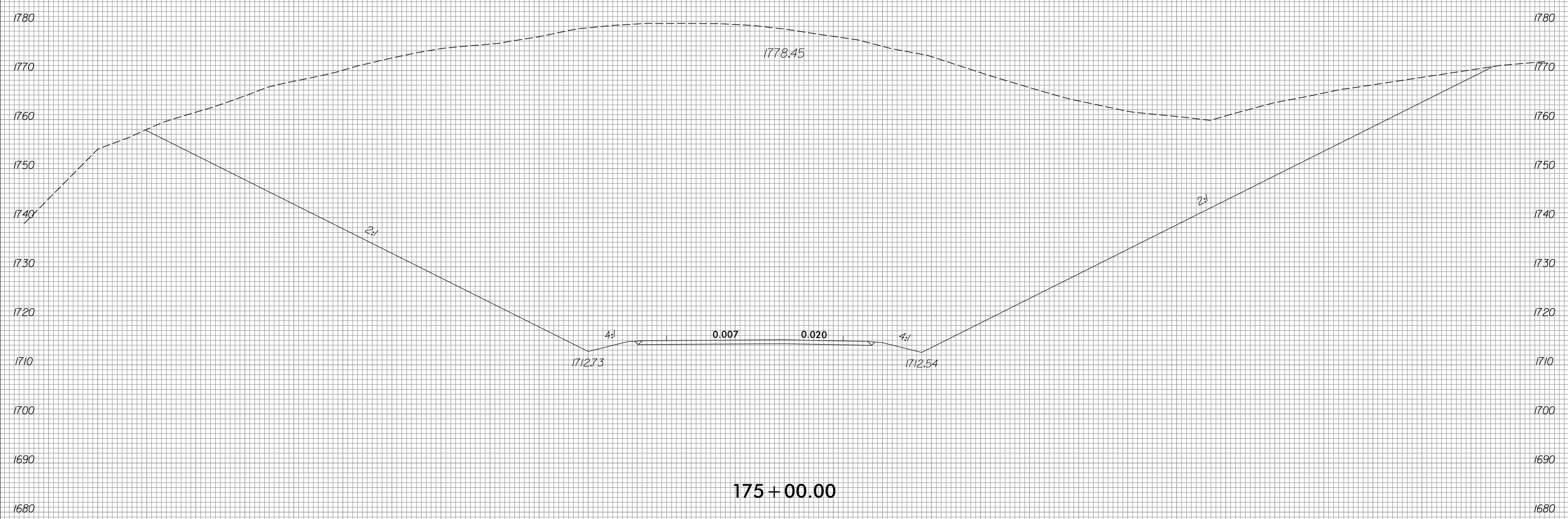

175 + 00.00

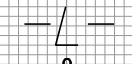

150 140 130 120 110 100 90 80 70 60 50 40 30 20 10 0 10 20 30 40 50 60 70 80 90 100 110 120 130 140 150

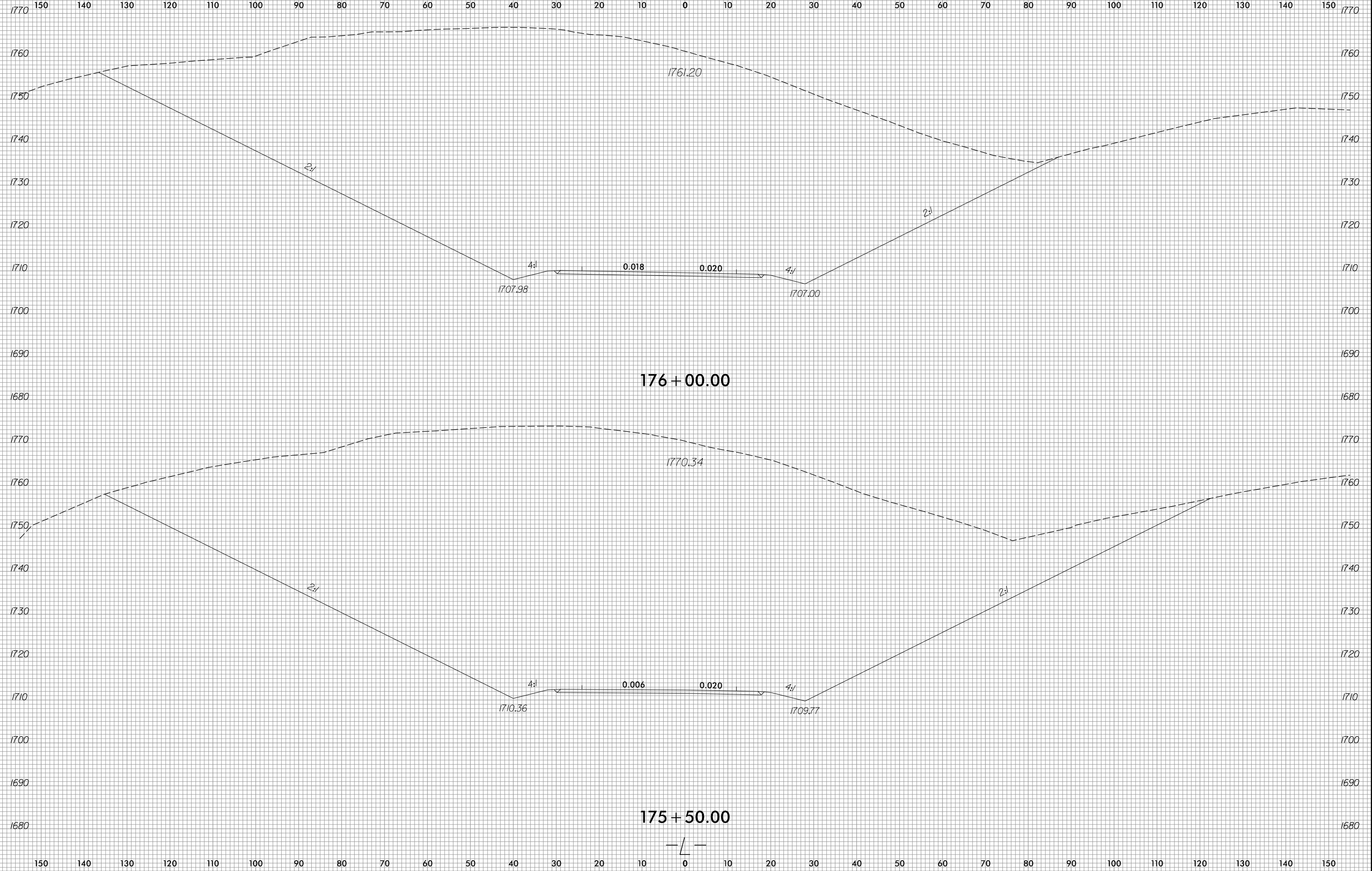



150 140 130 120 110 100 90 80 70 60 50 40 30 20 10 0 10 20 30 40 50 60 70 80 90 100 110 120 130 140 150

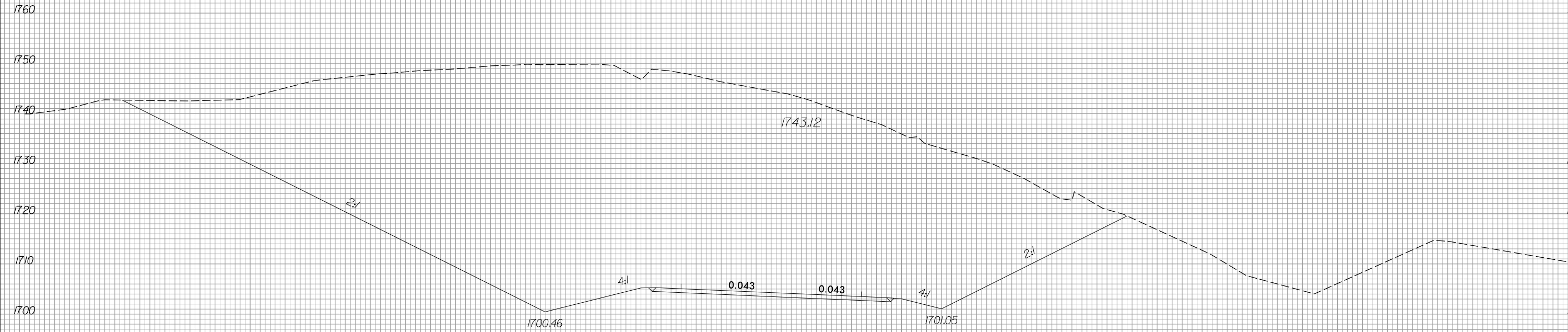

177 + 00.00

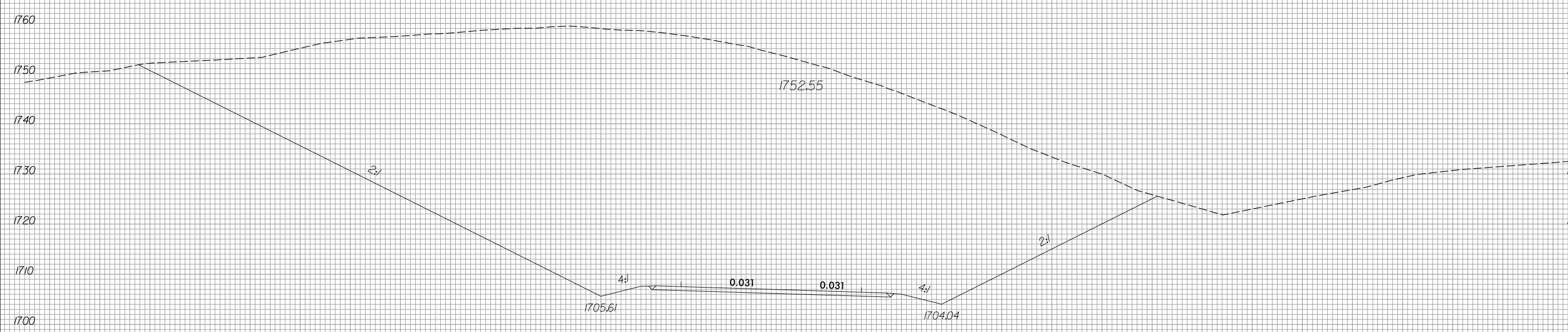

176 + 50.00

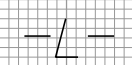



150 140 130 120 110 100 90 80 70 60 50 40 30 20 10 0 10 20 30 40 50 60 70 80 90 100 110 120 130 140 150

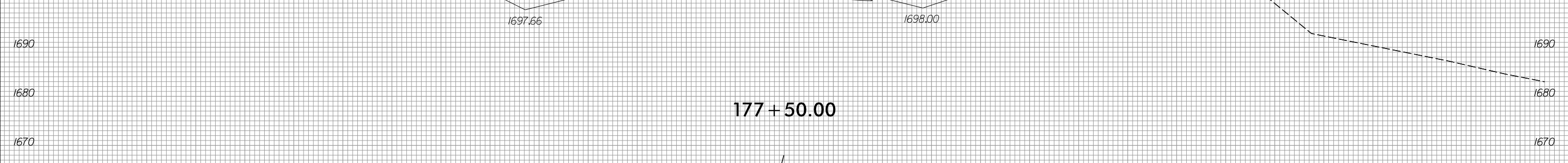
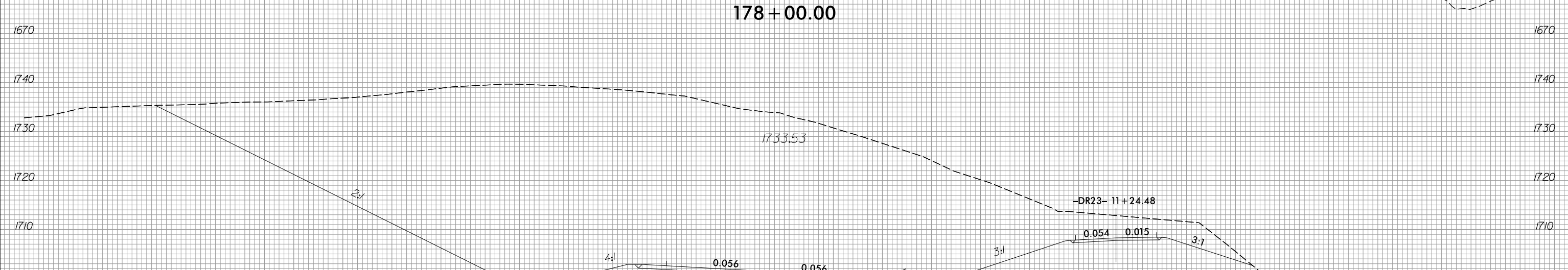
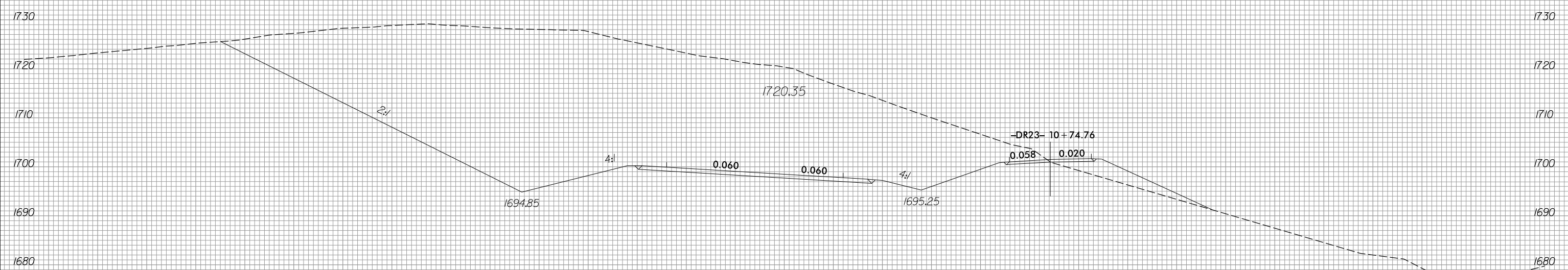

150 140 130 120 110 100 90 80 70 60 50 40 30 20 10 0 10 20 30 40 50 60 70 80 90 100 110 120 130 140 150



150 140 130 120 110 100 90 80 70 60 50 40 30 20 10 0 10 20 30 40 50 60 70 80 90 100 110 120 130 140 150

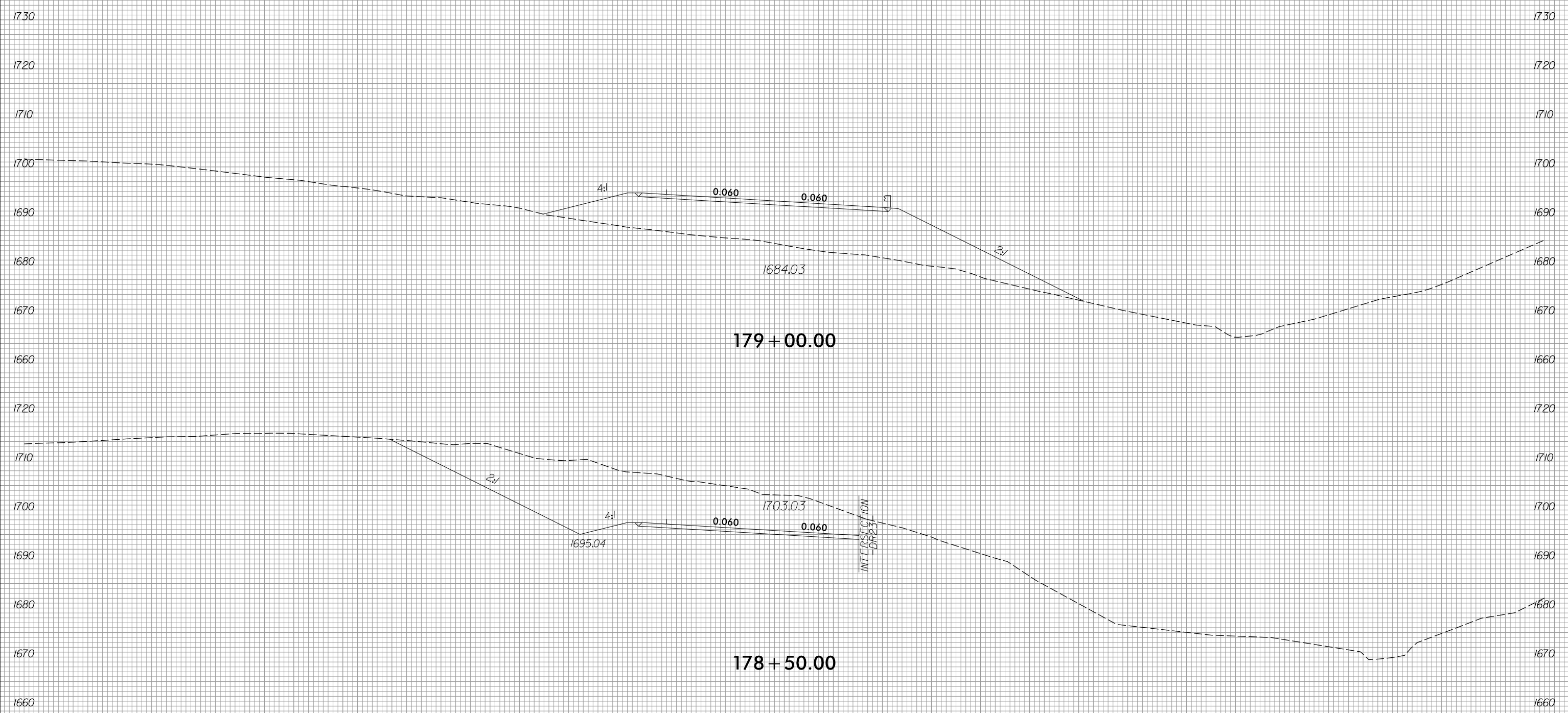

179 + 00.00

178 + 50.00

INTERSECTION
DR231

150 140 130 120 110 100 90 80 70 60 50 40 30 20 10 0 10 20 30 40 50 60 70 80 90 100 110 120 130 140 150

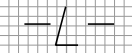

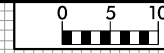

200 190 180 170 160 150 140 130 120 110 100 90 80 70 60 50 40 30 20 10 0 10 20 30 40 50 60 70 80 90 100

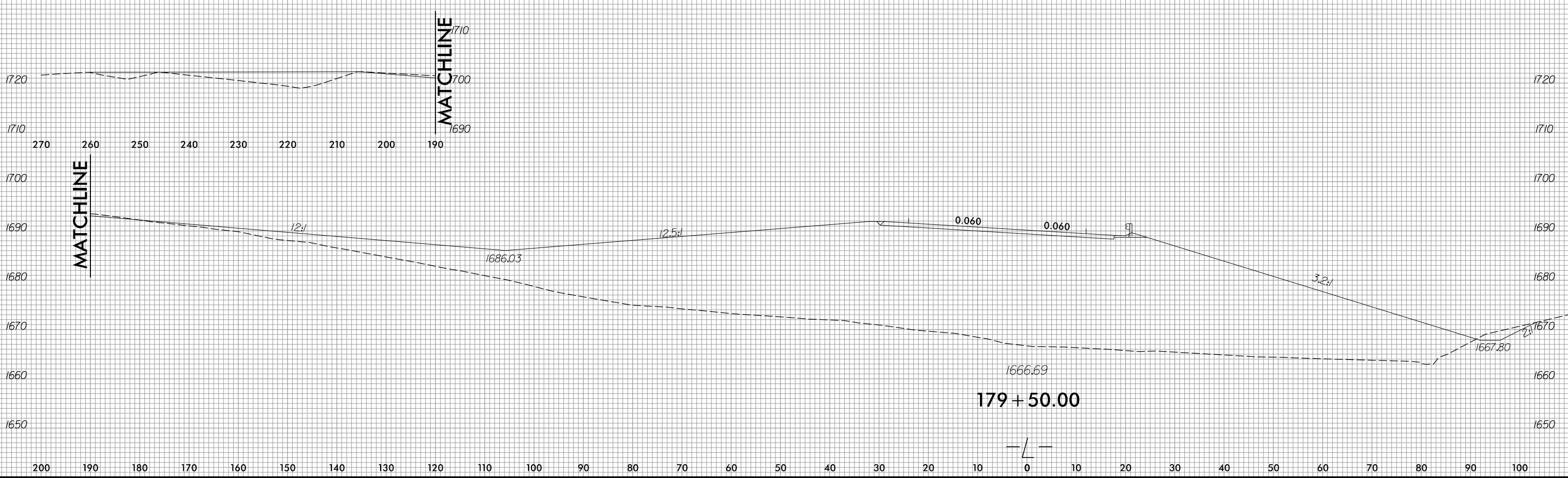
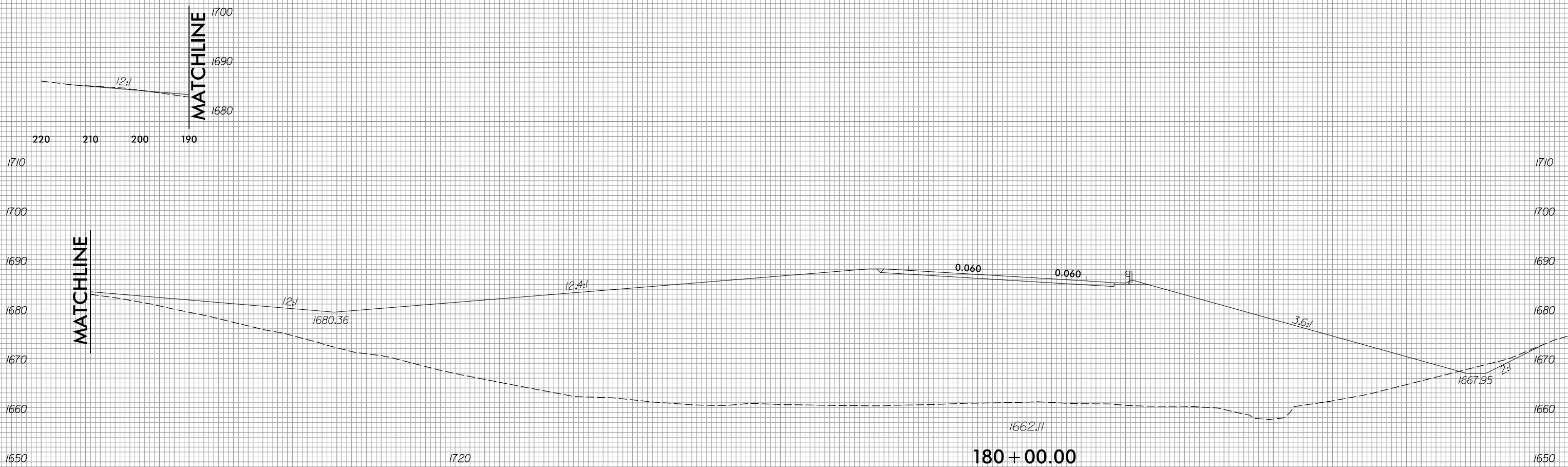

6/23/16

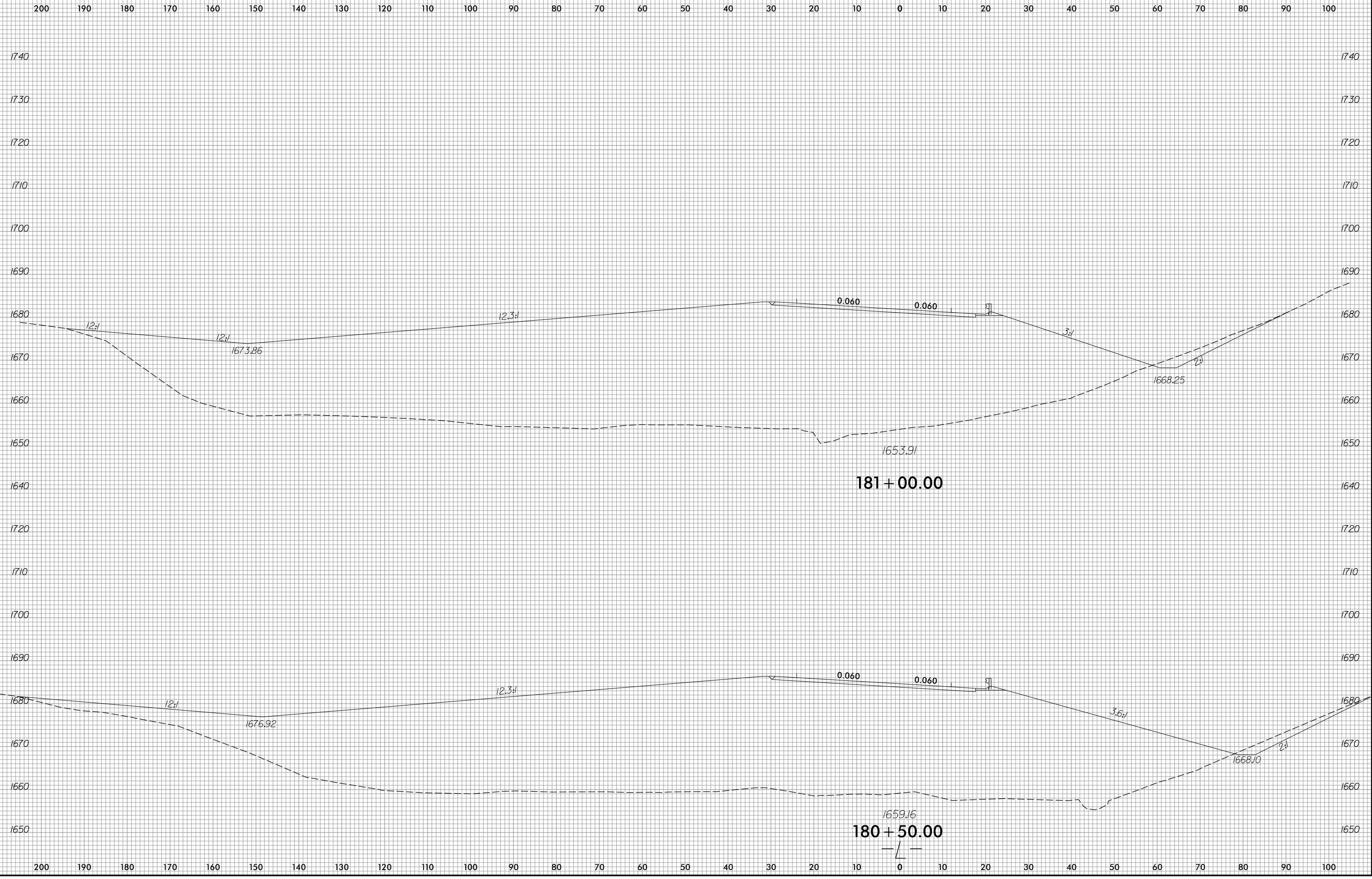

8/3/2023
R:\Roadway\XSC\XPLs\R5861.Rdy-XPL.L.dgn
Mason

6/23/16



PROJ. REFERENCE NO.
R-5861

SHEET NO.
X-172

200 190 180 170 160 150 140 130 120 110 100 90 80 70 60 50 40 30 20 10 0 10 20 30 40 50 60 70 80 90 100



8/3/2023
 R:\Roadway\XSC\XPLs\R5861.Rdy-XPL.L.dgn
 MASON

200 190 180 170 160 150 140 130 120 110 100 90 80 70 60 50 40 30 20 10 0 10 20 30 40 50 60 70 80 90 100



200 190 180 170 160 150 140 130 120 110 100 90 80 70 60 50 40 30 20 10 0 10 20 30 40 50 60 70 80 90 100

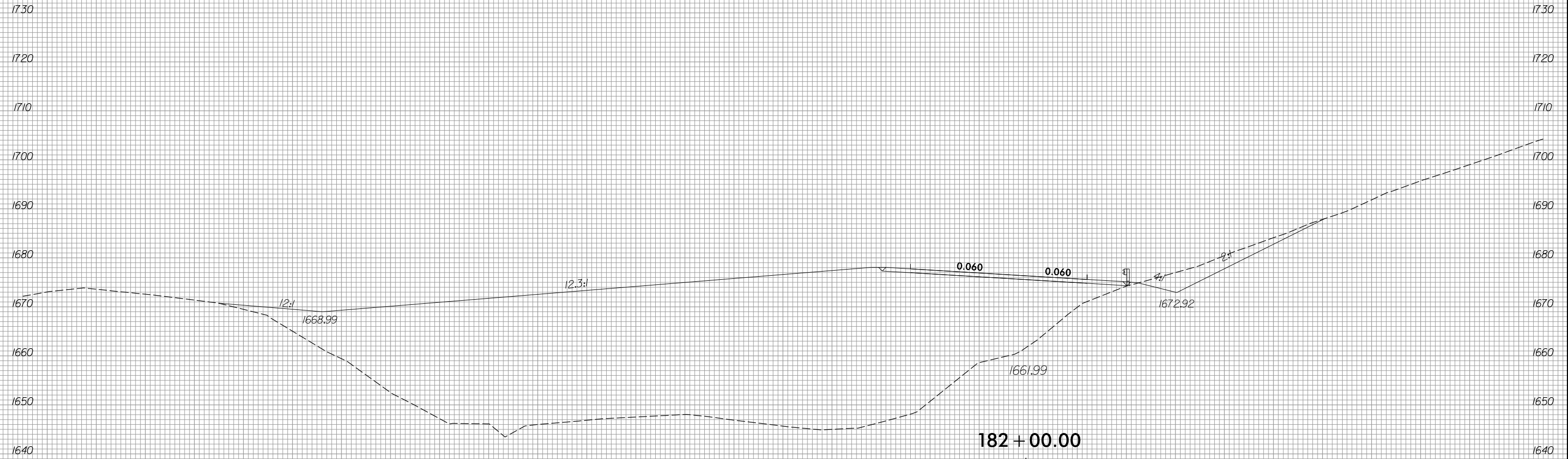

200 190 180 170 160 150 140 130 120 110 100 90 80 70 60 50 40 30 20 10 0 10 20 30 40 50 60 70 80 90 100

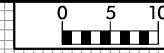

150 140 130 120 110 100 90 80 70 60 50 40 30 20 10 0 10 20 30 40 50 60 70 80 90 100 110 120 130 140 150

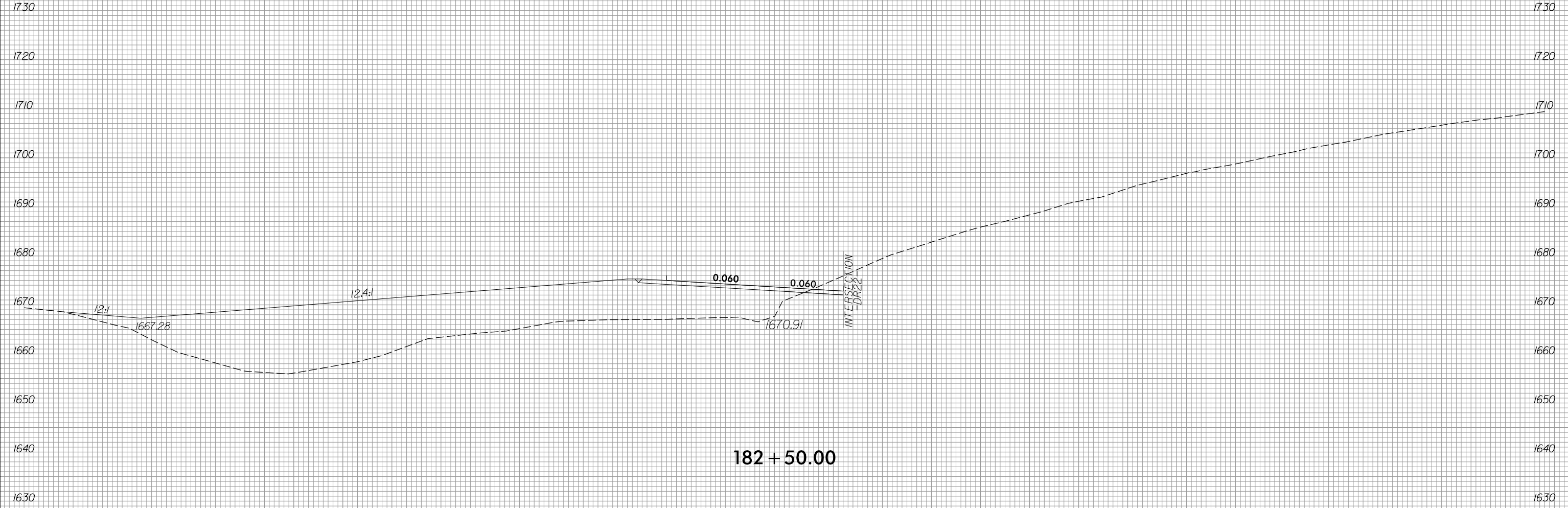

182 + 50.00

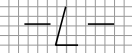

150 140 130 120 110 100 90 80 70 60 50 40 30 20 10 0 10 20 30 40 50 60 70 80 90 100 110 120 130 140 150



150 140 130 120 110 100 90 80 70 60 50 40 30 20 10 0 10 20 30 40 50 60 70 80 90 100 110 120 130 140 150

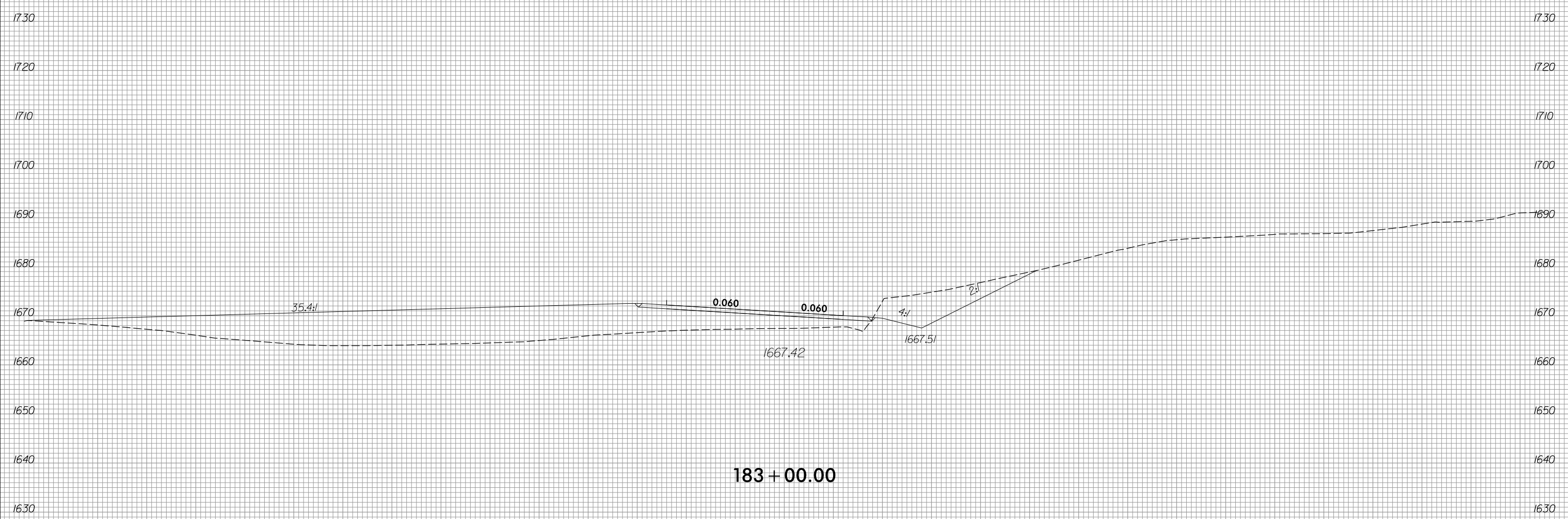

150 140 130 120 110 100 90 80 70 60 50 40 30 20 10 0 10 20 30 40 50 60 70 80 90 100 110 120 130 140 150



150 140 130 120 110 100 90 80 70 60 50 40 30 20 10 0 10 20 30 40 50 60 70 80 90 100 110 120 130 140 150

1730

1730

1720

1720

1710

1710

1700

1700

1690

1690

1680

1680

1670

1670

1660

1660

1650

1650

1640

1640

1630

1630



183 + 50.00



150 140 130 120 110 100 90 80 70 60 50 40 30 20 10 0 10 20 30 40 50 60 70 80 90 100 110 120 130 140 150



150 140 130 120 110 100 90 80 70 60 50 40 30 20 10 0 10 20 30 40 50 60 70 80 90 100 110 120 130 140 150

1740
1730
1720
1710
1700
1690
1680
1670
1660
1650
1640
1630

1740
1730
1720
1710
1700
1690
1680
1670
1660
1650
1640
1630

150 140 130 120 110 100 90 80 70 60 50 40 30 20 10 0 10 20 30 40 50 60 70 80 90 100 110 120 130 140 150

184 + 00.00

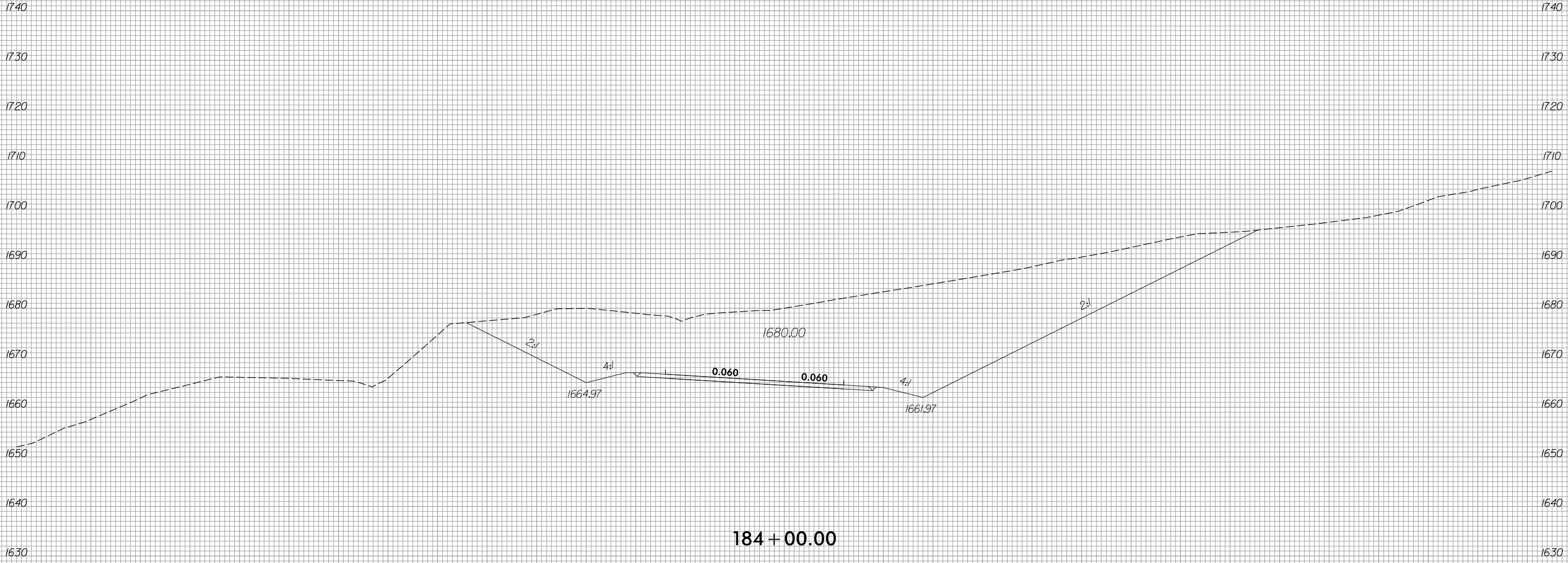



150 140 130 120 110 100 90 80 70 60 50 40 30 20 10 0 10 20 30 40 50 60 70 80 90 100 110 120 130 140 150

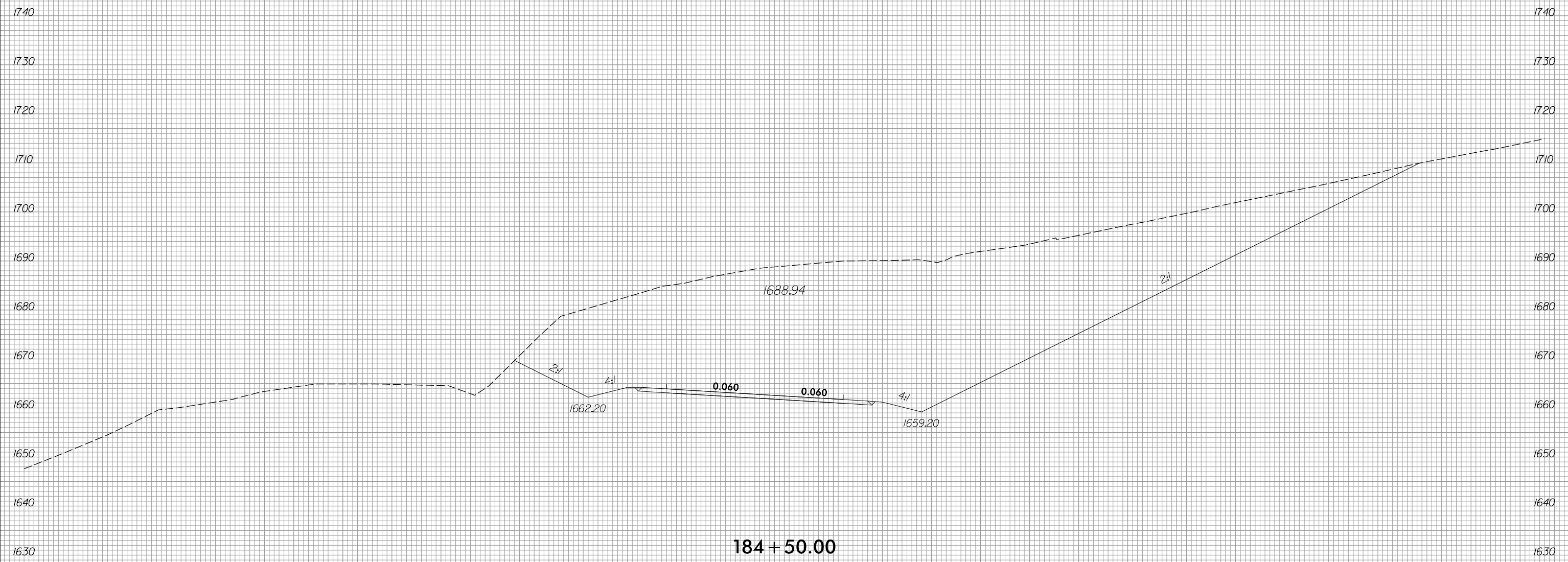

150 140 130 120 110 100 90 80 70 60 50 40 30 20 10 0 10 20 30 40 50 60 70 80 90 100 110 120 130 140 150



140 130 120 110 100 90 80 70 60 50 40 30 20 10 0 10 20 30 40 50 60 70 80 90 100 110 120 130 140 150 160

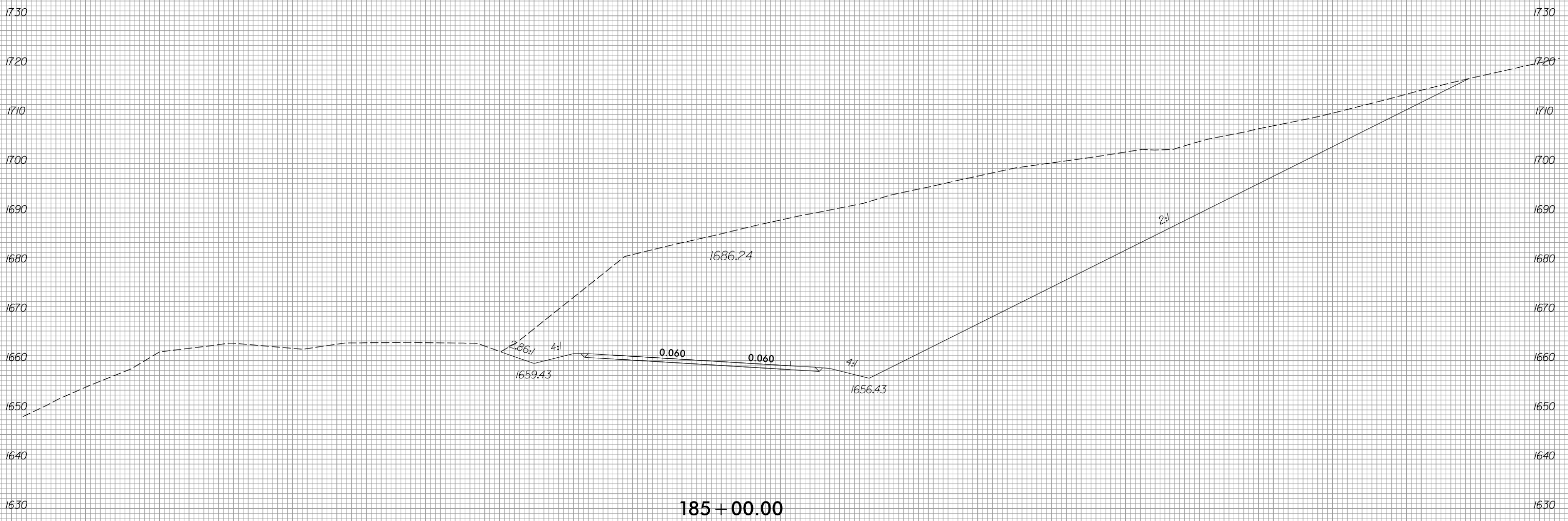

185 + 00.00



140 130 120 110 100 90 80 70 60 50 40 30 20 10 0 10 20 30 40 50 60 70 80 90 100 110 120 130 140 150 160

8/23/16



PROJ. REFERENCE NO.
R-5861

SHEET NO.
X-180

130 120 110 100 90 80 70 60 50 40 30 20 10 0 10 20 30 40 50 60 70 80 90 100 110 120 130 140 150 160 170

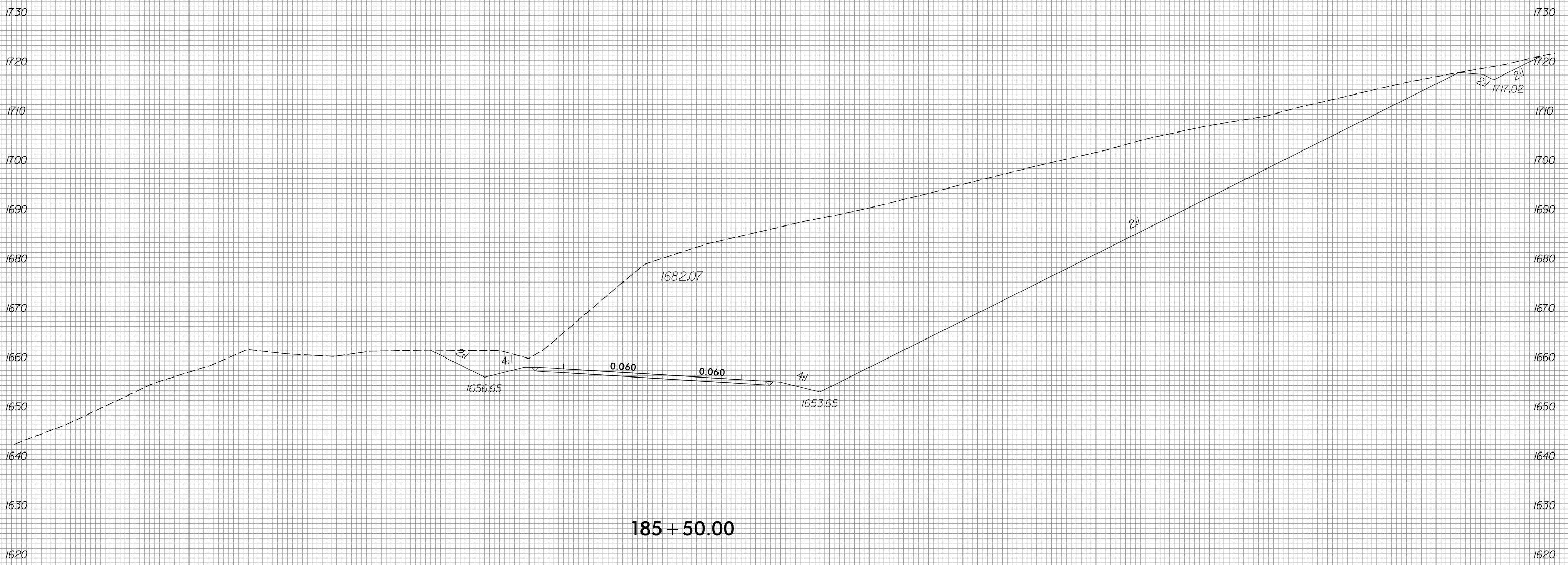

8/3/2023
R:\Roadway\XSC\XPLs\15861.Rd\XPL.L.dgn
Pinson

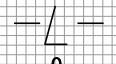

8/3/2023
R:\Roadway\XSC\XPLs\15861_Rdj_XPL_L.dgn
P:\ason

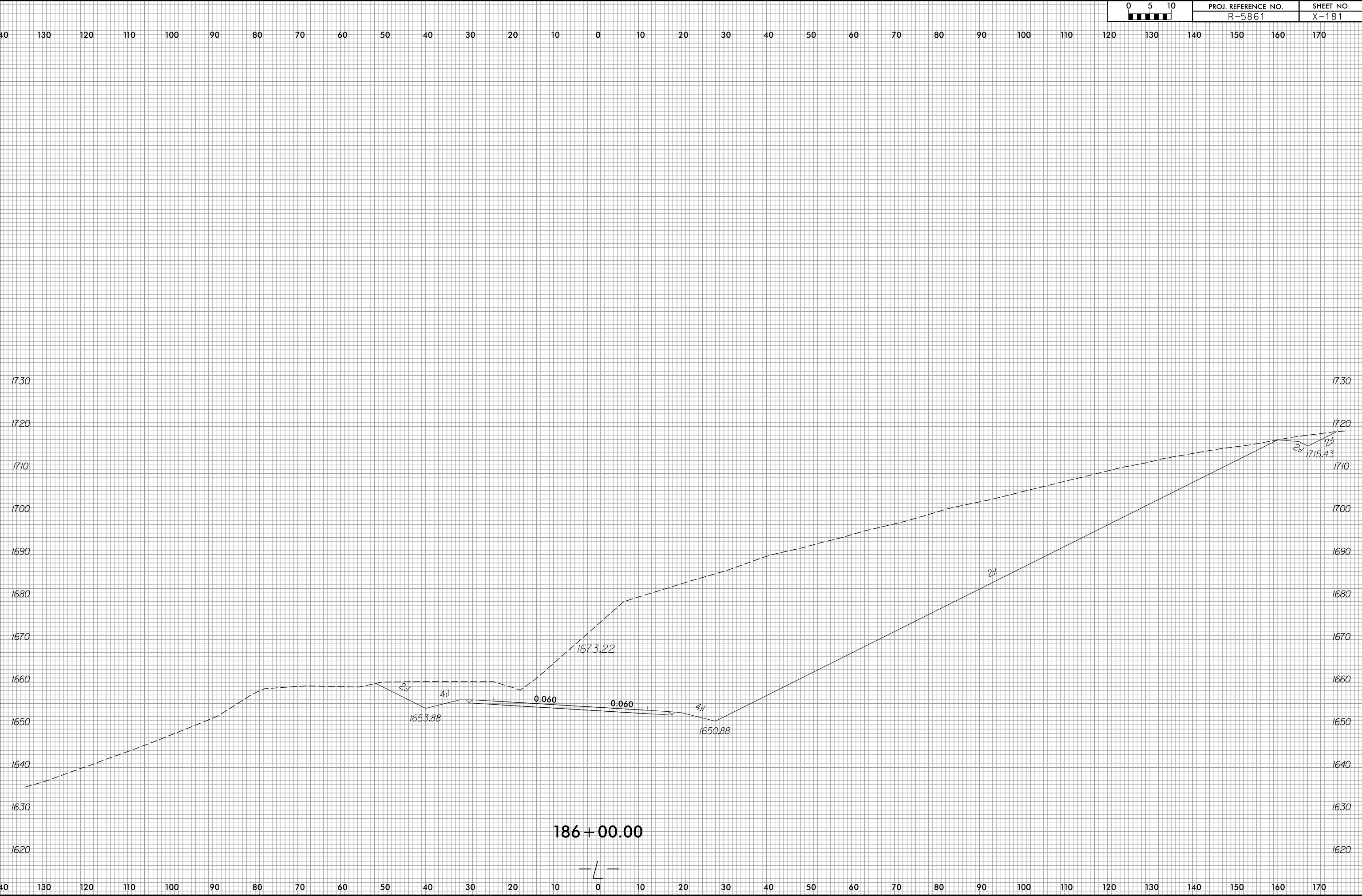

186 + 00.00

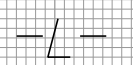

8/3/2023
R:\Roadway\XSC\XPLs\15861.Rd\XPL.L.dgn
Person

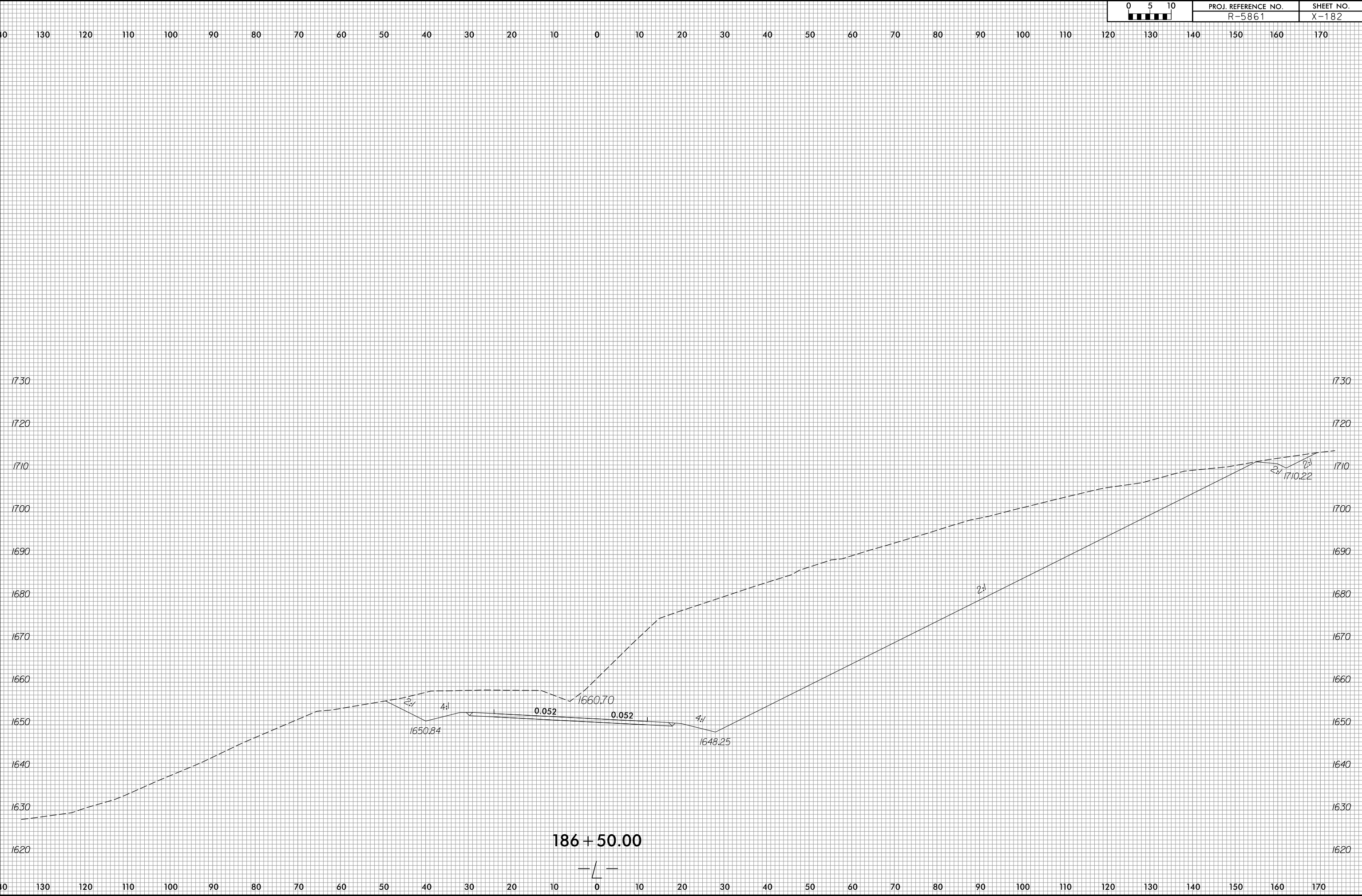



150 140 130 120 110 100 90 80 70 60 50 40 30 20 10 0 10 20 30 40 50 60 70 80 90 100 110 120 130 140 150

1730
1720
1710
1700
1690
1680
1670
1660
1650
1640
1630
1620

1730
1720
1710
1700
1690
1680
1670
1660
1650
1640
1630
1620

187 + 00.00

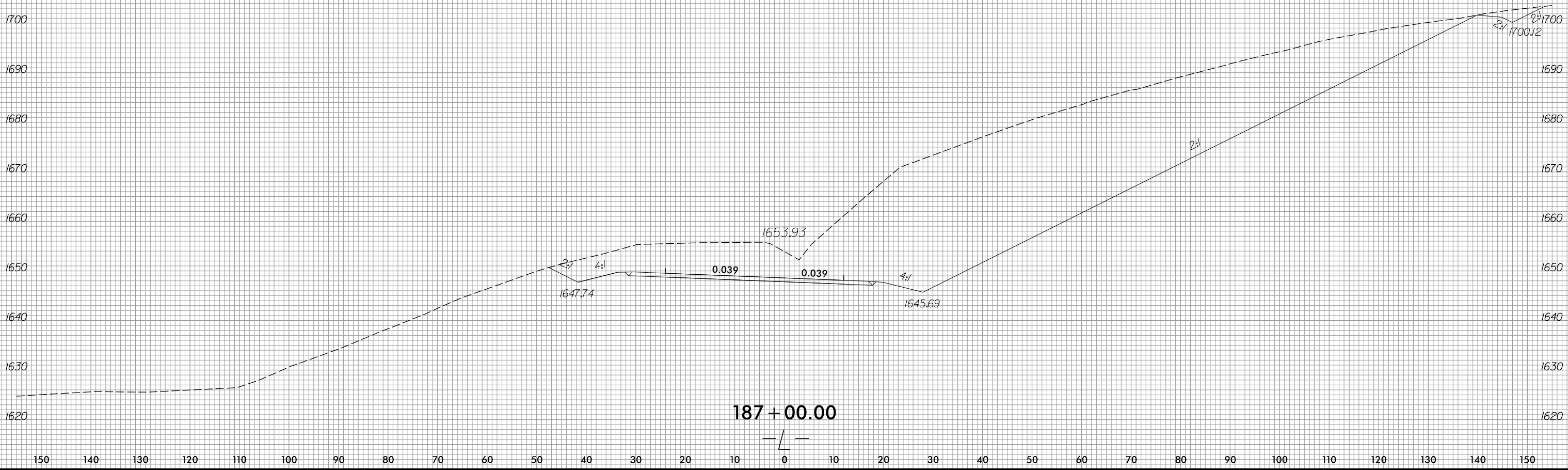

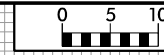

150 140 130 120 110 100 90 80 70 60 50 40 30 20 10 0 10 20 30 40 50 60 70 80 90 100 110 120 130 140 150

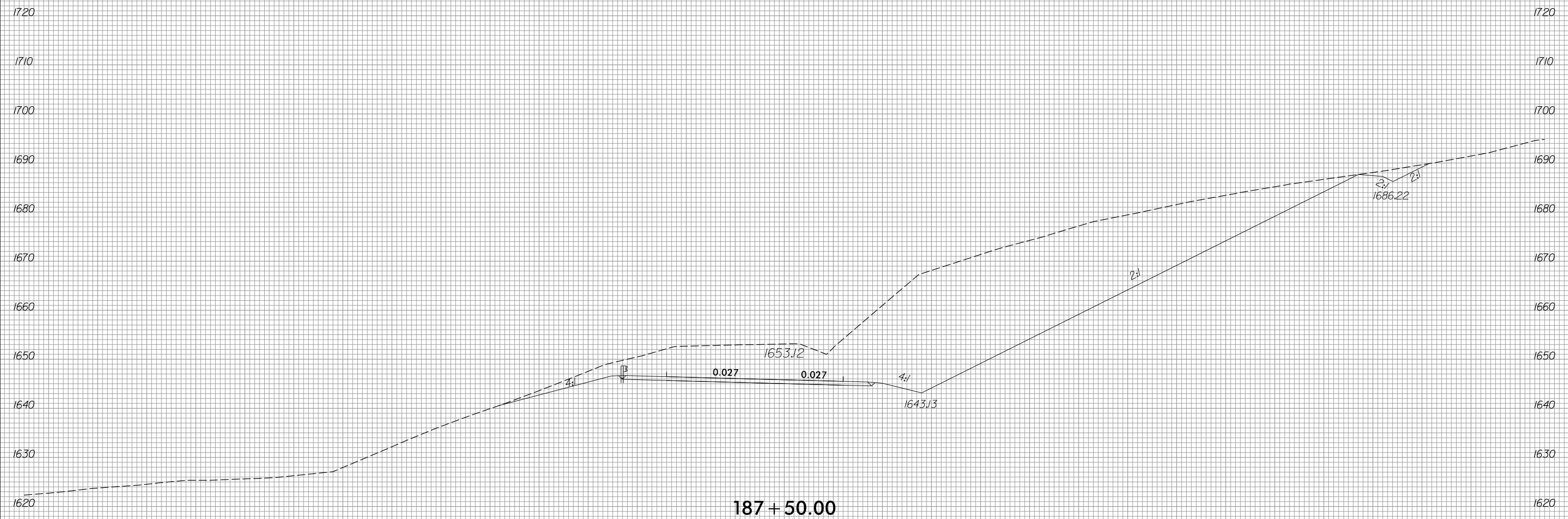

187 + 50.00

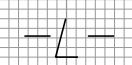

150 140 130 120 110 100 90 80 70 60 50 40 30 20 10 0 10 20 30 40 50 60 70 80 90 100 110 120 130 140 150

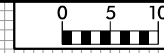

150 140 130 120 110 100 90 80 70 60 50 40 30 20 10 0 10 20 30 40 50 60 70 80 90 100 110 120 130 140 150

1720
1710
1700
1690
1680
1670
1660
1650
1640
1630
1620
1610

1720
1710
1700
1690
1680
1670
1660
1650
1640
1630
1620
1610

188 + 00.00

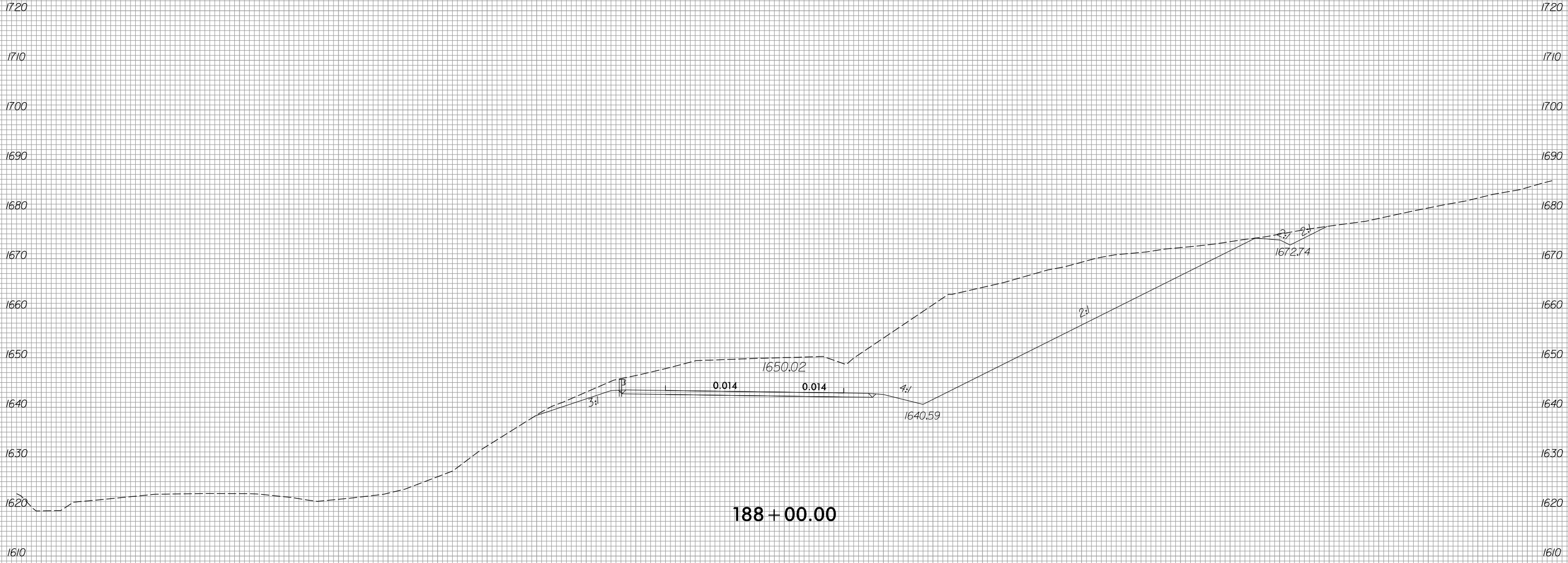

3:1

0.014

1650.02

0.014

1640.59

4:1

2:1

1672.74

2:1

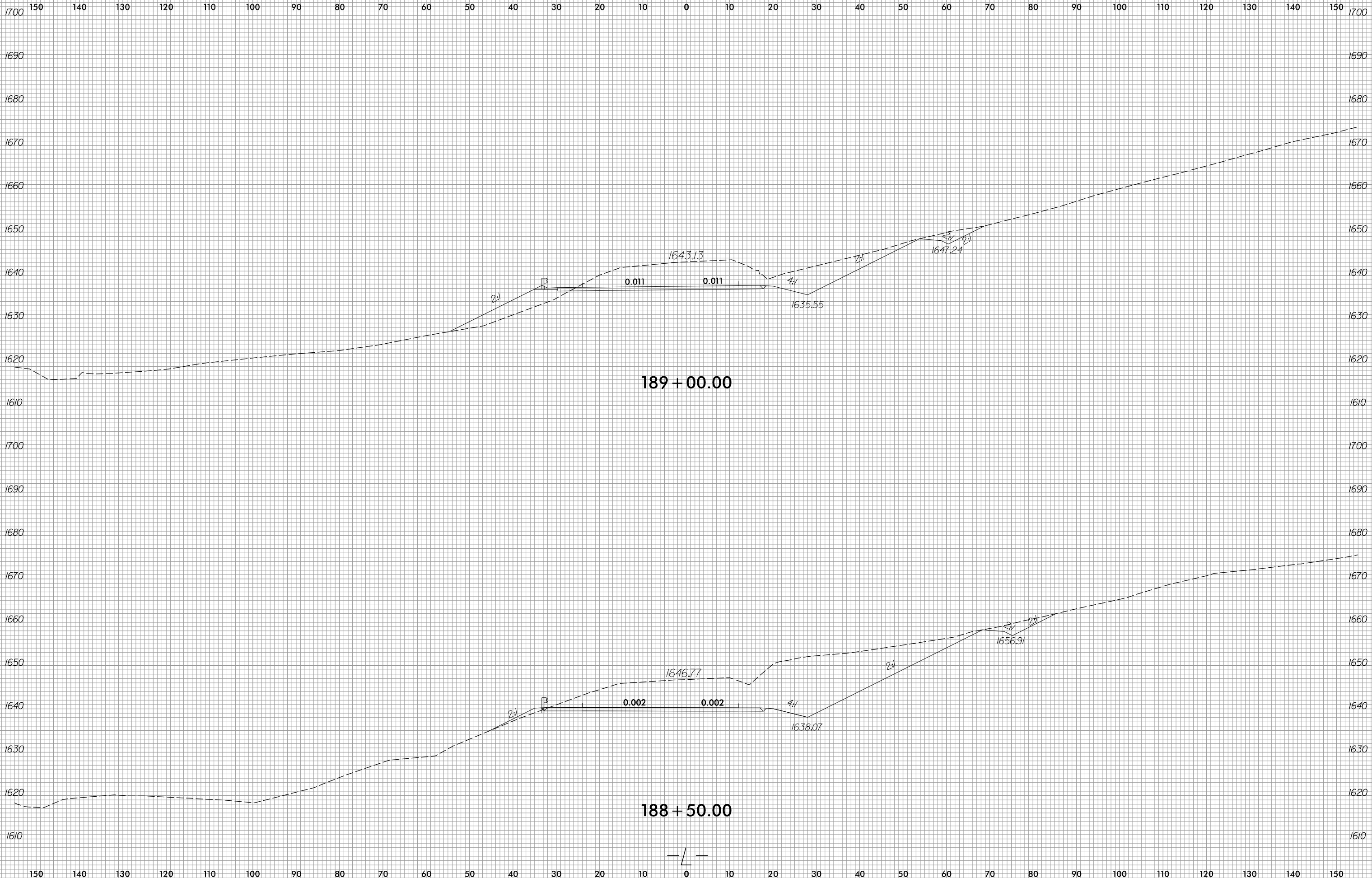



150 140 130 120 110 100 90 80 70 60 50 40 30 20 10 0 10 20 30 40 50 60 70 80 90 100 110 120 130 140 150

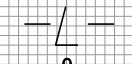
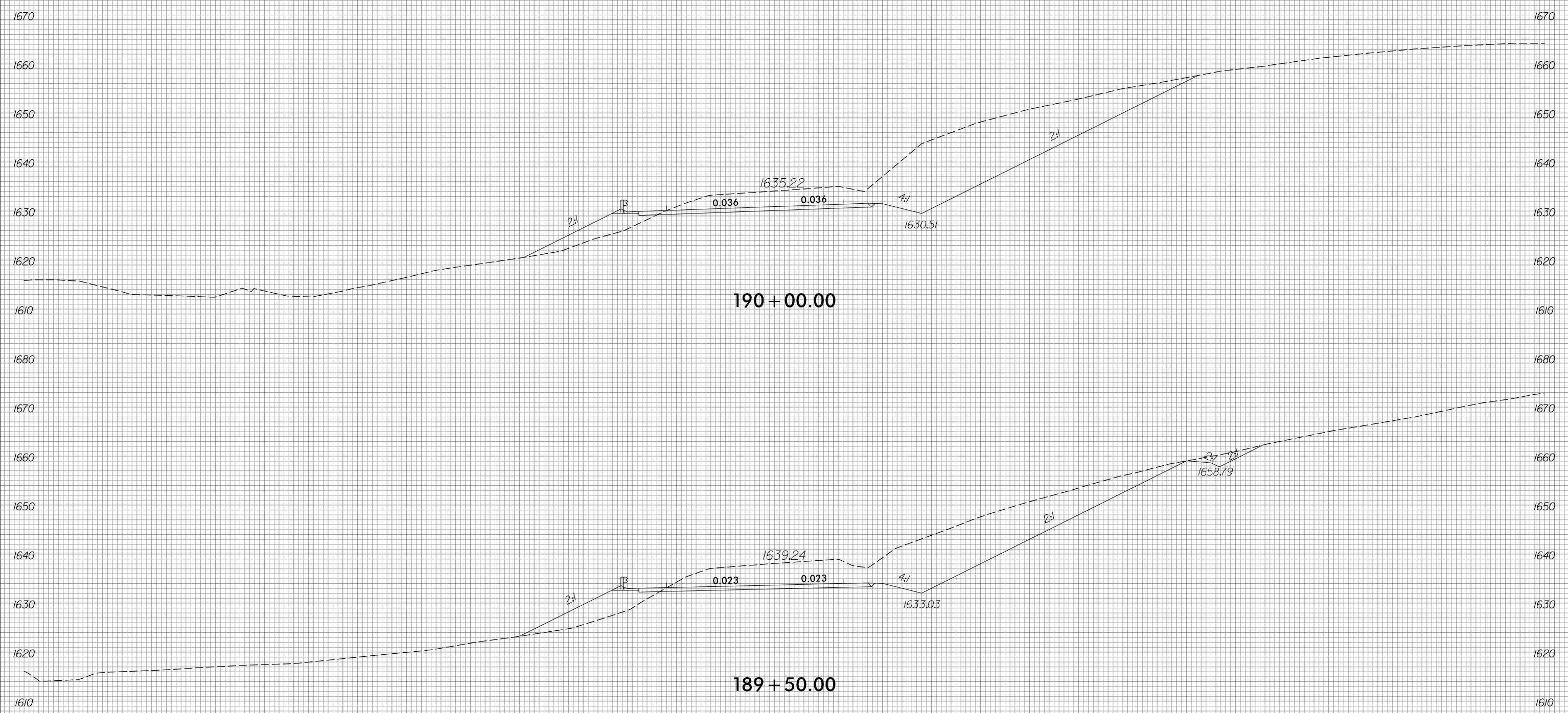

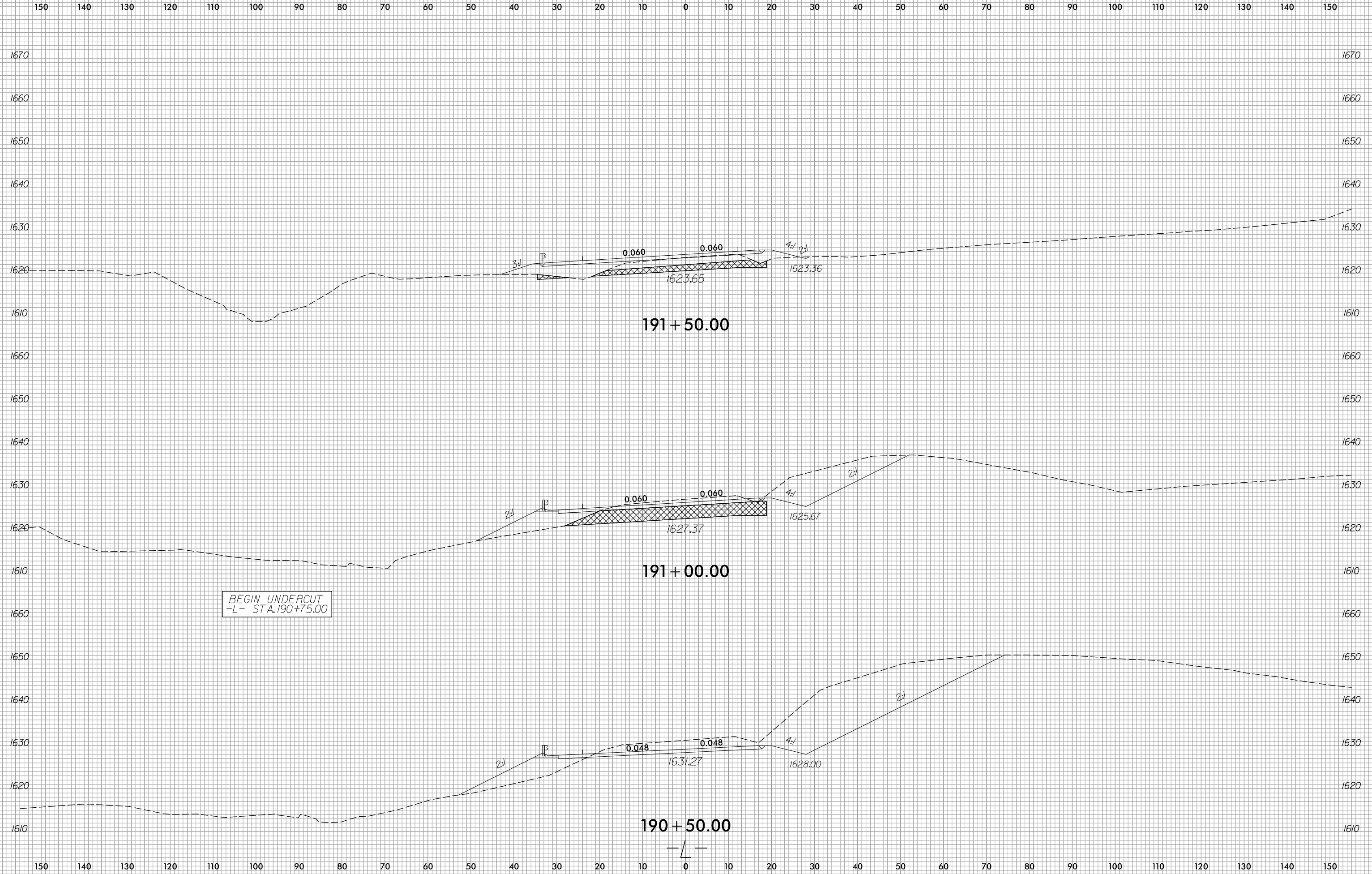



150 140 130 120 110 100 90 80 70 60 50 40 30 20 10 0 10 20 30 40 50 60 70 80 90 100 110 120 130 140 150

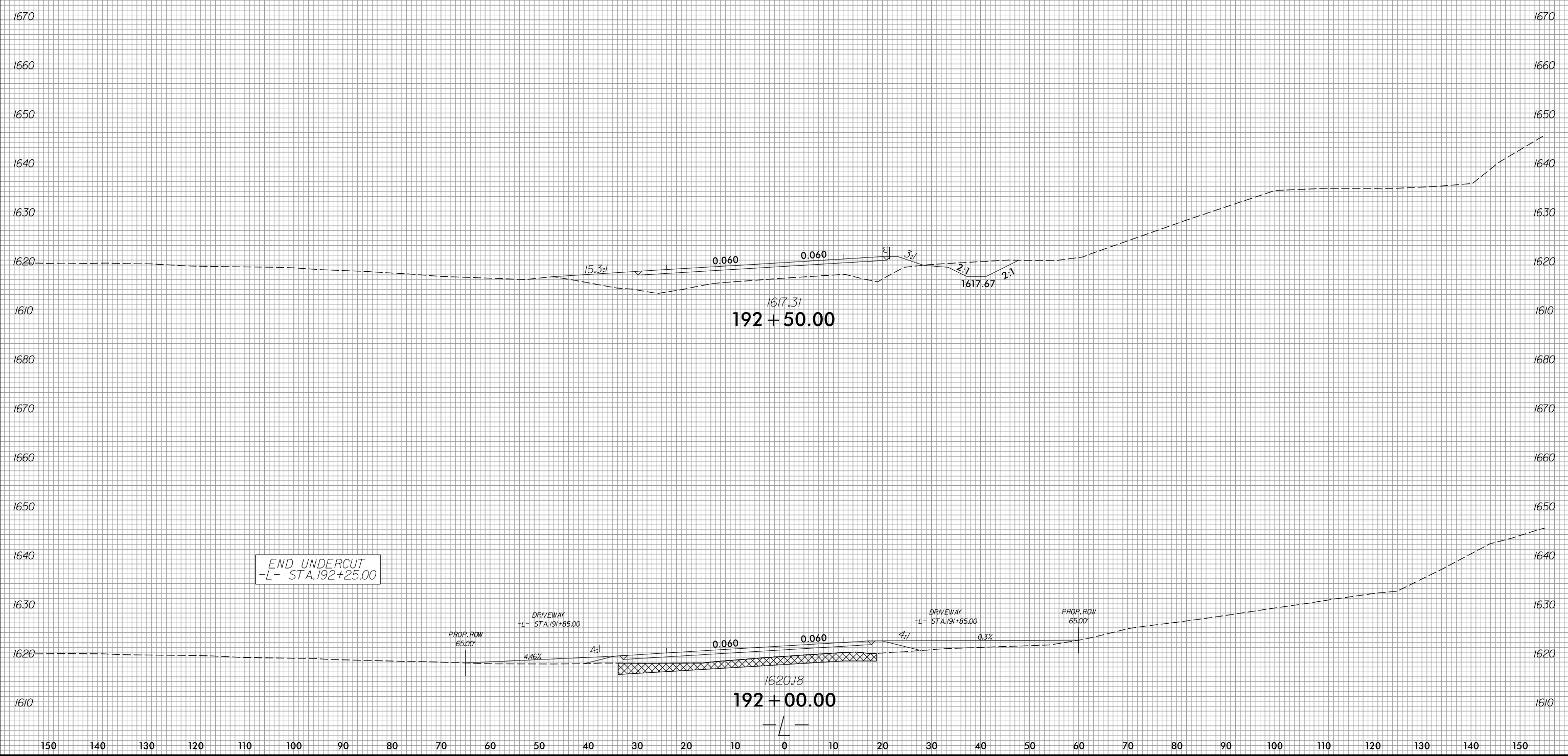

1617.31
192 + 50.00

END UNDERCUT
-L- STA. 192+25.00

1620.18
192 + 00.00

150 140 130 120 110 100 90 80 70 60 50 40 30 20 10 0 10 20 30 40 50 60 70 80 90 100 110 120 130 140 150

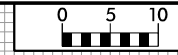

150 140 130 120 110 100 90 80 70 60 50 40 30 20 10 0 10 20 30 40 50 60 70 80 90 100 110 120 130 140 150

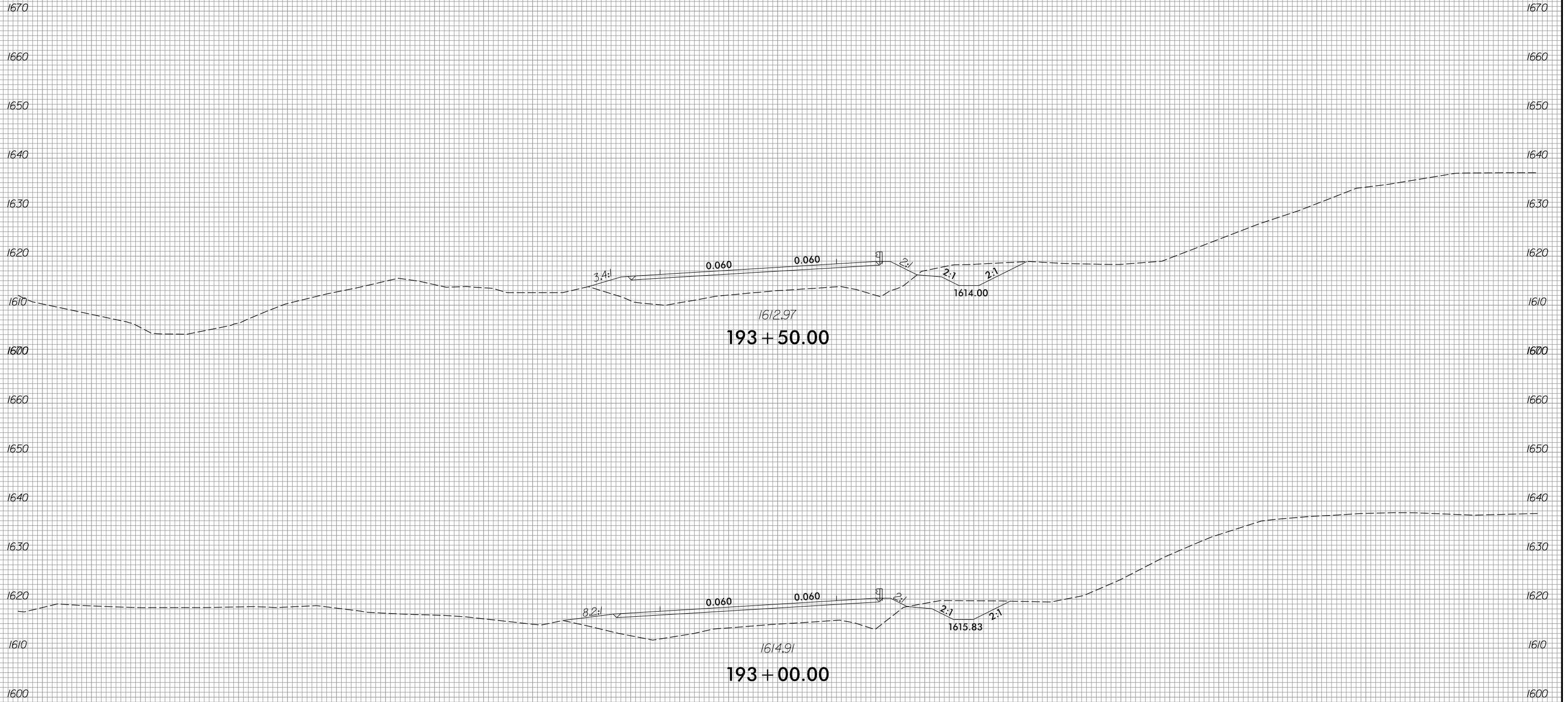

150 140 130 120 110 100 90 80 70 60 50 40 30 20 10 0 10 20 30 40 50 60 70 80 90 100 110 120 130 140 150



150 140 130 120 110 100 90 80 70 60 50 40 30 20 10 0 10 20 30 40 50 60 70 80 90 100 110 120 130 140 150

1690 1680 1670 1660 1650 1640 1630 1620 1610 1600

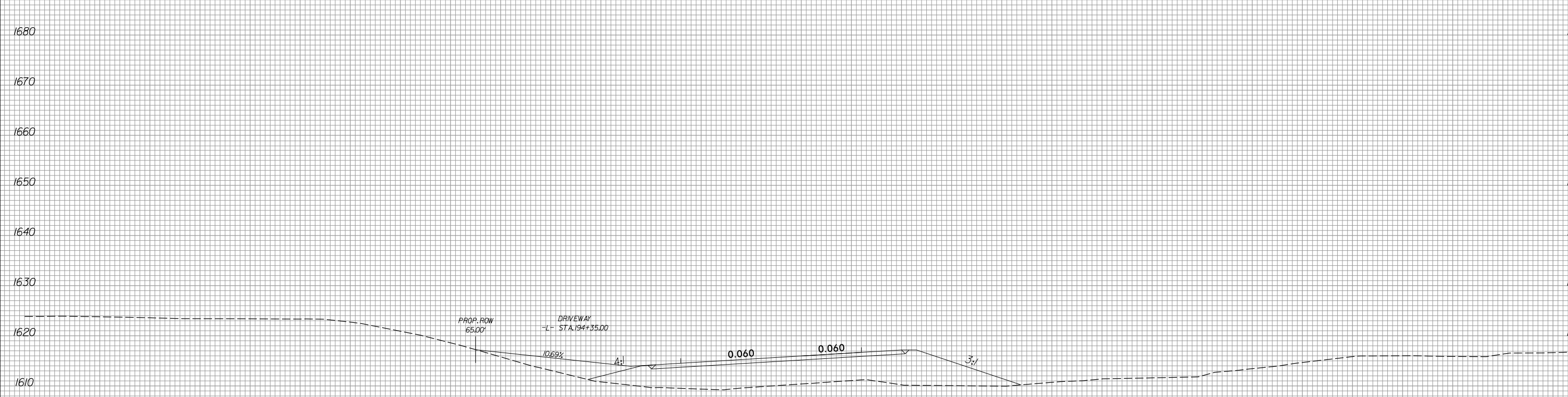

194 + 50.00



194 + 00.00

150 140 130 120 110 100 90 80 70 60 50 40 30 20 10 0 10 20 30 40 50 60 70 80 90 100 110 120 130 140 150

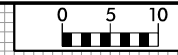

150 140 130 120 110 100 90 80 70 60 50 40 30 20 10 0 10 20 30 40 50 60 70 80 90 100 110 120 130 140 150

1690

1690

1680

1680

1670

1670

1660

1660

1650

1650

1640

1640

1630

1630

1620

1620

1610

1610

1600

1600

150 140 130 120 110 100 90 80 70 60 50 40 30 20 10 0 10 20 30 40 50 60 70 80 90 100 110 120 130 140 150

2:1

4:1

0.060

0.060

3:1

1610.33

1610.07

195 + 00.00





150 140 130 120 110 100 90 80 70 60 50 40 30 20 10 0 10 20 30 40 50 60 70 80 90 100 110 120 130 140 150

1700

1700

1690

1690

1680

1680

1670

1670

1660

1660

1650

1650

1640

1640

1630

1630

1620

1620

1610

1610

1600

1600

150 140 130 120 110 100 90 80 70 60 50 40 30 20 10 0 10 20 30 40 50 60 70 80 90 100 110 120 130 140 150

195 + 50.00

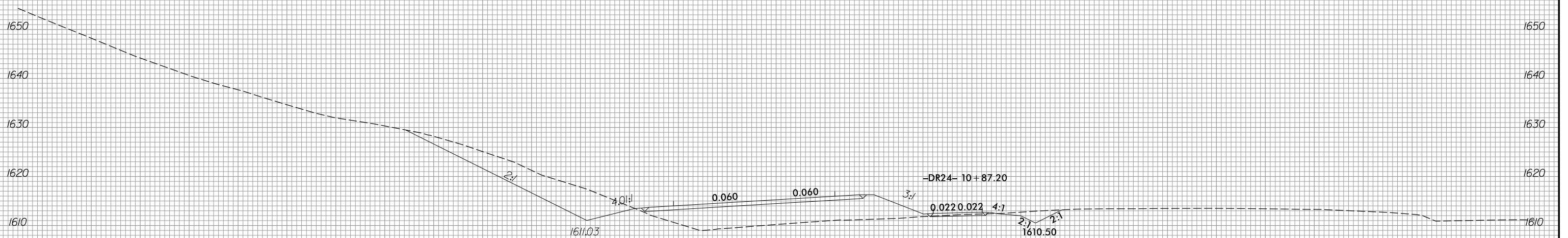
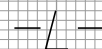

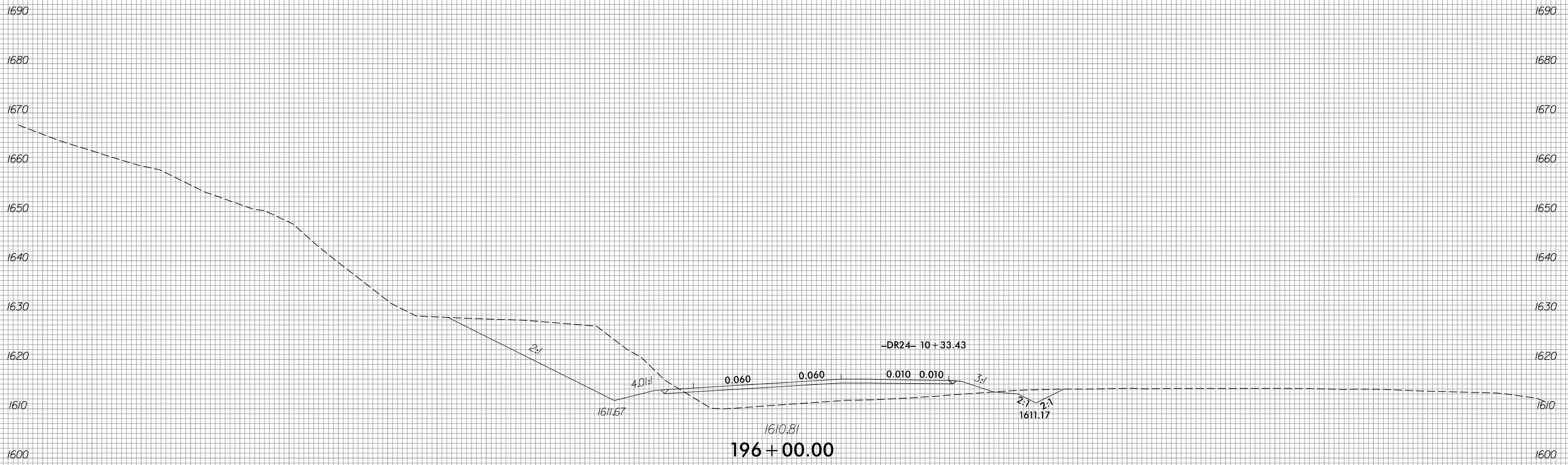
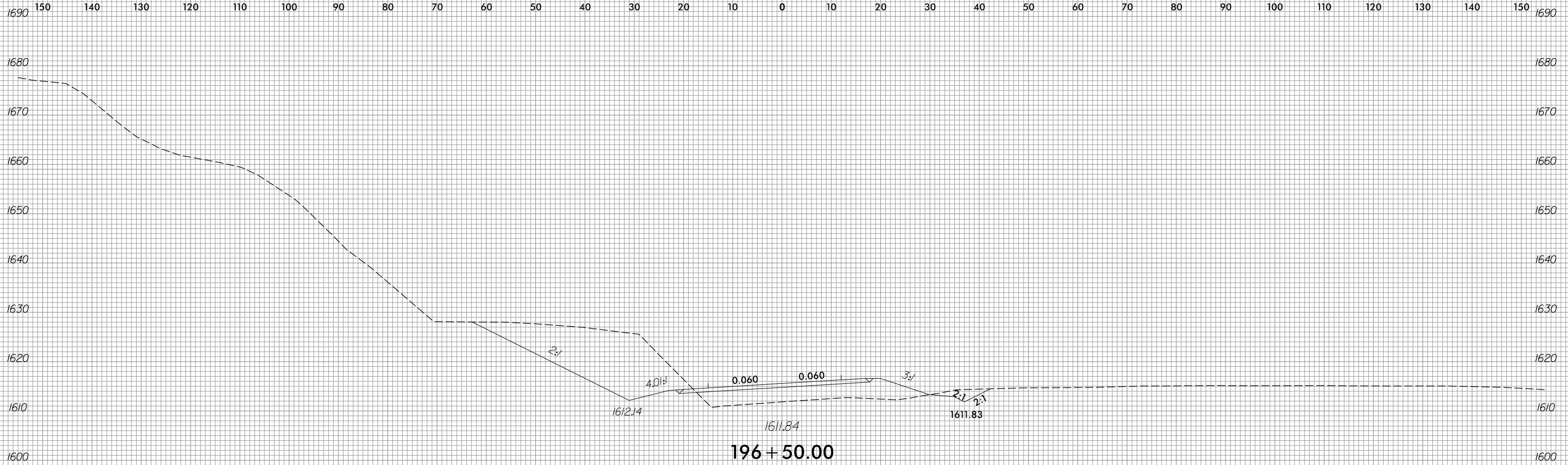

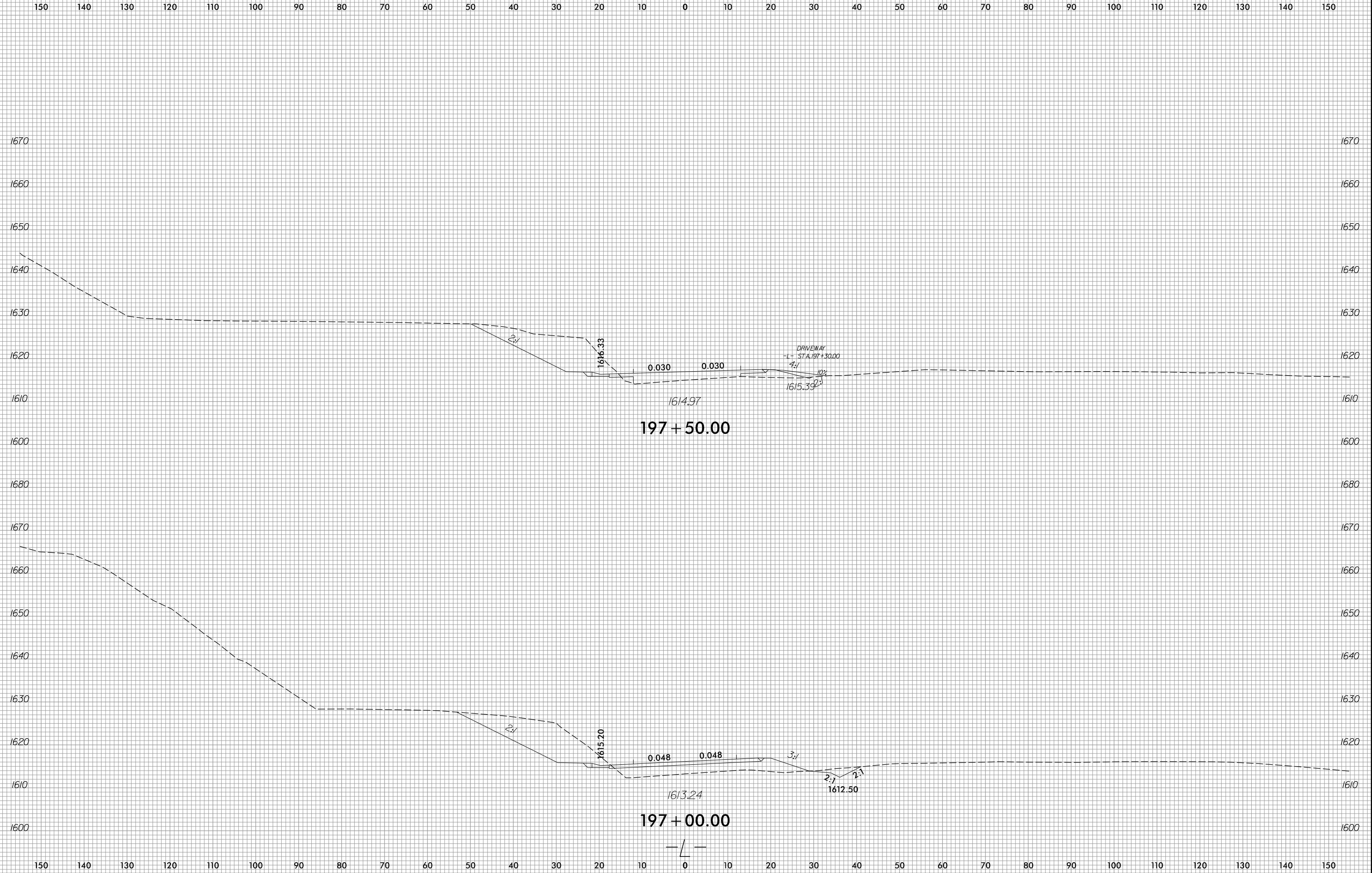

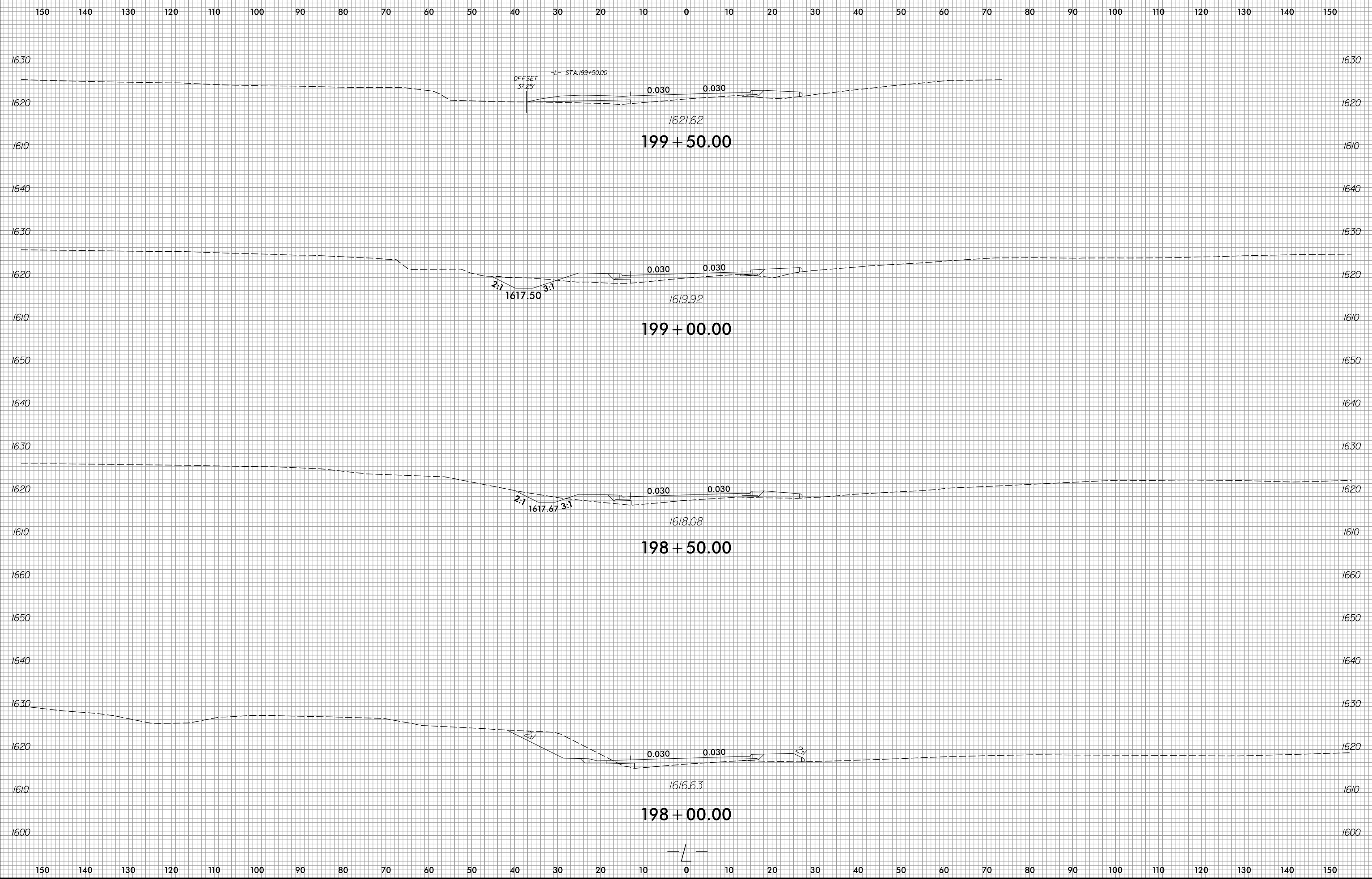



150 140 130 120 110 100 90 80 70 60 50 40 30 20 10 0 10 20 30 40 50 60 70 80 90 100 110 120 130 140 150

1640 1640

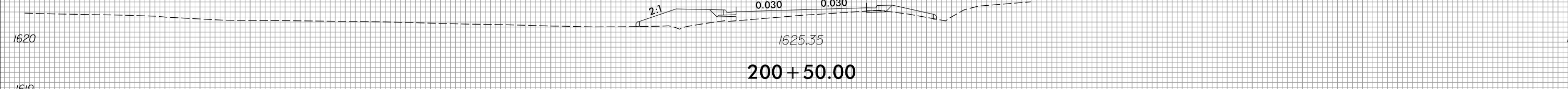
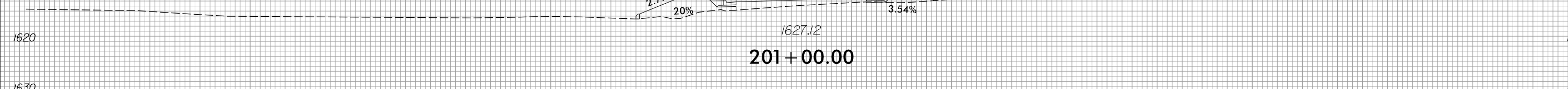
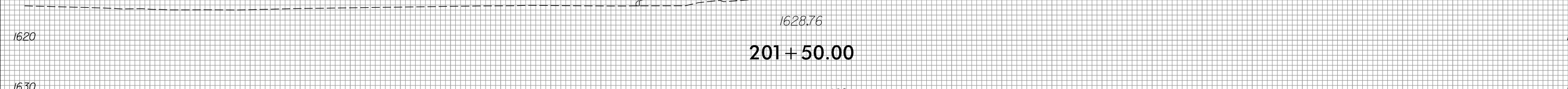
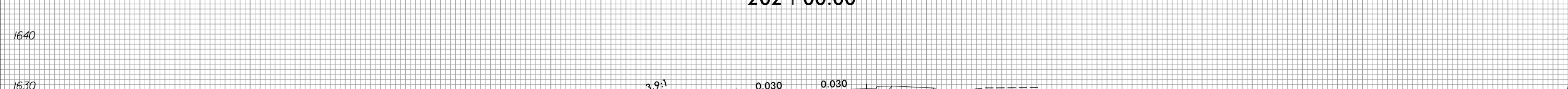
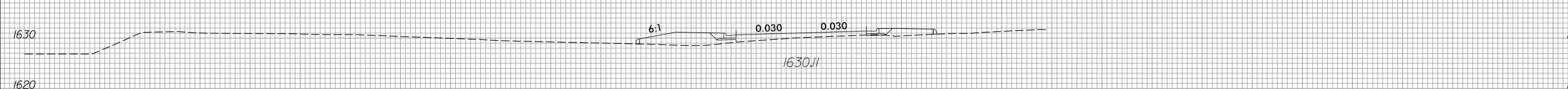
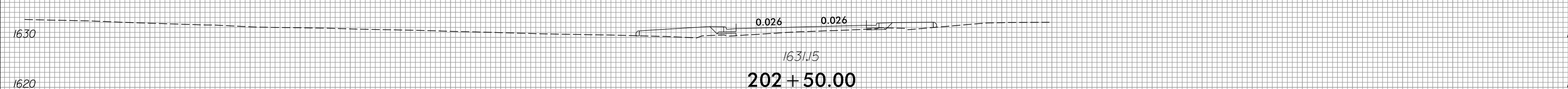
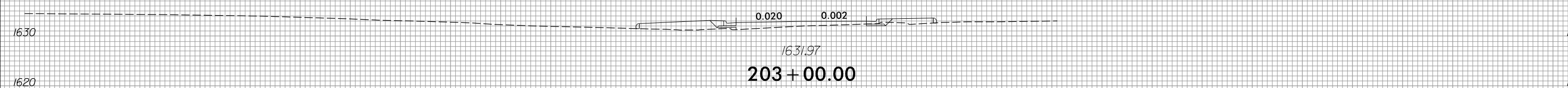
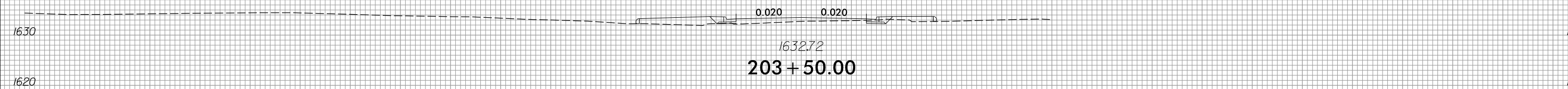

1610 1620 1610 1620

150 140 130 120 110 100 90 80 70 60 50 40 30 20 10 0 10 20 30 40 50 60 70 80 90 100 110 120 130 140 150



150 140 130 120 110 100 90 80 70 60 50 40 30 20 10 0 10 20 30 40 50 60 70 80 90 100 110 120 130 140 150

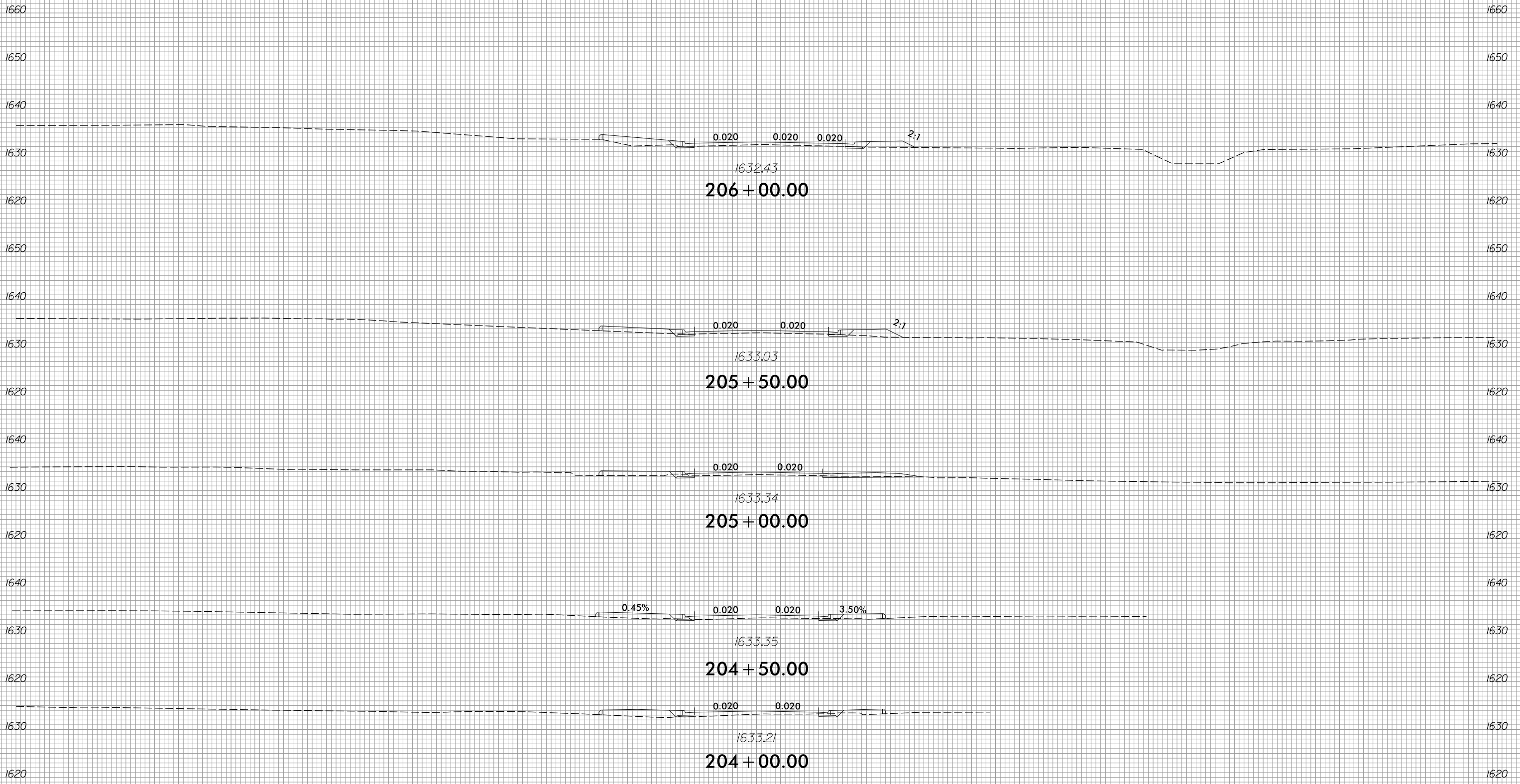

150 140 130 120 110 100 90 80 70 60 50 40 30 20 10 0 10 20 30 40 50 60 70 80 90 100 110 120 130 140 150

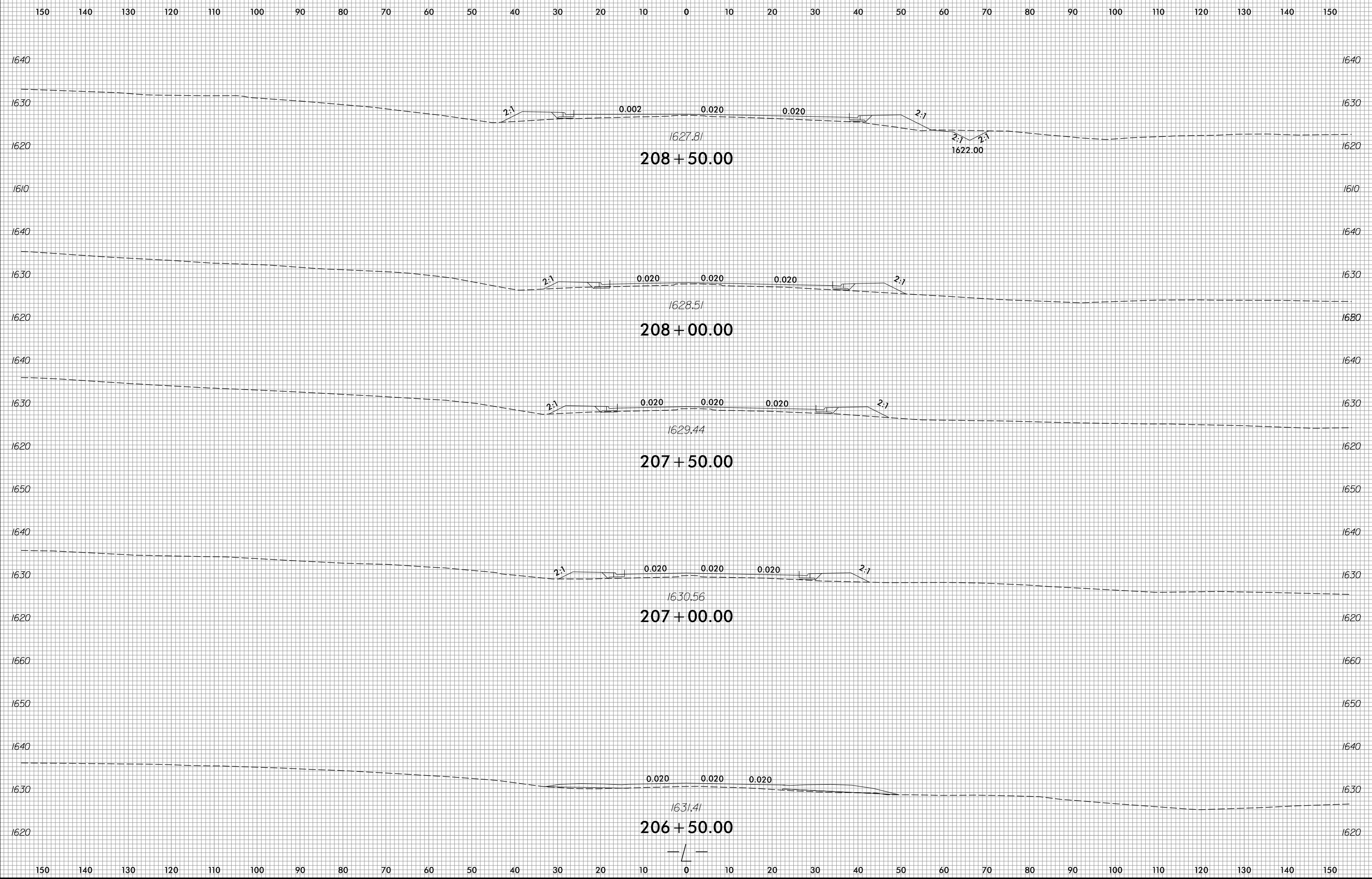

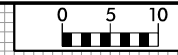

150 140 130 120 110 100 90 80 70 60 50 40 30 20 10 0 10 20 30 40 50 60 70 80 90 100 110 120 130 140 150

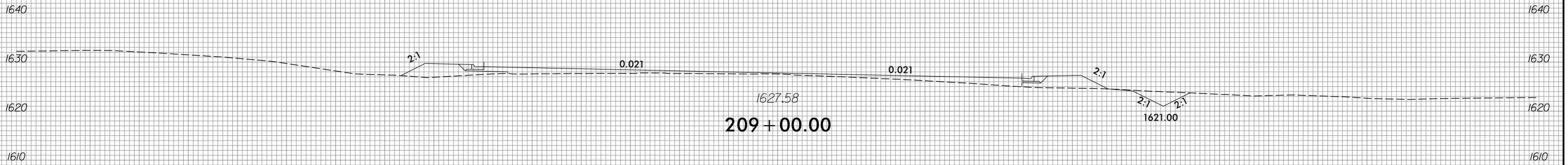

150 140 130 120 110 100 90 80 70 60 50 40 30 20 10 0 10 20 30 40 50 60 70 80 90 100 110 120 130 140 150

6/23/16



PROJ. REFERENCE NO.
R-5861

SHEET NO.
X-201

75 70 65 60 55 50 45 40 35 30 25 20 15 10 5 0 5 10 15 20 25 30 35 40 45 50 55 60 65 70 75

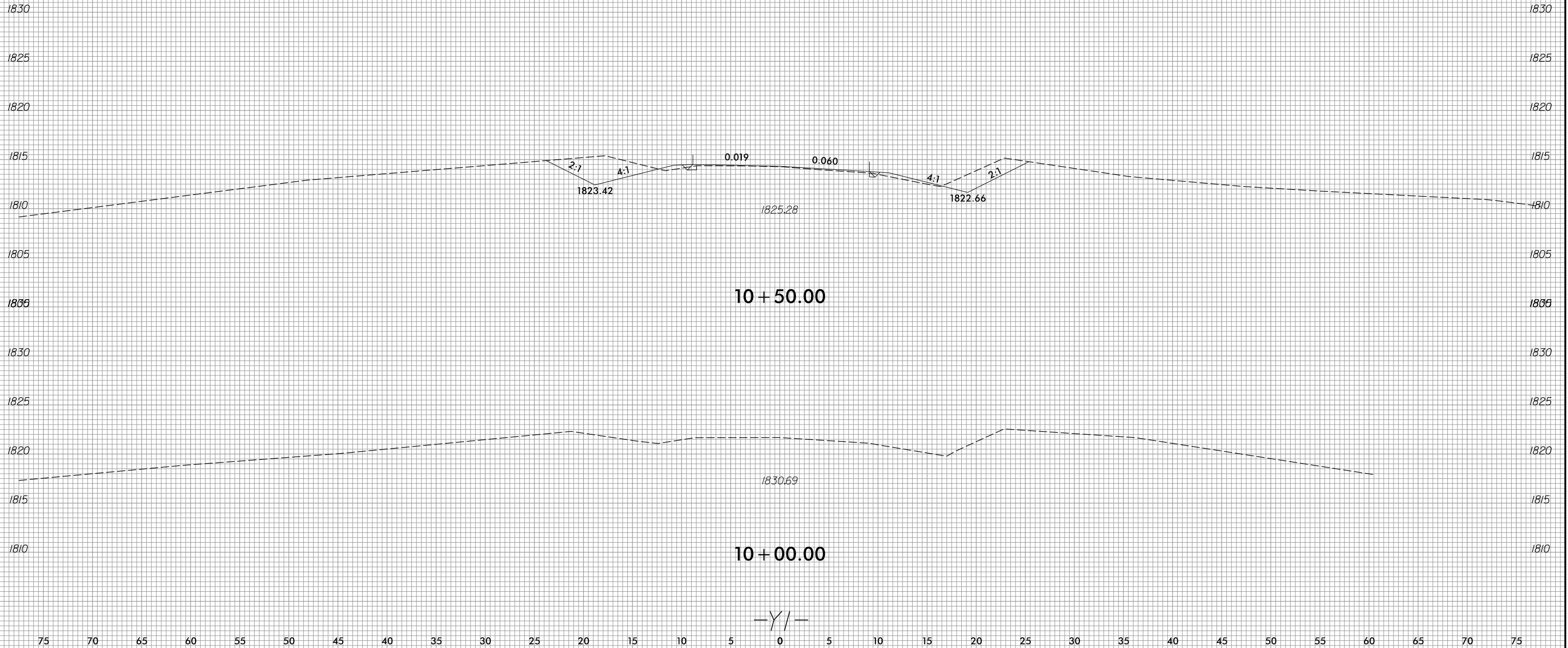

8/3/2023
R:\Roadway\XSC\XPLs\RB861\RDy.XPL_Y1.dgn
jlinson

75 70 65 60 55 50 45 40 35 30 25 20 15 10 5 0 5 10 15 20 25 30 35 40 45 50 55 60 65 70 75

6/23/16

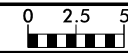

PROJ. REFERENCE NO.	SHEET NO.
R-5861	X-202

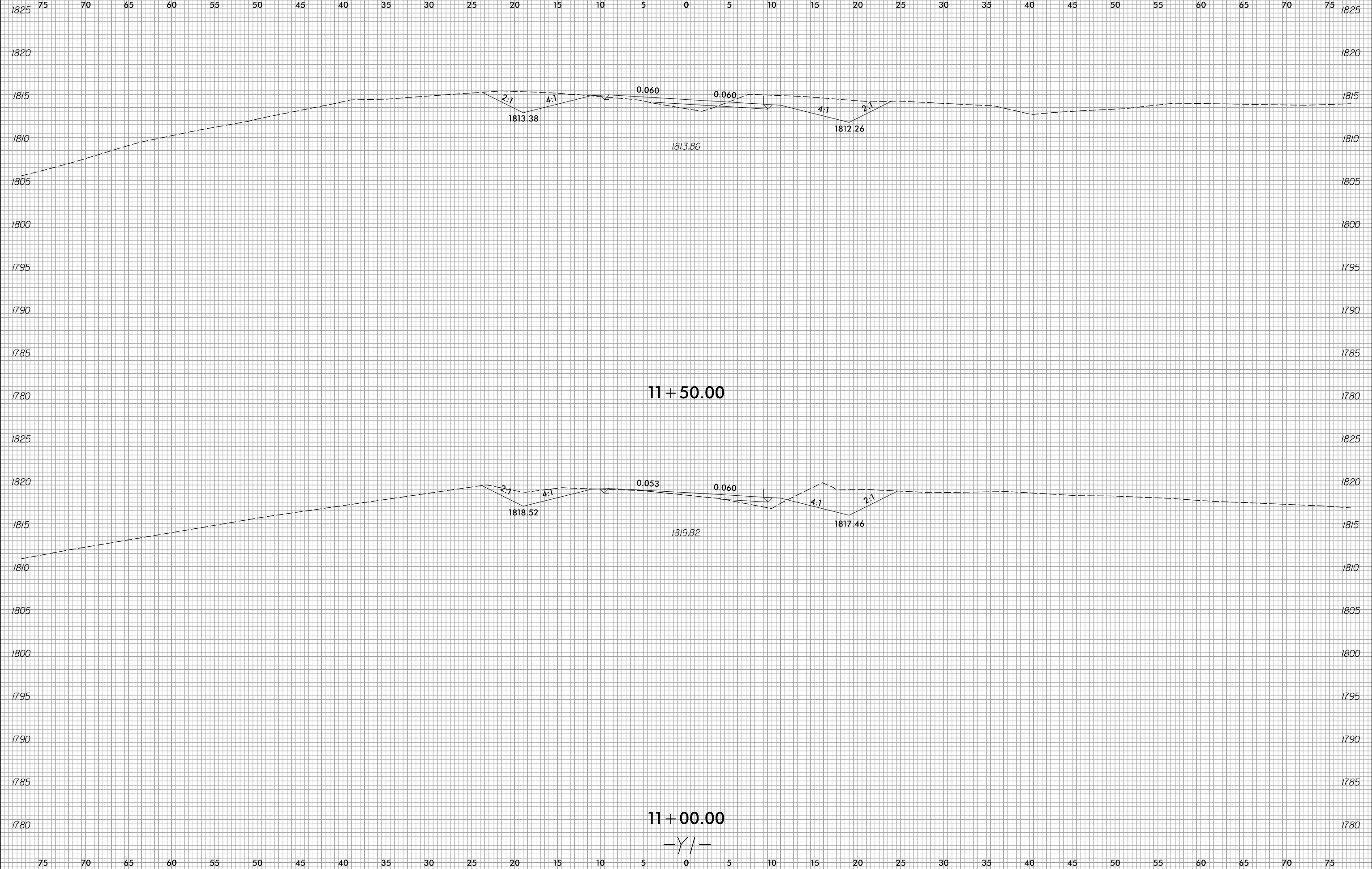

8/3/2023
R:\Roadway\XSC\XPLs\RB861_Rdy_XPL_Y1.dgn
jinson

6/23/16

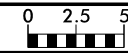

PROJ. REFERENCE NO.
R-5861

SHEET NO.
X-203

75 70 65 60 55 50 45 40 35 30 25 20 15 10 5 0 5 10 15 20 25 30 35 40 45 50 55 60 65 70 75

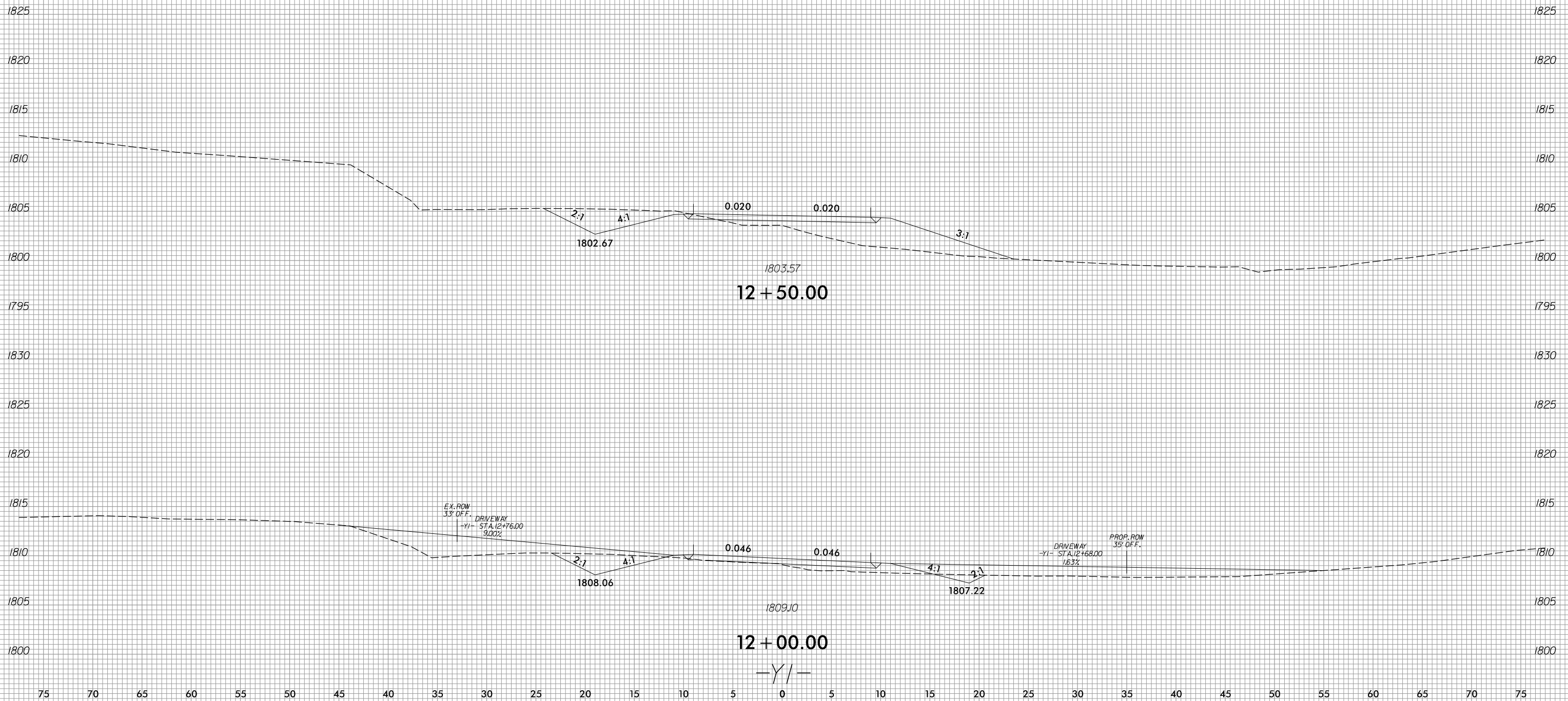

8/3/2023
R:\Roadway\XSC\XPLs\RB861_Rdy_XPL_Y1.dgn
J.Hinson

75 70 65 60 55 50 45 40 35 30 25 20 15 10 5 0 5 10 15 20 25 30 35 40 45 50 55 60 65 70 75

6/23/16

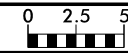

PROJ. REFERENCE NO.	SHEET NO.
R-5861	X-204

75 70 65 60 55 50 45 40 35 30 25 20 15 10 5 0 5 10 15 20 25 30 35 40 45 50 55 60 65 70 75

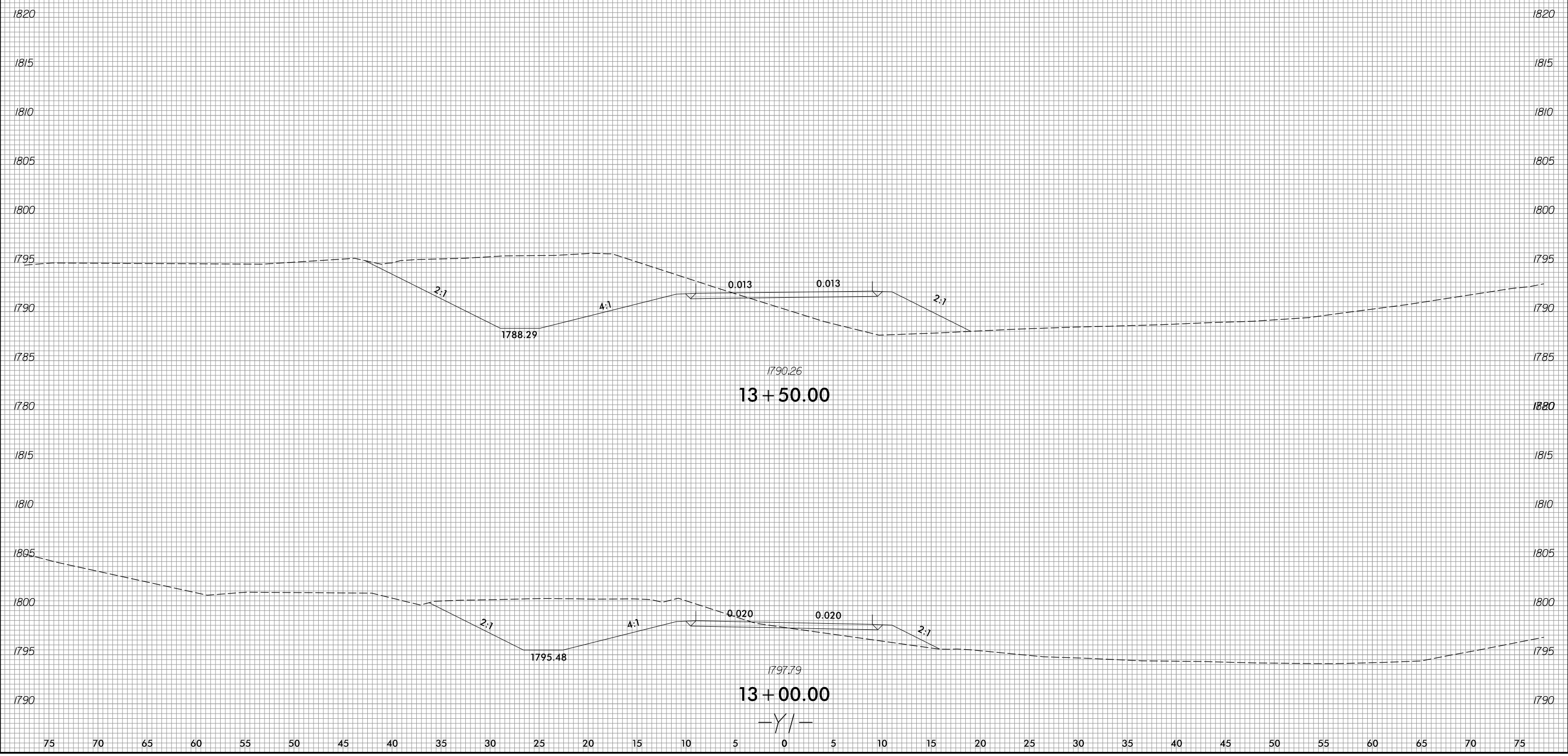

8/3/2023
 R:\Roadway\XSC\XPLs\RB861_Rdy_XPL_Y1.dgn
 jinson

75 70 65 60 55 50 45 40 35 30 25 20 15 10 5 0 5 10 15 20 25 30 35 40 45 50 55 60 65 70 75

6/23/16

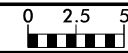

PROJ. REFERENCE NO.
R-5861

SHEET NO.
X-205

75 70 65 60 55 50 45 40 35 30 25 20 15 10 5 0 5 10 15 20 25 30 35 40 45 50 55 60 65 70 75

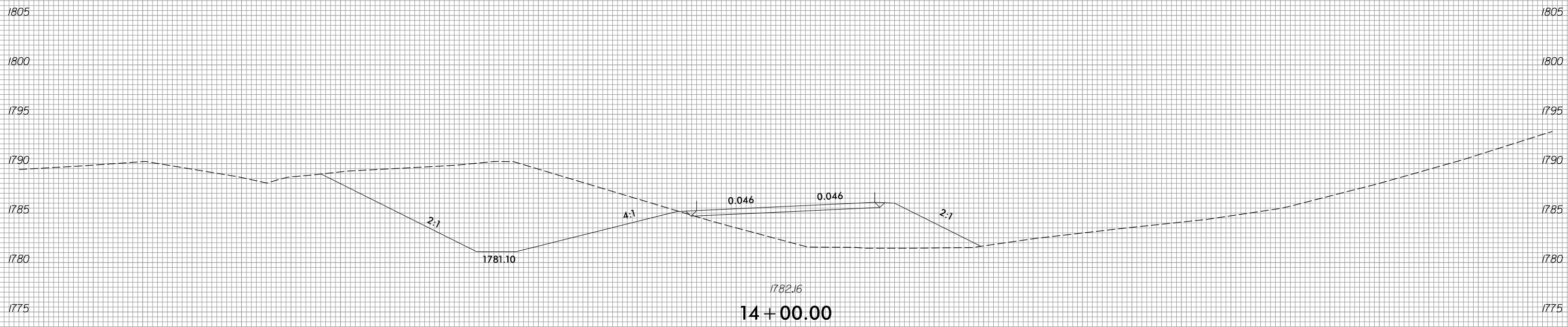
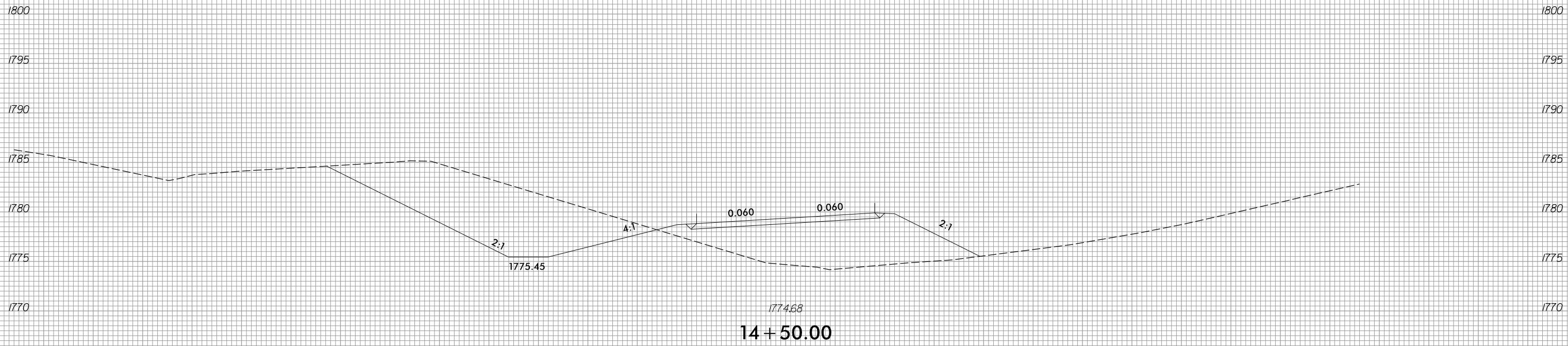

-Y/-

8/3/2023
R:\Roadway\XSC\XPLs\RB861_Rdy_XPL_Y1.dgn
jinson

75 70 65 60 55 50 45 40 35 30 25 20 15 10 5 0 5 10 15 20 25 30 35 40 45 50 55 60 65 70 75

6/23/16

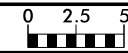

PROJ. REFERENCE NO.	SHEET NO.
R-5861	X-206

75 70 65 60 55 50 45 40 35 30 25 20 15 10 5 0 5 10 15 20 25 30 35 40 45 50 55 60 65 70 75

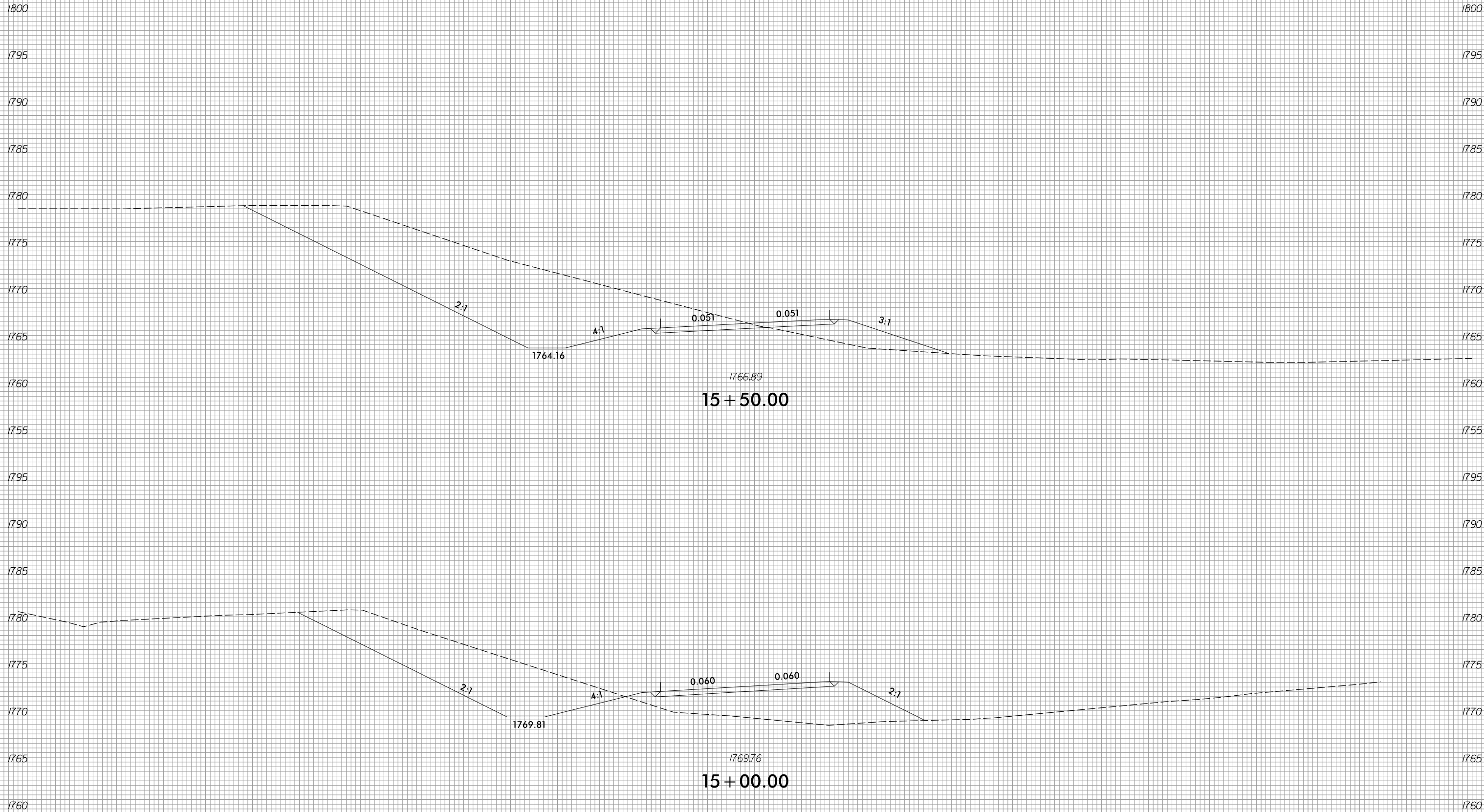

75 70 65 60 55 50 45 40 35 30 25 20 15 10 5 0 5 10 15 20 25 30 35 40 45 50 55 60 65 70 75

8/3/2023
 R:\Roadway\XSC\XPLs\RB861\RDy_XPL_Y1.dgn
 jinson

6/23/16

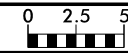

PROJ. REFERENCE NO.	SHEET NO.
R-5861	X-207

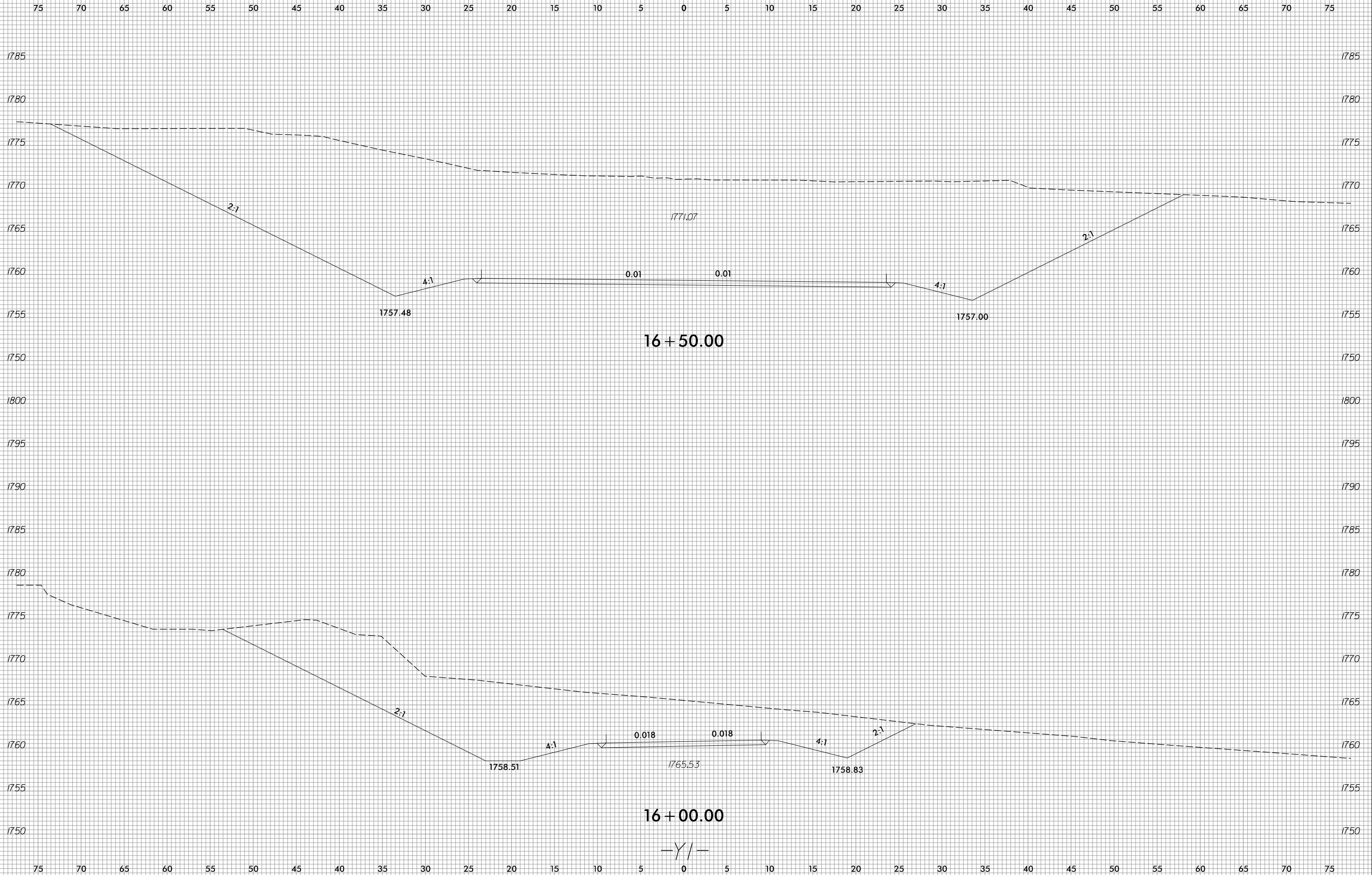

8/3/2023
 R:\Roadway\XSC\XPLs\RB861_Rdy_XPL_Y1.dgn
 jinson

6/23/16

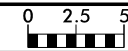

PROJ. REFERENCE NO.	SHEET NO.
R-5861	X-208

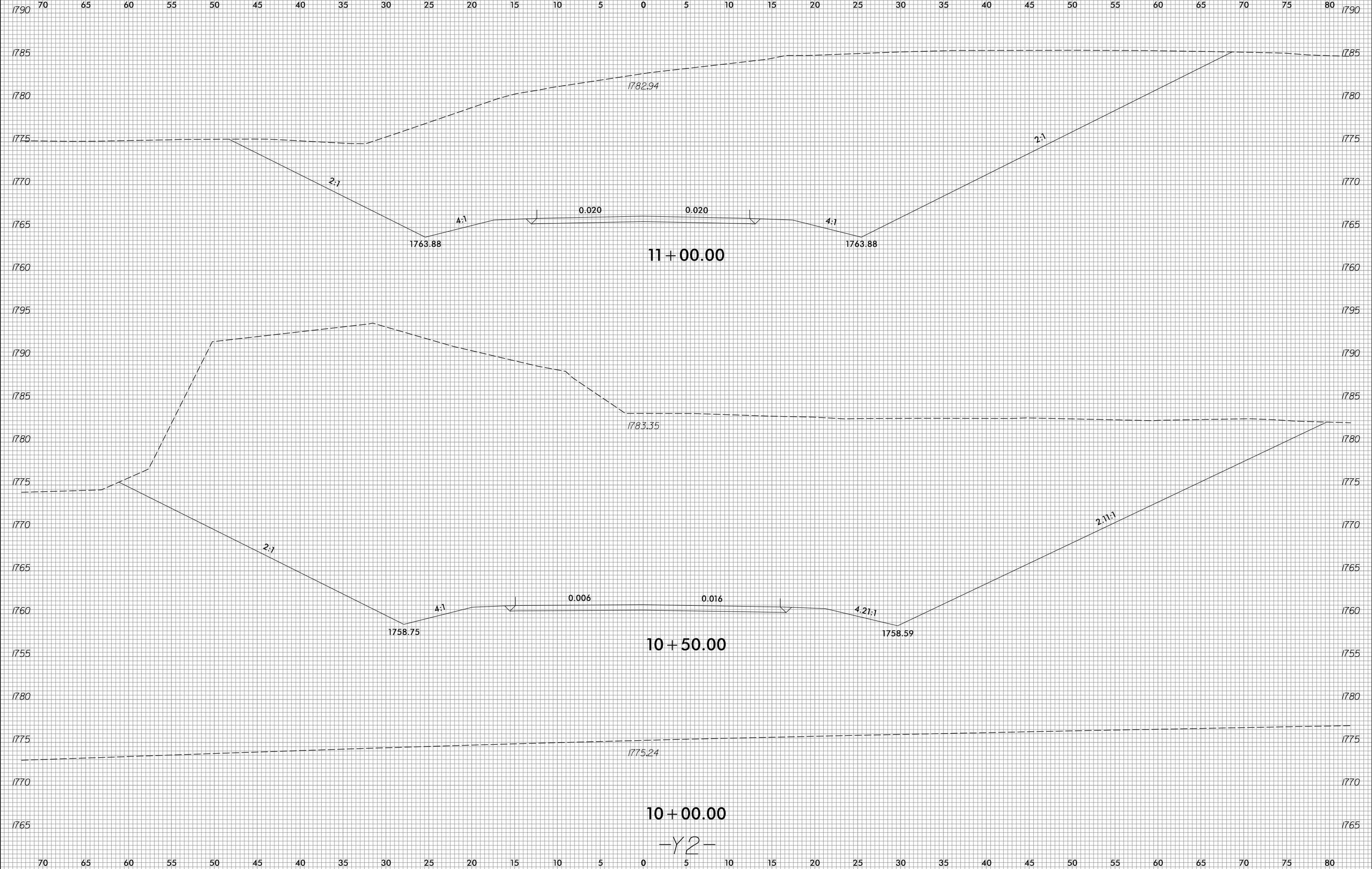

8/3/2023
R:\Roadway\XSC\XPLs\RB861\RDy_XPL_Y2.dgn
jlinson

6/23/16



PROJ. REFERENCE NO.
R-5861

SHEET NO.
X-209

70 65 60 55 50 45 40 35 30 25 20 15 10 5 0 5 10 15 20 25 30 35 40 45 50 55 60 65 70 75 80

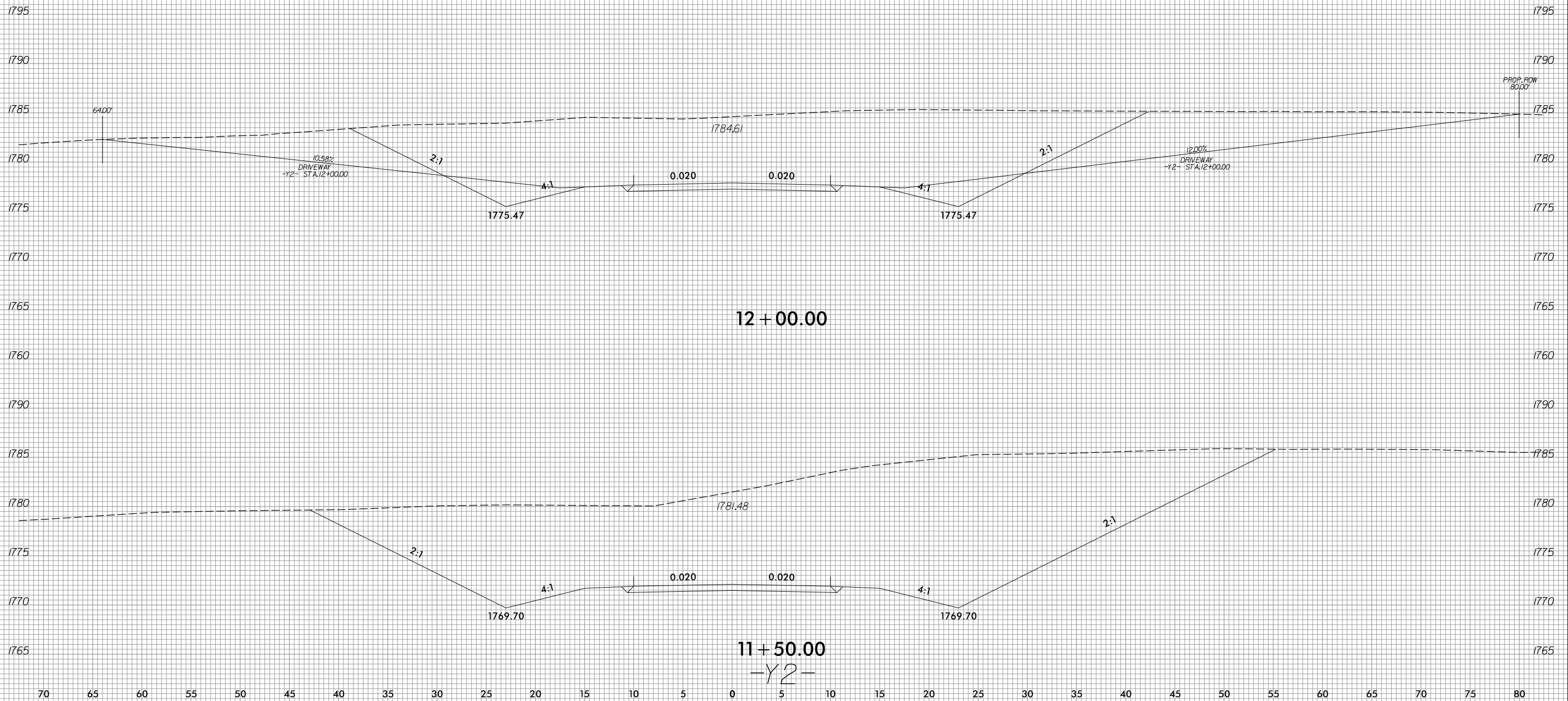

8/3/2023
R:\Roadway\XSC\XPLs\RB861\RDy.XPL_Y2.dgn
J.Hinson

70 65 60 55 50 45 40 35 30 25 20 15 10 5 0 5 10 15 20 25 30 35 40 45 50 55 60 65 70 75 80

6/23/16

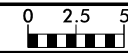

PROJ. REFERENCE NO.	SHEET NO.
R-5861	X-210

70 65 60 55 50 45 40 35 30 25 20 15 10 5 0 5 10 15 20 25 30 35 40 45 50 55 60 65 70 75 80

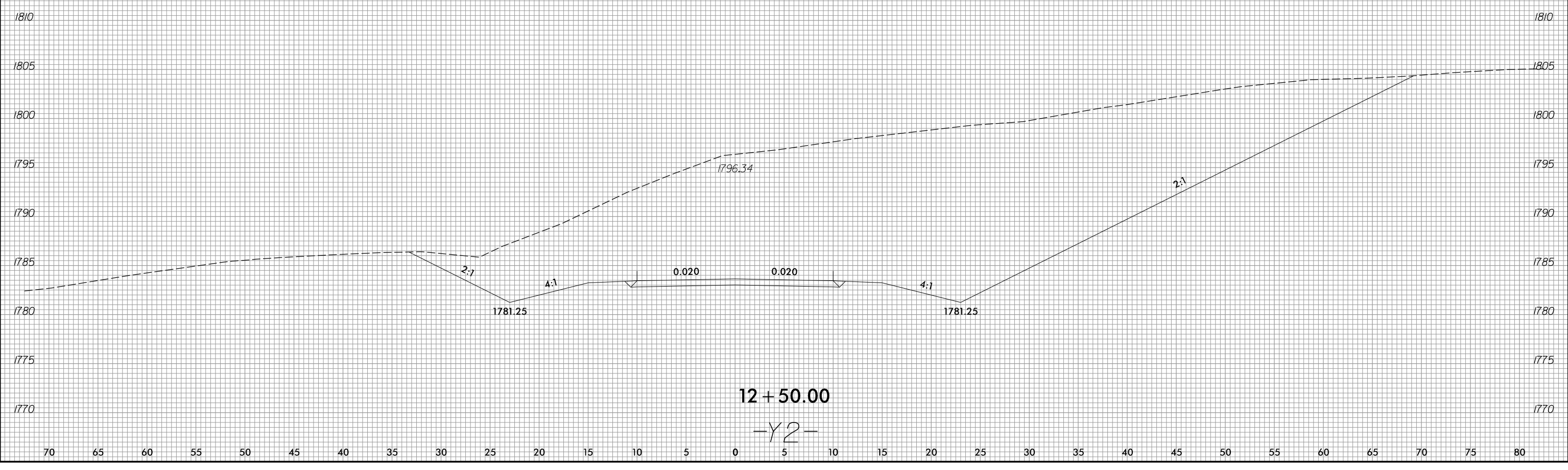
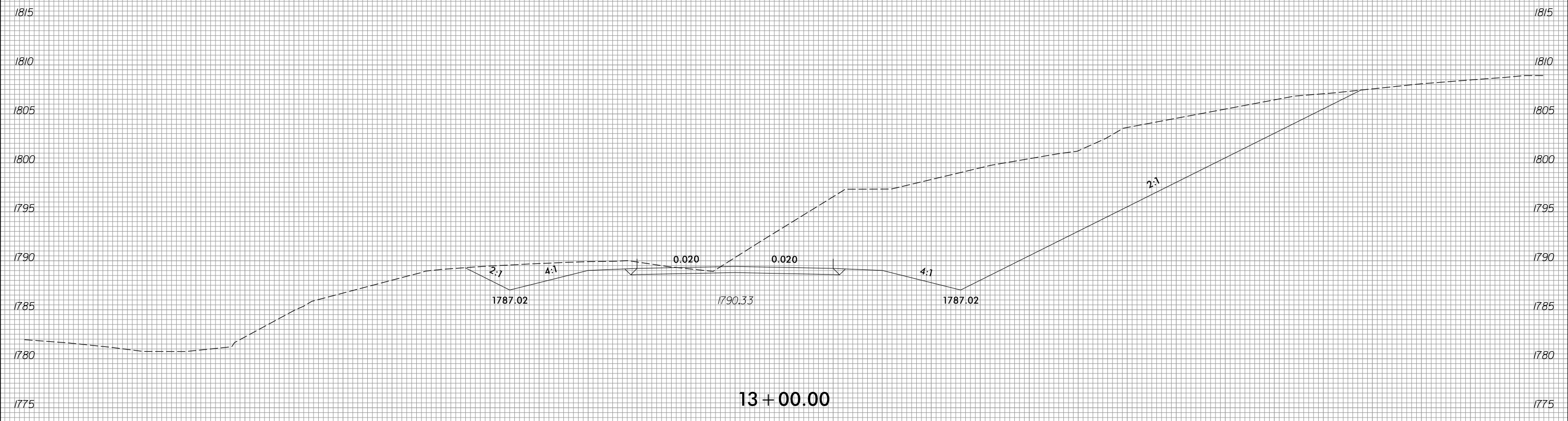

70 65 60 55 50 45 40 35 30 25 20 15 10 5 0 5 10 15 20 25 30 35 40 45 50 55 60 65 70 75 80

8/3/2023
R:\Roadway\XSC\XPLs\RB661.Rdy.XPL_Y2.dgn
J.Hinson

6/23/16

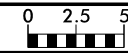

PROJ. REFERENCE NO.	SHEET NO.
R-5861	X-211

70 65 60 55 50 45 40 35 30 25 20 15 10 5 0 5 10 15 20 25 30 35 40 45 50 55 60 65 70 75 80

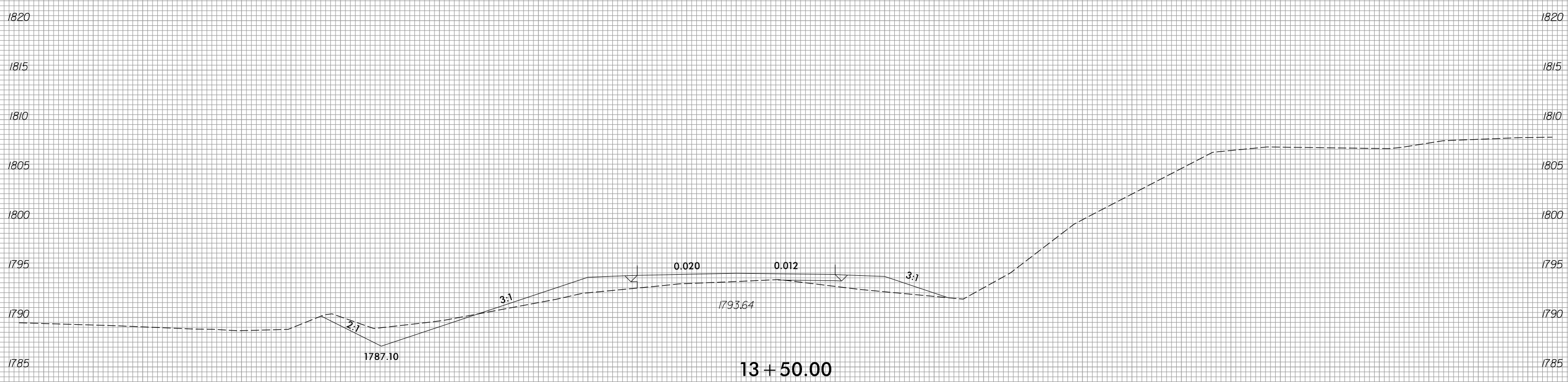
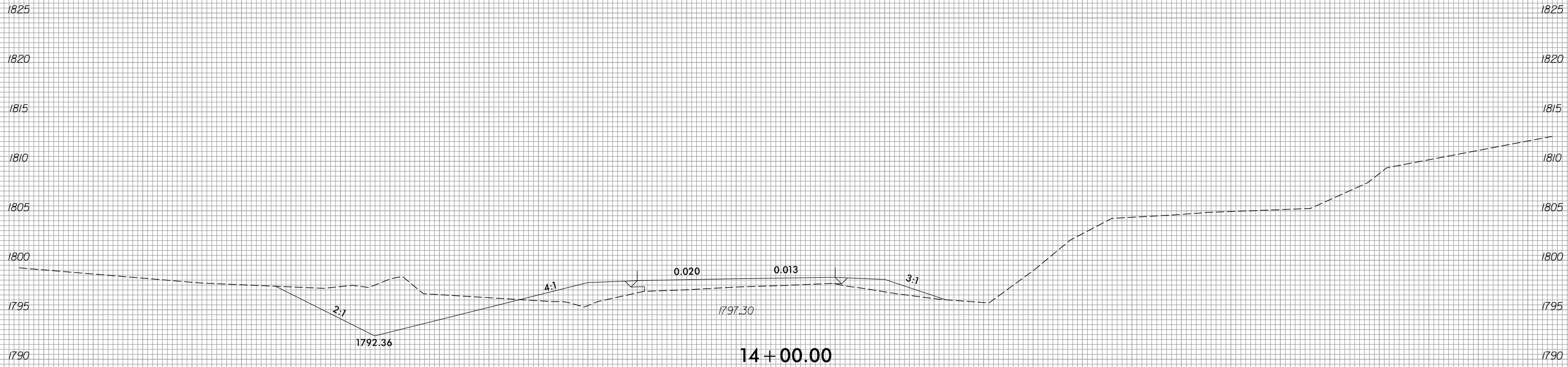

-Y2-

8/3/2023
R:\Roadway\XSC\XPLs\RB861\RDy_XPL_Y2.dgn
J.Hanson

70 65 60 55 50 45 40 35 30 25 20 15 10 5 0 5 10 15 20 25 30 35 40 45 50 55 60 65 70 75 80

6/23/16

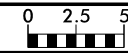

PROJ. REFERENCE NO.	SHEET NO.
R-5861	X-212

70 65 60 55 50 45 40 35 30 25 20 15 10 5 0 5 10 15 20 25 30 35 40 45 50 55 60 65 70 75 80

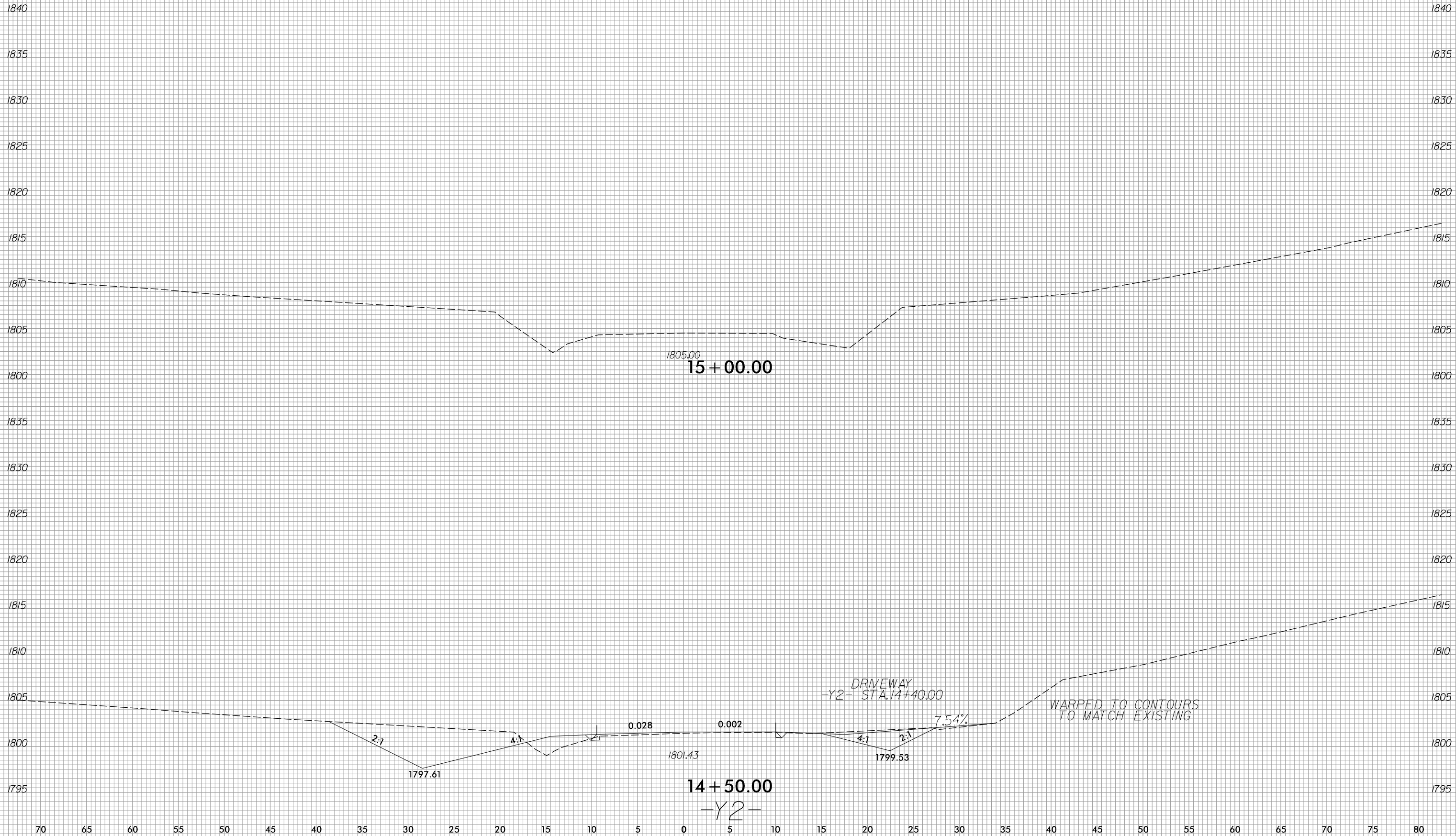

8/3/2023
 R:\Roadway\XSC\XPLs\RB861_Rdy_XPL_Y2.dgn
 jinson

6/23/16

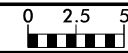

PROJ. REFERENCE NO.	SHEET NO.
R-5861	X-213

70 65 60 55 50 45 40 35 30 25 20 15 10 5 0 5 10 15 20 25 30 35 40 45 50 55 60 65 70 75 80

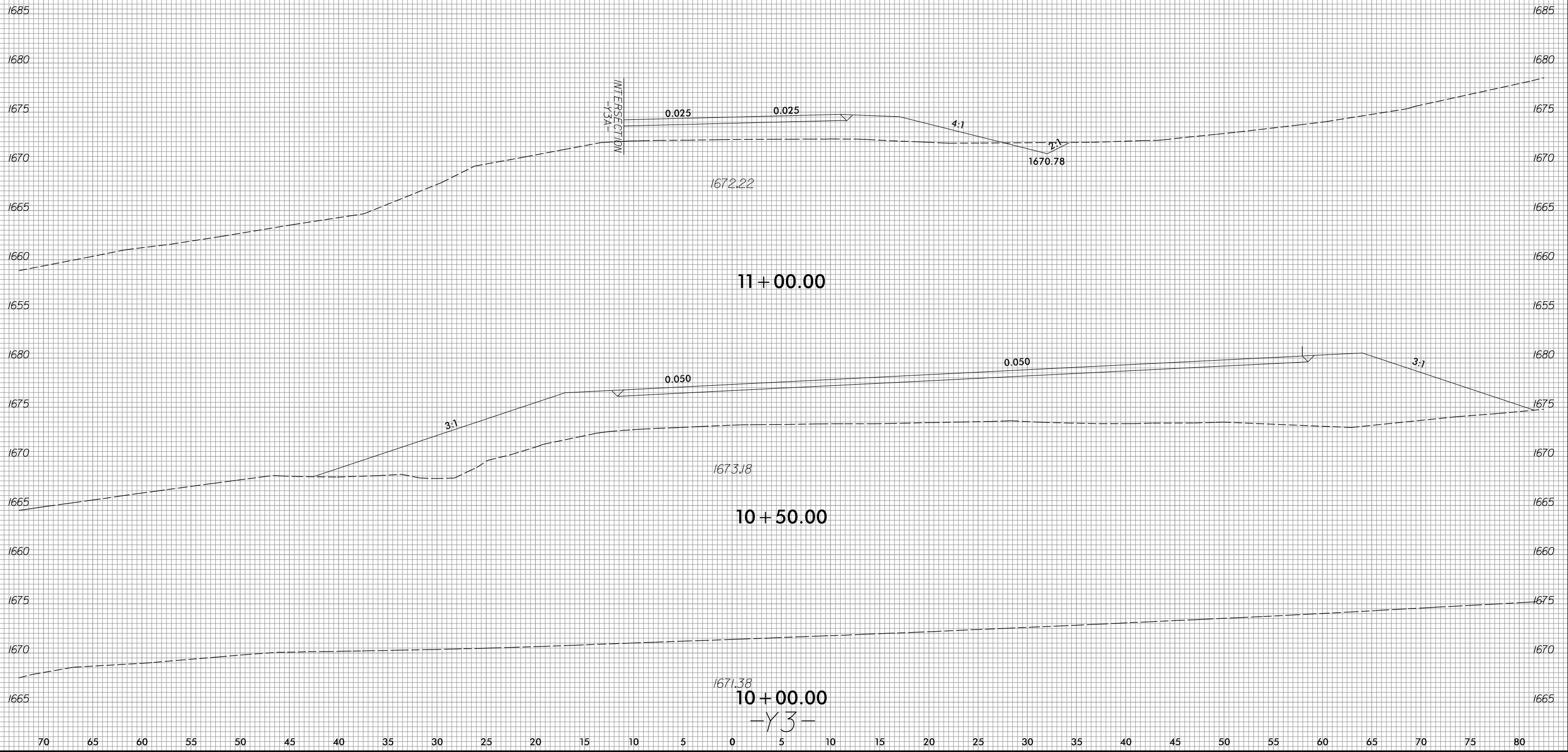

8/3/2023
 R:\Roadway\XSC\XPLs\RB861\RDy_XPL_Y3.dgn
 jinson

70 65 60 55 50 45 40 35 30 25 20 15 10 5 0 5 10 15 20 25 30 35 40 45 50 55 60 65 70 75 80

6/23/16

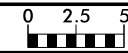

PROJ. REFERENCE NO.	SHEET NO.
R-5861	X-214

90 85 80 75 70 65 60 55 50 45 40 35 30 25 20 15 10 5 0 5 10 15 20 25 30 35 40 45 50 55 60 65

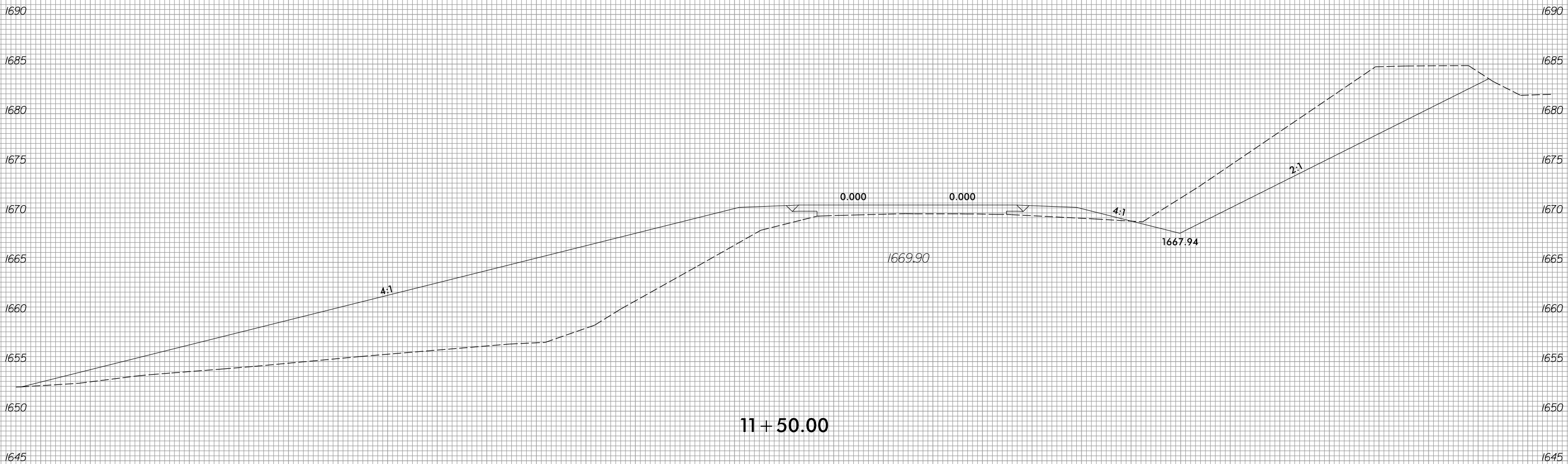

8/3/2023
 R:\Roadway\XSC\XPLs\RB861_Rdy_XPL_Y3.dgn
 jinson

90 85 80 75 70 65 60 55 50 45 40 35 30 25 20 15 10 5 0 5 10 15 20 25 30 35 40 45 50 55 60 65

-Y3-

6/23/16

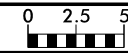

PROJ. REFERENCE NO.
R-5861

SHEET NO.
X-215

85 80 75 70 65 60 55 50 45 40 35 30 25 20 15 10 5 0 5 10 15 20 25 30 35 40 45 50 55 60 65

1695
1690
1685
1680
1675
1670
1665
1660
1655
1650
1645

1695
1690
1685
1680
1675
1670
1665
1660
1655
1650
1645

4:1

0.020

0.020

1667.96

INTERSECTION
-DR7-

12 + 00.00

-Y3-

85 80 75 70 65 60 55 50 45 40 35 30 25 20 15 10 5 0 5 10 15 20 25 30 35 40 45 50 55 60 65

8/3/2023
R:\Roadway\XSC\XPLs\RB861_Rdy_XPL_Y3.dgn
jlinson

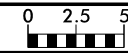

85 80 75 70 65 60 55 50 45 40 35 30 25 20 15 10 5 0 5 10 15 20 25 30 35 40 45 50 55 60 65

1720
1715
1710
1705
1700
1695
1690
1685
1680
1675

MATCHLINE

MATCHLINE

1695
1690
1685
1680
1675
1670
1665
1660
1655
1650
1645

1695
1690
1685
1680
1675
1670
1665
1660
1655
1650
1645

60 65 70 75 80 85 90 95 100 105 110 115 120 125 130 135

4:1

2:1

2:1

4:1

0.011

0.031

1666.71

1664.43

12 + 50.00

-Y3-

85 80 75 70 65 60 55 50 45 40 35 30 25 20 15 10 5 0 5 10 15 20 25 30 35 40 45 50 55 60 65

6/23/16



PROJ. REFERENCE NO.	SHEET NO.
R-5861	X-217

85 80 75 70 65 60 55 50 45 40 35 30 25 20 15 10 5 0 5 10 15 20 25 30 35 40 45 50 55 60 65

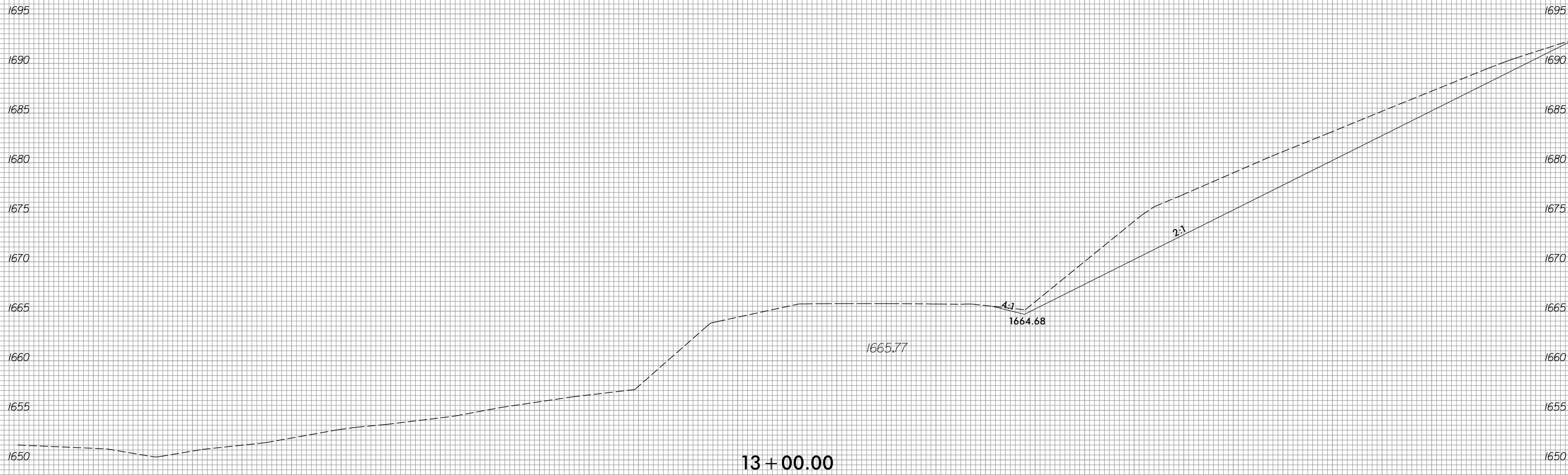

13+00.00

-Y3-

8/3/2023
R:\Roadway\XSC\XPLs\RB861_Rdy_XPL_Y3.dgn
jlinson

6/23/16

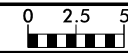

PROJ. REFERENCE NO.	SHEET NO.
R-5861	X-218

PROJ. REFERENCE NO.	SHEET NO.
R-5861	X-218

85 80 75 70 65 60 55 50 45 40 35 30 25 20 15 10 5 0 5 10 15 20 25 30 35 40 45 50 55 60 65

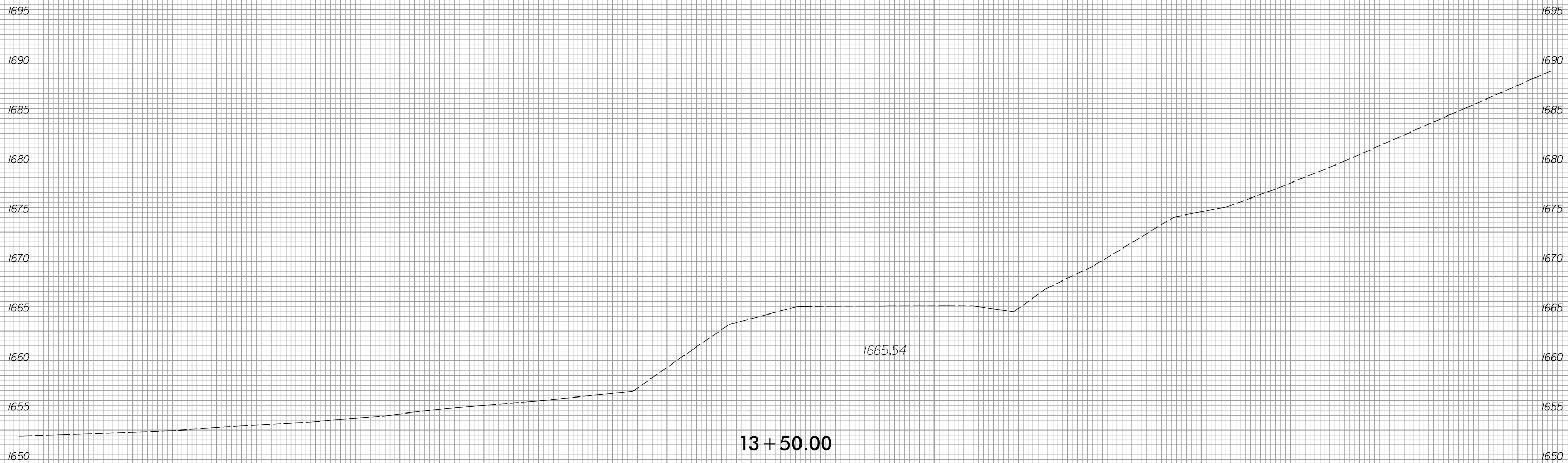

13+50.00

-Y3-

8/3/2023
 R:\Roadway\XSC\XPLs\RB861\RDY.XPL_Y3.dgn
 jinson

85 80 75 70 65 60 55 50 45 40 35 30 25 20 15 10 5 0 5 10 15 20 25 30 35 40 45 50 55 60 65

6/23/16

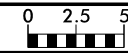

PROJ. REFERENCE NO.
R-5861

SHEET NO.
X-219

75 70 65 60 55 50 45 40 35 30 25 20 15 10 5 0 5 10 15 20 25 30 35 40 45 50 55 60 65 70 75

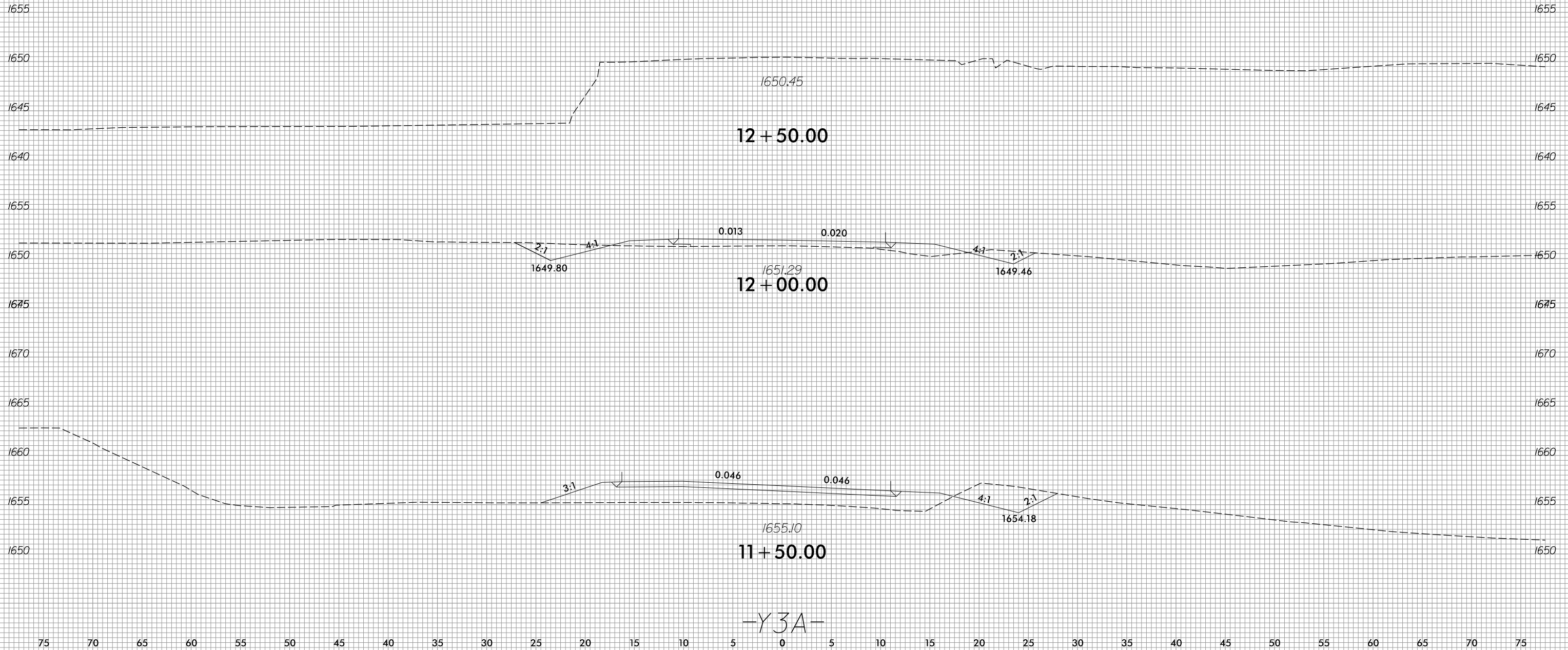

1655 1650 1645 1640 1655 1650 1675 1670 1665 1660 1655 1650 75 70 65 60 55 50 45 40 35 30 25 20 15 10 5 0 5 10 15 20 25 30 35 40 45 50 55 60 65 70 75

8/3/2023
R:\Roadway\XSC\XPLs\RB861_Rdy_XPL_Y3A.dgn
jlinson

-Y3A-

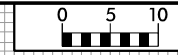

150 140 130 120 110 100 90 80 70 60 50 40 30 20 10 0 10 20 30 40 50 60 70 80 90 100 110 120 130 140 150

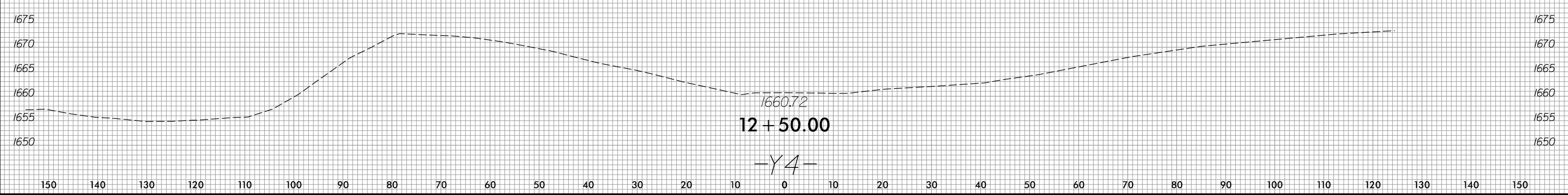
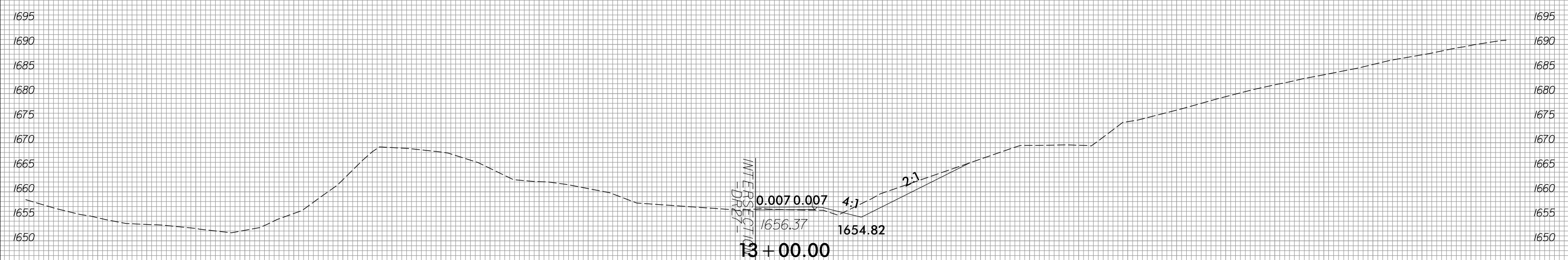
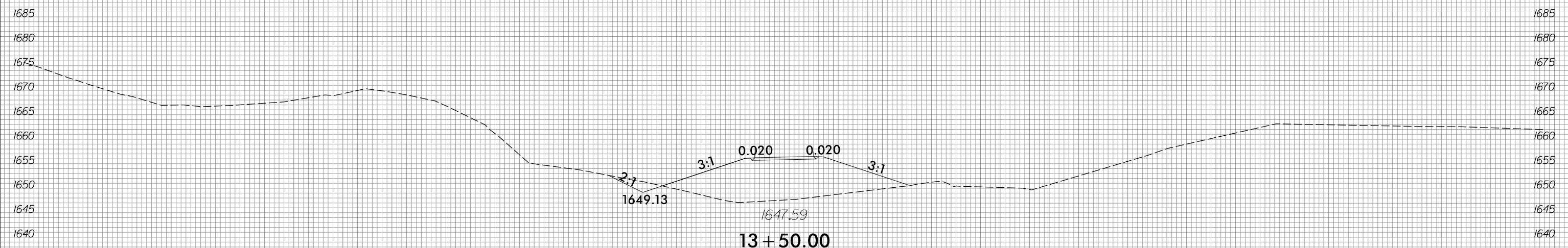

150 140 130 120 110 100 90 80 70 60 50 40 30 20 10 0 10 20 30 40 50 60 70 80 90 100 110 120 130 140 150

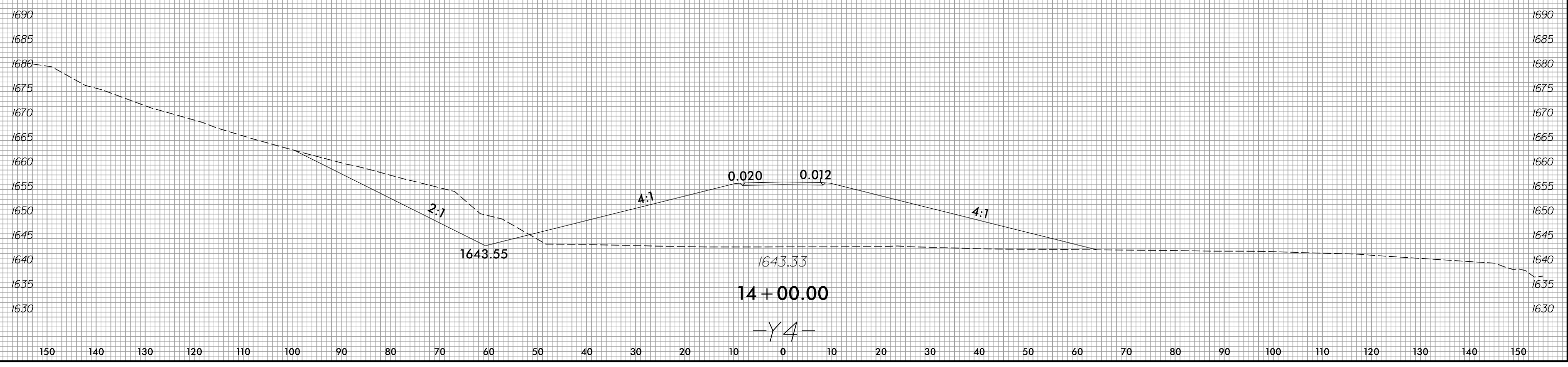
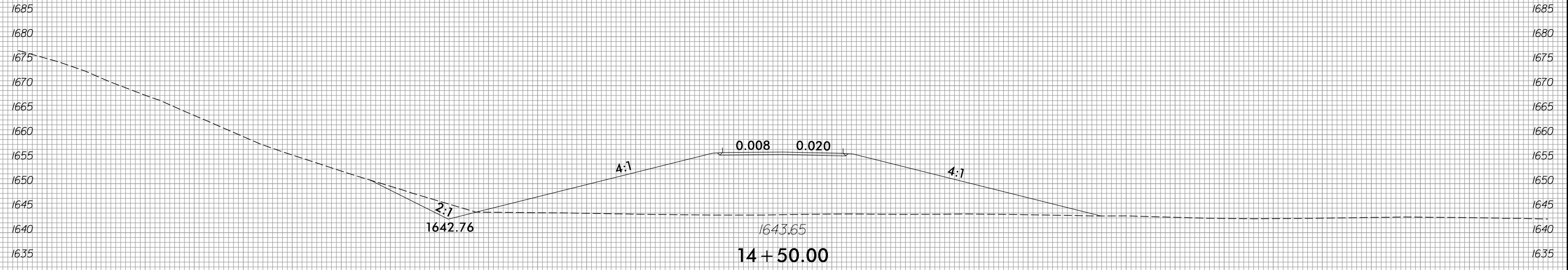
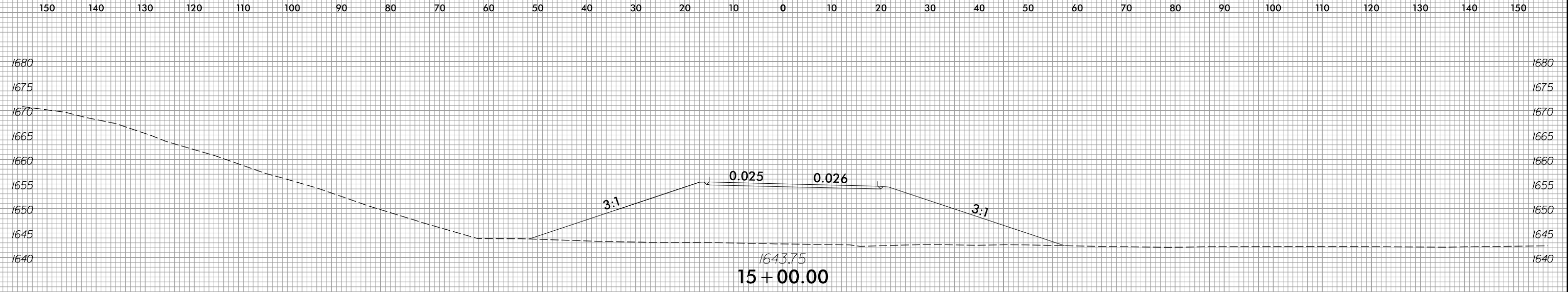

6/23/16



PROJ. REFERENCE NO.
R-5861

SHEET NO.
X-222

75 70 65 60 55 50 45 40 35 30 25 20 15 10 5 0 5 10 15 20 25 30 35 40 45 50 55 60 65 70 75

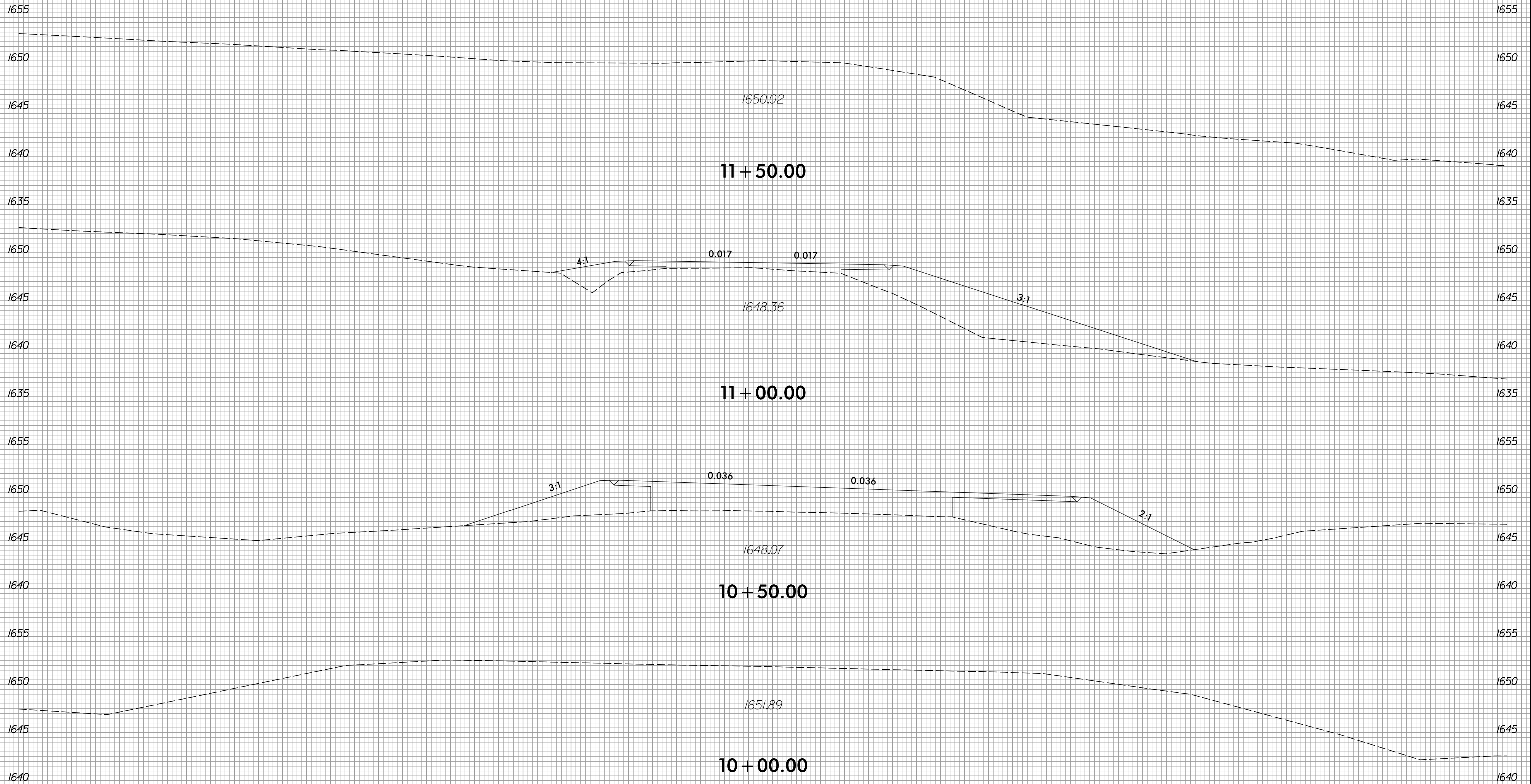

75 70 65 60 55 50 45 40 35 30 25 20 15 10 5 0 5 10 15 20 25 30 35 40 45 50 55 60 65 70 75

-Y5-

8/3/2023
R:\Roadway\XSC\XPLs\RB861_Rdy_XPL_Y5.dgn
jinson

6/23/16

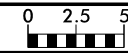

PROJ. REFERENCE NO.	SHEET NO.
R-5861	X-223

75 70 65 60 55 50 45 40 35 30 25 20 15 10 5 0 5 10 15 20 25 30 35 40 45 50 55 60 65 70 75

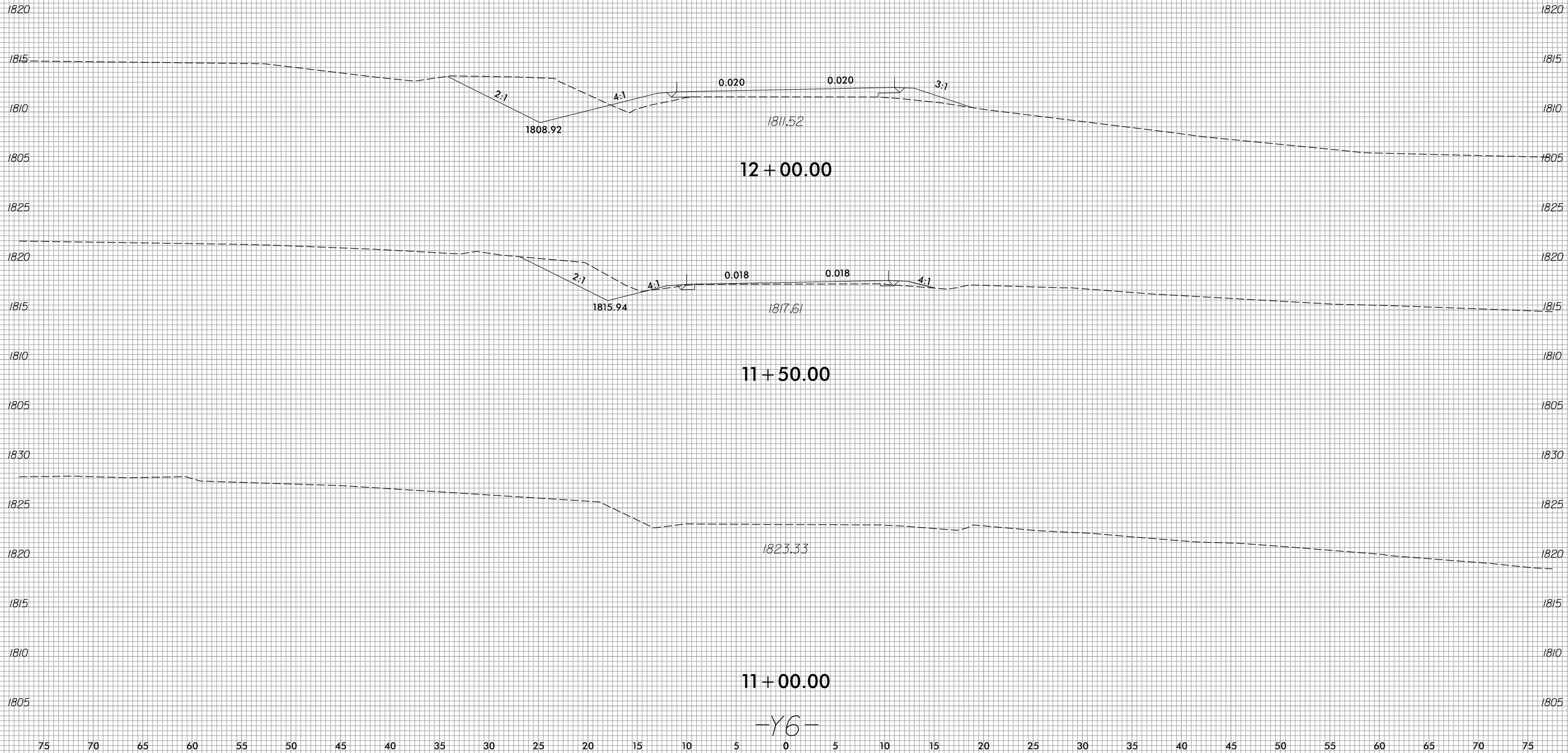

-Y6-

8/3/2023
 R:\Roadway\XSC\XPLs\RB861\RDY.XPL_Y6.dgn
 jinson

6/23/16

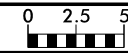

PROJ. REFERENCE NO.
R-5861

SHEET NO.
X-224

75 70 65 60 55 50 45 40 35 30 25 20 15 10 5 0 5 10 15 20 25 30 35 40 45 50 55 60 65 70 75

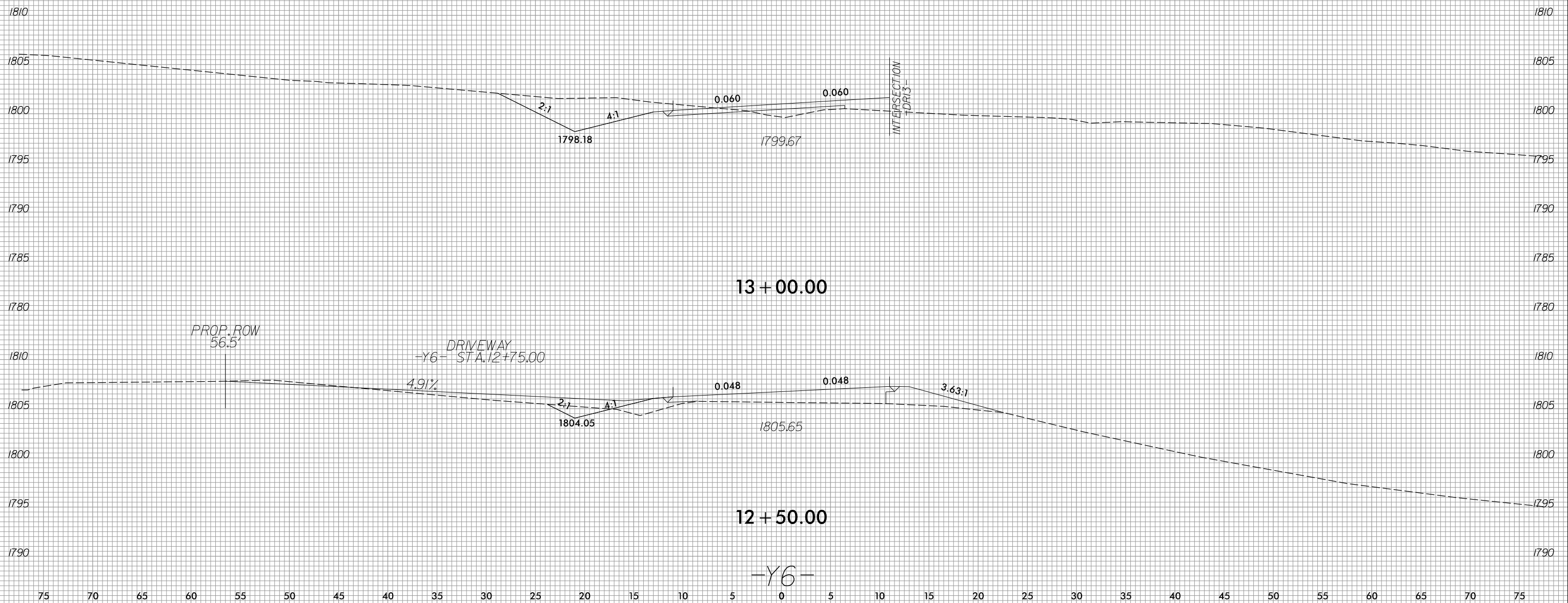

8/3/2023
R:\Roadway\XSC\XPLs\RB861\RDY_XPL_Y6.dgn
jlinson

6/23/16



PROJ. REFERENCE NO.	SHEET NO.
R-5861	X-225

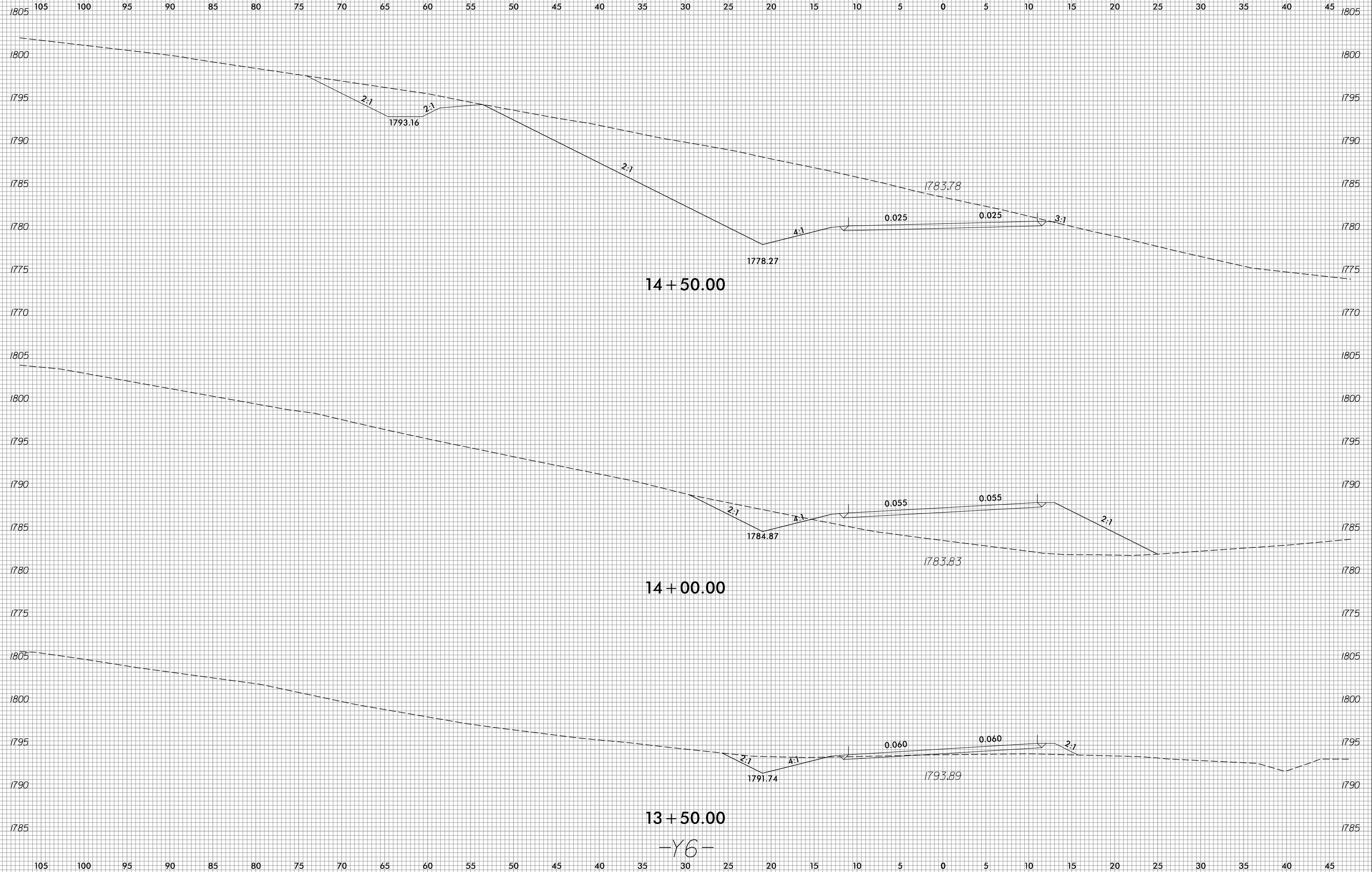

8/3/2023
R:\Roadway\XSC\XPLs\RB861_Rdy_XPL_Y6.dgn
jlinson

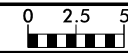

105 100 95 90 85 80 75 70 65 60 55 50 45 40 35 30 25 20 15 10 5 0 5 10 15 20 25 30 35 40 45

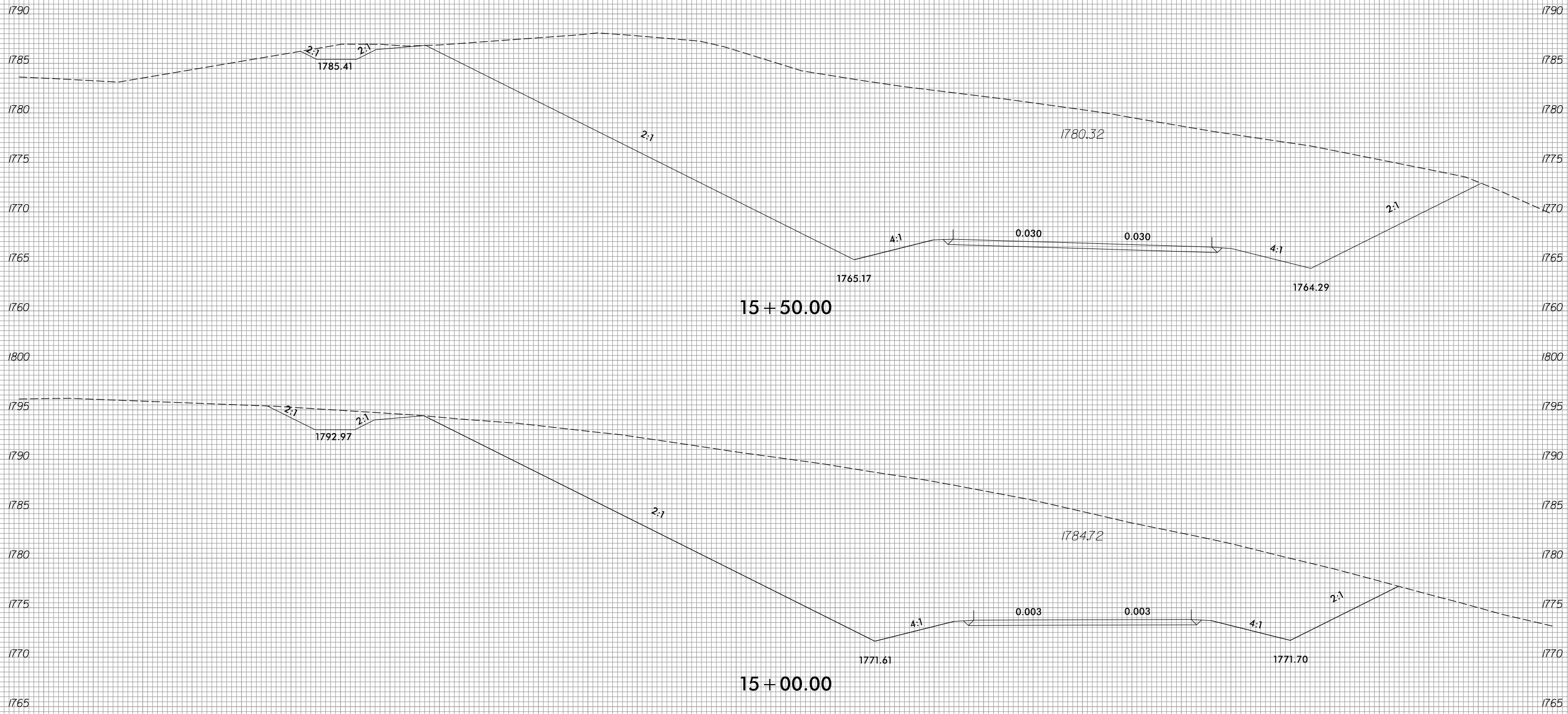

-Y6-

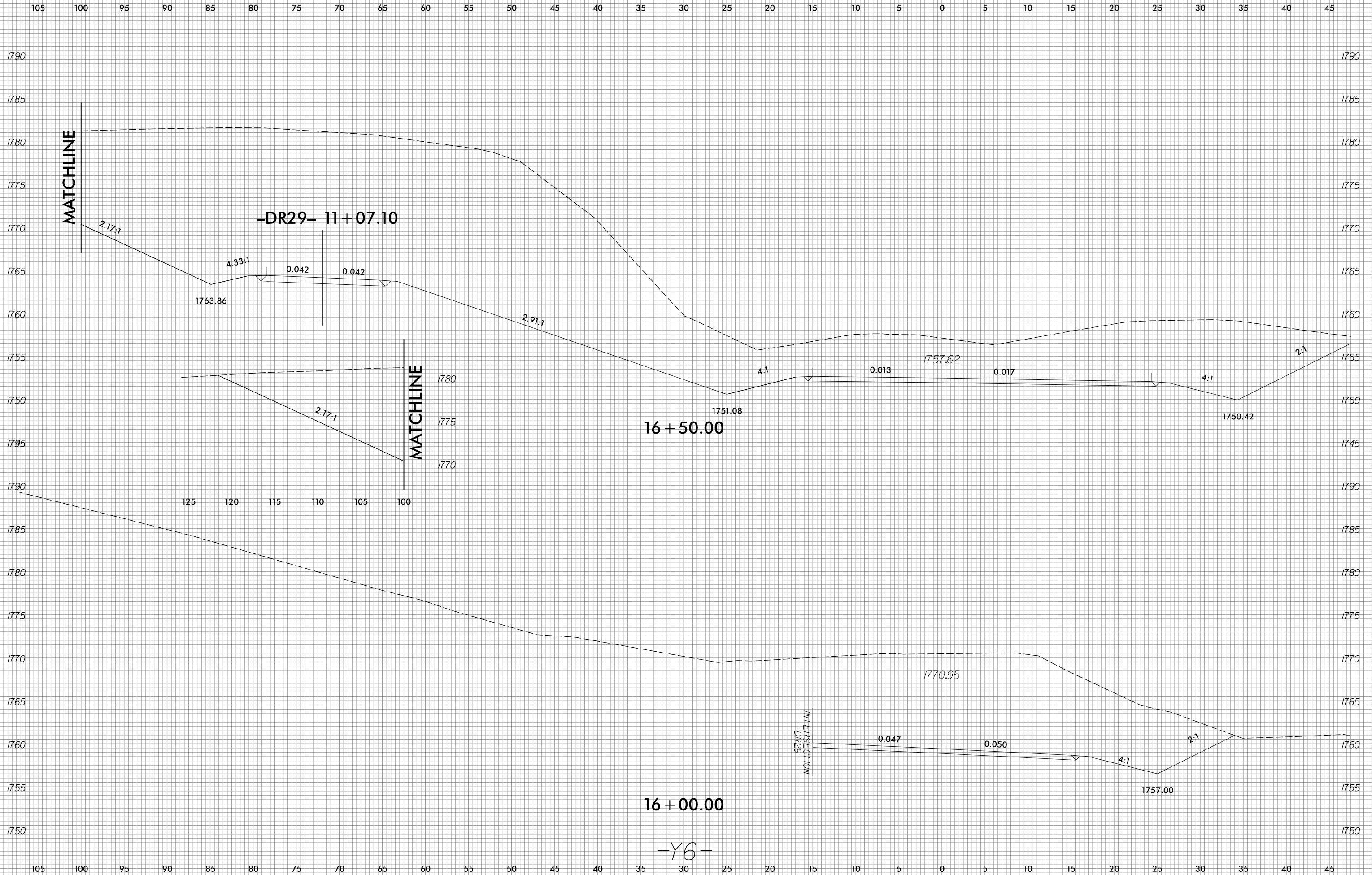
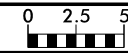

-Y6-

6/23/16

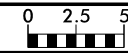

PROJ. REFERENCE NO.	SHEET NO.
R-5861	X-228

75 70 65 60 55 50 45 40 35 30 25 20 15 10 5 0 5 10 15 20 25 30 35 40 45 50 55 60 65 70 75

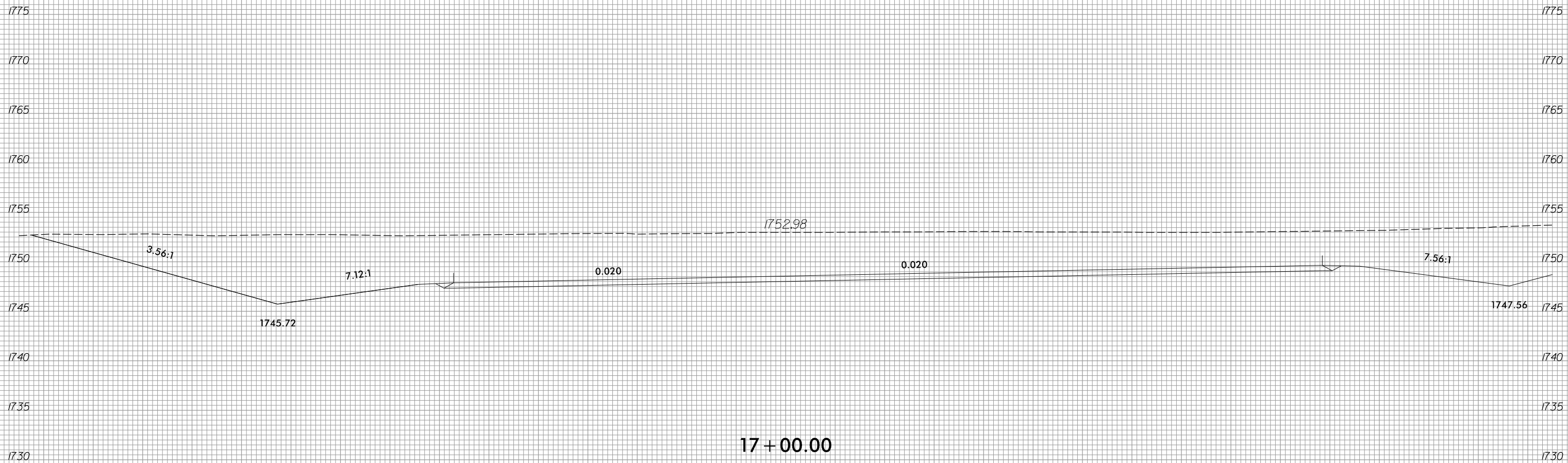

17+00.00

-Y6-

8/3/2023
R:\Roadway\XSC\XPLs\RB861.Rdy.XPL_Y6.dgn
Pinson

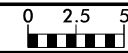

75 70 65 60 55 50 45 40 35 30 25 20 15 10 5 0 5 10 15 20 25 30 35 40 45 50 55 60 65 70 75

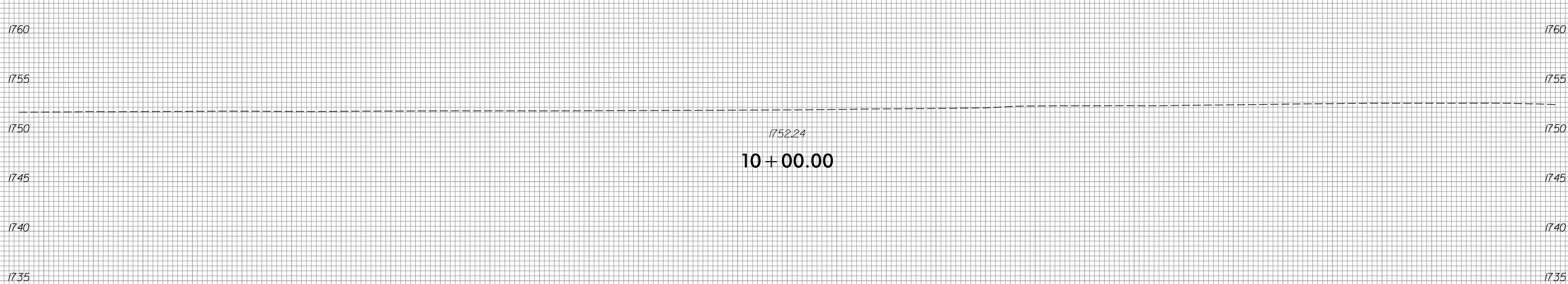
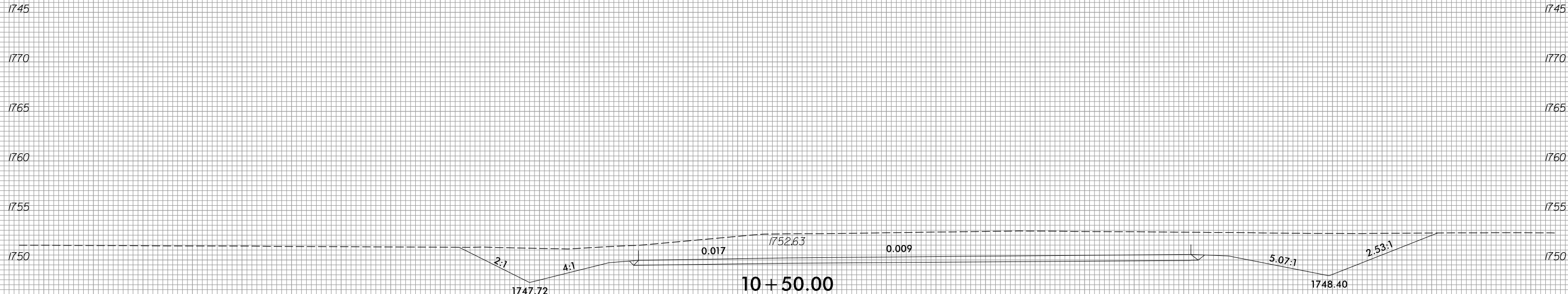
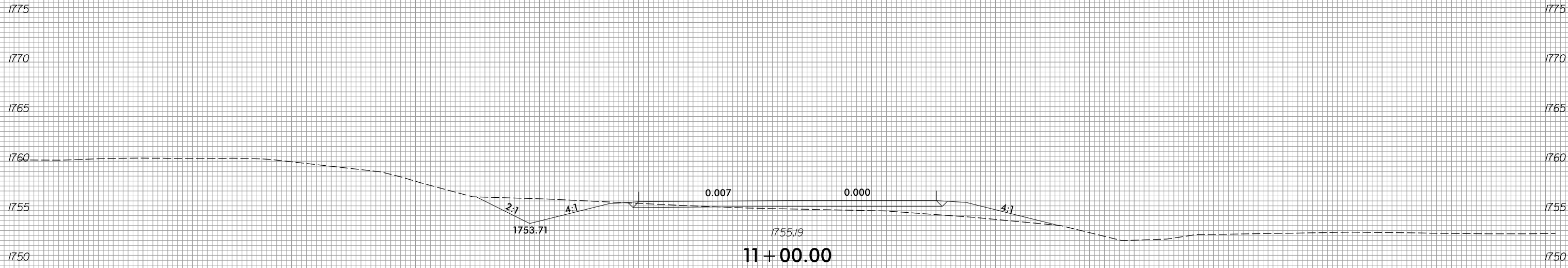

-Y7-

6/23/16

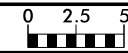

PROJ. REFERENCE NO.	SHEET NO.
R-5861	X-230

75 70 65 60 55 50 45 40 35 30 25 20 15 10 5 0 5 10 15 20 25 30 35 40 45 50 55 60 65 70 75

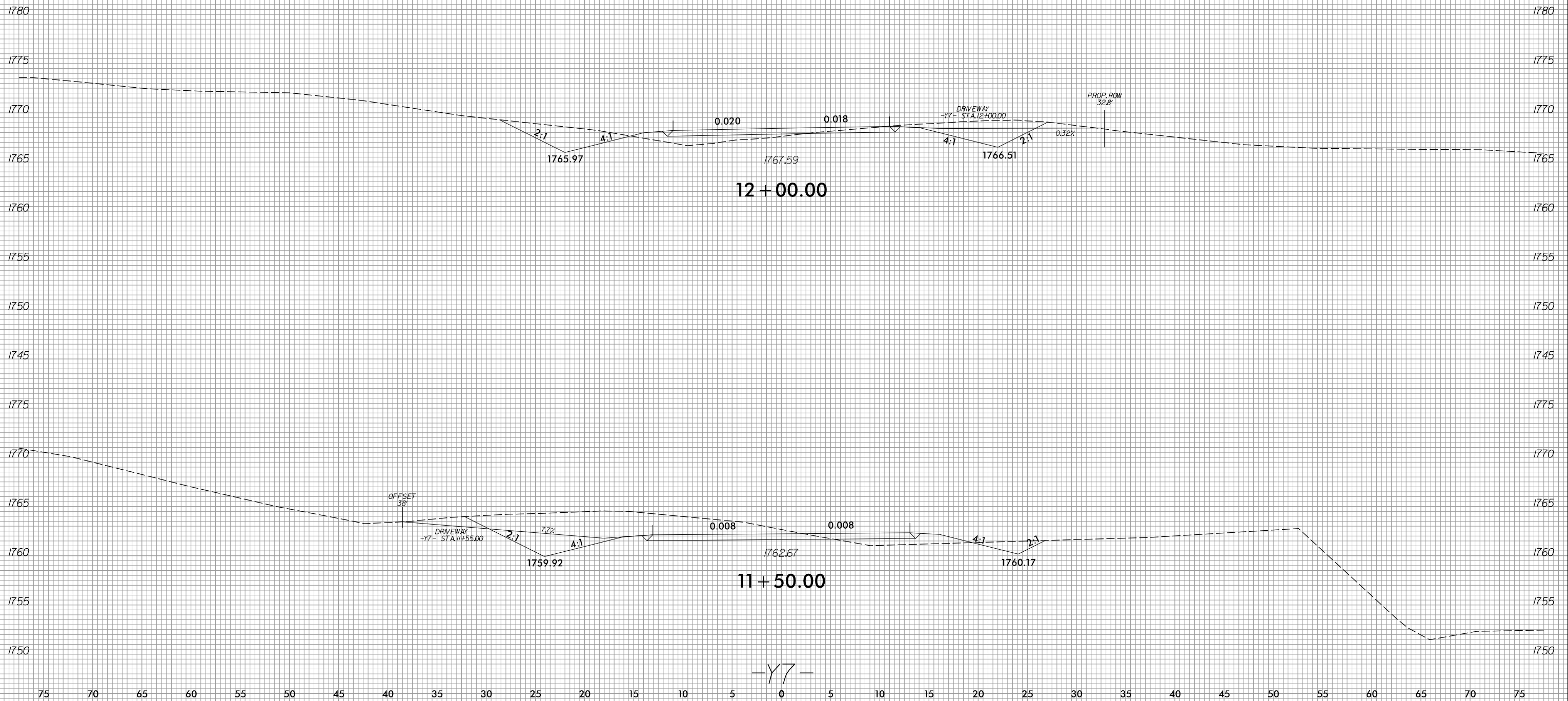

8/3/2023
 R:\Roadway\XSC\XPLs\RB861\RDy_XPL_Y7.dgn
 jinison

6/23/16

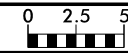

PROJ. REFERENCE NO.
R-5861

SHEET NO.
X-231

75 70 65 60 55 50 45 40 35 30 25 20 15 10 5 0 5 10 15 20 25 30 35 40 45 50 55 60 65 70 75

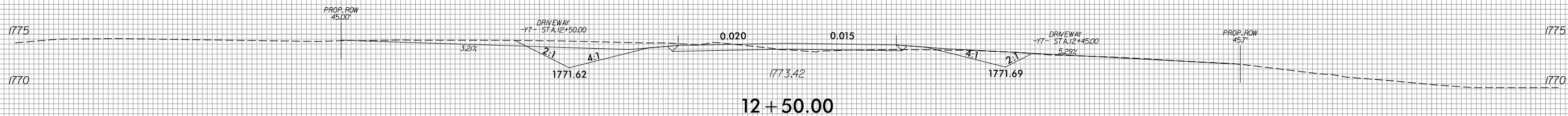
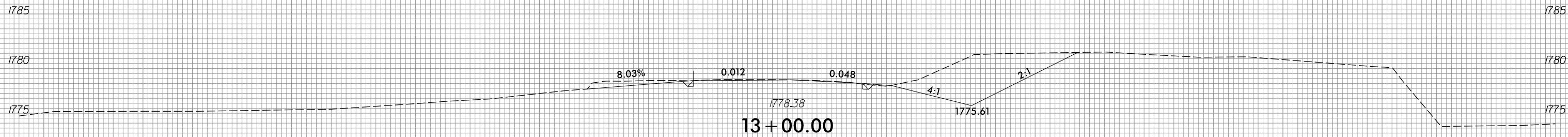

-Y7-

8/3/2023
R:\Roadway\XSC\XPLs\RB861\RDY_XPL_Y7.dgn
jlinson

75 70 65 60 55 50 45 40 35 30 25 20 15 10 5 0 5 10 15 20 25 30 35 40 45 50 55 60 65 70 75

6/23/16

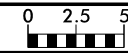

PROJ. REFERENCE NO.
R-5861

SHEET NO.
X-232

75 70 65 60 55 50 45 40 35 30 25 20 15 10 5 0 5 10 15 20 25 30 35 40 45 50 55 60 65 70 75

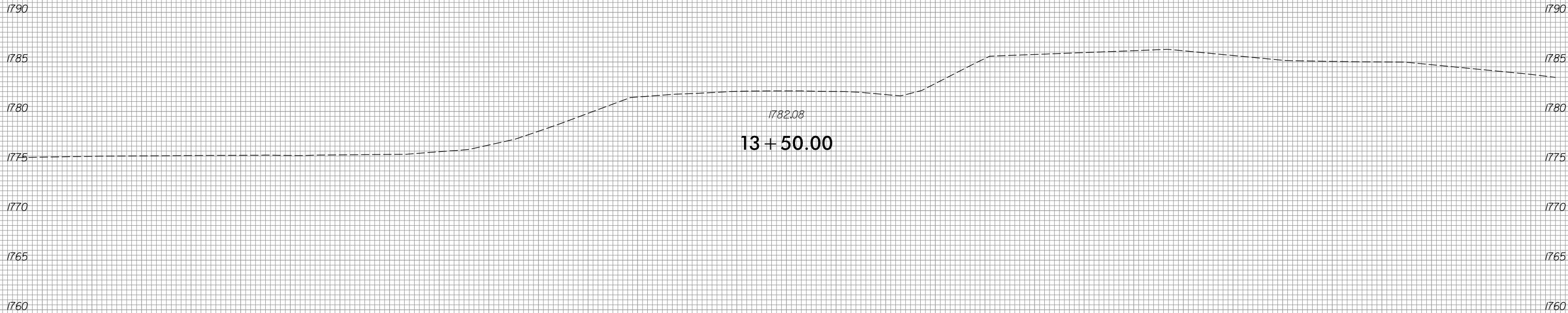

13+50.00

—Y7—

8/3/2023
 R:\Roadway\XSC\XPLs\RB861.Rdy.XPL.Y7.dgn
 jinson

6/23/16



PROJ. REFERENCE NO.	SHEET NO.
R-5861	X-233

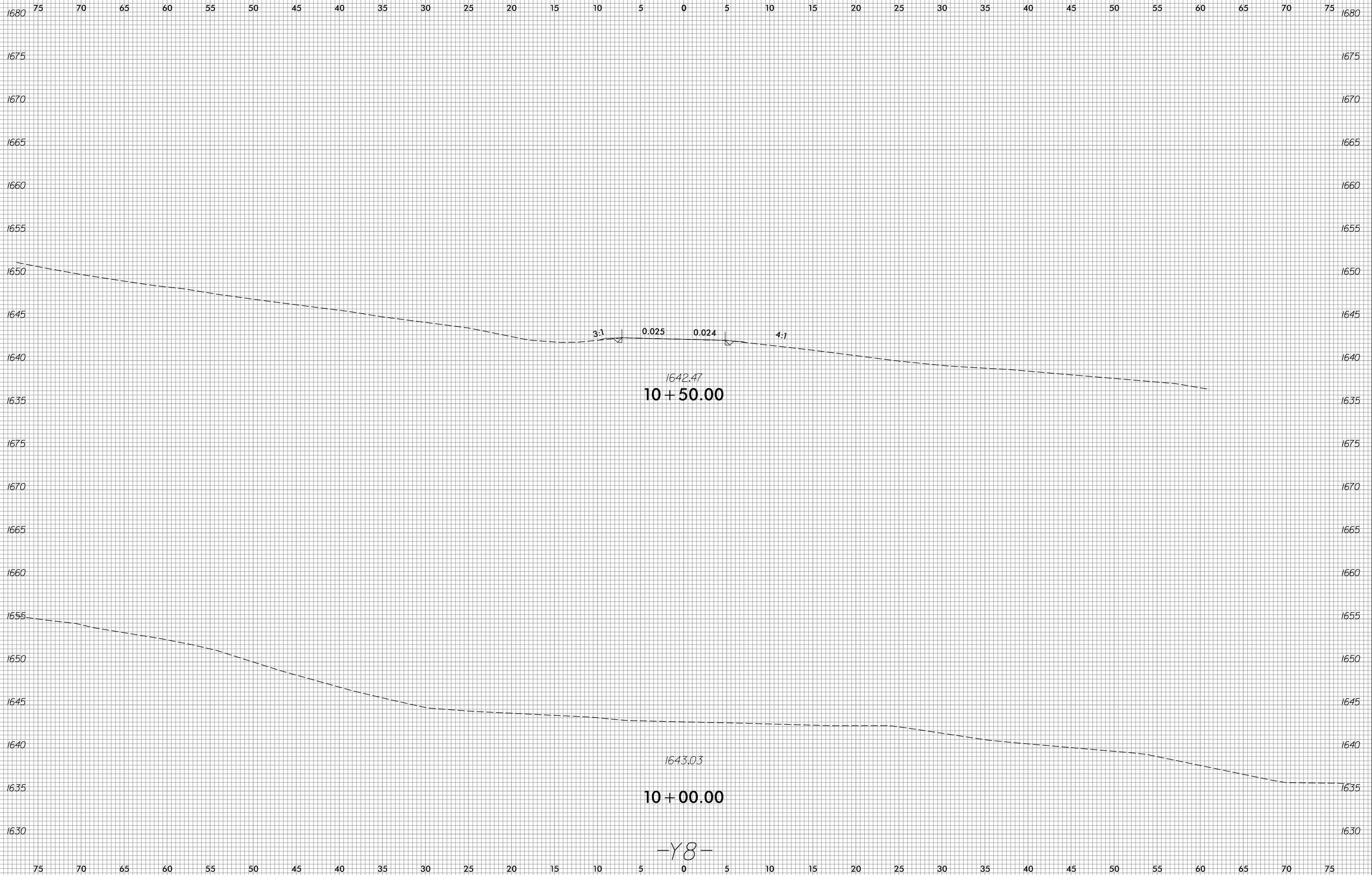

8/3/2023
R:\Roadway\XSC\XPLs\RB861\RDY_XPL_Y8.dgn
jlinson

6/23/16

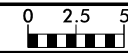

PROJ. REFERENCE NO.	SHEET NO.
R-5861	X-234

75 70 65 60 55 50 45 40 35 30 25 20 15 10 5 0 5 10 15 20 25 30 35 40 45 50 55 60 65 70 75

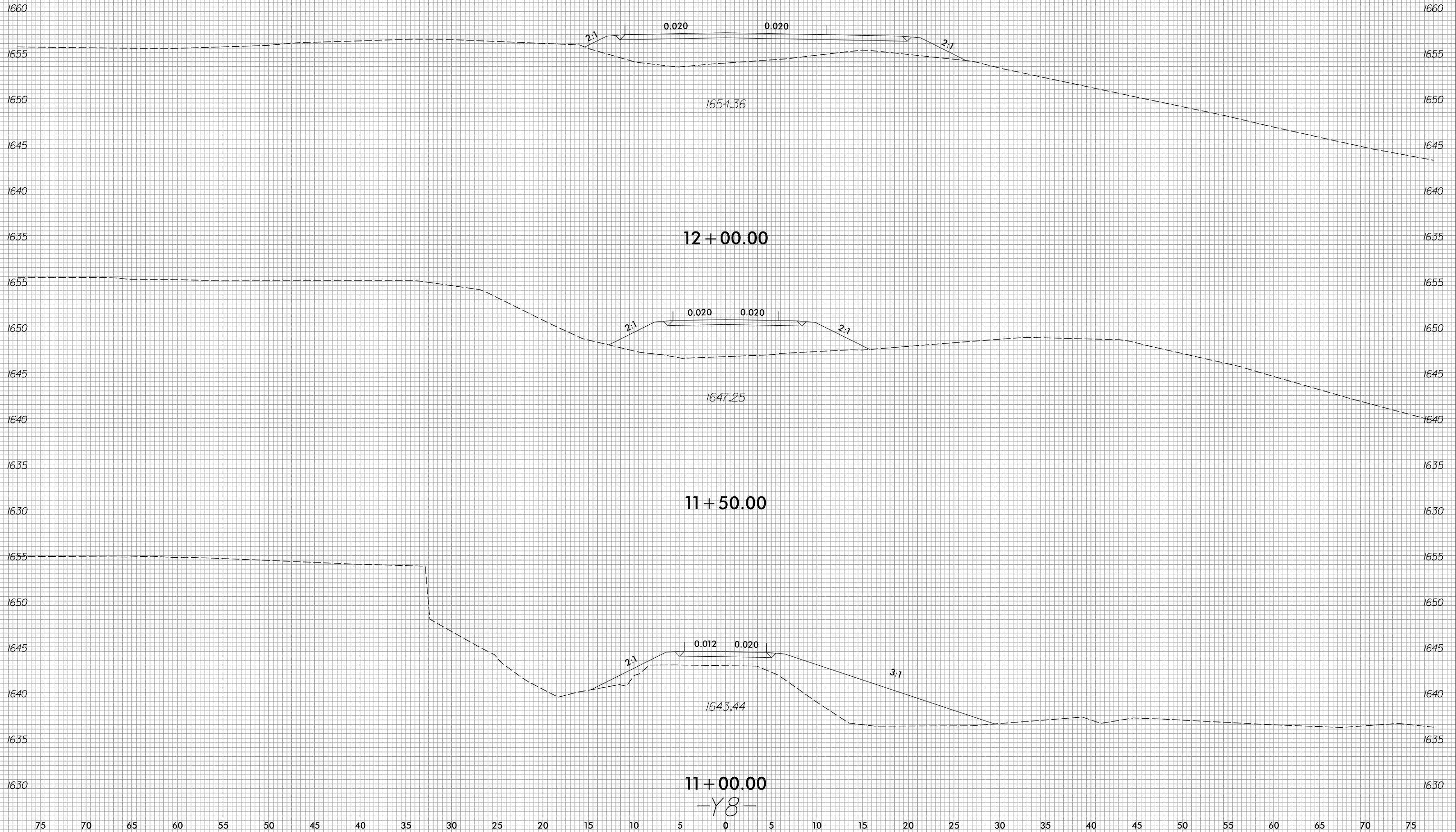

8/3/2023
 R:\Roadway\XSC\XPLs\RB861\RDy_XPL_Y8.dgn
 jinson

11 + 00.00
 -Y8-

6/23/16

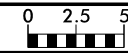

PROJ. REFERENCE NO.	SHEET NO.
R-5861	X-235

75 70 65 60 55 50 45 40 35 30 25 20 15 10 5 0 5 10 15 20 25 30 35 40 45 50 55 60 65 70 75

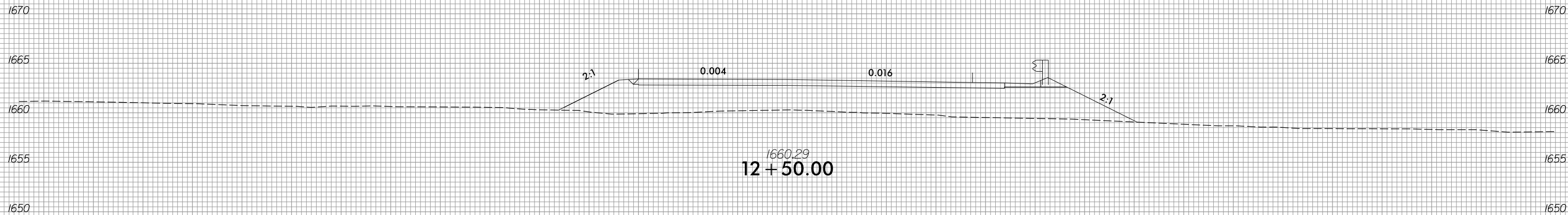

75 70 65 60 55 50 45 40 35 30 25 20 15 10 5 0 5 10 15 20 25 30 35 40 45 50 55 60 65 70 75

8/3/2023
 R:\Roadway\XSC\XPLs\RB861\RDy_XPL_Y8.dgn
 jinson

1660.29
12+50.00

-Y8-

6/23/16

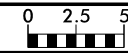

PROJ. REFERENCE NO.
R-5861

SHEET NO.
X-236

75 70 65 60 55 50 45 40 35 30 25 20 15 10 5 0 5 10 15 20 25 30 35 40 45 50 55 60 65 70 75

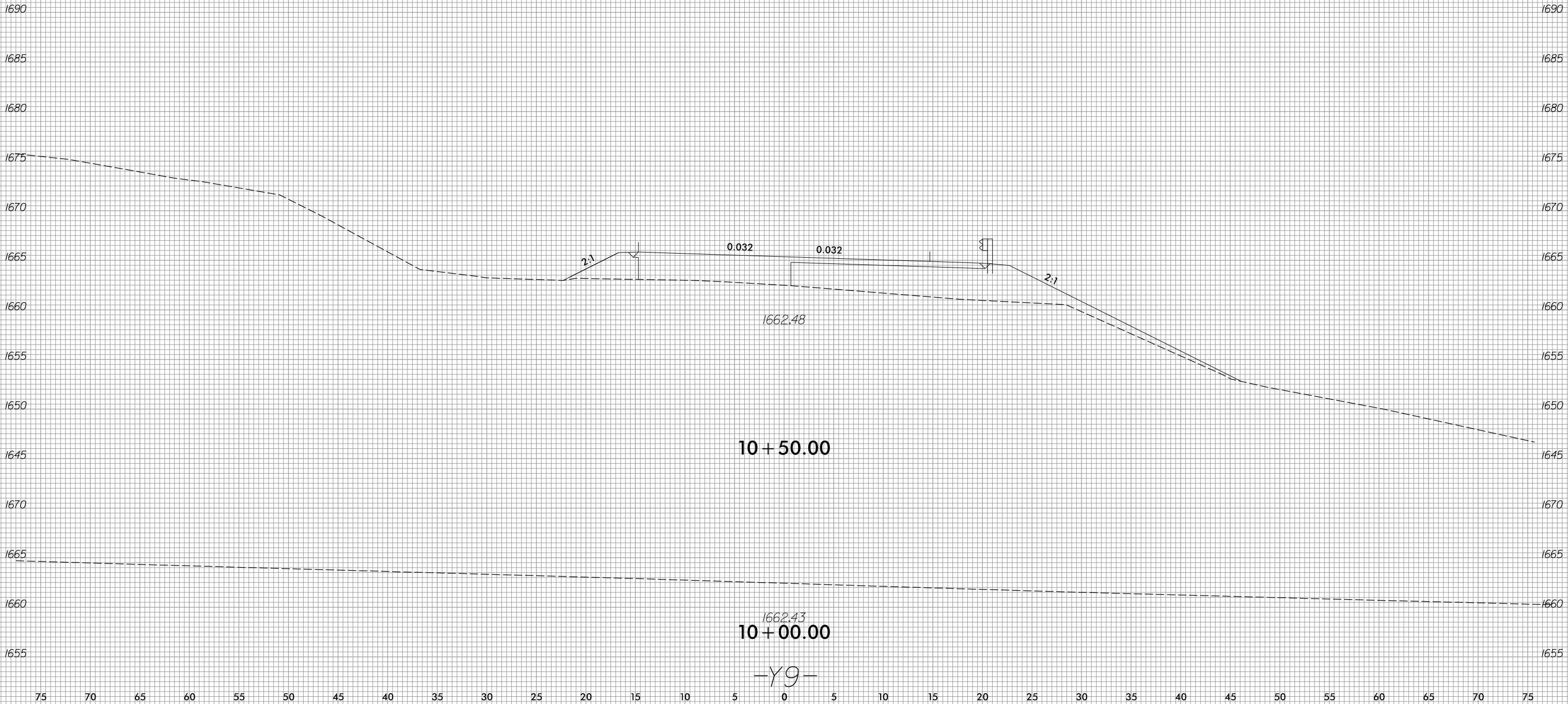

8/3/2023
R:\Roadway\XSC\XPLs\RB861.Rdy.XPL.Y9.dgn
jinson

6/23/16

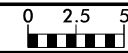

PROJ. REFERENCE NO.	SHEET NO.
R-5861	X-237

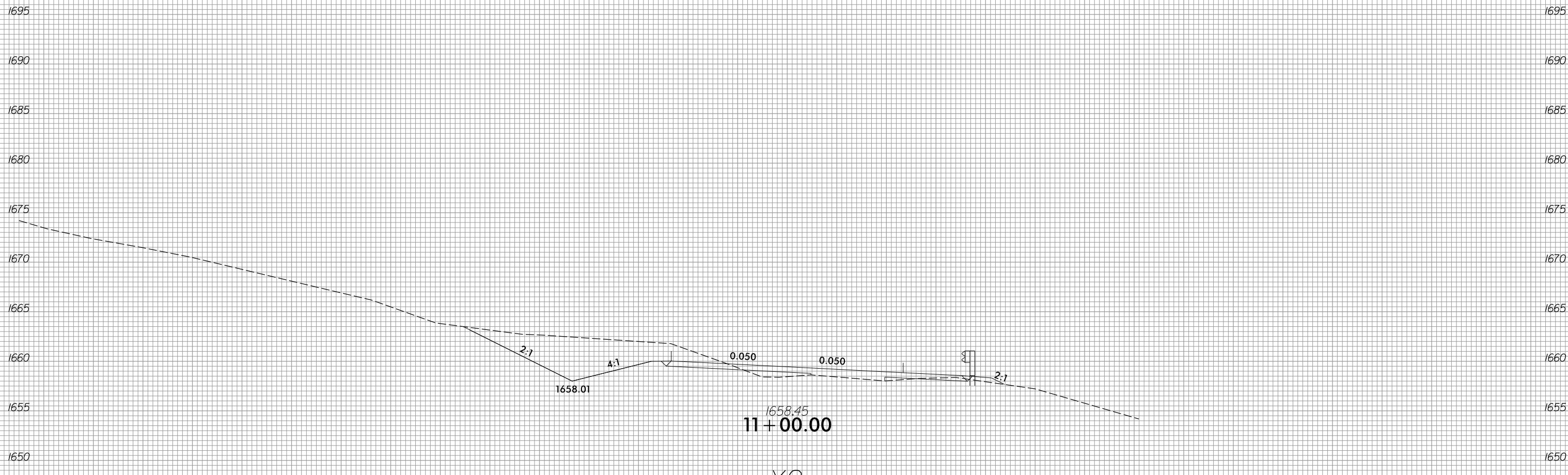
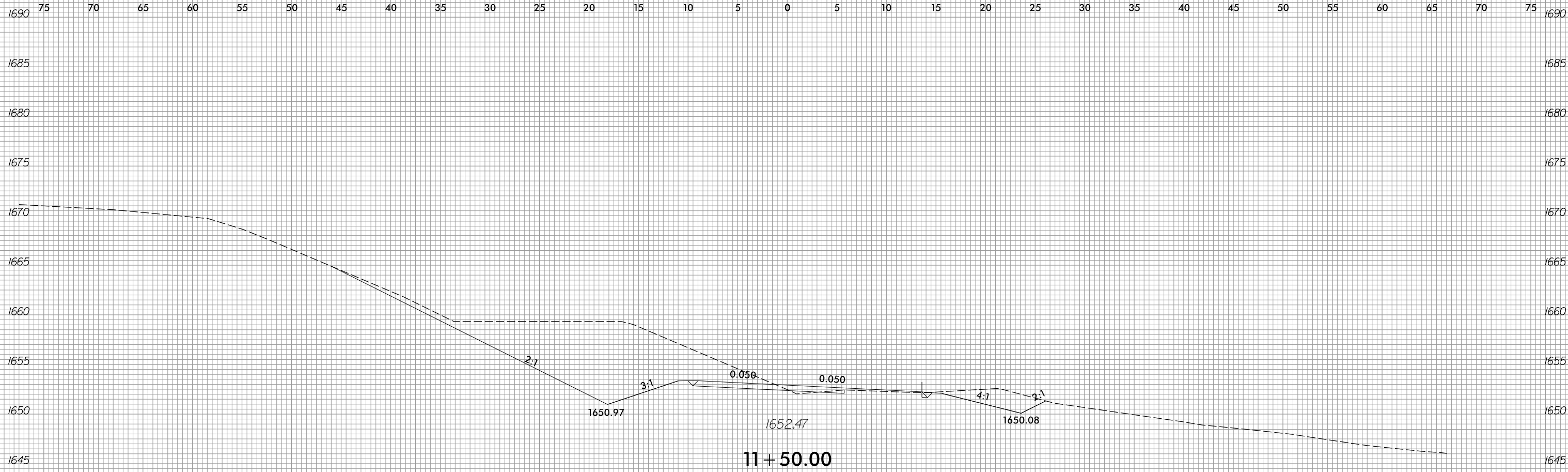

75 70 65 60 55 50 45 40 35 30 25 20 15 10 5 0 5 10 15 20 25 30 35 40 45 50 55 60 65 70 75

8/3/2023
 R:\Roadway\XSC\XPLs\RB861_Rdy_XPL_Y9.dgn
 jinson

-Y9-

6/23/16

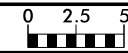

PROJ. REFERENCE NO.	SHEET NO.
R-5861	X-238

75 70 65 60 55 50 45 40 35 30 25 20 15 10 5 0 5 10 15 20 25 30 35 40 45 50 55 60 65 70 75

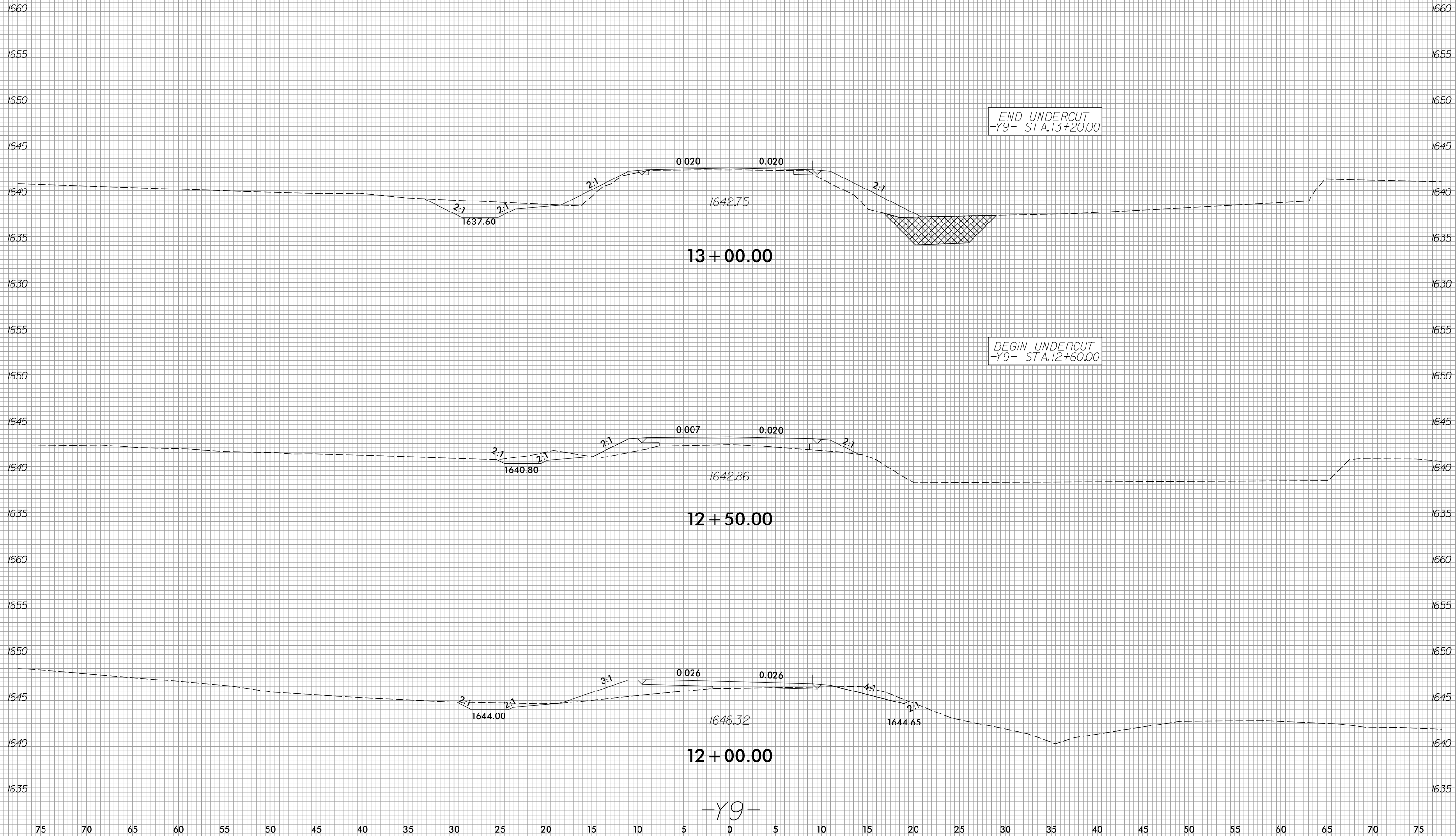

8/3/2023
 R:\Roadway\XSC\XPLs\RB861_Rdy_XPL_Y9.dgn
 jinson

6/23/16

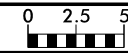

PROJ. REFERENCE NO.	SHEET NO.
R-5861	X-239

75 70 65 60 55 50 45 40 35 30 25 20 15 10 5 0 5 10 15 20 25 30 35 40 45 50 55 60 65 70 75

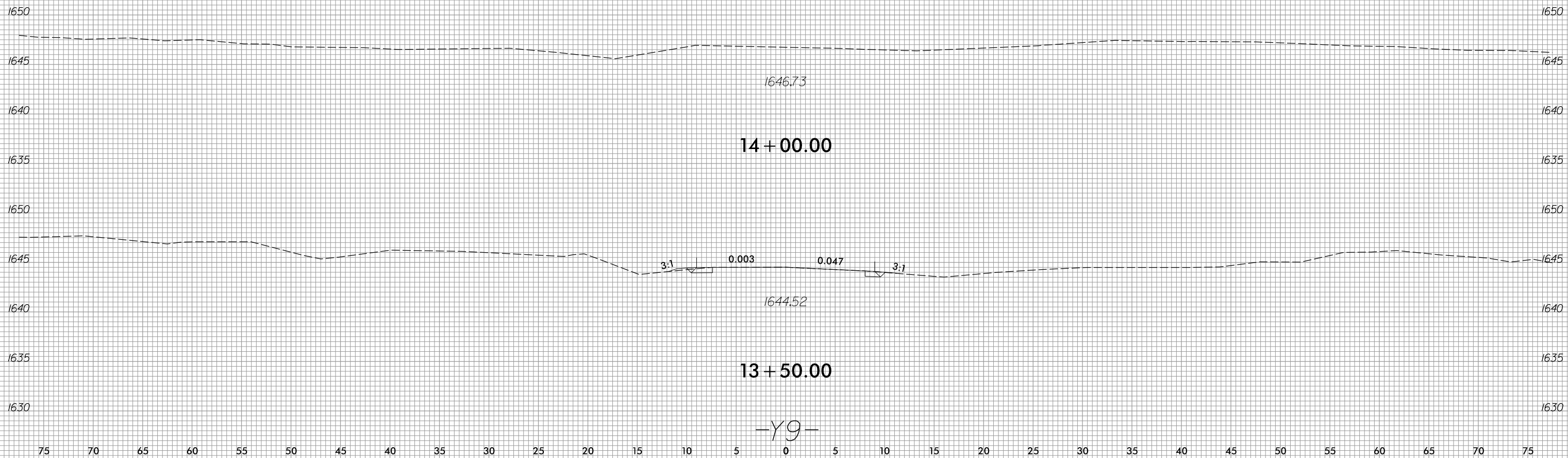

8/3/2023
 R:\Roadway\XSC\XPLs\RB861.Rdy.XPL.Y9.dgn
 jinson

6/23/16

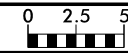

PROJ. REFERENCE NO.	SHEET NO.
R-5861	X-240

75 70 65 60 55 50 45 40 35 30 25 20 15 10 5 0 5 10 15 20 25 30 35 40 45 50 55 60 65 70 75

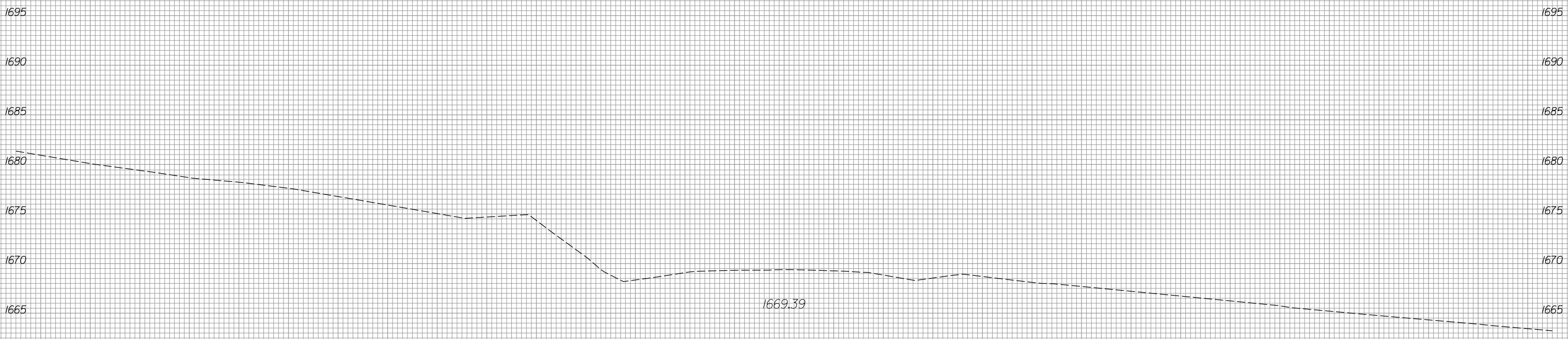

10 + 50.00

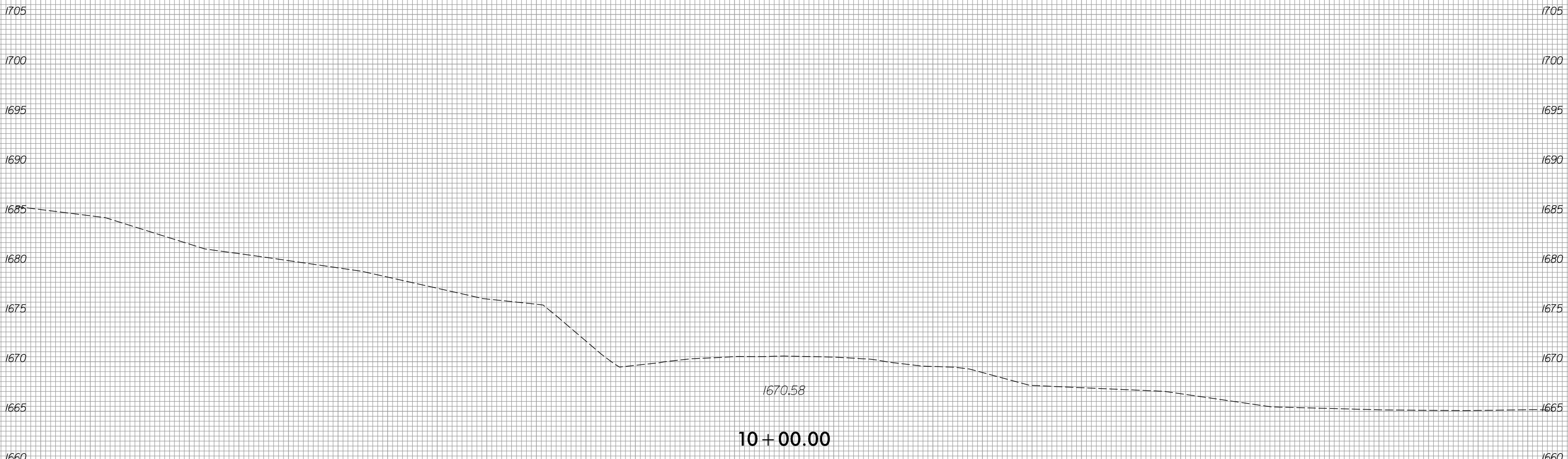

10 + 00.00

-Y10A-

75 70 65 60 55 50 45 40 35 30 25 20 15 10 5 0 5 10 15 20 25 30 35 40 45 50 55 60 65 70 75

8/3/2023
R:\Roadway\XSC\XPLs\RB861_Rdy_XPL_Y10A.dgn
jinson

6/23/16



PROJ. REFERENCE NO.	SHEET NO.
R-5861	X-241

65 60 55 50 45 40 35 30 25 20 15 10 5 0 5 10 15 20 25 30 35 40 45 50 55 60 65 70 75 80 85

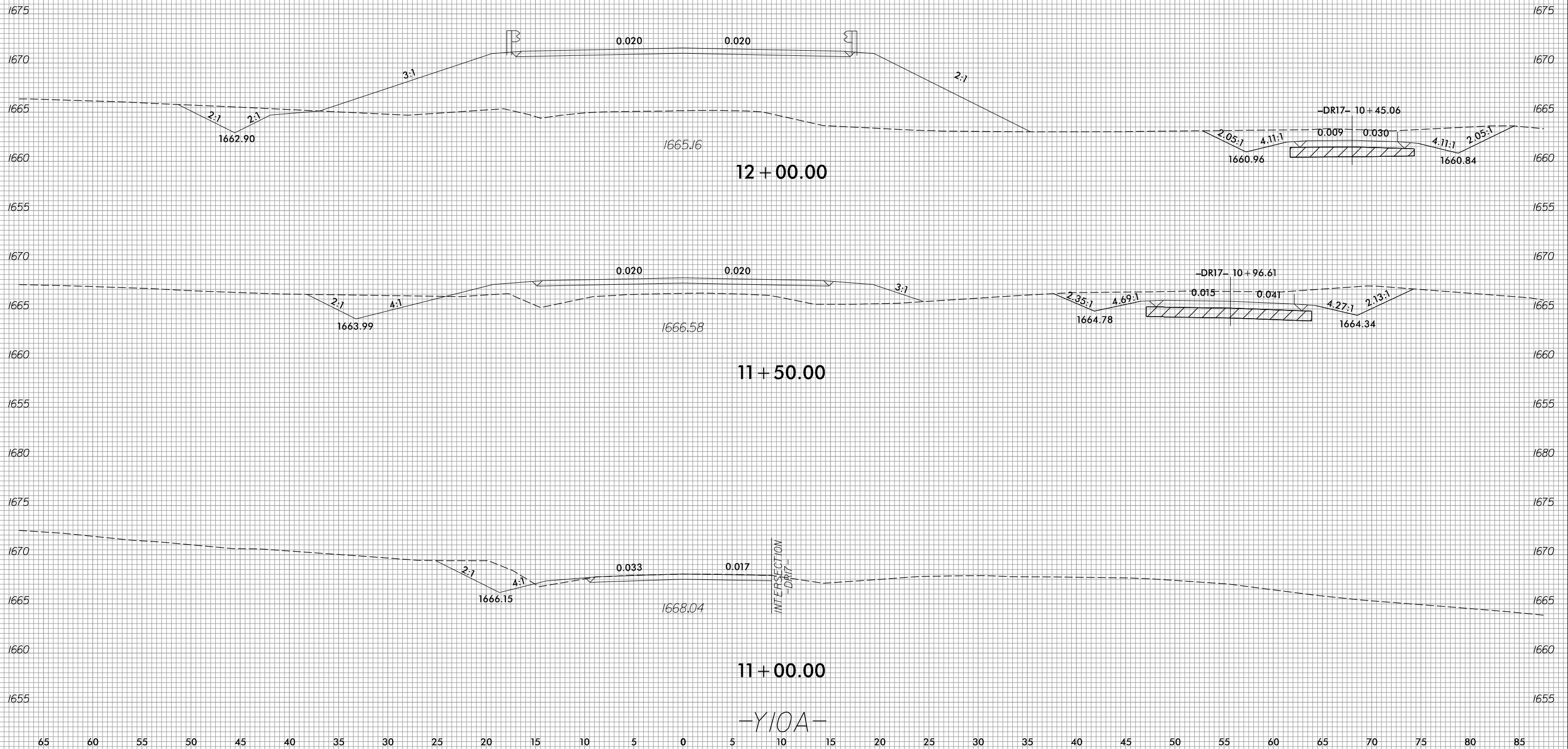

8/3/2023
R:\Roadway\XSC\XPLs\RB861.Rdy.XPL\Y10A.dgn
Jinison

6/23/16

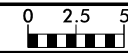

PROJ. REFERENCE NO.
R-5861

SHEET NO.
X-242

75 70 65 60 55 50 45 40 35 30 25 20 15 10 5 0 5 10 15 20 25 30 35 40 45 50 55 60 65 70 75

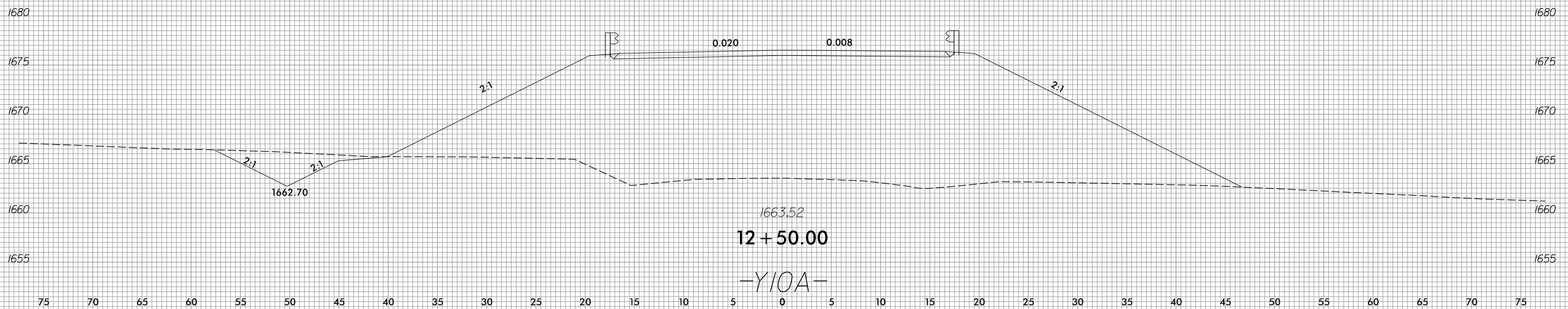

8/3/2023
R:\Roadway\XSC\XPLs\RB861_Rdy_XPL_Y10A.dgn
jlinson

75 70 65 60 55 50 45 40 35 30 25 20 15 10 5 0 5 10 15 20 25 30 35 40 45 50 55 60 65 70 75

6/23/16

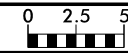

PROJ. REFERENCE NO.
R-5861

SHEET NO.
X-243

75 70 65 60 55 50 45 40 35 30 25 20 15 10 5 0 5 10 15 20 25 30 35 40 45 50 55 60 65 70 75

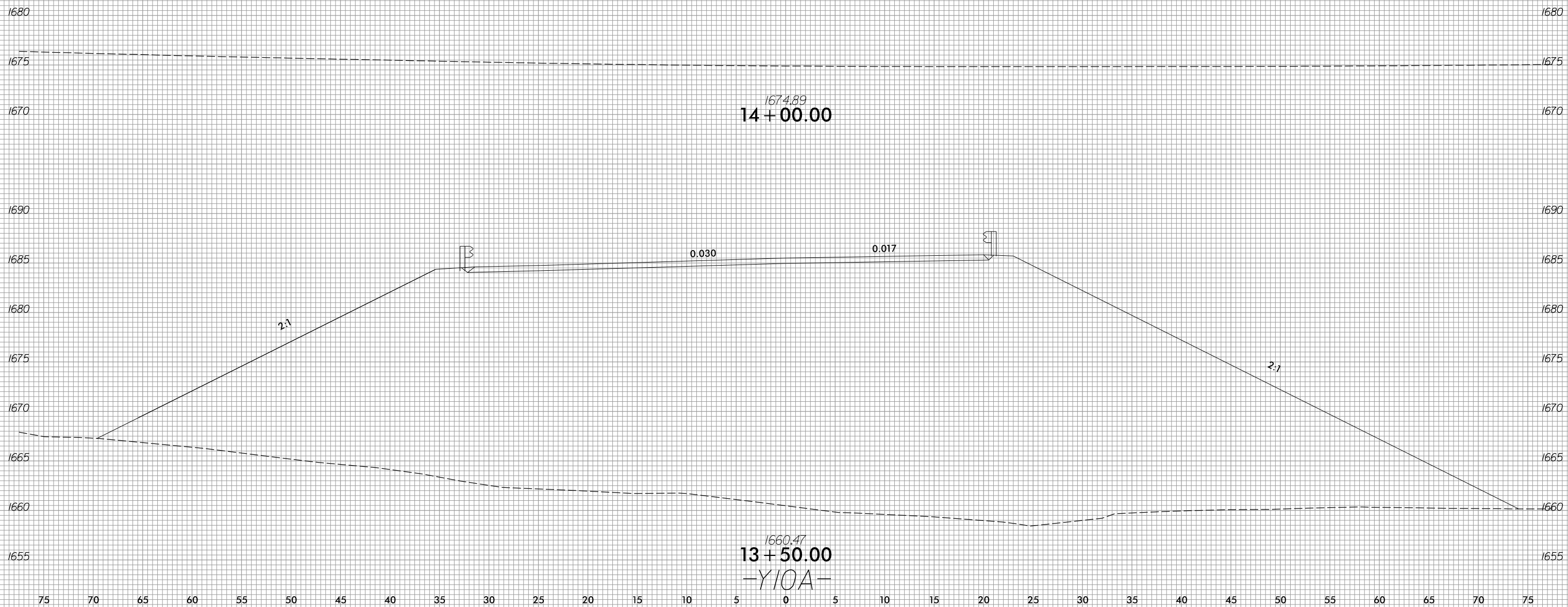

8/3/2023
R:\Roadway\XSC\XPLs\RB861_Rdy_XPL_Y10A.dgn
jlinson

6/23/16



PROJ. REFERENCE NO.	SHEET NO.
R-5861	X-244

150 140 130 120 110 100 90 80 70 60 50 40 30 20 10 0 10 20 30 40 50 60 70 80 90 100 110 120 130 140 150

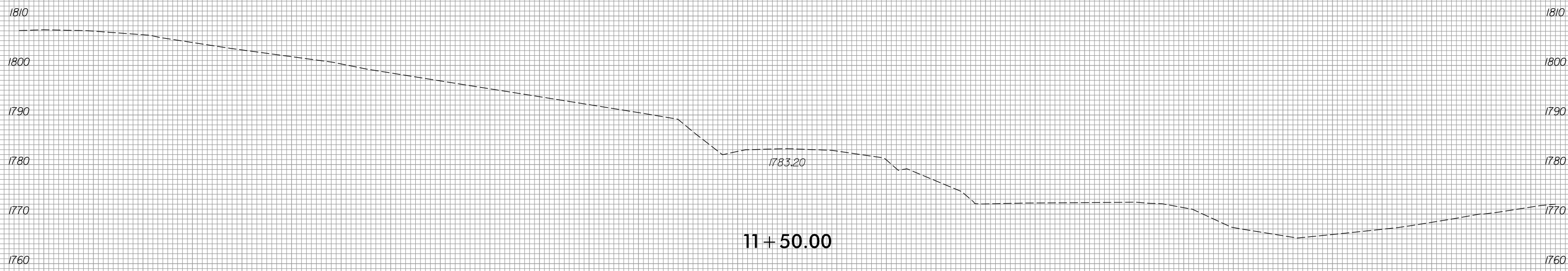
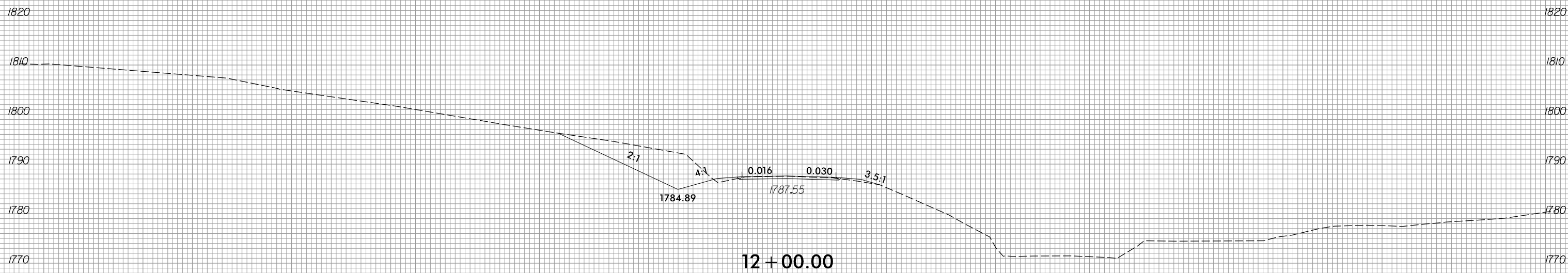
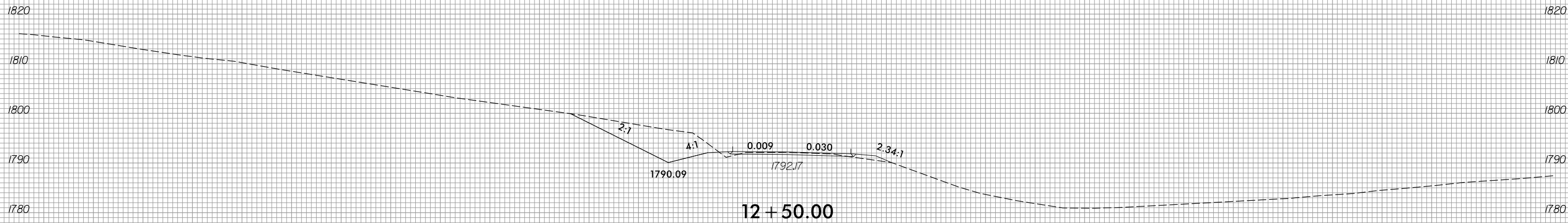

150 140 130 120 110 100 90 80 70 60 50 40 30 20 10 0 10 20 30 40 50 60 70 80 90 100 110 120 130 140 150

8/3/2023
 R:\Roadway\XSC\XPLs\RB661.Rdy.XPL_Y10B.dgn
 jinison

-Y10B-

6/23/16



PROJ. REFERENCE NO.	SHEET NO.
R-5861	X-245

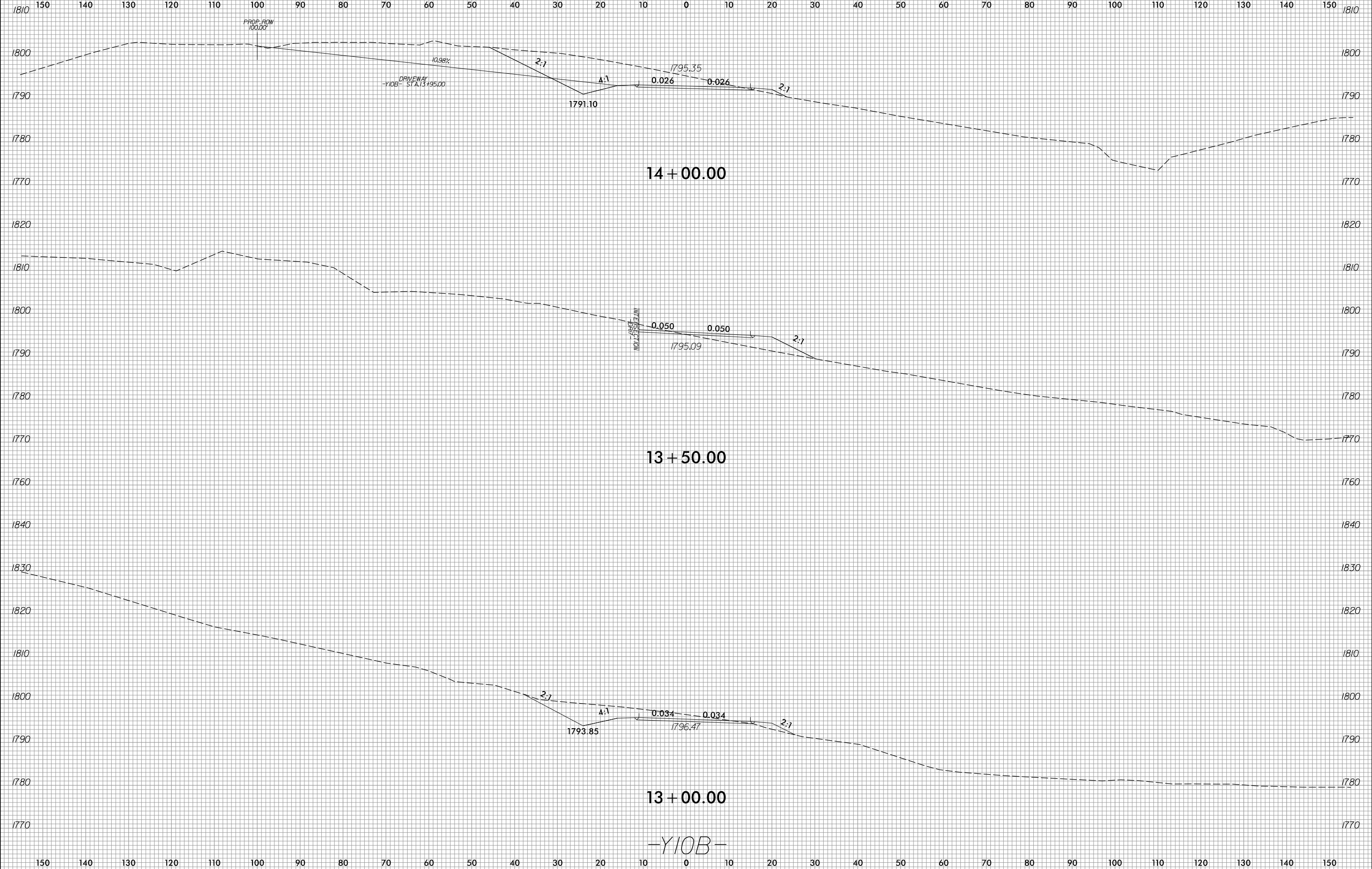

8/3/2023
R:\Roadway\XSC\XPLs\RB661\RDy_XPL_Y10B.dgn
Jinison

6/23/16



PROJ. REFERENCE NO.	SHEET NO.
R-5861	X-246

150 140 130 120 110 100 90 80 70 60 50 40 30 20 10 0 10 20 30 40 50 60 70 80 90 100 110 120 130 140 150

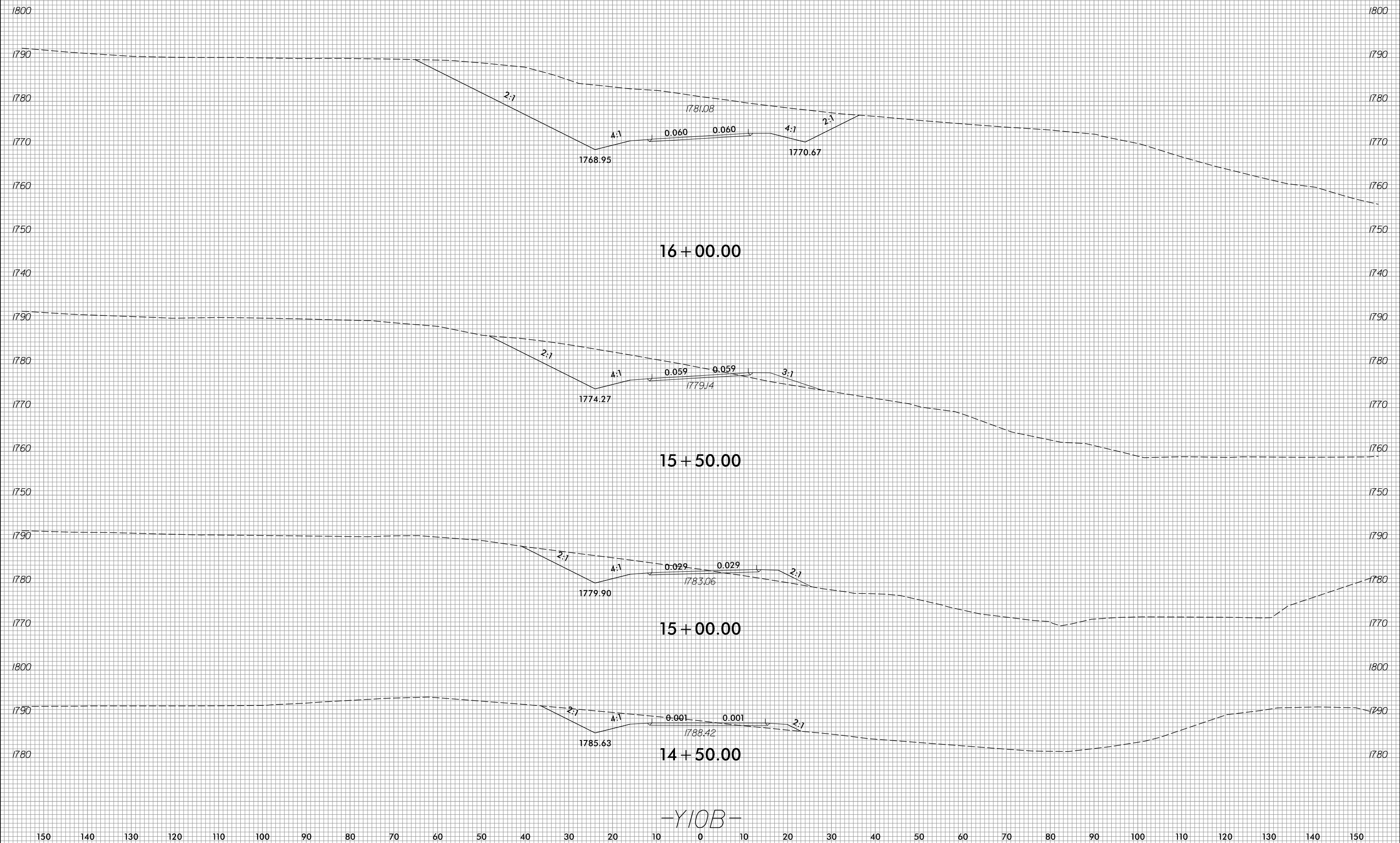

-Y10B-

8/3/2023
R:\Roadway\XSC\XPLs\RB661_Rdy_XPL_Y10B.dgn
jlinson

6/23/16



PROJ. REFERENCE NO.	SHEET NO.
R-5861	X-247

150 140 130 120 110 100 90 80 70 60 50 40 30 20 10 0 10 20 30 40 50 60 70 80 90 100 110 120 130 140 150

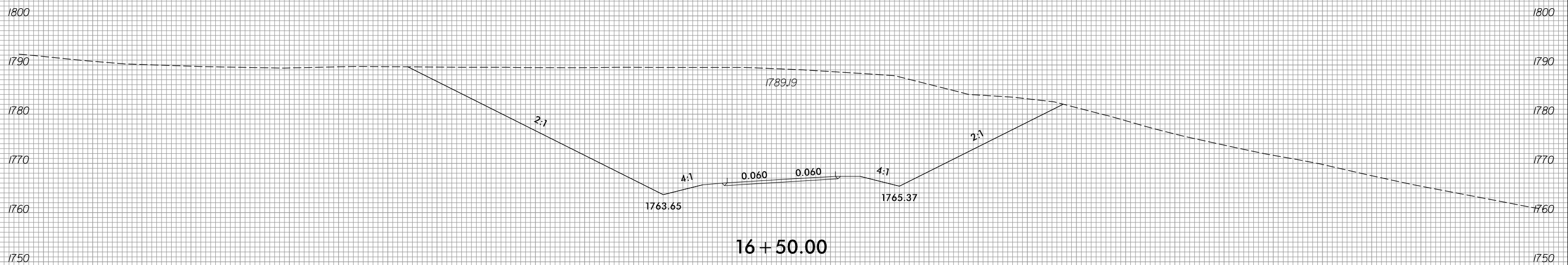
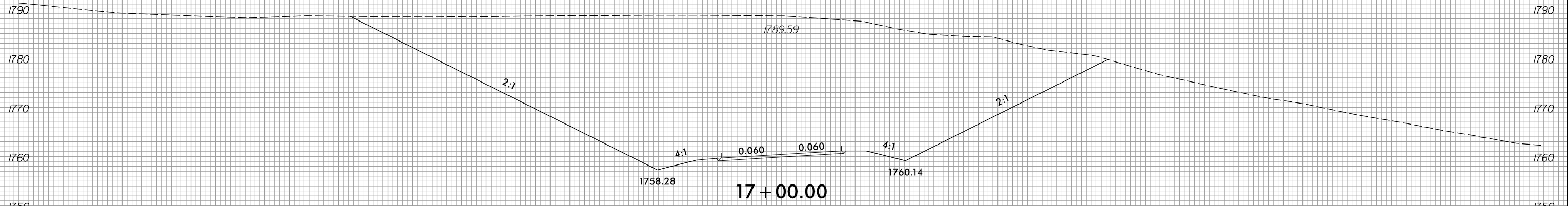
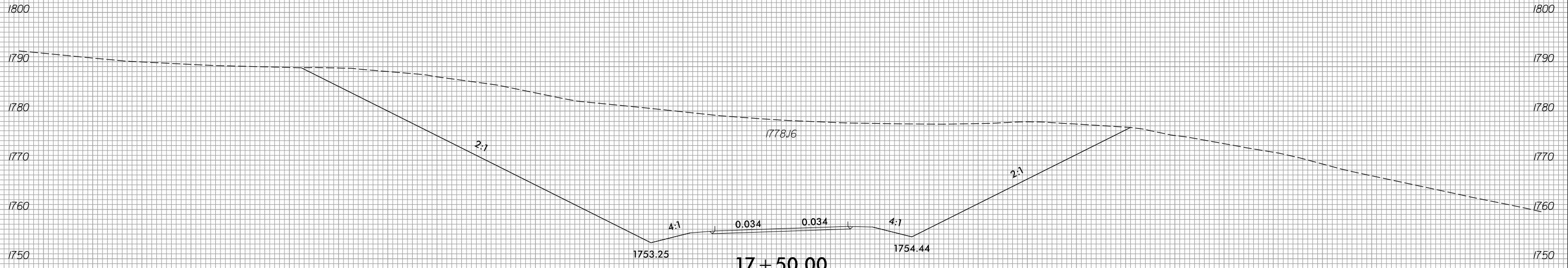

150 140 130 120 110 100 90 80 70 60 50 40 30 20 10 0 10 20 30 40 50 60 70 80 90 100 110 120 130 140 150

1750 1760 1770 1780 1790 1800

17+50.00

17+00.00

16+50.00

-Y10B-

8/3/2023
 R:\Roadway\XSC\XPLs\RB861_Rdy_XPL_Y10B.dgn
 jinson

6/23/16



PROJ. REFERENCE NO.	SHEET NO.
R-5861	X-248

150 140 130 120 110 100 90 80 70 60 50 40 30 20 10 0 10 20 30 40 50 60 70 80 90 100 110 120 130 140 150

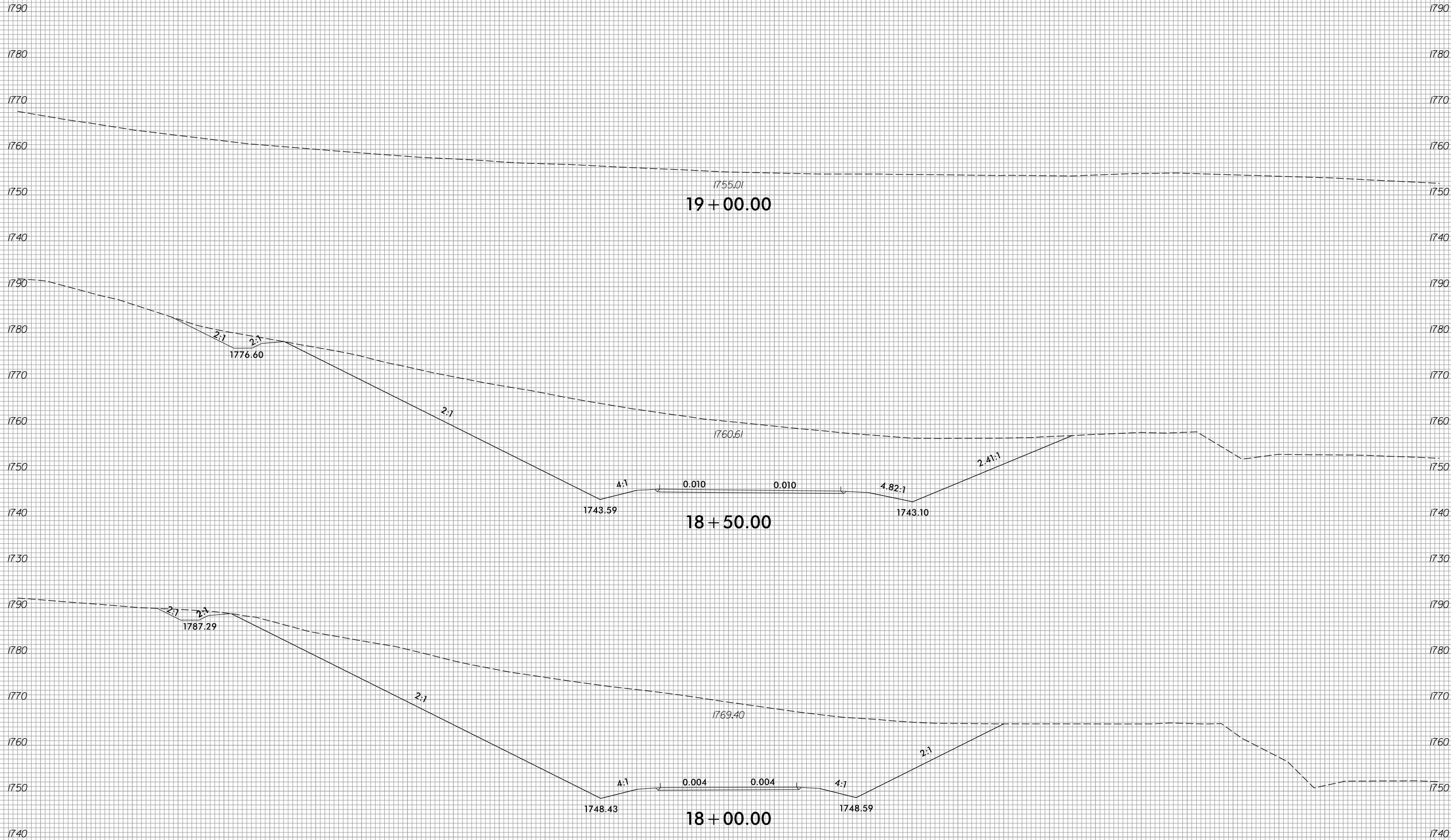

-Y10B-

8/3/2023
R:\Roadway\XSC\XPLs\RB661\RDy_XPL_Y10B.dgn
jinson

6/23/16



PROJ. REFERENCE NO.	SHEET NO.
R-5861	X-249

150 140 130 120 110 100 90 80 70 60 50 40 30 20 10 0 10 20 30 40 50 60 70 80 90 100 110 120 130 140 150

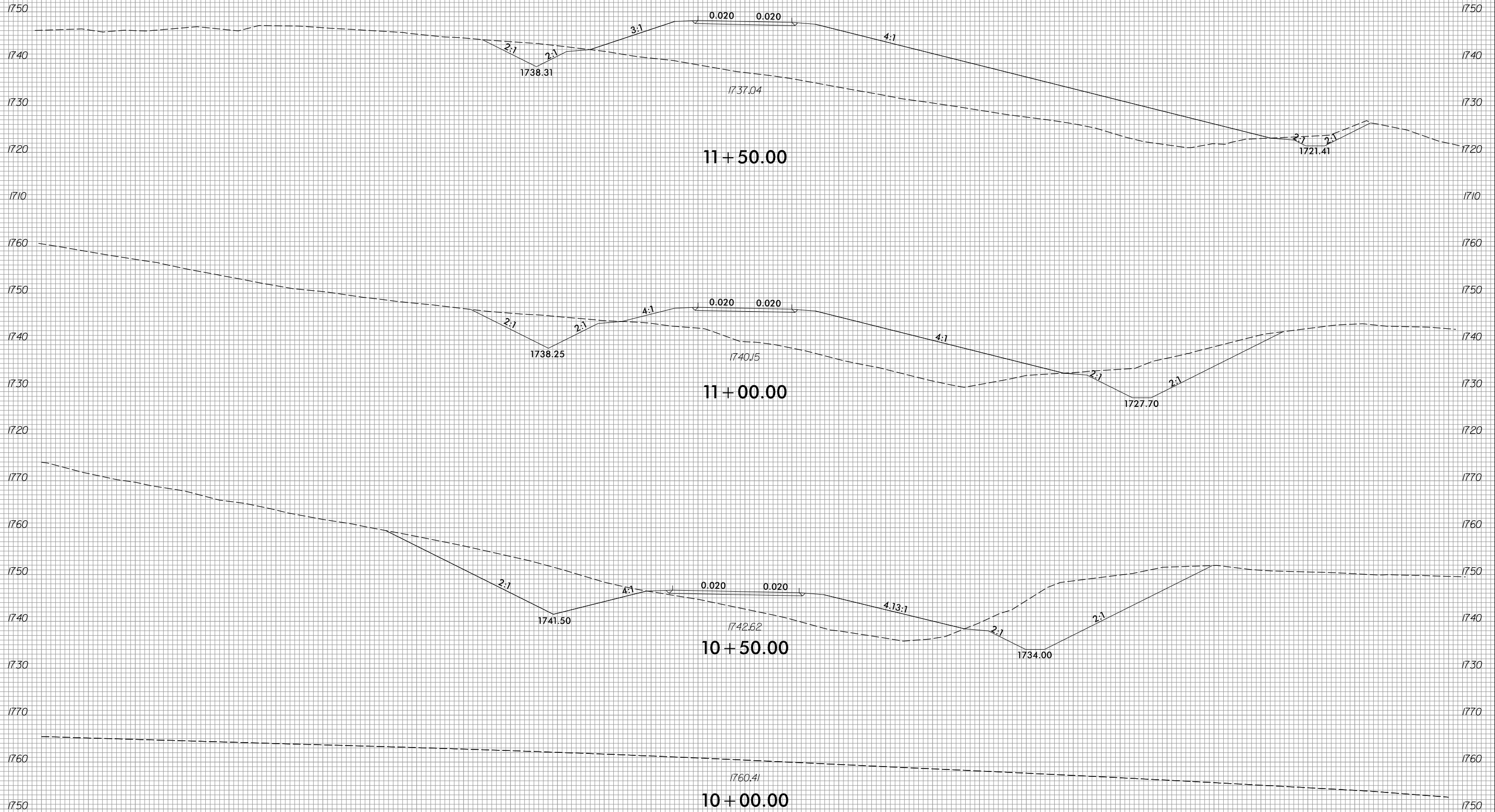

150 140 130 120 110 100 90 80 70 60 50 40 30 20 10 0 10 20 30 40 50 60 70 80 90 100 110 120 130 140 150

8/3/2023
 R:\Roadway\XSC\XPLs\RB861.Rdy.XPL_Y11.dgn
 jinson



150 140 130 120 110 100 90 80 70 60 50 40 30 20 10 0 10 20 30 40 50 60 70 80 90 100 110 120 130 140 150

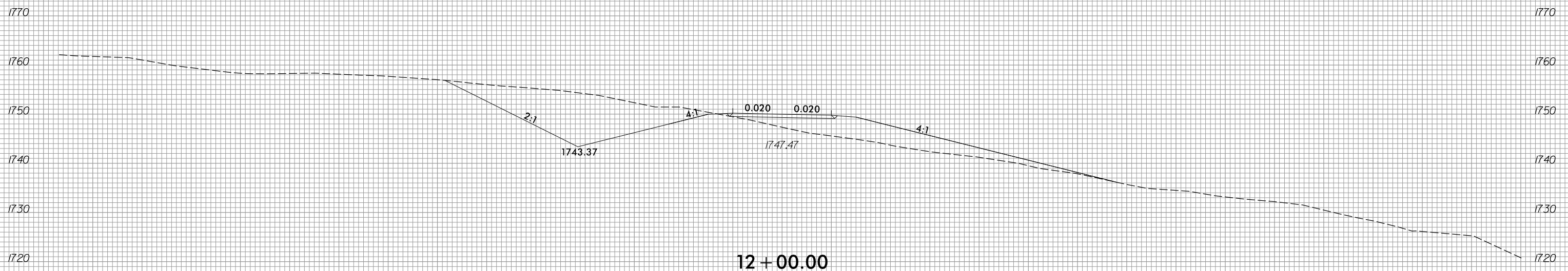
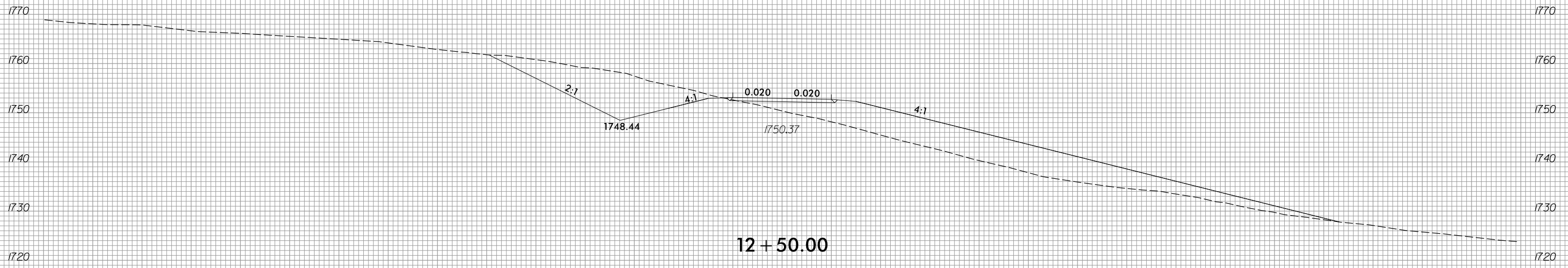

-Y///-

150 140 130 120 110 100 90 80 70 60 50 40 30 20 10 0 10 20 30 40 50 60 70 80 90 100 110 120 130 140 150

6/23/16



PROJ. REFERENCE NO.	SHEET NO.
R-5861	X-251

150 140 130 120 110 100 90 80 70 60 50 40 30 20 10 0 10 20 30 40 50 60 70 80 90 100 110 120 130 140 150

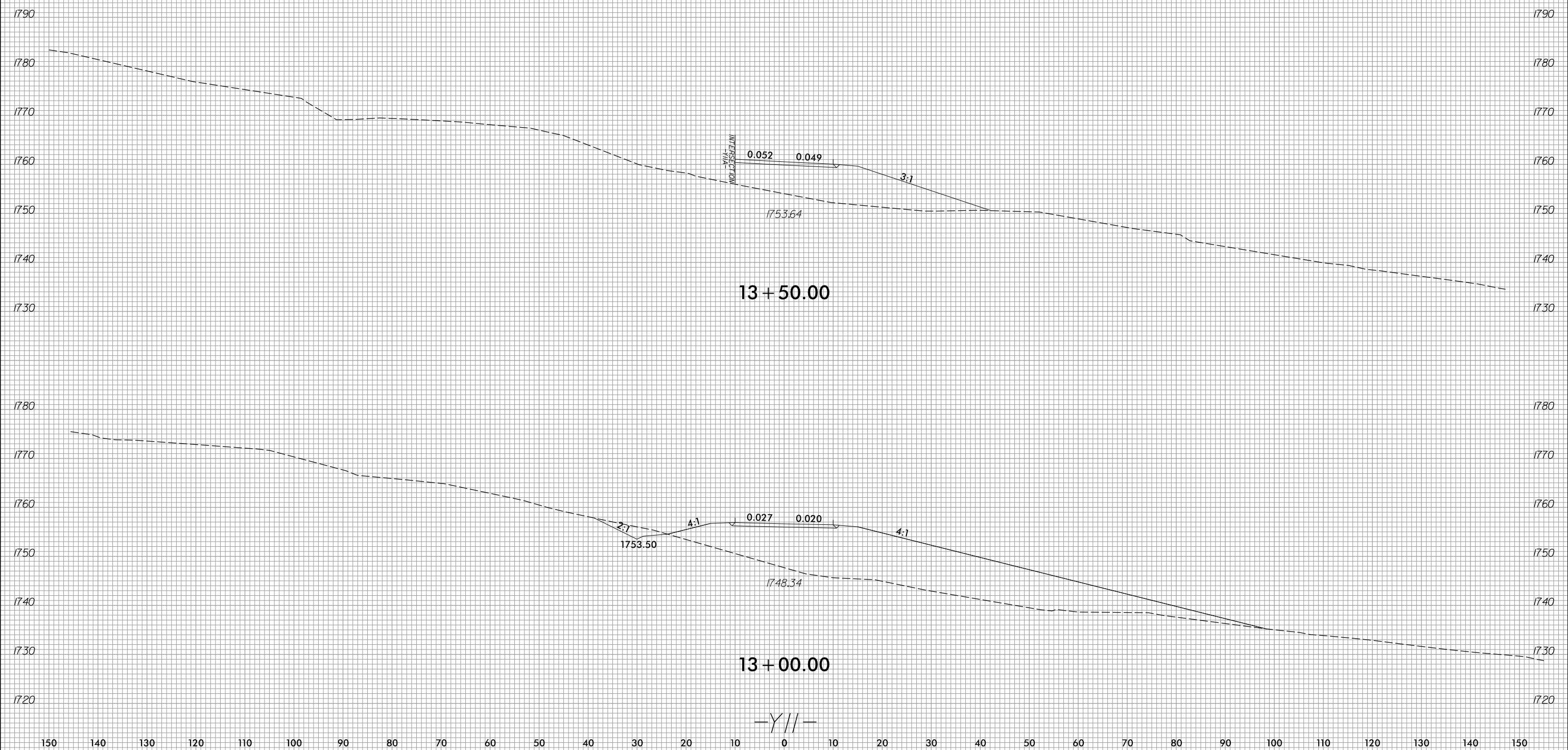

8/3/2023
 R:\Roadway\XSC\XPLs\RB861.Rdy.XPL_Y11.dgn
 jinson

6/23/16



PROJ. REFERENCE NO.	SHEET NO.
R-5861	X-252

150 140 130 120 110 100 90 80 70 60 50 40 30 20 10 0 10 20 30 40 50 60 70 80 90 100 110 120 130 140 150

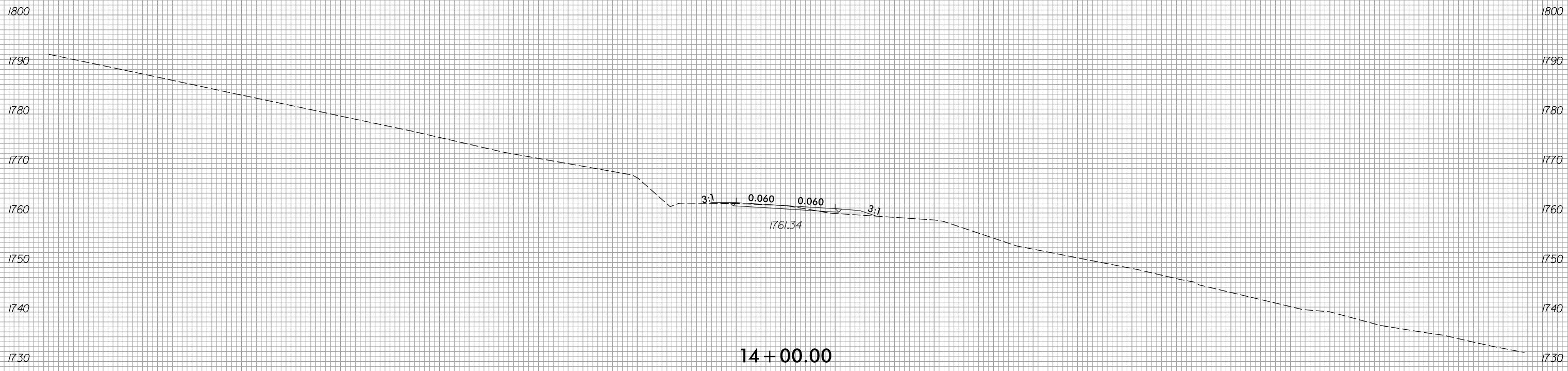

-Y//-

8/3/2023
R:\Roadway\XSC\XPLs\RB861.Rdy.XPL.Y11.dgn
jlinson

150 140 130 120 110 100 90 80 70 60 50 40 30 20 10 0 10 20 30 40 50 60 70 80 90 100 110 120 130 140 150

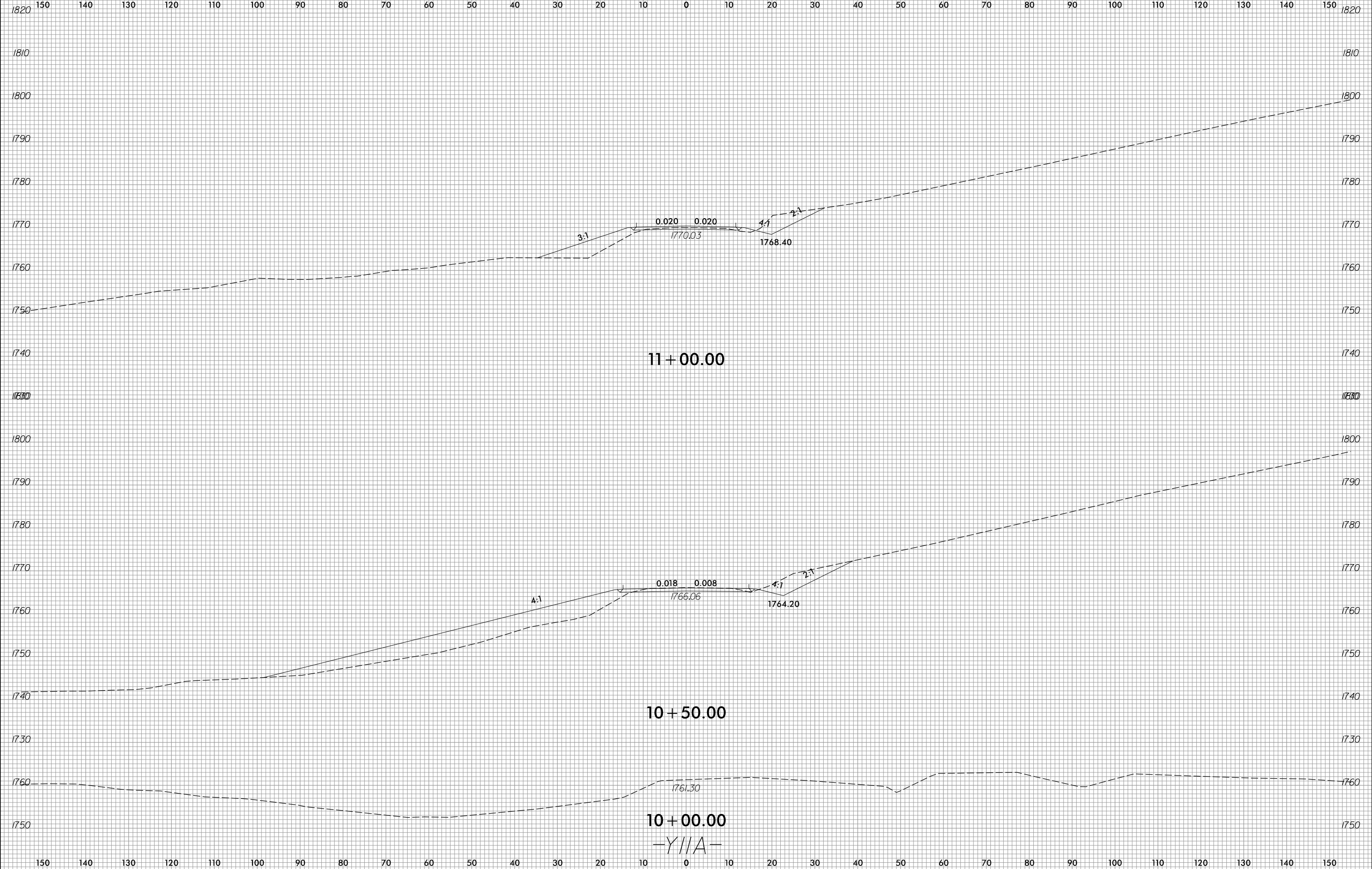



150 140 130 120 110 100 90 80 70 60 50 40 30 20 10 0 10 20 30 40 50 60 70 80 90 100 110 120 130 140 150

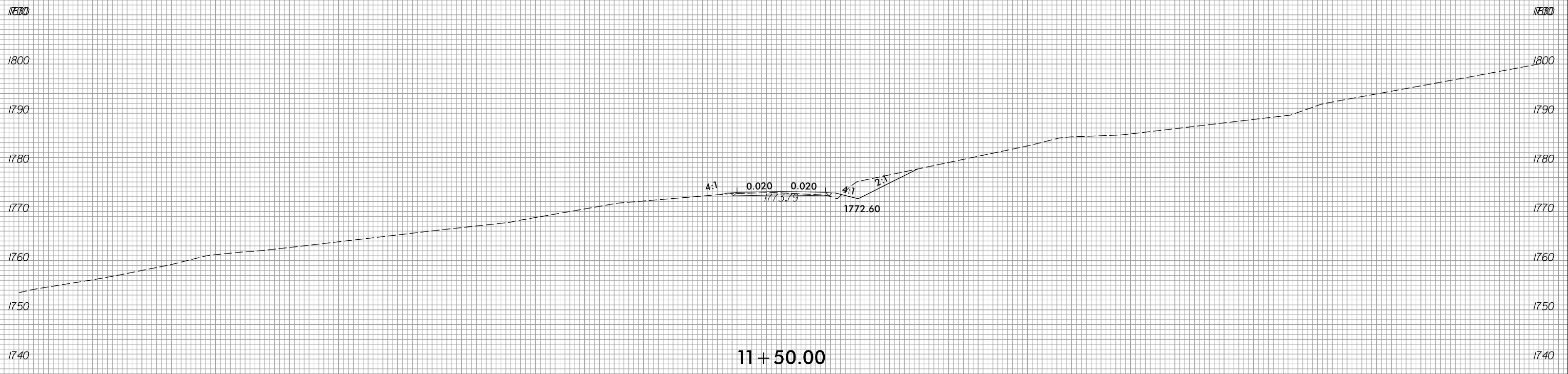
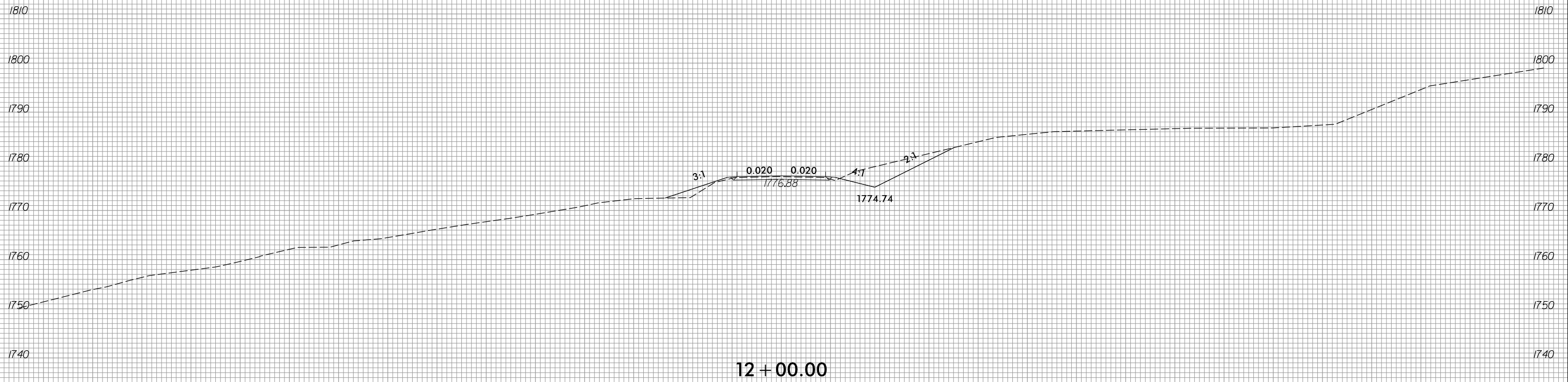

150 140 130 120 110 100 90 80 70 60 50 40 30 20 10 0 10 20 30 40 50 60 70 80 90 100 110 120 130 140 150

-Y11A-

6/23/16



PROJ. REFERENCE NO.	SHEET NO.
R-5861	X-255

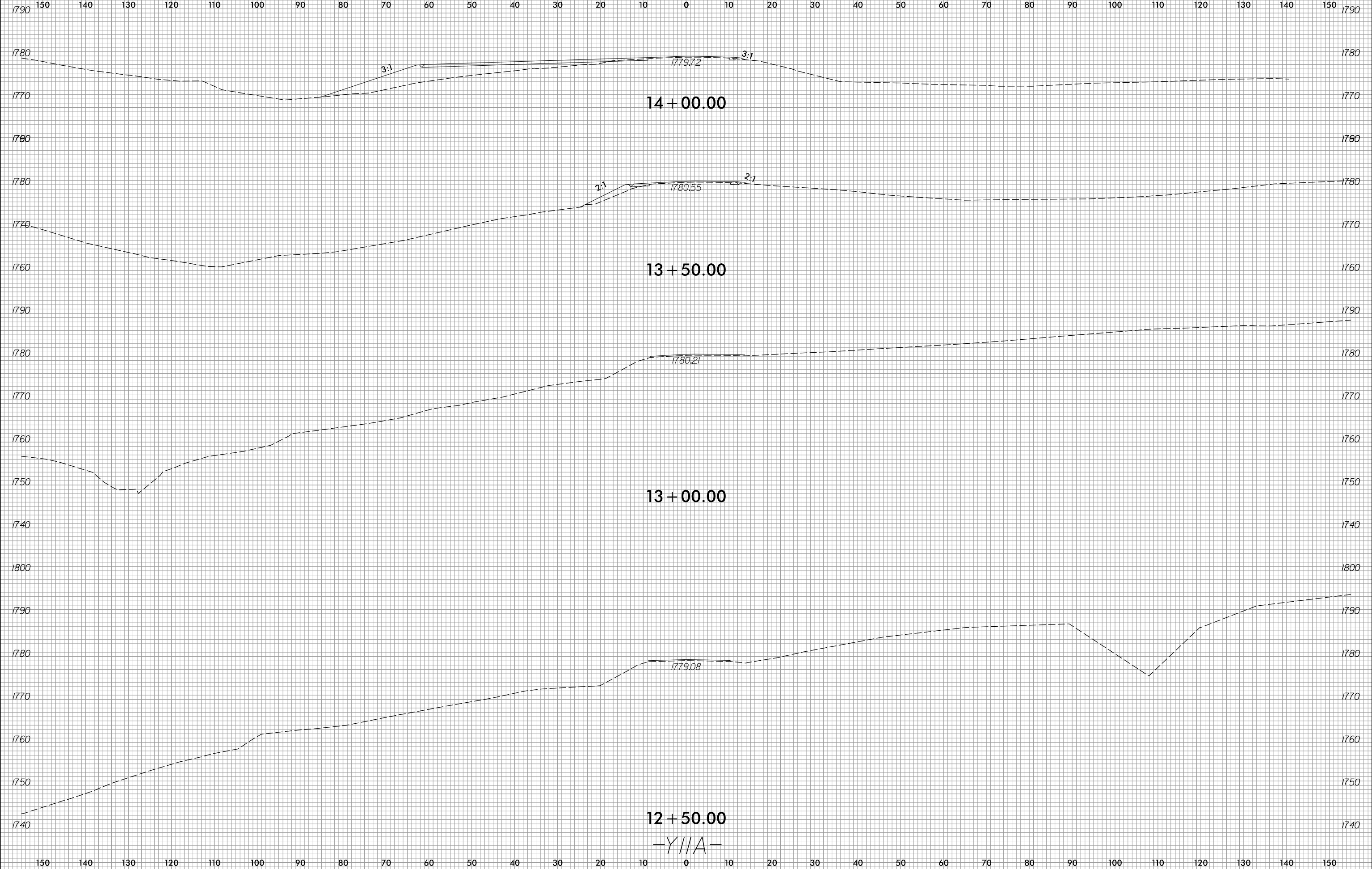

8/3/2023
R:\Roadway\XSC\XPLs\RB861\RDY_XPL_Y11A.dgn
jlinson

-Y//A-

6/23/16



PROJ. REFERENCE NO.	SHEET NO.
R-5861	X-256

150 140 130 120 110 100 90 80 70 60 50 40 30 20 10 0 10 20 30 40 50 60 70 80 90 100 110 120 130 140 150

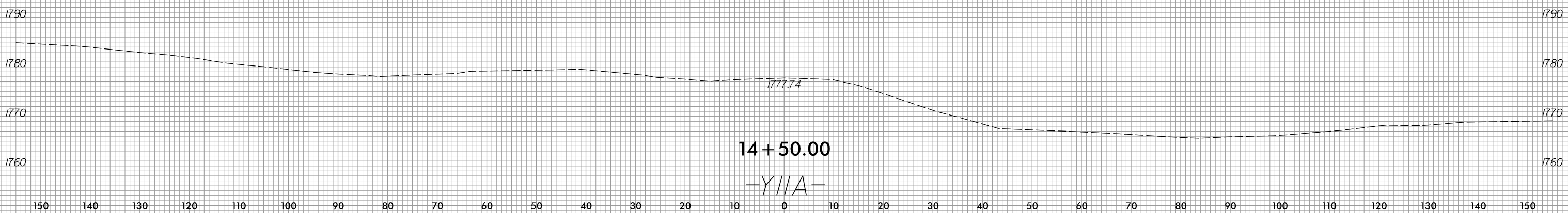

8/3/2023
 R:\Roadway\XSC\XPLs\RB861.Rdy.XPL.Y11A.dgn
 jlinson



150 140 130 120 110 100 90 80 70 60 50 40 30 20 10 0 10 20 30 40 50 60 70 80 90 100 110 120 130 140 150

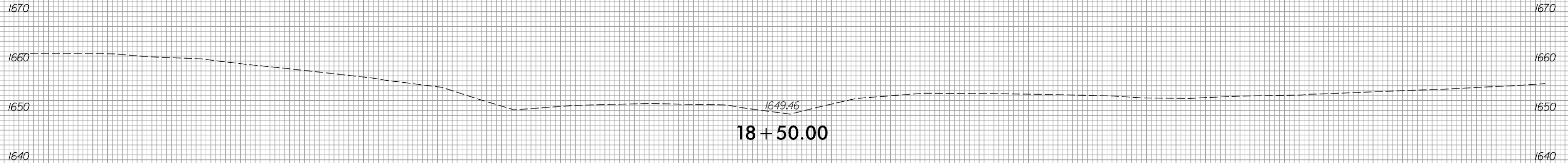
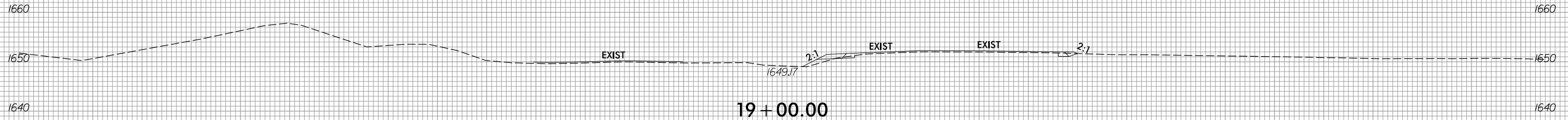
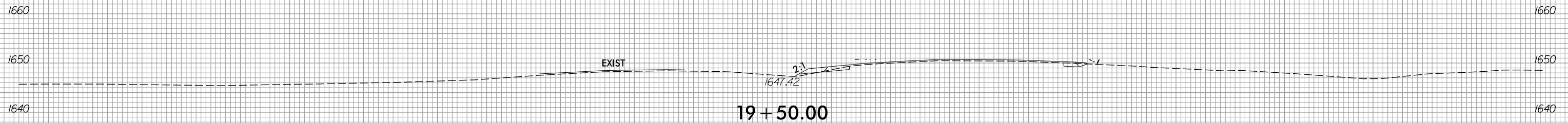
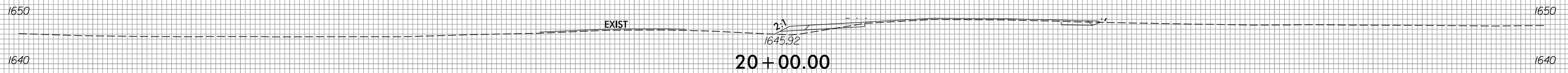
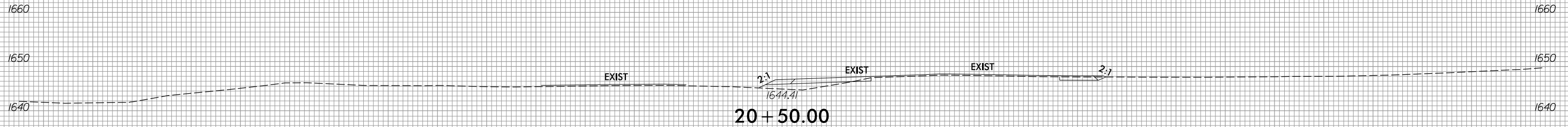

150 140 130 120 110 100 90 80 70 60 50 40 30 20 10 0 10 20 30 40 50 60 70 80 90 100 110 120 130 140 150

-Y12-



150 140 130 120 110 100 90 80 70 60 50 40 30 20 10 0 10 20 30 40 50 60 70 80 90 100 110 120 130 140 150

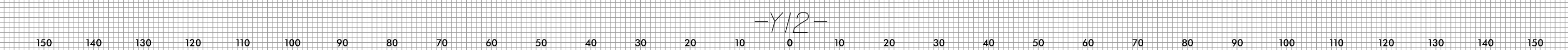
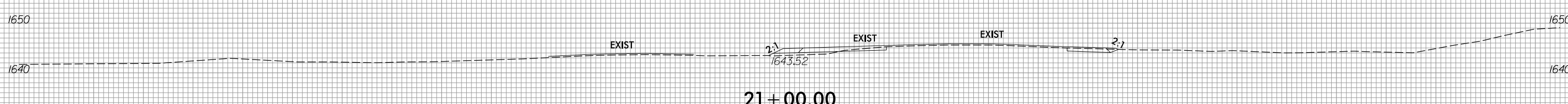
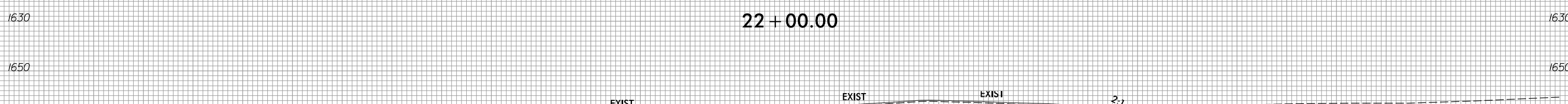
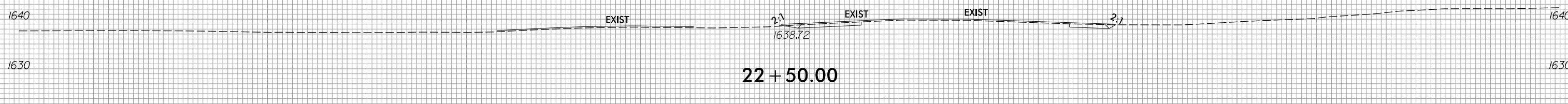
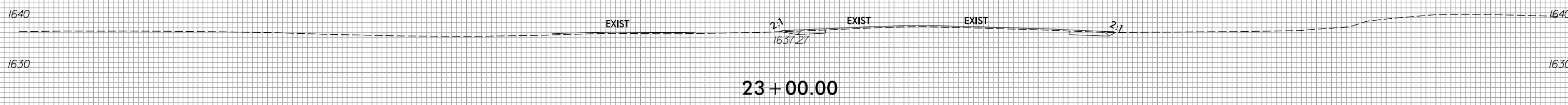
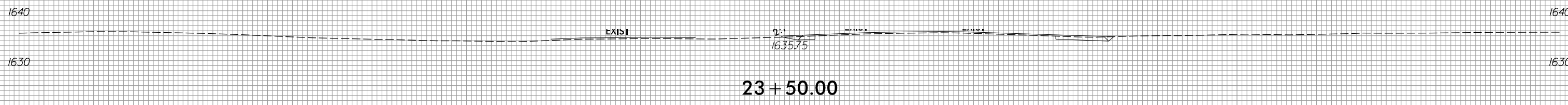

150 140 130 120 110 100 90 80 70 60 50 40 30 20 10 0 10 20 30 40 50 60 70 80 90 100 110 120 130 140 150

-Y12-



150 140 130 120 110 100 90 80 70 60 50 40 30 20 10 0 10 20 30 40 50 60 70 80 90 100 110 120 130 140 150

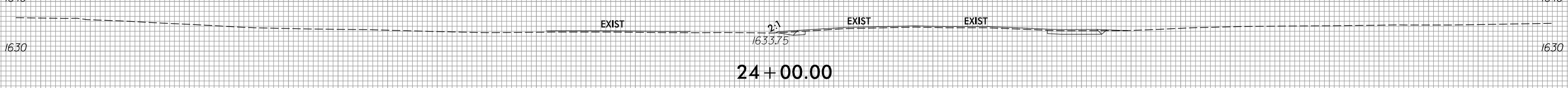
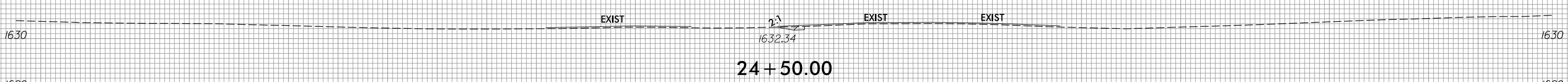
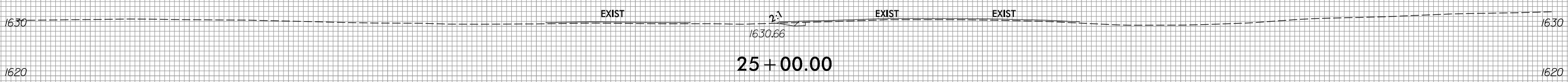
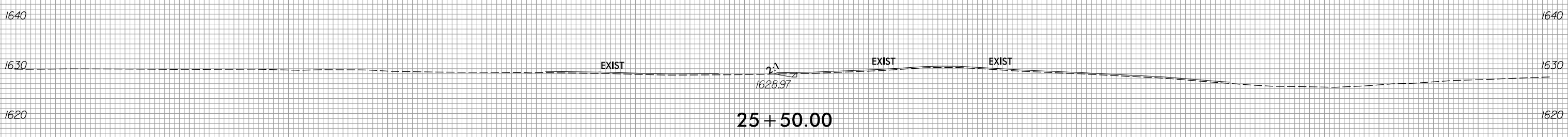
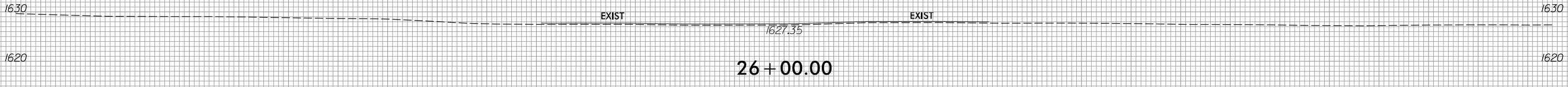
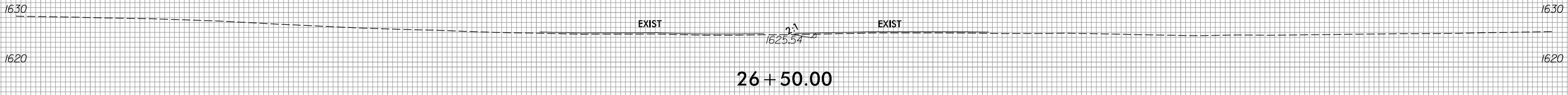

-Y12-

150 140 130 120 110 100 90 80 70 60 50 40 30 20 10 0 10 20 30 40 50 60 70 80 90 100 110 120 130 140 150



150 140 130 120 110 100 90 80 70 60 50 40 30 20 10 0 10 20 30 40 50 60 70 80 90 100 110 120 130 140 150

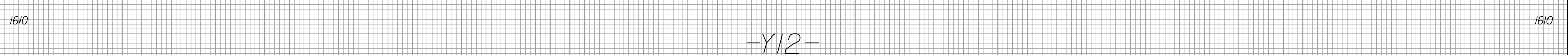
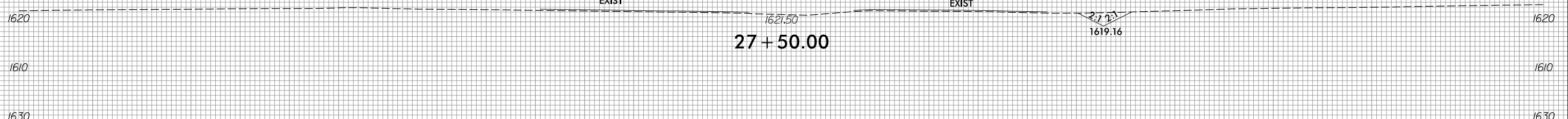
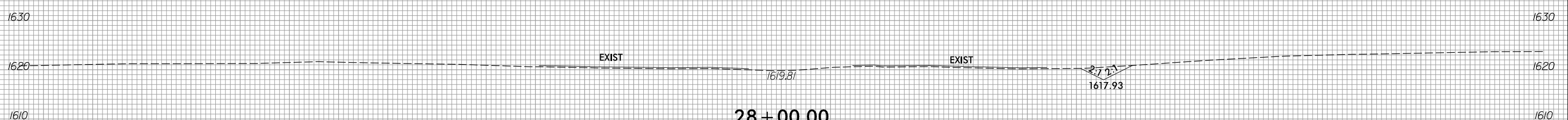
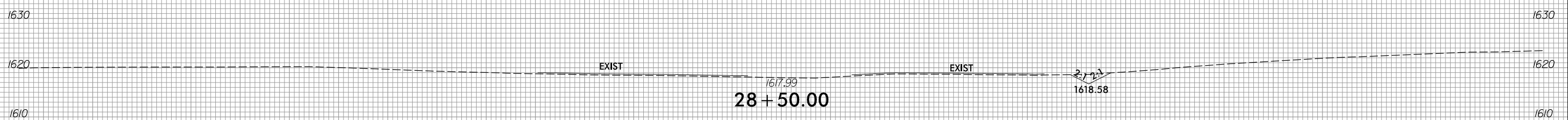
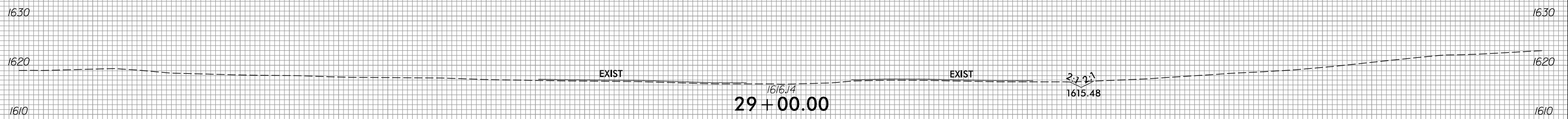

150 140 130 120 110 100 90 80 70 60 50 40 30 20 10 0 10 20 30 40 50 60 70 80 90 100 110 120 130 140 150

-Y12-

6/23/16



PROJ. REFERENCE NO.	SHEET NO.
R_5861	X-261

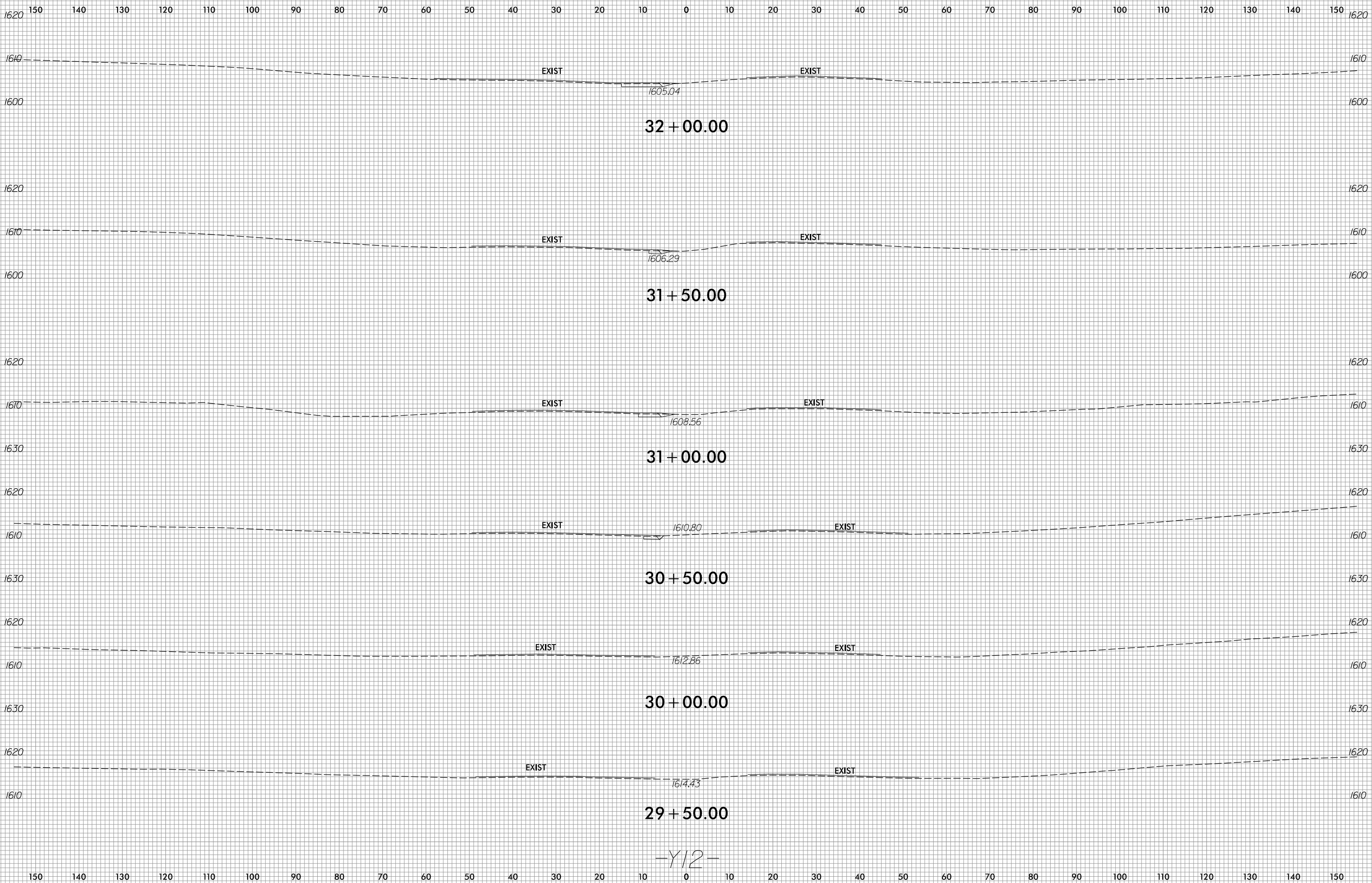

8/3/2023
R:\Roadway\XSC\XPLs\RB861_Rdyr_XPL_Y12.dgn
jlinson



150 140 130 120 110 100 90 80 70 60 50 40 30 20 10 0 10 20 30 40 50 60 70 80 90 100 110 120 130 140 150

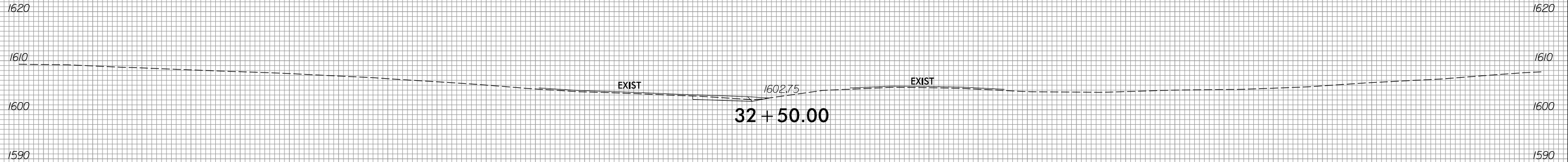
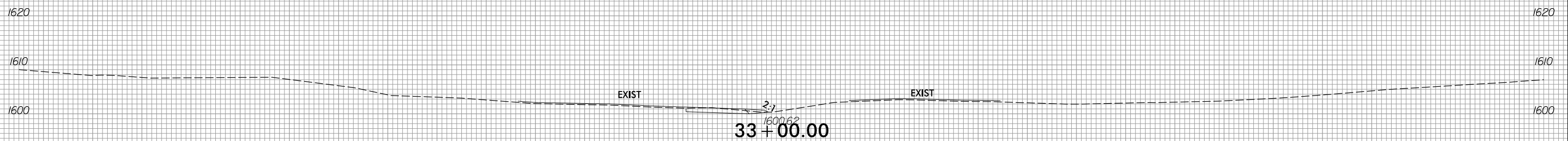
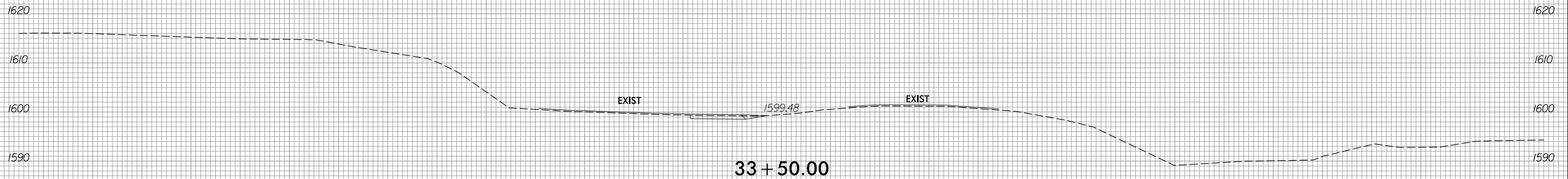
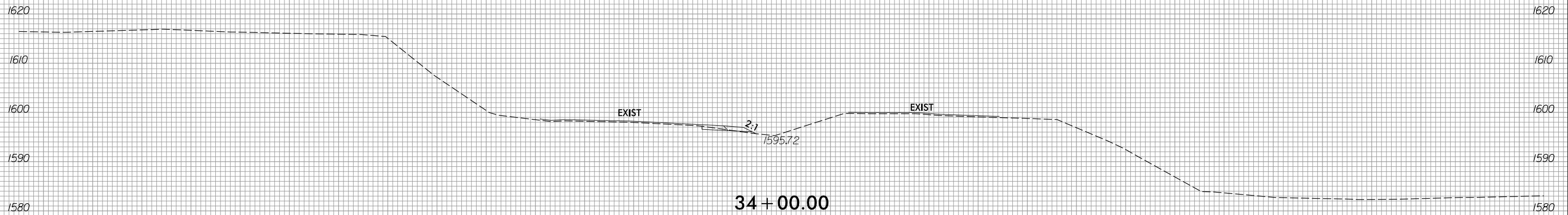

150 140 130 120 110 100 90 80 70 60 50 40 30 20 10 0 10 20 30 40 50 60 70 80 90 100 110 120 130 140 150

-Y12-



150 140 130 120 110 100 90 80 70 60 50 40 30 20 10 0 10 20 30 40 50 60 70 80 90 100 110 120 130 140 150



35 + 50.00

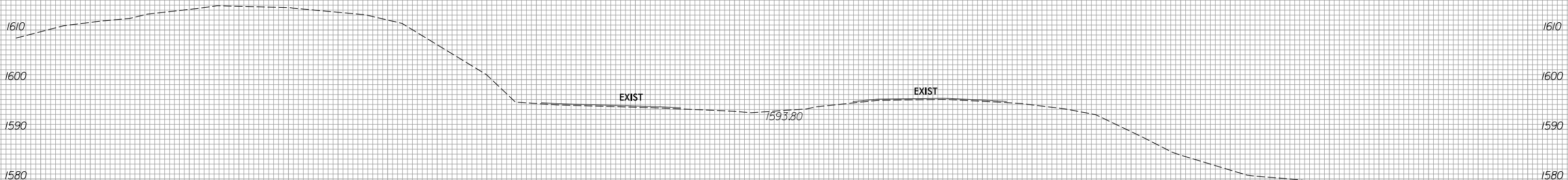

35 + 00.00

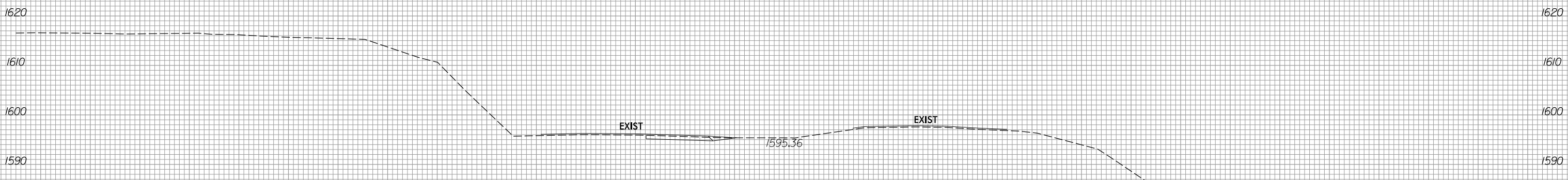

34 + 50.00

-Y12-

150 140 130 120 110 100 90 80 70 60 50 40 30 20 10 0 10 20 30 40 50 60 70 80 90 100 110 120 130 140 150



150 140 130 120 110 100 90 80 70 60 50 40 30 20 10 0 10 20 30 40 50 60 70 80 90 100 110 120 130 140 150

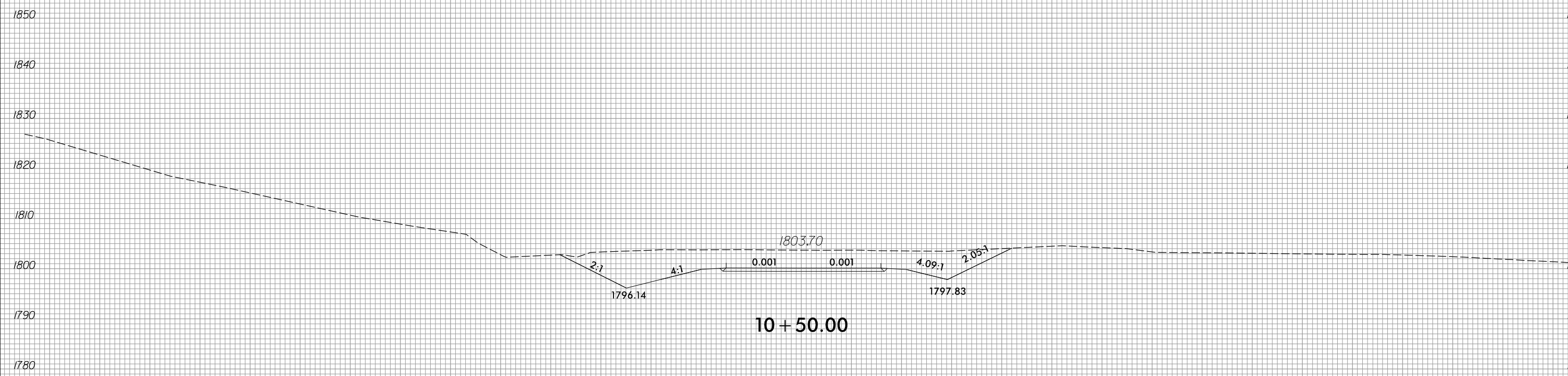
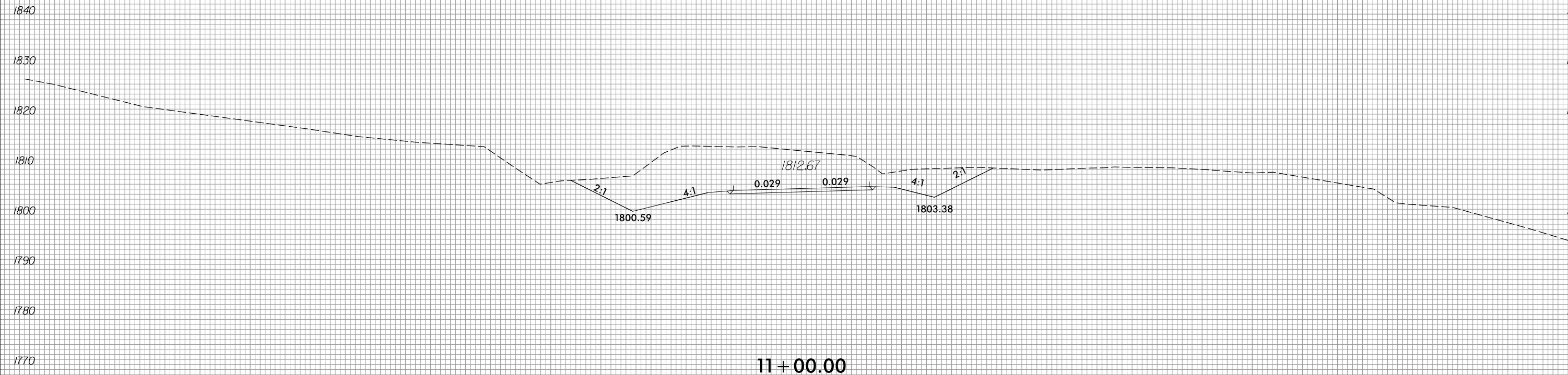

-Y13-

150 140 130 120 110 100 90 80 70 60 50 40 30 20 10 0 10 20 30 40 50 60 70 80 90 100 110 120 130 140 150

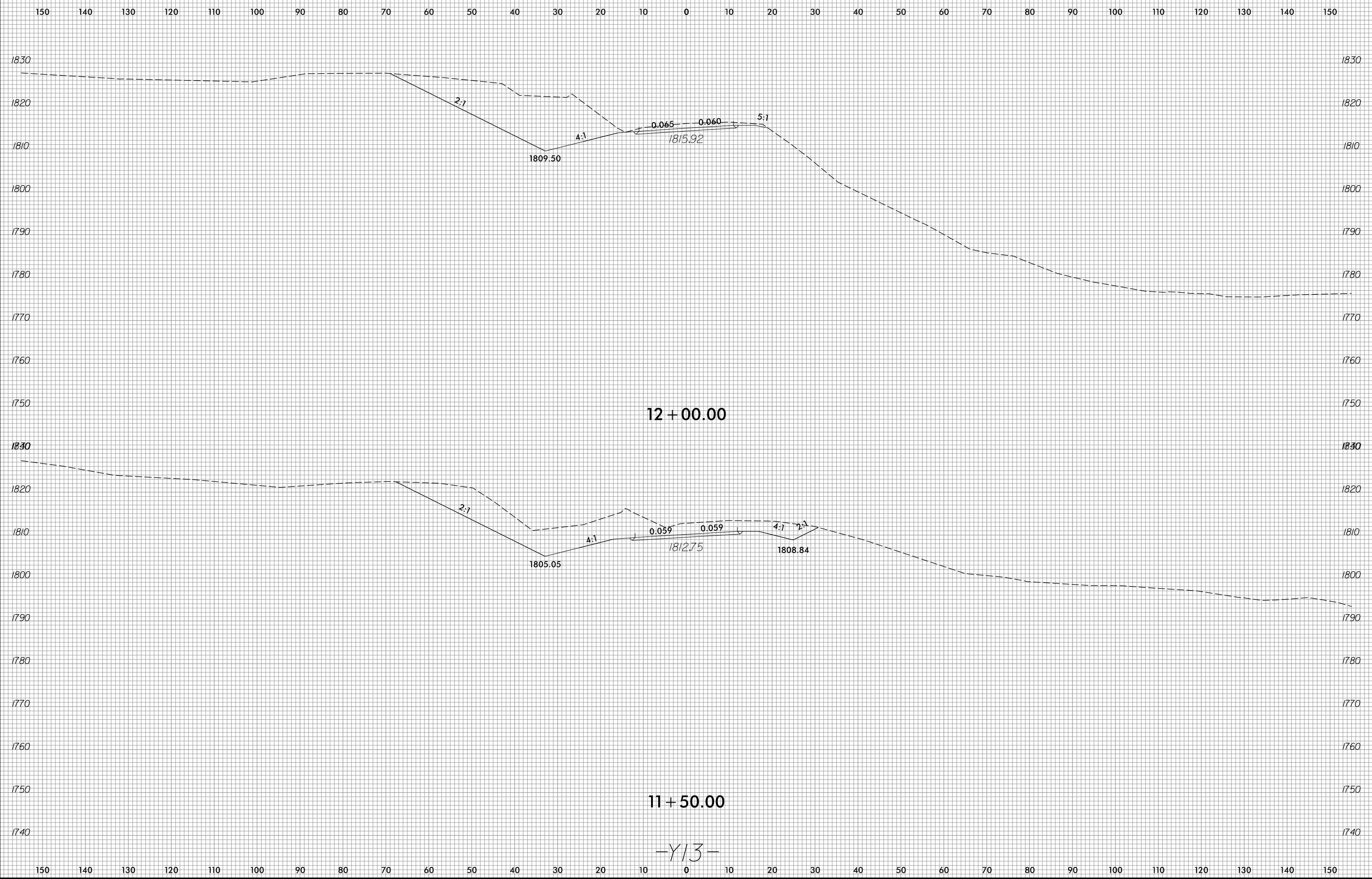

-Y13-



150 140 130 120 110 100 90 80 70 60 50 40 30 20 10 0 10 20 30 40 50 60 70 80 90 100 110 120 130 140 150

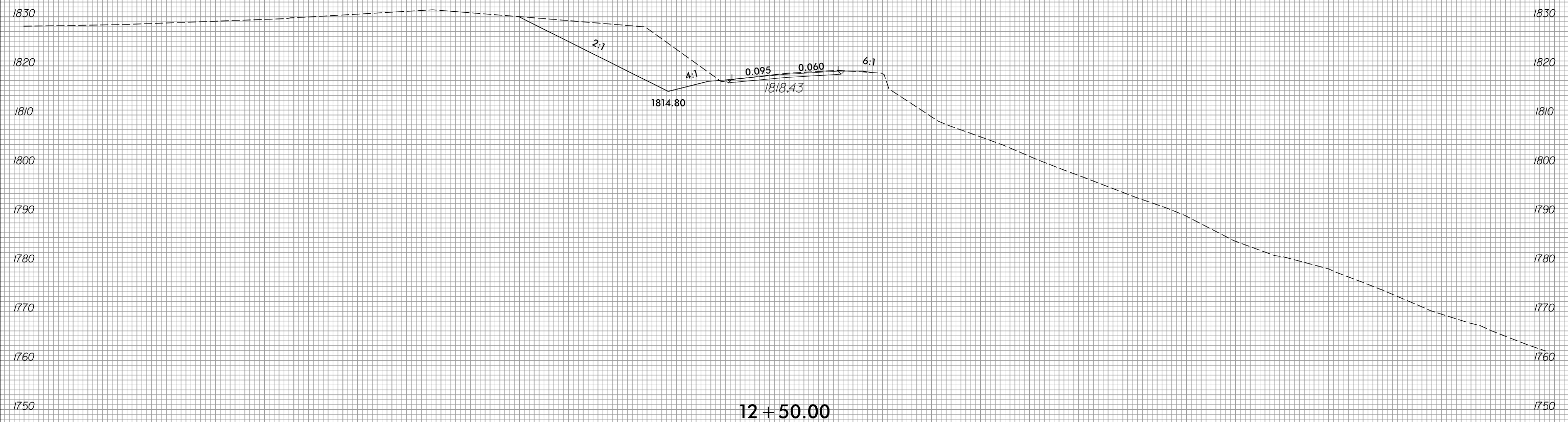

12 + 50.00

-Y13-

150 140 130 120 110 100 90 80 70 60 50 40 30 20 10 0 10 20 30 40 50 60 70 80 90 100 110 120 130 140 150

6/23/16

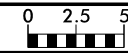

PROJ. REFERENCE NO.	SHEET NO.
R-5861	X-267

75 70 65 60 55 50 45 40 35 30 25 20 15 10 5 0 5 10 15 20 25 30 35 40 45 50 55 60 65 70 75

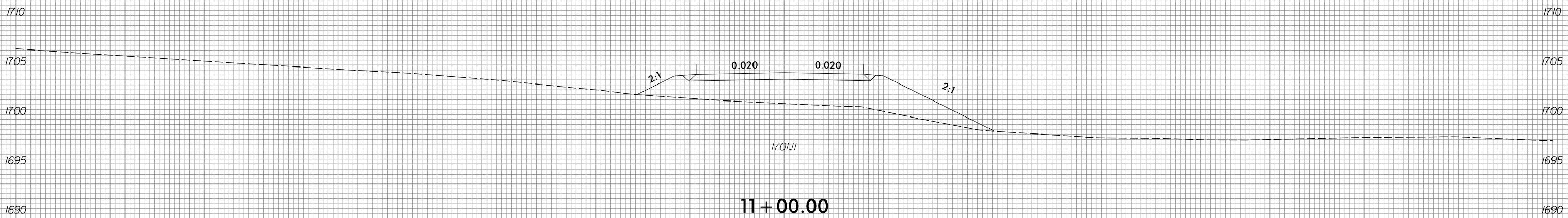

11 + 00.00

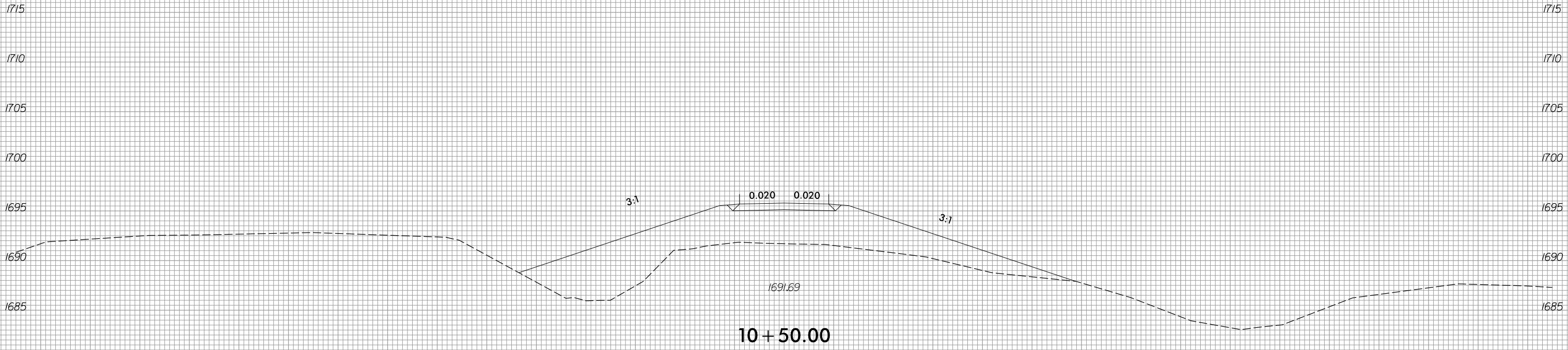

10 + 50.00

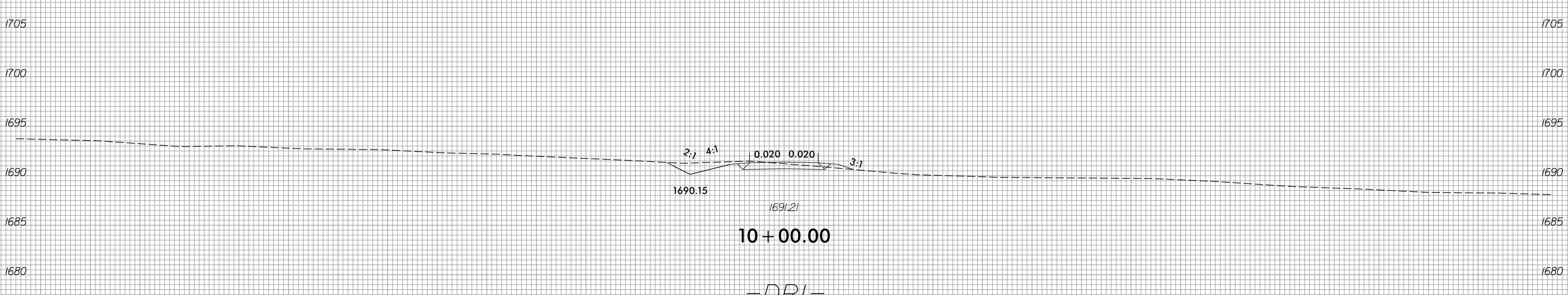

10 + 00.00

-DRI-

8/3/2023
 R:\Roadway\XSC\XPLs\RB861_Rdy_XPL_DR1.dgn
 jinson

75 70 65 60 55 50 45 40 35 30 25 20 15 10 5 0 5 10 15 20 25 30 35 40 45 50 55 60 65 70 75

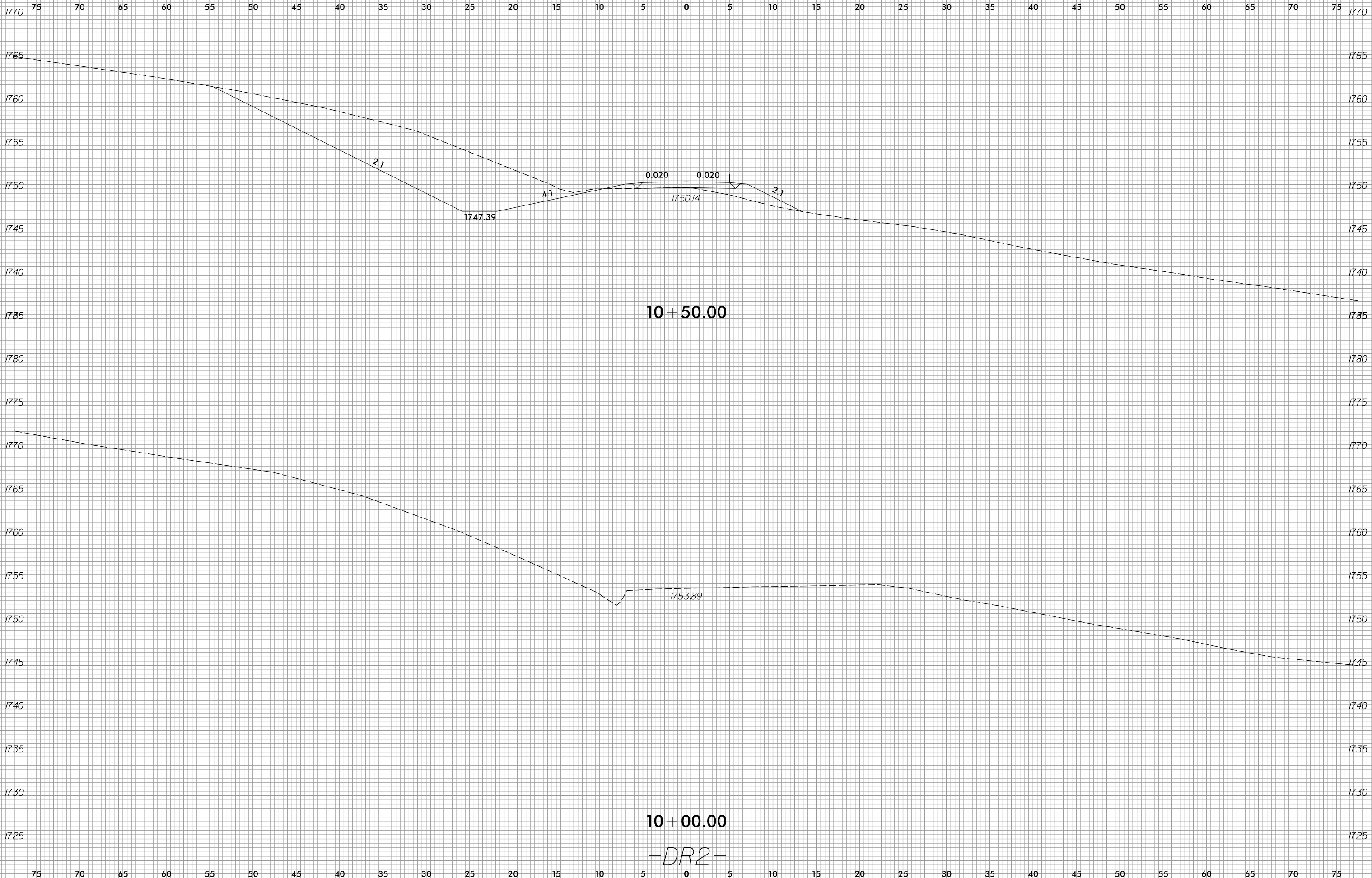
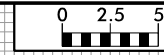

10 + 00.00

-DR2-

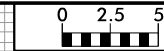

75 70 65 60 55 50 45 40 35 30 25 20 15 10 5 0 5 10 15 20 25 30 35 40 45 50 55 60 65 70 75

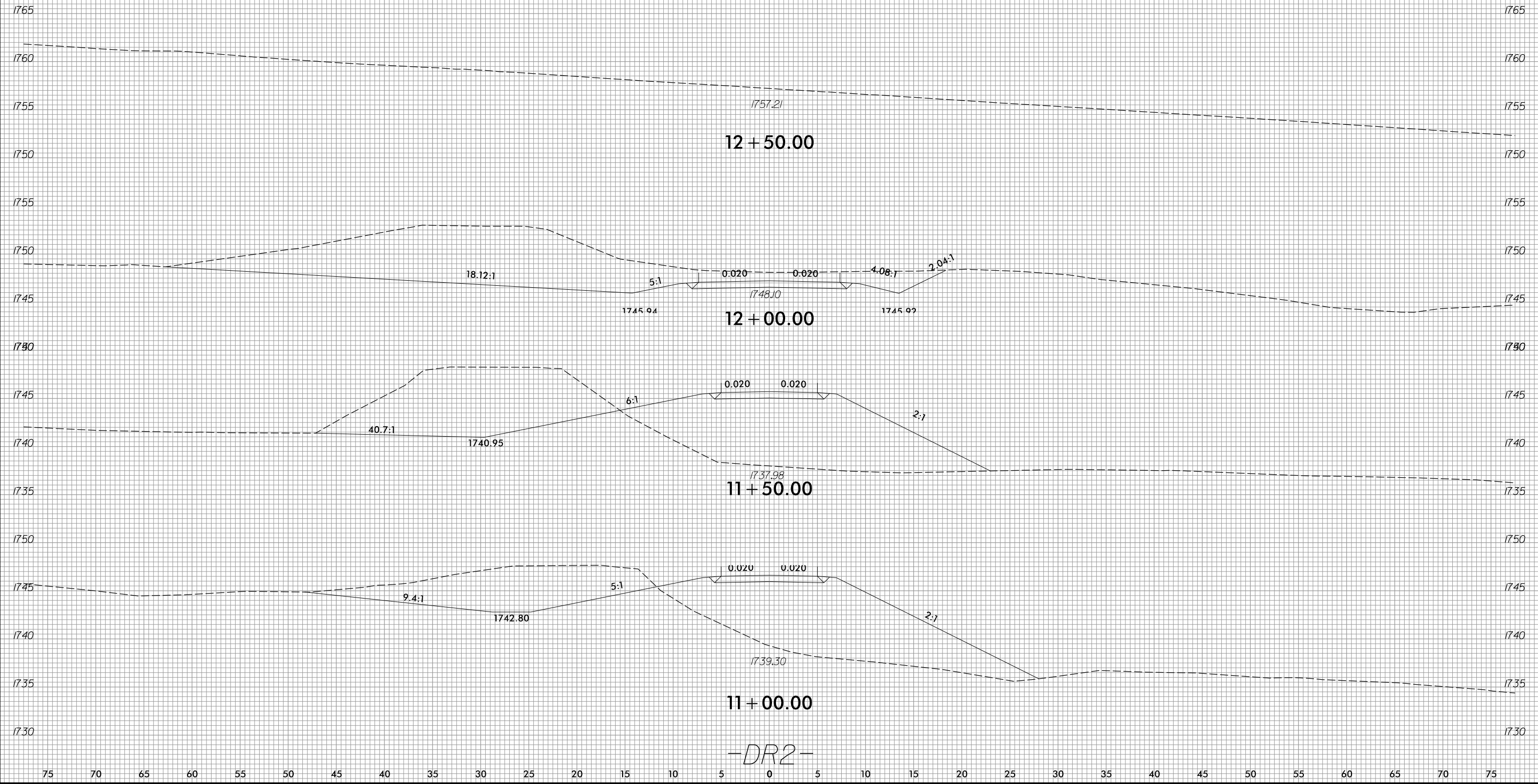

-DR2-

6/23/16

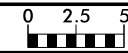

PROJ. REFERENCE NO.	SHEET NO.
R-5861	X-270

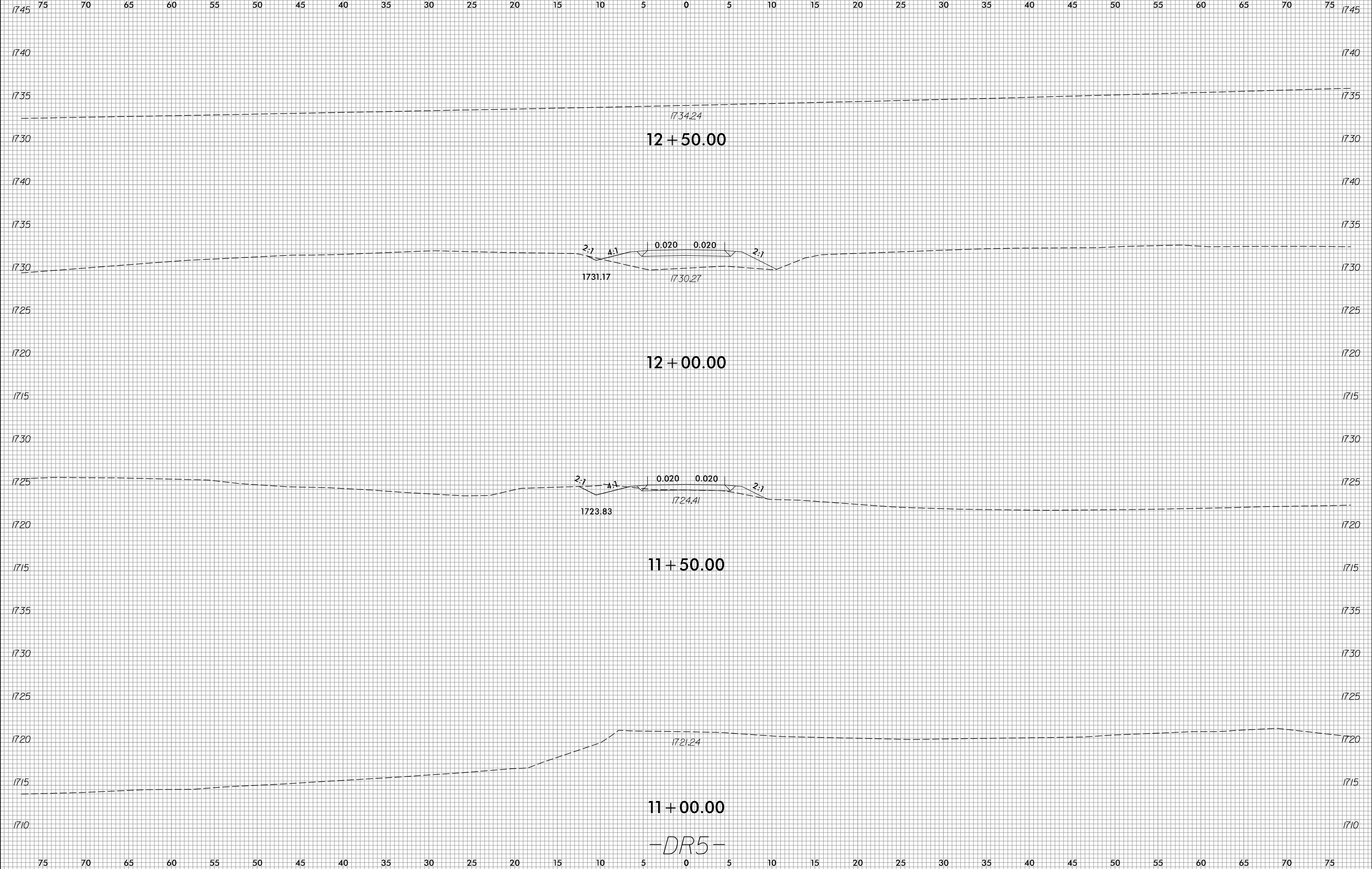

-DR5-

8/3/2023
R:\Roadway\XSC\XPLs\RB661.Rdy.XPL_DR5.dgn
jlinson

6/23/16

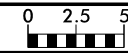

PROJ. REFERENCE NO.	SHEET NO.
R-5861	X-271

75 70 65 60 55 50 45 40 35 30 25 20 15 10 5 0 5 10 15 20 25 30 35 40 45 50 55 60 65 70 75

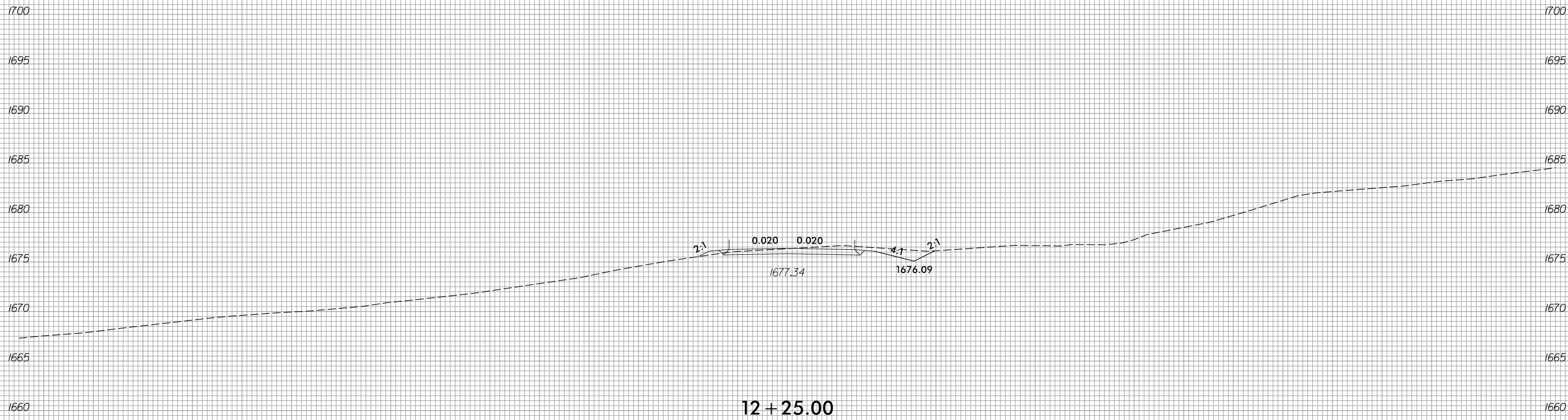
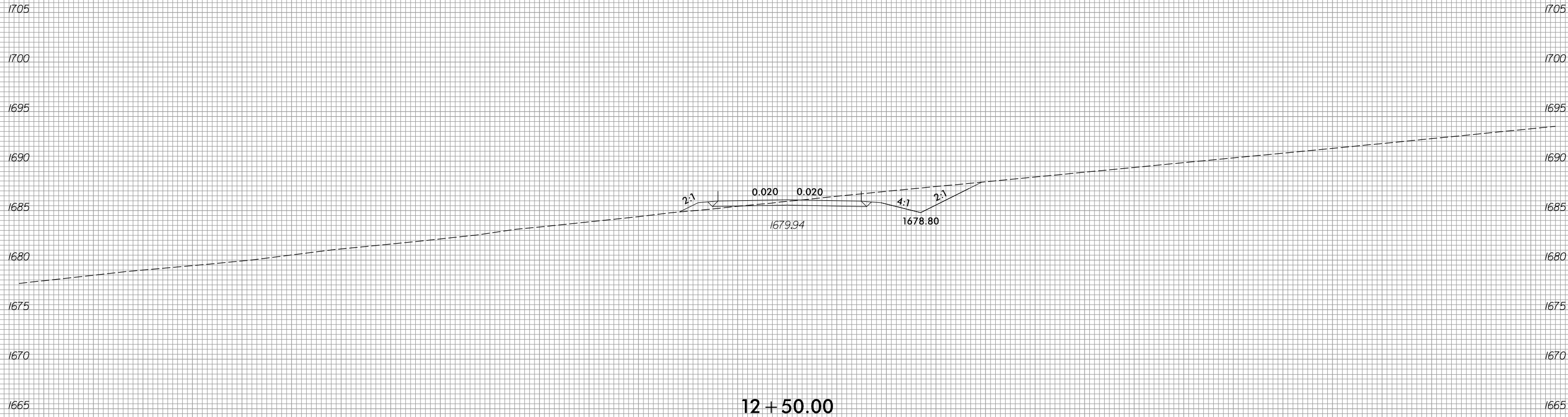

-DR6-

75 70 65 60 55 50 45 40 35 30 25 20 15 10 5 0 5 10 15 20 25 30 35 40 45 50 55 60 65 70 75

8/3/2023
R:\Roadway\XSC\XPLs\RB861.Rdy.XPL_DR6.dgn
jlinson

6/23/16

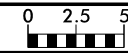

PROJ. REFERENCE NO.	SHEET NO.
R-5861	X-272

75 70 65 60 55 50 45 40 35 30 25 20 15 10 5 0 5 10 15 20 25 30 35 40 45 50 55 60 65 70 75

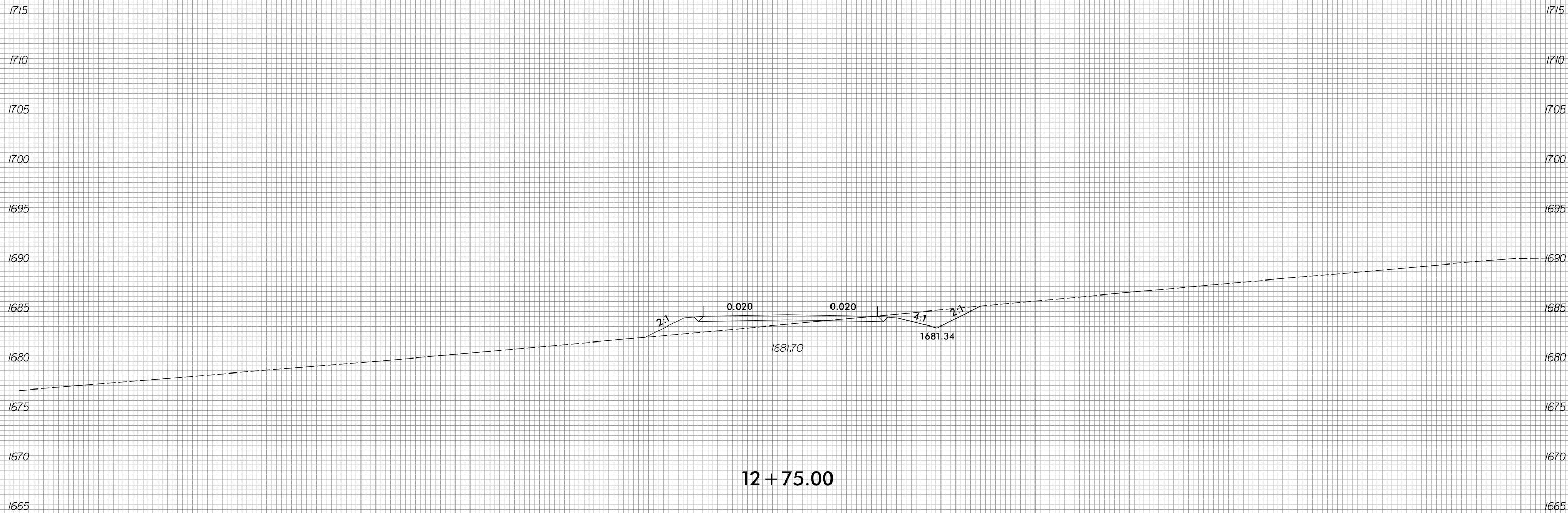

12 + 75.00

-DR6-

8/3/2023
R:\Roadway\XSC\XPLs\RB861\RDy.XPL_DR6.dgn
jlinson

75 70 65 60 55 50 45 40 35 30 25 20 15 10 5 0 5 10 15 20 25 30 35 40 45 50 55 60 65 70 75



150 140 130 120 110 100 90 80 70 60 50 40 30 20 10 0 10 20 30 40 50 60 70 80 90 100 110 120 130 140 150

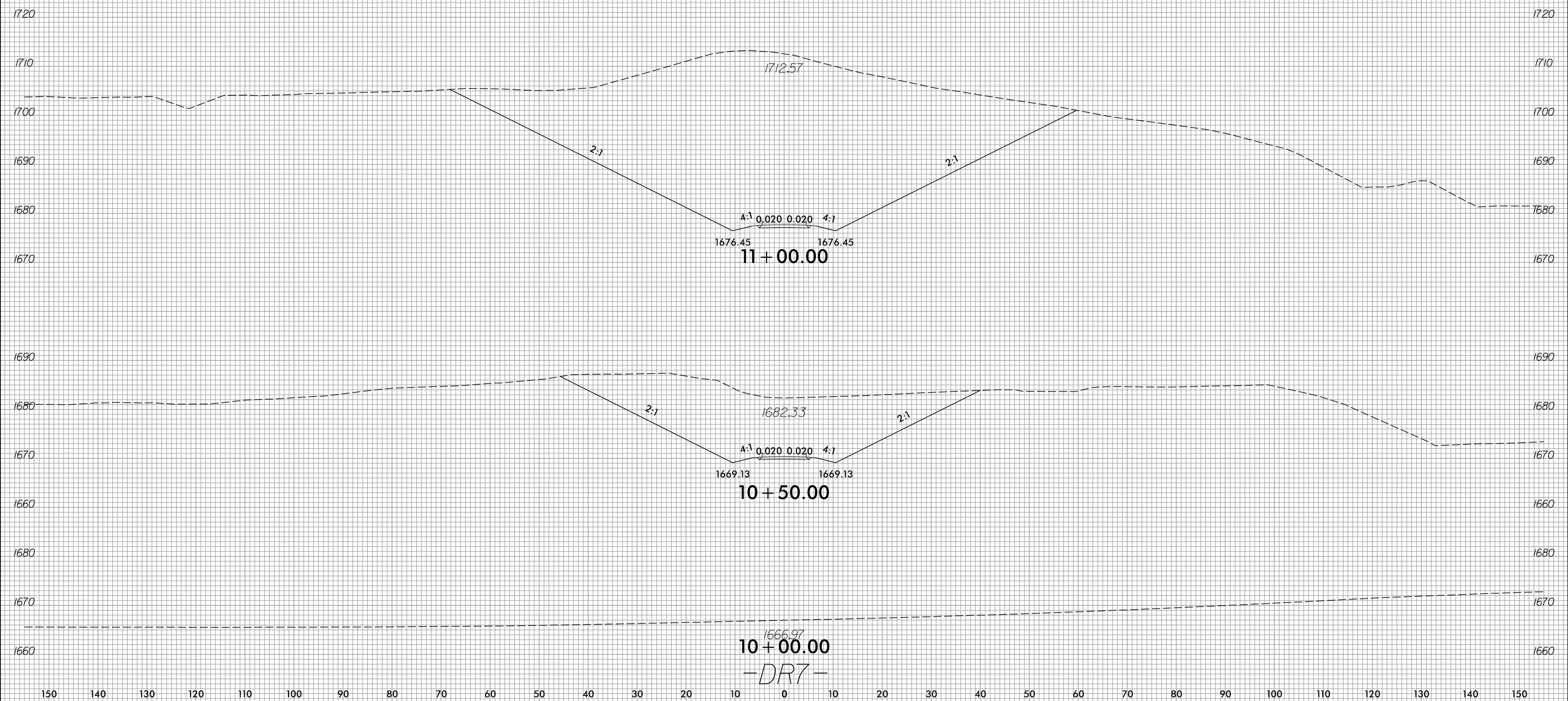

150 140 130 120 110 100 90 80 70 60 50 40 30 20 10 0 10 20 30 40 50 60 70 80 90 100 110 120 130 140 150

6/23/16



PROJ. REFERENCE NO.	SHEET NO.
R-5861	X-274

150 140 130 120 110 100 90 80 70 60 50 40 30 20 10 0 10 20 30 40 50 60 70 80 90 100 110 120 130 140 150

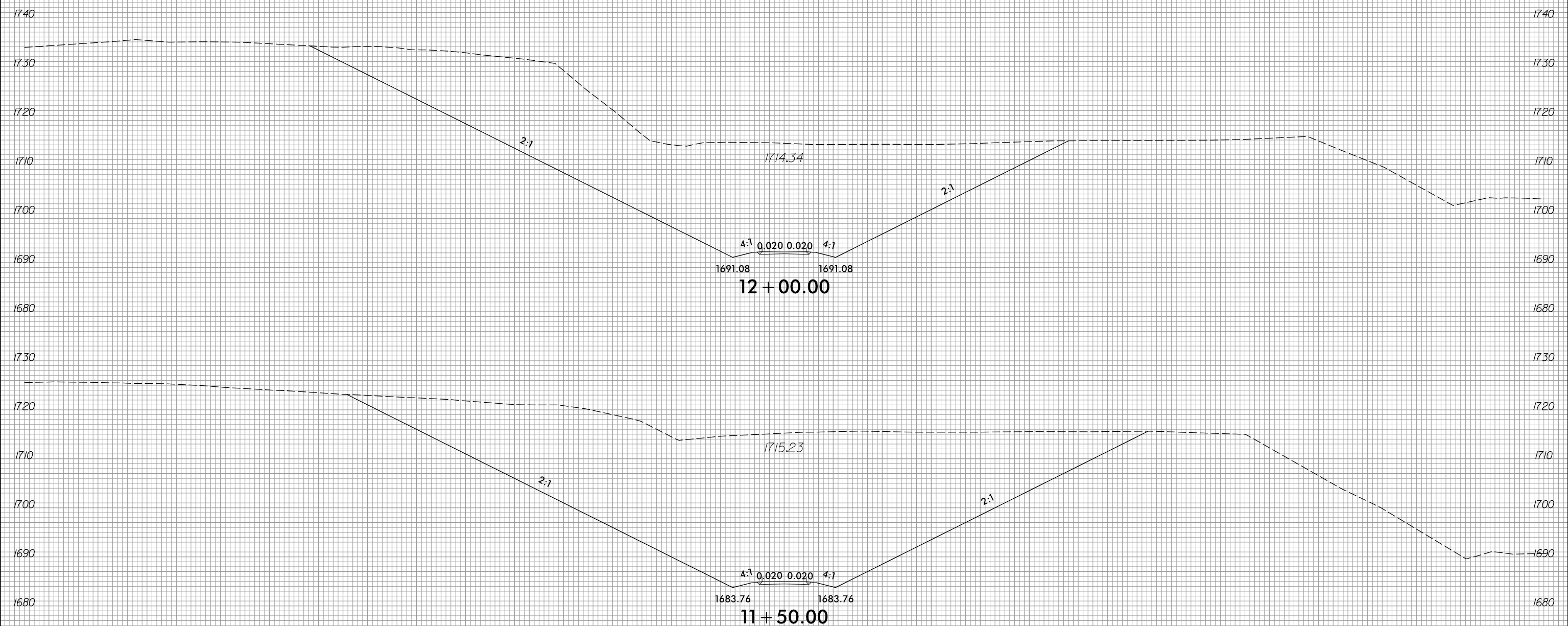

-DR7-

8/3/2023
 R:\Roadway\XSC\XPLs\RB661.Rdy.XPL_DR7.dgn
 jinison

6/23/16



PROJ. REFERENCE NO.	SHEET NO.
R-5861	X-275

150 140 130 120 110 100 90 80 70 60 50 40 30 20 10 0 10 20 30 40 50 60 70 80 90 100 110 120 130 140 150

1780 1780

1770 1770

1760 1760

1750 1750

1740 1740

1730 1730

1720 1720

1710 1710

1700 1700

1690 1690

1750 1750

1740 1740

1730 1730

1720 1720

1710 1710

1700 1700

1690 1690

150 140 130 120 110 100 90 80 70 60 50 40 30 20 10 0 10 20 30 40 50 60 70 80 90 100 110 120 130 140 150

13 + 00.00

12 + 50.00

-DR7-

8/3/2023
 R:\Roadway\XSC\XPLs\RB861\RDy_XPL_DR7.dgn
 jinson

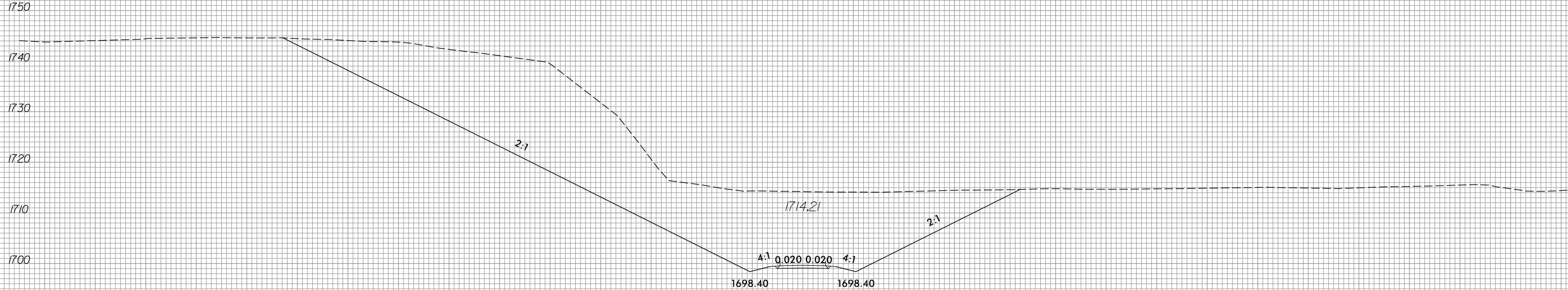
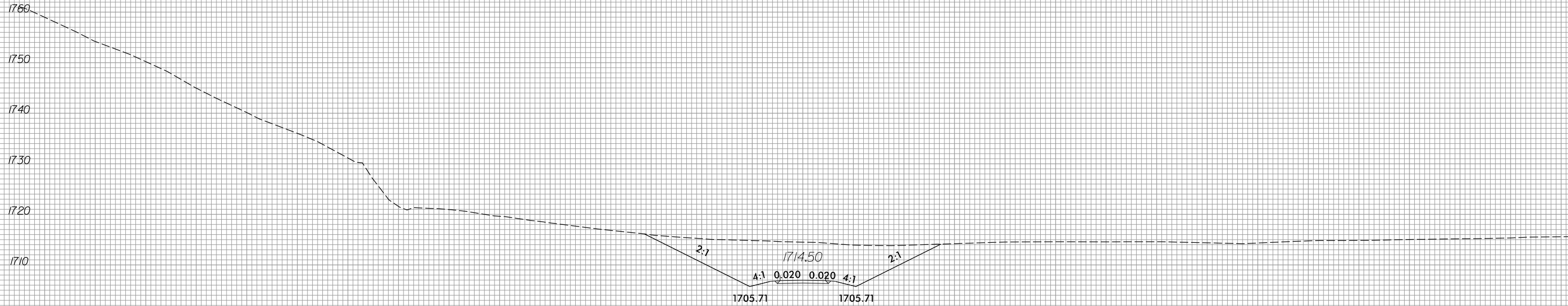

6/23/16



PROJ. REFERENCE NO.	SHEET NO.
R-5861	X-276

150 140 130 120 110 100 90 80 70 60 50 40 30 20 10 0 10 20 30 40 50 60 70 80 90 100 110 120 130 140 150

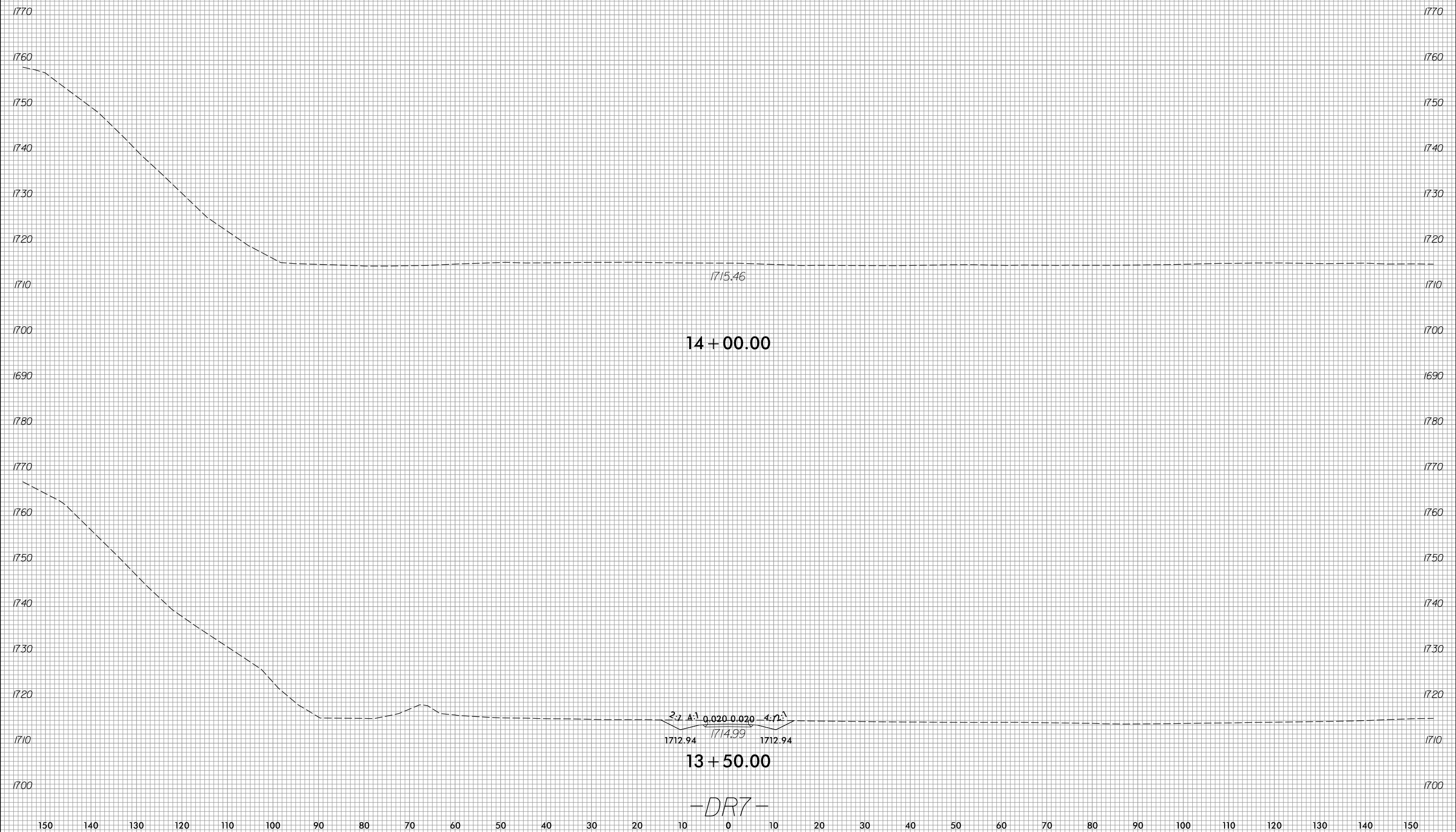

14 + 00.00

13 + 50.00

-DR7-

8/3/2023
R:\Roadway\XSC\XPLs\RB861_Rdy_XPL_DR7.dgn
jlinson

6/23/16

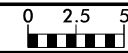

PROJ. REFERENCE NO.	SHEET NO.
R-5861	X-277

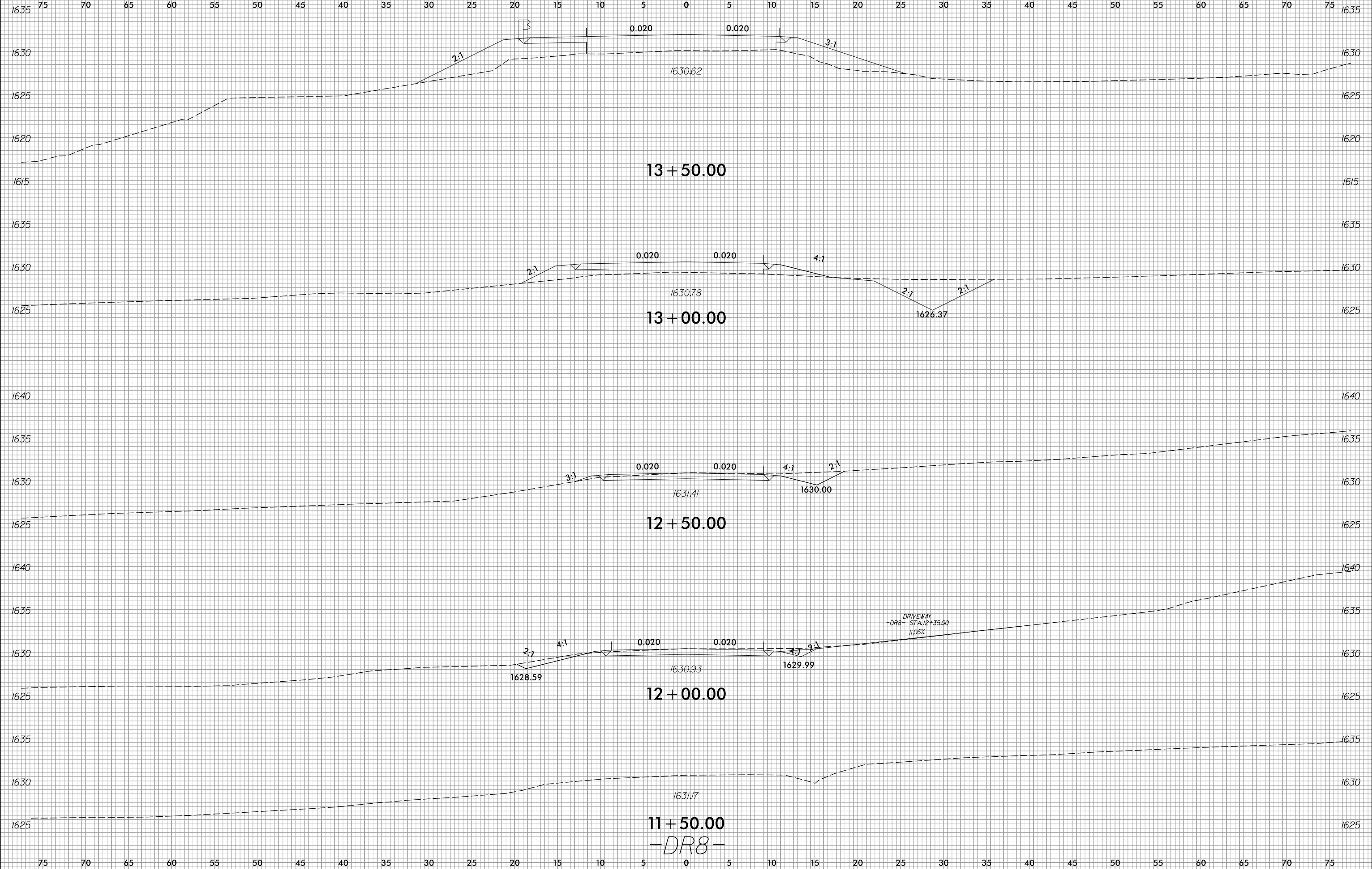

8/3/2023
 R:\Roadway\XSC\XPLs\RB861\RDy_XPL_DR8.dgn
 jinison

6/23/16

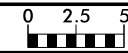

PROJ. REFERENCE NO.	SHEET NO.
R-5861	X-278

75 70 65 60 55 50 45 40 35 30 25 20 15 10 5 0 5 10 15 20 25 30 35 40 45 50 55 60 65 70 75

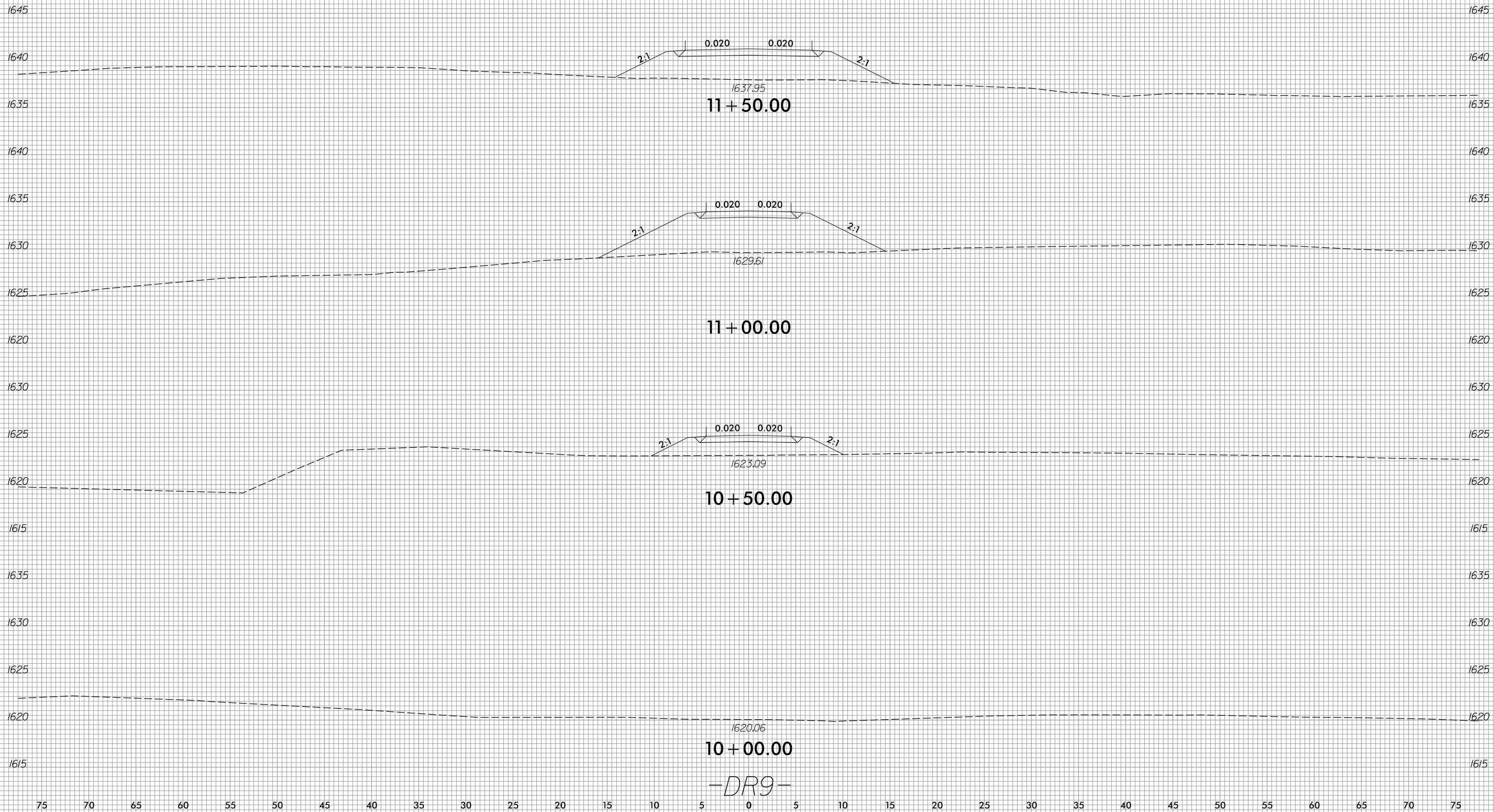

-DR9-

8/3/2023
 R:\Roadway\XSC\XPLs\RB861.Rdy.XPL_DR9.dgn
 jinson

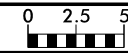

75 70 65 60 55 50 45 40 35 30 25 20 15 10 5 0 5 10 15 20 25 30 35 40 45 50 55 60 65 70 75

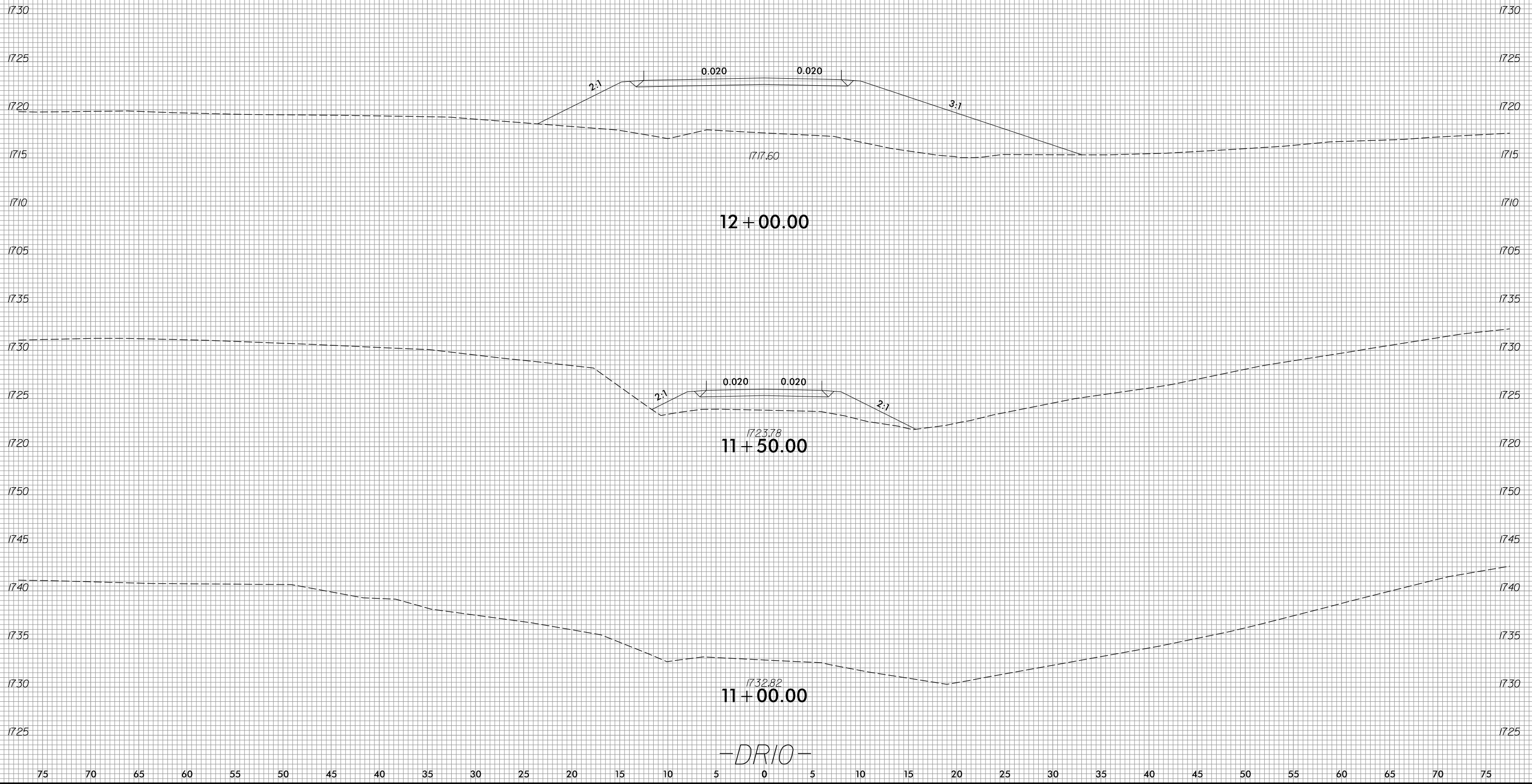

6/23/16

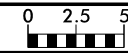

PROJ. REFERENCE NO.	SHEET NO.
R-5861	X-280

65 60 55 50 45 40 35 30 25 20 15 10 5 0 5 10 15 20 25 30 35 40 45 50 55 60 65 70 75 80 85

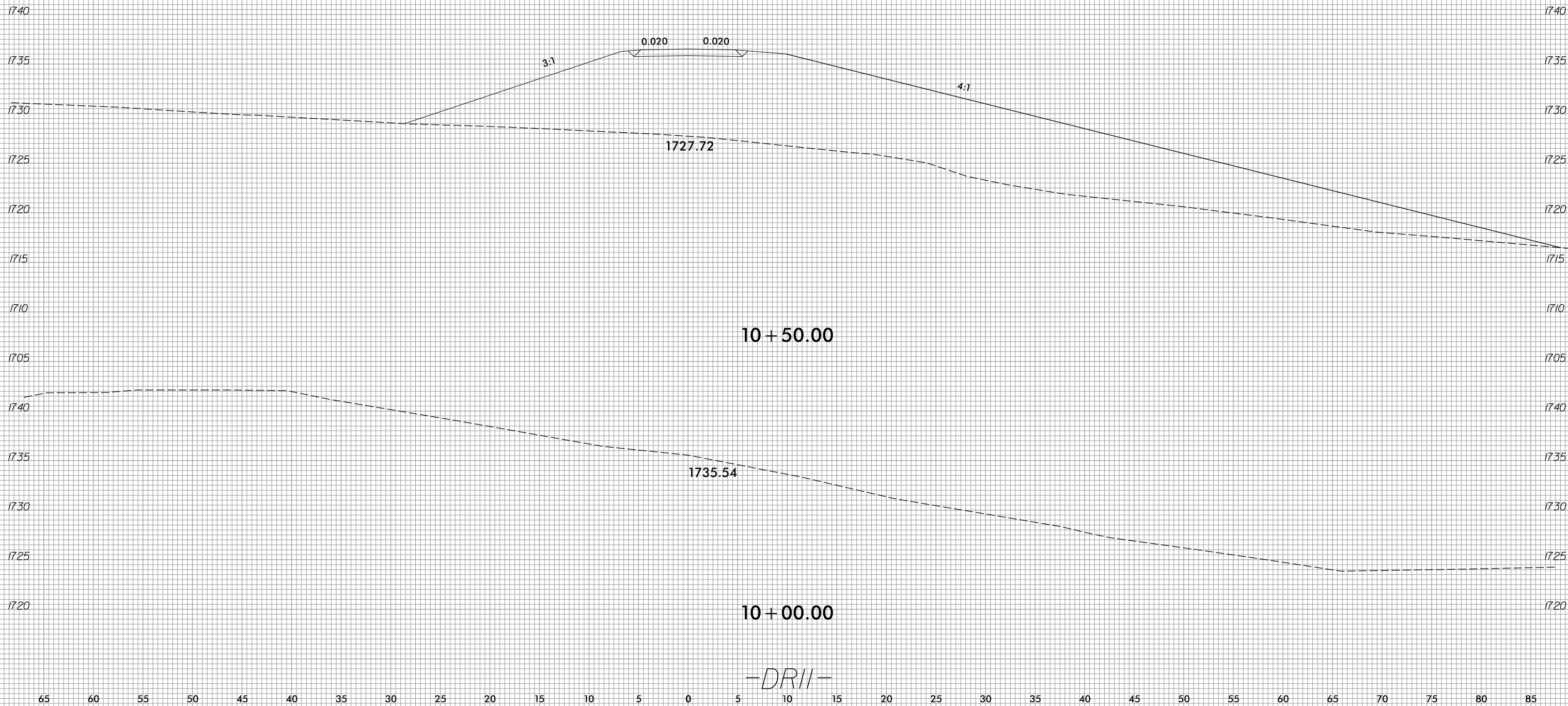

8/3/2023
 R:\Roadway\XSC\XPLs\RB861.Rdy.XPL_DR11.dgn
 jinson

-DR11-

6/23/16



PROJ. REFERENCE NO.	SHEET NO.
R-5861	X-281

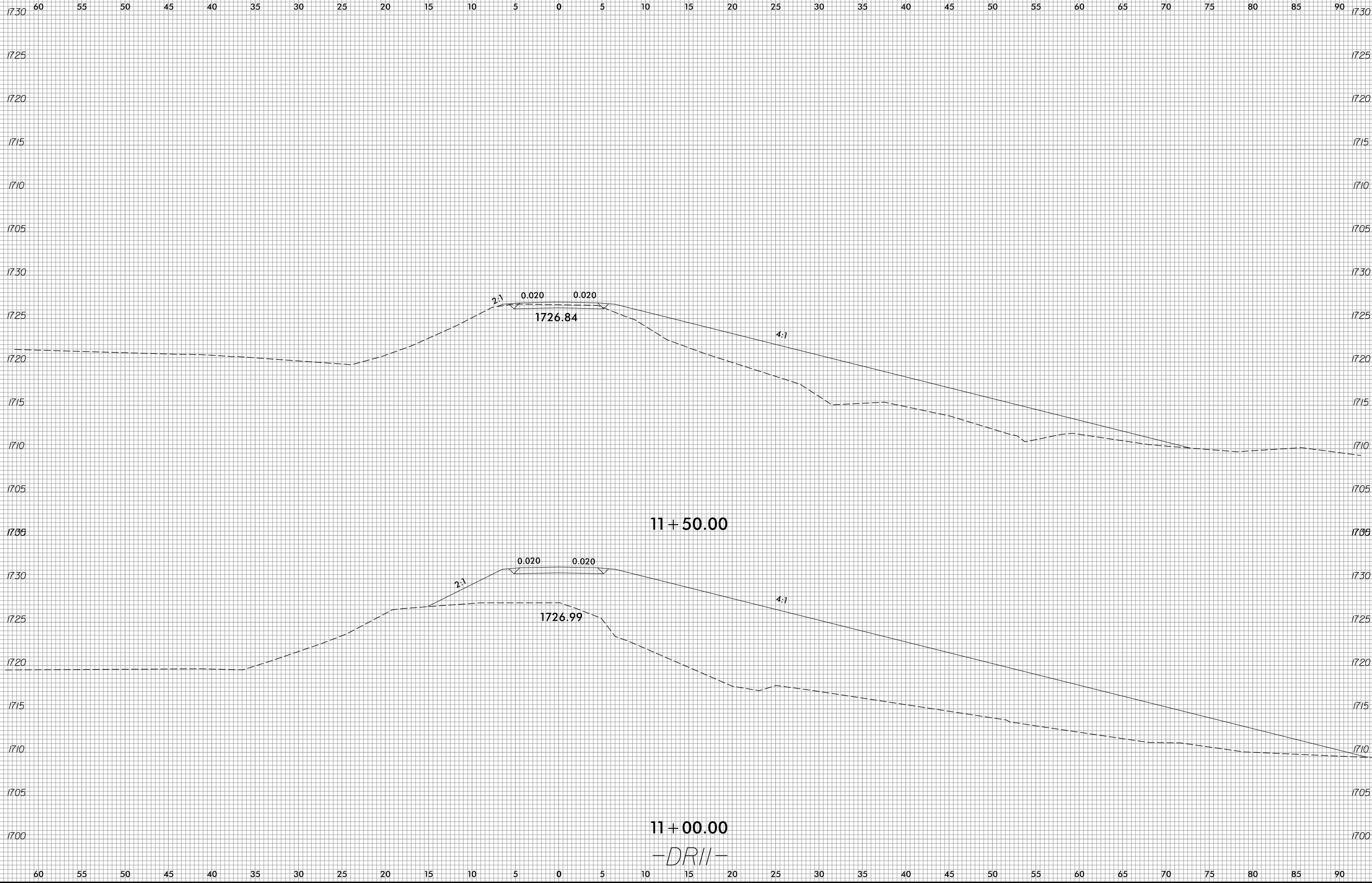

8/3/2023
 R:\Roadway\XSC\XPLs\RB861\RDy.XPL_DR11.dgn
 jinson

6/23/16

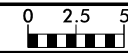

PROJ. REFERENCE NO.	SHEET NO.
R-5861	X-282

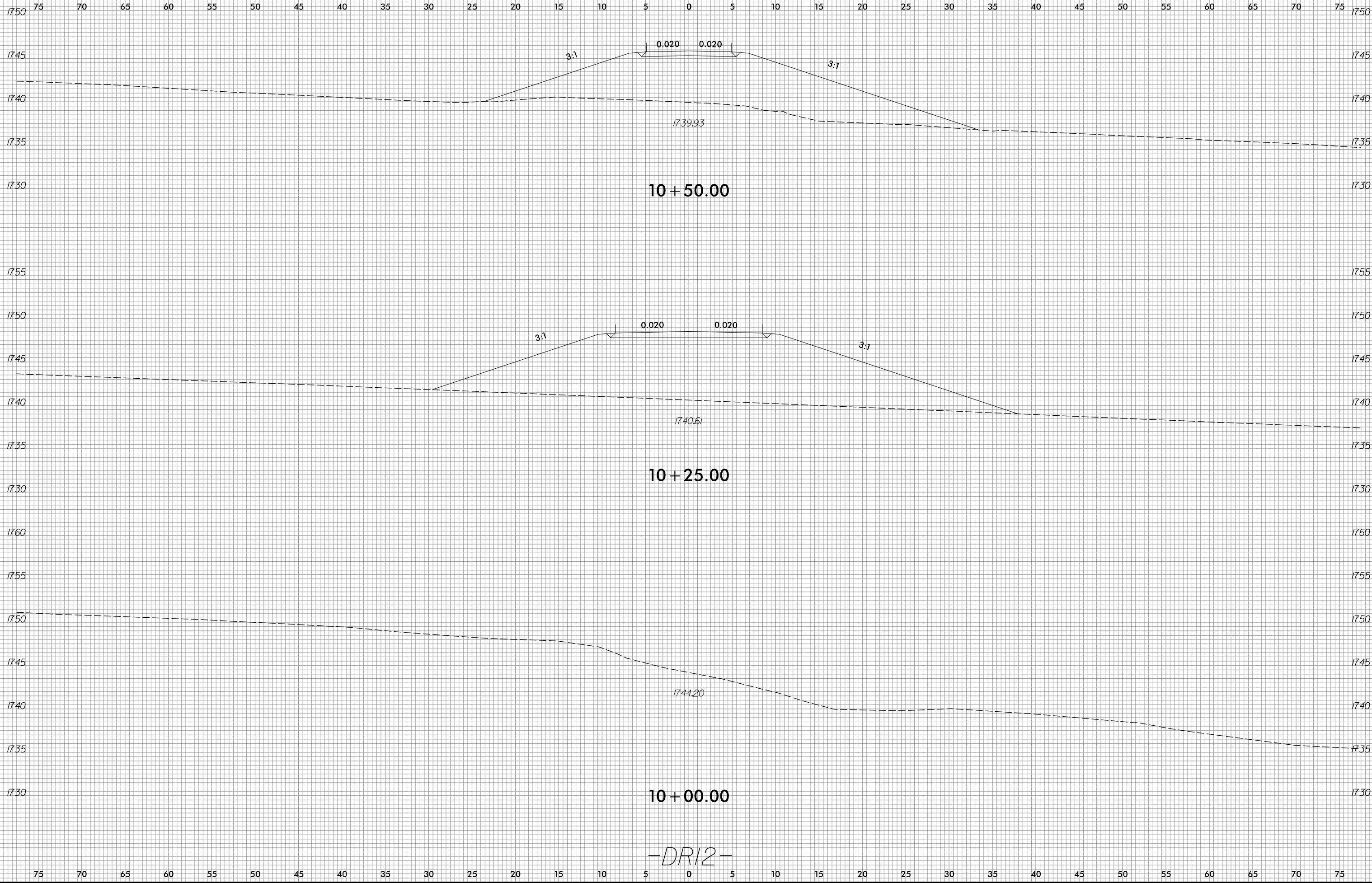

8/3/2023
R:\Roadway\XSC\XPLs\RB861\RDy.XPL_DR12.dgn
jlinson

-DR12-

6/23/16

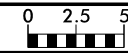

PROJ. REFERENCE NO.	SHEET NO.
R-5861	X-283

65 60 55 50 45 40 35 30 25 20 15 10 5 0 5 10 15 20 25 30 35 40 45 50 55 60 65 70 75 80 85

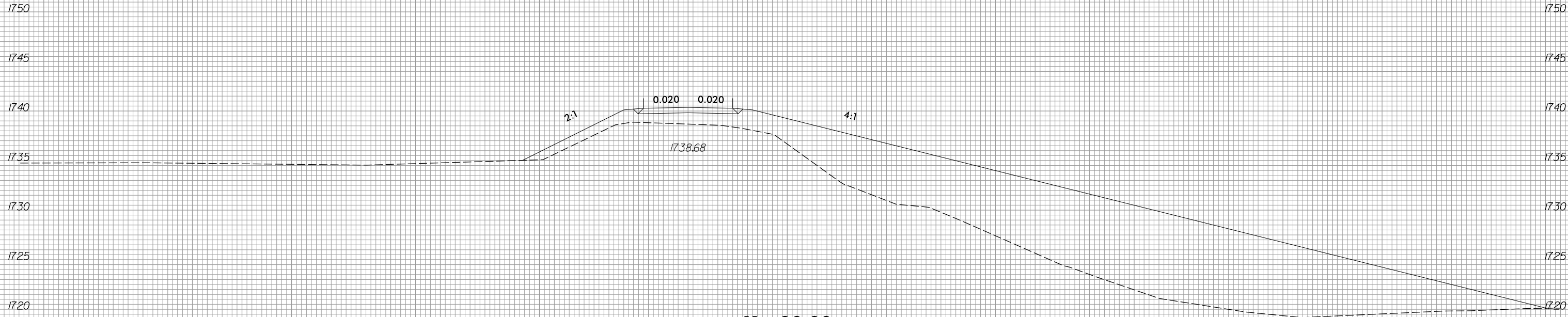

11 + 00.00

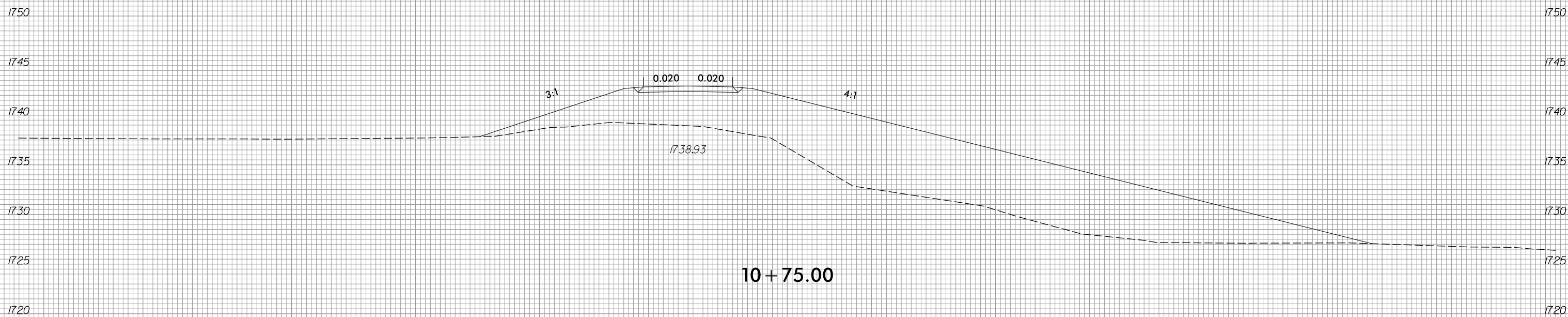

10 + 75.00

-DR12-

8/3/2023
 R:\Roadway\XSC\XPLs\RB661\RDy.XPL_DR12.dgn
 jinson

65 60 55 50 45 40 35 30 25 20 15 10 5 0 5 10 15 20 25 30 35 40 45 50 55 60 65 70 75 80 85

6/23/16

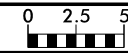

PROJ. REFERENCE NO.	SHEET NO.
R-5861	X-284

75 70 65 60 55 50 45 40 35 30 25 20 15 10 5 0 5 10 15 20 25 30 35 40 45 50 55 60 65 70 75

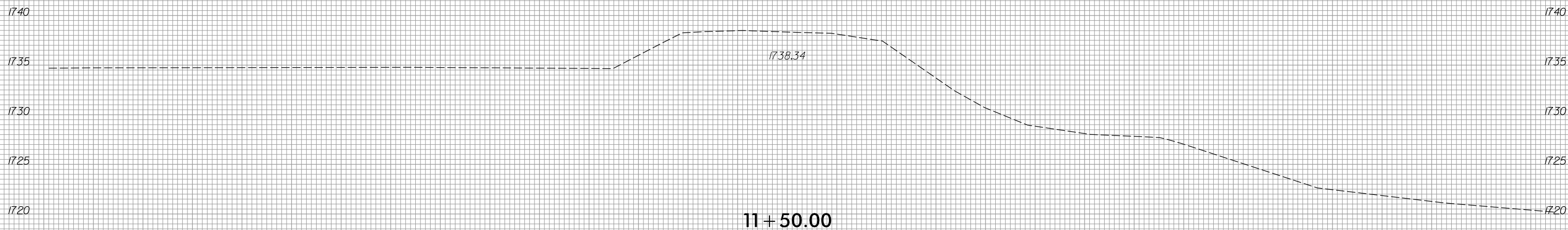

11 + 50.00

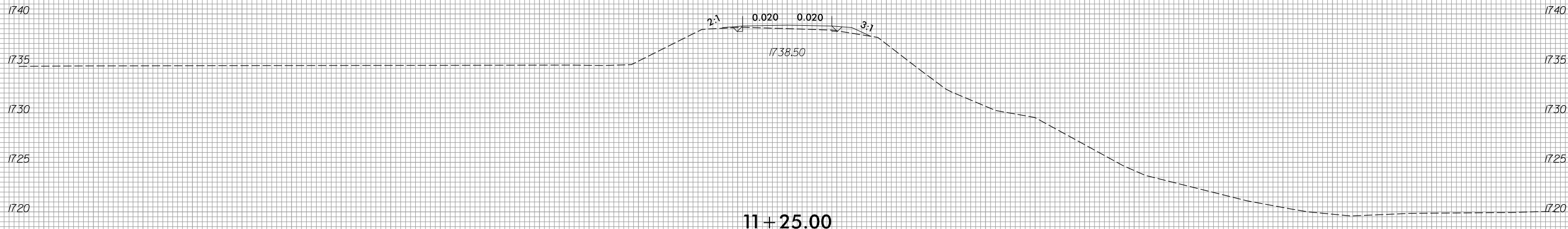

11 + 25.00

-DR12-

8/3/2023
 R:\Roadway\XSC\XPLs\RB661.Rdy.XPL_DR12.dgn
 jinson

75 70 65 60 55 50 45 40 35 30 25 20 15 10 5 0 5 10 15 20 25 30 35 40 45 50 55 60 65 70 75

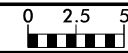

75 70 65 60 55 50 45 40 35 30 25 20 15 10 5 0 5 10 15 20 25 30 35 40 45 50 55 60 65 70 75

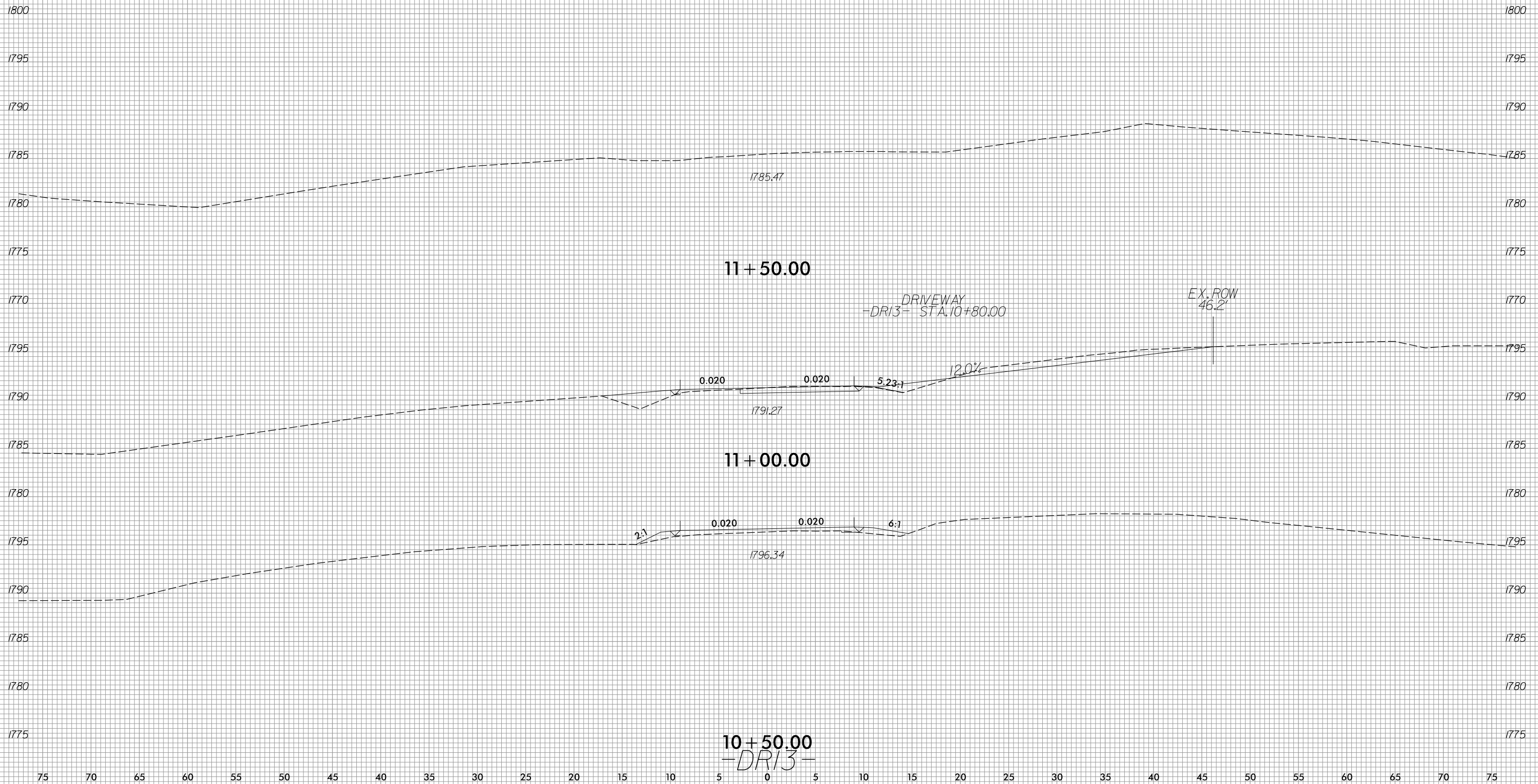

6/23/16



PROJ. REFERENCE NO.
R-5861

SHEET NO.
X-286

150 140 130 120 110 100 90 80 70 60 50 40 30 20 10 0 10 20 30 40 50 60 70 80 90 100 110 120 130 140 150

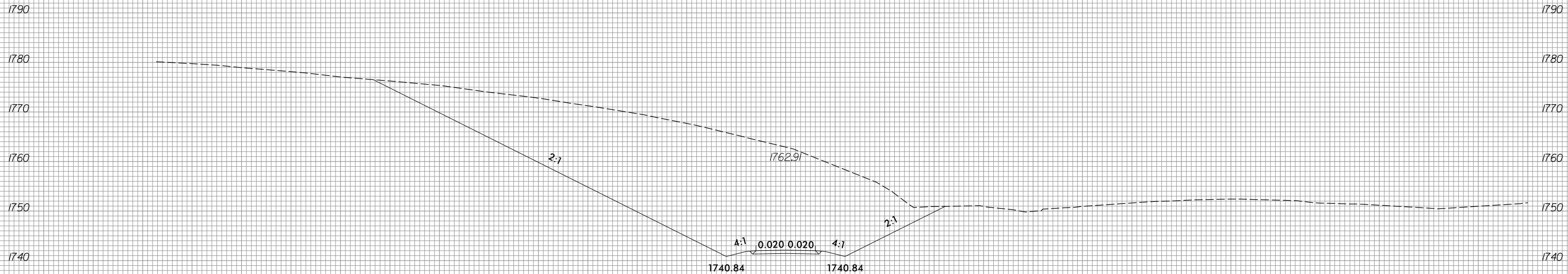

11 + 00.00

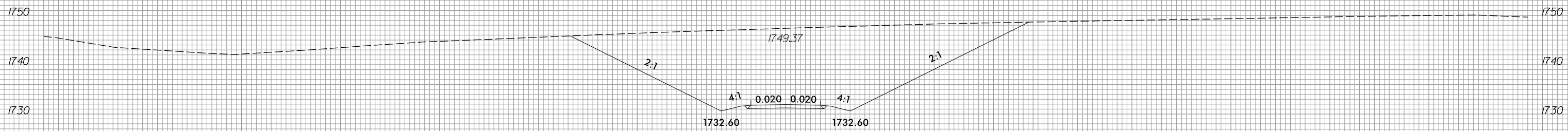

10 + 50.00

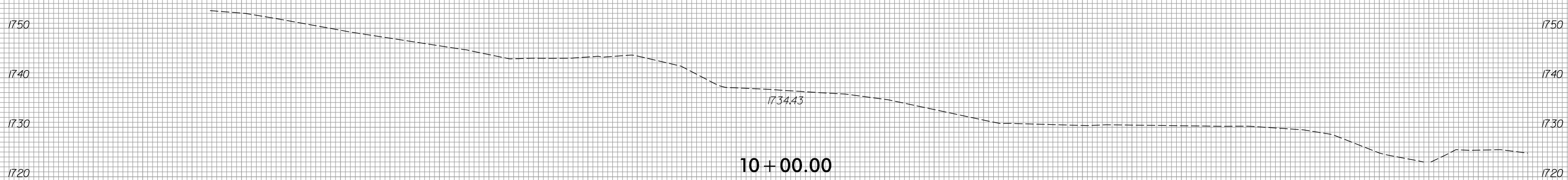

10 + 00.00

-DR14-

150 140 130 120 110 100 90 80 70 60 50 40 30 20 10 0 10 20 30 40 50 60 70 80 90 100 110 120 130 140 150

8/3/2023
R:\Roadway\XSC\XPLs\RB861\RDy.XPL_DR14.dgn
jlinson



150 140 130 120 110 100 90 80 70 60 50 40 30 20 10 0 10 20 30 40 50 60 70 80 90 100 110 120 130 140 150

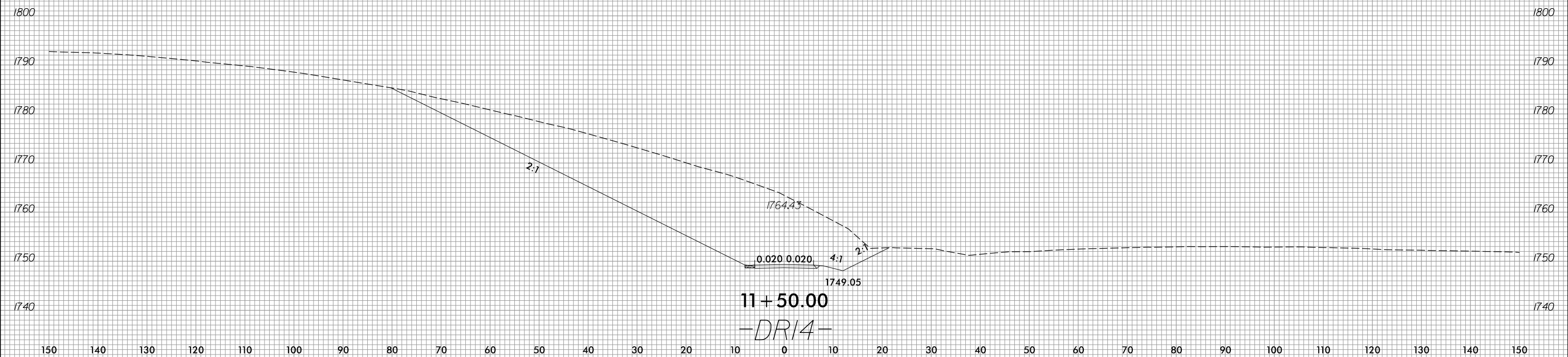
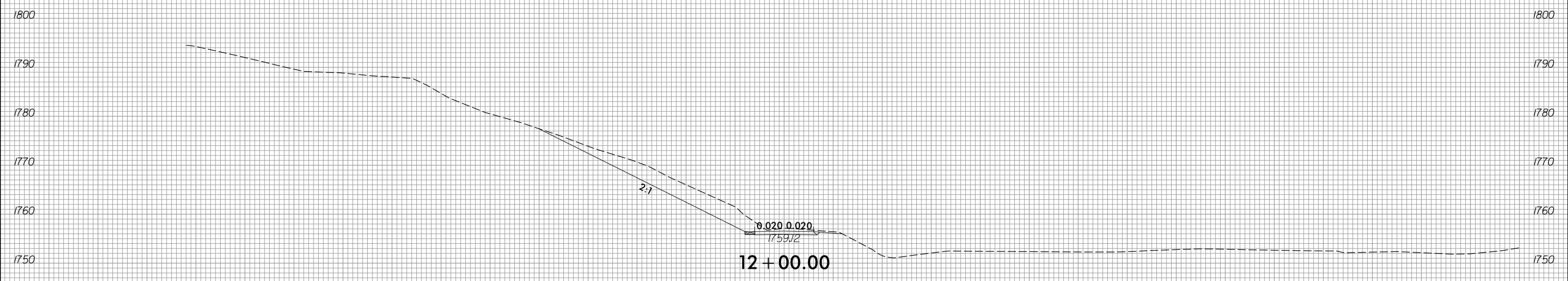
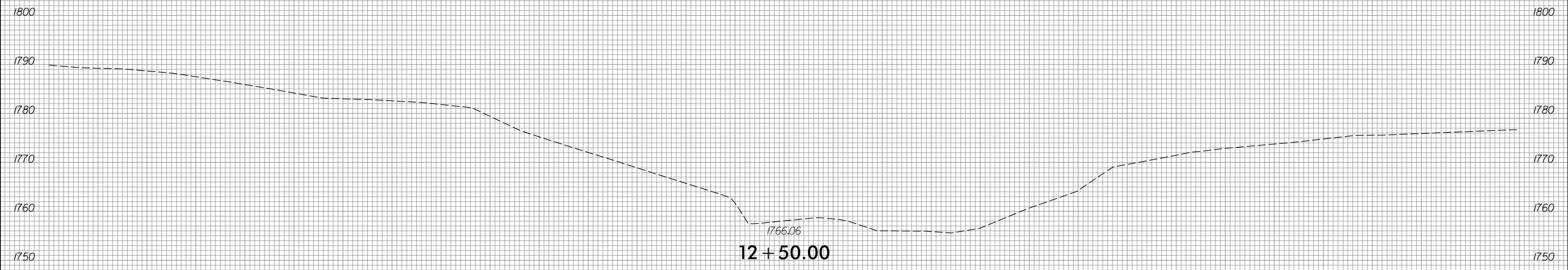

150 140 130 120 110 100 90 80 70 60 50 40 30 20 10 0 10 20 30 40 50 60 70 80 90 100 110 120 130 140 150

6/23/16



PROJ. REFERENCE NO.	SHEET NO.
R-5861	X-288

150 140 130 120 110 100 90 80 70 60 50 40 30 20 10 0 10 20 30 40 50 60 70 80 90 100 110 120 130 140 150

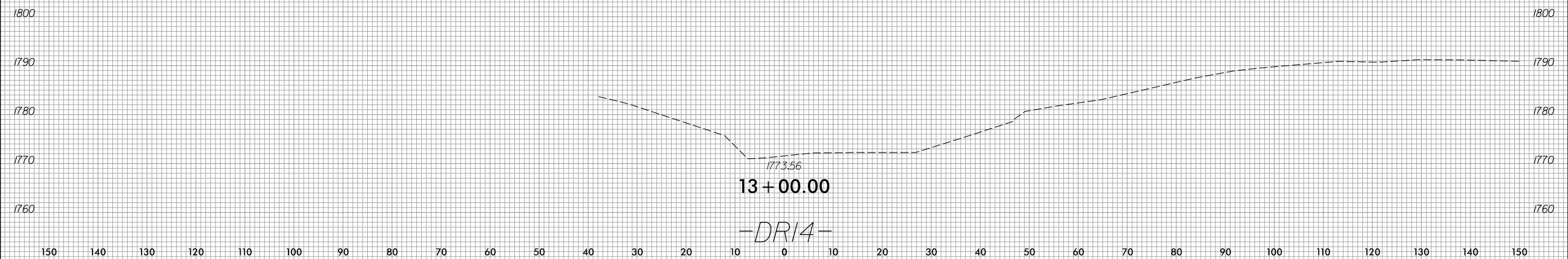

8/3/2023
 R:\Roadway\XSC\XPLs\RB861.Rdy.XPL_DR14.dgn
 jinson

6/23/16



PROJ. REFERENCE NO.	SHEET NO.
R-5861	X-289

75 70 65 60 55 50 45 40 35 30 25 20 15 10 5 0 5 10 15 20 25 30 35 40 45 50 55 60 65 70 75

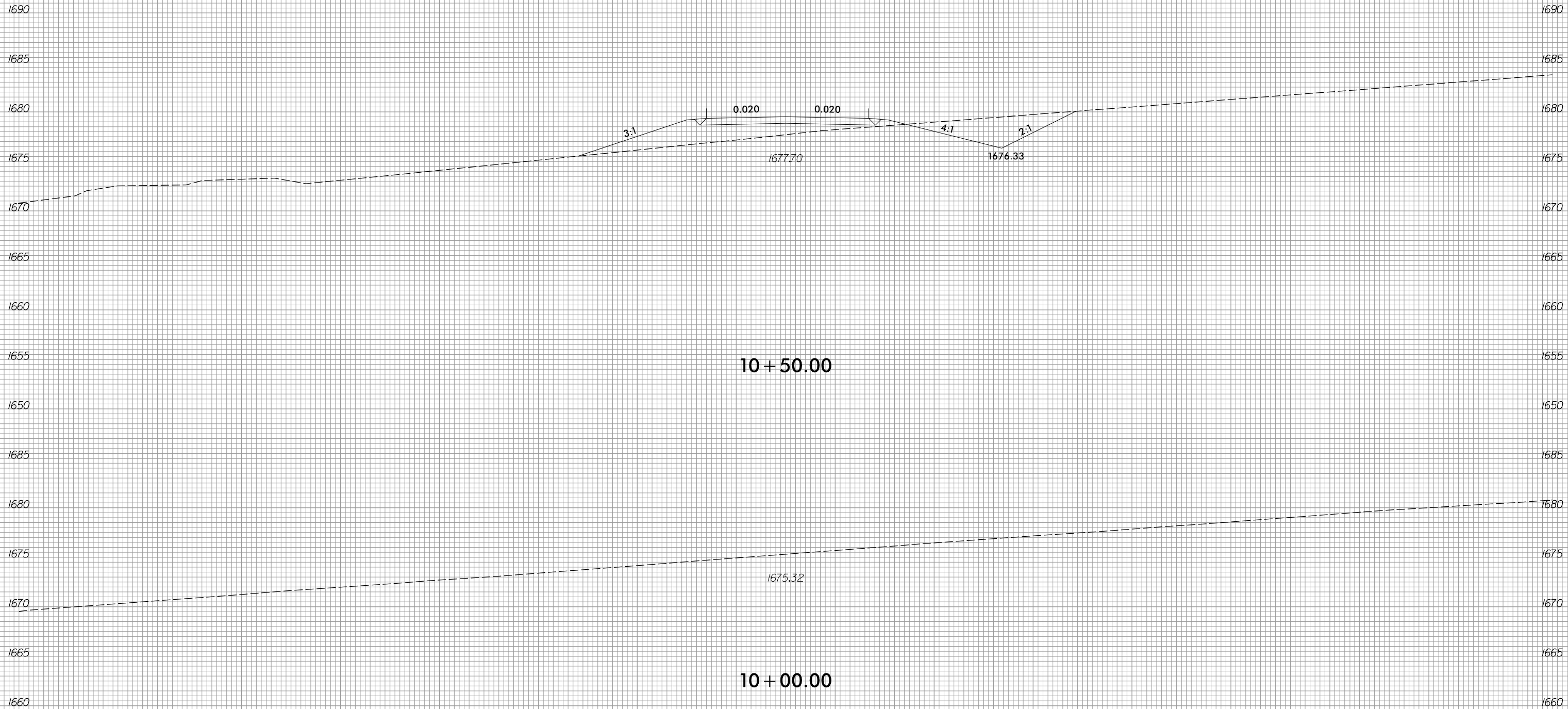

10 + 50.00

10 + 00.00

-DR15-

8/3/2023
R:\Roadway\XSC\XPLs\RB861.Rdy.XPL_DR15.dgn
jlinson

6/23/16

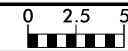

PROJ. REFERENCE NO.	SHEET NO.
R-5861	X-290

75 70 65 60 55 50 45 40 35 30 25 20 15 10 5 0 5 10 15 20 25 30 35 40 45 50 55 60 65 70 75

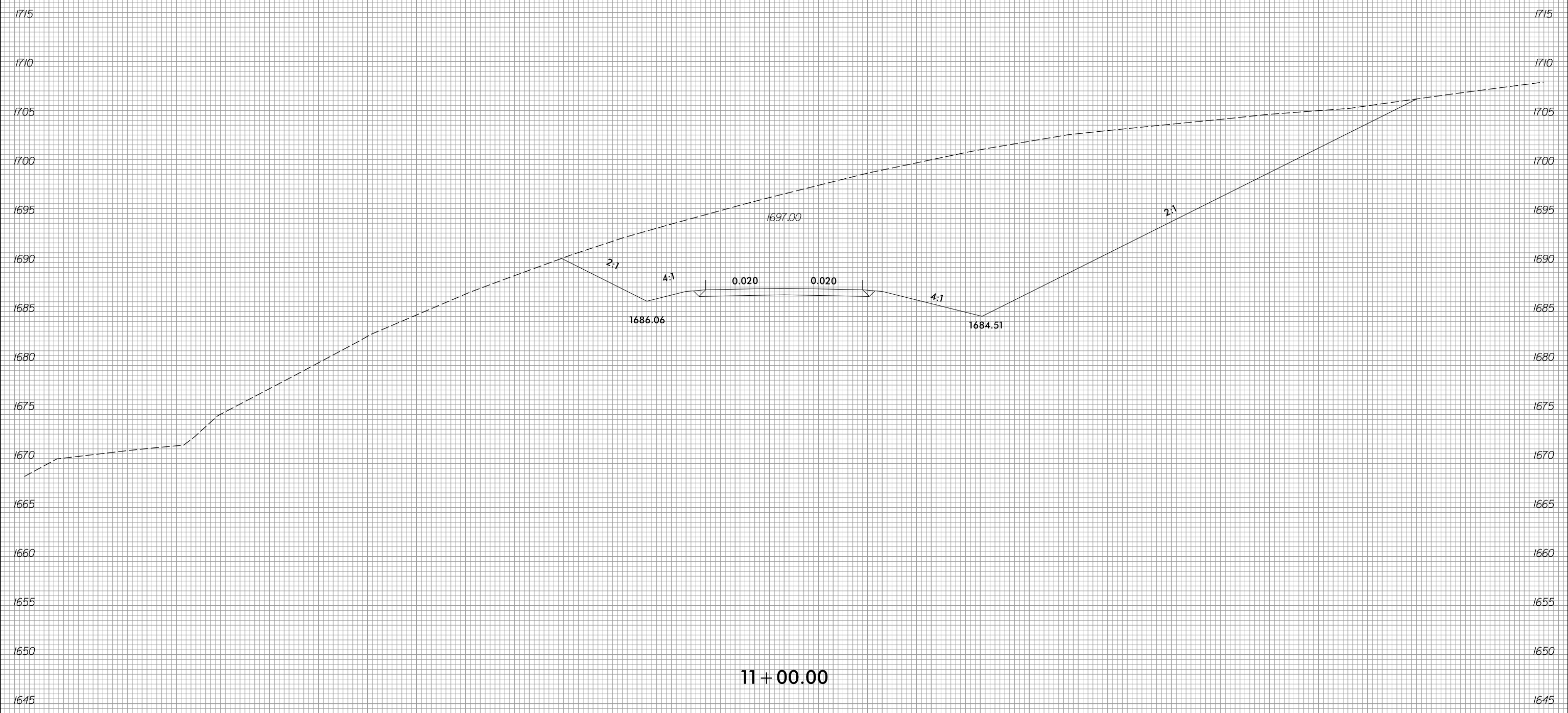

11+00.00

-DR15-

8/3/2023
R:\Roadway\XSC\XPLs\RB861.Rdy.XPL_DR15.dgn
jinson

6/23/16

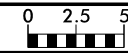

PROJ. REFERENCE NO.	SHEET NO.
R-5861	X-291

75 70 65 60 55 50 45 40 35 30 25 20 15 10 5 0 5 10 15 20 25 30 35 40 45 50 55 60 65 70 75

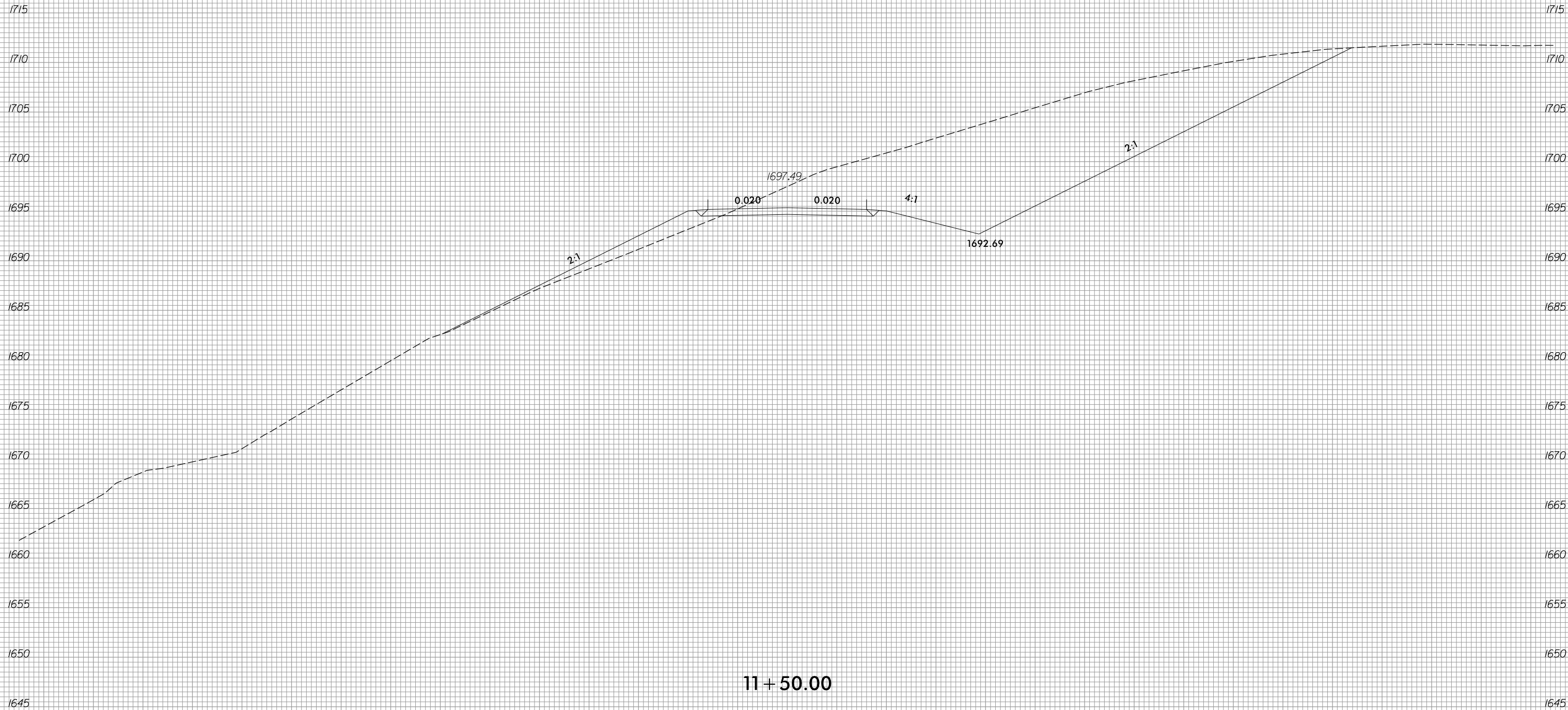

11 + 50.00

-DR15-

8/3/2023
 R:\Roadway\XSC\XPLs\RB861.Rdy.XPL_DR15.dgn
 jinson

75 70 65 60 55 50 45 40 35 30 25 20 15 10 5 0 5 10 15 20 25 30 35 40 45 50 55 60 65 70 75

6/23/16

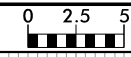

PROJ. REFERENCE NO.	SHEET NO.
R-5861	X-292

75 70 65 60 55 50 45 40 35 30 25 20 15 10 5 0 5 10 15 20 25 30 35 40 45 50 55 60 65 70 75

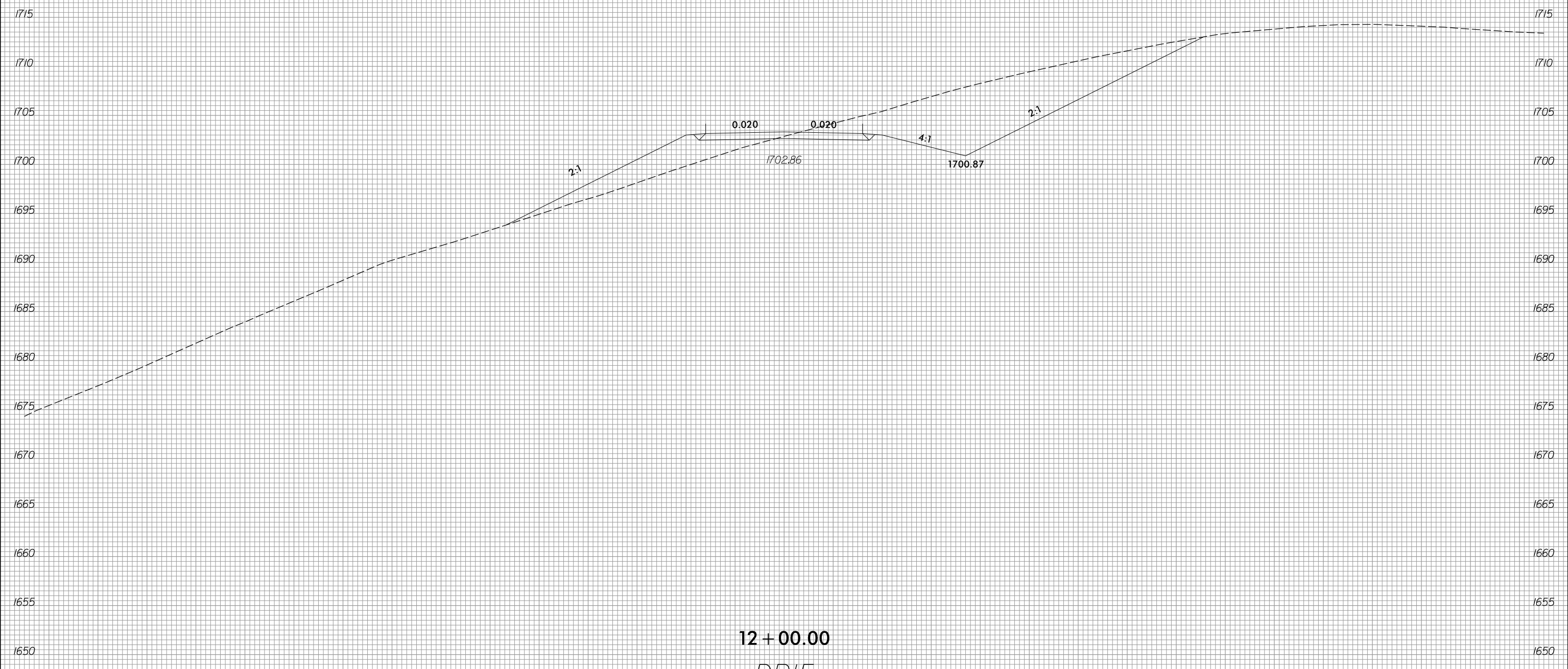

12 + 00.00

-DR15-

75 70 65 60 55 50 45 40 35 30 25 20 15 10 5 0 5 10 15 20 25 30 35 40 45 50 55 60 65 70 75

8/3/2023
R:\Roadway\XSC\XPLs\RB861.Rdy.XPL_DR15.dgn
jlinson

6/23/16

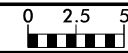

PROJ. REFERENCE NO.	SHEET NO.
R-5861	X-293

75 70 65 60 55 50 45 40 35 30 25 20 15 10 5 0 5 10 15 20 25 30 35 40 45 50 55 60 65 70 75

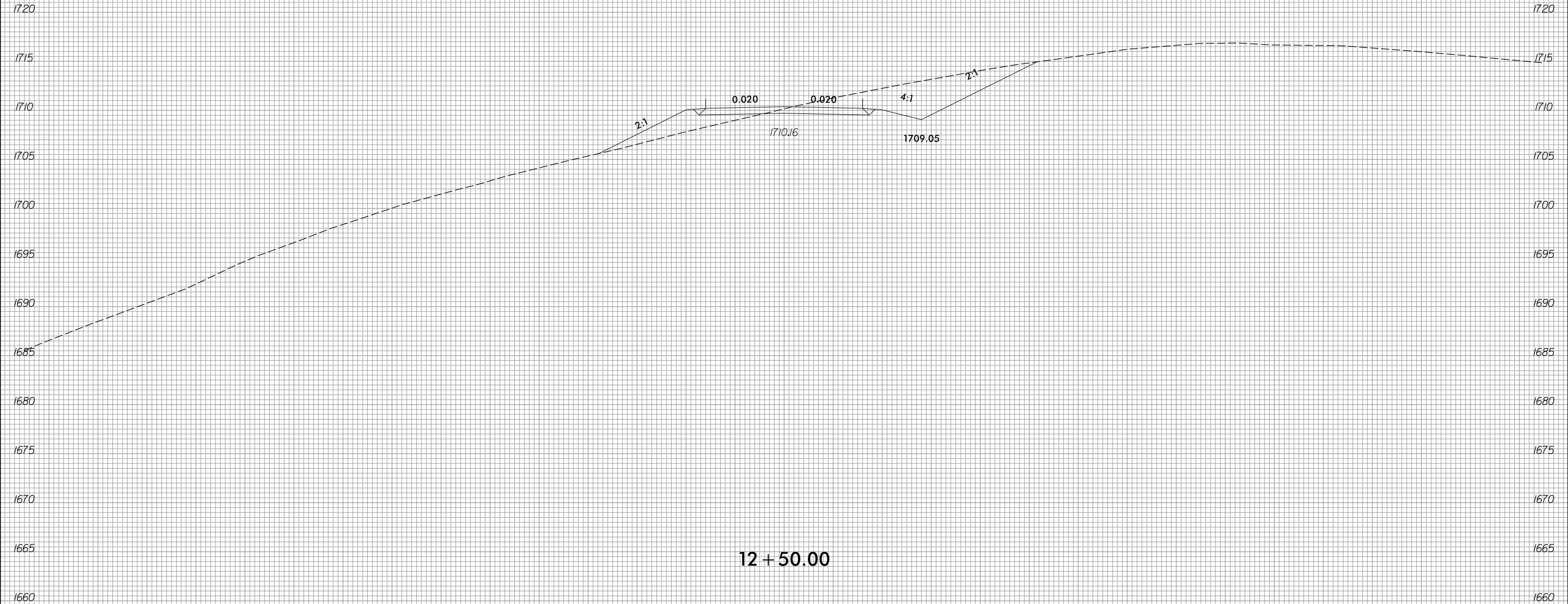

12 + 50.00

-DR15-

8/3/2023
R:\Roadway\XSC\XPLs\RB861.Rdy.XPL_DR15.dgn
jlinson

75 70 65 60 55 50 45 40 35 30 25 20 15 10 5 0 5 10 15 20 25 30 35 40 45 50 55 60 65 70 75

6/23/16

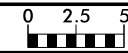

PROJ. REFERENCE NO.	SHEET NO.
R-5861	X-294

75 70 65 60 55 50 45 40 35 30 25 20 15 10 5 0 5 10 15 20 25 30 35 40 45 50 55 60 65 70 75

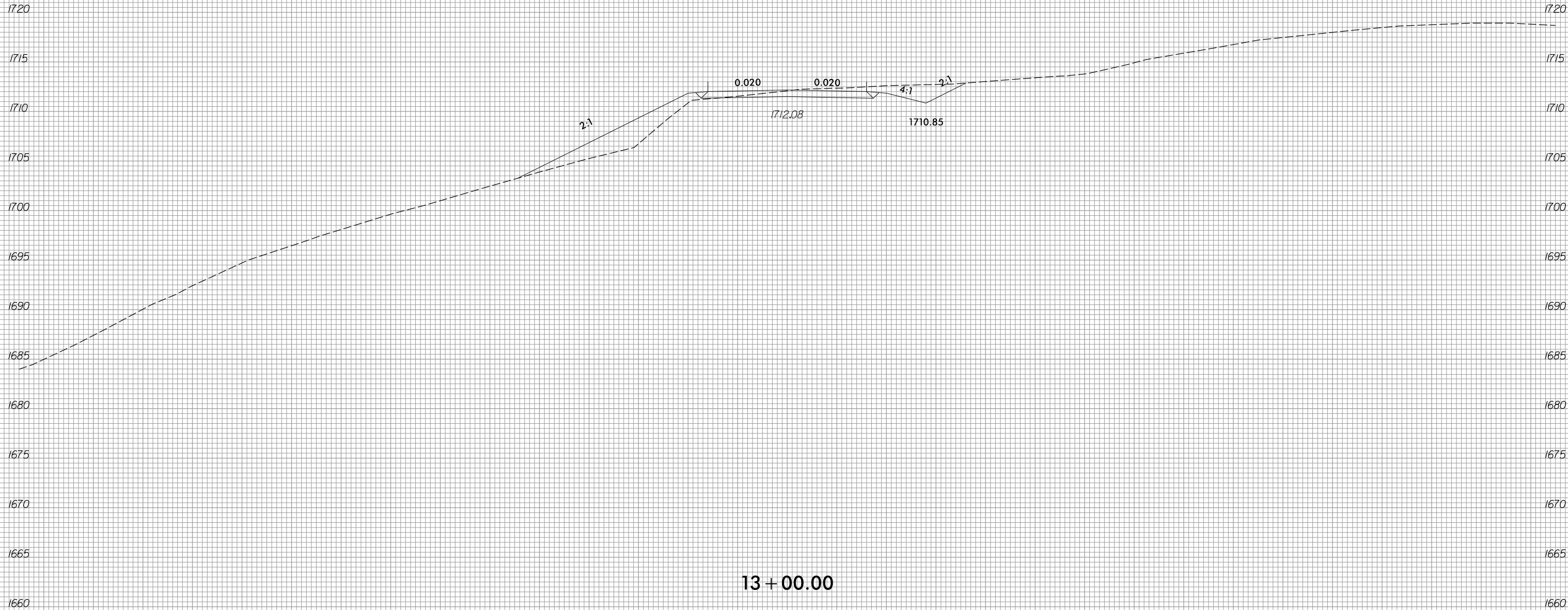

13+00.00

-DR15-

8/3/2023
R:\Roadway\XSC\XPLs\RB861.Rdy.XPL_DR15.dgn
jinson

75 70 65 60 55 50 45 40 35 30 25 20 15 10 5 0 5 10 15 20 25 30 35 40 45 50 55 60 65 70 75

6/23/16

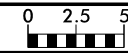

PROJ. REFERENCE NO.	SHEET NO.
R-5861	X-295

75 70 65 60 55 50 45 40 35 30 25 20 15 10 5 0 5 10 15 20 25 30 35 40 45 50 55 60 65 70 75

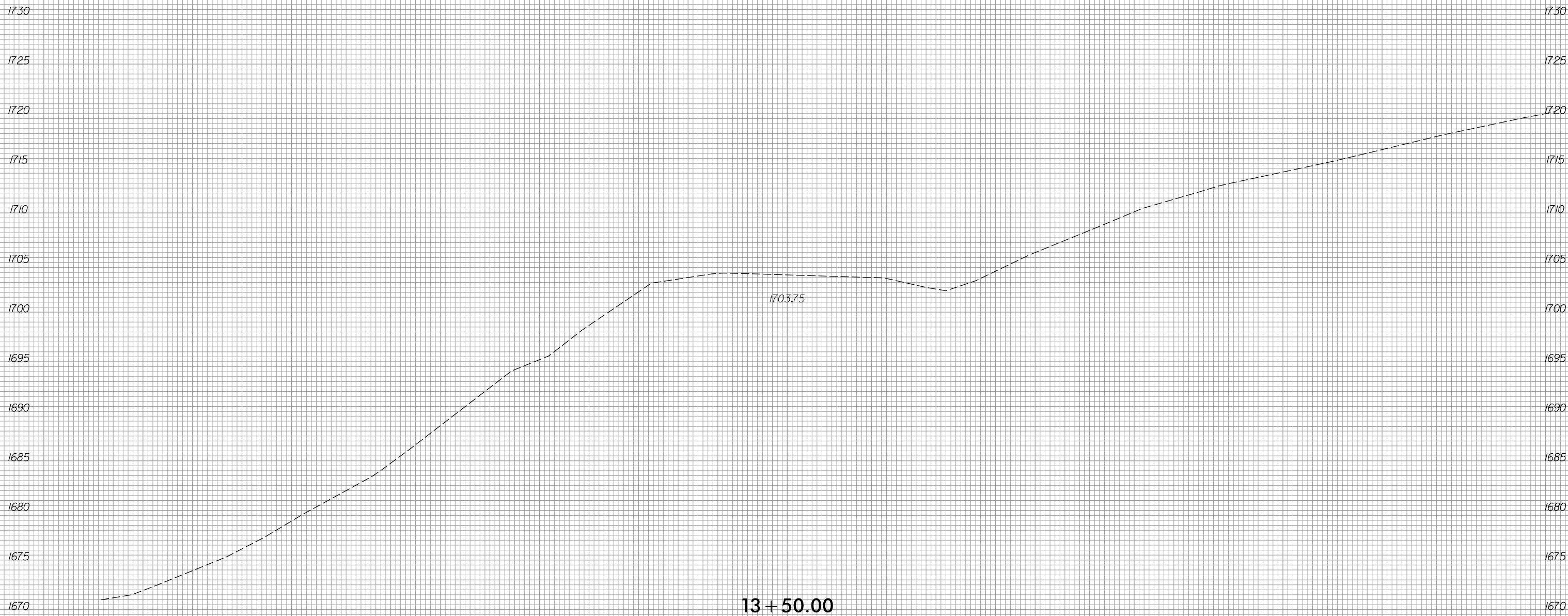

13 + 50.00

-DR15-

8/3/2023
R:\Roadway\XSC\XPLs\RB861.Rdy.XPL_DR15.dgn
jlinson

75 70 65 60 55 50 45 40 35 30 25 20 15 10 5 0 5 10 15 20 25 30 35 40 45 50 55 60 65 70 75

6/23/16

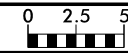

PROJ. REFERENCE NO.	SHEET NO.
R-5861	X-296

75 70 65 60 55 50 45 40 35 30 25 20 15 10 5 0 5 10 15 20 25 30 35 40 45 50 55 60 65 70 75

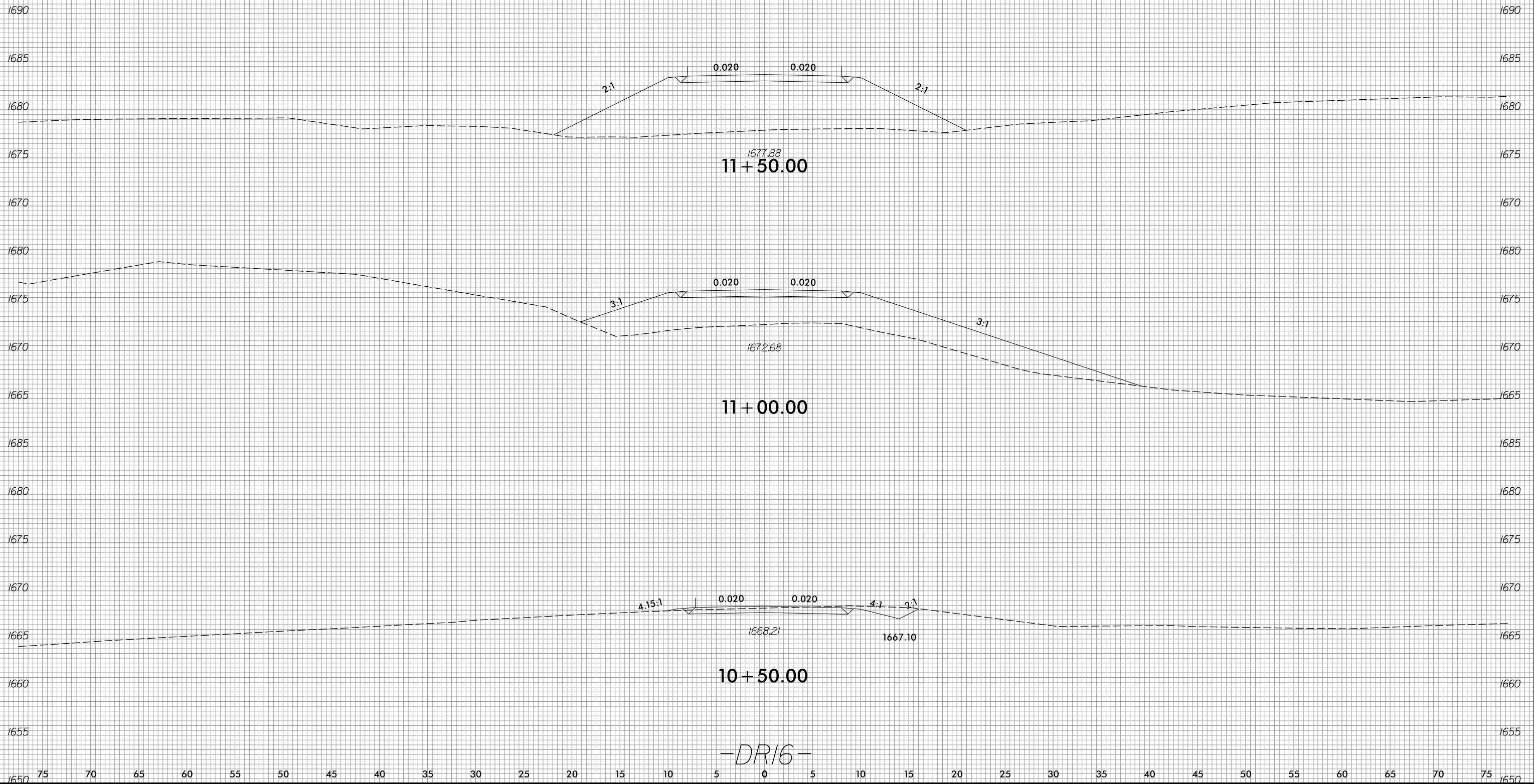

-DR16-

8/3/2023
 R:\Roadway\XSC\XPLs\RB861.Rdy.XPL_DR16.dgn
 jinson

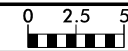

75 70 65 60 55 50 45 40 35 30 25 20 15 10 5 0 5 10 15 20 25 30 35 40 45 50 55 60 65 70 75

