

PROJECT REFERENCE NO. <b>I-5972</b>	SHEET NO. <b>SIGN-3</b>
Approved by: <i>David J. Sears</i> <small>089183P28E5741E</small> DATE: 9/19/2023	
SEAL 	
<b>DOCUMENT NOT CONSIDERED FINAL UNLESS ALL SIGNATURES COMPLETED</b>	

**401** QUANTITY REQ'D 2

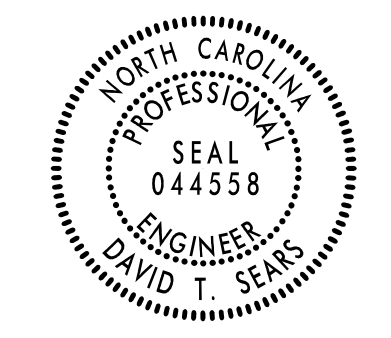
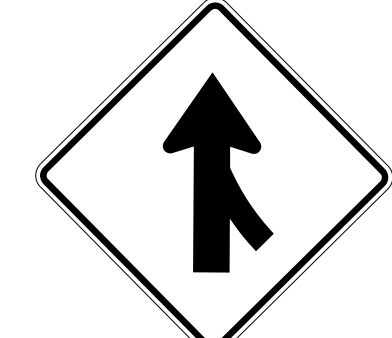

W4-1  
48" X 48"

TWO "U" CHANNEL POSTS PER SIGN

**402** QUANTITY REQ'D 1

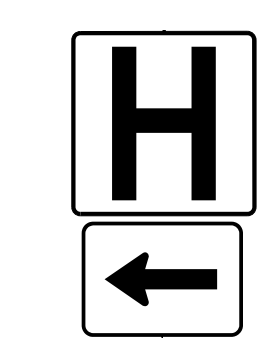

D9-2  
24" X 24"

M6-1  
21" X 15"  
COLOR : BLUE

ONE "U" CHANNEL POST

**403** QUANTITY REQ'D 4



R5-1A  
36" X 24"

ONE "U" CHANNEL POST PER SIGN

**404** QUANTITY REQ'D 2



R6-1L  
54" X 18"

MOUNT BACK TO BACK WITH  
SIGN 409 IN TWO INSTALLATIONS

**405** QUANTITY REQ'D 3



R5-1  
36" X 36"

ONE "U" CHANNEL POST PER SIGN

**406** QUANTITY REQ'D 6

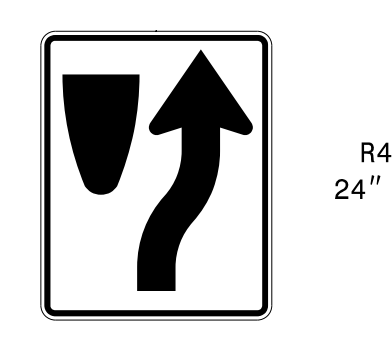

R4-7  
24" X 30"

ONE "U" CHANNEL POST PER SIGN

**407** QUANTITY REQ'D 5

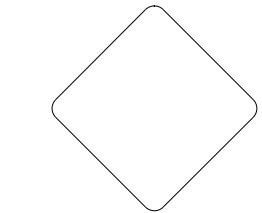

OM1-3  
18" X 18"

MOUNT BELOW SIGGN 406  
IN FIVE INSTALLATIONS

**408** QUANTITY REQ'D 1

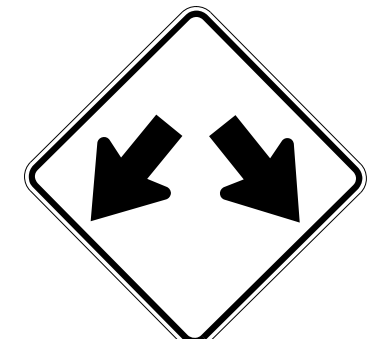

W12-1  
36" X 36"

ONE "U" CHANNEL POST

**409** QUANTITY REQ'D 3



R6-1R  
54" X 18"

TWO "U" CHANNEL POSTS PER SIGN

**410** QUANTITY REQ'D 1

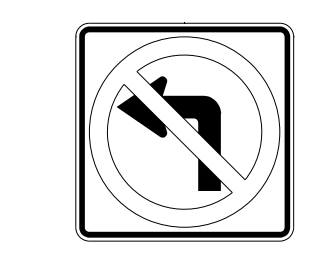

R3-2  
24" X 24"

MOUNT BELOW SIGN 406  
IN ONE INSTALLATION

**411** QUANTITY REQ'D 4



R3-7R  
36" X 36"

ONE "U" CHANNEL POST PER SIGN

**412** QUANTITY REQ'D 4



R2-1  
30" X 36"

ONE "U" CHANNEL POST PER SIGN

**413** QUANTITY REQ'D 2

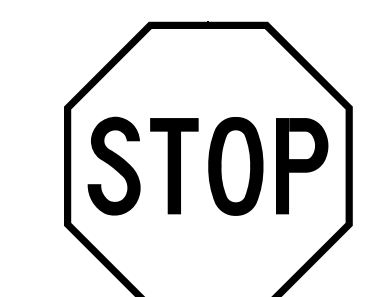

R1-1  
36" X 36"

ONE "U" CHANNEL POST PER SIGN

**414** QUANTITY REQ'D 1



W14-1  
30" X 30"

ONE "U" CHANNEL POST

**415** QUANTITY REQ'D 3

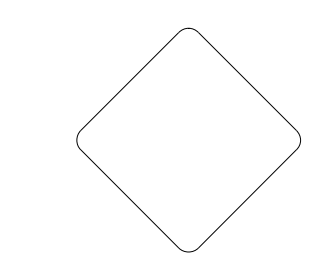

OM4-3  
18" X 18"

ONE "U" CHANNEL POST PER SIGN

**416** QUANTITY REQ'D 1

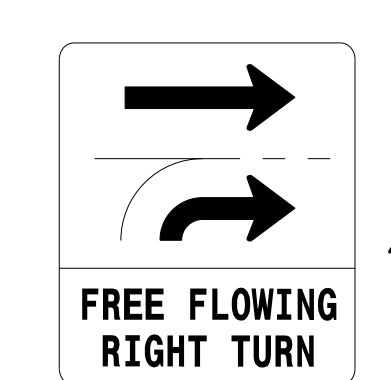

W26-S  
48" X 54"

SEE SHEET SIGN-4E FOR SIGN DESIGN

**501**



M3-3  
36" X 18"



M1-1  
36" X 36"

ONE "U" CHANNEL POST

**502**



M3-4  
24" X 12"



M3-2  
24" X 12"



M4-3  
24" X 12"



M4-3  
24" X 12"



M1-4  
24" X 24"



M1-4  
24" X 24"



M6-1  
21" X 15"



M6-1  
21" X 15"

MOUNT BELOW SIGN 301

**503**



M3-2  
24" X 12"



M4-3  
24" X 12"



M1-4  
24" X 24"

ONE "U" CHANNEL POST

**504**



M3-3  
24" X 12"



M1-1  
24" X 24"

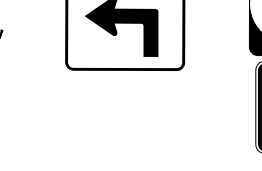

M5-1  
21" X 15"



M3-4  
24" X 12"

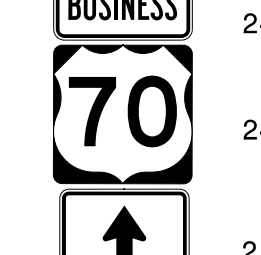

M4-3  
24" X 12"

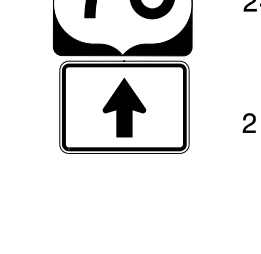

M1-4  
24" X 24"

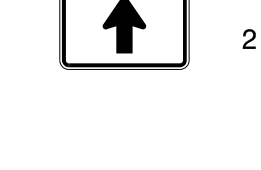

M6-3  
21" X 15"

TWO "U" CHANNEL POSTS

**505**



M3-1  
24" X 12"

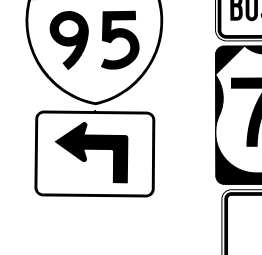

M1-1  
24" X 24"



M5-1  
21" X 15"

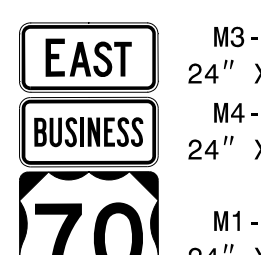

M3-2  
24" X 12"

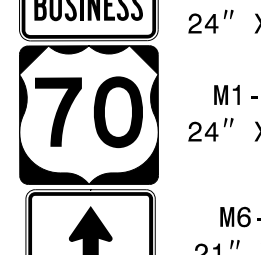

M4-3  
24" X 12"

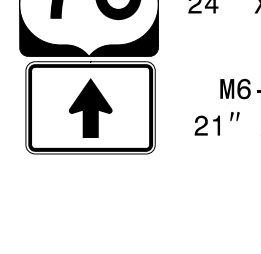

M1-4  
24" X 24"



M6-3  
21" X 15"

TWO "U" CHANNEL POSTS

**506**



M3-1  
36" X 18"



M1-1  
36" X 36"

ONE "U" CHANNEL POST

**507 508**

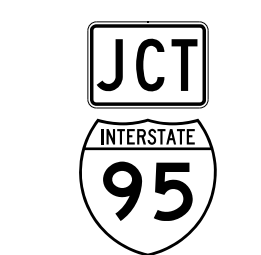

M2-1  
21" X 15"



M1-1  
24" X 24"

ONE "U" CHANNEL POST PER SIGN

**509**



M3-4  
24" X 12"



M4-3  
24" X 12"



M1-4  
24" X 24"

ONE "U" CHANNEL POST

**510**



M3-3  
24" X 12"

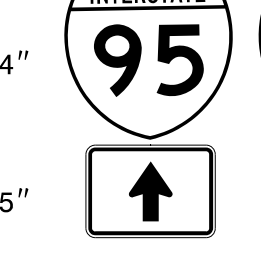

M1-1  
24" X 24"

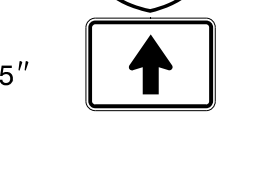

M6-3  
21" X 15"

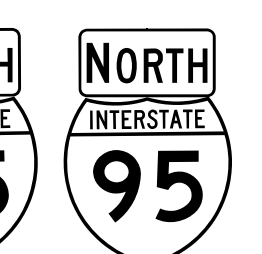

M3-1  
24" X 12"



M1-1  
24" X 24"

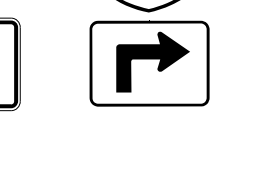

M5-1R  
21" X 15"

TWO "U" CHANNEL POSTS

**QUANTITY REQ'D 2**

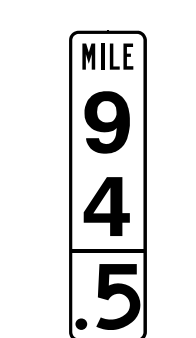

D10-2A  
12" X 48"

TO BE INSTALLED  
BACK TO BACK

ONE 3 LB. "U" CHANNEL POST

**QUANTITY REQ'D 2**

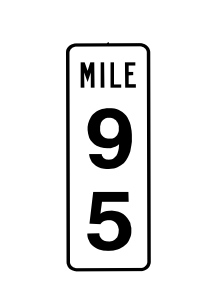

D10-2  
12" X 36"

ONE 3 LB. "U" CHANNEL POST

**TYPE 'E' & 'F' SIGNS  
& MILEMARKERS**