

PLAN SHEET 5 DITCH DETAILS

PROJECT REFERENCE NO. 1-5972	SHEET NO. DITCH DETAIL
RW SHEET NO.	
ROADWAY DESIGN ENGINEER	HYDRAULICS ENGINEER

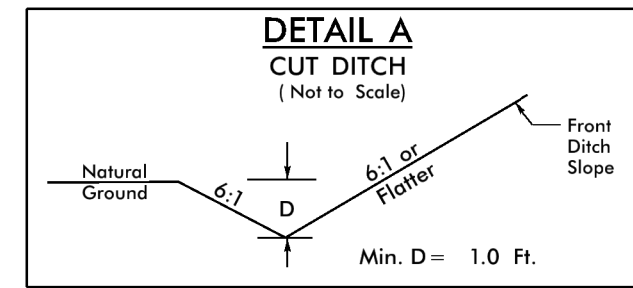

-Y1- STA. 46+00 TO STA. 53+75 LT
-Y1- STA. 46+80 TO STA. 54+50 RT

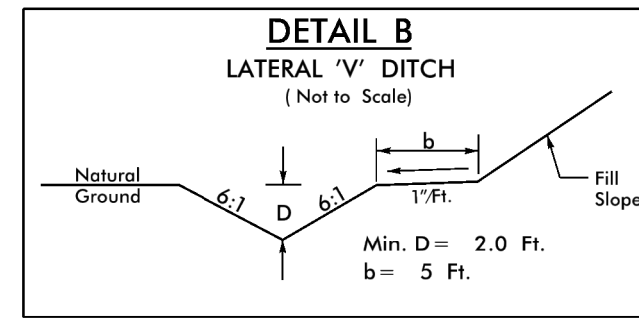

-Y1- STA. 44+50 TO STA. 46+00 LT

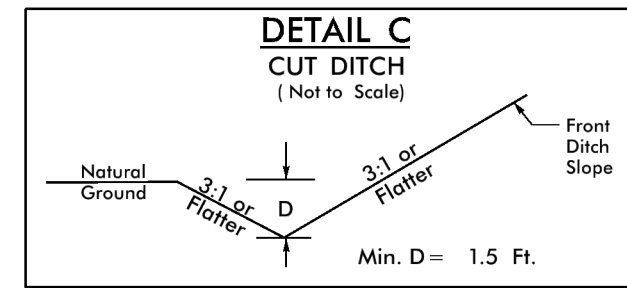

-RPD- STA. 20+50 TO STA. 29+00 LT

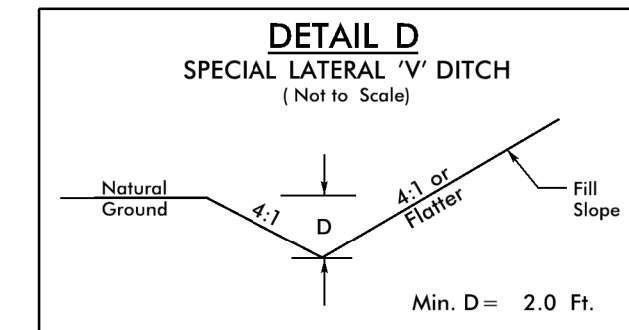

-RPC- STA. 20+00 TO STA. 24+20 LT
-RPD- STA. 29+00 TO STA. 29+25 LT

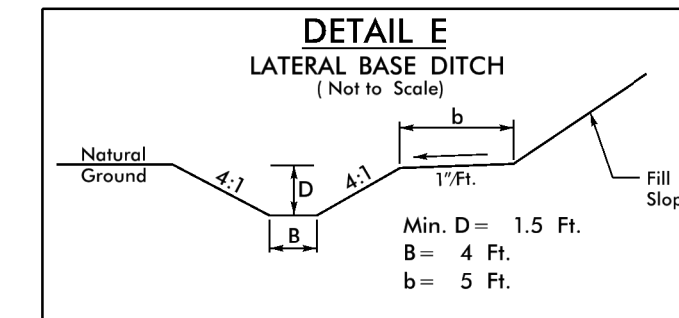

-L- STA. 61+00 TO STA. 63+32.5 LT
-RPA- STA. 19+05.65 TO STA. 21+15 RT

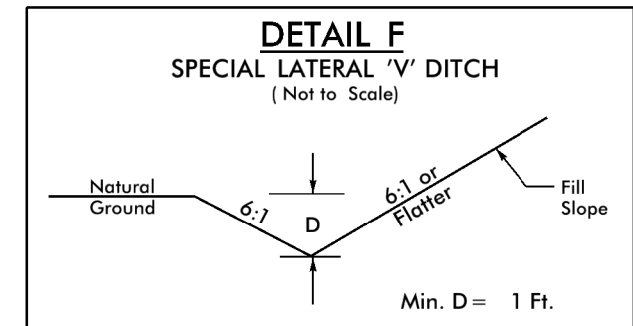

-L- STA. 46+00 TO STA. 47+00 RT
-RPC- STA. 18+00 TO STA. 20+00 LT

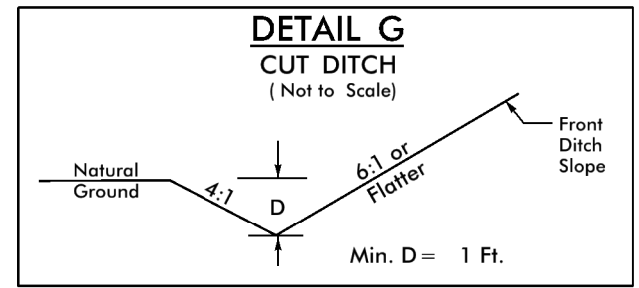

-RPB- STA. 13+90.79 TO STA. 19+00 RT
-RPC- STA. 12+00 TO STA. 15+50 LT
-RPD- STA. 18+50 TO STA. 20+50 LT
-RPD- STA. 15+50 TO STA. 21+00 RT
-Y1- STA. 45+50 TO STA. 46+65 RT

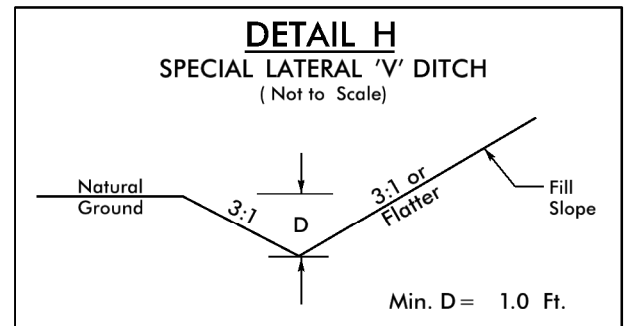

-RPD- STA. 27+50 TO STA. 29+50 RT
-Y1- STA. 39+37.5 TO STA. 41+85 LT

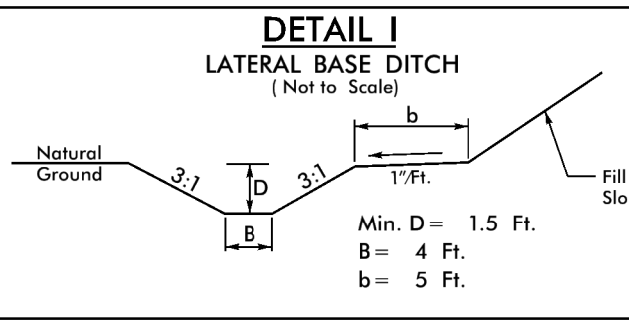

-RPC- STA. 15+50 TO STA. 18+00 LT

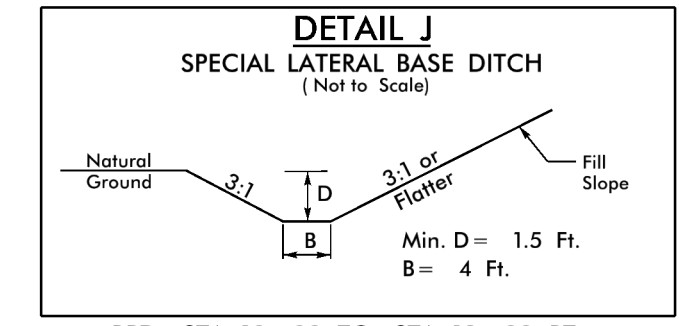

-RPD- STA. 10+00 TO STA. 13+00 RT
-Y1- STA. 32+25 TO STA. 34+54 RT

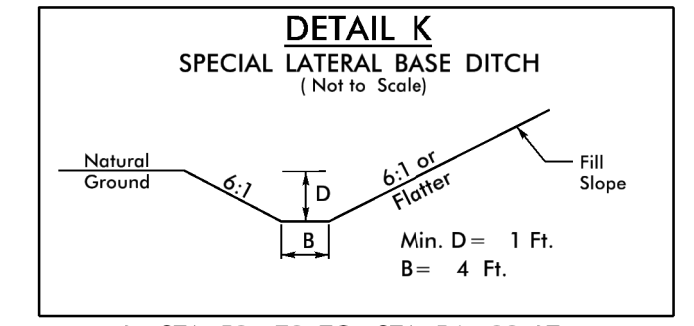

-L- STA. 50+70 TO STA. 54+00 LT

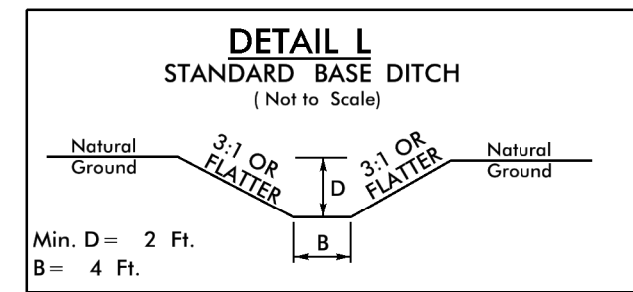

-L- STA. 54+00 RT, L=136',
BEG. EL=145.00', END EL= 144.85', S=0.10%
-L- STA. 61+00 RT, L=250',
BEG. EL=142.68', END EL= 142.61', S=0.21%
-RPC- STA. 17+10 RT, L=30',
BEG. EL=144.00', END EL=143.90', S=0.30%

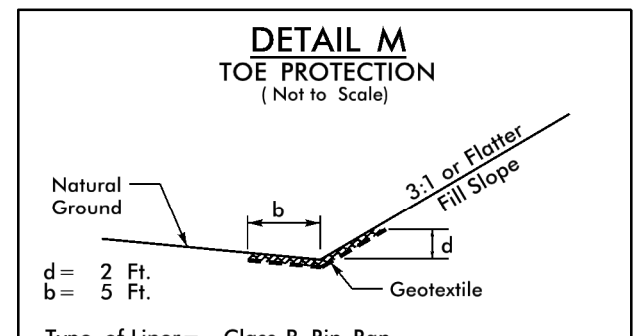

Type of Liner = Class B Rip-Rap
-Y1- FROM STA. 44+50 TO STA. 45+00 RT

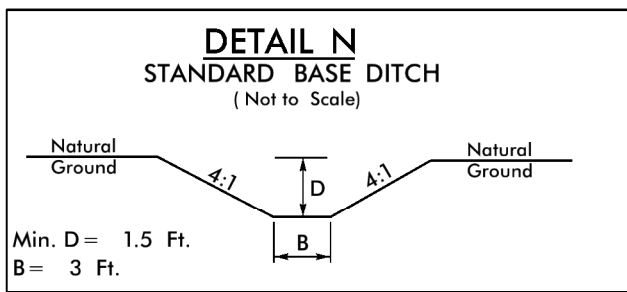

-RPA- STA. 20+75 TO STA. 21+42 LT
BEG. EL 144.34', END EL 144.14', S=0.30%
-Y1- STA. 30+50 TO STA. 31+57 LT
BEG. EL 143.69', END EL 143.68', S=0.10%

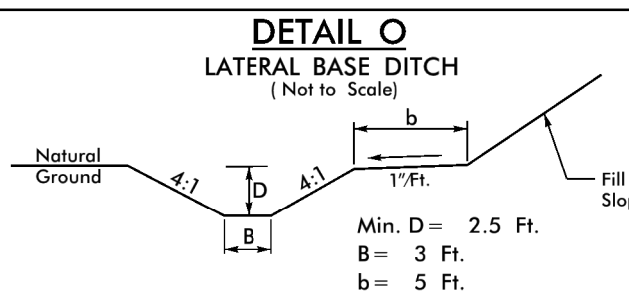

-Y1- STA. 28+50 TO STA. 30+50 LT
-Y1- STA. 32+89 TO STA. 36+75 LT
-L- STA. 57+87 TO STA. 61+00 LT

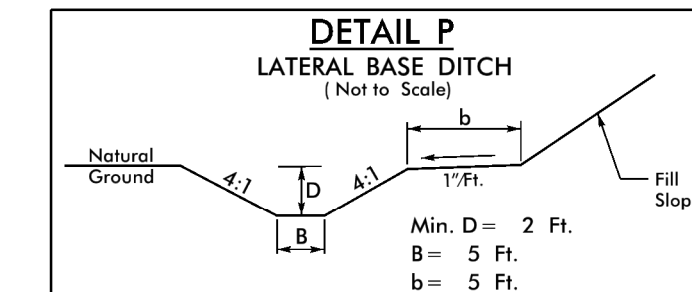

-RPD- STA. 29+25 TO STA. 29+94 LT

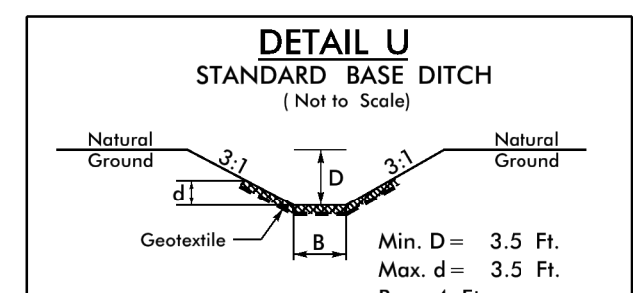

*When B is < 6.0'
Type of Liner = Class 1 Rip-Rap
-RPD- STA. 15+50 RT, L=46',
BEG. EL=143.10', END EL= 142.90', S=0.40%

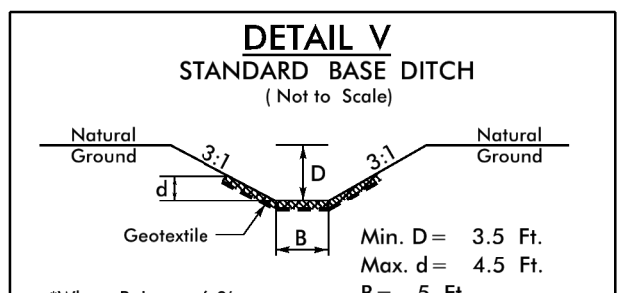

*When B is < 6.0'
Type of Liner = Class 1 Rip-Rap
-RPD- STA. 29+50 RT, L=80',
BEG. EL=141.54', END EL= 141.40', S=0.18%

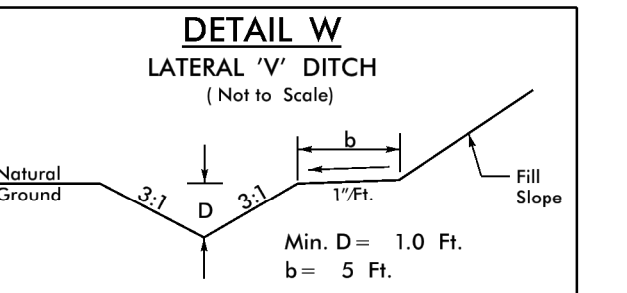

-Y1- STA. 44+50 TO STA. 45+50 RT

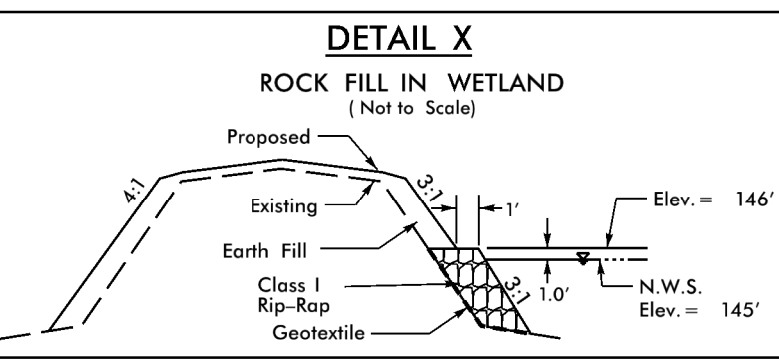

-Y1- FROM STA. 37+40 TO STA. 41+54 RT