

5/14/2019 8/19/2023 U:\Projects\18-3833C_rdy_psh06.dgn

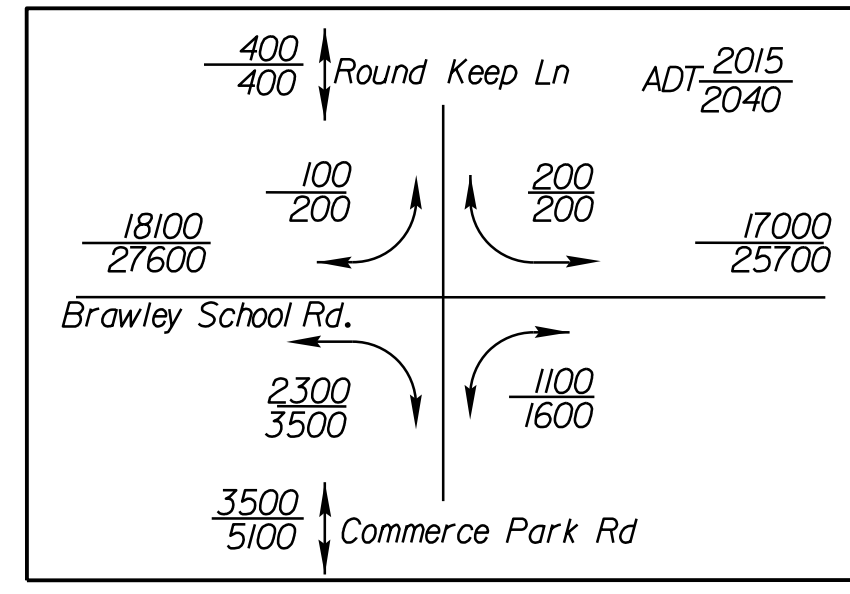
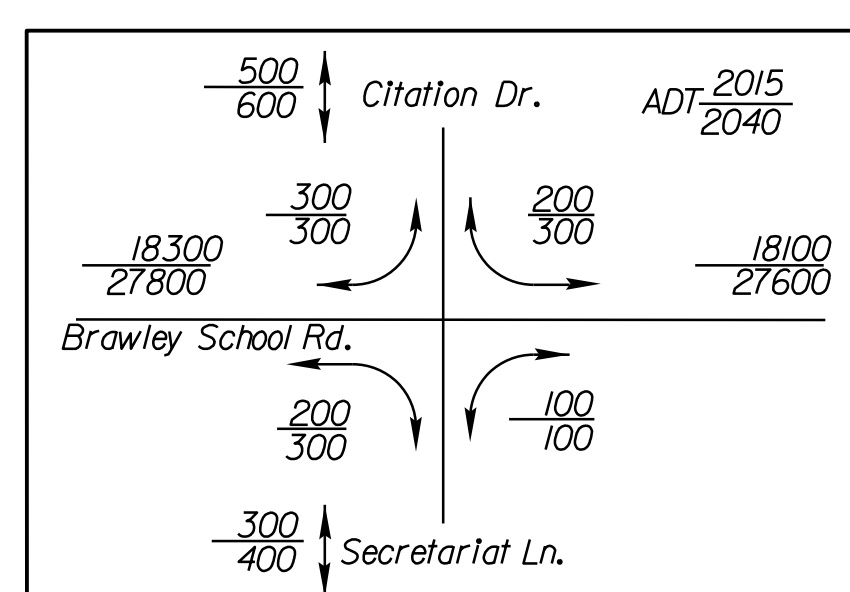

-L-		
PI Sta 38+56.09	PI Sta 47+51.10	PI Sta 56+10.32
$\Delta = 46^\circ 35' 27.8''$ (LT)	$\Delta = 55^\circ 20' 14.2''$ (LT)	$\Delta = 59^\circ 26' 02.5''$ (RT)
$D = 5^\circ 43' 46.5''$	$D = 7^\circ 38' 22.0''$	$D = 7^\circ 38' 22.0''$
$L = 813.17'$	$L = 724.36'$	$L = 777.99'$
$T = 430.58'$	$T = 393.24'$	$T = 428.09'$
$R = 1,000.00'$	$R = 750.00'$	$R = 750.00'$
$SE = .04$	$SE = .04$	$SE = .04$
$INC = 49'$	$INC = 49'$	$INC = 49'$

-Y3-	
PI Sta 10+70.41	PI Sta 12+80.38
$\Delta = 27^\circ 38' 58.0''$ (RT)	$\Delta = 29^\circ 20' 09.7''$ (LT)
$D = 24^\circ 45' 47.2''$	$D = 25^\circ 27' 53.2''$
$L = 111.66'$	$L = 115.20'$
$T = 56.94'$	$T = 58.89'$
$R = 231.38'$	$R = 225.00'$
$SE = SEE PLANS$	$SE = SEE PLANS$
$INC = 10'$	$INC = 10'$

-Y4-	
PI Sta 11+75.35	
$\Delta = 43^\circ 28' 09.6''$ (RT)	
$D = 31^\circ 43' 24.8''$	
$L = 137.03'$	
$T = 72.00'$	
$R = 180.61'$	
$SE = SEE PLANS$	
$INC = 18'$	

FOR -L- PROFILE SEE SHEET 13
FOR -Y3- PROFILE SEE SHEET 17
FOR -Y4- PROFILE SEE SHEET 18
FOR -Y6- PROFILE SEE SHEET 18
FOR -Y7- PROFILE SEE SHEET 18

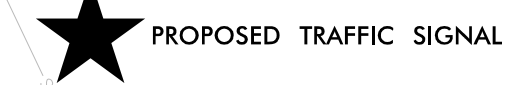

PROJECT REFERENCE NO. R-3833C	SHEET NO. 06
ROADWAY DESIGN ENGINEER A. Dean Sahvis	HYDRAULICS ENGINEER Benjamin J. Henchrich
8/21/2023	8/21/2023
DOCUMENT NOT CONSIDERED FINAL UNLESS ALL SIGNATURES COMPLETED	

Stantec
Stantec Consulting Services Inc.
801 Jones Franklin Road
Suite 300
Raleigh, NC 27606
Tel. (919) 851-6866
Fax. (919) 851-7024
www.stantec.com
License No. F-0672

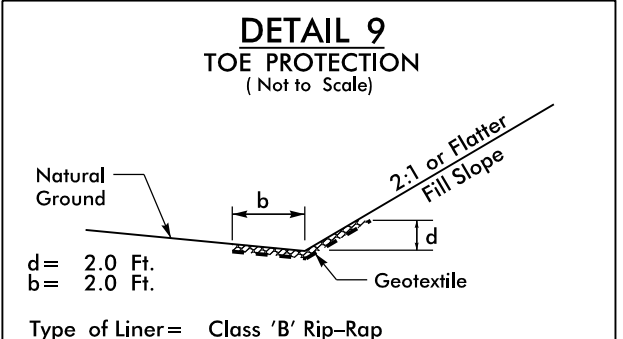
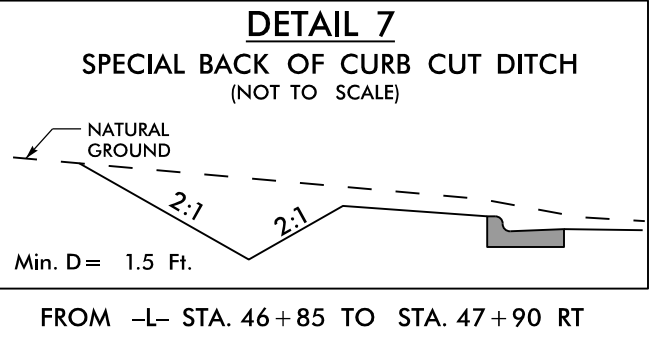

-Y5-	
PI Sta 11+71.17	
$\Delta = 53^\circ 12' 03.0''$ (LT)	
$D = 37^\circ 12' 18.2''$	
$L = 142.99'$	
$T = 77.12'$	
$R = 154.00'$	
$SE = SEE PLANS$	
$INC = 18'$	

-Y7-	
PI Sta 11+15.22	
$\Delta = 33^\circ 58' 21.8''$ (LT)	
$D = 19^\circ 26' 48.7''$	
$L = 174.70'$	
$T = 90.00'$	
$R = 294.63'$	
$SE = .04$	
$INC = N/A$	

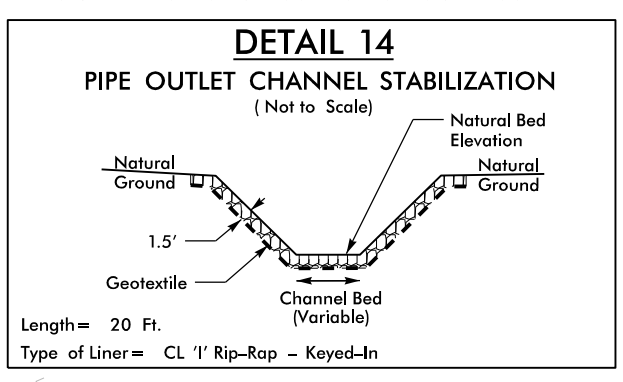

BEGIN CONSTRUCTION
-Y6- POT STA. 11+70.00

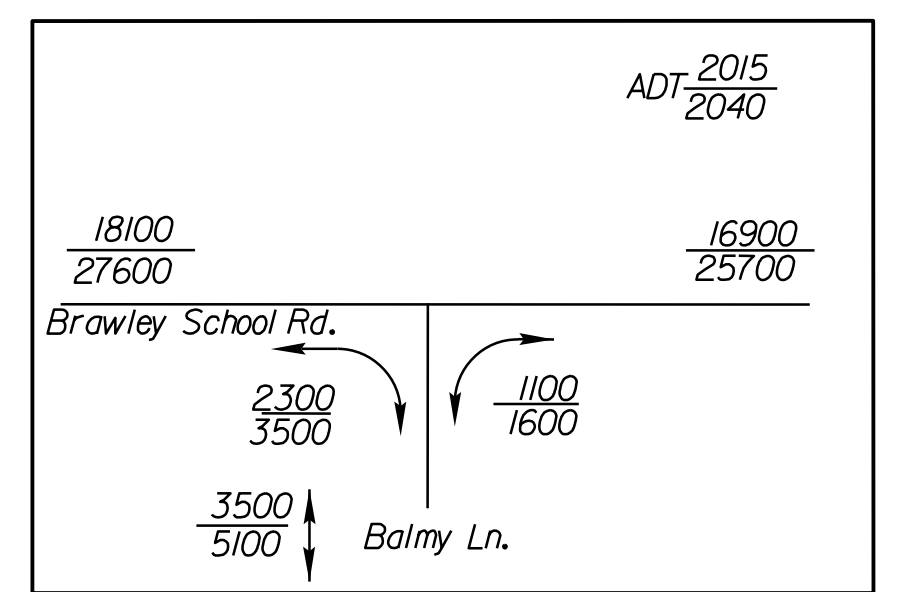
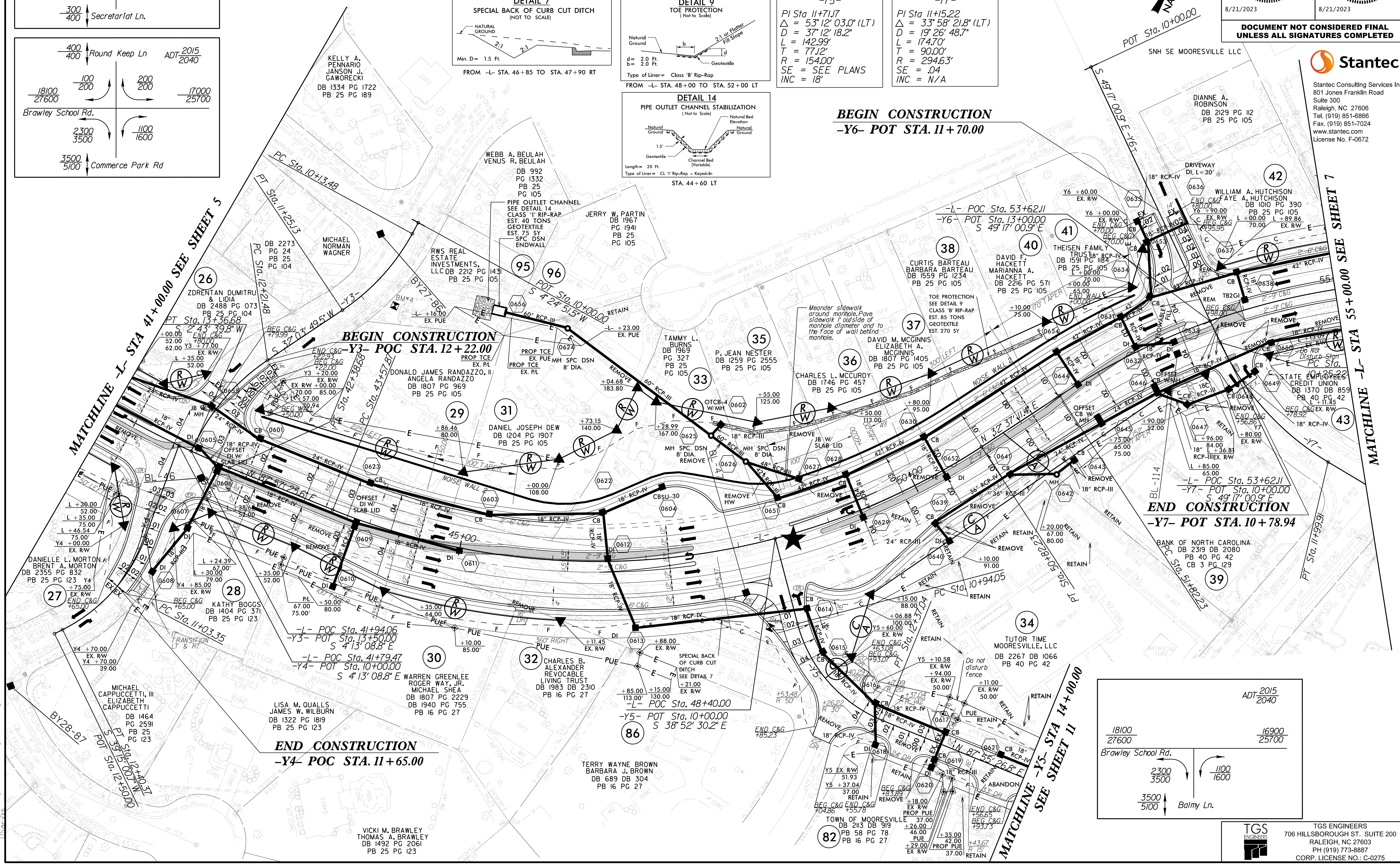

TGS ENGINEERS
706 HILLSBOROUGH ST., SUITE 200
RALEIGH, NC 27603
PH (919) 773-8887
CORP. LICENSE NO.: C-0275