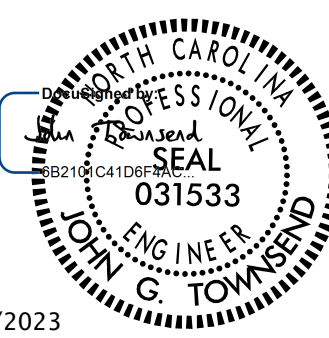

T.I.P.: U-5312

CONTRACT: C204841

**STATE OF NORTH CAROLINA
DEPARTMENT OF TRANSPORTATION**

**PAVEMENT MARKING PLAN
WILKES COUNTY**

TIP NO. U-5312	SHEET NO. PMP-1
APPROVED: _____	
DATE: _____	
	
7/13/2023	
DOCUMENT NOT CONSIDERED FINAL UNLESS ALL SIGNATURES COMPLETED	

INDEX	
SHEET NO.	DESCRIPTION
PMP-1	PAVEMENT MARKING PLAN TITLE AND SCHEDULE SHEET
PMP-6-16	PAVEMENT MARKING DETAIL

GENERAL NOTES

THE FOLLOWING GENERAL NOTES APPLY AT ALL TIMES FOR THE DURATION OF THE CONSTRUCTION PROJECT, EXCEPT WHEN OTHERWISE NOTED IN THE PLAN, OR DIRECTED BY THE ENGINEER.

A) INSTALL PAVEMENT MARKINGS AND PAVEMENT MARKERS ON THE FINAL SURFACE AS FOLLOWS:

ROAD NAME	MARKING	MARKER
-L-	THERMOPLASTIC	SNOWPLOWABLE
-Y- LINES	THERMOPLASTIC	SNOWPLOWABLE

B) TIE PROPOSED PAVEMENT MARKING LINES TO EXISTING PAVEMENT MARKING LINES.

C) REMOVE/REPLACE ANY CONFLICTING/DAMAGED PAVEMENT MARKINGS AND MARKERS.

D) STOP BAR LOCATION AT NON-SIGNALIZED INTERSECTIONS MAY BE ADJUSTED AS DIRECTED BY THE ENGINEER.

E) UNLESS OTHERWISE SPECIFIED, HEATED-IN-PLACE THERMOPLASTIC MAY BE USED IN LIEU OF EXTRUDED THERMOPLASTIC FOR STOP BARS, SYMBOLS, CHARACTERS AND DIAGONALS. IF HEATED-IN-PLACE IS USED, IT SHALL BE PAID FOR USING THE EXTRUDED THERMOPLASTIC PAY ITEM.

PAVEMENT MARKING SCHEDULE		
SYMBOL	ITEM DESCRIPTION	TOTAL QUANTITY
	<u>THERMOPLASTIC (4", 90 MILS.)</u>	
T1	WHITE EDGELINE	32325 FT
T2	WHITE SOLID LANE LINE	3890 FT
T3	10 FT. WHITE SKIP	7705 FT
T4	3 FT. - 9 FT./SP WHITE MINISKIP	1805 FT
T5	2 FT. - 6 FT./SP WHITE MINISKIP	1265 FT
T10	YELLOW EDGELINE	14690 FT
T11	YELLOW SOLID LANE LINE	255 FT
T12	10 FT. YELLOW SKIP	255 FT
T13	YELLOW DOUBLE CENTER	6310 FT
T14	2 FT. - 6 FT./SP YELLOW MINISKIP	325 FT
	<u>THERMOPLASTIC (8", 90 MILS.)</u>	
T40	WHITE GORELINE	11720 FT
T41	WHITE DIAGONAL	1445 FT
T42	YELLOW DIAGONAL	490 FT
T46	WHITE CROSSWALK LINE	1070 FT
	<u>THERMOPLASTIC (24", 90 MILS.)</u>	
T61	WHITE STOPBAR	1310 FT
	<u>THERMOPLASTIC PAVEMENT MARKING SYMBOLS (90 MILS.)</u>	
T70	LEFT TURN ARROW	43 EA
T71	RIGHT TURN ARROW	40 EA
T72	STRAIGHT ARROW	29 EA
T74	COMBO. STRAIGHT/RIGHT	1 EA
T77	U-TURN ARROW	30 EA
	<u>PERMANENT PAVEMENT MARKERS (SNOWPLOWABLE)</u>	
ME	YELLOW & YELLOW	50 EA
MF	CRYSTAL & RED	1120 EA

ROADWAY STANDARD DRAWING

THE FOLLOWING ROADWAY STANDARDS AS APPEAR IN "ROADWAY STANDARD DRAWINGS" - PROJECT SERVICES UNIT - N.C. DEPARTMENT OF TRANSPORTATION - RALEIGH, N.C., DATED JANUARY 2018 ARE APPLICABLE TO THIS PROJECT AND BY REFERENCE HEREBY ARE CONSIDERED A PART OF THESE PLANS:

STD. NO.	TITLE
1205.01	PAVEMENT MARKINGS - LINE TYPES AND OFFSETS
1205.02	PAVEMENT MARKINGS - TWO-LANE AND MULTILANE ROADWAYS
1205.04	PAVEMENT MARKINGS - INTERSECTIONS
1205.05	PAVEMENT MARKINGS - TURN LANES
1205.07	PAVEMENT MARKINGS - PEDESTRIAN CROSSWALKS
1205.08	PAVEMENT MARKINGS - SYMBOLS AND WORD MESSAGES
1205.09	PAVEMENT MARKINGS - PAINTED ISLANDS
1205.15	PAVEMENT MARKINGS - SUPERSTREETS
1250.01	RAISED PAVEMENT MARKERS - INSTALLATION SPACING
1253.01	RAISED PAVEMENT MARKERS - SNOWPLOWABLE
1261.01	GUARDRAIL AND BARRIER DELINEATORS - INSTALLATION SPACING
1261.02	GUARDRAIL AND BARRIER DELINEATORS - TYPES AND MOUNTING
1262.01	GUARDRAIL END DELINEATION

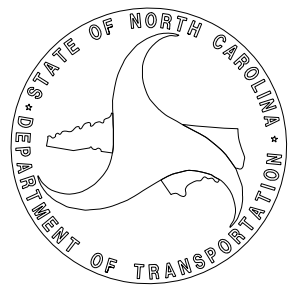
PLAN SUBMITTED TO:	
<u>Ramie Shaw, PE</u>	

PLAN PREPARED BY: VHB Engineering NC, P.C.	
<u>John G. Townsend, PE</u> PROJECT ENGINEER	Venture I 940 Main Campus Drive, Suite 500 Raleigh, NC 27606 NC License No. C-3705 919.829.0328

APPROVED: _____
 DATE: _____

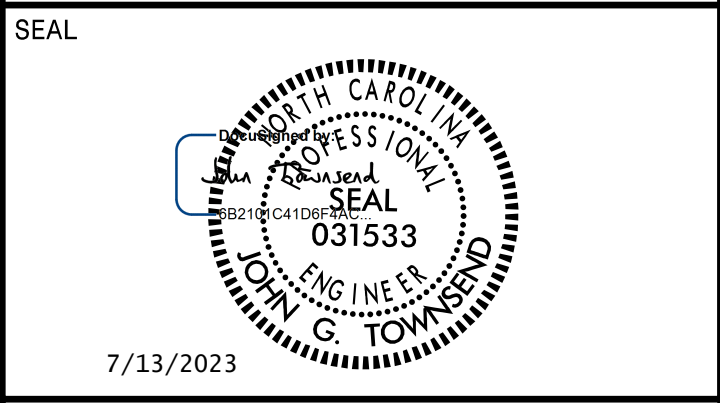

**DOCUMENT NOT CONSIDERED FINAL
 UNLESS ALL SIGNATURES COMPLETED**



940 Main Campus Drive, Suite 500 Raleigh, NC 27606
 NC License No. C-3705

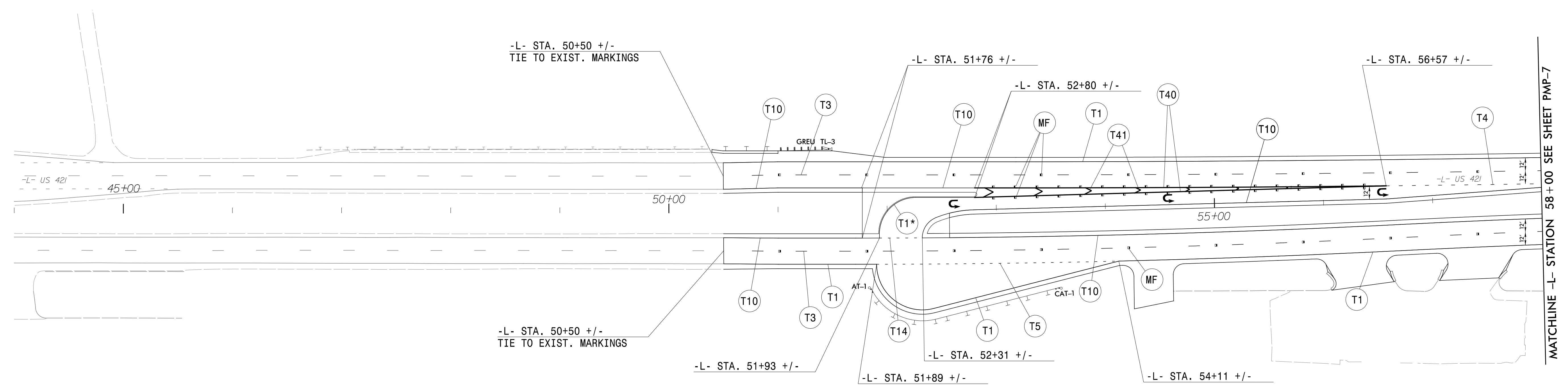

PAVEMENT MARKING SCHEDULE

SYMBOL	DESCRIPTION
T1	WHITE EDGELINE (4", 90 MIL)
T2	WHITE SOLID LANE LINE (4", 90 MIL)
T3	10 FT. WHITE SKIP (4", 90 MIL)
T4	3 FT.-9 FT./SP WHITE MINISKIP (4", 90 MIL)
T5	2 FT.-6 FT./SP WHITE MINISKIP (4", 90 MIL)
T10	YELLOW EDGELINE (4", 90 MIL)
T11	YELLOW SINGLE CENTER (4", 90 MIL)
T12	10 FT. YELLOW SKIP (4", 90 MIL)
T13	YELLOW DOUBLE CENTER (4", 90 MIL)
T14	2 FT.-6 FT./SP YELLOW MINISKIP (4", 90 MIL)
T40	WHITE GORELINE (8", 90 MIL)
T41	WHITE DIAGONAL (8", 90 MIL)
T42	YELLOW DIAGONAL (8", 90 MIL)
T46	WHITE CROSSWALK LINE (8", 90 MIL)
T61	WHITE STOPBAR (24", 90 MIL)
→	LEFT TURN ARROW (90 MIL)
↘	RIGHT TURN ARROW (90 MIL)
→↘	STRAIGHT ARROW (90 MIL)
↘→	COMBO.STRAIGHT/RIGHT (90 MIL)
↻	U-TURN ARROW (90 MIL)
ME	SNOWPLOWABLE MARKER (YELLOW & YELLOW)
MF	SNOWPLOWABLE MARKER (CRYSTAL & RED)

* EDGELINE OFFSET 0.75' FROM FACE OF CURB/ISLAND

PAVEMENT MARKING DETAIL

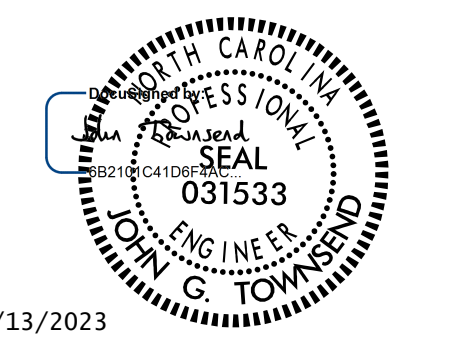
TIP NO. U-5312	SHEET NO. PMP-7
APPROVED: _____	
DATE: _____	
SEAL	
	
7/13/2023	
DOCUMENT NOT CONSIDERED FINAL UNLESS ALL SIGNATURES COMPLETED	

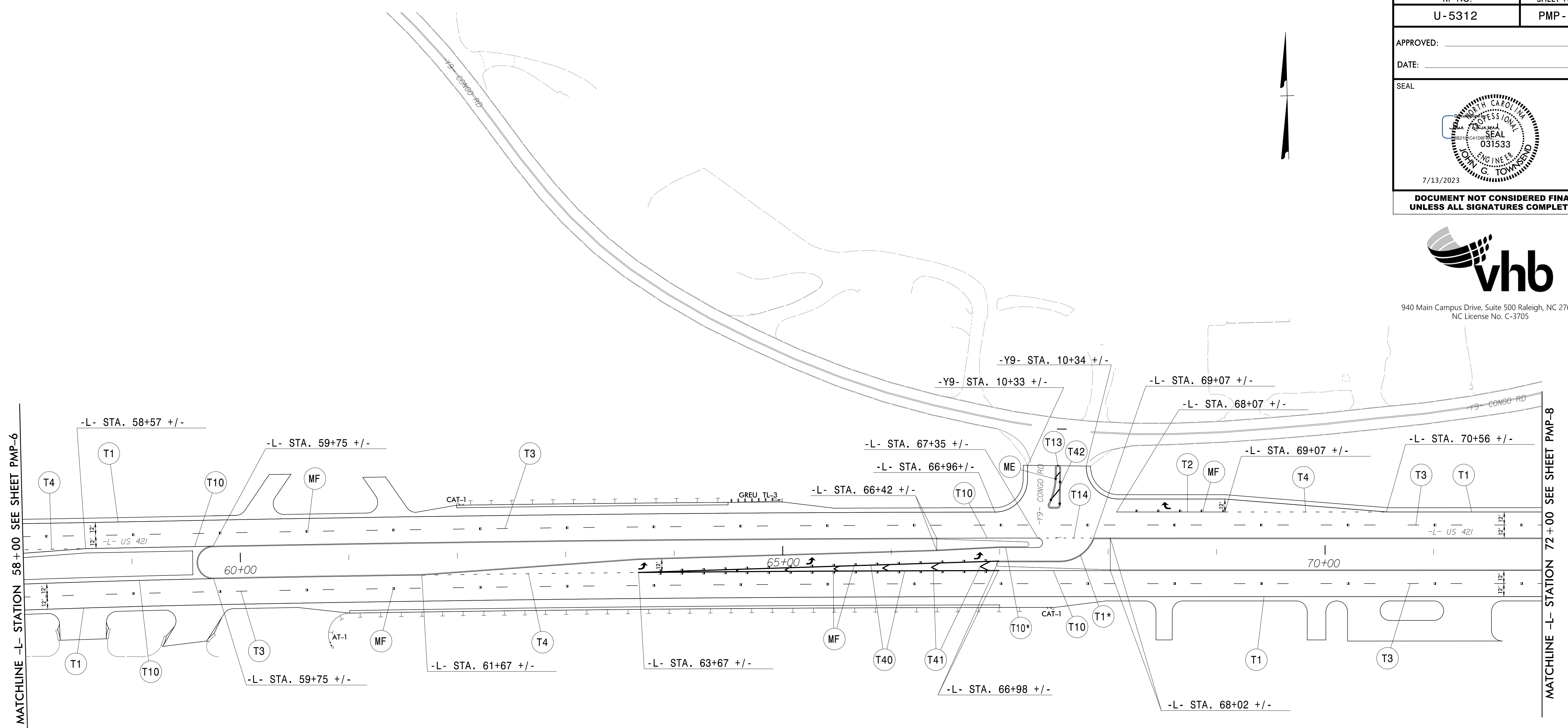

PAVEMENT MARKING SCHEDULE

SYMBOL	DESCRIPTION
T1	WHITE EDGELINE (4", 90 MIL)
T2	WHITE SOLID LANE LINE (4", 90 MIL)
T3	10 FT. WHITE SKIP (4", 90 MIL)
T4	3 FT.-9 FT./SP WHITE MINISKIP (4", 90 MIL)
T5	2 FT.-6 FT./SP WHITE MINISKIP (4", 90 MIL)
T10	YELLOW EDGELINE (4", 90 MIL)
T11	YELLOW SINGLE CENTER (4", 90 MIL)
T12	10 FT. YELLOW SKIP (4", 90 MIL)
T13	YELLOW DOUBLE CENTER (4", 90 MIL)
T14	2 FT.-6 FT./SP YELLOW MINISKIP (4", 90 MIL)
T40	WHITE GORELINE (8", 90 MIL)
T41	WHITE DIAGONAL (8", 90 MIL)
T42	YELLOW DIAGONAL (8", 90 MIL)
T46	WHITE CROSSWALK LINE (8", 90 MIL)
T61	WHITE STOPBAR (24", 90 MIL)
↵	LEFT TURN ARROW (90 MIL)
↶	RIGHT TURN ARROW (90 MIL)
↑	STRAIGHT ARROW (90 MIL)
↷	COMBO.STRAIGHT/RIGHT (90 MIL)
↻	U-TURN ARROW (90 MIL)
ME	SNOWPLOWABLE MARKER (YELLOW & YELLOW)
MF	SNOWPLOWABLE MARKER (CRYSTAL & RED)

* EDGELINE OFFSET 0.75' FROM FACE OF CURB/ISLAND

PAVEMENT MARKING DETAIL



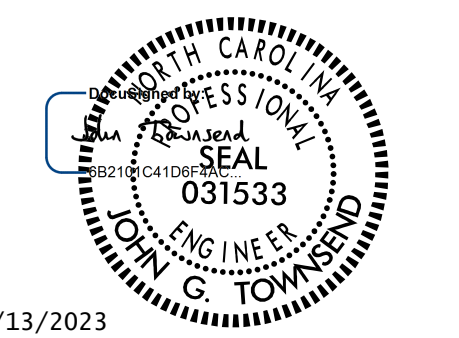

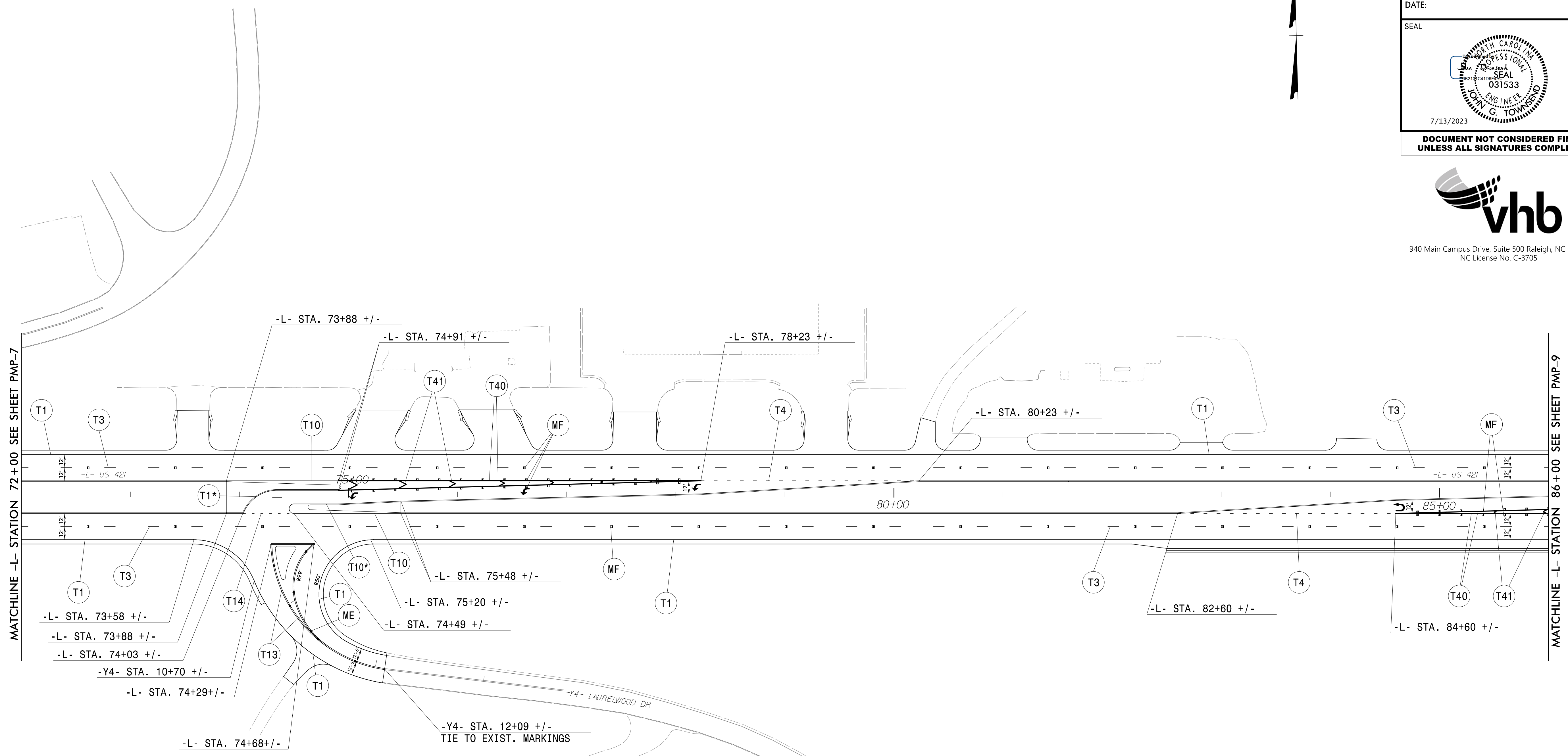
3/10/2023 R:\Traffic\PavementMarking\U5312_pm_psh07.dgn User:jtownsend

TIP NO. U-5312	SHEET NO. PMP-8
APPROVED: _____	
DATE: _____	
SEAL	
	
7/13/2023	
DOCUMENT NOT CONSIDERED FINAL UNLESS ALL SIGNATURES COMPLETED	



* EDGELINE OFFSET 0.75' FROM FACE OF CURB/ISLAND

PAVEMENT MARKING SCHEDULE

SYMBOL	DESCRIPTION
T1	WHITE EDGELINE (4", 90 MIL)
T2	WHITE SOLID LANE LINE (4", 90 MIL)
T3	10 FT. WHITE SKIP (4", 90 MIL)
T4	3 FT.-9 FT./SP WHITE MINISKIP (4", 90 MIL)
T5	2 FT.-6 FT./SP WHITE MINISKIP (4", 90 MIL)
T10	YELLOW EDGELINE (4", 90 MIL)
T11	YELLOW SINGLE CENTER (4", 90 MIL)
T12	10 FT. YELLOW SKIP (4", 90 MIL)
T13	YELLOW DOUBLE CENTER (4", 90 MIL)
T14	2 FT.-6 FT./SP YELLOW MINISKIP (4", 90 MIL)
T40	WHITE GORELINE (8", 90 MIL)
T41	WHITE DIAGONAL (8", 90 MIL)
T42	YELLOW DIAGONAL (8", 90 MIL)
T46	WHITE CROSSWALK LINE (8", 90 MIL)
T61	WHITE STOPBAR (24", 90 MIL)
	LEFT TURN ARROW (90 MIL)
	RIGHT TURN ARROW (90 MIL)
	STRAIGHT ARROW (90 MIL)
	COMBO.STRAIGHT/RIGHT (90 MIL)
	U-TURN ARROW (90 MIL)
ME	SNOWPLOWABLE MARKER (YELLOW & YELLOW)
MF	SNOWPLOWABLE MARKER (CRYSTAL & RED)

PAVEMENT MARKING DETAIL

3/10/2023 R:\Traffic\PavementMarking\U5312_pm_psh08.dgn User:jtowns

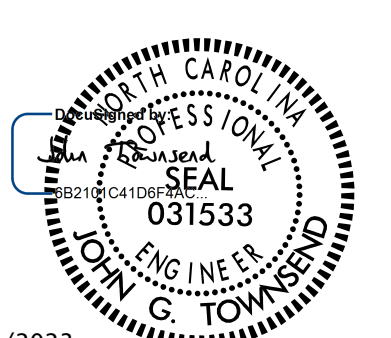
TIP NO. U-5312	SHEET NO. PMP-9
APPROVED: _____	
DATE: _____	
SEAL	
	
7/13/2023	
DOCUMENT NOT CONSIDERED FINAL UNLESS ALL SIGNATURES COMPLETED	



940 Main Campus Drive, Suite 500 Raleigh, NC 27606
NC License No. C-3705

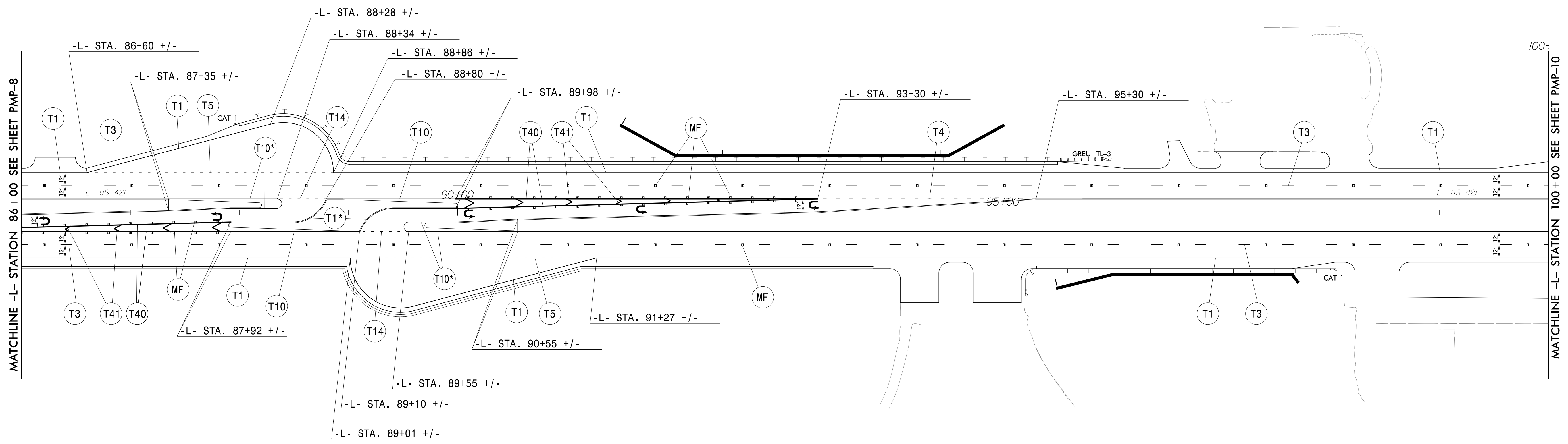

* EDGELINE OFFSET 0.75' FROM FACE OF CURB/ISLAND

PAVEMENT MARKING SCHEDULE

SYMBOL	DESCRIPTION
T1	WHITE EDGELINE (4", 90 MIL)
T2	WHITE SOLID LANE LINE (4", 90 MIL)
T3	10 FT. WHITE SKIP (4", 90 MIL)
T4	3 FT.-9 FT./SP WHITE MINISKIP (4", 90 MIL)
T5	2 FT.-6 FT./SP WHITE MINISKIP (4", 90 MIL)
T10	YELLOW EDGELINE (4", 90 MIL)
T11	YELLOW SINGLE CENTER (4", 90 MIL)
T12	10 FT. YELLOW SKIP (4", 90 MIL)
T13	YELLOW DOUBLE CENTER (4", 90 MIL)
T14	2 FT.-6 FT./SP YELLOW MINISKIP (4", 90 MIL)
T40	WHITE GORELINE (8", 90 MIL)
T41	WHITE DIAGONAL (8", 90 MIL)
T42	YELLOW DIAGONAL (8", 90 MIL)
T46	WHITE CROSSWALK LINE (8", 90 MIL)
T61	WHITE STOPBAR (24", 90 MIL)
↶	LEFT TURN ARROW (90 MIL)
↷	RIGHT TURN ARROW (90 MIL)
→	STRAIGHT ARROW (90 MIL)
↷→	COMBO.STRAIGHT/RIGHT (90 MIL)
↶↷	U-TURN ARROW (90 MIL)
ME	SNOWPLOWABLE MARKER (YELLOW & YELLOW)
MF	SNOWPLOWABLE MARKER (CRYSTAL & RED)

PAVEMENT MARKING DETAIL

3/10/2023 R:\Traffic\PavementMarking\U5312_pm_psh03.dgn User:jtownsend

TIP NO. U-5312	SHEET NO. PMP-10
APPROVED: _____	
DATE: _____	
SEAL	
7/13/2023	
DOCUMENT NOT CONSIDERED FINAL UNLESS ALL SIGNATURES COMPLETED	



940 Main Campus Drive, Suite 500 Raleigh, NC 27606
NC License No. C-3705

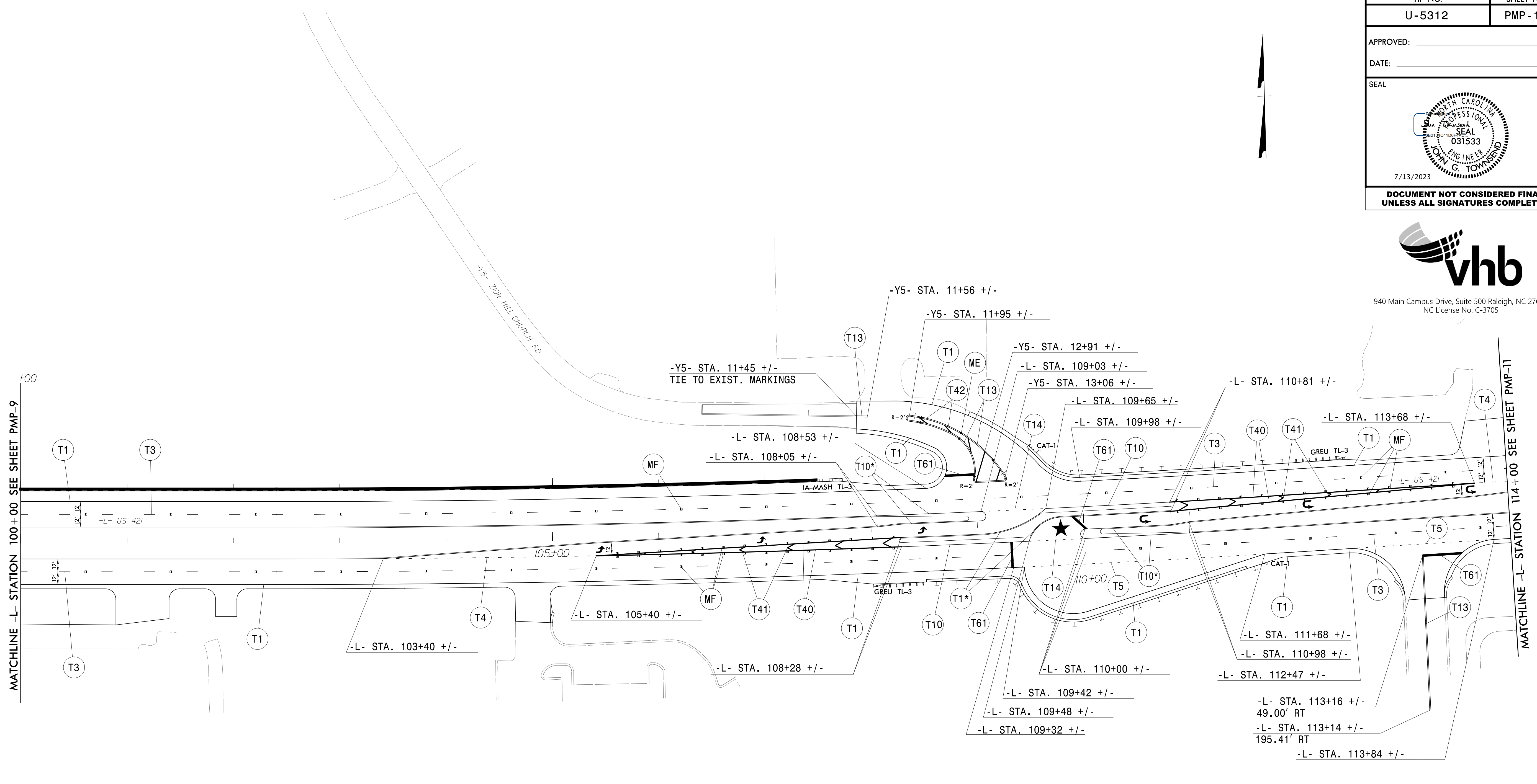

* EDGELINE OFFSET 0.75' FROM FACE OF CURB/ISLAND

PAVEMENT MARKING SCHEDULE

SYMBOL	DESCRIPTION
T1	WHITE EDGELINE (4", 90 MIL)
T2	WHITE SOLID LANE LINE (4", 90 MIL)
T3	10 FT. WHITE SKIP (4", 90 MIL)
T4	3 FT.-9 FT./SP WHITE MINISKIP (4", 90 MIL)
T5	2 FT.-6 FT./SP WHITE MINISKIP (4", 90 MIL)
T10	YELLOW EDGELINE (4", 90 MIL)
T11	YELLOW SINGLE CENTER (4", 90 MIL)
T12	10 FT. YELLOW SKIP (4", 90 MIL)
T13	YELLOW DOUBLE CENTER (4", 90 MIL)
T14	2 FT.-6 FT./SP YELLOW MINISKIP (4", 90 MIL)
T40	WHITE GORELINE (8", 90 MIL)
T41	WHITE DIAGONAL (8", 90 MIL)
T42	YELLOW DIAGONAL (8", 90 MIL)
T46	WHITE CROSSWALK LINE (8", 90 MIL)
T61	WHITE STOPBAR (24", 90 MIL)
↶	LEFT TURN ARROW (90 MIL)
↷	RIGHT TURN ARROW (90 MIL)
→	STRAIGHT ARROW (90 MIL)
↷→	COMBO.STRAIGHT/RIGHT (90 MIL)
↶↷	U-TURN ARROW (90 MIL)
ME	SNOWPLOWABLE MARKER (YELLOW & YELLOW)
MF	SNOWPLOWABLE MARKER (CRYSTAL & RED)

★ TRAFFIC SIGNAL

PAVEMENT MARKING DETAIL

3/10/2023 R:\Traffic\PavementMarking\U5312_pm_psh0.dgn User:jtowndse

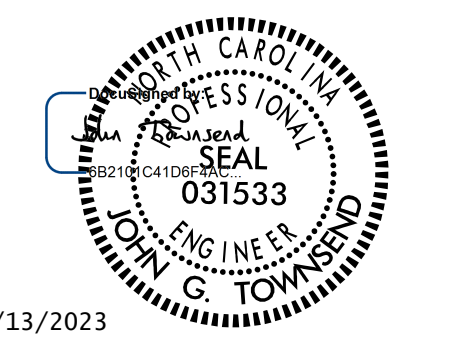
TIP NO.	SHEET NO.
U-5312	PMP-11
APPROVED: _____	
DATE: _____	
SEAL	
	
7/13/2023	
DOCUMENT NOT CONSIDERED FINAL UNLESS ALL SIGNATURES COMPLETED	



- 1 -L- STA. 120+40 +/-, 15.00' RT
- 2 -L- STA. 120+46 +/-, 15.00' RT
- 3 -L- STA. 120+22 +/-, 58.92' RT
- 4 -L- STA. 120+28 +/-, 61.52' RT
- 5 -L- STA. 120+32 +/-, 67.50' RT
- 6 -L- STA. 120+69 +/-, 67.34' RT
- 7 -L- STA. 120+70 +/-, 61.33' RT
- 8 -L- STA. 120+80 +/-, 61.27' RT
- 9 -L- STA. 120+78 +/-, 67.30' RT
- 10 -L- STA. 120+97 +/-, 71.16' RT
- 11 -L- STA. 120+99 +/-, 67.14' RT
- 12 -L- STA. 121+09 +/-, 53.17' RT
- 13 -L- STA. 120+76 +/-, 15.00' LT
- 14 -L- STA. 120+83 +/-, 15.00' LT
- 15 -L- STA. 120+90 +/-, 15.00' LT
- 16 -L- STA. 121+15 +/-, 6.25' RT
- 17 -L- STA. 121+03 +/-, 66.43' LT
- 18 -L- STA. 121+08 +/-, 62.45' LT
- 19 -L- STA. 121+12 +/-, 59.41' LT
- 20 -L- STA. 121+15 +/-, 15.00' RT
- 21 -L- STA. 120+79 +/-, 43.00' RT
- 22 -L- STA. 120+88 +/-, 43.00' RT
- 23 -L- STA. 120+19 +/-, 56.88' RT
- 24 -L- STA. 120+14 +/-, 54.55' RT
- 25 -L- STA. 120+53 +/-, 15.00' RT
- 26 -L- STA. 120+68 +/-, 172.77' RT
- 27 -L- STA. 120+74 +/-, 172.84' RT

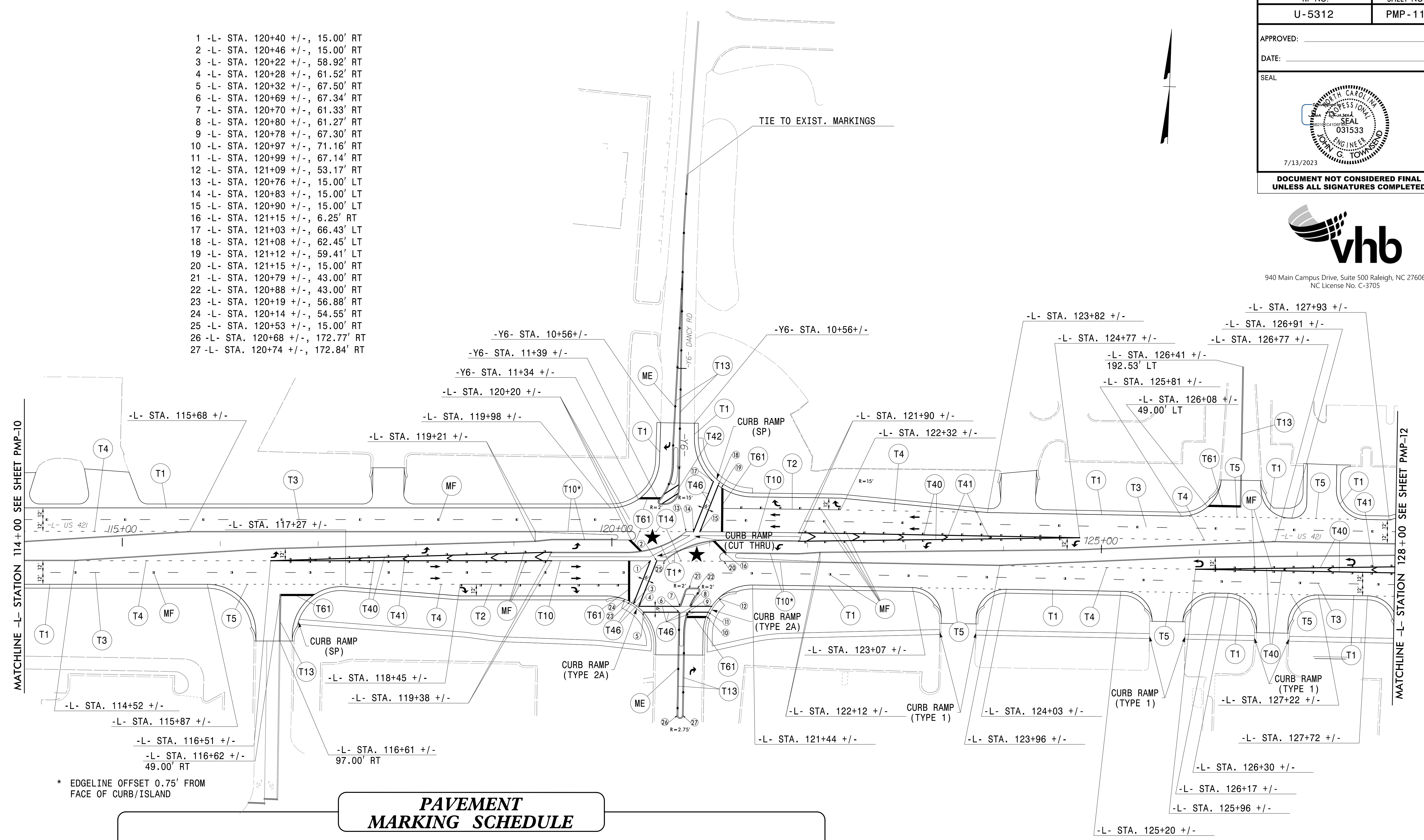

* EDGELINE OFFSET 0.75' FROM FACE OF CURB/ISLAND

PAVEMENT MARKING SCHEDULE

SYMBOL	DESCRIPTION	SYMBOL	DESCRIPTION
T1	WHITE EDGELINE (4", 90 MIL)	T41	WHITE DIAGONAL (8", 90 MIL)
T2	WHITE SOLID LANE LINE (4", 90 MIL)	T42	YELLOW DIAGONAL (8", 90 MIL)
T3	10 FT. WHITE SKIP (4", 90 MIL)	T46	WHITE CROSSWALK LINE (8", 90 MIL)
T4	3 FT.-9 FT./SP WHITE MINISKIP (4", 90 MIL)	T61	WHITE STOPBAR (24", 90 MIL)
T5	2 FT.-6 FT./SP WHITE MINISKIP (4", 90 MIL)	→	LEFT TURN ARROW (90 MIL)
T10	YELLOW EDGELINE (4", 90 MIL)	↘	RIGHT TURN ARROW (90 MIL)
T11	YELLOW SINGLE CENTER (4", 90 MIL)	→	STRAIGHT ARROW (90 MIL)
T12	10 FT. YELLOW SKIP (4", 90 MIL)	↘	COMBO.STRAIGHT/RIGHT (90 MIL)
T13	YELLOW DOUBLE CENTER (4", 90 MIL)	↺	U-TURN ARROW (90 MIL)
T14	2 FT.-6 FT./SP YELLOW MINISKIP (4", 90 MIL)	ME	SNOWPLOWABLE MARKER (YELLOW & YELLOW)
T40	WHITE GORELINE (8", 90 MIL)	MF	SNOWPLOWABLE MARKER (CRYSTAL & RED)

★ TRAFFIC SIGNAL

PAVEMENT MARKING DETAIL

3/10/2023 R:\Traffic\Pavement\Marking\U5312_pm_pshll.dgn User:jtownsend

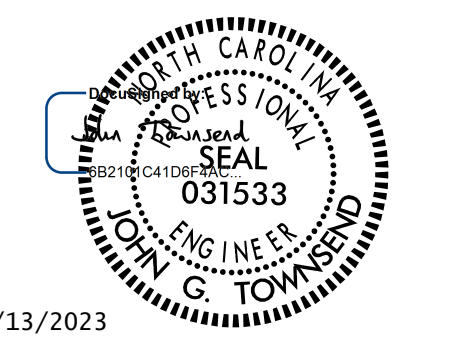
TIP NO. U-5312	SHEET NO. PMP-12
APPROVED: _____	
DATE: _____	
SEAL	
	
7/13/2023	
DOCUMENT NOT CONSIDERED FINAL UNLESS ALL SIGNATURES COMPLETED	



940 Main Campus Drive, Suite 500 Raleigh, NC 27606
NC License No. C-3705

- 1 -L- STA. 133+13 +/-, 49.00' LT
- 2 -L- STA. 133+25 +/-, 49.06' LT
- 3 -L- STA. 133+12 +/-, 137.11' LT
- 4 -L- STA. 133+24 +/-, 137.17' LT
- 5 -L- STA. 133+12 +/-, 262.18' LT
- 6 -L- STA. 133+24 +/-, 262.24' LT

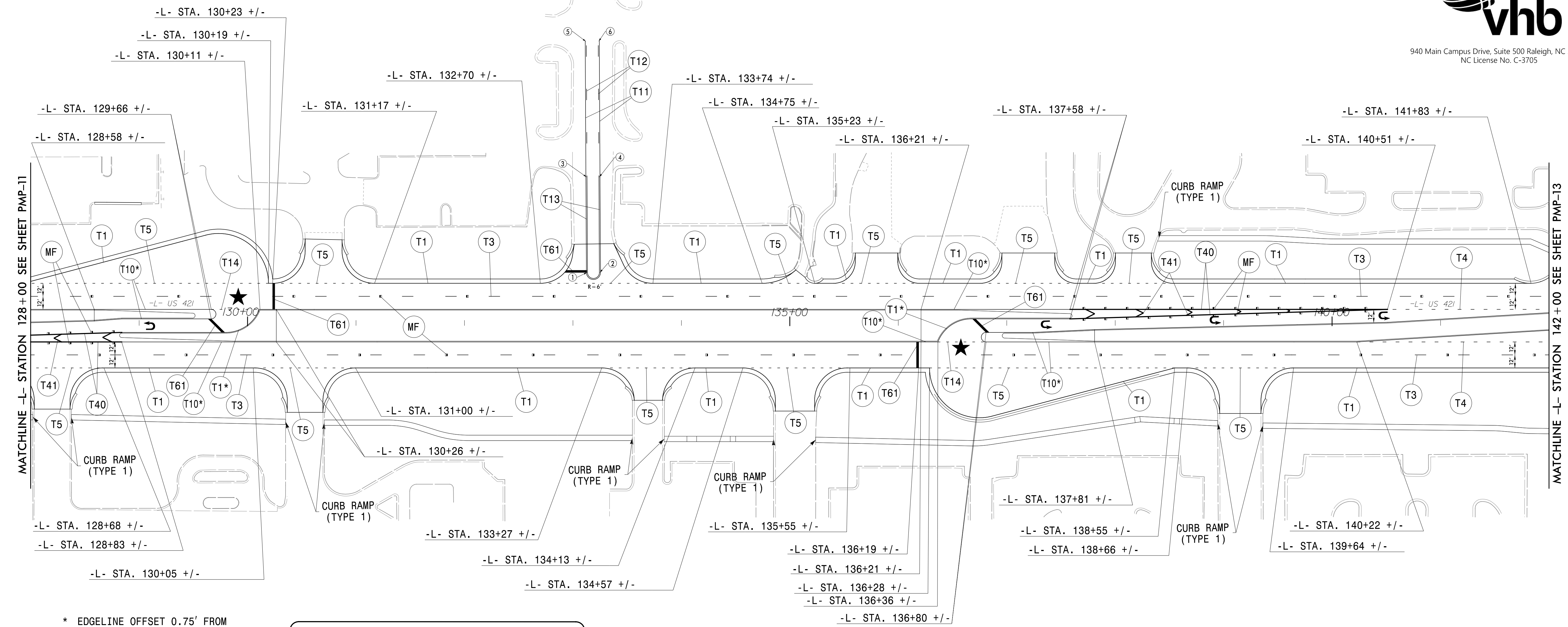

* EDGELINE OFFSET 0.75' FROM FACE OF CURB/ISLAND

PAVEMENT MARKING SCHEDULE

SYMBOL	DESCRIPTION
T1	WHITE EDGELINE (4", 90 MIL)
T2	WHITE SOLID LANE LINE (4", 90 MIL)
T3	10 FT. WHITE SKIP (4", 90 MIL)
T4	3 FT.-9 FT./SP WHITE MINISKIP (4", 90 MIL)
T5	2 FT.-6 FT./SP WHITE MINISKIP (4", 90 MIL)
T10	YELLOW EDGELINE (4", 90 MIL)
T11	YELLOW SINGLE CENTER (4", 90 MIL)
T12	10 FT. YELLOW SKIP (4", 90 MIL)
T13	YELLOW DOUBLE CENTER (4", 90 MIL)
T14	2 FT.-6 FT./SP YELLOW MINISKIP (4", 90 MIL)
T40	WHITE GORELINE (8", 90 MIL)
T41	WHITE DIAGONAL (8", 90 MIL)
T42	YELLOW DIAGONAL (8", 90 MIL)
T46	WHITE CROSSWALK LINE (8", 90 MIL)
T61	WHITE STOPBAR (24", 90 MIL)
↶	LEFT TURN ARROW (90 MIL)
↷	RIGHT TURN ARROW (90 MIL)
→	STRAIGHT ARROW (90 MIL)
↷→	COMBO.STRAIGHT/RIGHT (90 MIL)
↶↷	U-TURN ARROW (90 MIL)
ME	SNOWPLOWABLE MARKER (YELLOW & YELLOW)
MF	SNOWPLOWABLE MARKER (CRYSTAL & RED)

★ TRAFFIC SIGNAL

PAVEMENT MARKING DETAIL

3/10/2023 R:\Traffic\Pavement\Marking\U5312_pm_psh2.dgn User:jtowmsend

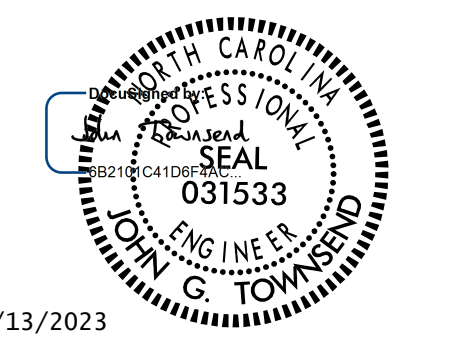
TIP NO. U-5312	SHEET NO. PMP-13
APPROVED: _____	
DATE: _____	
SEAL	
	
7/13/2023	
DOCUMENT NOT CONSIDERED FINAL UNLESS ALL SIGNATURES COMPLETED	



940 Main Campus Drive, Suite 500 Raleigh, NC 27606
NC License No. C-3705

- | | | |
|------------------------------------|------------------------------------|------------------------------------|
| 1 -L- STA. 145+90 +/-, 39.00' LT | 21 -L- STA. 146+81 +/-, 6.25' RT | 41 -L- STA. 152+87 +/-, 49.11' RT |
| 2 -L- STA. 145+90 +/-, 27.00' LT | 22 -L- STA. 146+83 +/-, 51.65' LT | 42 -L- STA. 152+95 +/-, 49.02' RT |
| 3 -L- STA. 145+93 +/-, 15.00' LT | 23 -L- STA. 146+79 +/-, 52.75' LT | 43 -L- STA. 152+76 +/-, 91.00' RT |
| 4 -L- STA. 145+93 +/-, 6.25' LT | 24 -L- STA. 146+74 +/-, 55.33' LT | 44 -L- STA. 152+87 +/-, 91.00' RT |
| 5 -L- STA. 145+86 +/-, 15.00' RT | 25 -L- STA. 146+61 +/-, 15.00' LT | 45 -L- STA. 152+90 +/-, 301.29' RT |
| 6 -L- STA. 145+89 +/-, 54.33' RT | 26 -L- STA. 146+55 +/-, 15.00' LT | 46 -L- STA. 152+98 +/-, 301.20' RT |
| 7 -L- STA. 145+95 +/-, 57.13' RT | 27 -L- STA. 146+47 +/-, 15.00' LT | |
| 8 -L- STA. 146+07 +/-, 69.56' RT | 28 -L- STA. 146+43 +/-, 46.21' LT | |
| 9 -L- STA. 146+10 +/-, 75.56' RT | 29 -L- STA. 146+39 +/-, 47.79' LT | |
| 10 -L- STA. 146+28 +/-, 128.53' RT | 30 -L- STA. 146+65 +/-, 64.23' LT | |
| 11 -L- STA. 146+59 +/-, 79.56' RT | 31 -L- STA. 146+62 +/-, 69.72' LT | |
| 12 -L- STA. 146+60 +/-, 75.56' RT | 32 -L- STA. 146+47 +/-, 146.54' LT | |
| 13 -L- STA. 146+61 +/-, 69.56' RT | 33 -L- STA. 146+43 +/-, 146.51' LT | |
| 14 -L- STA. 146+40 +/-, 49.35' RT | 34 -L- STA. 146+31 +/-, 148.42' LT | |
| 15 -L- STA. 146+89 +/-, 27.00' RT | 35 -L- STA. 146+20 +/-, 69.59' LT | |
| 16 -L- STA. 146+81 +/-, 15.00' RT | 36 -L- STA. 146+18 +/-, 60.00' LT | |
| 17 -L- STA. 146+25 +/-, 15.00' RT | 37 -L- STA. 146+15 +/-, 53.15' LT | |
| 18 -L- STA. 146+17 +/-, 15.00' RT | 38 -L- STA. 146+34 +/-, 128.50' RT | |
| 19 -L- STA. 146+10 +/-, 15.00' RT | 39 -L- STA. 146+47 +/-, 131.46' RT | |
| 20 -L- STA. 146+35 +/-, 46.65' RT | 40 -L- STA. 152+75 +/-, 52.86' RT | |

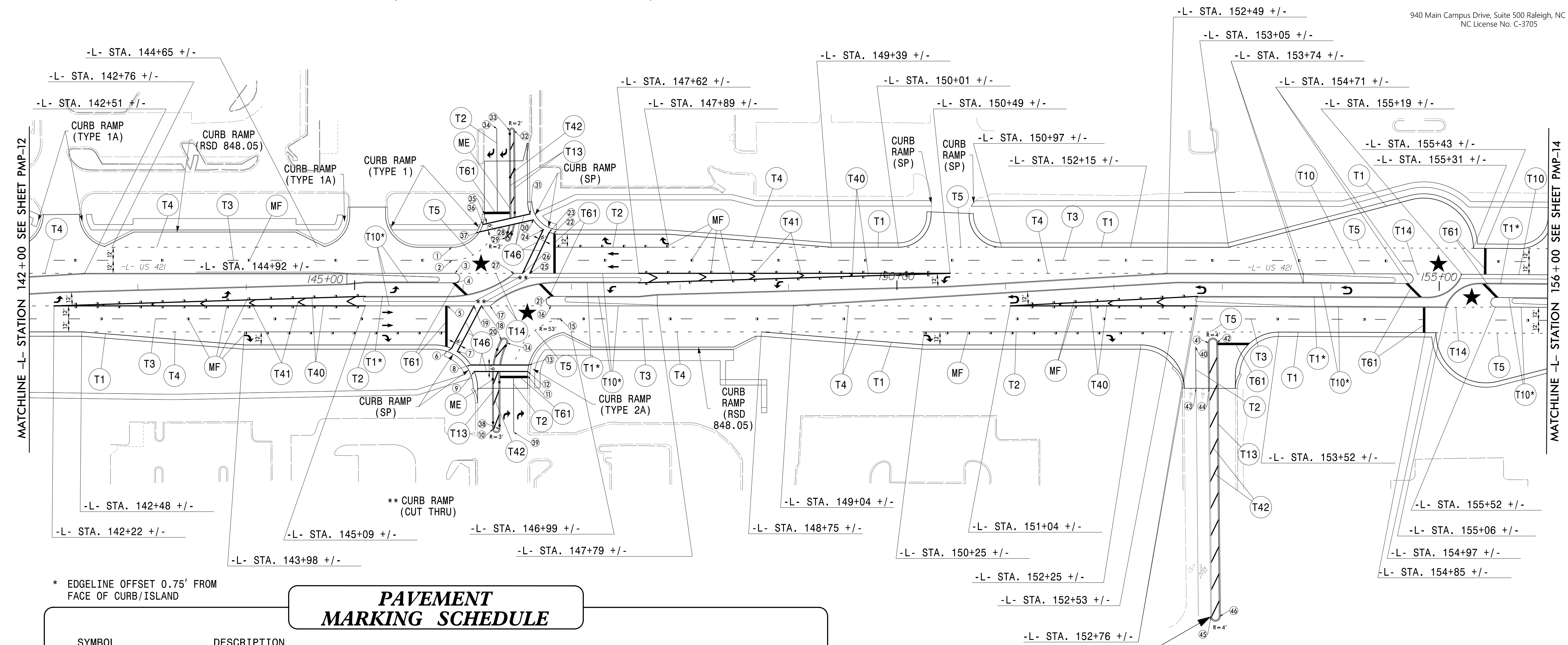

* EDGELINE OFFSET 0.75' FROM FACE OF CURB/ISLAND

PAVEMENT MARKING SCHEDULE

SYMBOL	DESCRIPTION	SYMBOL	DESCRIPTION
T1	WHITE EDGELINE (4", 90 MIL)	T41	WHITE DIAGONAL (8", 90 MIL)
T2	WHITE SOLID LANE LINE (4", 90 MIL)	T42	YELLOW DIAGONAL (8", 90 MIL)
T3	10 FT. WHITE SKIP (4", 90 MIL)	T46	WHITE CROSSWALK LINE (8", 90 MIL)
T4	3 FT.-9 FT./SP WHITE MINISKIP (4", 90 MIL)	T61	WHITE STOPBAR (24", 90 MIL)
T5	2 FT.-6 FT./SP WHITE MINISKIP (4", 90 MIL)	↶	LEFT TURN ARROW (90 MIL)
T10	YELLOW EDGELINE (4", 90 MIL)	↷	RIGHT TURN ARROW (90 MIL)
T11	YELLOW SINGLE CENTER (4", 90 MIL)	→	STRAIGHT ARROW (90 MIL)
T12	10 FT. YELLOW SKIP (4", 90 MIL)	↷↶	COMBO.STRAIGHT/RIGHT (90 MIL)
T13	YELLOW DOUBLE CENTER (4", 90 MIL)	↶↷	U-TURN ARROW (90 MIL)
T14	2 FT.-6 FT./SP YELLOW MINISKIP (4", 90 MIL)	ME	SNOWPLOWABLE MARKER (YELLOW & YELLOW)
T40	WHITE GORELINE (8", 90 MIL)	MF	SNOWPLOWABLE MARKER (CRYSTAL & RED)

★ TRAFFIC SIGNAL

PAVEMENT MARKING DETAIL

3/10/2023 R:\Traffic\Pavement\Marking\U5312_pm_psh13.dgn User:jtownsend

APPROVED: _____
DATE: _____

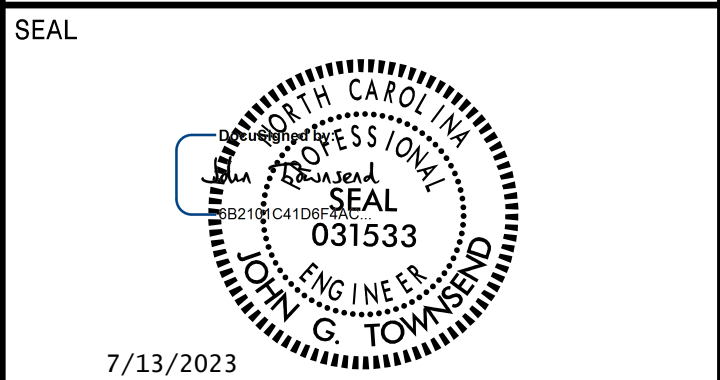

7/13/2023
**DOCUMENT NOT CONSIDERED FINAL
UNLESS ALL SIGNATURES COMPLETED**



940 Main Campus Drive, Suite 500 Raleigh, NC 27606
NC License No. C-3705

- | | |
|------------------------------------|-----------------------------------|
| 1 -L- STA. 162+55 +/-, 39.00' LT | 21 -L- STA. 163+59 +/-, 15.00' LT |
| 2 -L- STA. 162+99 +/-, 15.00' LT | 22 -L- STA. 163+10 +/-, 43.00' LT |
| 3 -L- STA. 162+99 +/-, 6.25' LT | 23 -L- STA. 163+05 +/-, 43.00' LT |
| 4 -L- STA. 162+98 +/-, 15.00' RT | 24 -L- STA. 162+94 +/-, 69.26' LT |
| 5 -L- STA. 162+60 +/-, 51.00' RT | 25 -Y7- STA. 12+49 +/-, 0.00' RT |
| 6 -L- STA. 163+44 +/-, 43.00' RT | 26 -Y7- STA. 12+04 +/-, 0.00' RT |
| 7 -L- STA. 163+33 +/-, 49.00' RT | 27 -L- STA. 163+54 +/-, 63.08' LT |
| 8 -L- STA. 163+34 +/-, 84.34' RT | 28 -L- STA. 163+64 +/-, 56.74' LT |
| 9 -L- STA. 163+22 +/-, 104.10' RT | 29 -L- STA. 162+90 +/-, 59.40' LT |
| 10 -L- STA. 163+46 +/-, 133.00' RT | 30 -L- STA. 162+93 +/-, 63.30' LT |
| 11 -L- STA. 164+18 +/-, 49.00' RT | |
| 12 -L- STA. 164+33 +/-, 27.00' RT | |
| 13 -L- STA. 163+80 +/-, 43.00' RT | |
| 14 -L- STA. 163+96 +/-, 27.00' RT | |
| 15 -L- STA. 163+37 +/-, 15.00' RT | |
| 16 -L- STA. 163+96 +/-, 15.00' RT | |
| 17 -L- STA. 163+96 +/-, 6.25' RT | |
| 18 -L- STA. 164+56 +/-, 39.00' RT | |
| 19 -L- STA. 163+92 +/-, 51.00' LT | |
| 20 -L- STA. 163+47 +/-, 71.79' LT | |

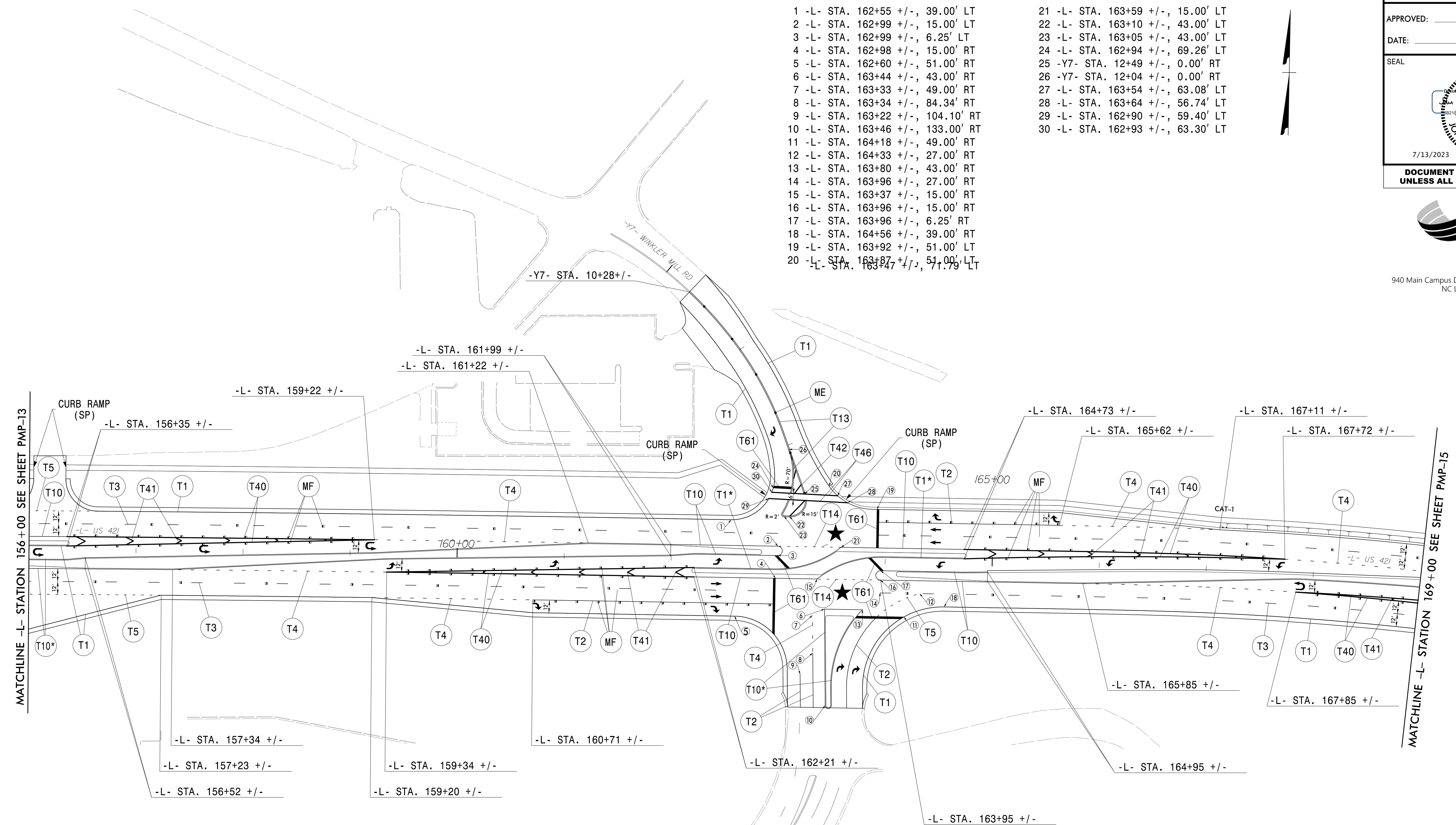

* EDGELINE OFFSET 0.75' FROM FACE OF CURB/ISLAND

PAVEMENT MARKING SCHEDULE

SYMBOL	DESCRIPTION
T1	WHITE EDGELINE (4", 90 MIL)
T2	WHITE SOLID LANE LINE (4", 90 MIL)
T3	10 FT. WHITE SKIP (4", 90 MIL)
T4	3 FT.-9 FT./SP WHITE MINISKIP (4", 90 MIL)
T5	2 FT.-6 FT./SP WHITE MINISKIP (4", 90 MIL)
T10	YELLOW EDGELINE (4", 90 MIL)
T11	YELLOW SINGLE CENTER (4", 90 MIL)
T12	10 FT. YELLOW SKIP (4", 90 MIL)
T13	YELLOW DOUBLE CENTER (4", 90 MIL)
T14	2 FT.-6 FT./SP YELLOW MINISKIP (4", 90 MIL)
T40	WHITE GORELINE (8", 90 MIL)
T41	WHITE DIAGONAL (8", 90 MIL)
T42	YELLOW DIAGONAL (8", 90 MIL)
T46	WHITE CROSSWALK LINE (8", 90 MIL)
T61	WHITE STOPBAR (24", 90 MIL)
↶	LEFT TURN ARROW (90 MIL)
↷	RIGHT TURN ARROW (90 MIL)
→	STRAIGHT ARROW (90 MIL)
↷→	COMBO.STRAIGHT/RIGHT (90 MIL)
↶→	U-TURN ARROW (90 MIL)
ME	SNOWPLOWABLE MARKER (YELLOW & YELLOW)
MF	SNOWPLOWABLE MARKER (CRYSTAL & RED)

★ TRAFFIC SIGNAL

PAVEMENT MARKING DETAIL

3/10/2023 R:\Traffic\PavementMarking\U5312_pm_psh14.dgn User:jtowndse

APPROVED: _____
 DATE: _____

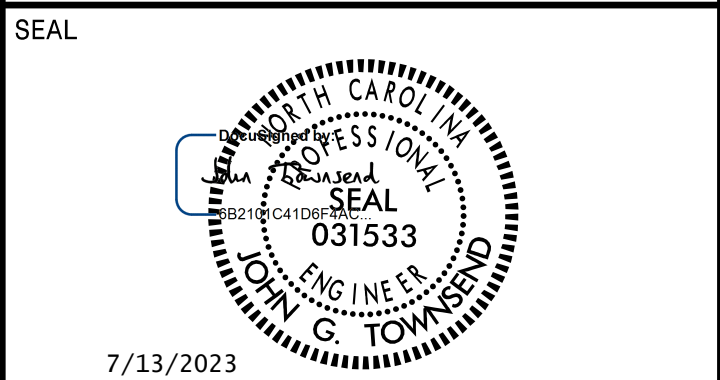

**DOCUMENT NOT CONSIDERED FINAL
 UNLESS ALL SIGNATURES COMPLETED**



940 Main Campus Drive, Suite 500 Raleigh, NC 27606
 NC License No. C-3705

- 1 -L- STA. 176+43 +/-, 30.00' LT
- 2 -L- STA. 176+80 +/-, 30.00' LT
- 3 -L- STA. 176+77 +/-, 56.00' LT
- 4 -L- STA. 176+80 +/-, 18.00' LT
- 5 -L- STA. 176+80 +/-, 11.25' LT
- 6 -L- STA. 177+44 +/-, 18.00' LT
- 7 -L- STA. 177+55 +/-, 18.00' LT
- 8 -L- STA. 177+23 +/-, 42.00' LT
- 9 -Y10- STA. 10+64 +/-, 6.64' RT
- 10 -Y10- STA. 10+63 +/-, 4.75' LT
- 11 -L- STA. 178+60 +/-, 42.00' LT
- 12 -L- STA. 178+68 +/-, 58.25' LT
- 13 -L- STA. 178+85 +/-, 42.00' LT
- 14 -Y10- STA. 12+38 +/-, 52.89' RT
- 15 -Y10- STA. 12+60 +/-, 30.00' RT
- 16 -Y10- STA. 12+22 +/-, 30.00' RT
- 17 -Y10- STA. 13+18 +/-, 30.00' RT
- 18 -Y10- STA. 12+31 +/-, 6.00' RT
- 19 -Y10- STA. 12+00 +/-, 20.78' LT

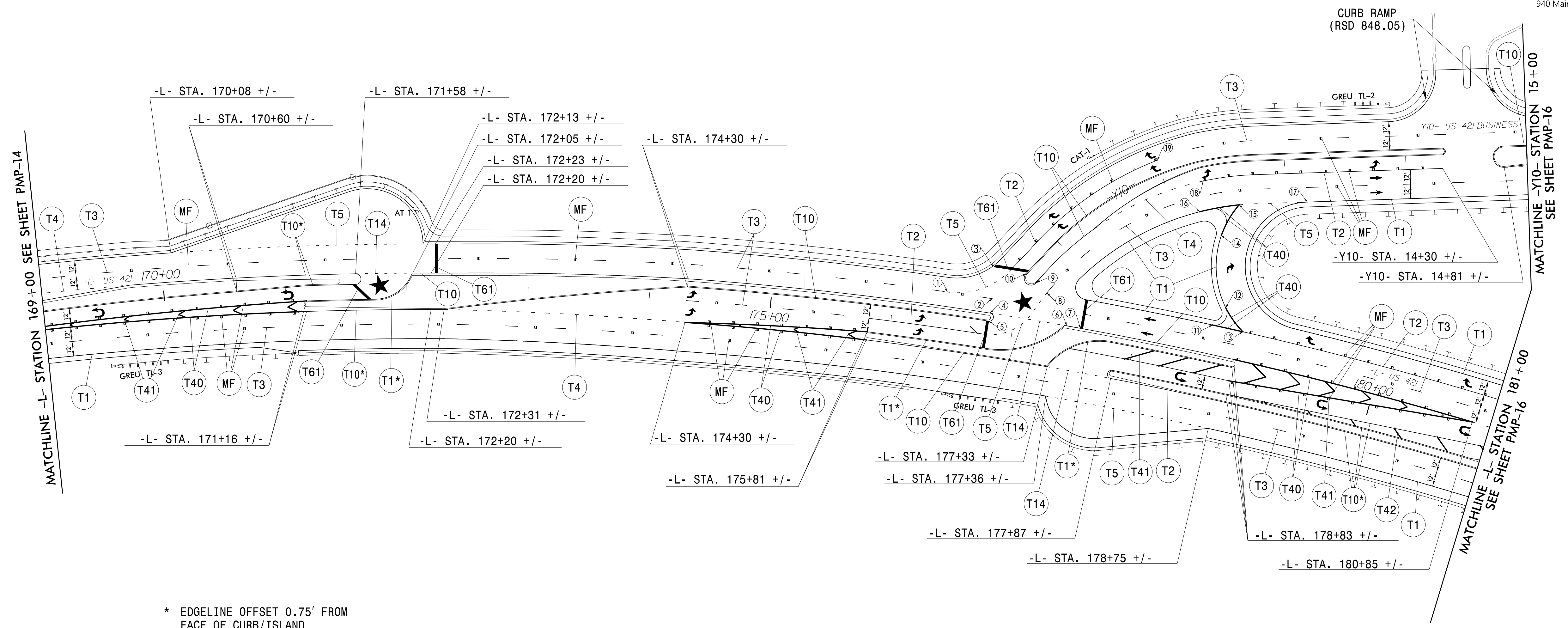
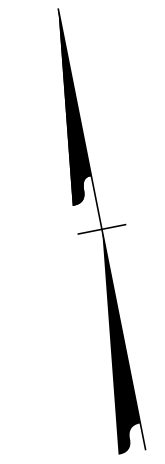

* EDGELINE OFFSET 0.75' FROM
 FACE OF CURB/ISLAND

PAVEMENT MARKING SCHEDULE

SYMBOL	DESCRIPTION	SYMBOL	DESCRIPTION
T1	WHITE EDGELINE (4", 90 MIL)	T41	WHITE DIAGONAL (8", 90 MIL)
T2	WHITE SOLID LANE LINE (4", 90 MIL)	T42	YELLOW DIAGONAL (8", 90 MIL)
T3	10 FT. WHITE SKIP (4", 90 MIL)	T46	WHITE CROSSWALK LINE (8", 90 MIL)
T4	3 FT.-9 FT./SP WHITE MINISKIP (4", 90 MIL)	T61	WHITE STOPBAR (24", 90 MIL)
T5	2 FT.-6 FT./SP WHITE MINISKIP (4", 90 MIL)	↶	LEFT TURN ARROW (90 MIL)
T10	YELLOW EDGELINE (4", 90 MIL)	↷	RIGHT TURN ARROW (90 MIL)
T11	YELLOW SINGLE CENTER (4", 90 MIL)	↩	STRAIGHT ARROW (90 MIL)
T12	10 FT. YELLOW SKIP (4", 90 MIL)	↪	COMBO.STRAIGHT/RIGHT (90 MIL)
T13	YELLOW DOUBLE CENTER (4", 90 MIL)	↻	U-TURN ARROW (90 MIL)
T14	2 FT.-6 FT./SP YELLOW MINISKIP (4", 90 MIL)	ME	SNOWPLOWABLE MARKER (YELLOW & YELLOW)
T40	WHITE GORELINE (8", 90 MIL)	MF	SNOWPLOWABLE MARKER (CRYSTAL & RED)





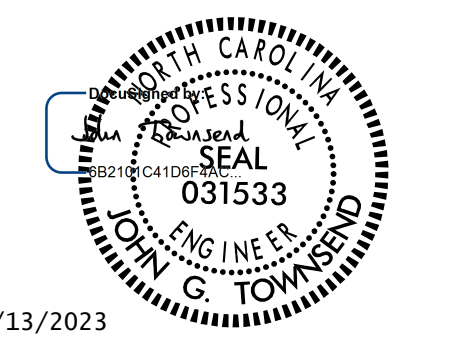

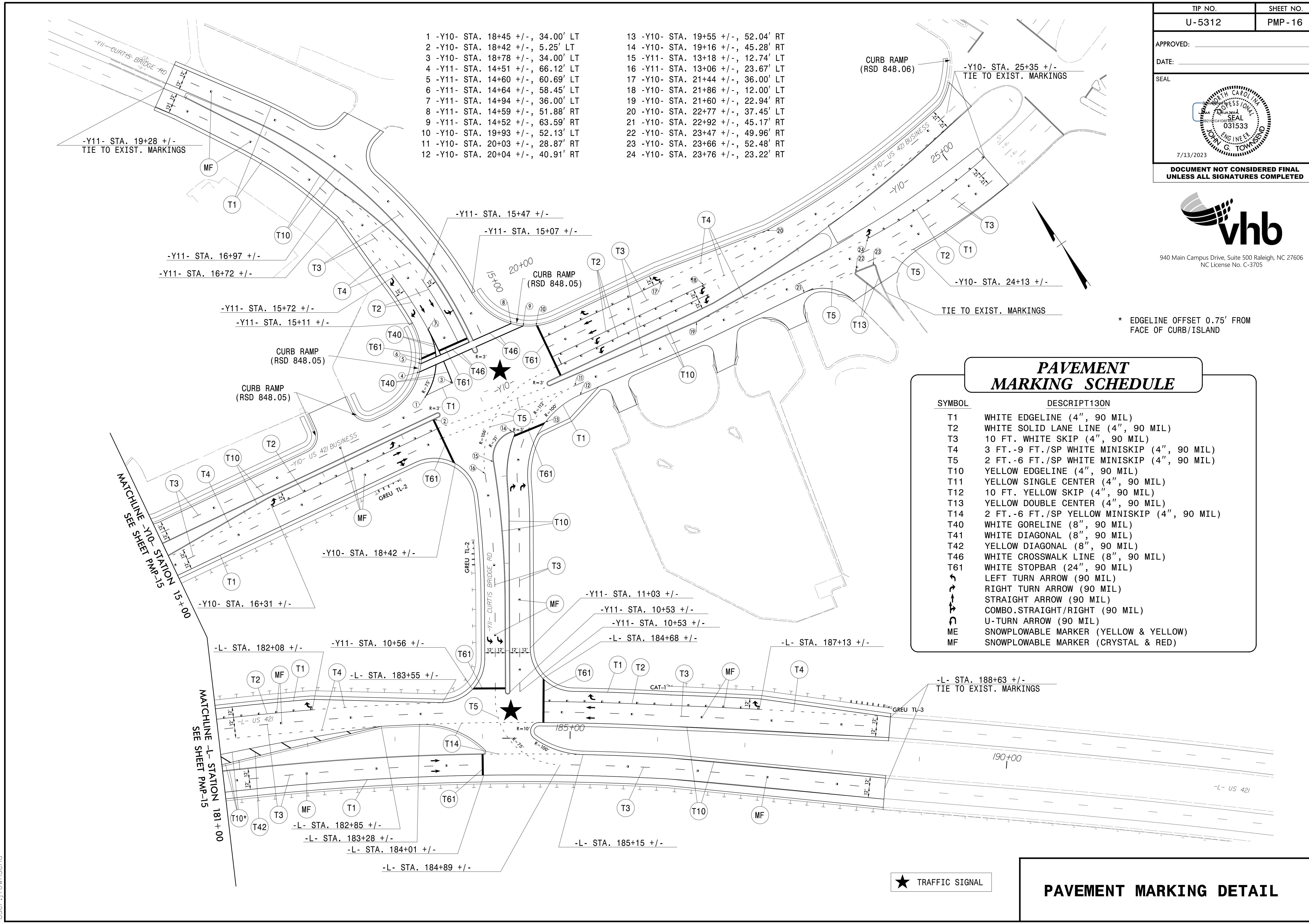

PAVEMENT MARKING DETAIL

TIP NO. U-5312	SHEET NO. PMP-16
APPROVED: _____	
DATE: _____	
SEAL	
	
7/13/2023	
DOCUMENT NOT CONSIDERED FINAL UNLESS ALL SIGNATURES COMPLETED	



- | | |
|------------------------------------|------------------------------------|
| 1 -Y10- STA. 18+45 +/-, 34.00' LT | 13 -Y10- STA. 19+55 +/-, 52.04' RT |
| 2 -Y10- STA. 18+42 +/-, 5.25' LT | 14 -Y10- STA. 19+16 +/-, 45.28' RT |
| 3 -Y10- STA. 18+78 +/-, 34.00' LT | 15 -Y11- STA. 13+18 +/-, 12.74' LT |
| 4 -Y11- STA. 14+51 +/-, 66.12' LT | 16 -Y11- STA. 13+06 +/-, 23.67' LT |
| 5 -Y11- STA. 14+60 +/-, 60.69' LT | 17 -Y10- STA. 21+44 +/-, 36.00' LT |
| 6 -Y11- STA. 14+64 +/-, 58.45' LT | 18 -Y10- STA. 21+86 +/-, 12.00' LT |
| 7 -Y11- STA. 14+94 +/-, 36.00' LT | 19 -Y10- STA. 21+60 +/-, 22.94' RT |
| 8 -Y11- STA. 14+59 +/-, 51.88' RT | 20 -Y10- STA. 22+77 +/-, 37.45' LT |
| 9 -Y11- STA. 14+52 +/-, 63.59' RT | 21 -Y10- STA. 22+92 +/-, 45.17' RT |
| 10 -Y10- STA. 19+93 +/-, 52.13' LT | 22 -Y10- STA. 23+47 +/-, 49.96' RT |
| 11 -Y10- STA. 20+03 +/-, 28.87' RT | 23 -Y10- STA. 23+66 +/-, 52.48' RT |
| 12 -Y10- STA. 20+04 +/-, 40.91' RT | 24 -Y10- STA. 23+76 +/-, 23.22' RT |



PAVEMENT MARKING SCHEDULE	
SYMBOL	DESCRIPTION
T1	WHITE EDGELINE (4", 90 MIL)
T2	WHITE SOLID LANE LINE (4", 90 MIL)
T3	10 FT. WHITE SKIP (4", 90 MIL)
T4	3 FT.-9 FT./SP WHITE MINISKIP (4", 90 MIL)
T5	2 FT.-6 FT./SP WHITE MINISKIP (4", 90 MIL)
T10	YELLOW EDGELINE (4", 90 MIL)
T11	YELLOW SINGLE CENTER (4", 90 MIL)
T12	10 FT. YELLOW SKIP (4", 90 MIL)
T13	YELLOW DOUBLE CENTER (4", 90 MIL)
T14	2 FT.-6 FT./SP YELLOW MINISKIP (4", 90 MIL)
T40	WHITE GORELINE (8", 90 MIL)
T41	WHITE DIAGONAL (8", 90 MIL)
T42	YELLOW DIAGONAL (8", 90 MIL)
T46	WHITE CROSSWALK LINE (8", 90 MIL)
T61	WHITE STOPBAR (24", 90 MIL)
	LEFT TURN ARROW (90 MIL)
	RIGHT TURN ARROW (90 MIL)
	STRAIGHT ARROW (90 MIL)
	COMBO.STRAIGHT/RIGHT (90 MIL)
	U-TURN ARROW (90 MIL)
ME	SNOWPLOWABLE MARKER (YELLOW & YELLOW)
MF	SNOWPLOWABLE MARKER (CRYSTAL & RED)

★ TRAFFIC SIGNAL

PAVEMENT MARKING DETAIL

5/31/2023
 R:\Traffic\Pavement\Marking\U5312_pm_psh16.dgn
 User:jtowns