

**This electronic collection of documents is provided
for the convenience of the user
and is Not a Certified Document –**

**The documents contained herein were originally issued
and sealed by the individuals whose names and license
numbers appear on each page, on the dates appearing
with their signature on that page.**

**This file or an individual page
shall not be considered a certified document.**

REVISIONS

K:\PAL_Roadway\01036333 - U-5724 (Central Heights)\Roadway\XSCU-5724_rdy_xpl_Y3.dgn

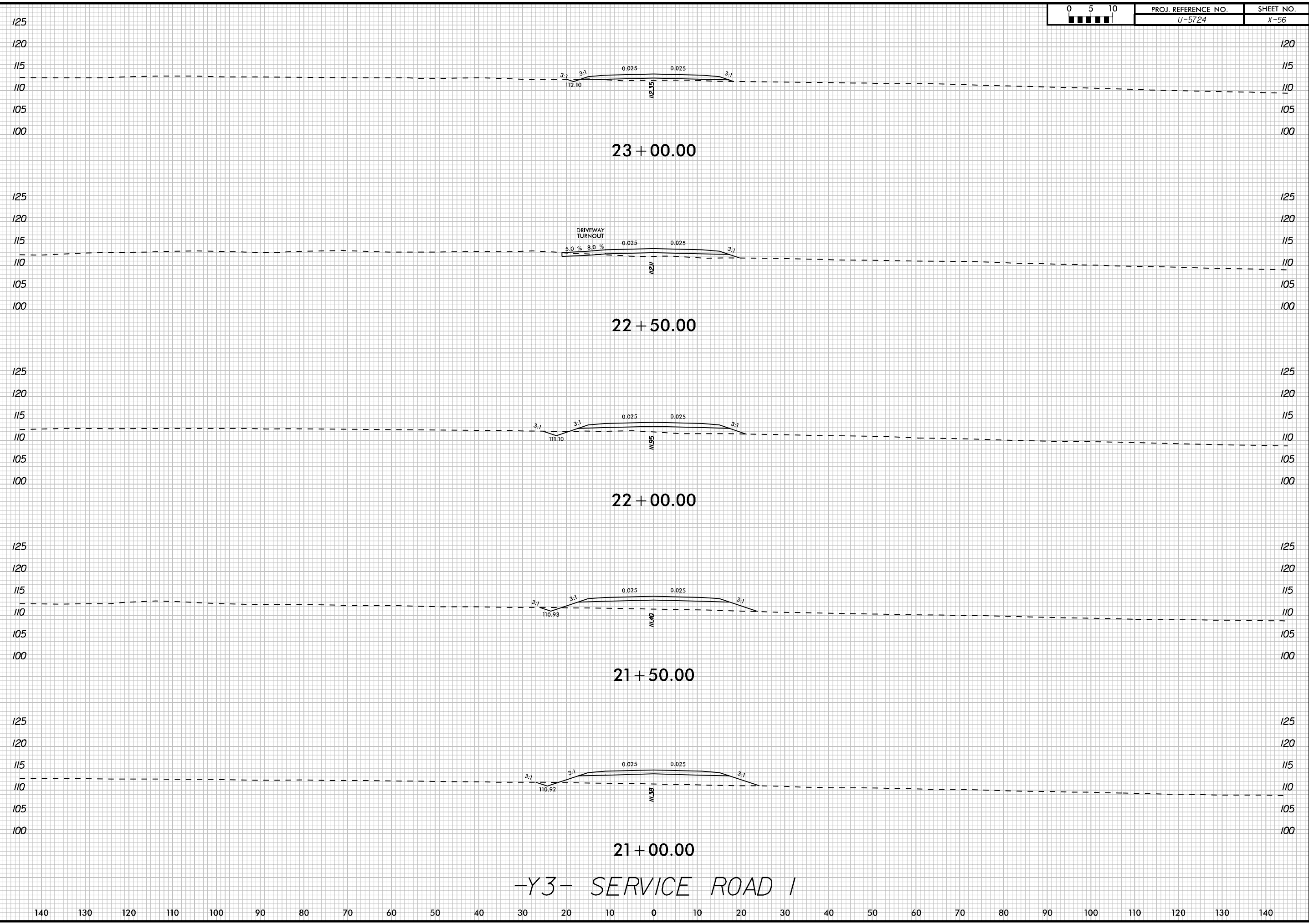

-Y3- SERVICE ROAD 1

2/19/2020

REVISIONS

K:\PAL_Roadway\01036333 - U-5724 (Central Heights)\Roadway\SSCU-5724_rdy_xpl_Y3.dgn

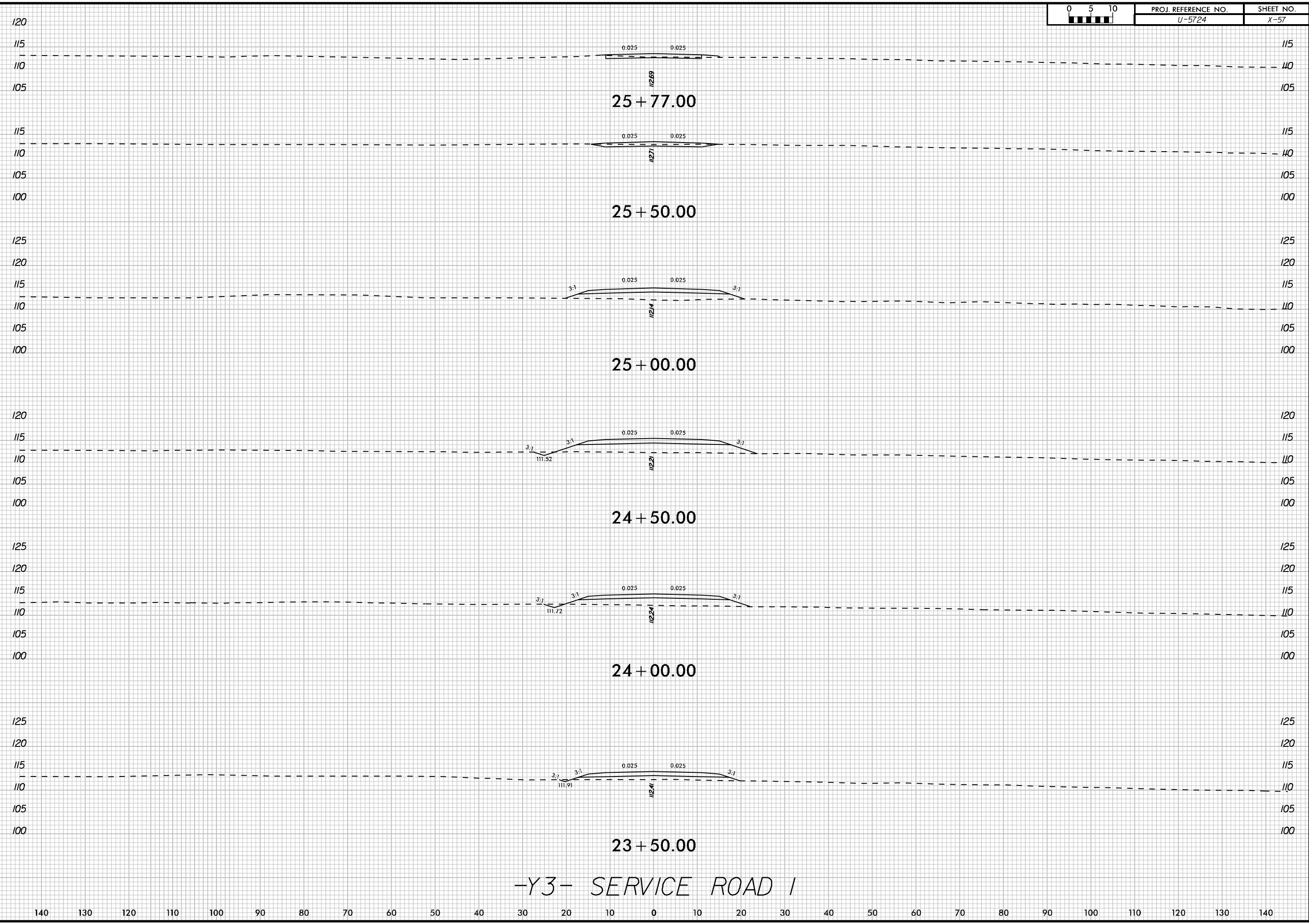

-Y3- SERVICE ROAD 1

2/19/2020

REVISIONS

K:\PAL_Roadway\01036333 - U-5724 (Central Heights)\Roadway\XSCU-5724_cdy_xpl_Y5.dgn

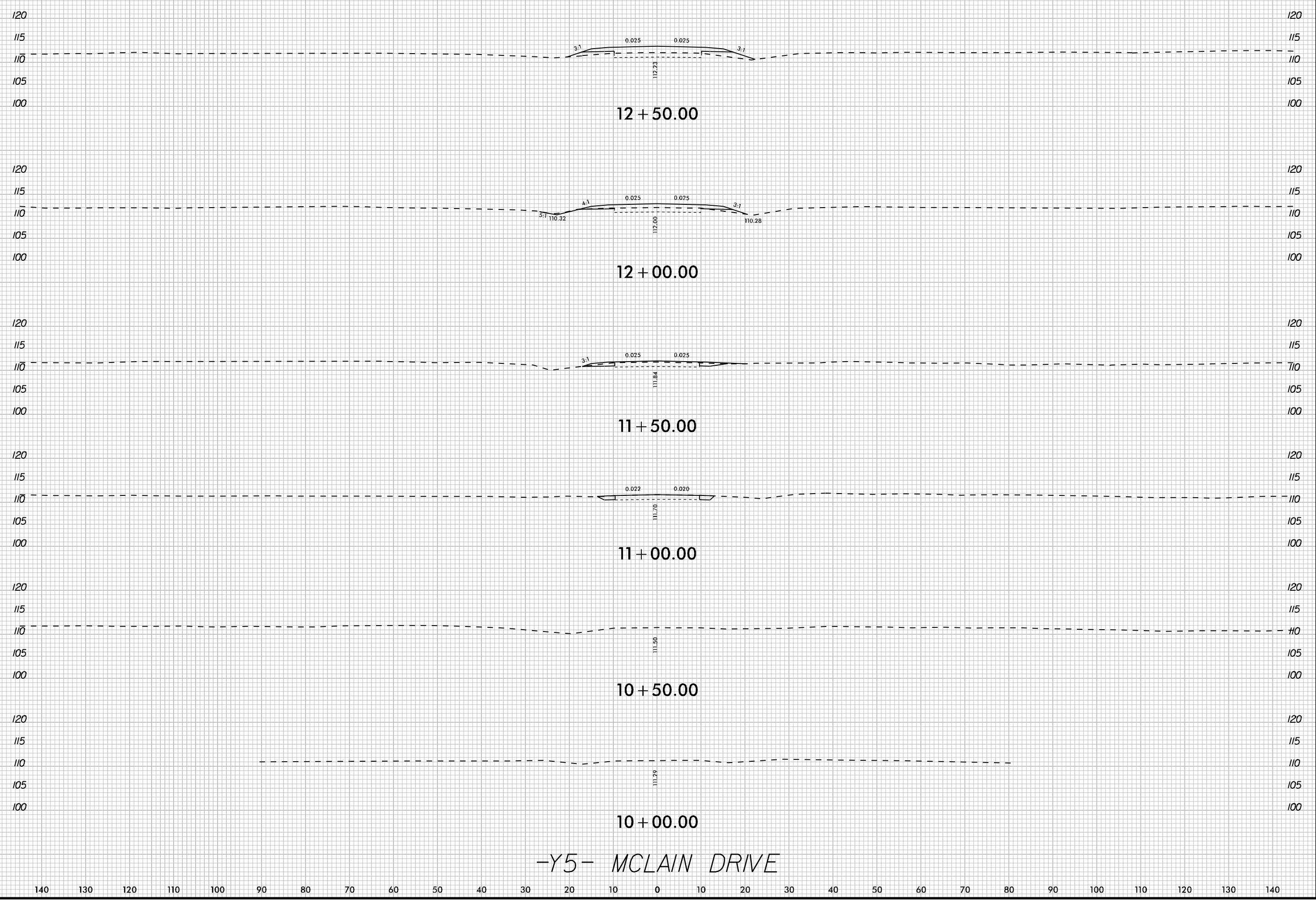

-Y5- MCLAIN DRIVE

2/19/2020

140 130 120 110 100 90 80 70 60 50 40 30 20 10 0 10 20 30 40 50 60 70 80 90 100 110 120 130 140

REVISIONS

K:\PAL_Roadway\0\036333 - U-5724 (Central Heights)\Roadway\XSCU-5724_rdy_xpl_Y5.dgn

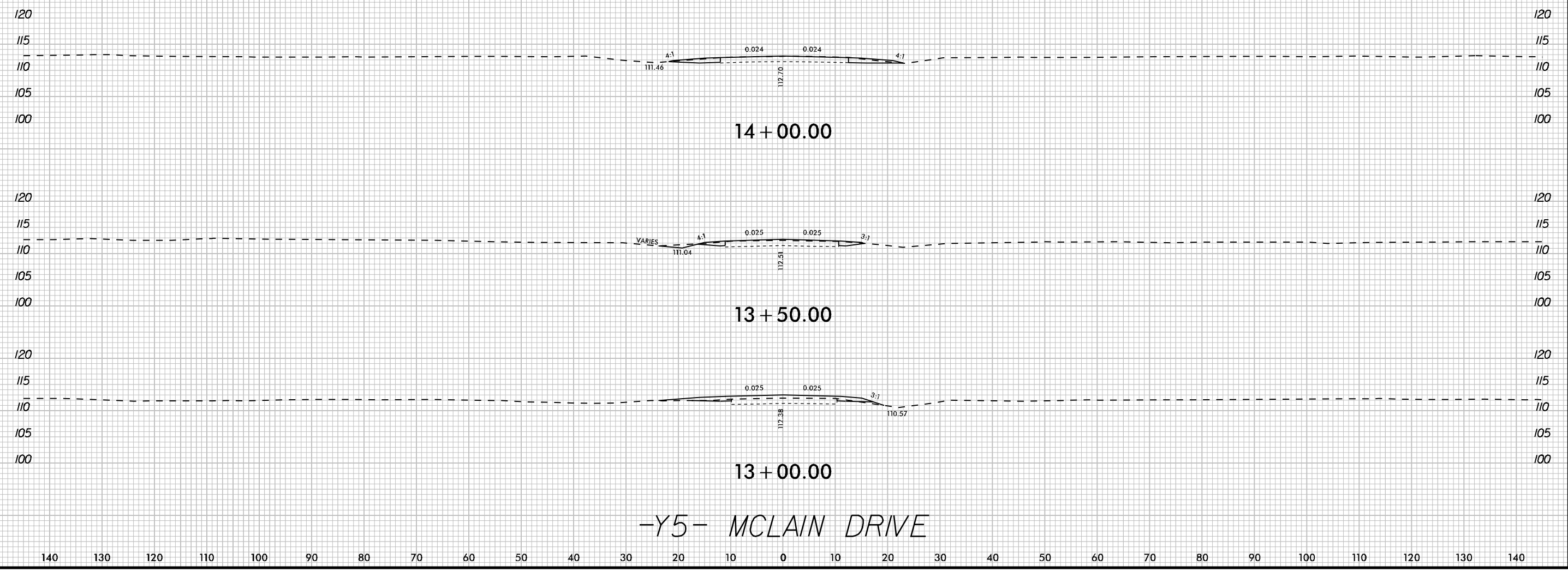

-Y5- MCLAIN DRIVE

2/19/2020

150 140 130 120 110 100 90 80 70 60 50 40 30 20 10 0 10 20 30 40 50 60 70 80 90 100 110 120 130 140 150

NOTE:
 THE TYPICAL SECTIONS TAKE
 PRECEDENCE OVER THE CROSS
 SECTIONS. CROSS SECTIONS
 ARE INCLUDED FOR REFERENCE
 ONLY

-RR_PR-

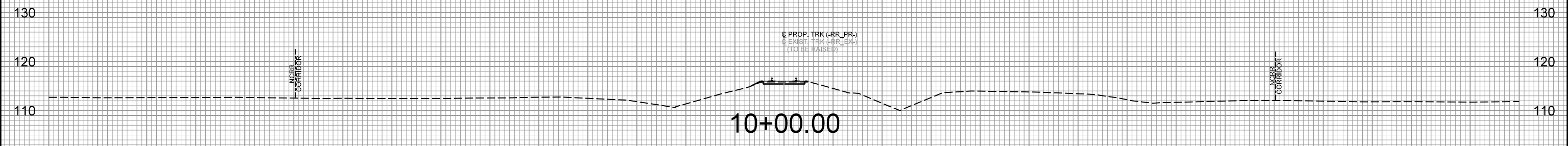
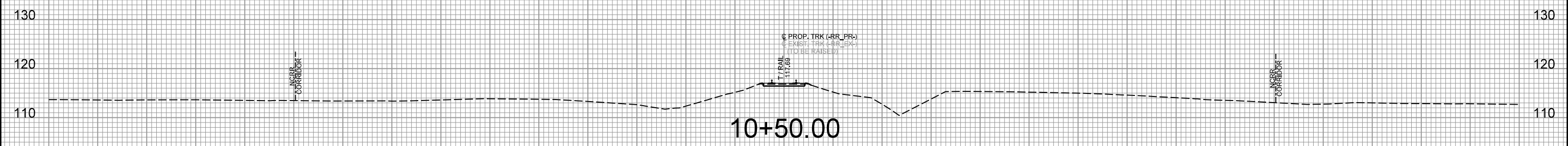
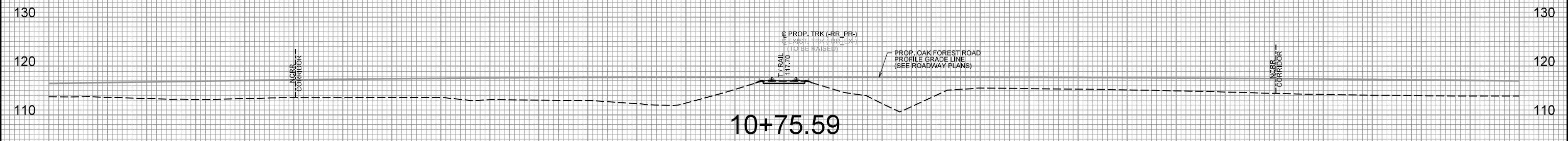

150 140 130 120 110 100 90 80 70 60 50 40 30 20 10 0 10 20 30 40 50 60 70 80 90 100 110 120 130 140 150

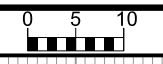

150 140 130 120 110 100 90 80 70 60 50 40 30 20 10 0 10 20 30 40 50 60 70 80 90 100 110 120 130 140 150

NOTE:
THE TYPICAL SECTIONS TAKE
PRECEDENCE OVER THE CROSS
SECTIONS. CROSS SECTIONS
ARE INCLUDED FOR REFERENCE
ONLY

-RR_PR-

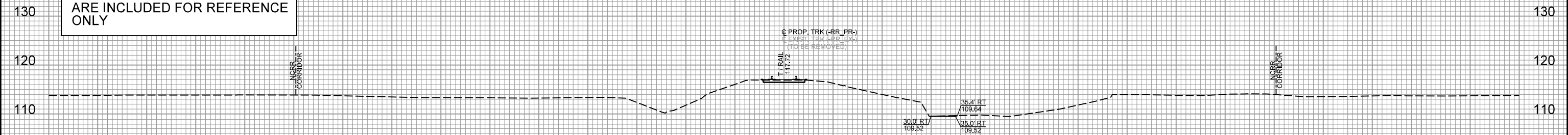

11+33.00

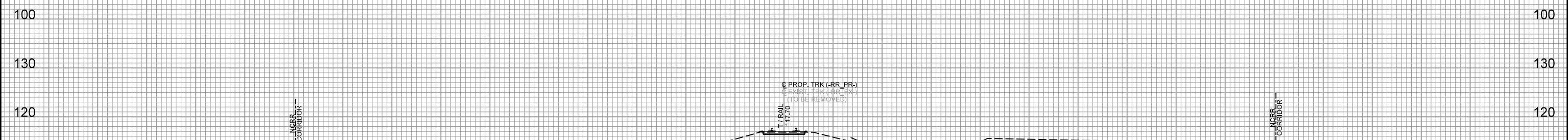

11+00.00

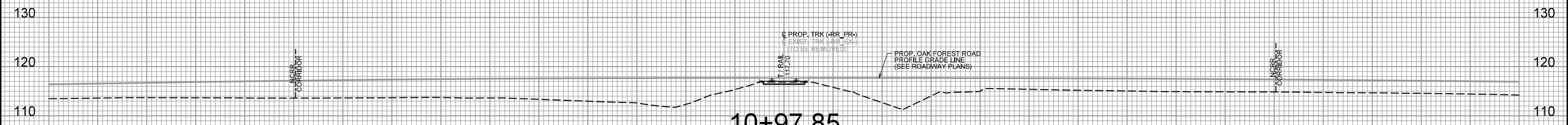

10+97.85

150 140 130 120 110 100 90 80 70 60 50 40 30 20 10 0 10 20 30 40 50 60 70 80 90 100 110 120 130 140 150

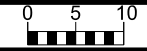

150 140 130 120 110 100 90 80 70 60 50 40 30 20 10 0 10 20 30 40 50 60 70 80 90 100 110 120 130 140 150

NOTE:
THE TYPICAL SECTIONS TAKE
PRECEDENCE OVER THE CROSS
SECTIONS. CROSS SECTIONS
ARE INCLUDED FOR REFERENCE
ONLY

-RR_PR-

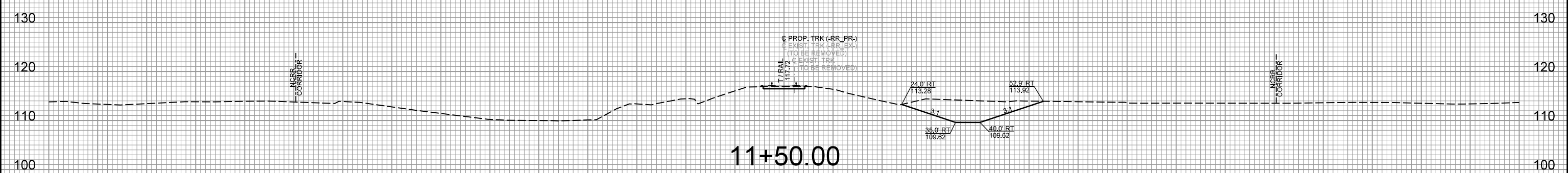
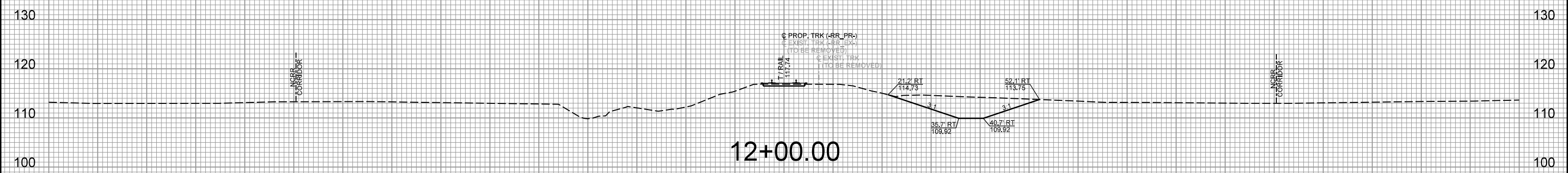
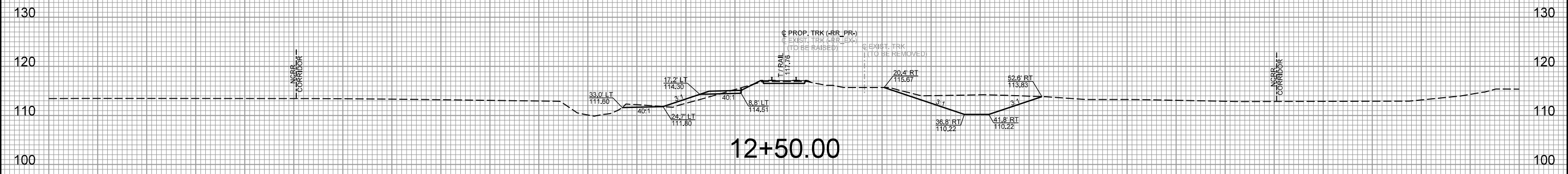

150 140 130 120 110 100 90 80 70 60 50 40 30 20 10 0 10 20 30 40 50 60 70 80 90 100 110 120 130 140 150

150 140 130 120 110 100 90 80 70 60 50 40 30 20 10 0 10 20 30 40 50 60 70 80 90 100 110 120 130 140 150

NOTE:
THE TYPICAL SECTIONS TAKE PRECEDENCE OVER THE CROSS SECTIONS. CROSS SECTIONS ARE INCLUDED FOR REFERENCE ONLY

-RR_PR-

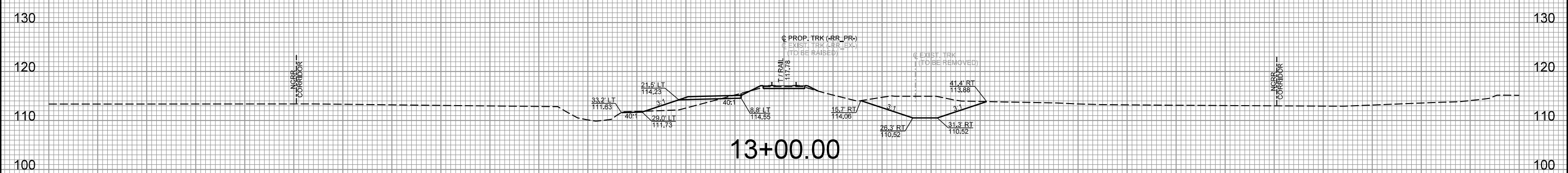
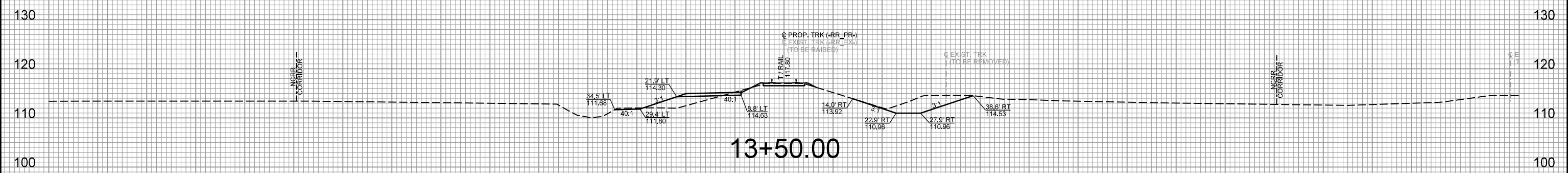
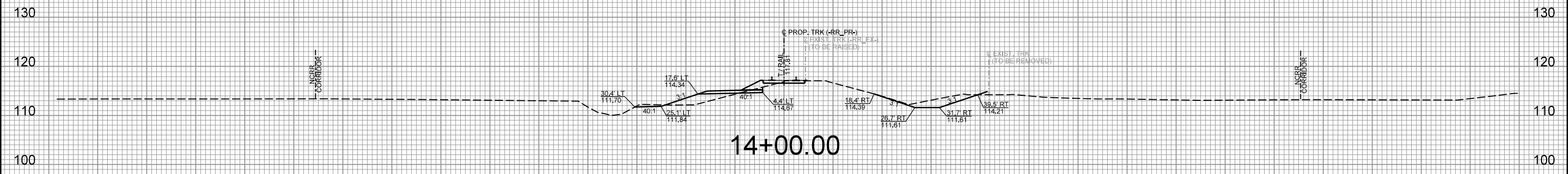

150 140 130 120 110 100 90 80 70 60 50 40 30 20 10 0 10 20 30 40 50 60 70 80 90 100 110 120 130 140 150

150 140 130 120 110 100 90 80 70 60 50 40 30 20 10 0 10 20 30 40 50 60 70 80 90 100 110 120 130 140 150

NOTE:
THE TYPICAL SECTIONS TAKE
PRECEDENCE OVER THE CROSS
SECTIONS. CROSS SECTIONS
ARE INCLUDED FOR REFERENCE
ONLY

-RR_PR-

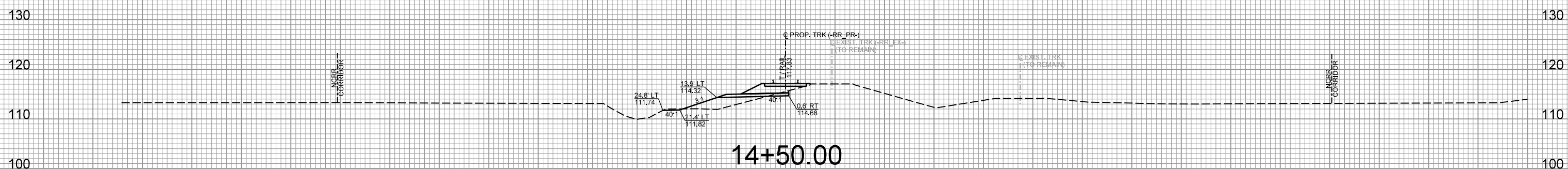
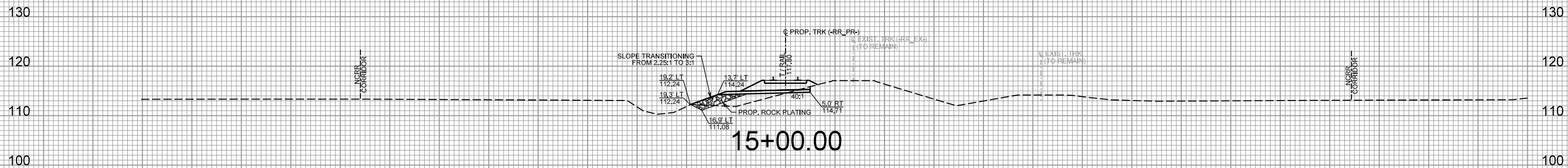
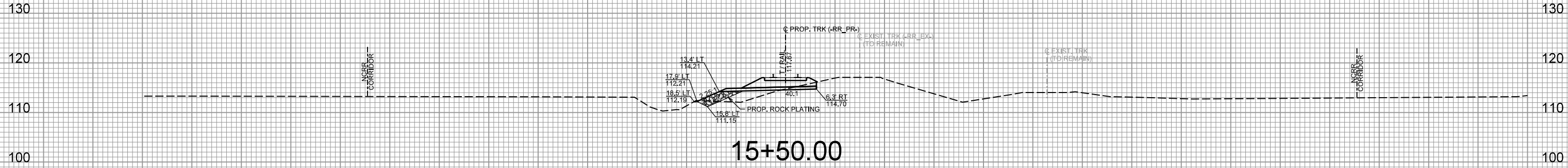

150 140 130 120 110 100 90 80 70 60 50 40 30 20 10 0 10 20 30 40 50 60 70 80 90 100 110 120 130 140 150



150 140 130 120 110 100 90 80 70 60 50 40 30 20 10 0 10 20 30 40 50 60 70 80 90 100 110 120 130 140 150

NOTE:
THE TYPICAL SECTIONS TAKE
PRECEDENCE OVER THE CROSS
SECTIONS. CROSS SECTIONS
ARE INCLUDED FOR REFERENCE
ONLY

-RR_PR-

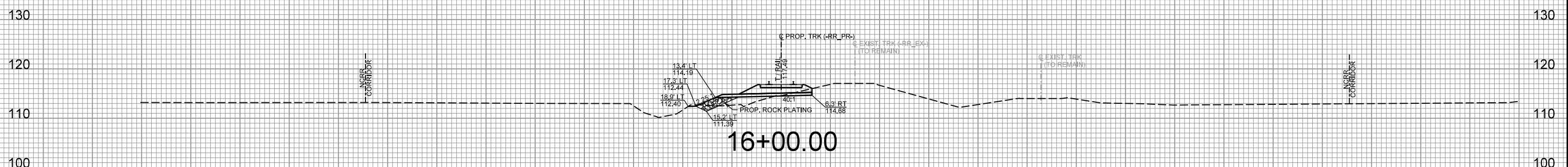
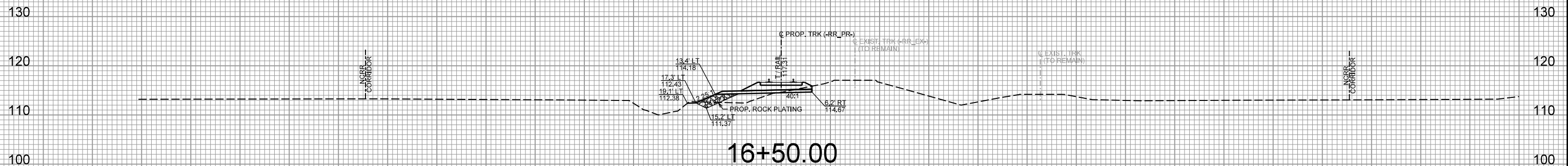
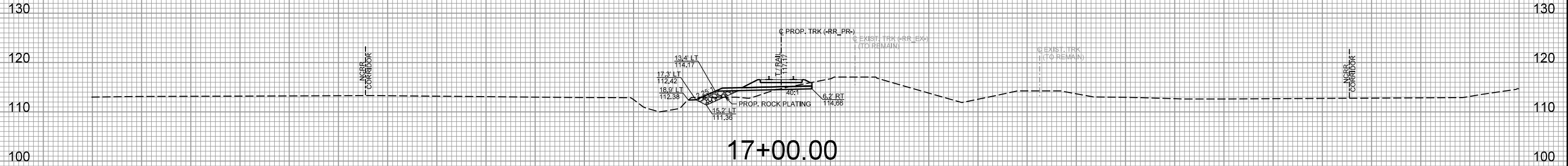

150 140 130 120 110 100 90 80 70 60 50 40 30 20 10 0 10 20 30 40 50 60 70 80 90 100 110 120 130 140 150



150 140 130 120 110 100 90 80 70 60 50 40 30 20 10 0 10 20 30 40 50 60 70 80 90 100 110 120 130 140 150

NOTE:
THE TYPICAL SECTIONS TAKE
PRECEDENCE OVER THE CROSS
SECTIONS. CROSS SECTIONS
ARE INCLUDED FOR REFERENCE
ONLY

-RR_PR-

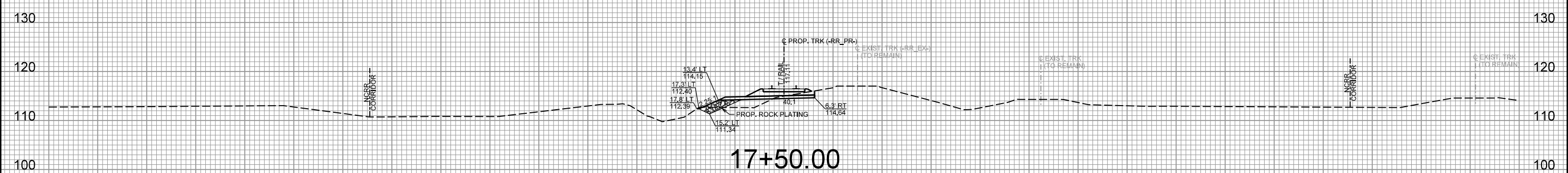
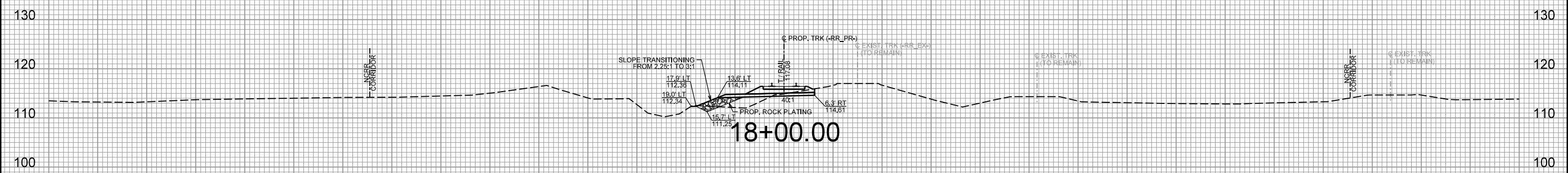
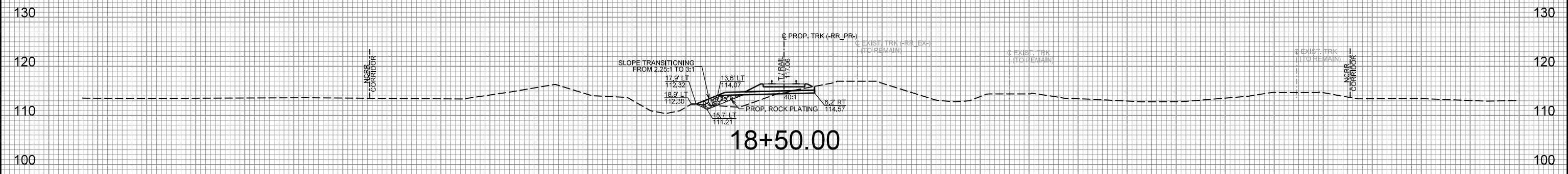

150 140 130 120 110 100 90 80 70 60 50 40 30 20 10 0 10 20 30 40 50 60 70 80 90 100 110 120 130 140 150

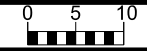

150 140 130 120 110 100 90 80 70 60 50 40 30 20 10 0 10 20 30 40 50 60 70 80 90 100 110 120 130 140 150

-RR_PR-

NOTE:
THE TYPICAL SECTIONS TAKE
PRECEDENCE OVER THE CROSS
SECTIONS. CROSS SECTIONS
ARE INCLUDED FOR REFERENCE
ONLY

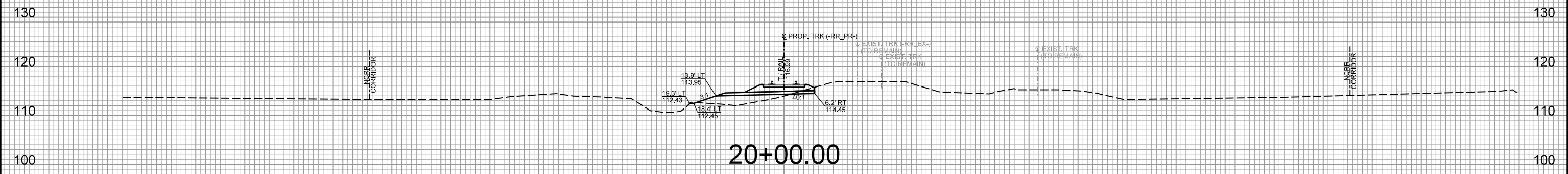

20+00.00

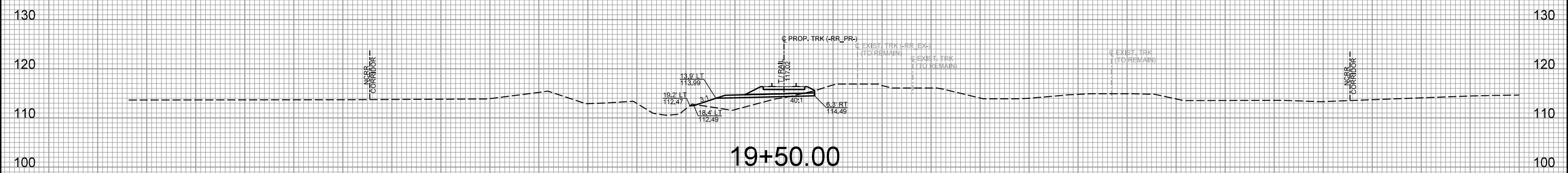

19+50.00

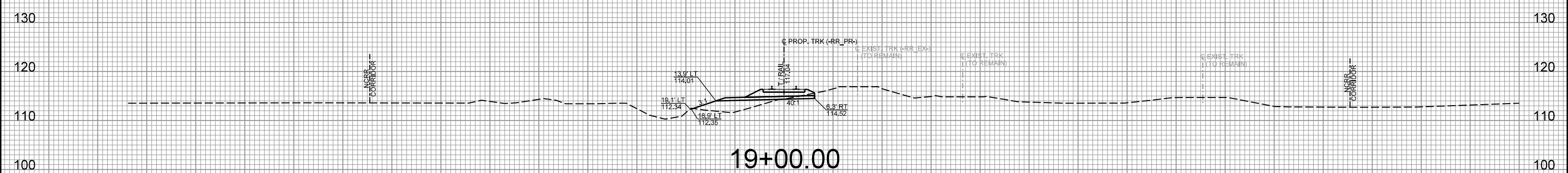

19+00.00

150 140 130 120 110 100 90 80 70 60 50 40 30 20 10 0 10 20 30 40 50 60 70 80 90 100 110 120 130 140 150



150 140 130 120 110 100 90 80 70 60 50 40 30 20 10 0 10 20 30 40 50 60 70 80 90 100 110 120 130 140 150

NOTE:
THE TYPICAL SECTIONS TAKE
PRECEDENCE OVER THE CROSS
SECTIONS. CROSS SECTIONS
ARE INCLUDED FOR REFERENCE
ONLY

-RR_PR-

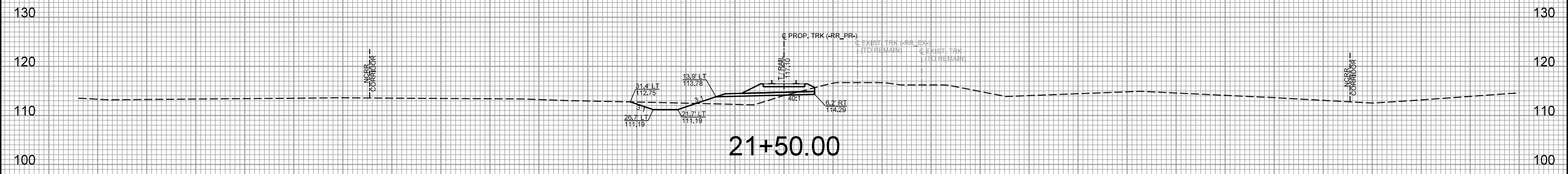

21+50.00

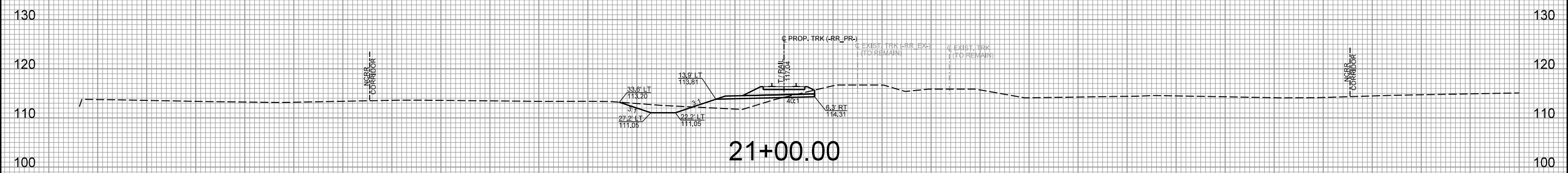

21+00.00

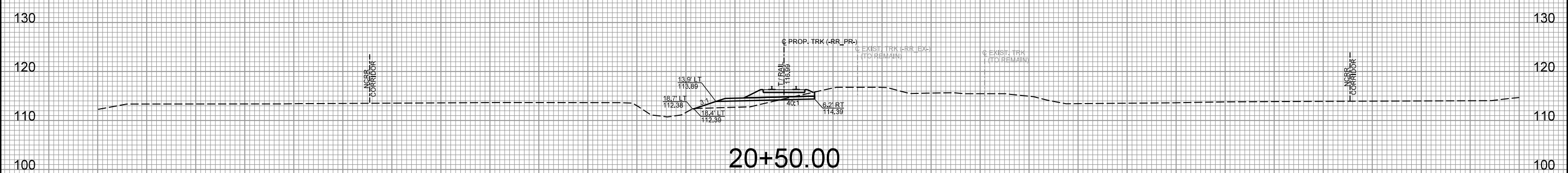

20+50.00

150 140 130 120 110 100 90 80 70 60 50 40 30 20 10 0 10 20 30 40 50 60 70 80 90 100 110 120 130 140 150



150 140 130 120 110 100 90 80 70 60 50 40 30 20 10 0 10 20 30 40 50 60 70 80 90 100 110 120 130 140 150

NOTE:
THE TYPICAL SECTIONS TAKE
PRECEDENCE OVER THE CROSS
SECTIONS. CROSS SECTIONS
ARE INCLUDED FOR REFERENCE
ONLY

-RR_PR-

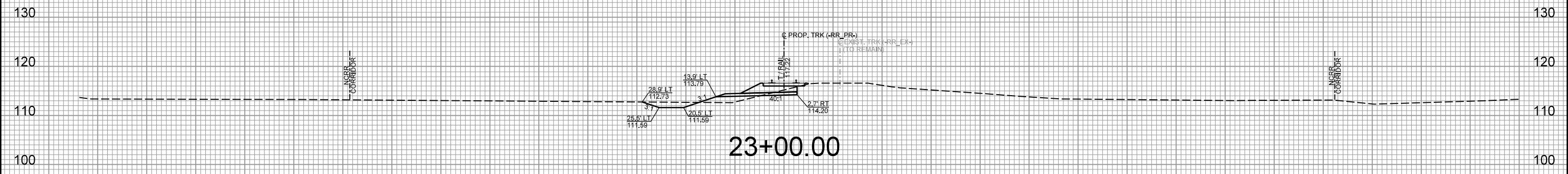

23+00.00

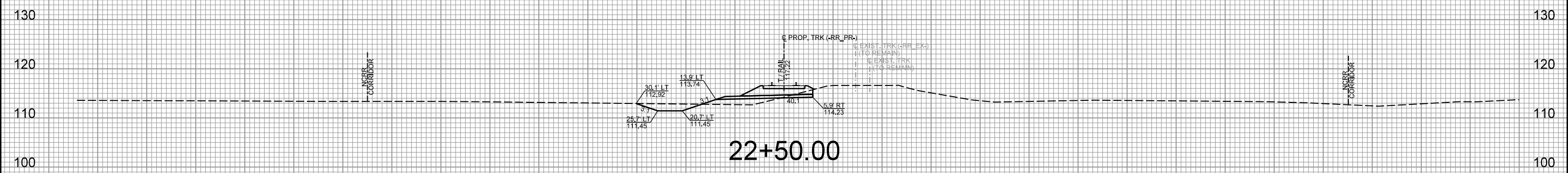

22+50.00

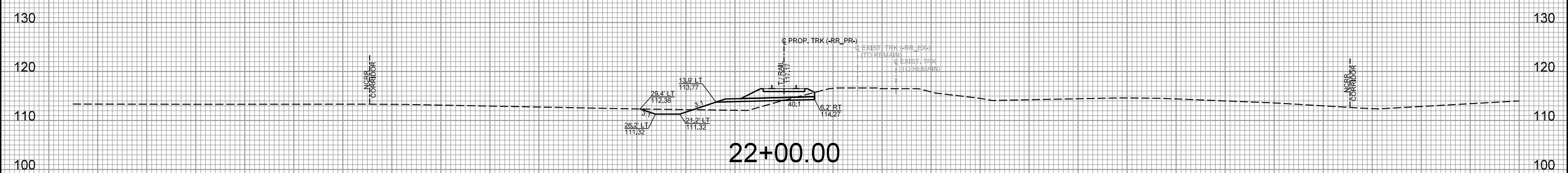

22+00.00

150 140 130 120 110 100 90 80 70 60 50 40 30 20 10 0 10 20 30 40 50 60 70 80 90 100 110 120 130 140 150

150 140 130 120 110 100 90 80 70 60 50 40 30 20 10 0 10 20 30 40 50 60 70 80 90 100 110 120 130 140 150

NOTE:
 THE TYPICAL SECTIONS TAKE
 PRECEDENCE OVER THE CROSS
 SECTIONS. CROSS SECTIONS
 ARE INCLUDED FOR REFERENCE
 ONLY

-RR_PR-

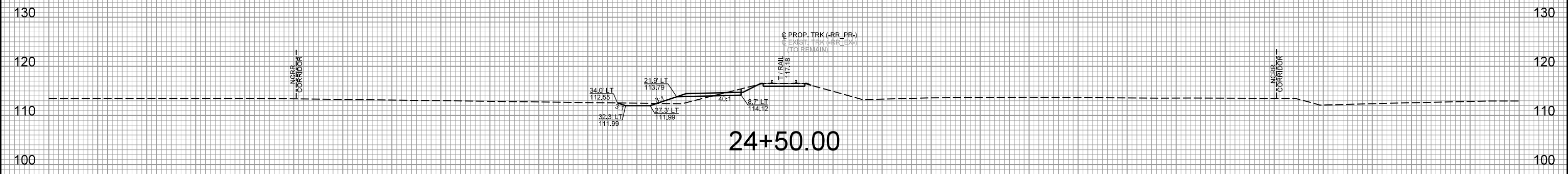

24+50.00

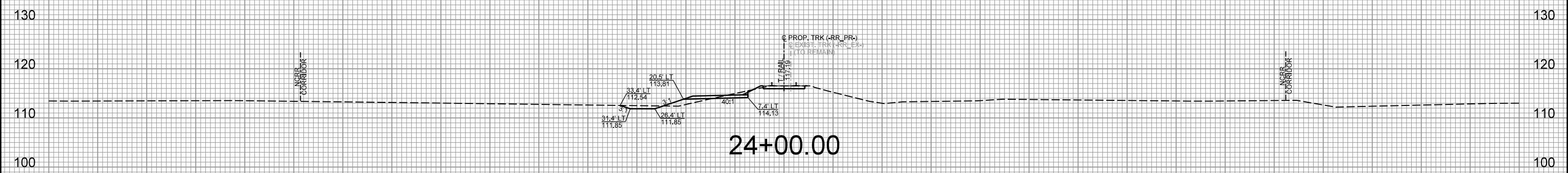

24+00.00

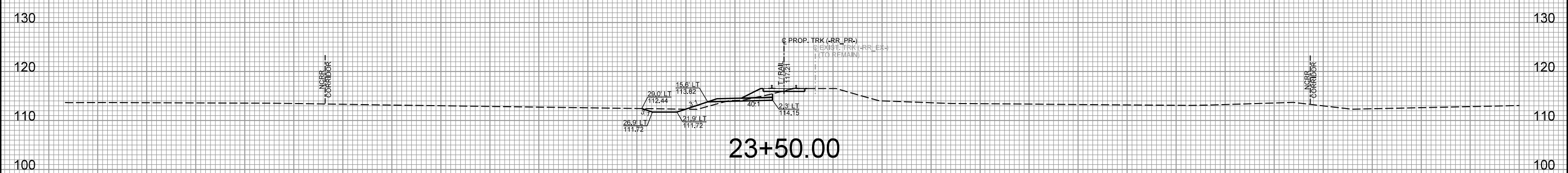

23+50.00

150 140 130 120 110 100 90 80 70 60 50 40 30 20 10 0 10 20 30 40 50 60 70 80 90 100 110 120 130 140 150

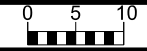

PROJ. REFERENCE NO.
U-5724

SHEET NO.
X-71

150 140 130 120 110 100 90 80 70 60 50 40 30 20 10 0 10 20 30 40 50 60 70 80 90 100 110 120 130 140 150

NOTE:
THE TYPICAL SECTIONS TAKE
PRECEDENCE OVER THE CROSS
SECTIONS. CROSS SECTIONS
ARE INCLUDED FOR REFERENCE
ONLY

-RR_PR-

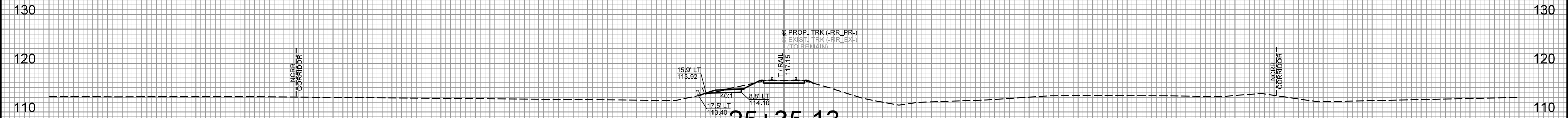

25+35.13

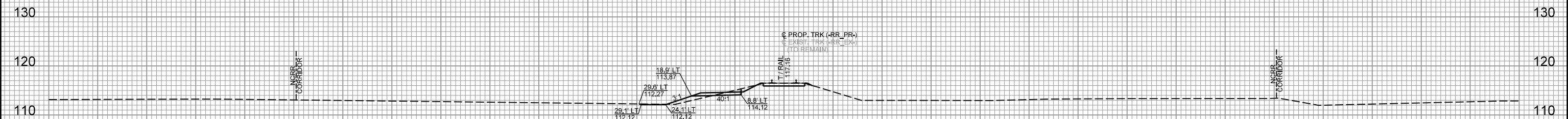

25+00.00

150 140 130 120 110 100 90 80 70 60 50 40 30 20 10 0 10 20 30 40 50 60 70 80 90 100 110 120 130 140 150