

MATCHLINE - SEE ITS-21

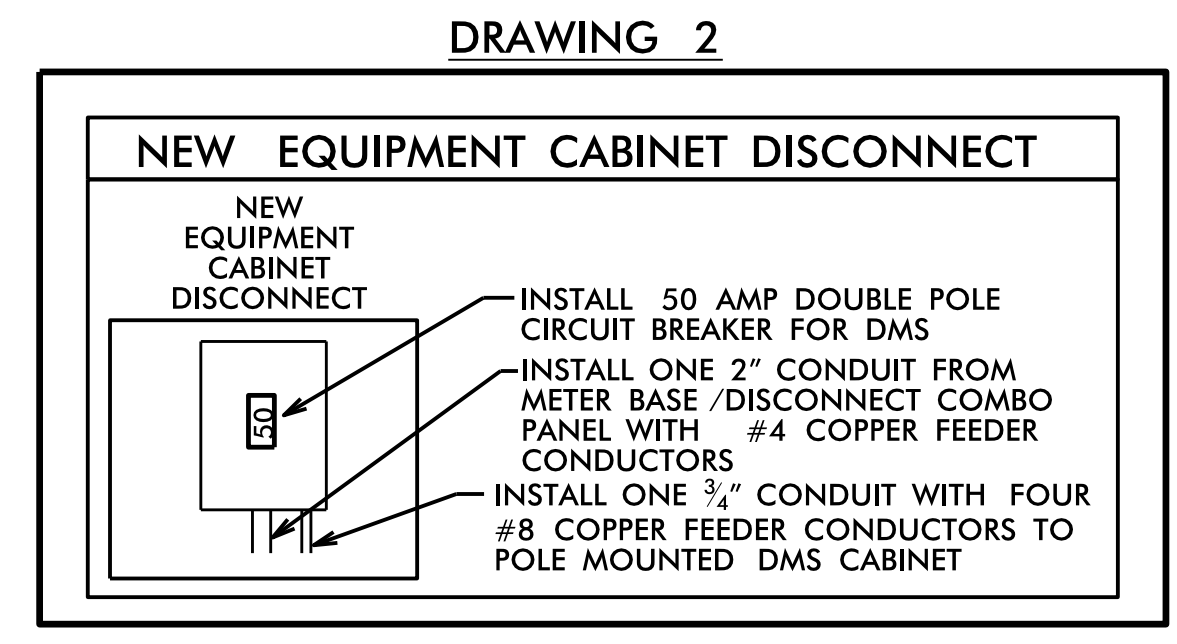

I-74 - NORTHERN BELTWAY

MATCHLINE - SEE ITS-23

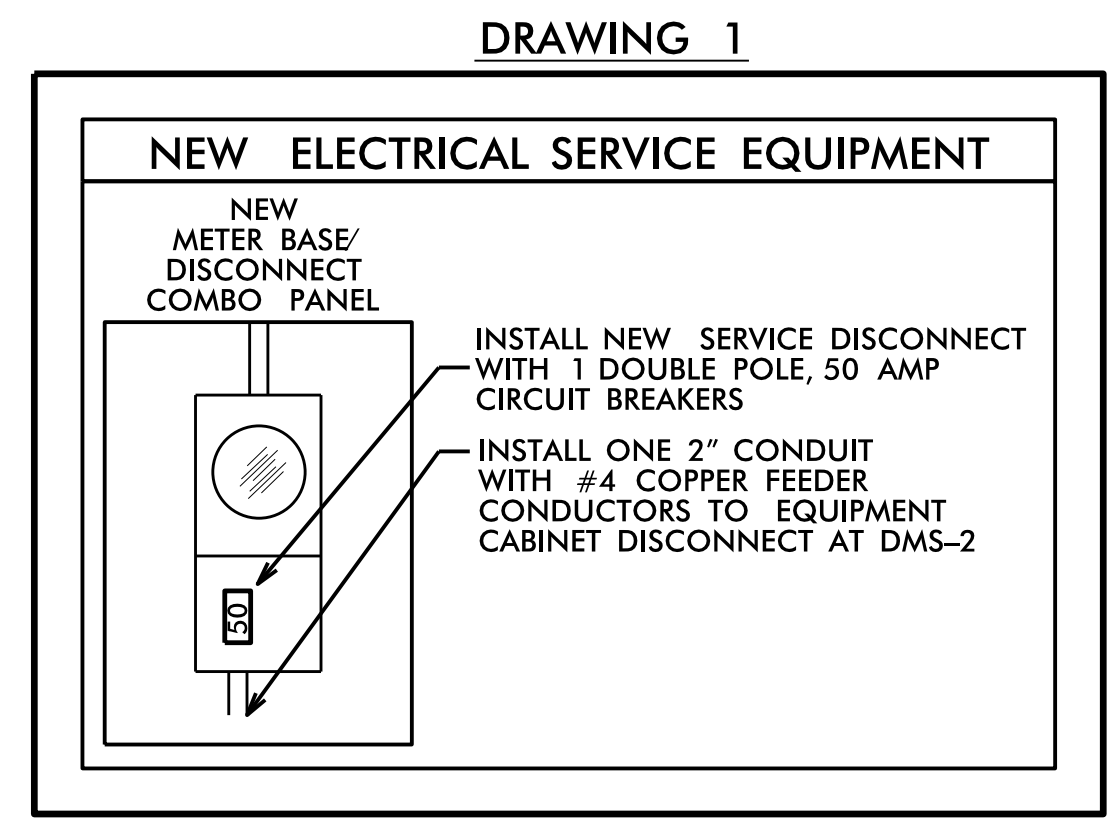
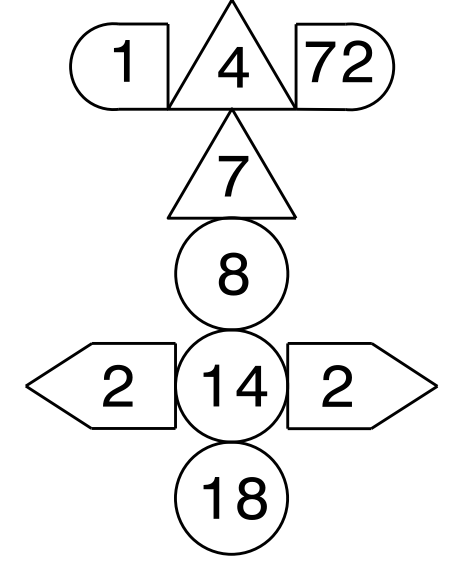
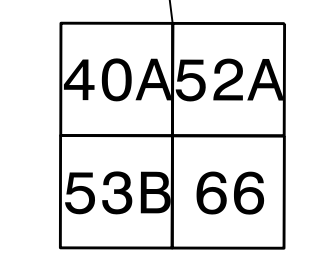
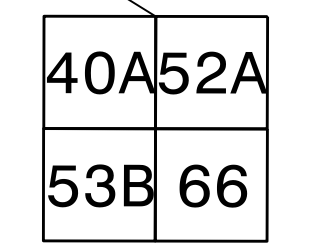
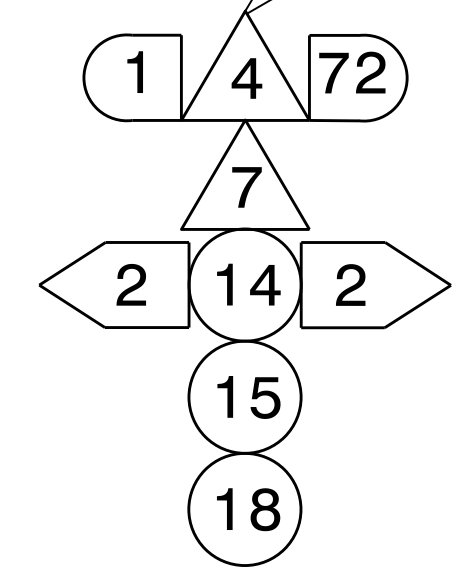
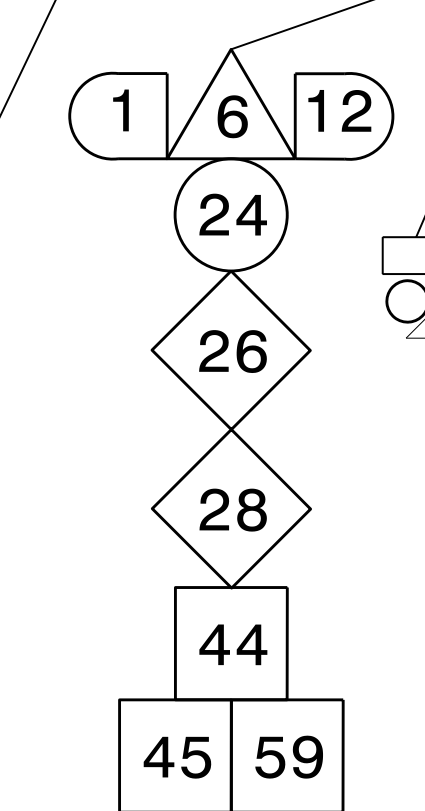

SEE DRAWING 1

DMS-2  
SEE DRAWING 2

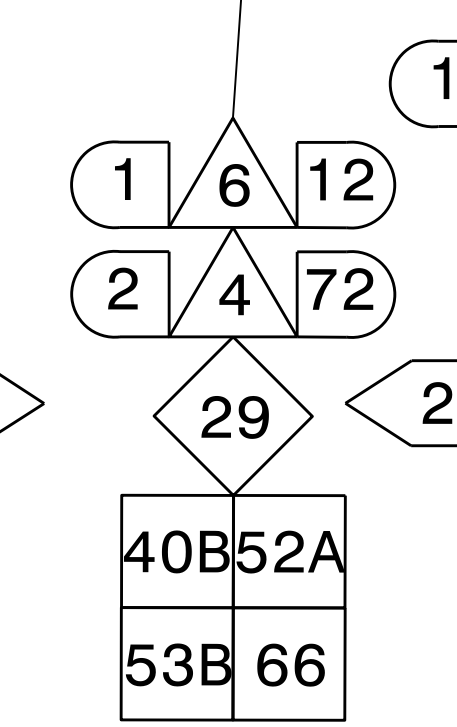

**NOTES**

1. OBTAIN FINAL DMS LOCATION APPROVAL FROM THE INCIDENT MANAGEMENT ENGINEER BEFORE INITIATING ANY WORK AT THIS LOCATION.
2. CONTACT ENGINEER TO REQUEST NCDOT SUPPLIED MODEM AT LEAST SIX WEEKS PRIOR TO INSTALLATION.

**DOCUMENT NOT CONSIDERED FINAL UNLESS ALL SIGNATURES COMPLETED**

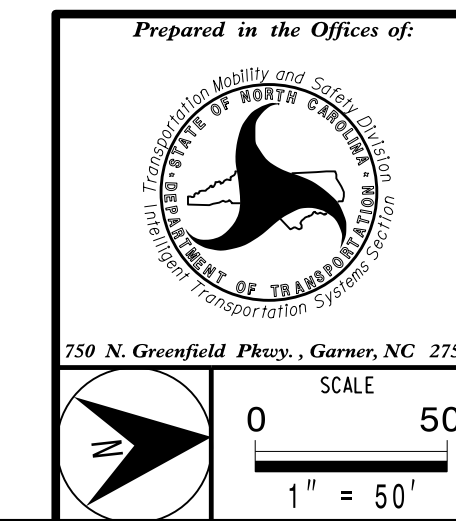

COMMUNICATIONS CABLING AND CONDUIT ROUTING PLANS	
DIVISION 09	FORSYTH CO., WINSTON-SALEM
PLAN DATE: AUGUST 2021	REVIEWED BY: A. SKUCE
PREPARED BY: B. CHRISTIAN	REVIEWED BY:
REVISIONS	INIT. DATE

