

REMOVE CONFLICTING PAVEMENT MARKING.

4:56:51 PM
 \\TCF\...5021\...pld26e.dgn
 \$\$\$USERNAME\$\$\$

HNTB HNTB NORTH CAROLINA, P.C.
 343 E. Six Forks Road, Suite 200
 Raleigh, North Carolina 27609
 NC License No: C-1554

APPROVED: *Helen Shyu*
 DATE: 11/10/2021
 SEAL
 PROFESSIONAL ENGINEER
 SEAL 042517
 HELEN SHYU

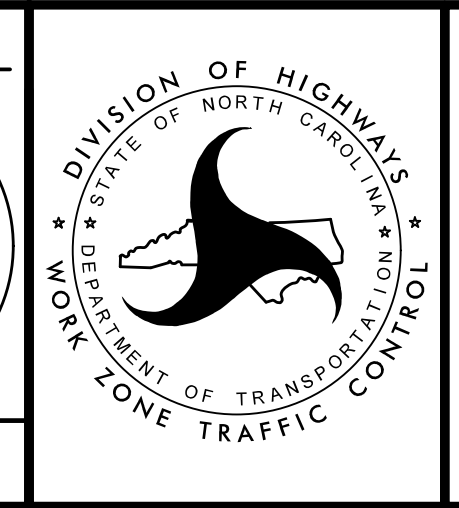

TRANSPORTATION
 MANAGEMENT PLAN
 PHASE IB
 STEPS 16.5 & 16.6
 DETAIL

DOCUMENT NOT CONSIDERED FINAL
 UNLESS ALL SIGNATURES COMPLETED

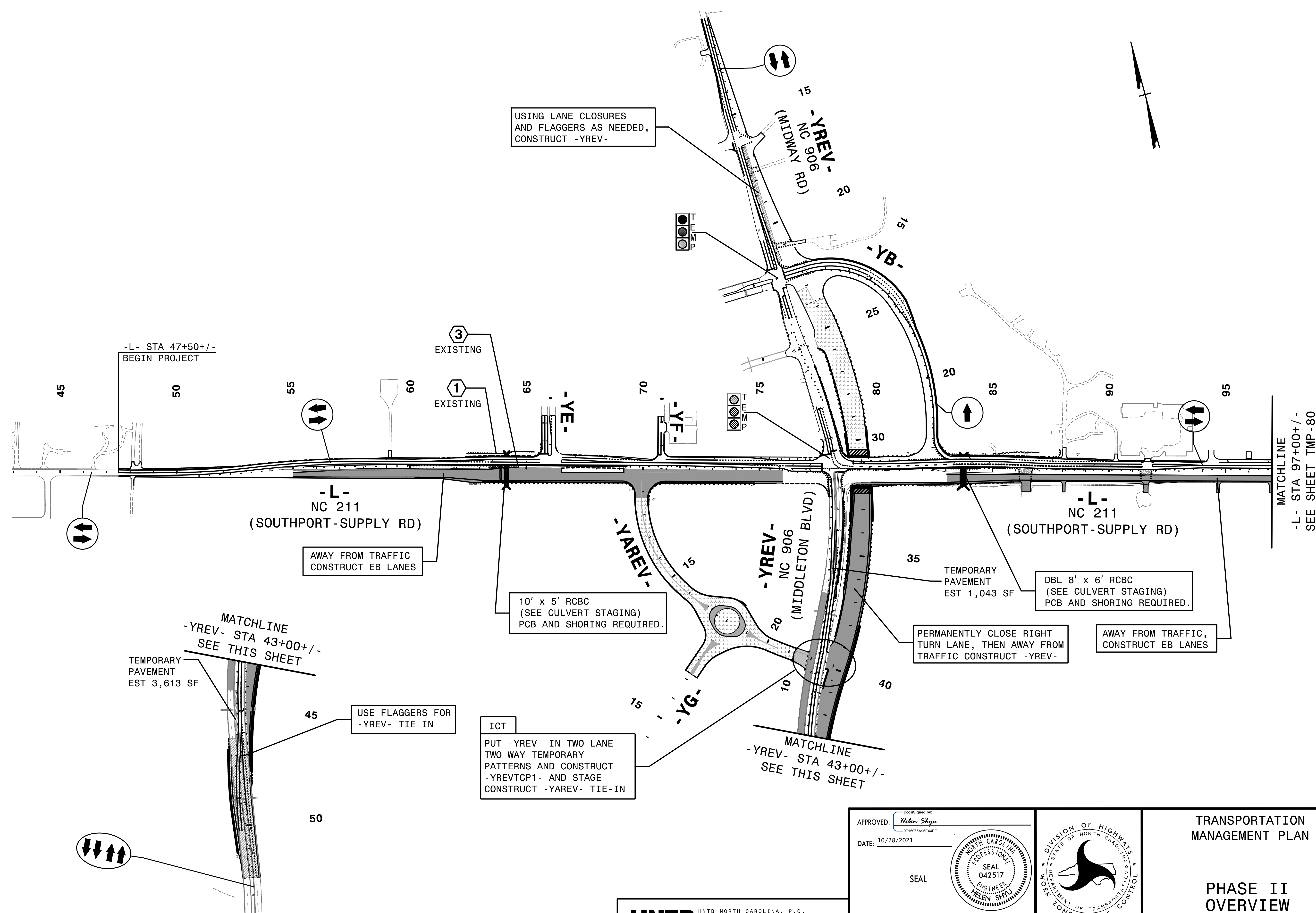

3:23:28 PM
 \\TCN\F5021\TC_P2_OVs.dgn
 \$\$\$USERNAME\$\$\$



APPROVED: *Helen Shyu*
 DATE: 10/28/2021

SEAL

DOCUMENT NOT CONSIDERED FINAL
 UNLESS ALL SIGNATURES COMPLETED

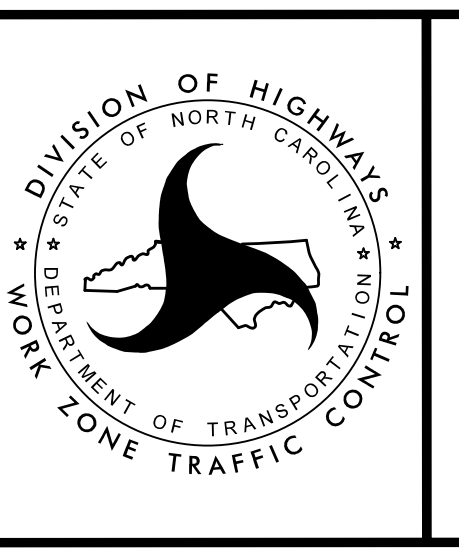

TRANSPORTATION
 MANAGEMENT PLAN

PHASE II
 OVERVIEW

PROJ. REFERENCE NO.	SHEET NO.
R-5021	TMP-80

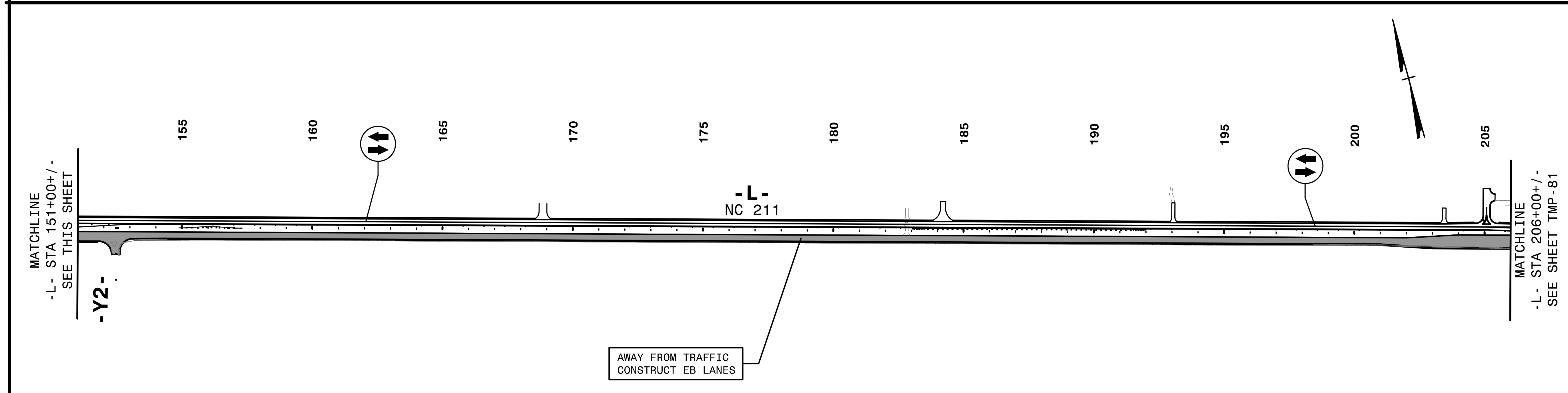
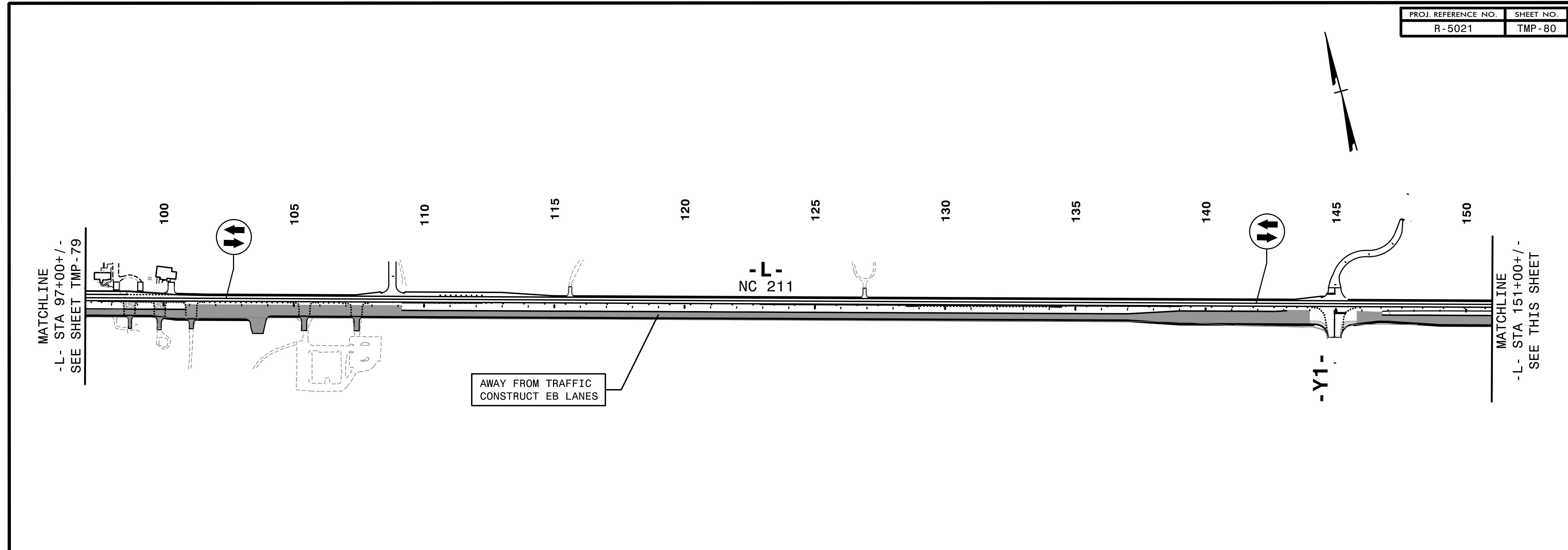

4:54:33 PM
 \\TCR\5021\TC_P2_0\vs.dgn
 \$\$\$USERNAME\$\$\$

HNTB HNTB NORTH CAROLINA, P.C.
 343 E. Six Forks Road, Suite 200
 Raleigh, North Carolina 27609
 NC License No: C-1554

APPROVED: *Helen Shyu*
 DATE: 9/9/2021

SEAL

SEAL
 NORTH CAROLINA
 PROFESSIONAL
 ENGINEER
 HELEN SHYU
 042517

DOCUMENT NOT CONSIDERED FINAL
 UNLESS ALL SIGNATURES COMPLETED

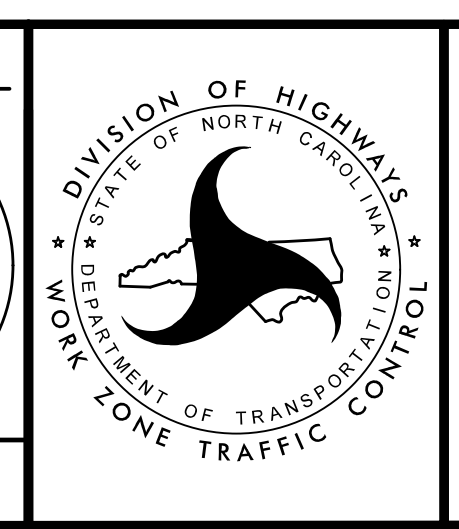

TRANSPORTATION
 MANAGEMENT PLAN

PHASE II
 OVERVIEW

PROJ. REFERENCE NO.	SHEET NO.
R-5021	TMP-81

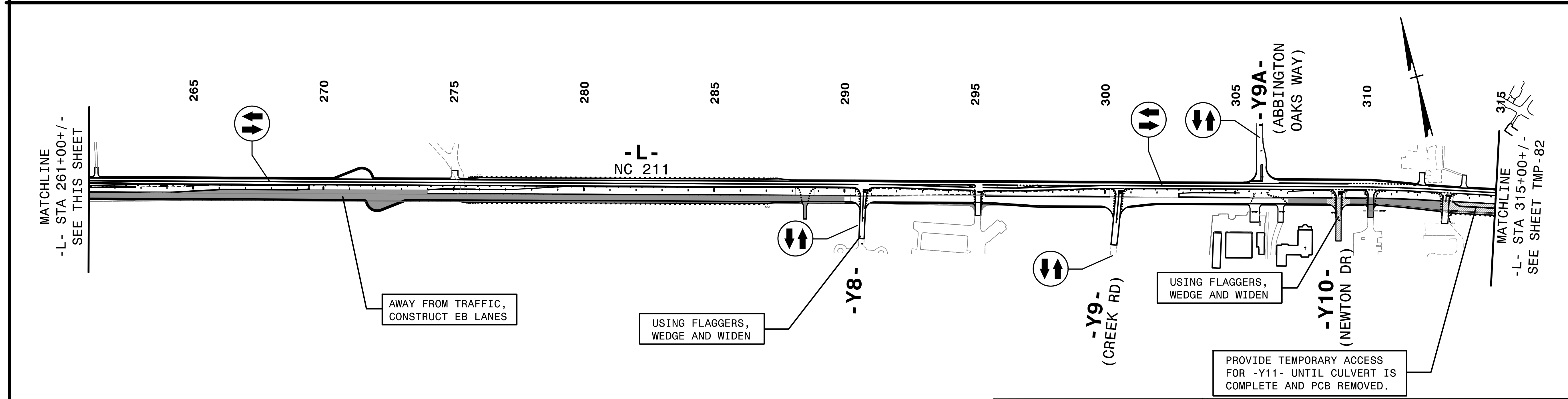
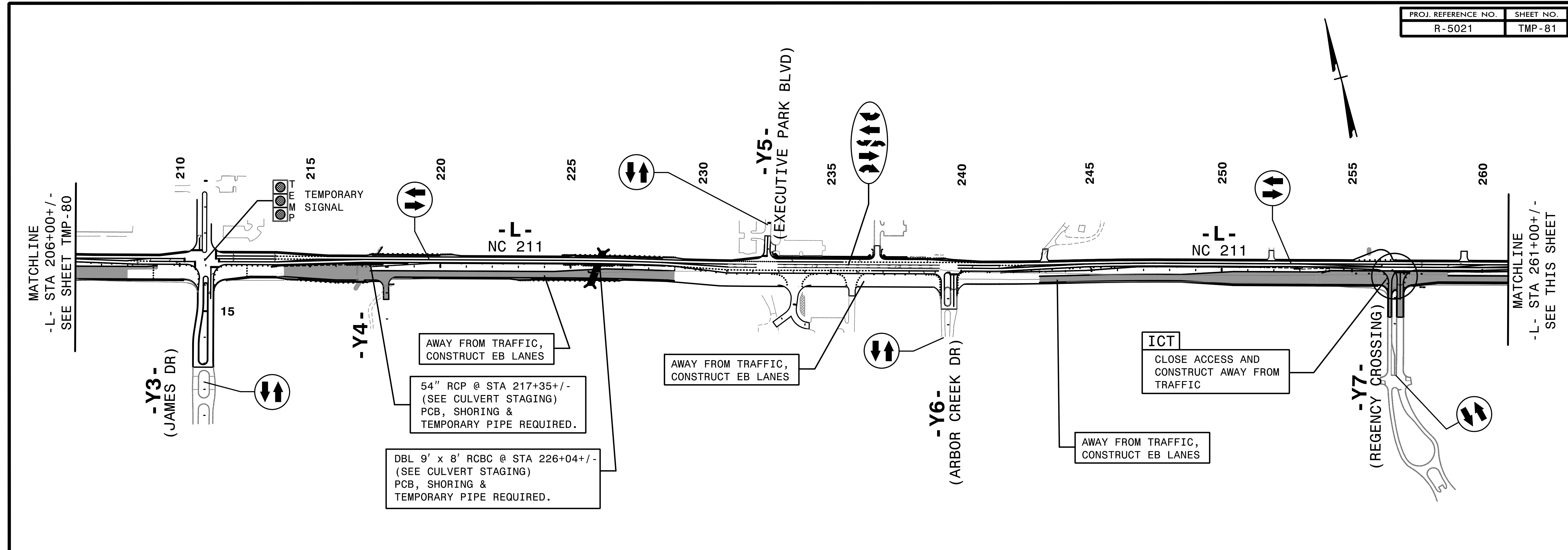

4:31:55 PM
 \\TCF\15021\10_P2_0\vs.dgn
 \$\$\$USERNAME\$\$\$

HNTB
 HNTB NORTH CAROLINA, P.C.
 343 E. Six Forks Road, Suite 200
 Raleigh, North Carolina 27609
 NC License No: C-1554

APPROVED: *Helen Shyu*
 DATE: 9/9/2021
 SEAL
 DOCUMENT NOT CONSIDERED FINAL
 UNLESS ALL SIGNATURES COMPLETED

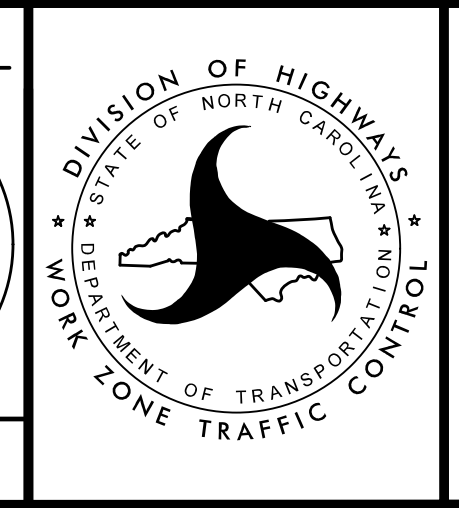

DIVISION OF HIGHWAYS
 DEPARTMENT OF TRANSPORTATION
 NORTH CAROLINA
 WORK ZONE TRAFFIC CONTROL

TRANSPORTATION
 MANAGEMENT PLAN

PHASE II
 OVERVIEW

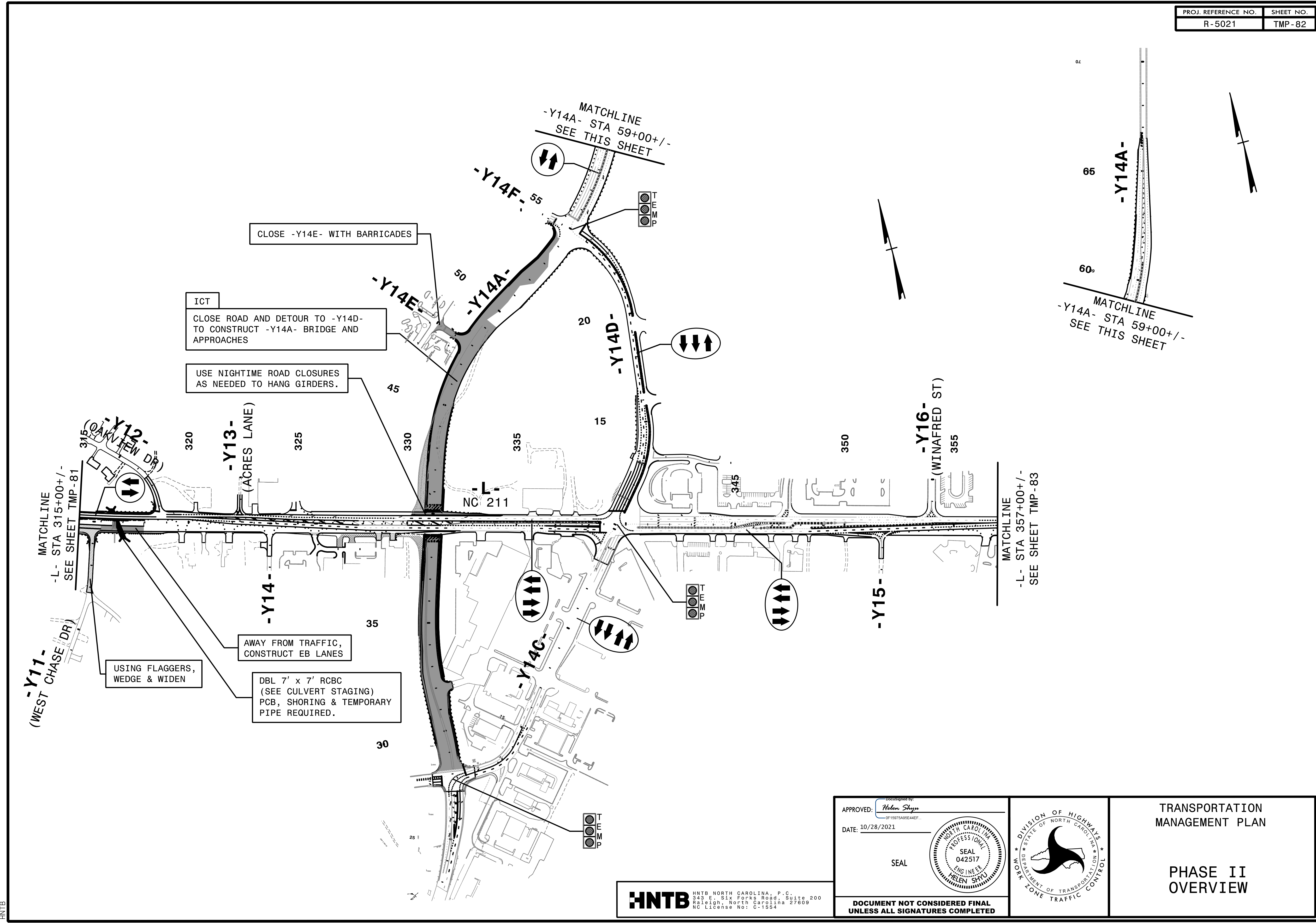

10/27/2021
10:17:07 AM
TCF-V5021-1c_P2_0V.s.dgn
HNTB

HNTB
HNTB NORTH CAROLINA, P.C.
343 E. Six Forks Road, Suite 200
Raleigh, North Carolina 27609
NC License No: C-1554

APPROVED: Helen Shyu
DATE: 10/28/2021
SEAL
SEAL
042517
ENGINEER
HELEN SHYU

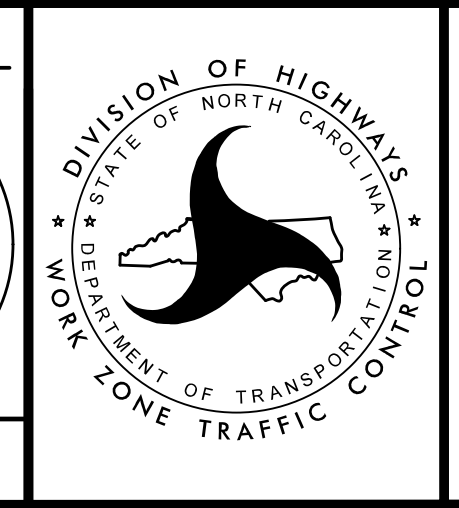

TRANSPORTATION
MANAGEMENT PLAN

PHASE II
OVERVIEW

DOCUMENT NOT CONSIDERED FINAL
UNLESS ALL SIGNATURES COMPLETED

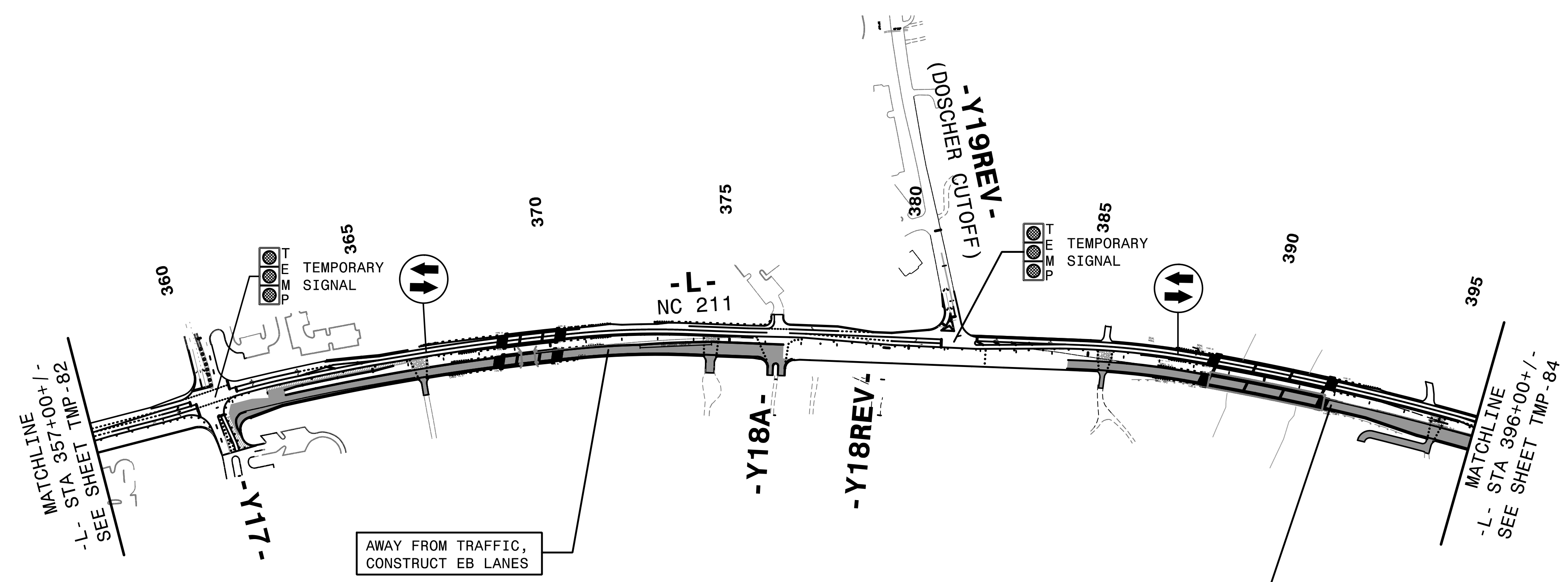

I:\49\23 AM
T:\CP\5021\Tc_P2_0\vs.dgn
\$\$\$\$\$USERNAME\$\$\$\$\$

HNTB HNTB NORTH CAROLINA, P.C.
343 E. Six Forks Road, Suite 200
Raleigh, North Carolina 27609
NC License No: C-1554

APPROVED: *Helen Shyu*
DATE: 9/9/2021
SEAL
DOCUMENT NOT CONSIDERED FINAL
UNLESS ALL SIGNATURES COMPLETED

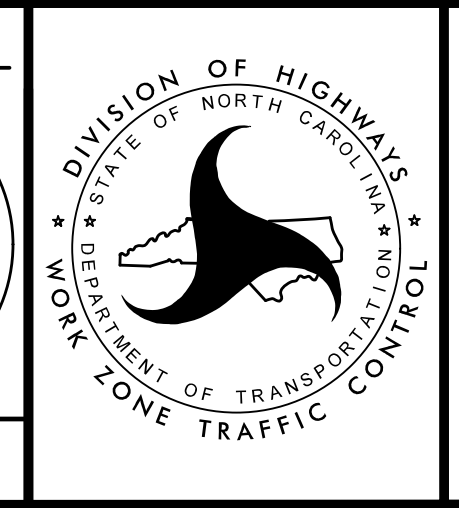
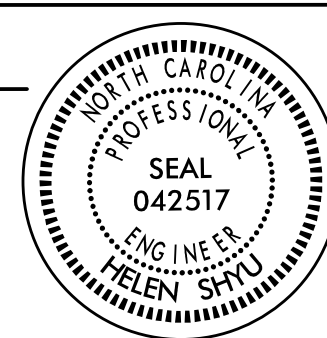

TRANSPORTATION
MANAGEMENT PLAN

PHASE II
OVERVIEW

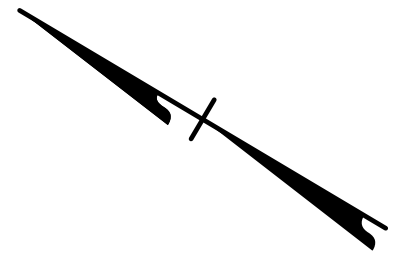
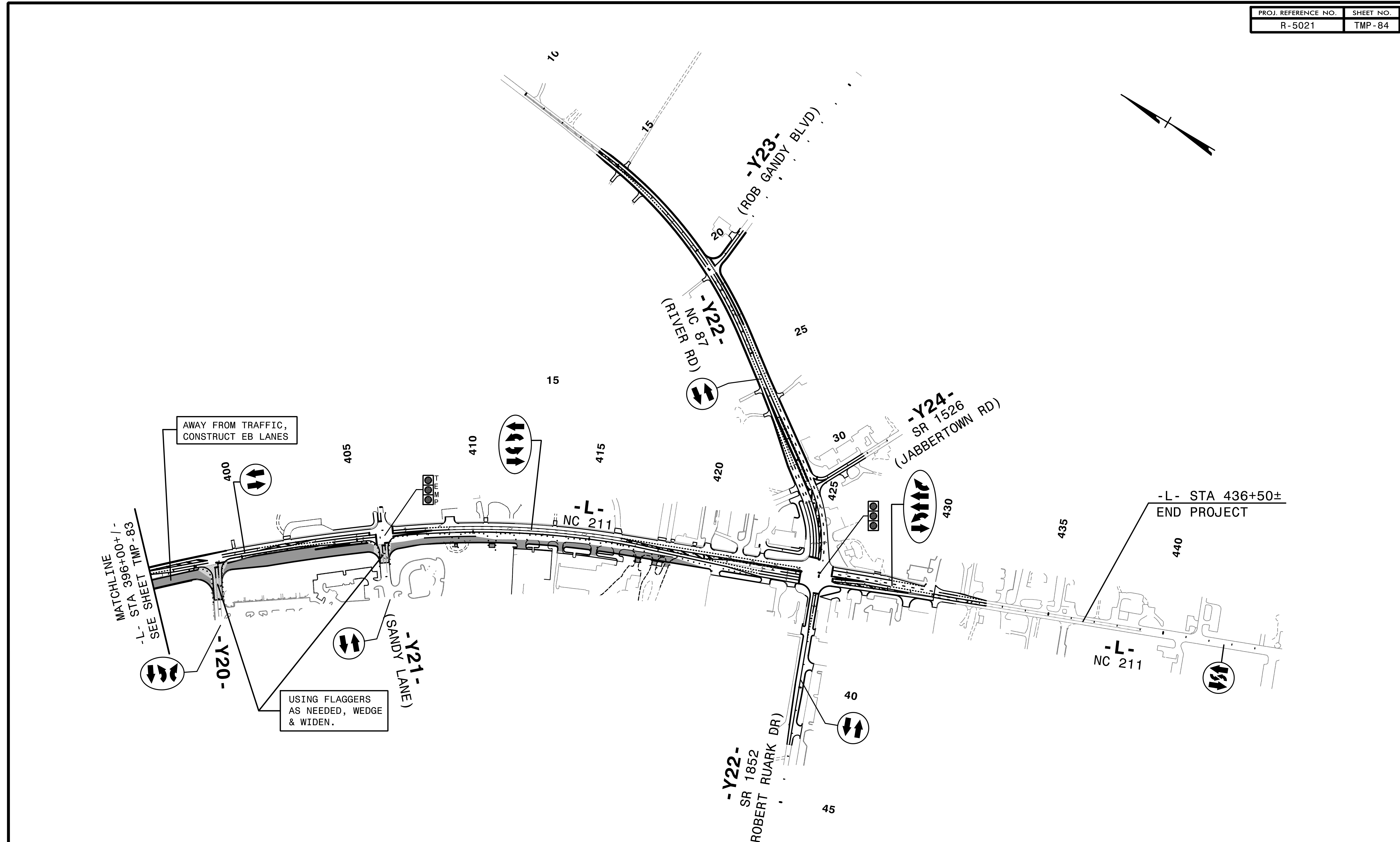

2/6/2019
 T:\CP\5021\to_P2_0\vs.dgn
 HNTB

HNTB
 HNTB NORTH CAROLINA, P.C.
 343 E. Six Forks Road, Suite 200
 Raleigh, North Carolina 27609
 NC License No: C-1554

APPROVED: *Helen Shyu*
 DATE: 2/6/2019
 SEAL
 DOCUMENT NOT CONSIDERED FINAL
 UNLESS ALL SIGNATURES COMPLETED

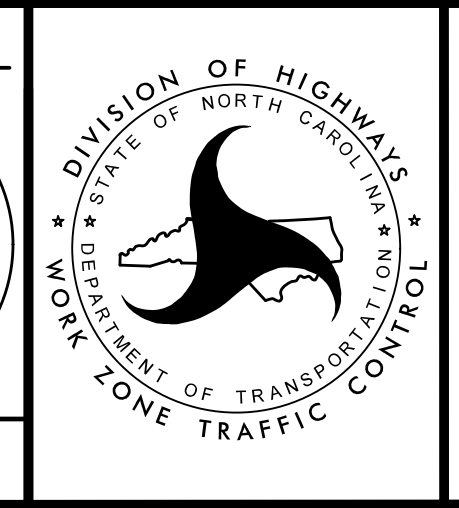
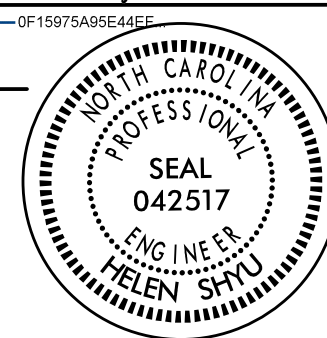

TRANSPORTATION
 MANAGEMENT PLAN

 PHASE II
 OVERVIEW

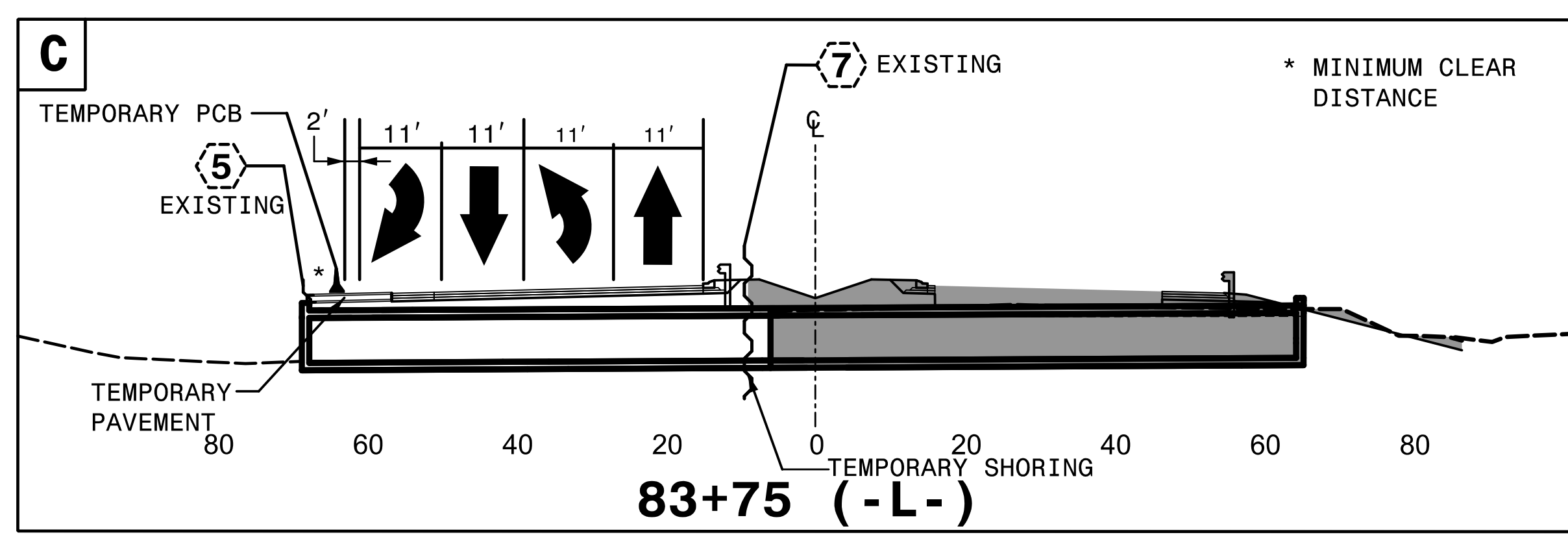
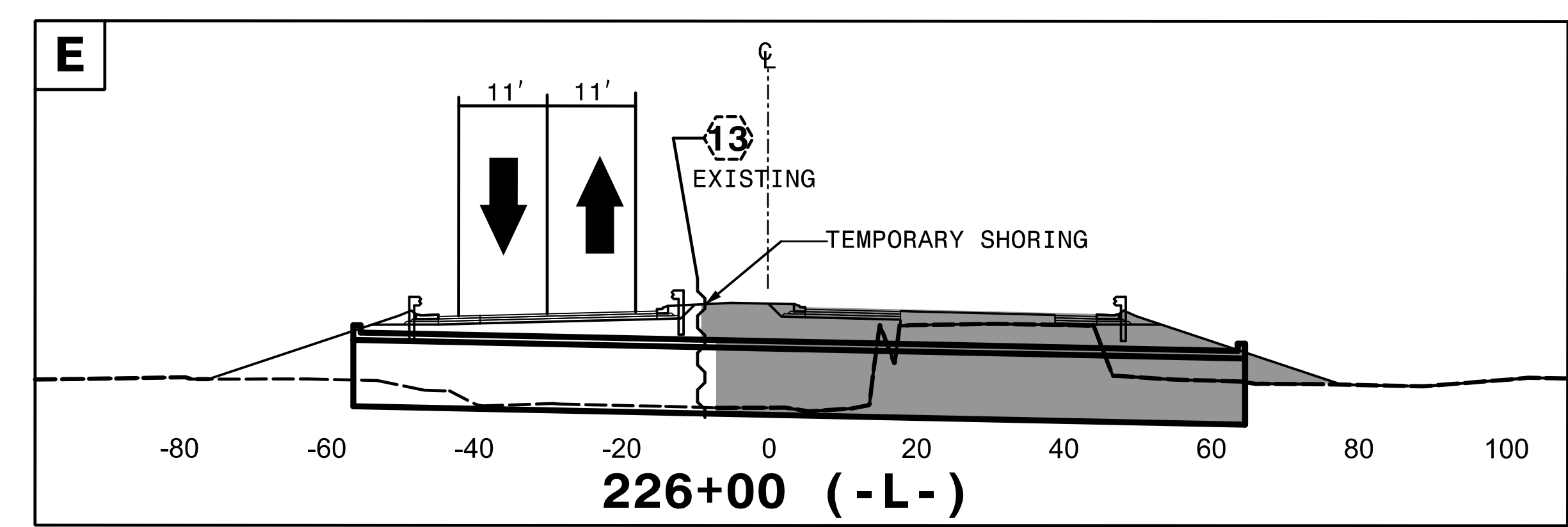
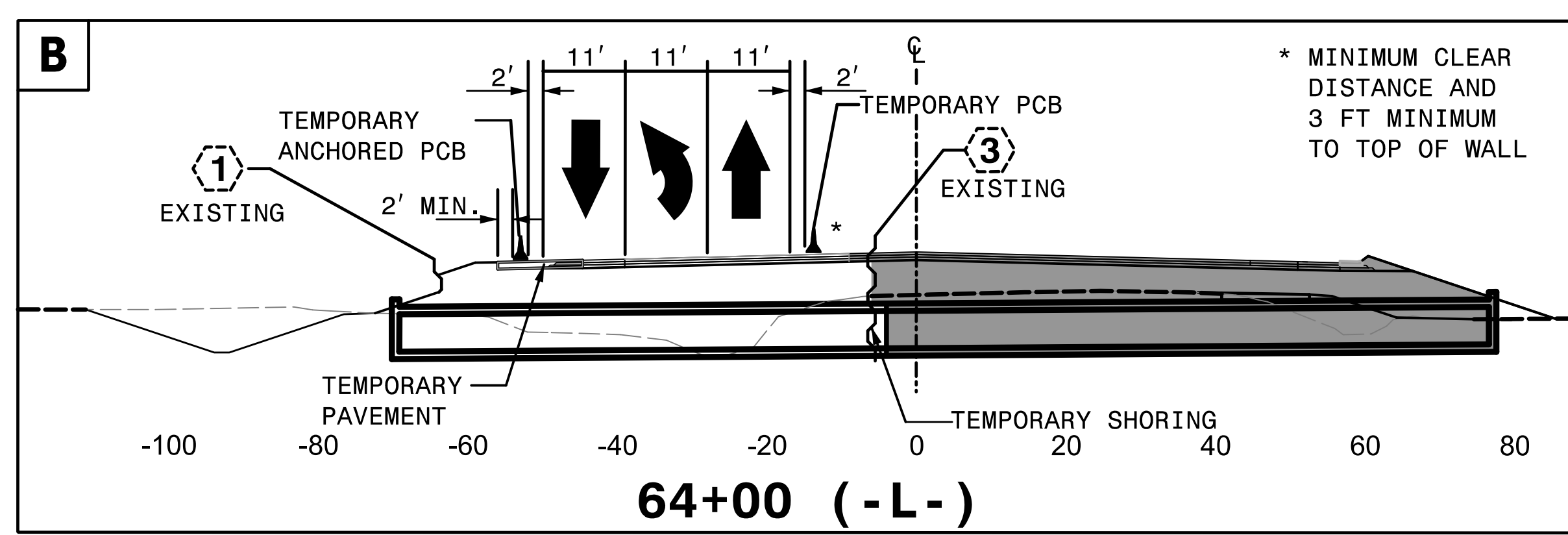
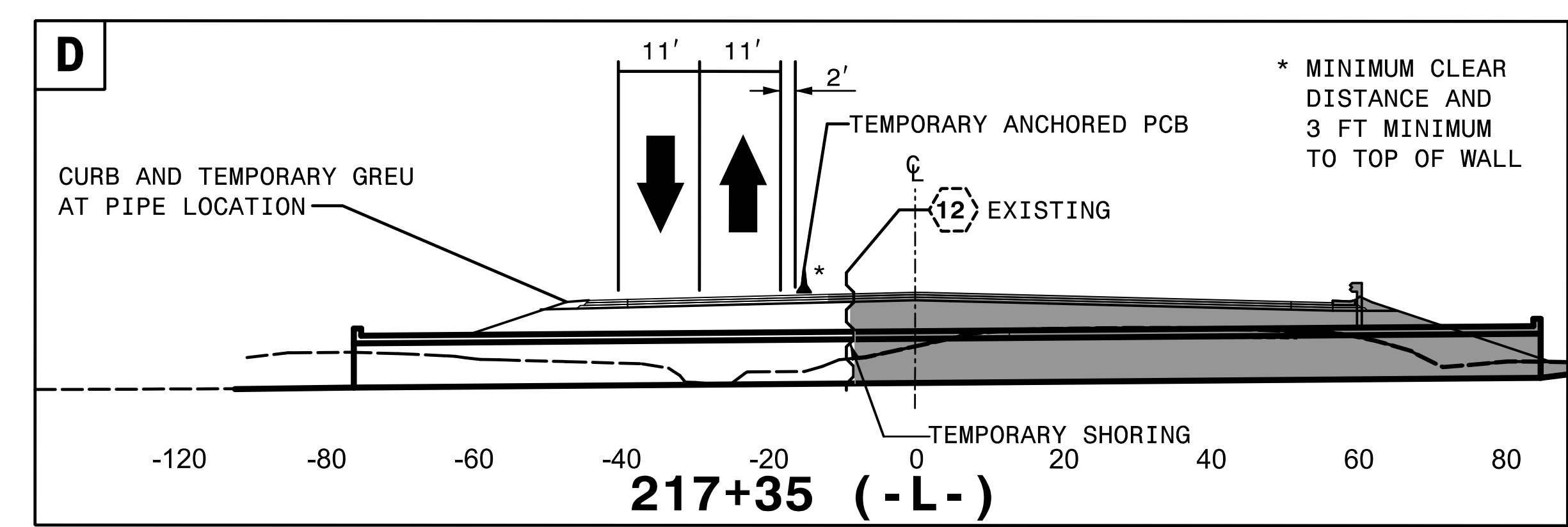
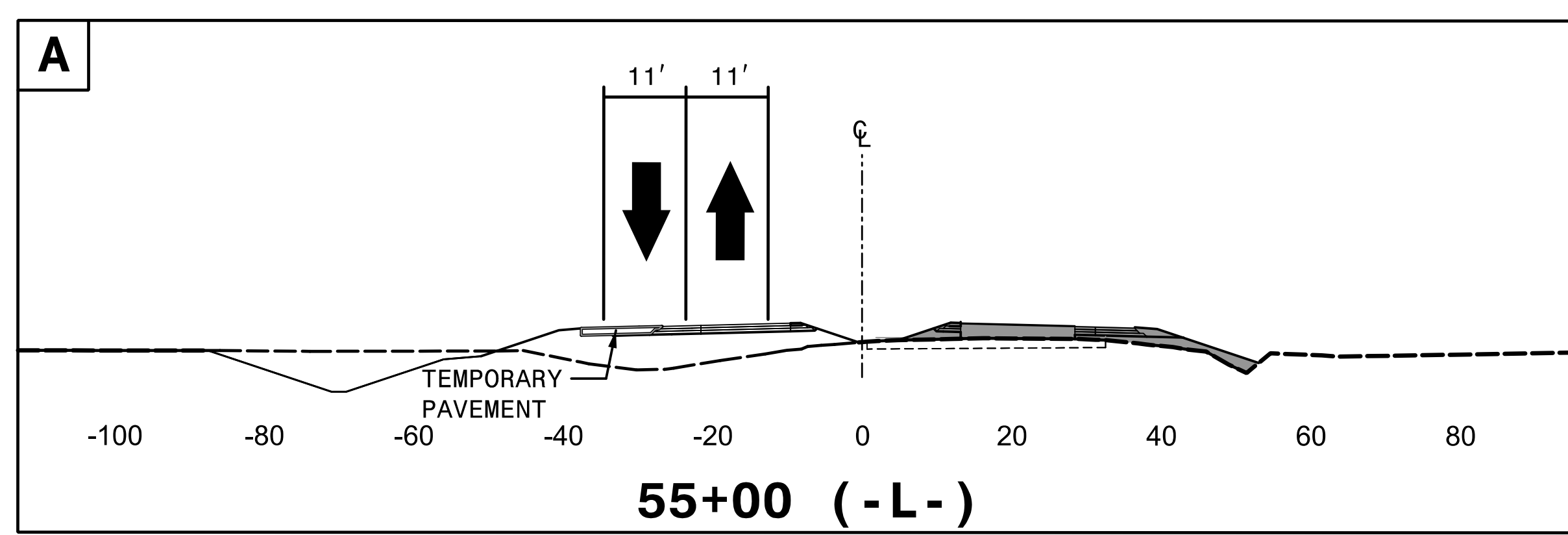

F: -L- STA 316+68+/-, SEE TMP-98
G: -YREV- STA 34+00+/-, SEE TMP-88

3:23:38 PM
 \\TC\PROJECTS\5021\TC_P2cuts.dgn
 \$\$\$USERNAME\$\$\$



APPROVED: *Helen Shyu*

DATE: 10/28/2021

SEAL

SEAL

DOCUMENT NOT CONSIDERED FINAL UNLESS ALL SIGNATURES COMPLETED

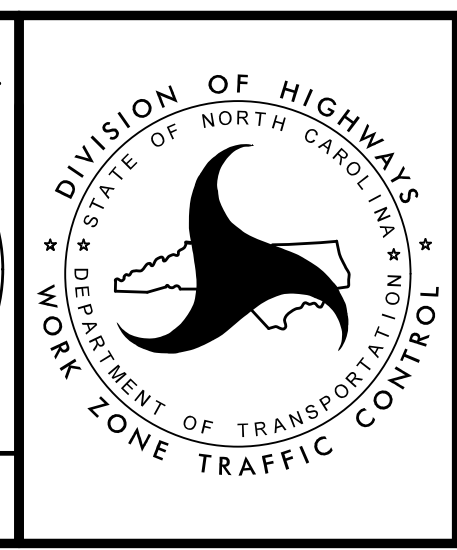

TRANSPORTATION MANAGEMENT PLAN

PHASE II CUT SECTIONS

PROJ. REFERENCE NO.	SHEET NO.
R-5021	TMP-86

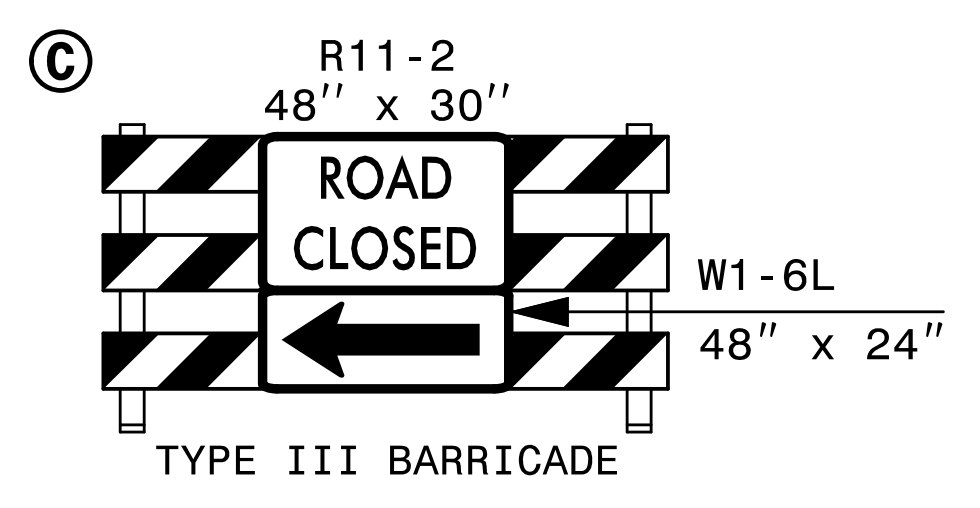

45

50

55

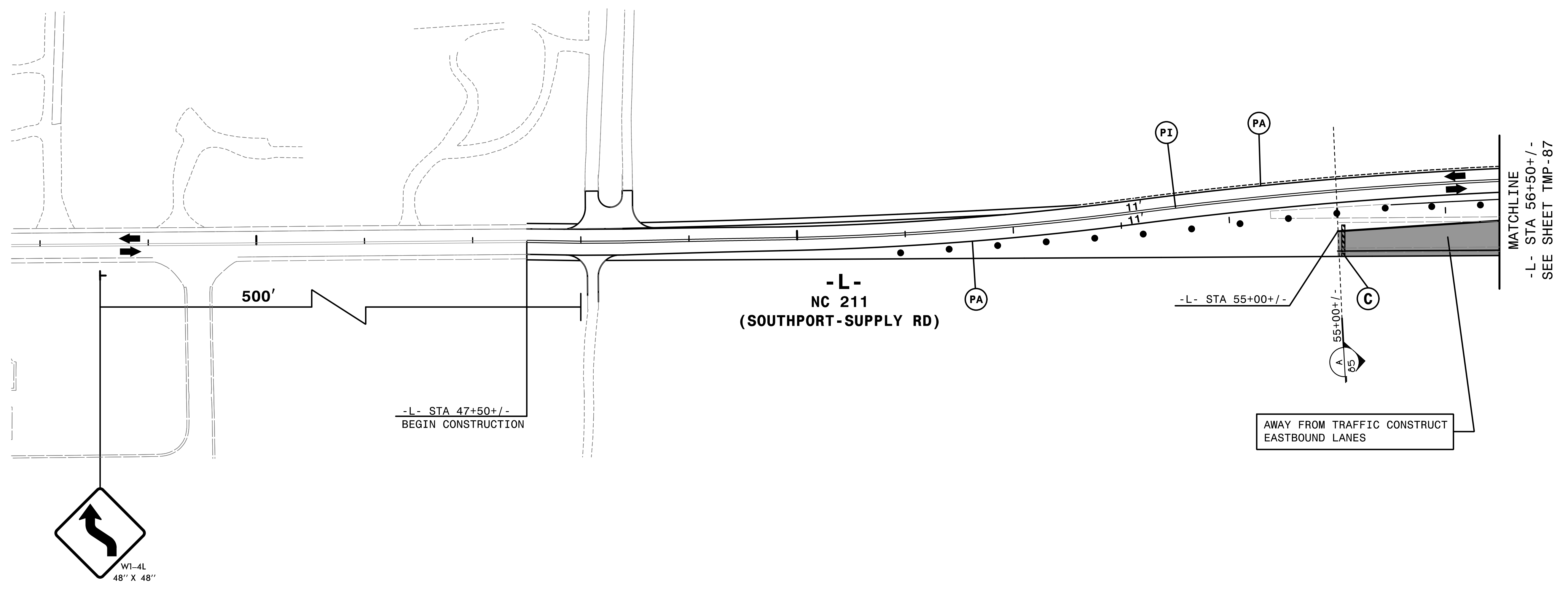
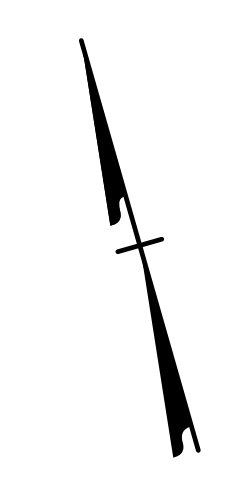

2/6/2019
C:\CP\5021\to_p2.dwg
HNTB

HNTB HNTB NORTH CAROLINA, P.C.
343 E. Six Forks Road, Suite 200
Raleigh, North Carolina 27609
NC License No: C-1554

APPROVED: *Helen Skyy*
DATE: 2/6/2019
SEAL

 DOCUMENT NOT CONSIDERED FINAL
UNLESS ALL SIGNATURES COMPLETED

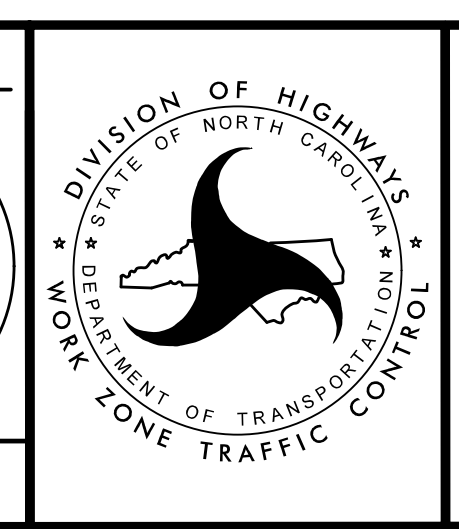

TRANSPORTATION
MANAGEMENT PLAN

PHASE II
DETAIL

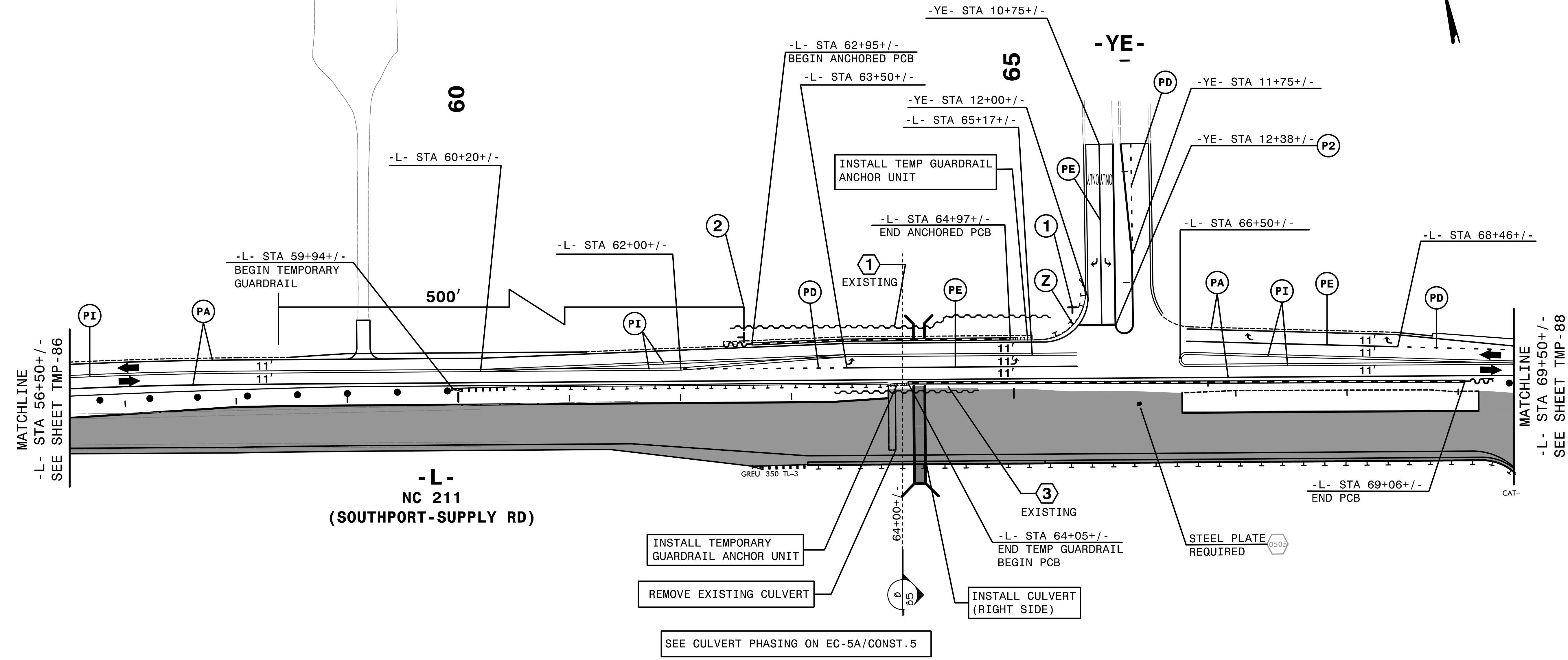
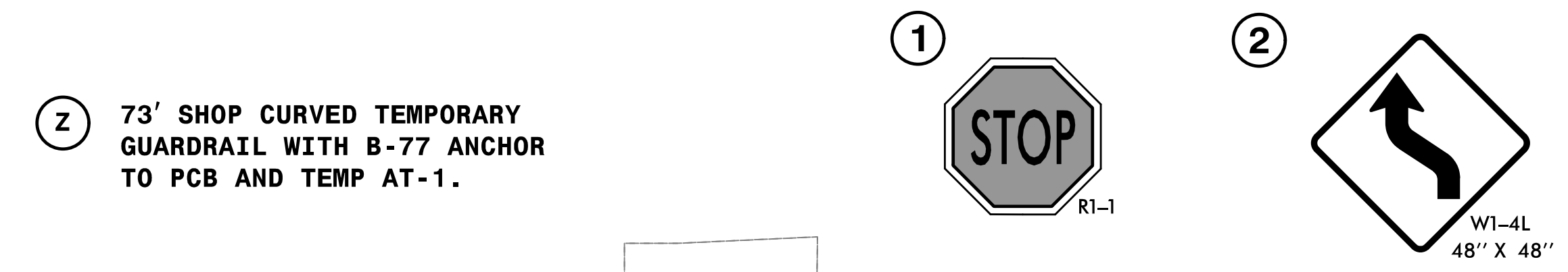

MATCHLINE
-L- STA 56+50+/-
SEE SHEET TMP-86

MATCHLINE
-L- STA 69+50+/-
SEE SHEET TMP-88

-L-
NC 211
(SOUTHPORT-SUPPLY RD)

INSTALL TEMPORARY
GUARDRAIL ANCHOR UNIT

REMOVE EXISTING CULVERT

SEE CULVERT PHASING ON EC-5A/CONST.5

INSTALL CULVERT
(RIGHT SIDE)

STEEL PLATE
REQUIRED

3:23:40 PM
\\TCF\5021\TC_P2\d2.dgn
\$\$\$\$\$USERNAME\$\$\$\$\$

HNTB
HNTB NORTH CAROLINA, P.C.
343 E. Six Forks Road, Suite 200
Raleigh, North Carolina 27609
NC License No: C-1554

APPROVED: *Helen Shyu*
DATE: 10/28/2021

SEAL

**DOCUMENT NOT CONSIDERED FINAL
UNLESS ALL SIGNATURES COMPLETED**

DIVISION OF HIGHWAYS
STATE OF NORTH CAROLINA
DEPARTMENT OF TRANSPORTATION
WORK ZONE TRAFFIC CONTROL

TRANSPORTATION
MANAGEMENT PLAN

**PHASE II
DETAIL**

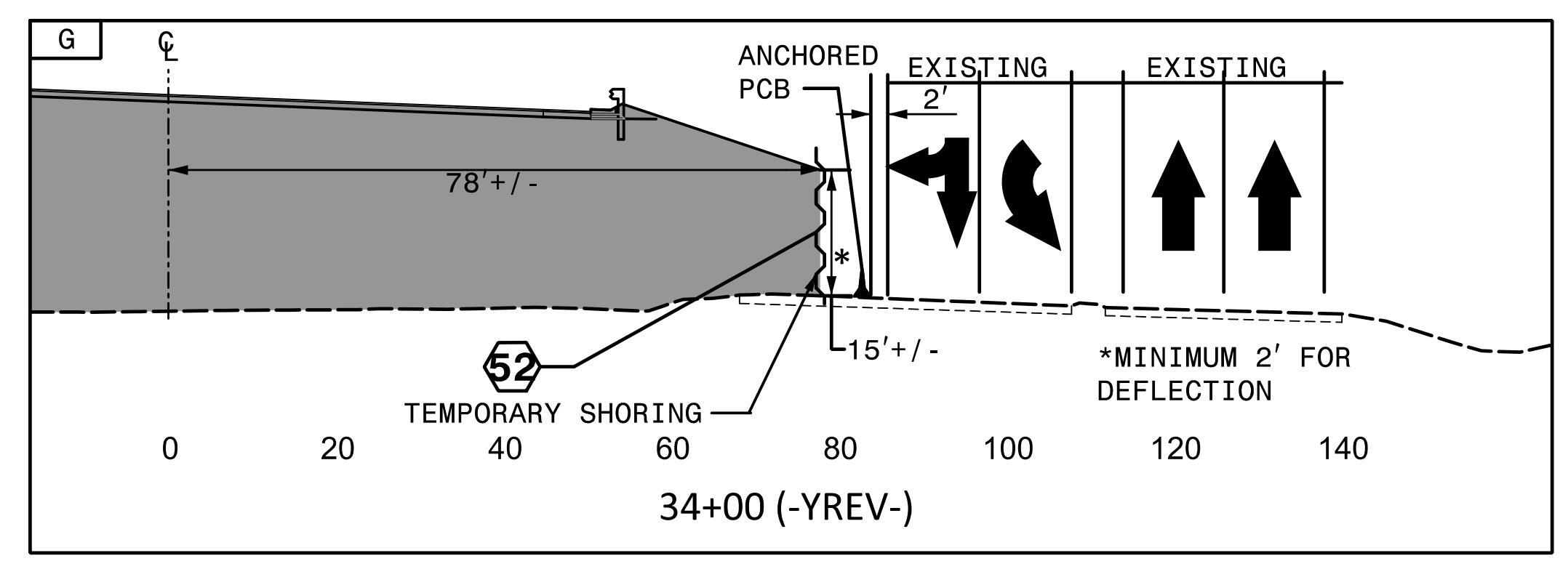

REMOVE CONFLICTING PAVEMENT MARKING.

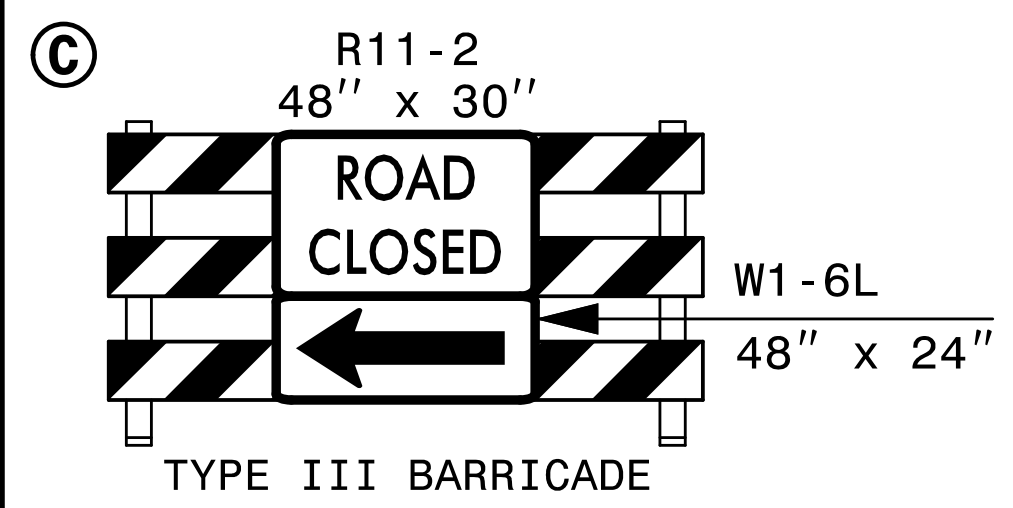
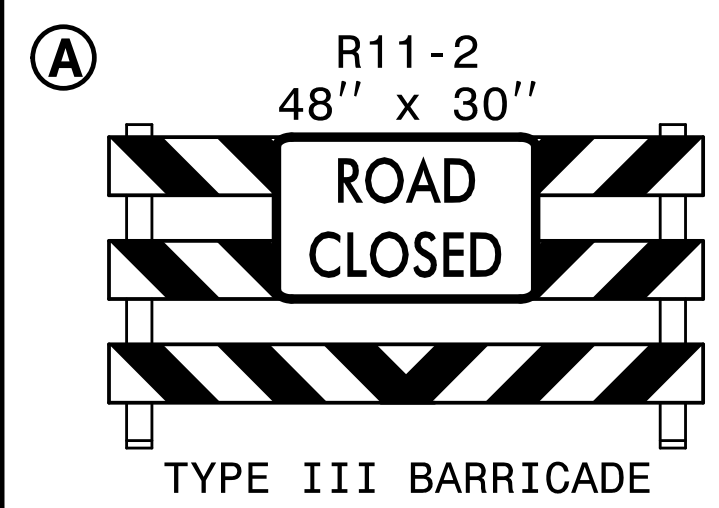
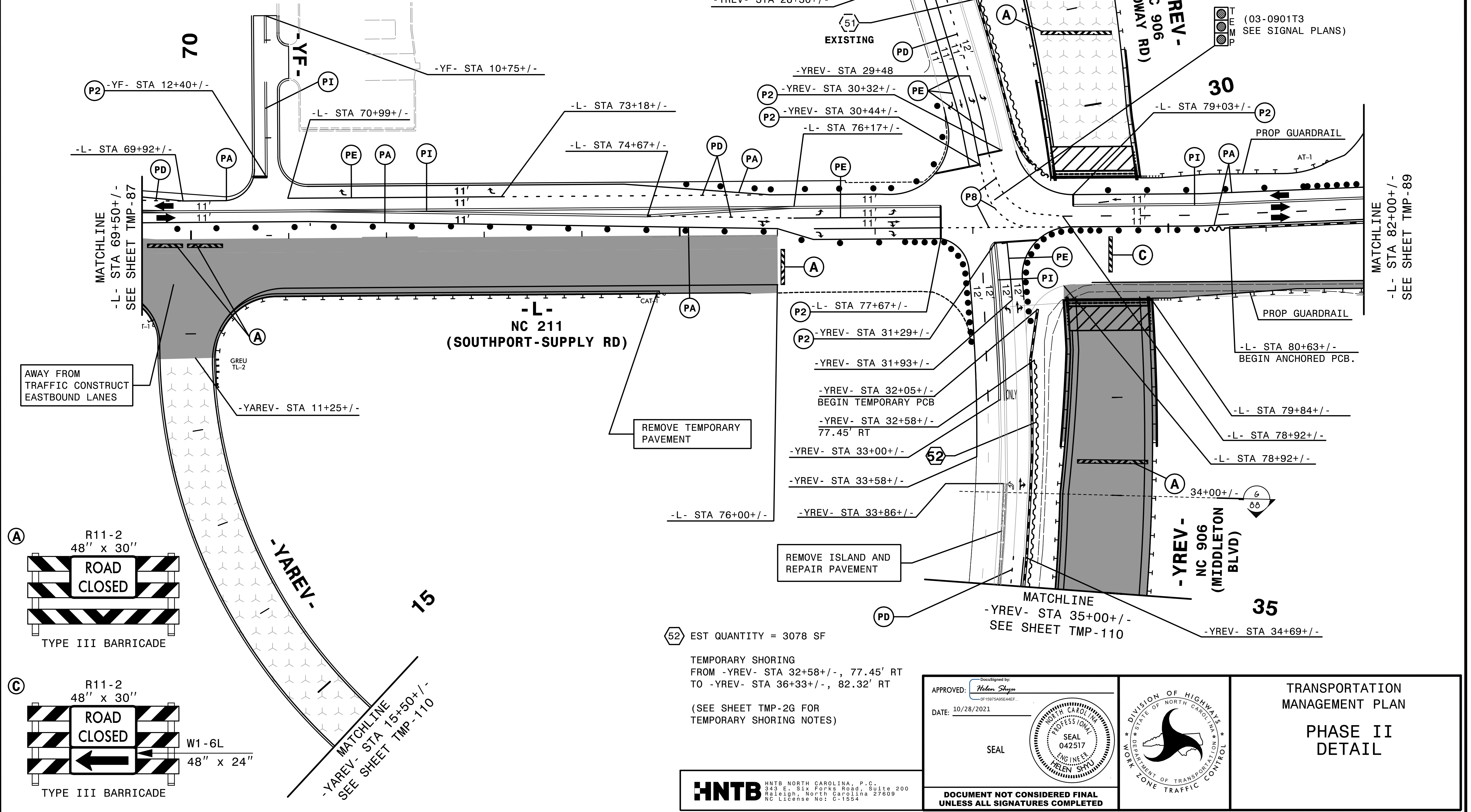

HNTB
HNTB NORTH CAROLINA, P.C.
343 E. Six Forks Road, Suite 200
Raleigh, North Carolina 27609
NC License No: C-1554

APPROVED: *Helen Shyu*
DATE: 10/28/2021
SEAL
DOCUMENT NOT CONSIDERED FINAL UNLESS ALL SIGNATURES COMPLETED

DIVISION OF HIGHWAYS
STATE OF NORTH CAROLINA
DEPARTMENT OF TRANSPORTATION
WORK ZONE TRAFFIC CONTROL

TRANSPORTATION MANAGEMENT PLAN
PHASE II
DETAIL

3:23:44 PM
...TCP...5021...c.p2d3.dgn
...\$USERNAME\$\$\$

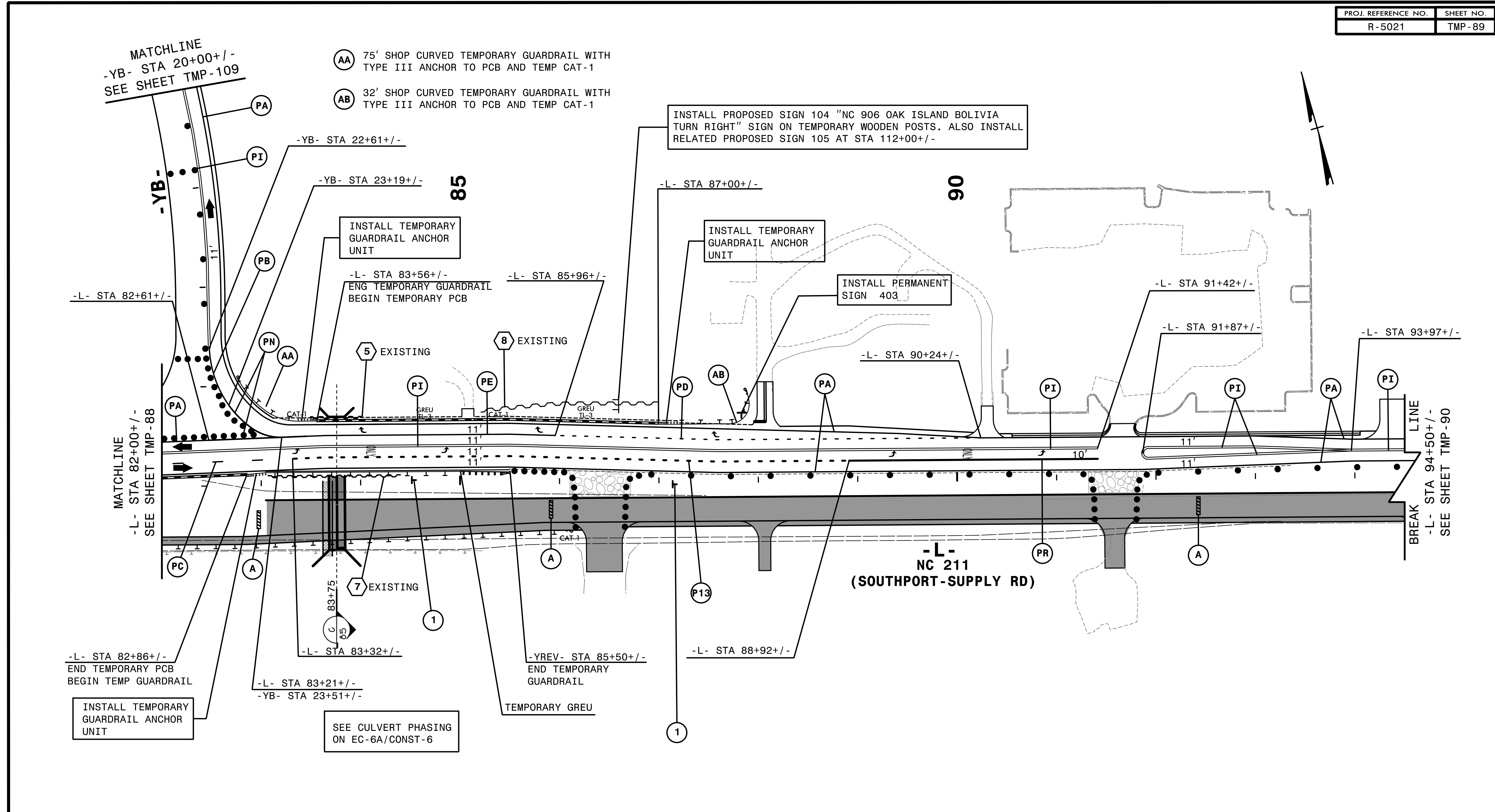

2/6/2019
HNTB

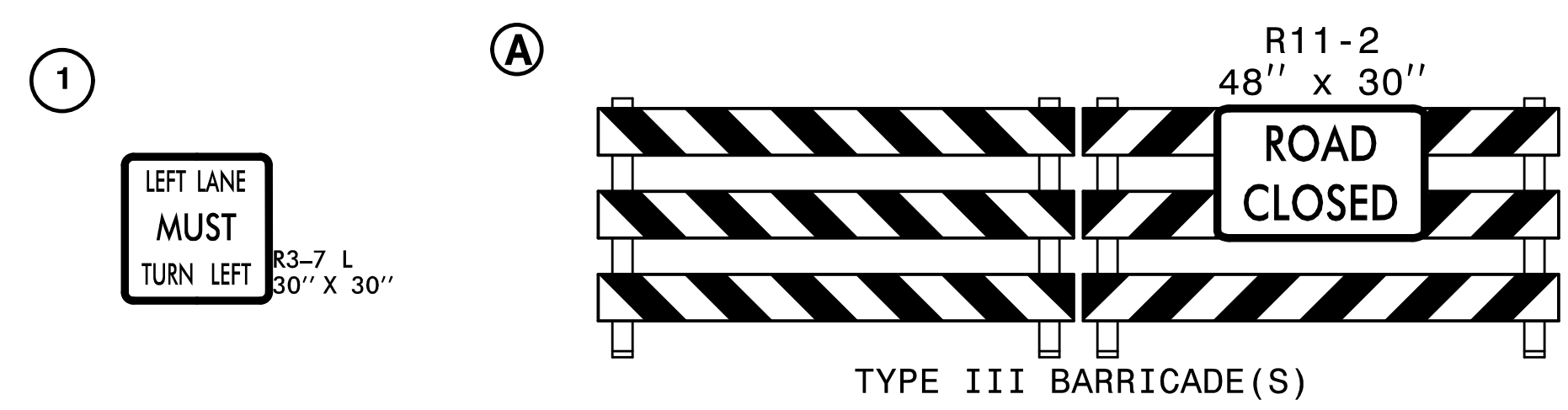

HNTB
 HNTB NORTH CAROLINA, P.C.
 343 E. Six Forks Road, Suite 200
 Raleigh, North Carolina 27609
 NC License No: C-1554

APPROVED: *Helen Shyu*
 DATE: 2/6/2019
 SEAL
 PROFESSIONAL SEAL
 ENGINEER
 HELEN SHYU

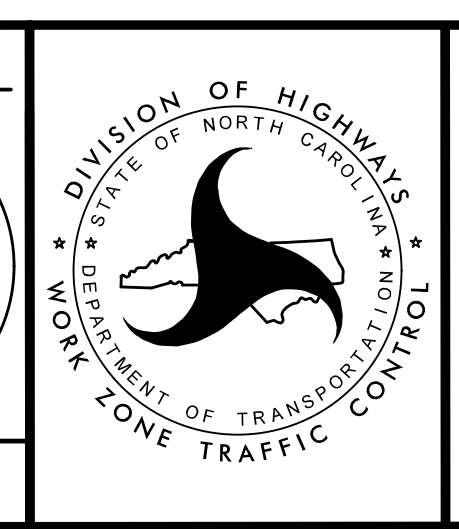

TRANSPORTATION
 MANAGEMENT PLAN
 PHASE II
 DETAIL

DOCUMENT NOT CONSIDERED FINAL
 UNLESS ALL SIGNATURES COMPLETED

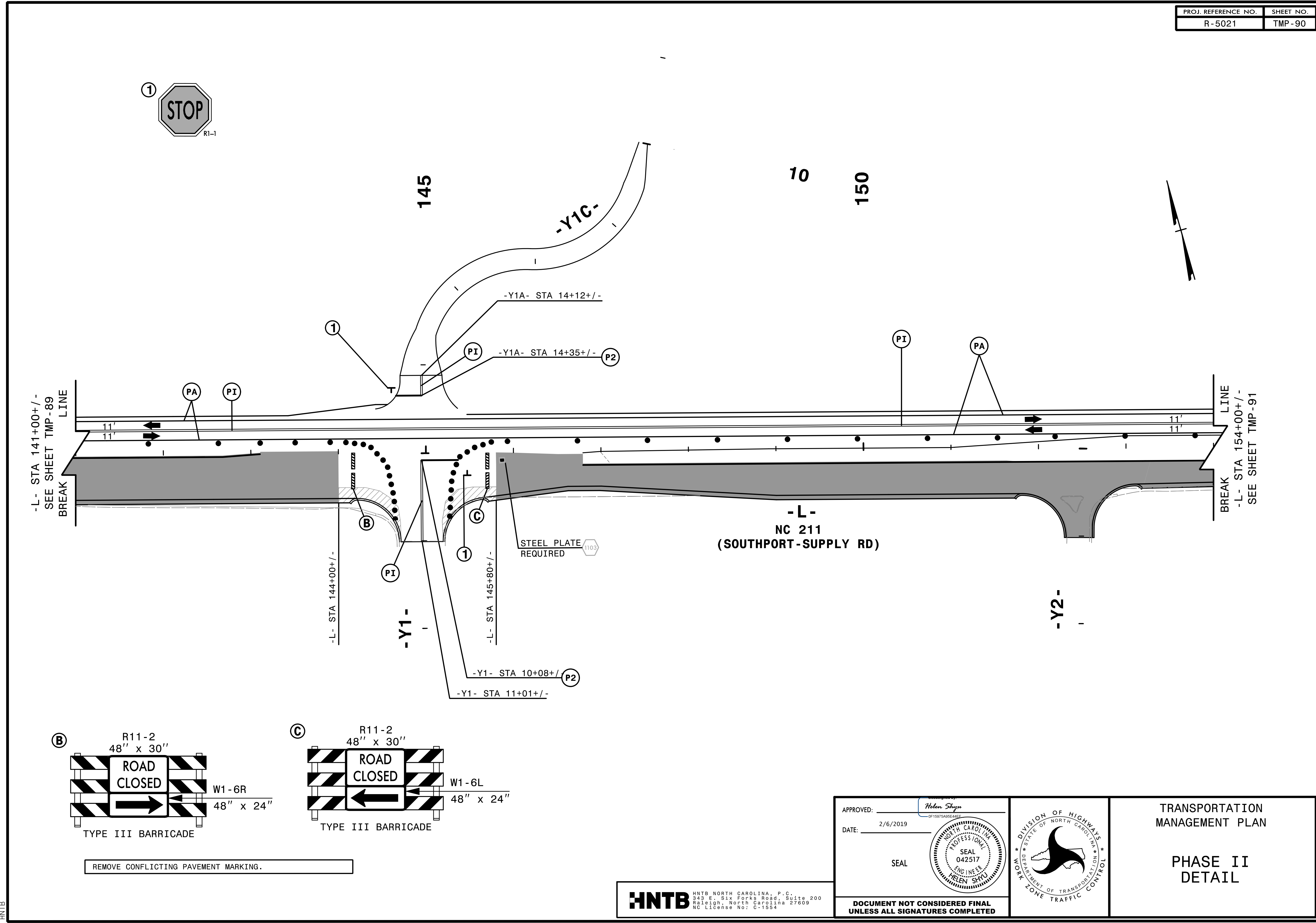

2/6/2019
HNTB

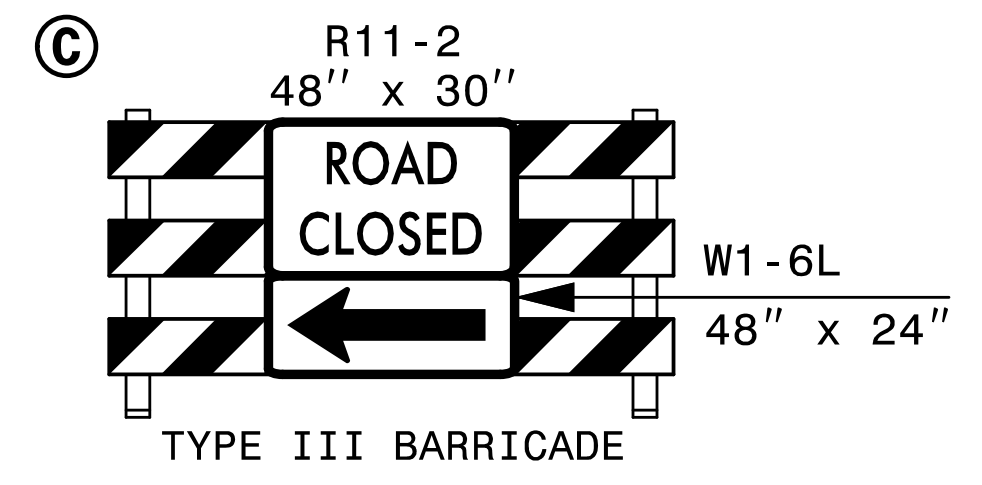
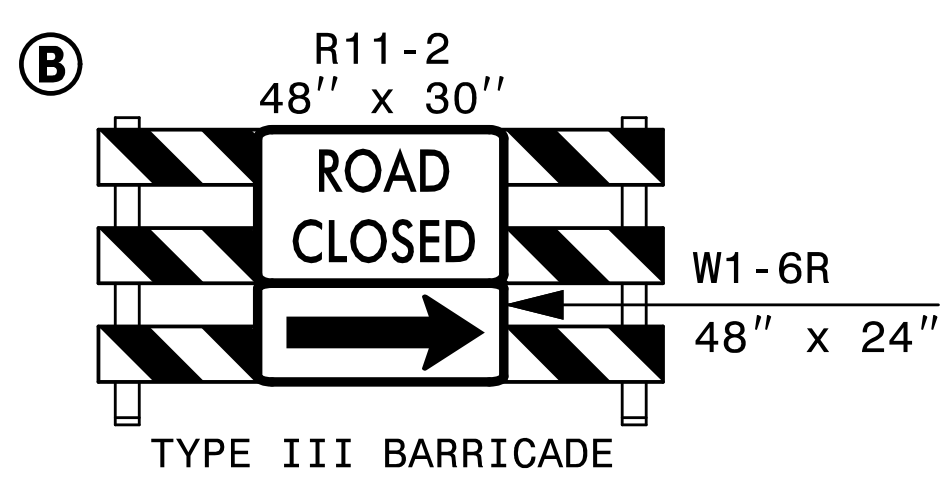

REMOVE CONFLICTING PAVEMENT MARKING.

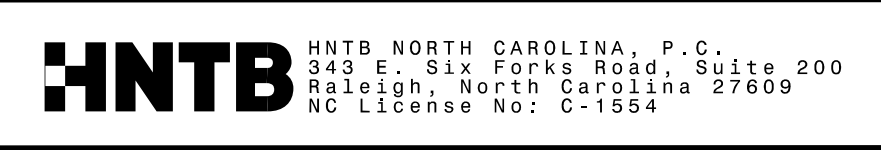

APPROVED: *Helen Skyy*
DATE: 2/6/2019
SEAL
DOCUMENT NOT CONSIDERED FINAL
UNLESS ALL SIGNATURES COMPLETED

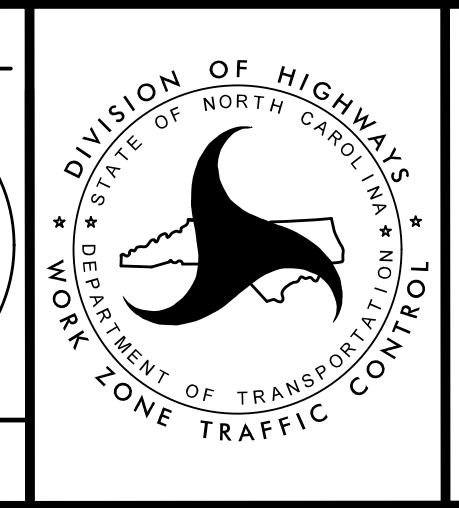

TRANSPORTATION
MANAGEMENT PLAN

PHASE II
DETAIL

PROJ. REFERENCE NO.	SHEET NO.
R-5021	TMP-91

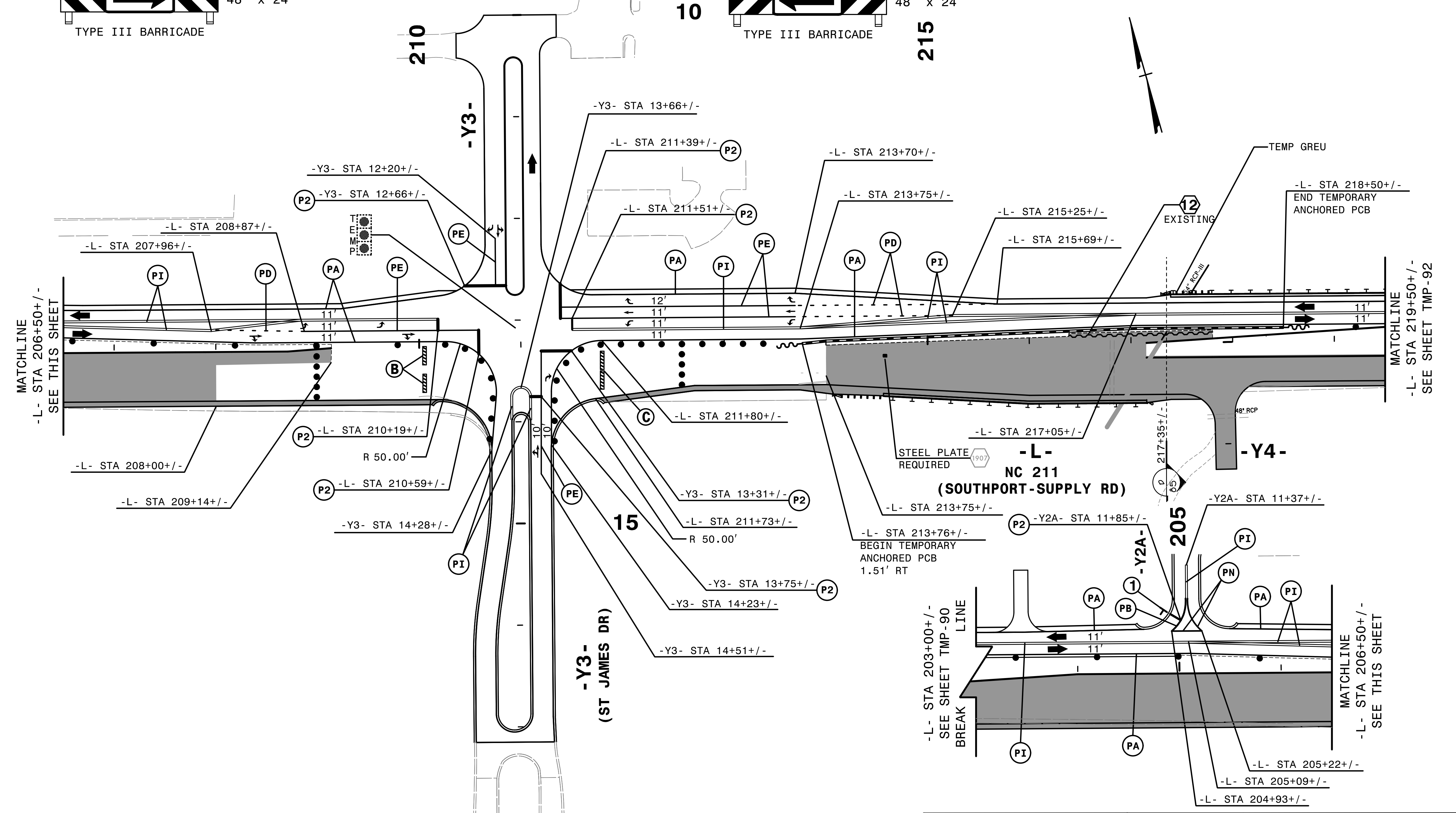
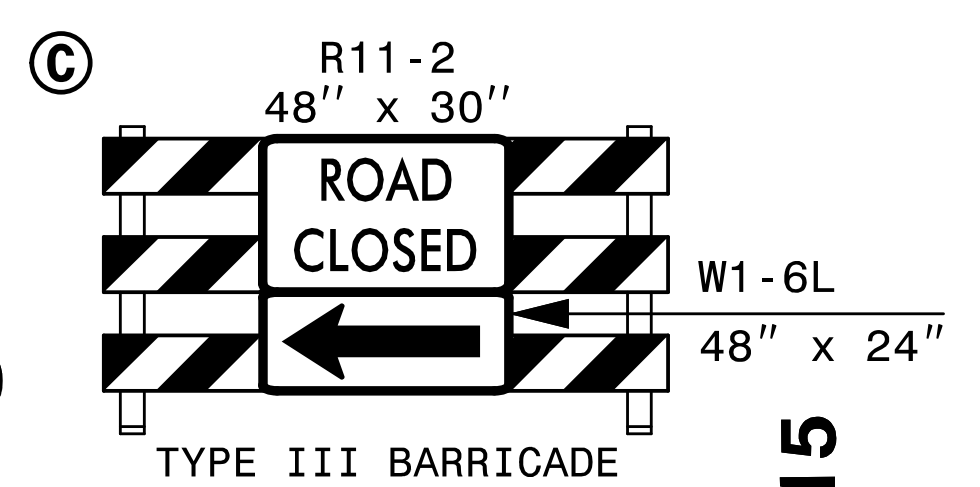
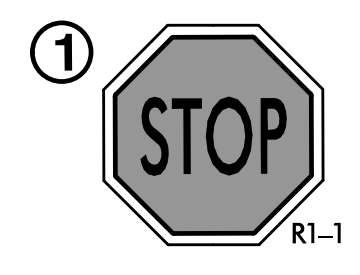
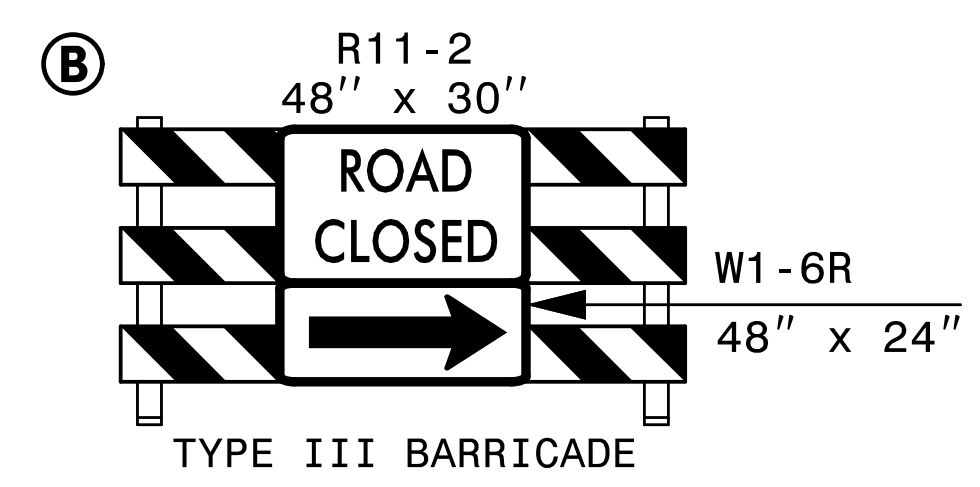

4:54:36 PM
 \\TCPLV5021_fc_p2d9.dgn
 \$\$\$USERNAME\$\$\$

REMOVE CONFLICTING PAVEMENT MARKING.

HNTB
 HNTB NORTH CAROLINA, P.C.
 343 E. Six Forks Road, Suite 200
 Raleigh, North Carolina 27609
 NC License No: C-1554

APPROVED: *Helen Shyu*
 DATE: 9/9/2021
 SEAL
 HNTB PROFESSIONAL SEAL
 HELLEN SHYU
 ENGINEER
 042517

TRANSPORTATION
 MANAGEMENT PLAN
 PHASE II
 DETAIL
 DOCUMENT NOT CONSIDERED FINAL
 UNLESS ALL SIGNATURES COMPLETED

PROJ. REFERENCE NO.	SHEET NO.
R-5021	TMP-92

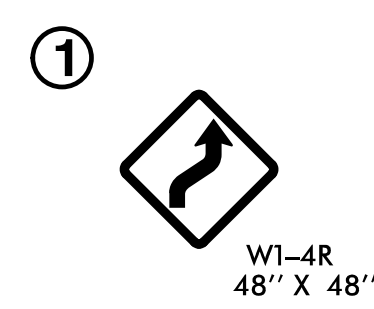

220

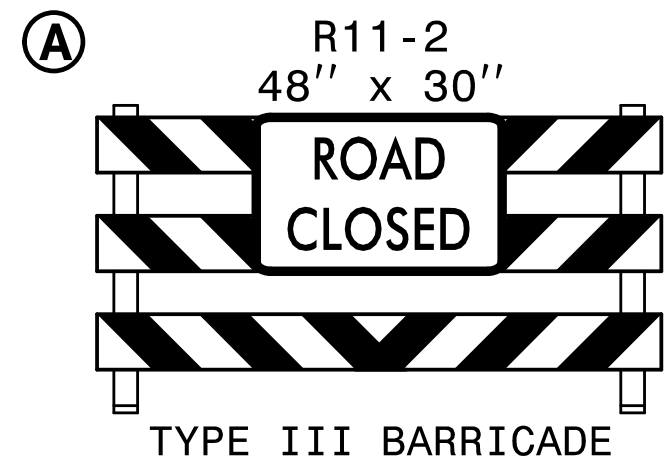

225

230

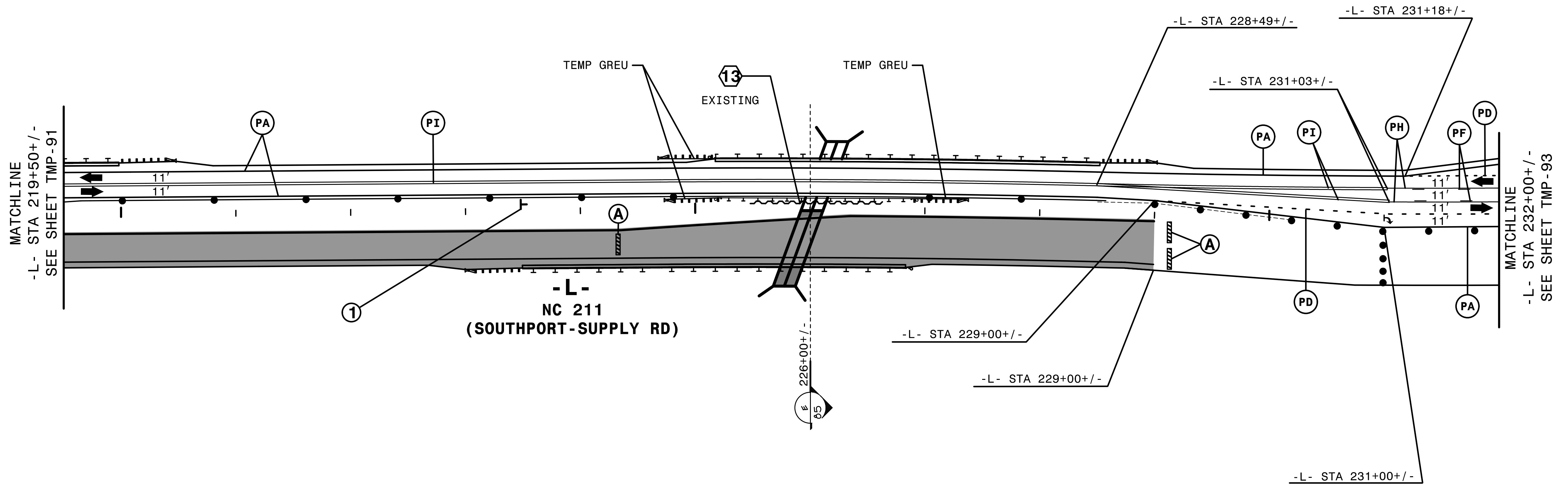
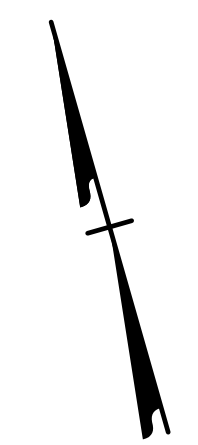

REMOVE CONFLICTING PAVEMENT MARKING.

2/6/2019
HNTB

HNTB HNTB NORTH CAROLINA, P.C.
 343 E. Six Forks Road, Suite 200
 Raleigh, North Carolina 27609
 NC License No: C-1554

APPROVED: *Helen Skyy*
 DATE: 2/6/2019
 SEAL
 PROFESSIONAL ENGINEER
 HELEN SKYY
 NC License No: C-1554

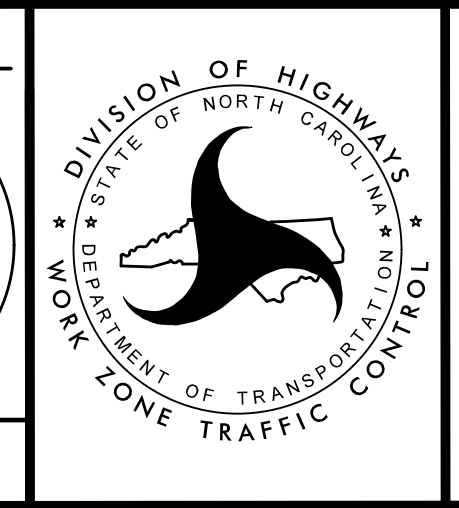

TRANSPORTATION
 MANAGEMENT PLAN

 PHASE II
 DETAIL

DOCUMENT NOT CONSIDERED FINAL
UNLESS ALL SIGNATURES COMPLETED

PROJ. REFERENCE NO.	SHEET NO.
R-5021	TMP-93

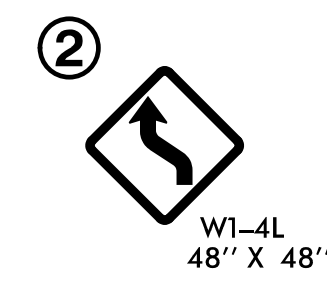
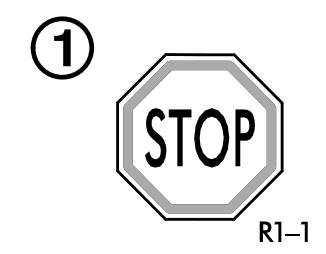

**-Y5-
(EXECUTIVE PARK BLVD)**

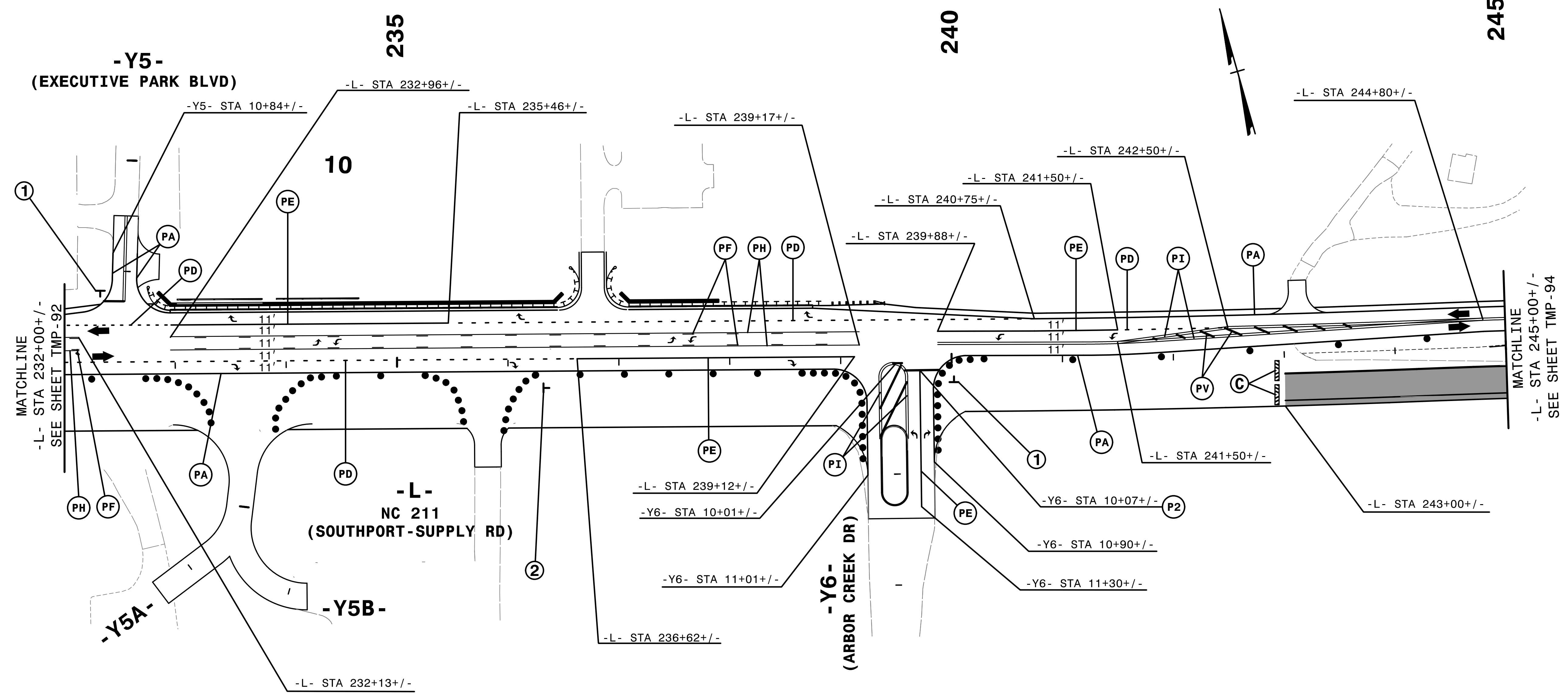

MATCHLINE
-L- STA 232+00+/-
SEE SHEET TMP-92

MATCHLINE
-L- STA 245+00+/-
SEE SHEET TMP-94

**-L-
NC 211
(SOUTHPORT-SUPPLY RD)**

**-Y6-
(ARBOR CREEK DR)**

-Y5A-

-Y5B-

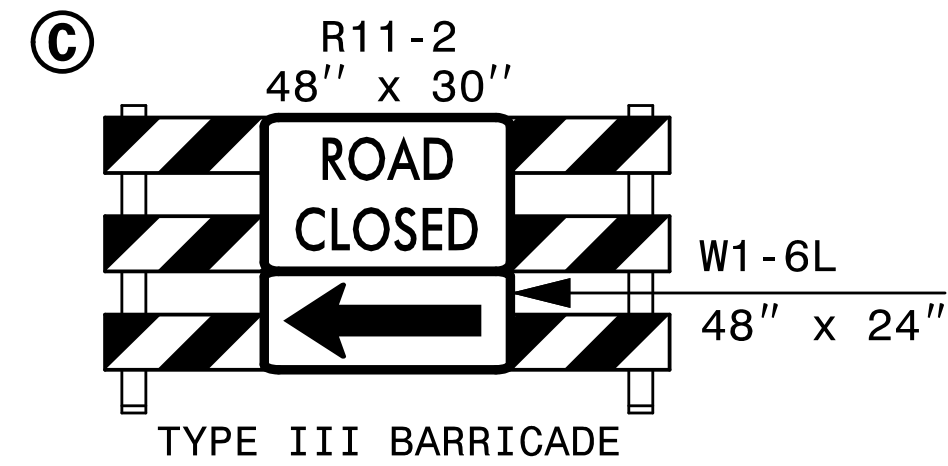

REMOVE CONFLICTING PAVEMENT MARKING.

2/6/2019
HNTB

HNTB HNTB NORTH CAROLINA, P.C.
343 E. Six Forks Road, Suite 200
Raleigh, North Carolina 27609
NC License No: C-1554

APPROVED: *Helen Skyy*
DATE: 2/6/2019
SEAL
Professional Engineer Seal for Helen Skyy, No. 042517, State of North Carolina.

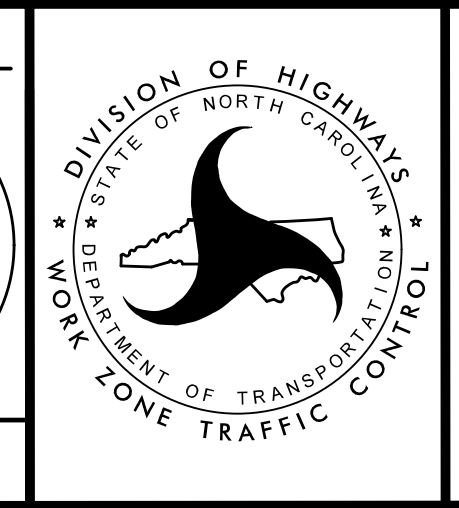

TRANSPORTATION
MANAGEMENT PLAN

PHASE II
DETAIL

DOCUMENT NOT CONSIDERED FINAL
UNLESS ALL SIGNATURES COMPLETED

PROJ. REFERENCE NO.	SHEET NO.
R-5021	TMP-94

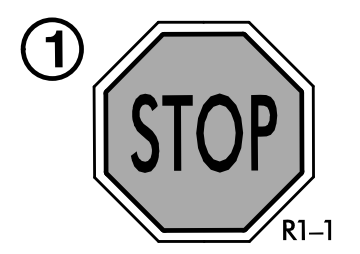

250

255

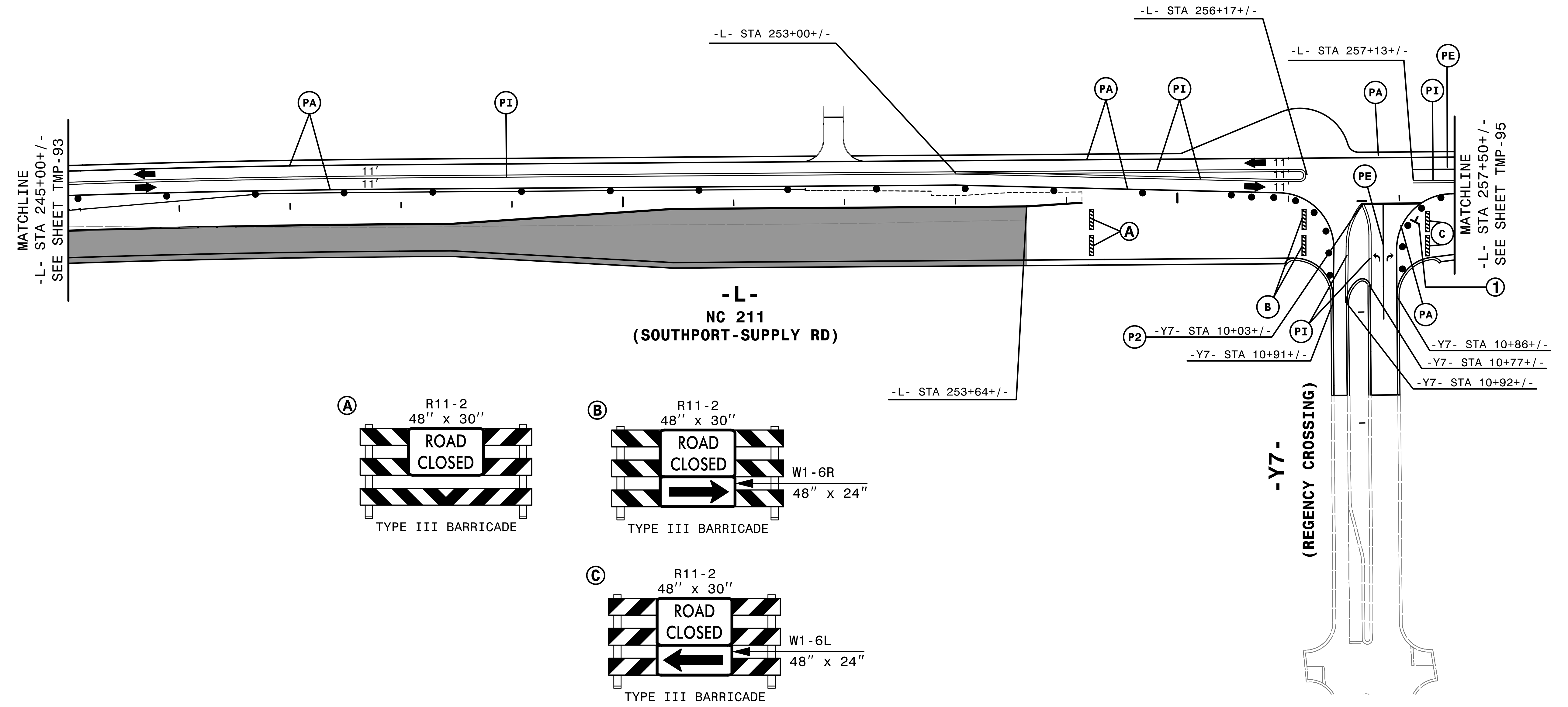
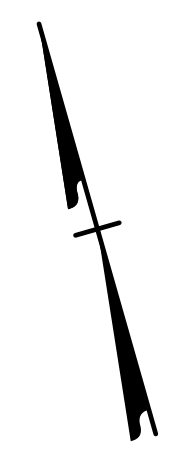

2/6/2019
 C:\CP\5021\to_p2.dwg
 HNTB

REMOVE CONFLICTING PAVEMENT MARKING.

HNTB HNTB NORTH CAROLINA, P.C.
 343 E. Six Forks Road, Suite 200
 Raleigh, North Carolina 27609
 NC License No: C-1554

APPROVED: *Helen Skyy*
 DATE: 2/6/2019
 SEAL
 PROFESSIONAL ENGINEER
 HELEN SKYY
 042517

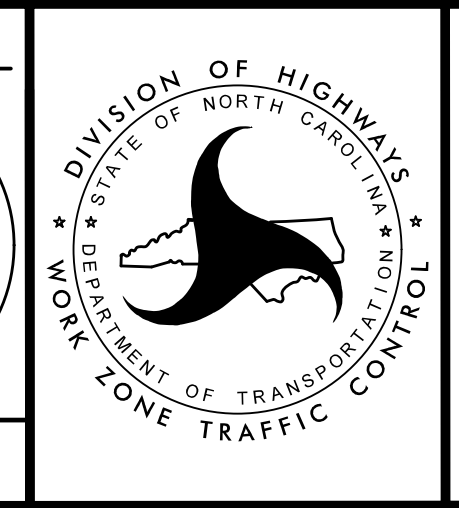

TRANSPORTATION
 MANAGEMENT PLAN
 PHASE II
 DETAIL

DOCUMENT NOT CONSIDERED FINAL
 UNLESS ALL SIGNATURES COMPLETED

PROJ. REFERENCE NO.	SHEET NO.
R-5021	TMP-95

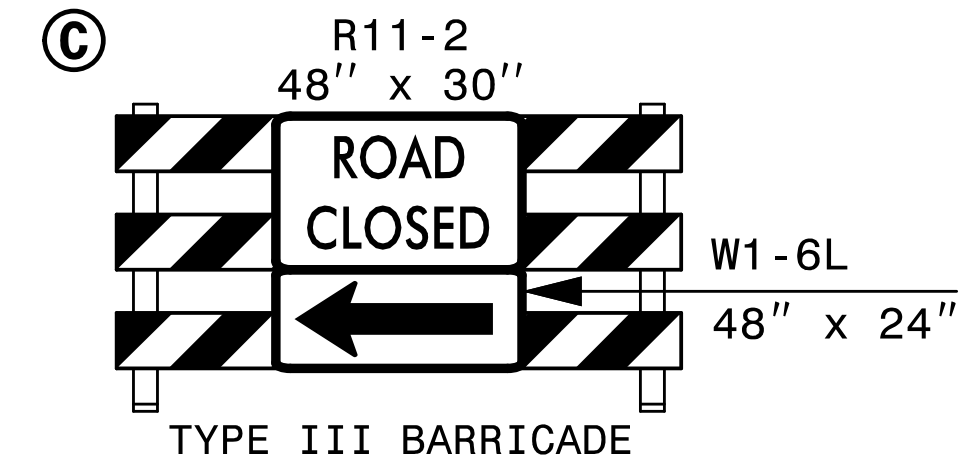
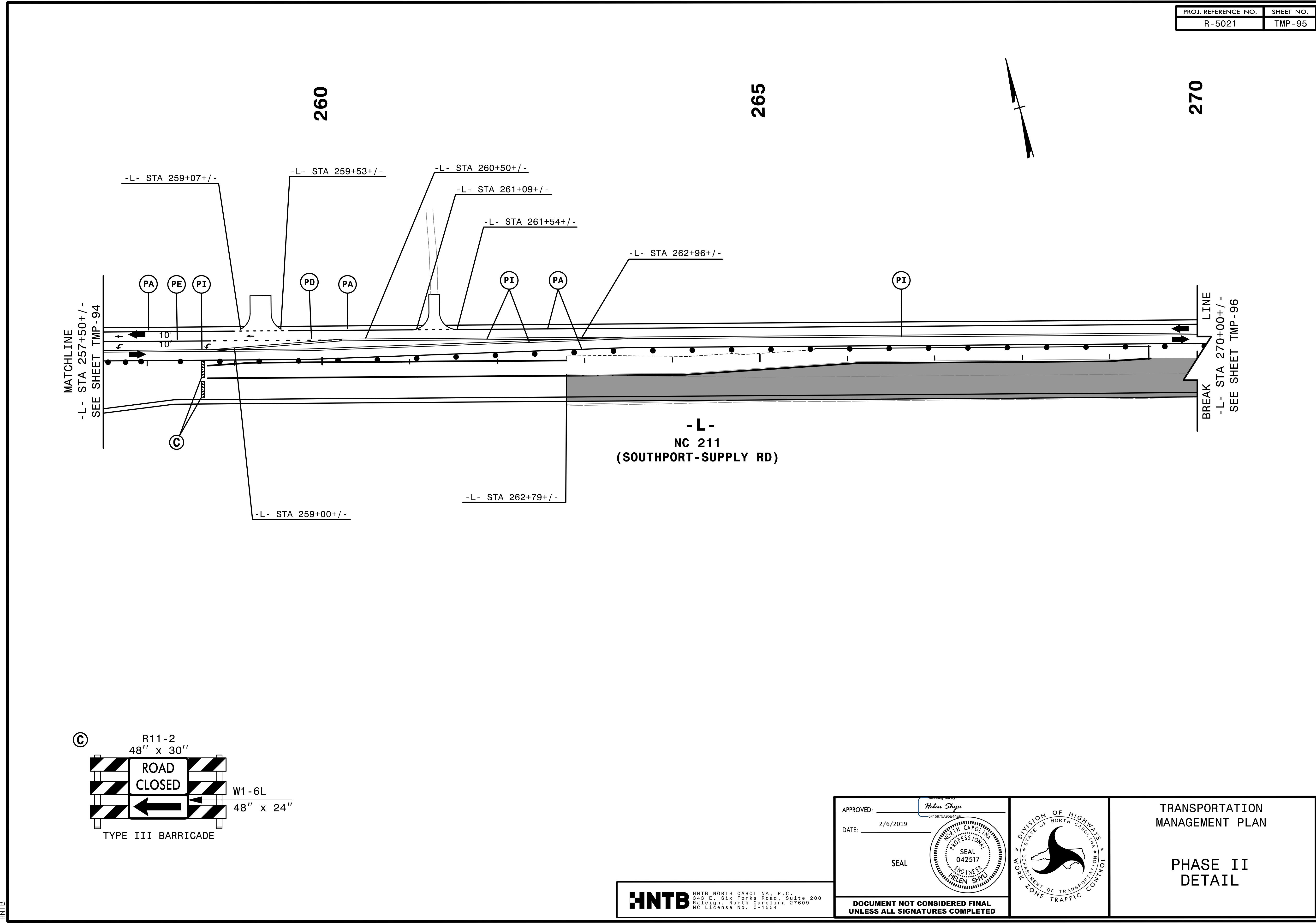

2/6/2019
 C:\CPV\5021\TC-p2d13.dgn
 HNTB

HNTB HNTB NORTH CAROLINA, P.C.
 343 E. Six Forks Road, Suite 200
 Raleigh, North Carolina 27609
 NC License No: C-1554

APPROVED: *Helen Skyy*
 OF 1987SAPPLICABLE
 DATE: 2/6/2019
 SEAL
 PROFESSIONAL SEAL
 042517
 ENGINEER
 HELEN SKYY

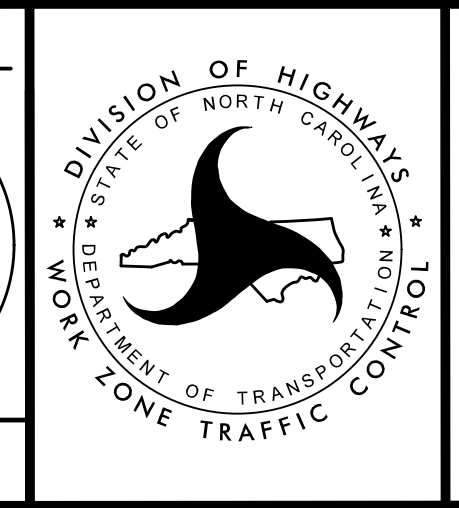

TRANSPORTATION
 MANAGEMENT PLAN
 PHASE II
 DETAIL

DOCUMENT NOT CONSIDERED FINAL
 UNLESS ALL SIGNATURES COMPLETED

PROJ. REFERENCE NO.	SHEET NO.
R-5021	TMP-96

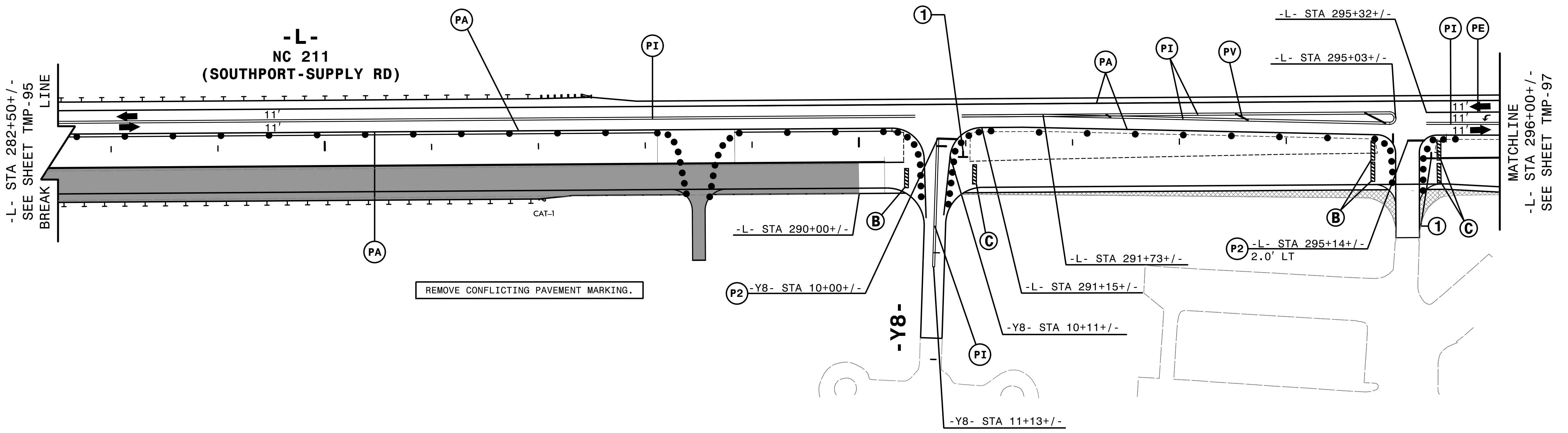
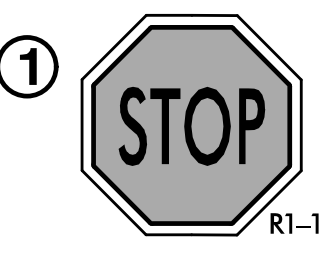
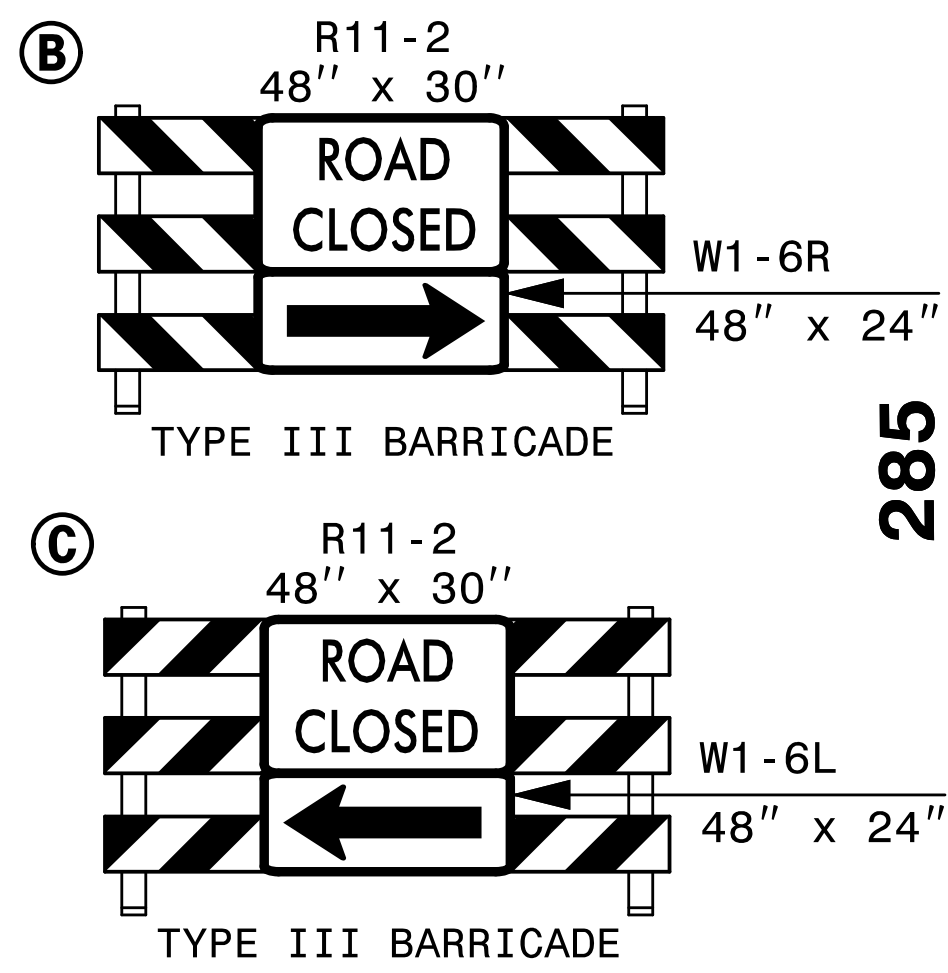

2/6/2019
 C:\CP\5021\TC-p2.dwg
 HNTB

HNTB HNTB NORTH CAROLINA, P.C.
 343 E. Six Forks Road, Suite 200
 Raleigh, North Carolina 27609
 NC License No: C-1554

APPROVED: *Helen Skyy*
 DATE: 2/6/2019
 SEAL
 PROFESSIONAL SEAL
 ENGINEER
 HELEN SKYY
 OF 1987SAPPLICABLE

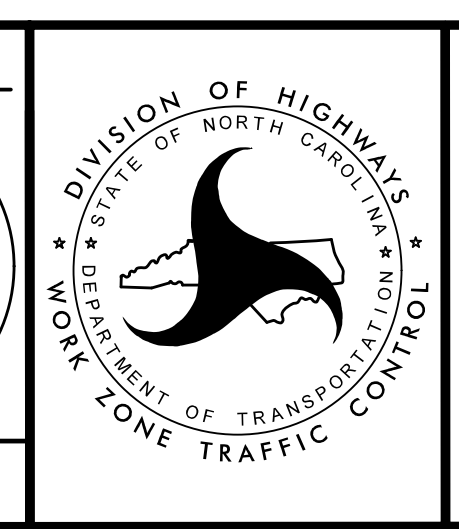

TRANSPORTATION
 MANAGEMENT PLAN
 PHASE II
 DETAIL

DOCUMENT NOT CONSIDERED FINAL
 UNLESS ALL SIGNATURES COMPLETED

PROJ. REFERENCE NO.	SHEET NO.
R-5021	TMP-97

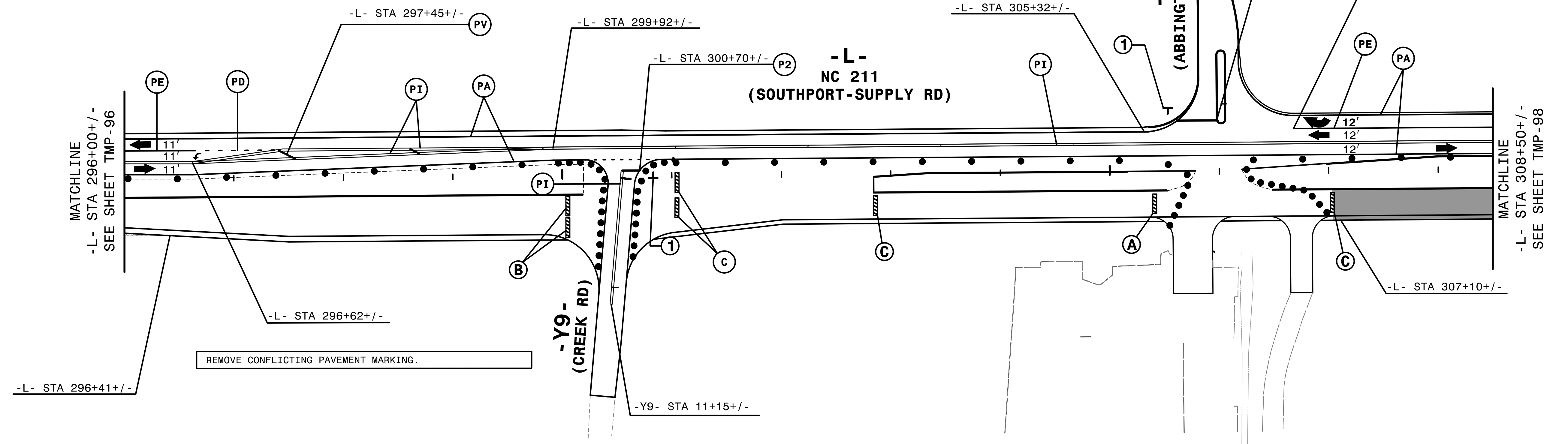
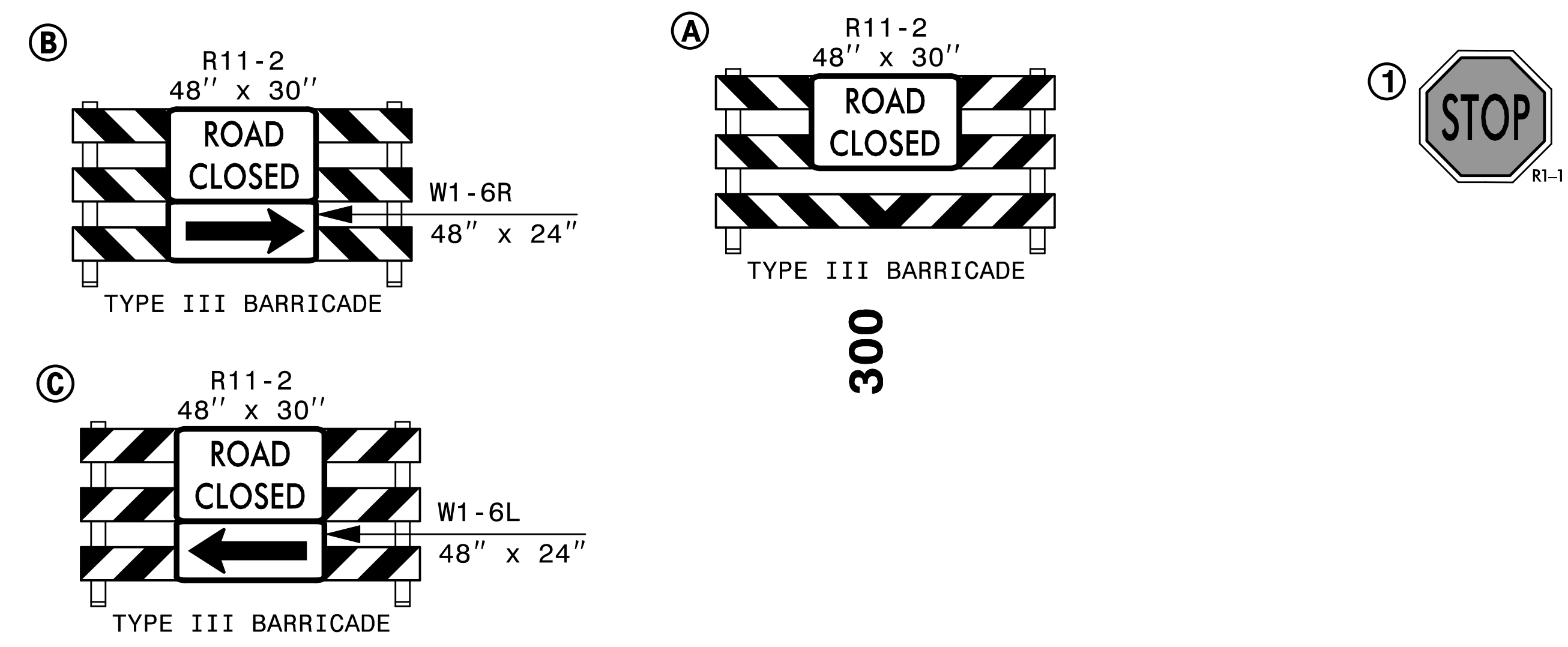

2:30:55 PM
 C:\TCP\15021\15021-1\021-1\021-1\021-1.dgn
 \$\$\$USERNAME\$\$\$

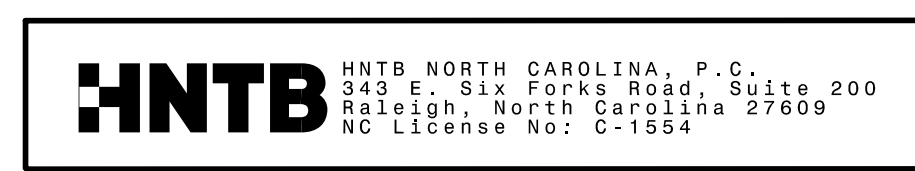

APPROVED: Helen Shyu
 DATE: 10/28/2021
 SEAL

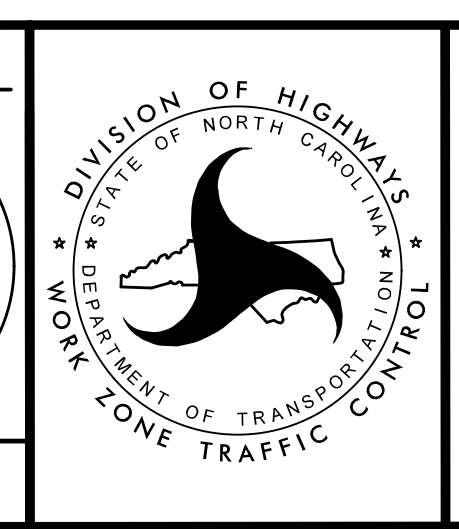

TRANSPORTATION
 MANAGEMENT PLAN

PHASE II
 DETAIL

DOCUMENT NOT CONSIDERED FINAL
 UNLESS ALL SIGNATURES COMPLETED

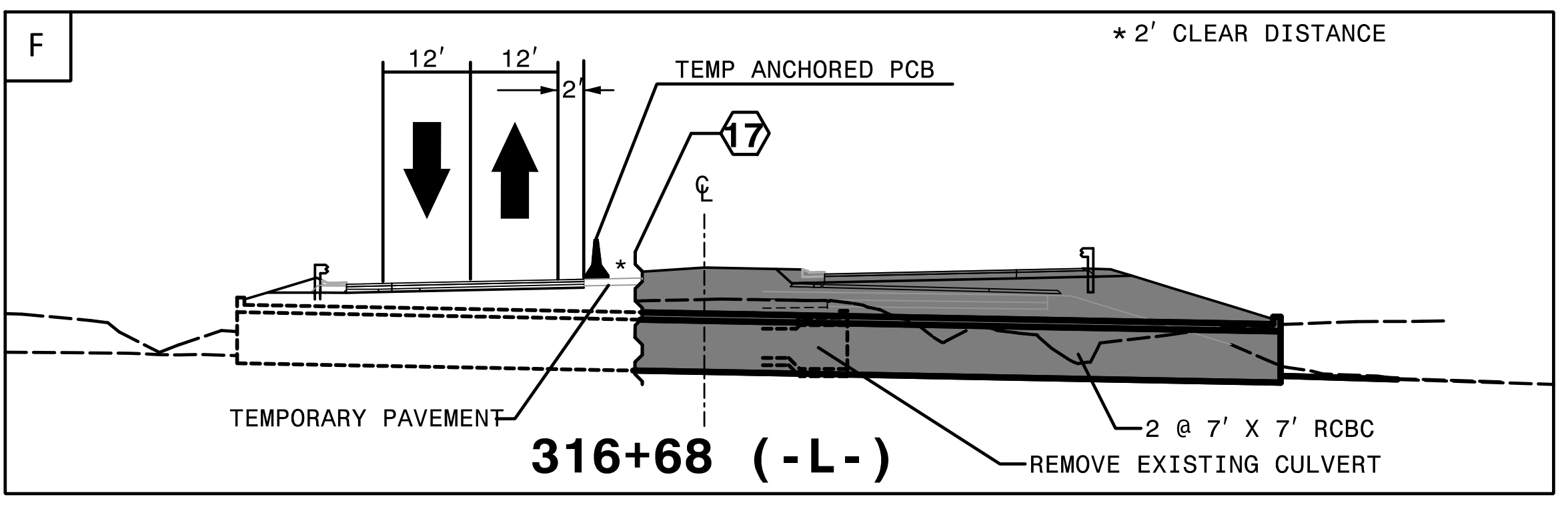
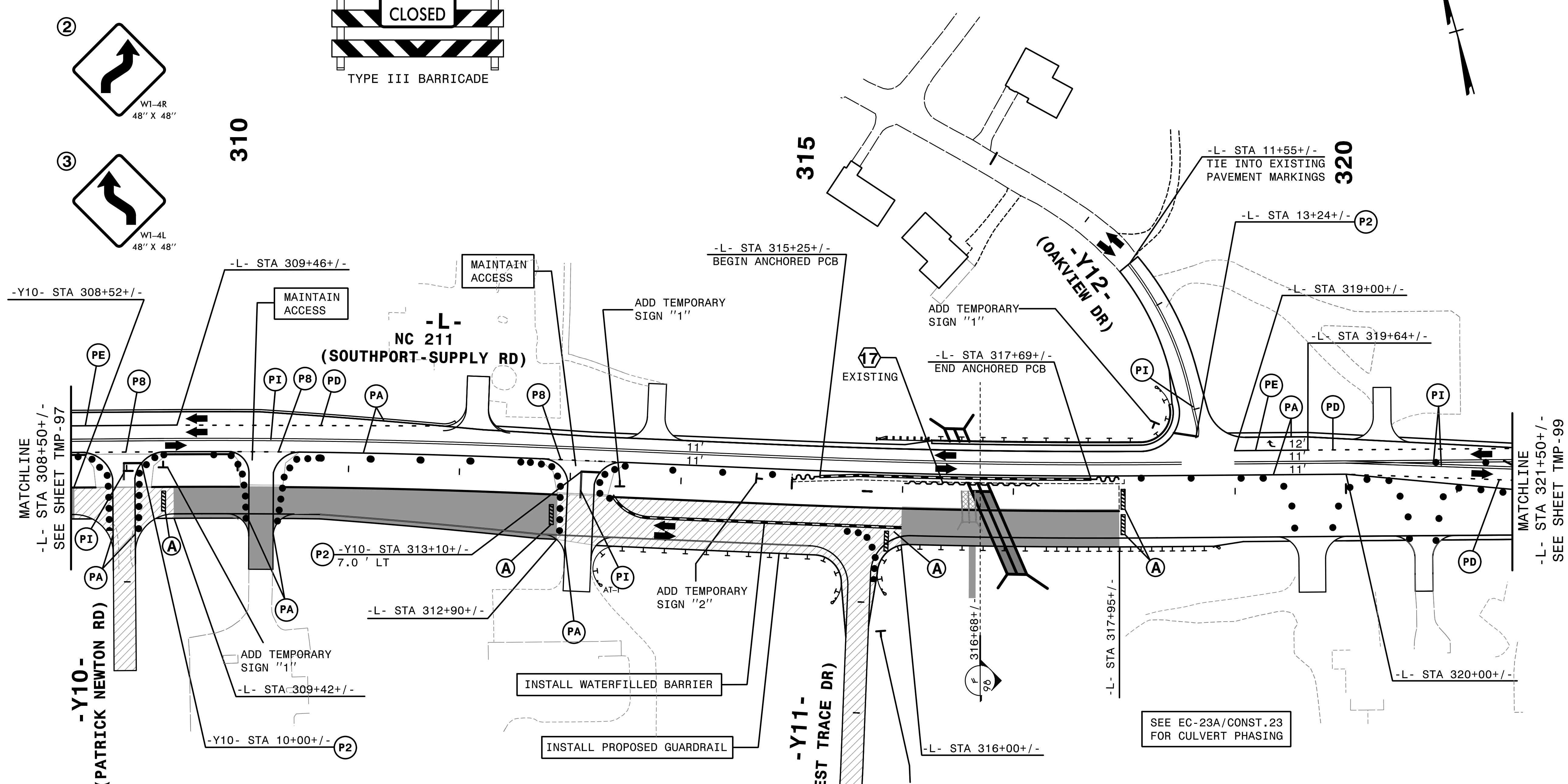
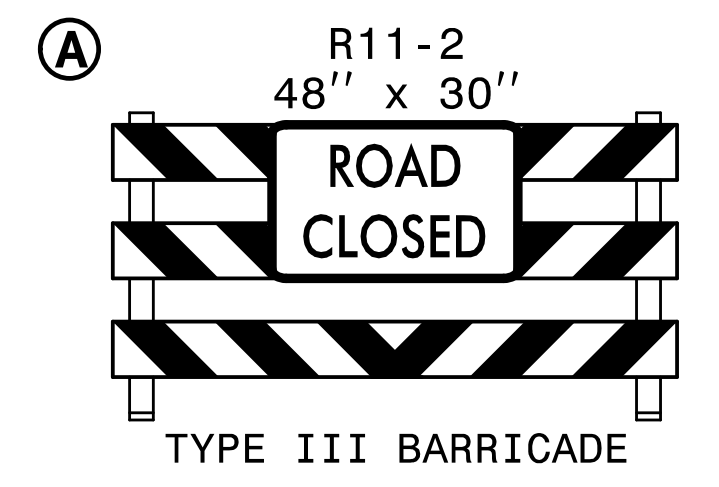
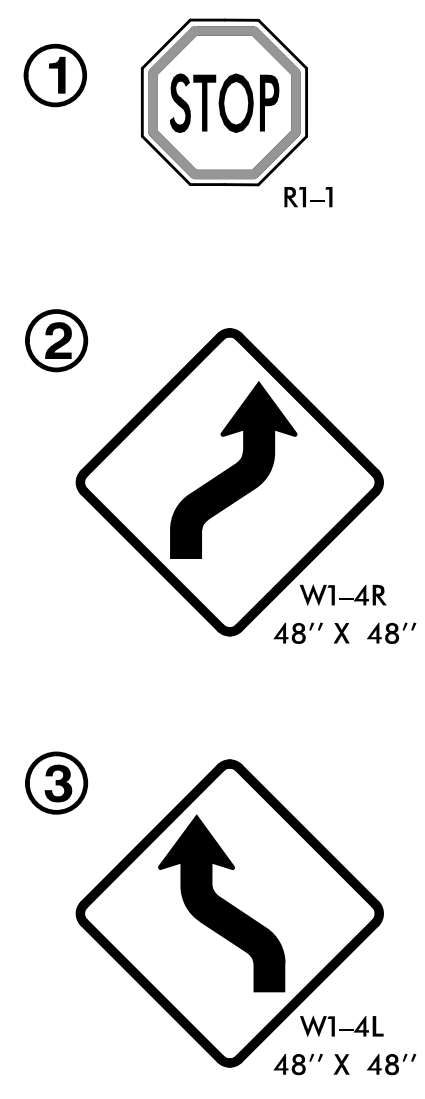

7/14/21 4:51 PM
 ...\\TCN\5021_Tc_p2.dwg
 \$\$\$USERNAME\$\$\$

HNTB
 HNTB NORTH CAROLINA, P.C.
 343 E. Six Forks Road, Suite 200
 Raleigh, North Carolina 27609
 NC License No: C-1554

APPROVED: *Helen Shyu*
 DATE: 10/28/2021
 SEAL
 PROFESSIONAL ENGINEER
 SEAL 042517
 HELEN SHYU

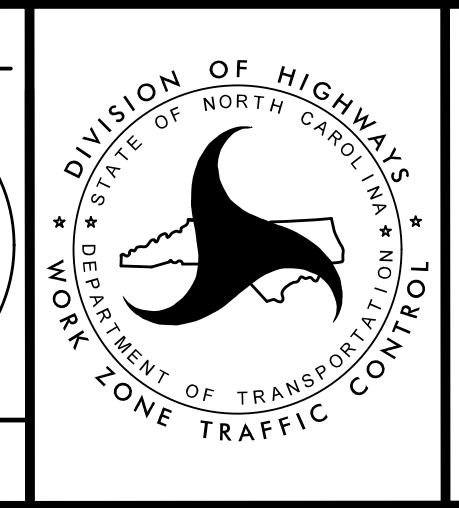

TRANSPORTATION
 MANAGEMENT PLAN
 PHASE II
 DETAIL
 DOCUMENT NOT CONSIDERED FINAL
 UNLESS ALL SIGNATURES COMPLETED

PROJ. REFERENCE NO.	SHEET NO.
R-5021	TMP-99

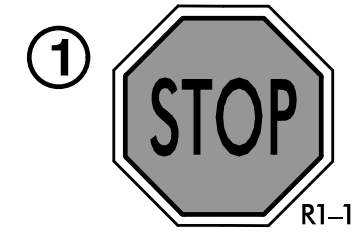

(AC) 45' SHOP CURVED TEMPORARY GUARDRAIL WITH B-77 ANCHOR TO PCB AND TEMP AT-1

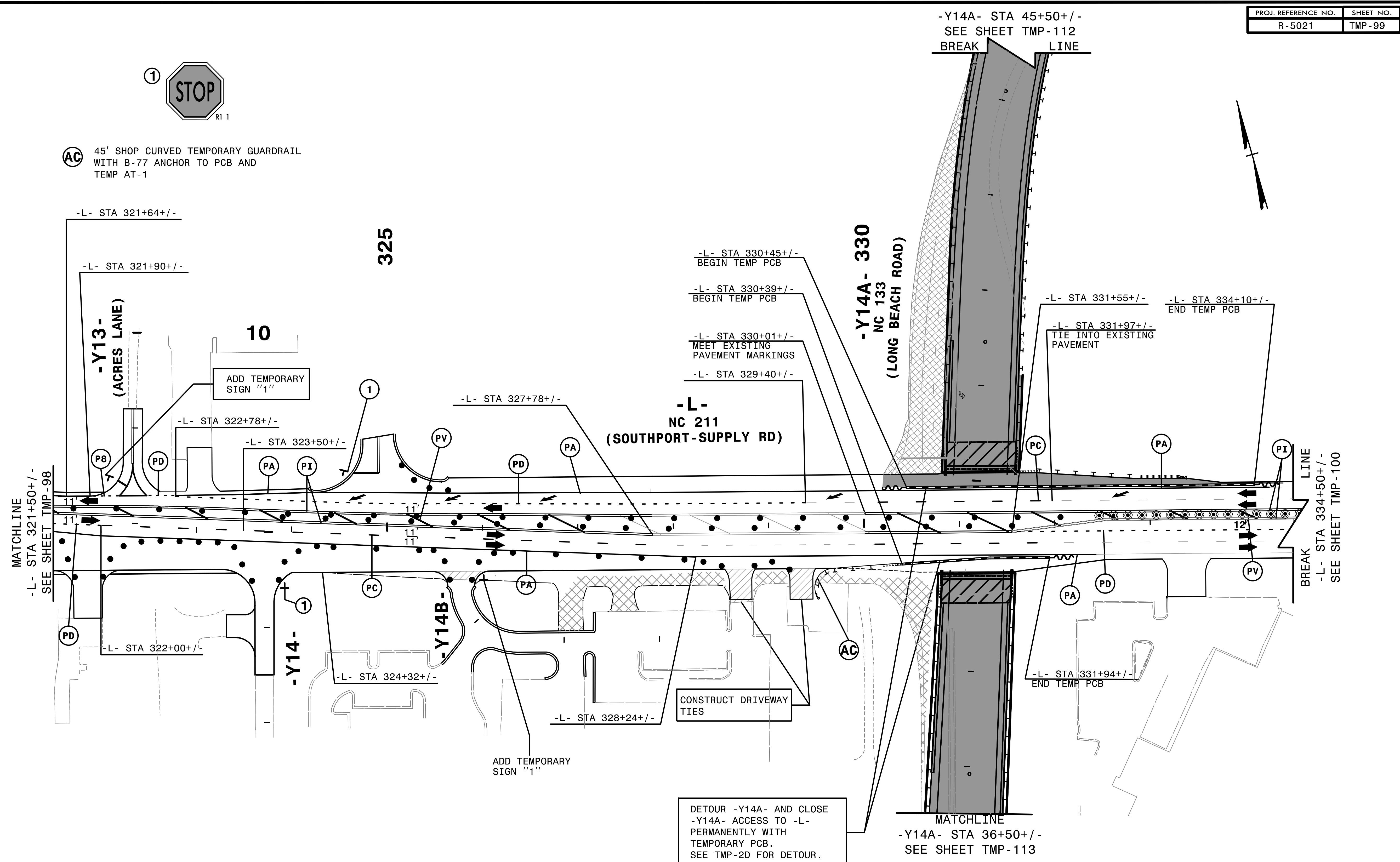

MATCHLINE
-L- STA 321+50+/-
SEE SHEET TMP-98

BREAK
LINE
-L- STA 334+50+/-
SEE SHEET TMP-100

DETOUR -Y14A- AND CLOSE -Y14A- ACCESS TO -L- PERMANENTLY WITH TEMPORARY PCB. SEE TMP-2D FOR DETOUR.

4:54:44 PM
...\\TCPL\5021\TC_p2.dwg
\$\$\$\$\$USERNAME\$\$\$\$\$

HNTB HNTB NORTH CAROLINA, P.C.
343 E. Six Forks Road, Suite 200
Raleigh, North Carolina 27609
NC License No: C-1554

APPROVED: *Helen Shyu*
DATE: 9/9/2021

SEAL

DOCUMENT NOT CONSIDERED FINAL
UNLESS ALL SIGNATURES COMPLETED

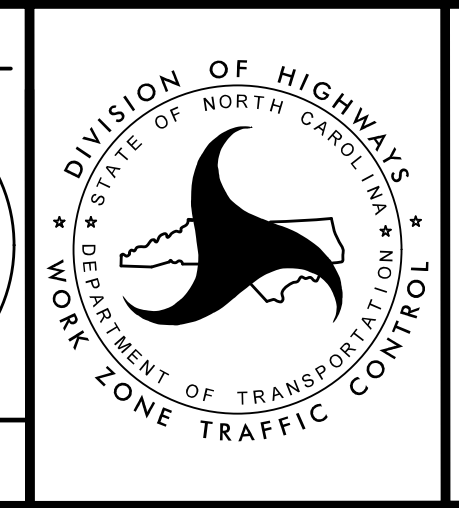

TRANSPORTATION
MANAGEMENT PLAN

PHASE II
DETAIL

PROJ. REFERENCE NO.	SHEET NO.
R-5021	TMP-100

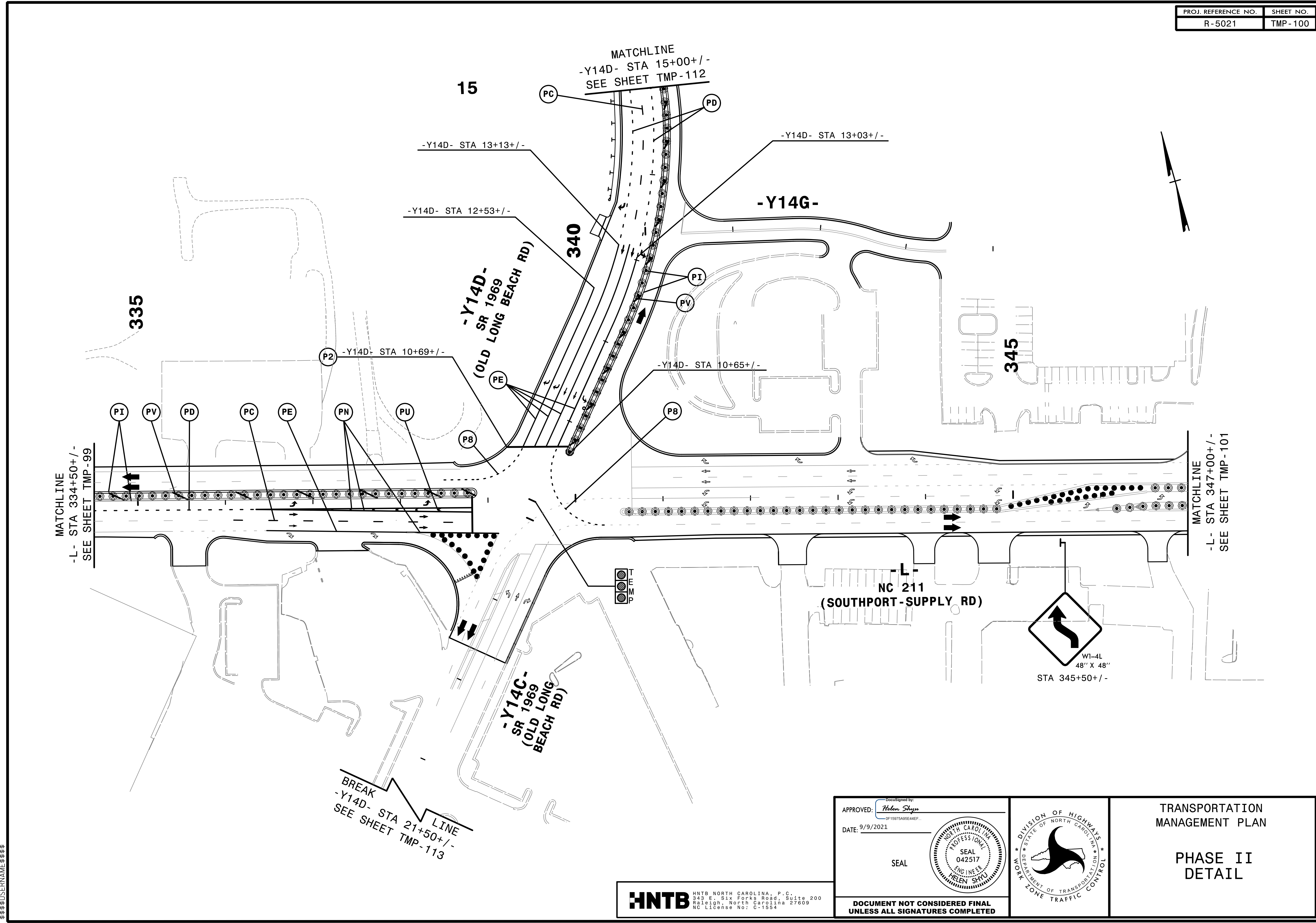

4:54:46 PM
 \\TCF\5021\1021\1021\1021.dgn
 \$\$\$USERNAME\$\$\$

BREAK
 -Y14D- STA 21+50+/-
 SEE SHEET TMP-113

HNTB HNTB NORTH CAROLINA, P.C.
 343 E. Six Forks Road, Suite 200
 Raleigh, North Carolina 27609
 NC License No: C-1554

APPROVED: *Helen Shyu*
 DATE: 9/9/2021

SEAL

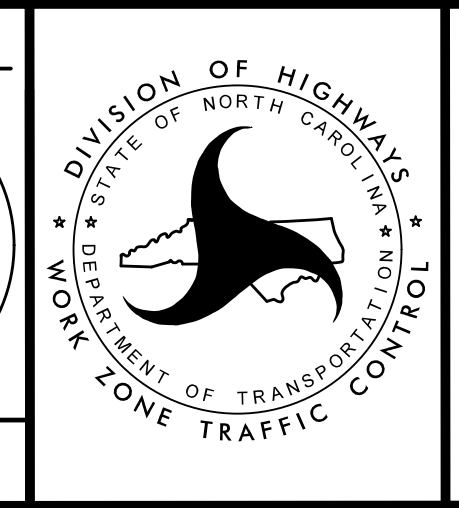



TRANSPORTATION
 MANAGEMENT PLAN

PHASE II
 DETAIL

DOCUMENT NOT CONSIDERED FINAL
 UNLESS ALL SIGNATURES COMPLETED

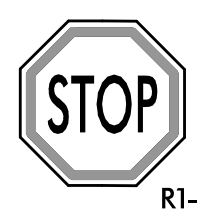
PROJ. REFERENCE NO.	SHEET NO.
R-5021	TMP-101

- ①  R1-1
- ②  R3-7 R
30" X 30"

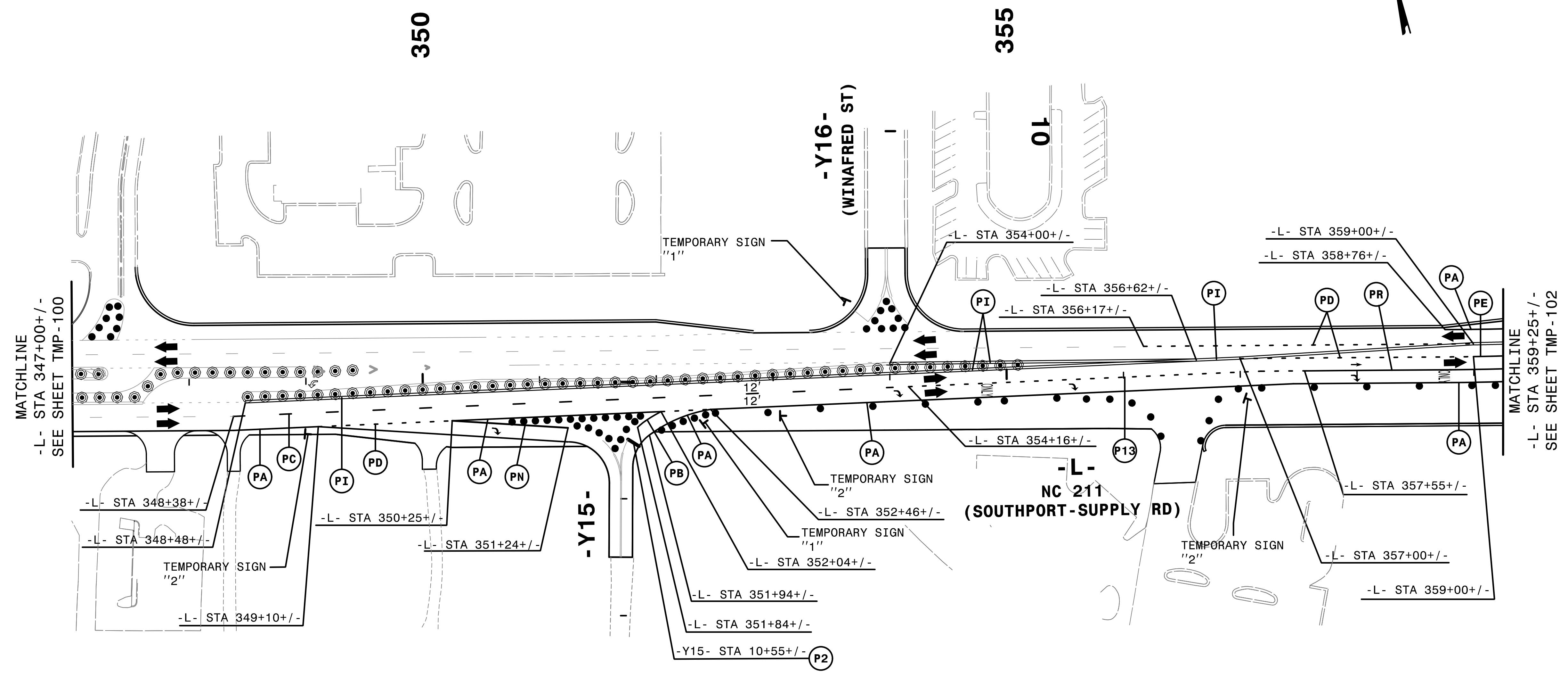
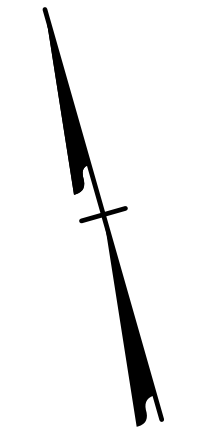

4:54:48 PM
 \\TCFV-5021_LTC_p2d20.dgn
 \$\$\$USERNAME\$\$\$

HNTB HNTB NORTH CAROLINA, P.C.
 343 E. Six Forks Road, Suite 200
 Raleigh, North Carolina 27609
 NC License No: C-1554

APPROVED: *Helen Shyne*
 DATE: 9/9/2021

SEAL

DOCUMENT NOT CONSIDERED FINAL
 UNLESS ALL SIGNATURES COMPLETED

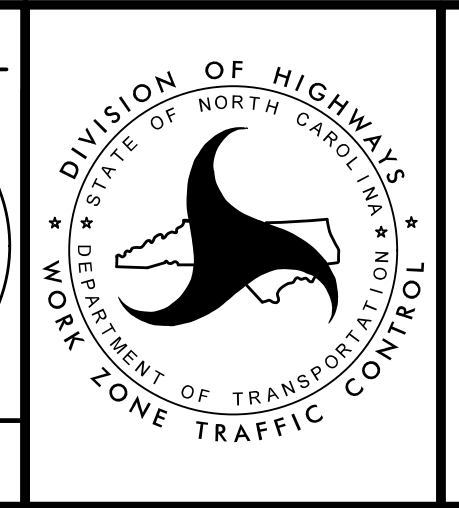

TRANSPORTATION
 MANAGEMENT PLAN

PHASE II
 DETAIL

PROJ. REFERENCE NO.	SHEET NO.
R-5021	TMP-102

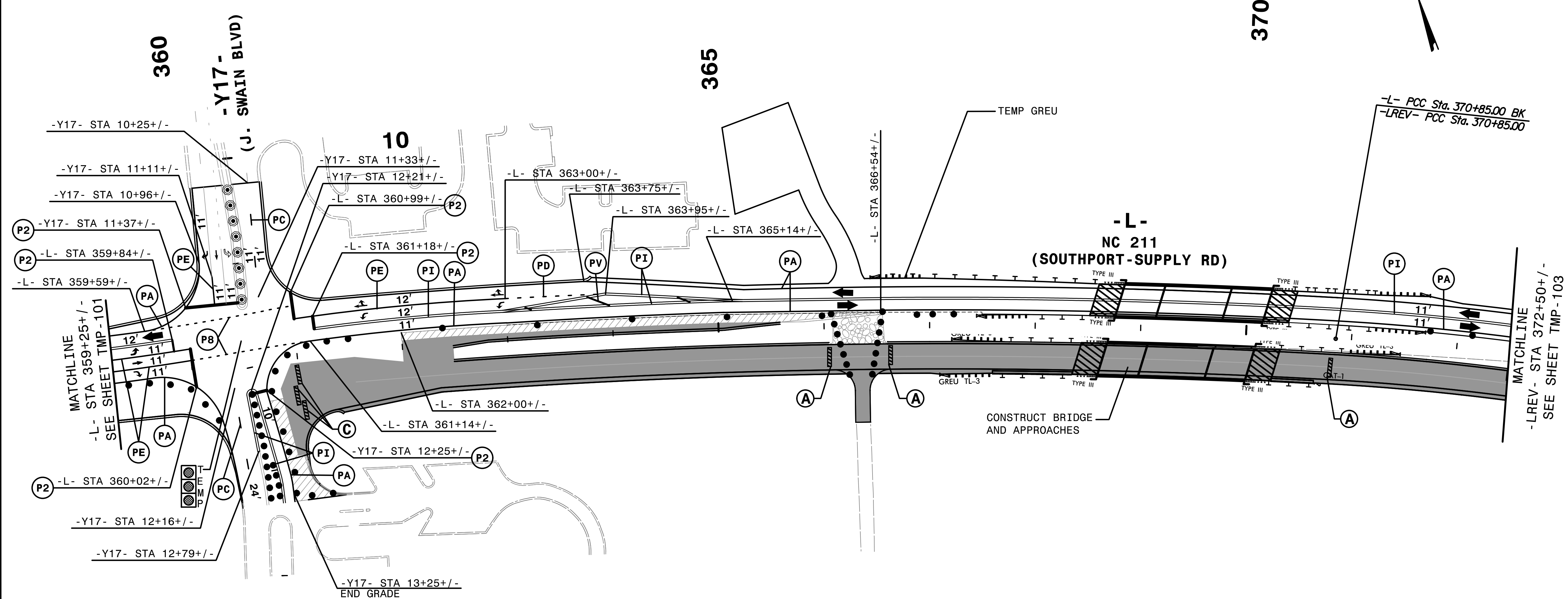
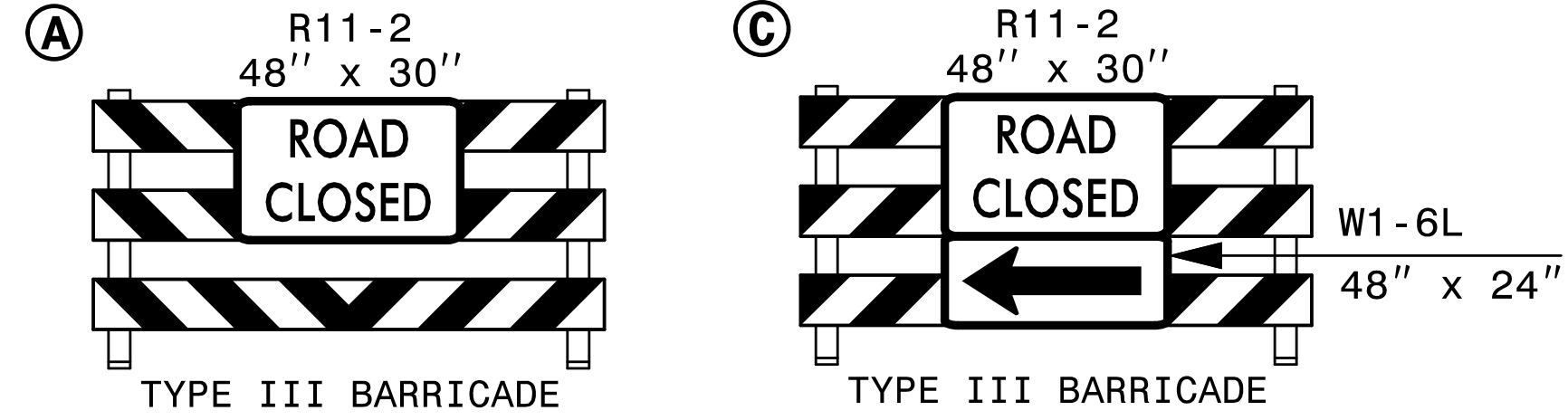

REMOVE CONFLICTING PAVEMENT MARKING.

2/6/2019
 C:\CP\5021\Tc-p2d21.dgn
 HNTB

HNTB HNTB NORTH CAROLINA, P.C.
 343 E. Six Forks Road, Suite 200
 Raleigh, North Carolina 27609
 NC License No: C-1554

APPROVED: *Helen Skyy*
 DATE: 2/6/2019
 SEAL
 PROFESSIONAL ENGINEER
 HELEN SKYY
 042517

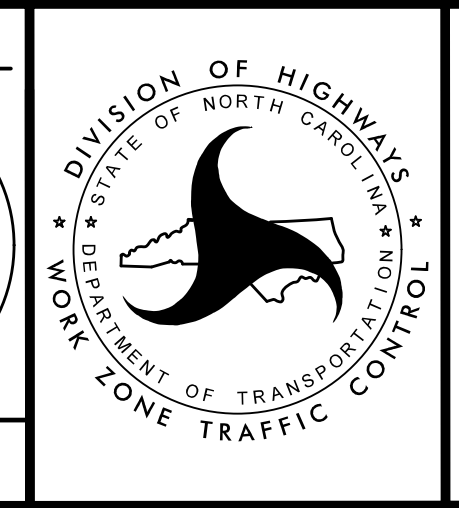

TRANSPORTATION
 MANAGEMENT PLAN
 PHASE II
 DETAIL

DOCUMENT NOT CONSIDERED FINAL
 UNLESS ALL SIGNATURES COMPLETED

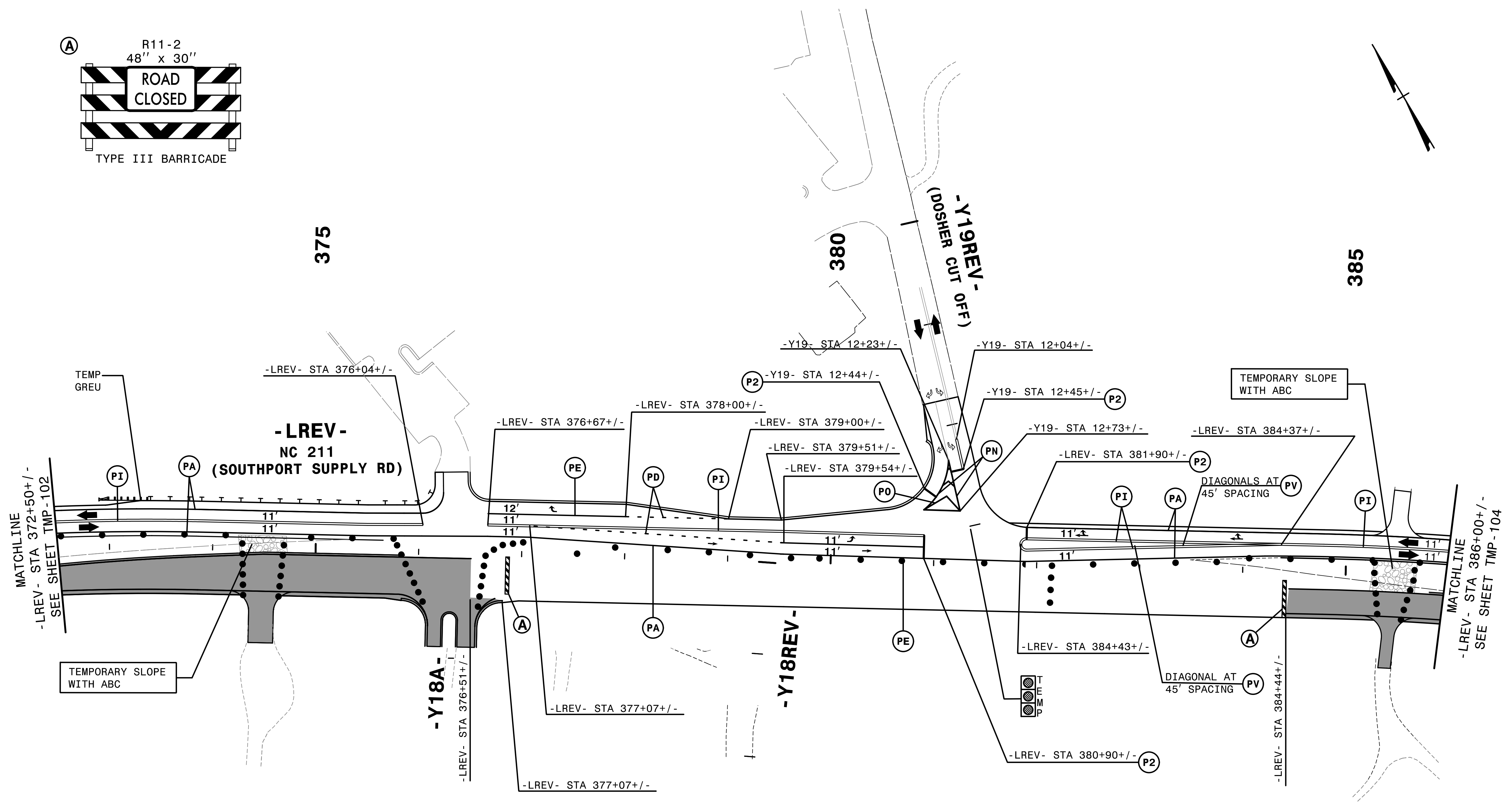
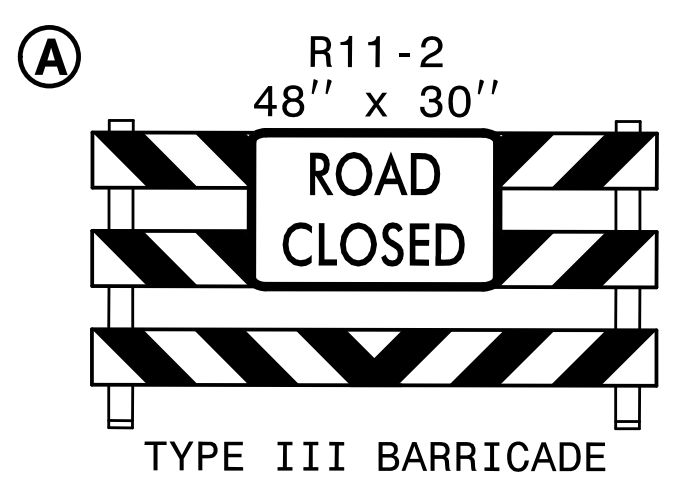

4:54:50 PM
\\TCPLV502L1\C_P2422.dgn
\$\$\$\$\$USERNAME\$\$\$\$\$

REMOVE CONFLICTING PAVEMENT MARKING.

HNTB HNTB NORTH CAROLINA, P.C.
343 E. Six Forks Road, Suite 200
Raleigh, North Carolina 27609
NC License No: C-1554

APPROVED: *Helen Shyne*
DATE: 9/9/2021

SEAL

PROFESSIONAL ENGINEER
HELEN SHYNE
042517

DOCUMENT NOT CONSIDERED FINAL
UNLESS ALL SIGNATURES COMPLETED

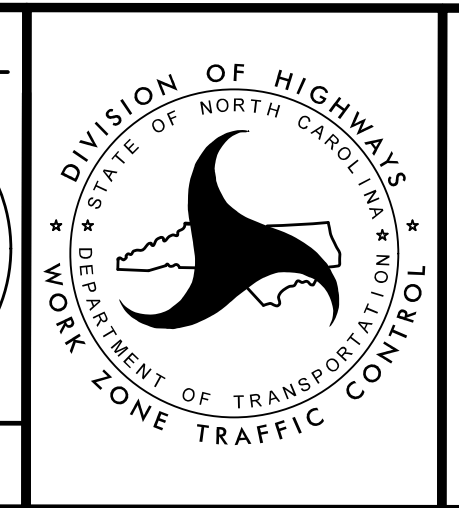

TRANSPORTATION
MANAGEMENT PLAN

PHASE II
DETAIL

PROJ. REFERENCE NO.	SHEET NO.
R-5021	TMP-104

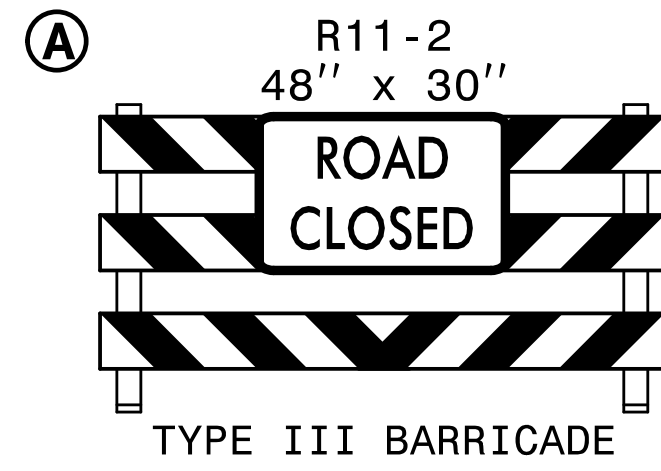

390

395

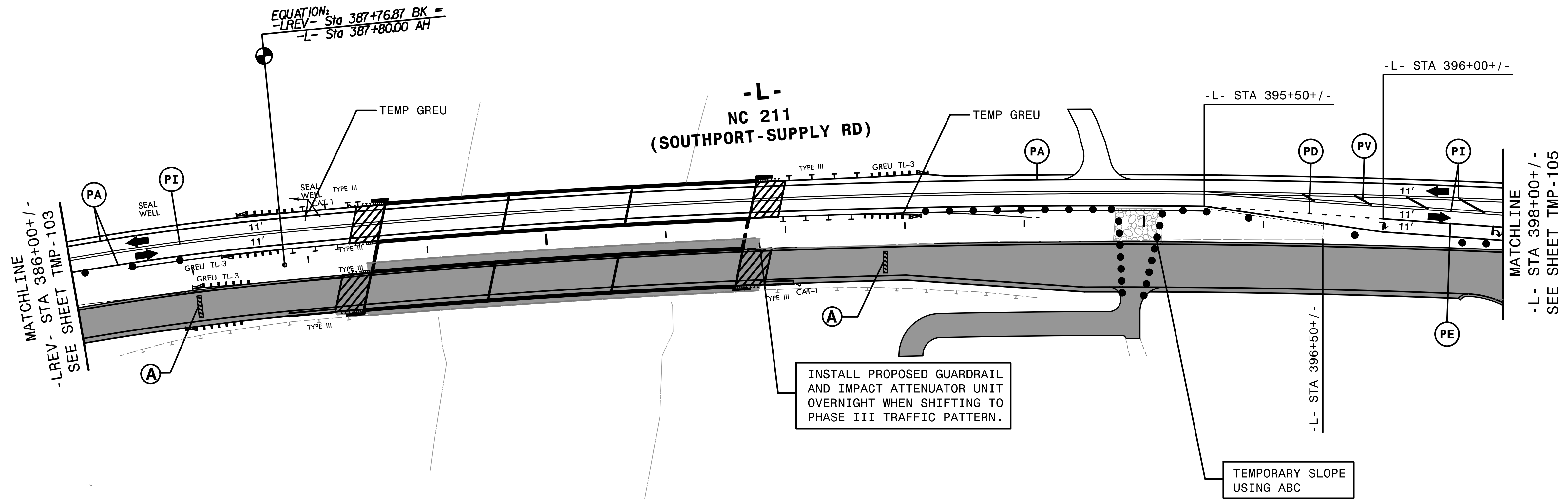

4:54:52 PM
\\TCFV15021\c_p2d23.dgn
\$\$\$\$\$USERNAME\$\$\$\$\$

HNTB HNTB NORTH CAROLINA, P.C.
343 E. Six Forks Road, Suite 200
Raleigh, North Carolina 27609
NC License No: C-1554

APPROVED: *Helen Shyu*
DATE: 9/9/2021
SEAL
DOCUMENT NOT CONSIDERED FINAL
UNLESS ALL SIGNATURES COMPLETED

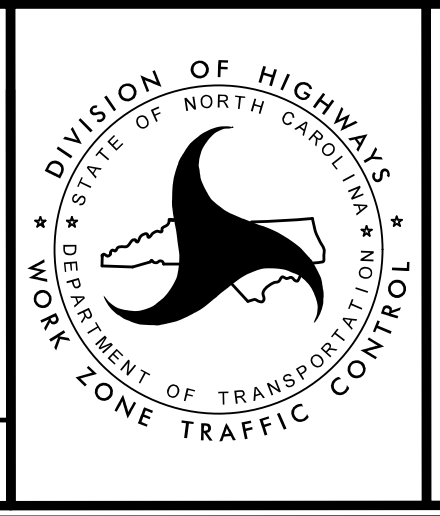

TRANSPORTATION
MANAGEMENT PLAN

PHASE II
DETAIL

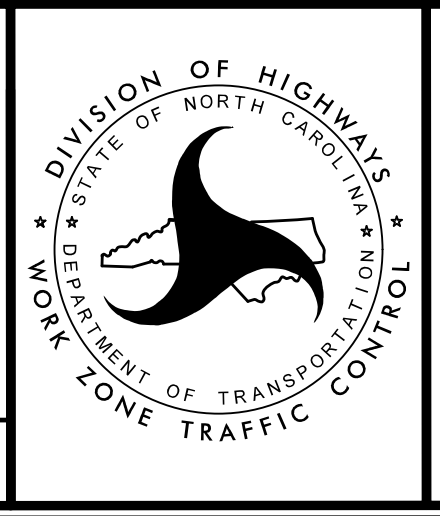

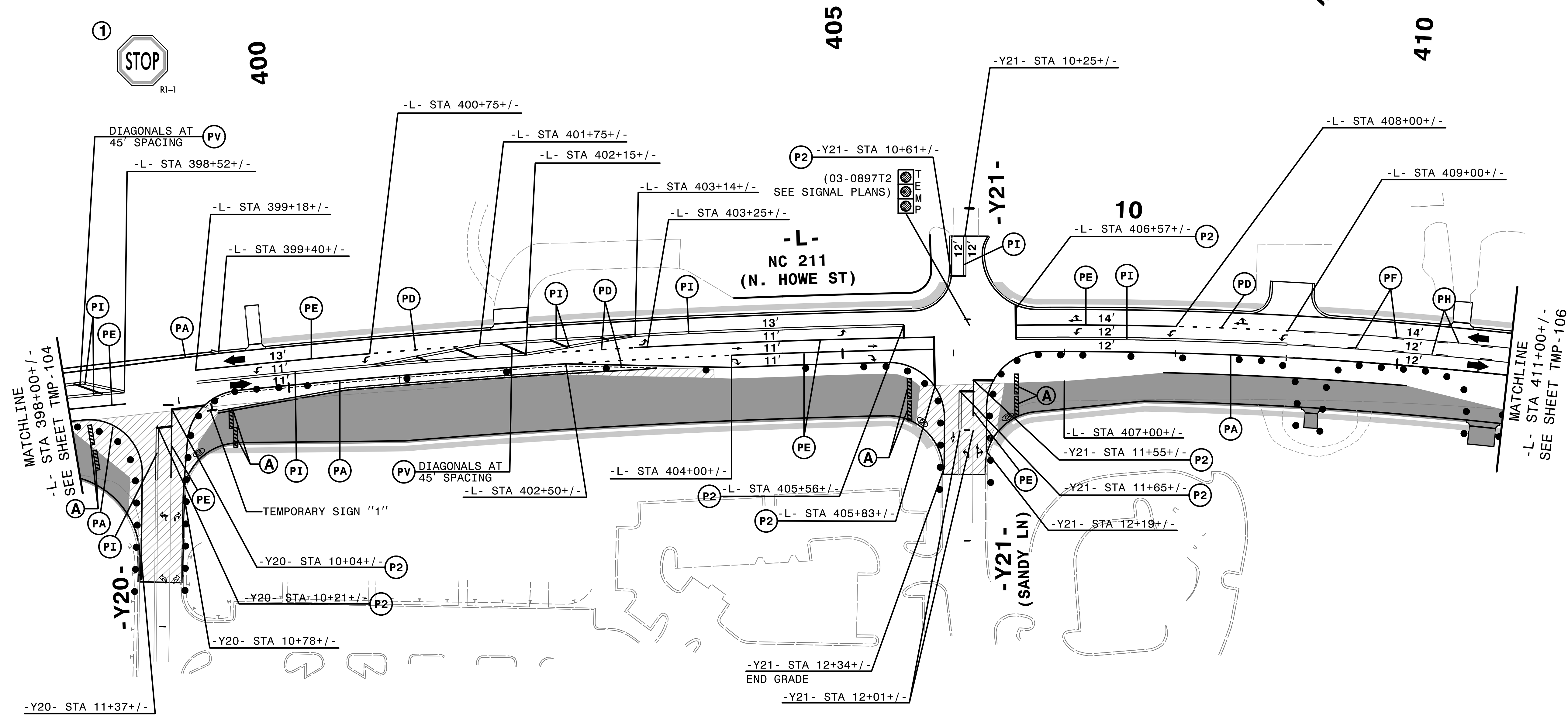
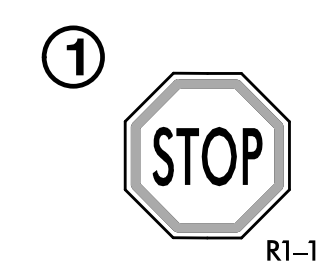
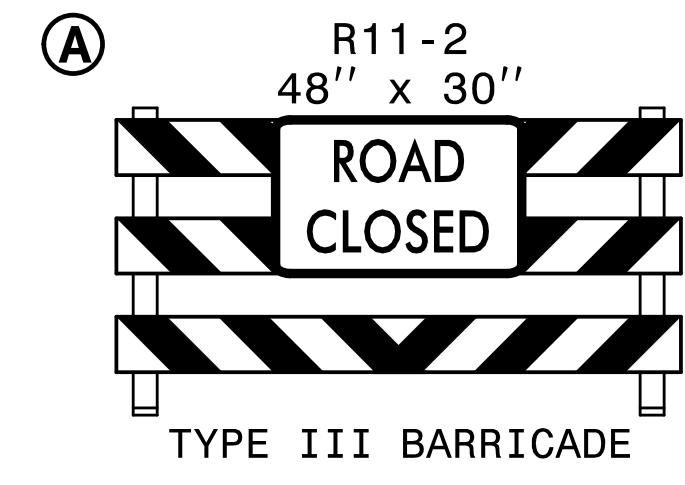

2/6/2019
HNTB

REMOVE CONFLICTING PAVEMENT MARKING.

HNTB HNTB NORTH CAROLINA, P.C.
343 E. Six Forks Road, Suite 200
Raleigh, North Carolina 27609
NC License No: C-1554

APPROVED: *Helen Skyy*
DATE: 2/6/2019
SEAL
DOCUMENT NOT CONSIDERED FINAL
UNLESS ALL SIGNATURES COMPLETED

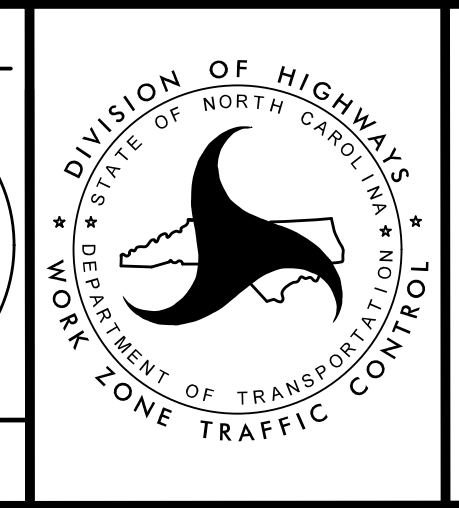

TRANSPORTATION
MANAGEMENT PLAN

PHASE II
DETAIL

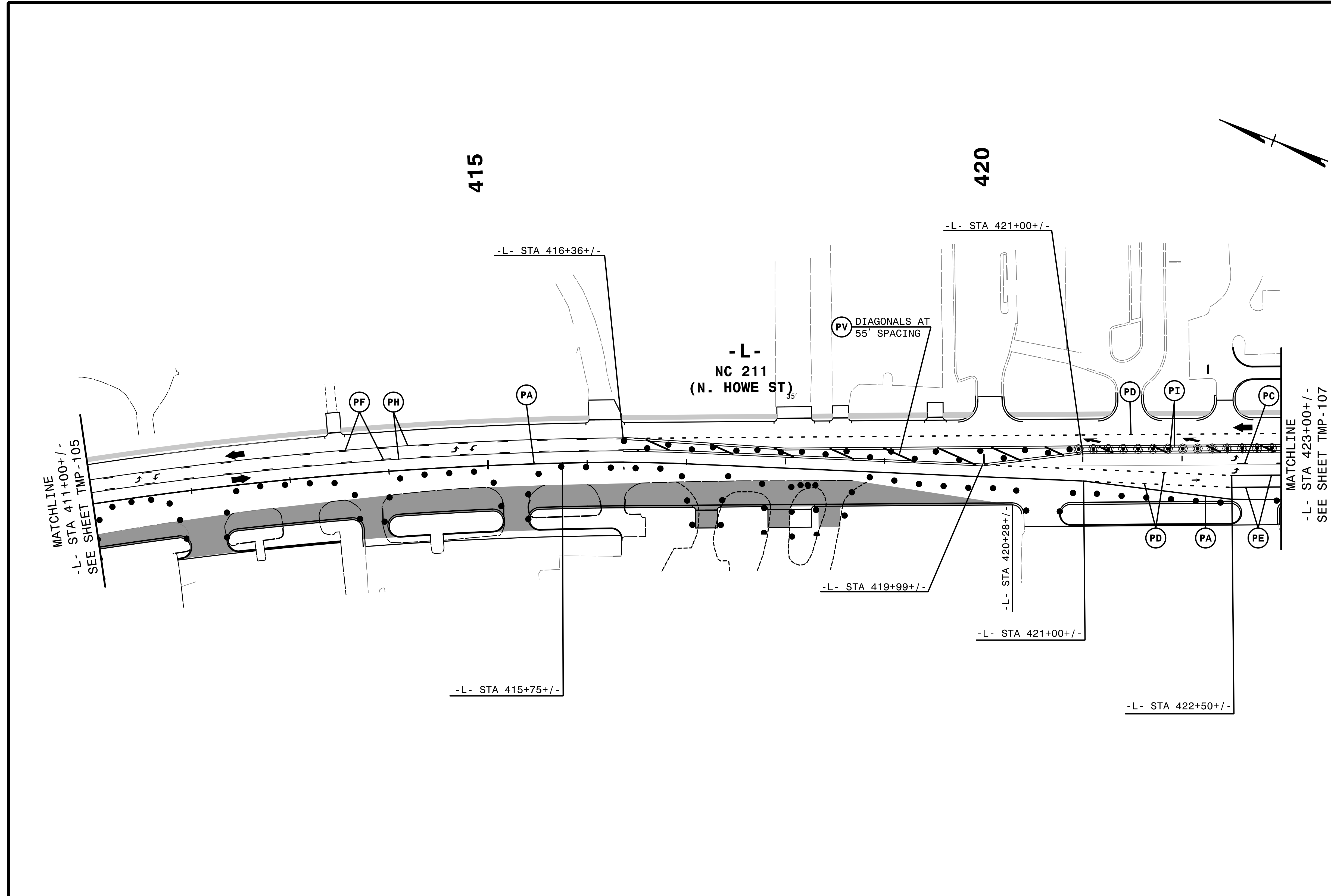

2/6/2019
C:\CPV\5021\c-p2d25.dgn
HNTB

REMOVE CONFLICTING PAVEMENT MARKING.

HNTB HNTB NORTH CAROLINA, P.C.
343 E. Six Forks Road, Suite 200
Raleigh, North Carolina 27609
NC License No: C-1554

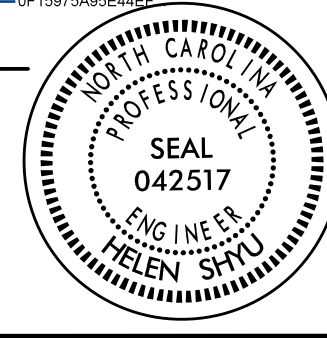
APPROVED: *Helen Skyy*
DATE: 2/6/2019
SEAL

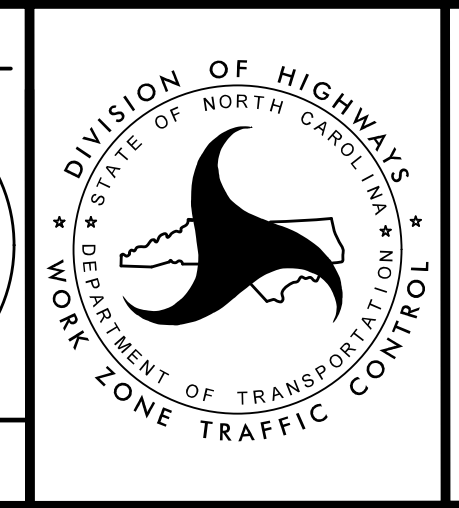

TRANSPORTATION
MANAGEMENT PLAN

PHASE II
DETAIL

DOCUMENT NOT CONSIDERED FINAL
UNLESS ALL SIGNATURES COMPLETED

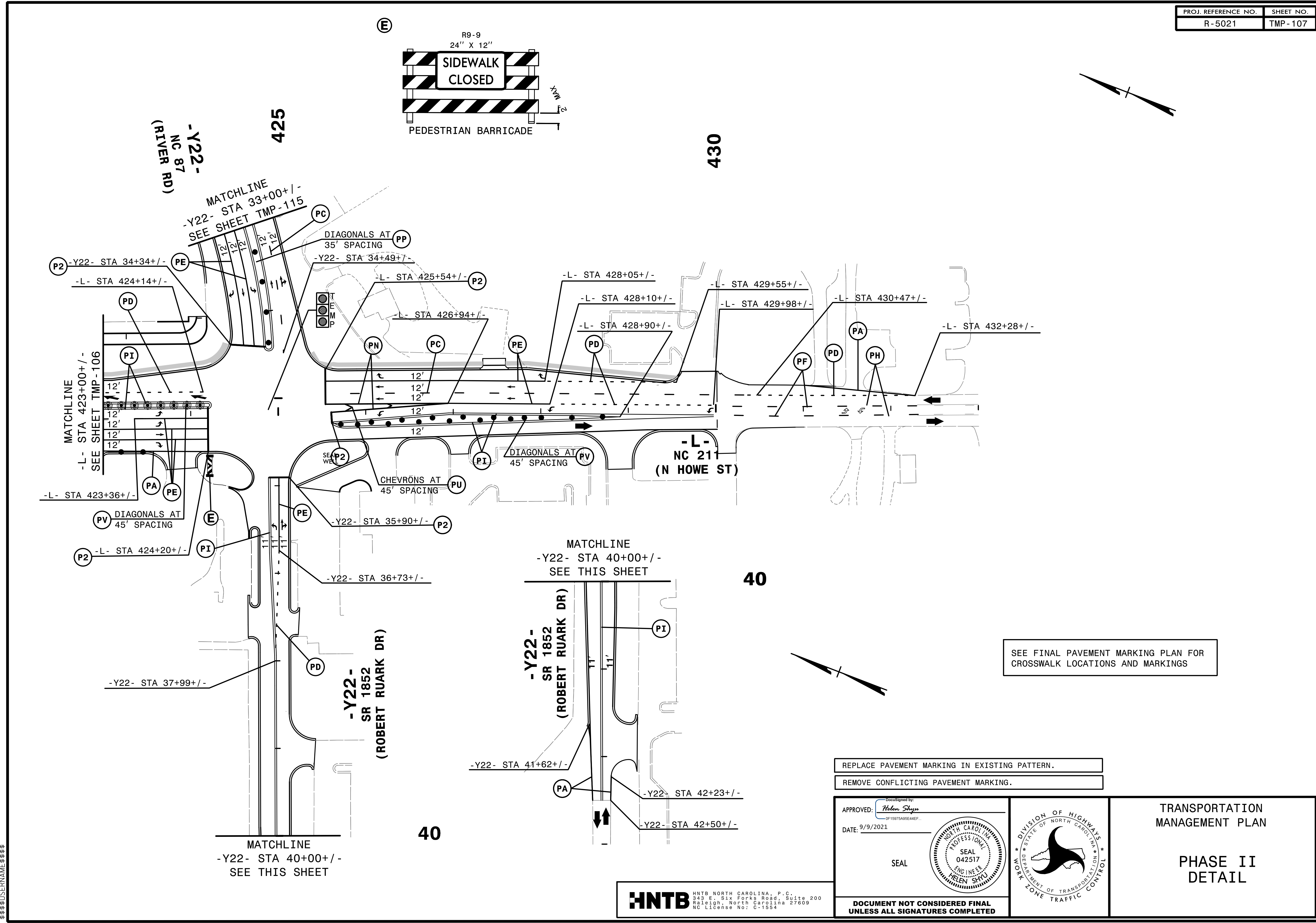

SEE FINAL PAVEMENT MARKING PLAN FOR CROSSWALK LOCATIONS AND MARKINGS

REPLACE PAVEMENT MARKING IN EXISTING PATTERN.
 REMOVE CONFLICTING PAVEMENT MARKING.

APPROVED: *Helen Shyu*
 DATE: 9/9/2021
 SEAL
 HNTB NORTH CAROLINA, P.C.
 343 E. Six Forks Road, Suite 200
 Raleigh, North Carolina 27609
 NC License No: C-1554

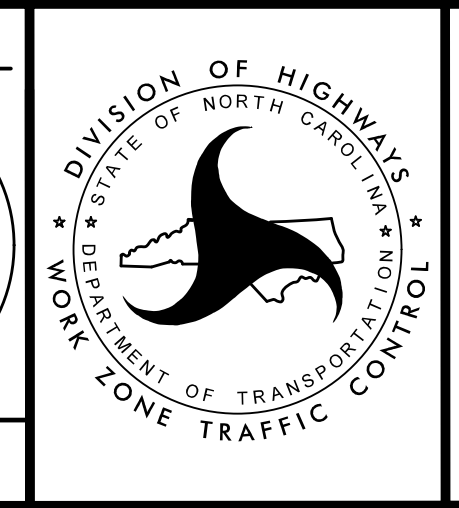

TRANSPORTATION
 MANAGEMENT PLAN
 PHASE II
 DETAIL

4:54:54 PM
 \\TCN\F5021\Tc_p2d26.dgn
 \$\$\$USERNAME\$\$\$

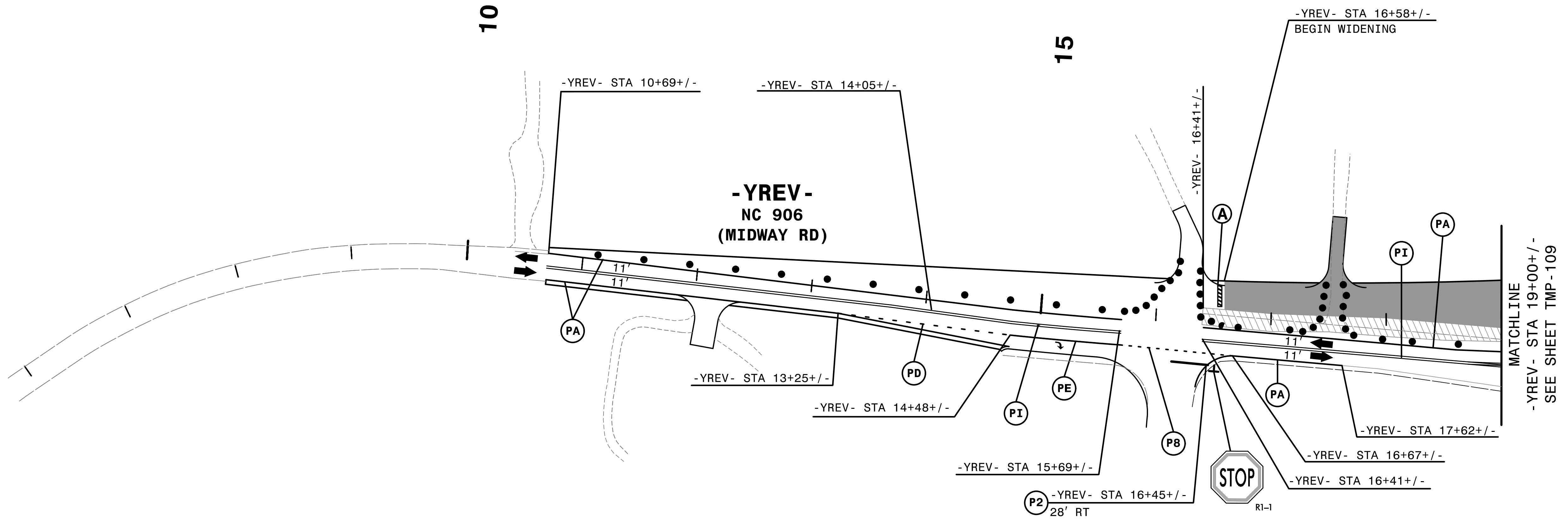
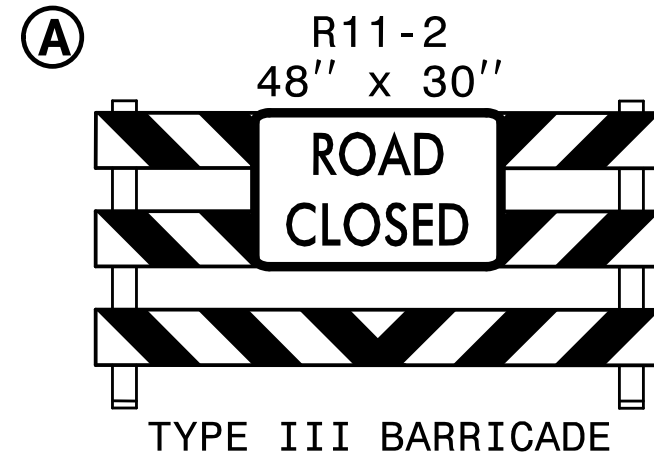

2/6/2019
TCPLV-5021-10-p2.dwg
HNTB

REMOVE CONFLICTING PAVEMENT MARKING.

HNTB HNTB NORTH CAROLINA, P.C.
343 E. Six Forks Road, Suite 200
Raleigh, North Carolina 27609
NC License No: C-1554

APPROVED: *Helen Shyu*
DATE: 2/6/2019

SEAL

PROFESSIONAL SEAL
042517
ENGINEER
HELEN SHYU

DOCUMENT NOT CONSIDERED FINAL
UNLESS ALL SIGNATURES COMPLETED

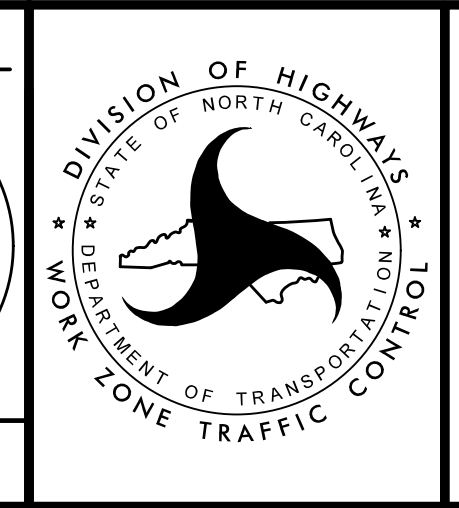

TRANSPORTATION
MANAGEMENT PLAN

PHASE II
DETAIL

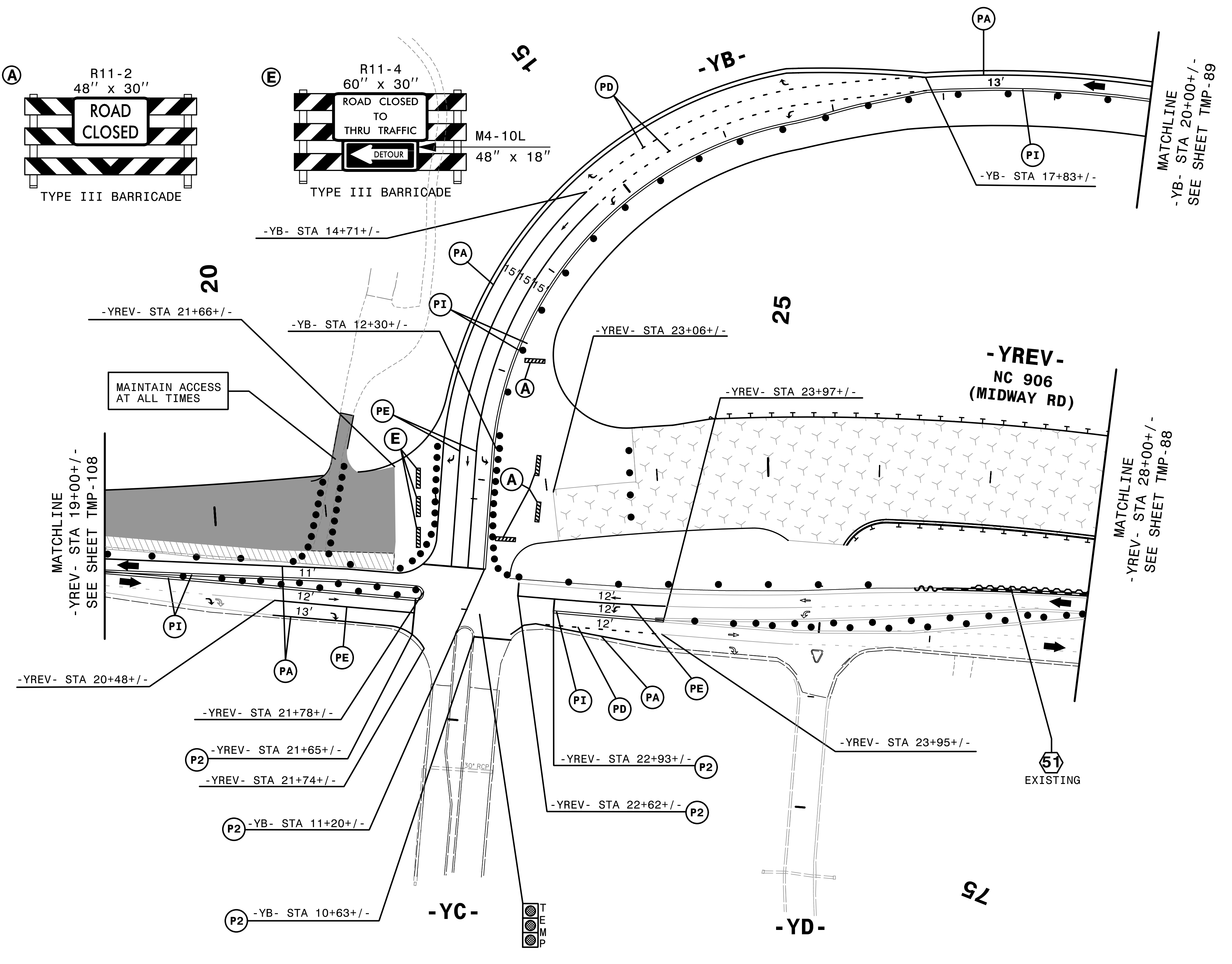
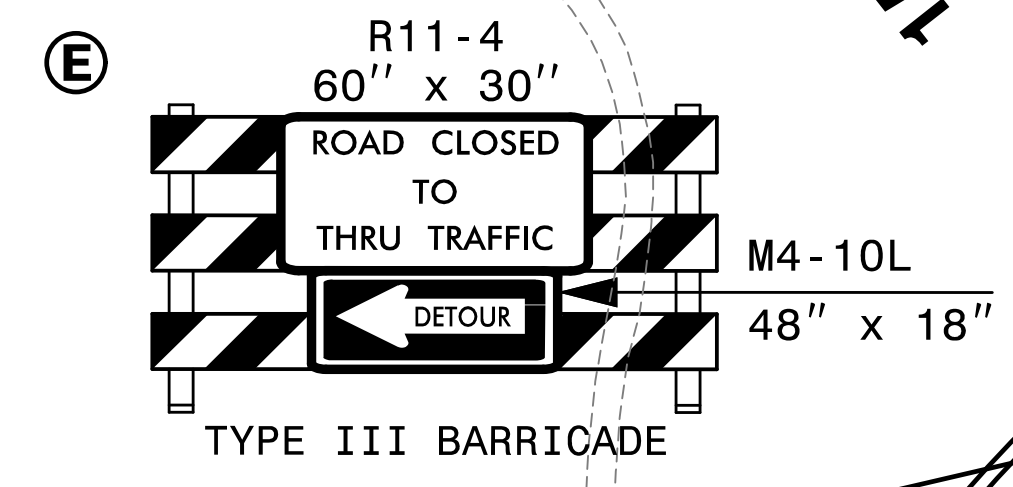
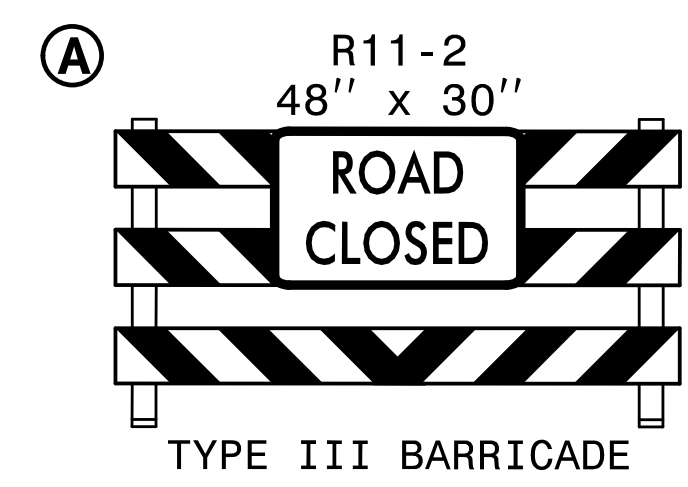

4:54:57 PM
 \\TCFV-5021_LTC_p2d29.dgn
 \$\$\$\$(USERNAM\$\$\$\$\$

REMOVE CONFLICTING PAVEMENT MARKING.

HNTB HNTB NORTH CAROLINA, P.C.
 343 E. Six Forks Road, Suite 200
 Raleigh, North Carolina 27609
 NC License No: C-1554

APPROVED: *Helen Shyu*
 DATE: 9/9/2021
 SEAL
 DOCUMENT NOT CONSIDERED FINAL
 UNLESS ALL SIGNATURES COMPLETED

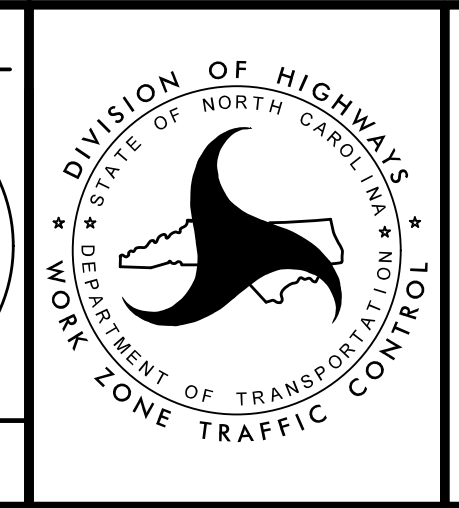

TRANSPORTATION
 MANAGEMENT PLAN

**PHASE II
 DETAIL**

DIVISION OF HIGHWAYS
 STATE OF NORTH CAROLINA
 DEPARTMENT OF TRANSPORTATION
 WORK ZONE TRAFFIC CONTROL

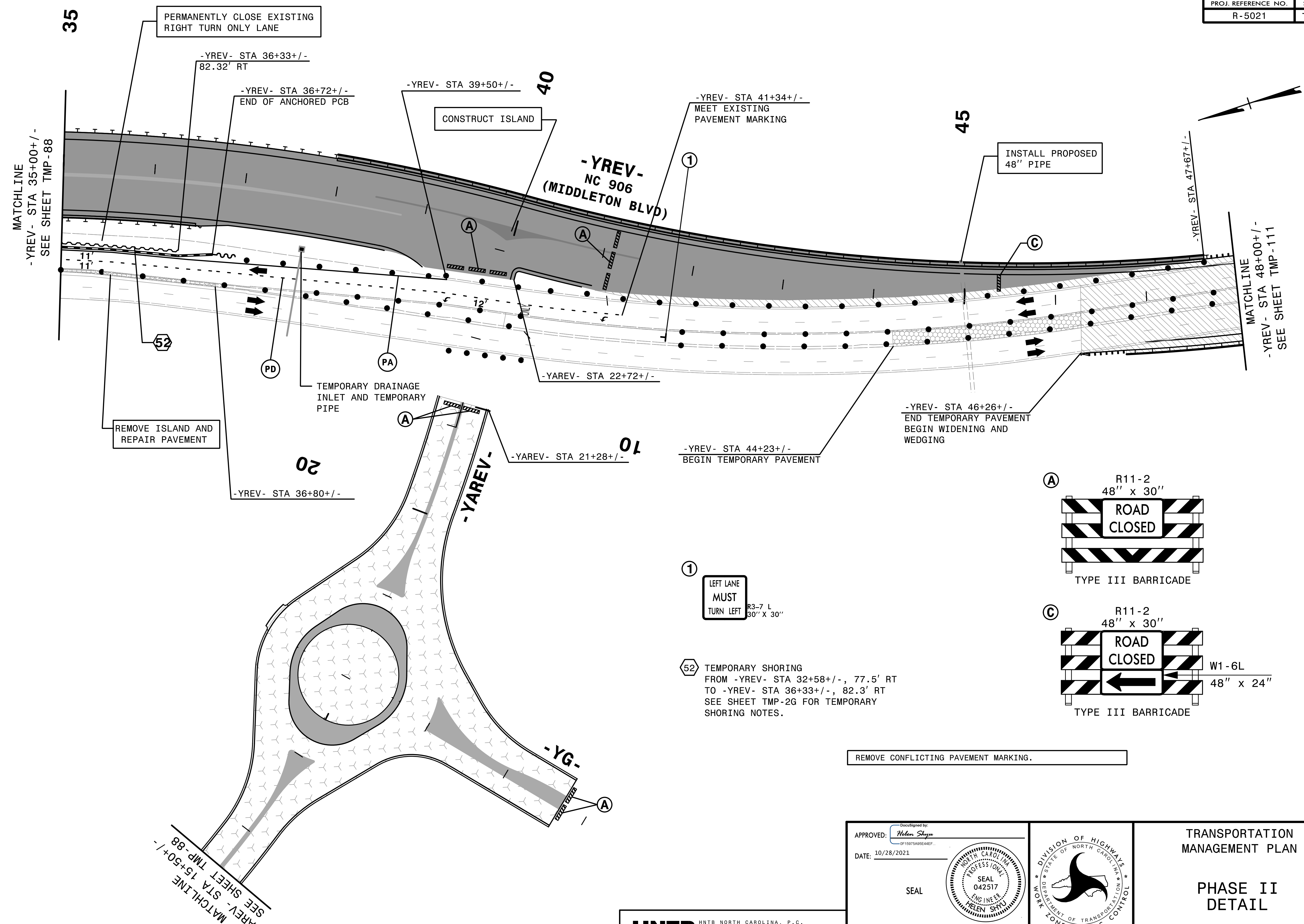

MATCHLINE
-YREV- STA 35+00+/-
SEE SHEET TMP-88

MATCHLINE
-YREV- STA 48+00+/-
SEE SHEET TMP-111

REMOVE ISLAND AND REPAIR PAVEMENT

CONSTRUCT ISLAND

INSTALL PROPOSED 48" PIPE

-YREV- NC 906 (MIDDLETON BLVD)

-YREV- STA 41+34+/-
MEET EXISTING PAVEMENT MARKING

-YREV- STA 46+26+/-
END TEMPORARY PAVEMENT
BEGIN WIDENING AND WEDGING

-YREV- STA 44+23+/-
BEGIN TEMPORARY PAVEMENT

-YREV- STA 36+80+/-

-YREV- STA 21+28+/-

-YAREV- STA 22+72+/-

-YREV- STA 36+33+/-
82.32' RT

-YREV- STA 36+72+/-
END OF ANCHORED PCB

-YREV- STA 39+50+/-

MATCHLINE
-YAREV- STA 15+50+/-
SEE SHEET TMP-88

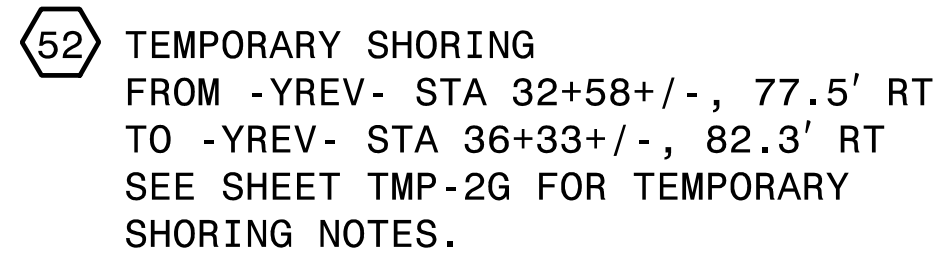
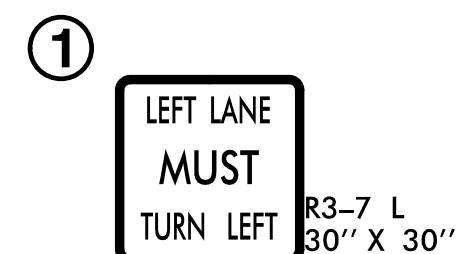
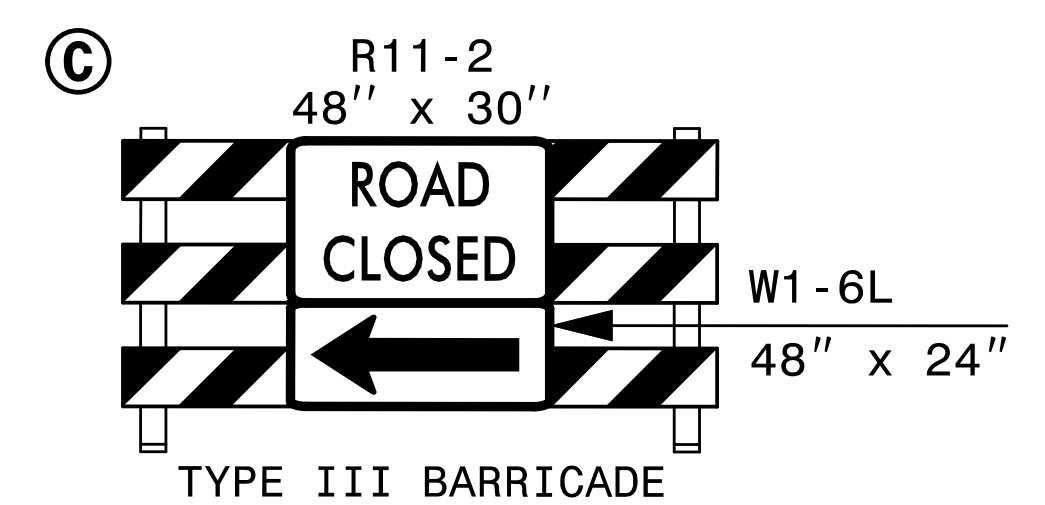
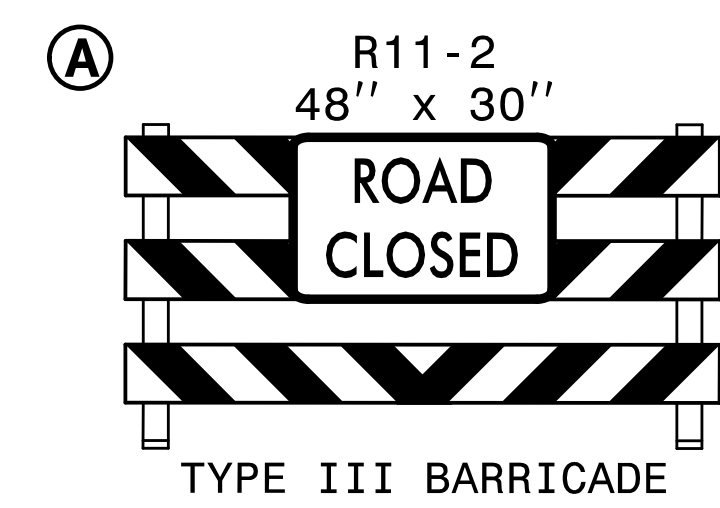

REMOVE CONFLICTING PAVEMENT MARKING.

3:23:46 PM
\\TCPL\F5021\TC_P2d30.dgn
\$\$\$\$\$USERNAME\$\$\$\$\$



APPROVED: *Helen Shyu*
DATE: 10/28/2021

SEAL

DOCUMENT NOT CONSIDERED FINAL UNLESS ALL SIGNATURES COMPLETED

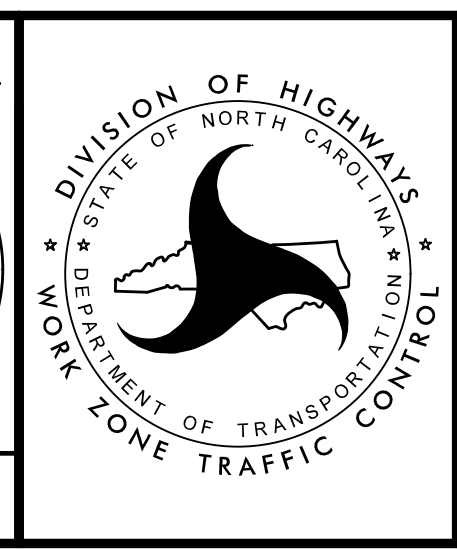

TRANSPORTATION MANAGEMENT PLAN

PHASE II DETAIL

PROJ. REFERENCE NO.	SHEET NO.
R-5021	TMP-111

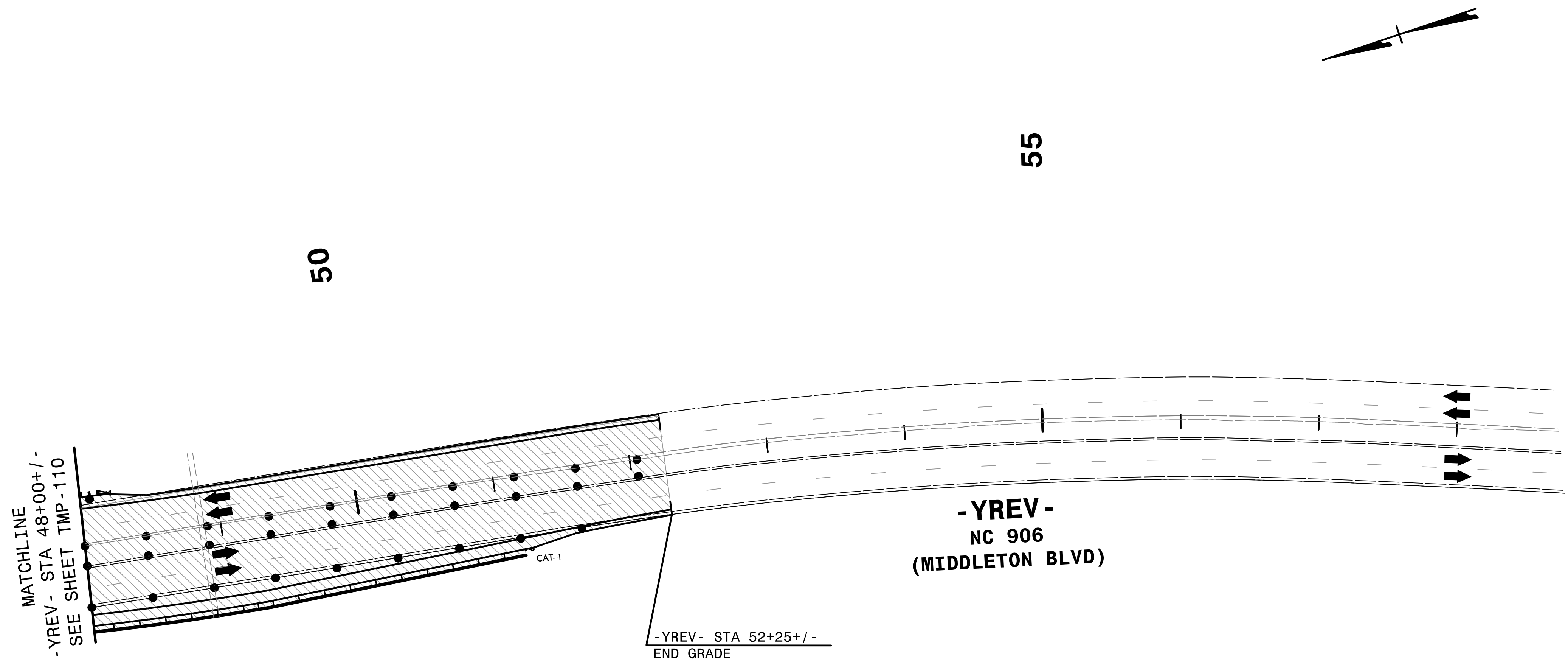

2/6/2019
 HNTB
 HNTB

REPLACE PAVEMENT MARKING IN EXISTING PATTERN.

HNTB HNTB NORTH CAROLINA, P.C.
 343 E. Six Forks Road, Suite 200
 Raleigh, North Carolina 27609
 NC License No: C-1554

APPROVED: *Helen Shyu*
 DATE: 2/6/2019
 SEAL
 PROFESSIONAL SEAL
 042517
 ENGINEER
 HELEN SHYU

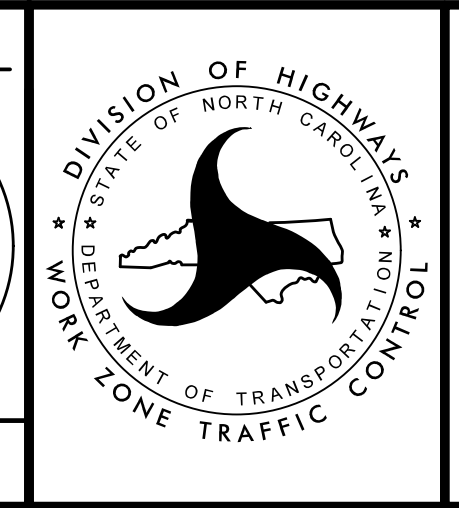

TRANSPORTATION
 MANAGEMENT PLAN
 PHASE II
 DETAIL

DOCUMENT NOT CONSIDERED FINAL
 UNLESS ALL SIGNATURES COMPLETED

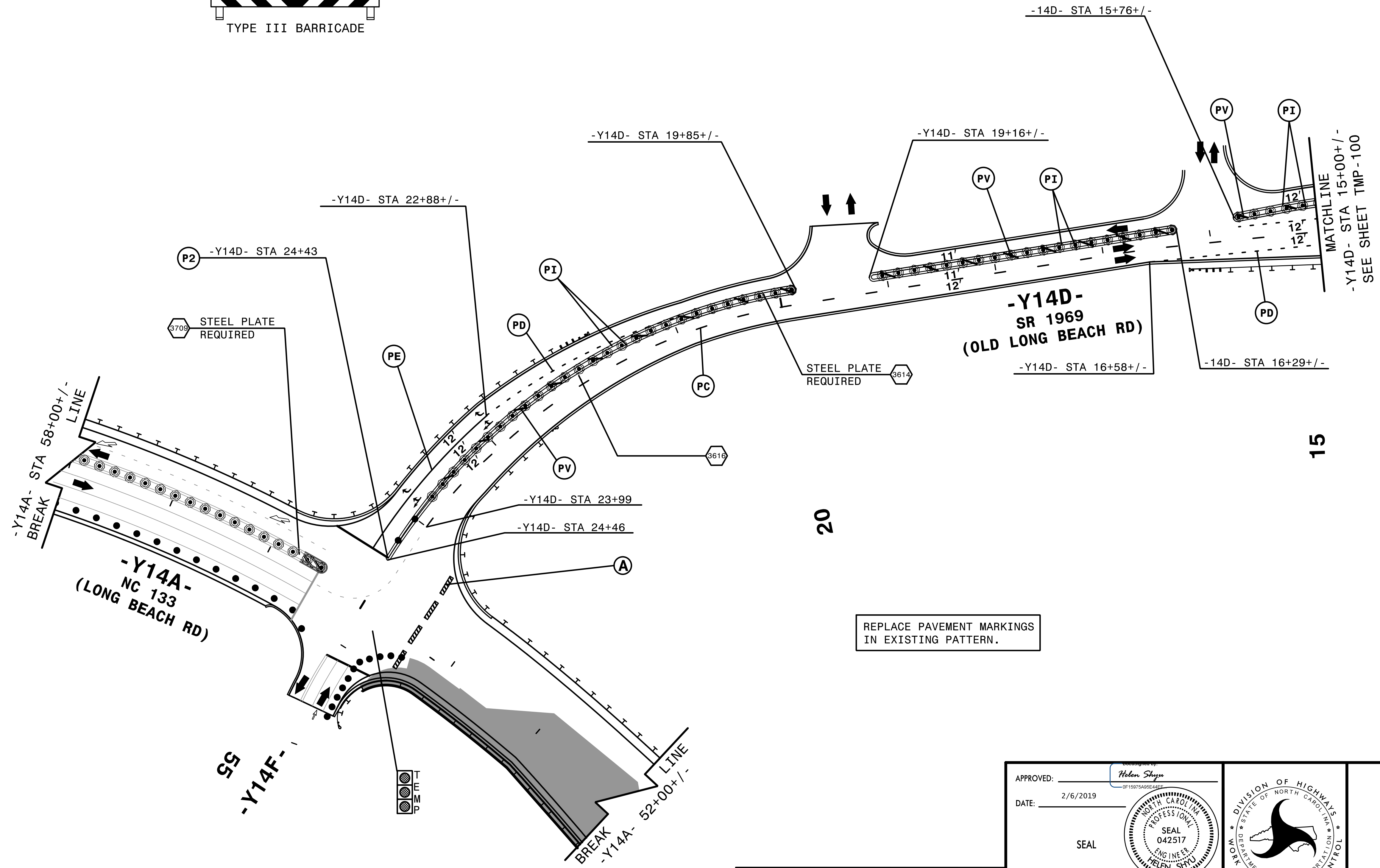
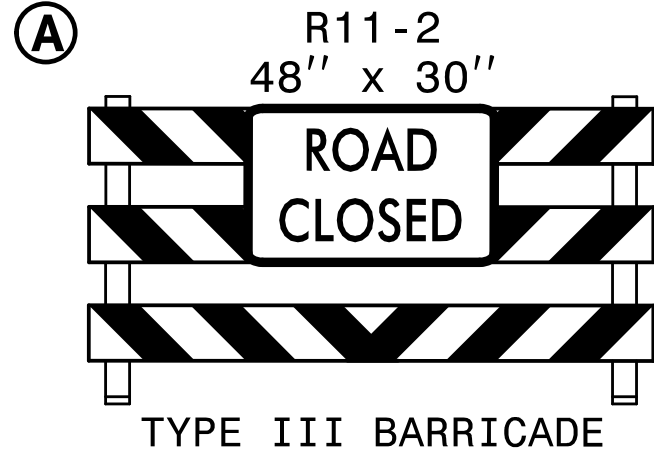

2/6/2019
TCPLV-5021-10-p2d35.dgn
HNTB

HNTB HNTB NORTH CAROLINA, P.C.
343 E. Six Forks Road, Suite 200
Raleigh, North Carolina 27609
NC License No: C-1554

APPROVED: *Helen Shyu*
DATE: 2/6/2019
SEAL
DOCUMENT NOT CONSIDERED FINAL
UNLESS ALL SIGNATURES COMPLETED

PROFESSIONAL ENGINEER
HELEN SHYU
042517
STATE OF NORTH CAROLINA

DIVISION OF HIGHWAYS
STATE OF NORTH CAROLINA
DEPARTMENT OF TRANSPORTATION
WORK ZONE TRAFFIC CONTROL

TRANSPORTATION
MANAGEMENT PLAN
PHASE II
DETAIL

PROJ. REFERENCE NO.	SHEET NO.
R-5021	TMP-113

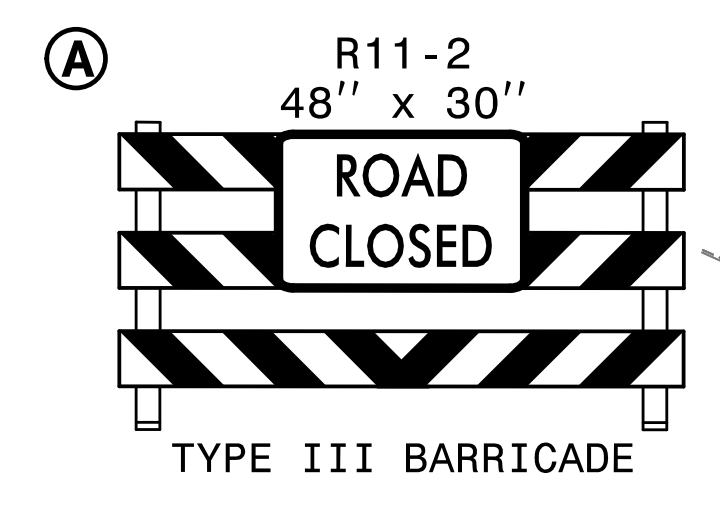
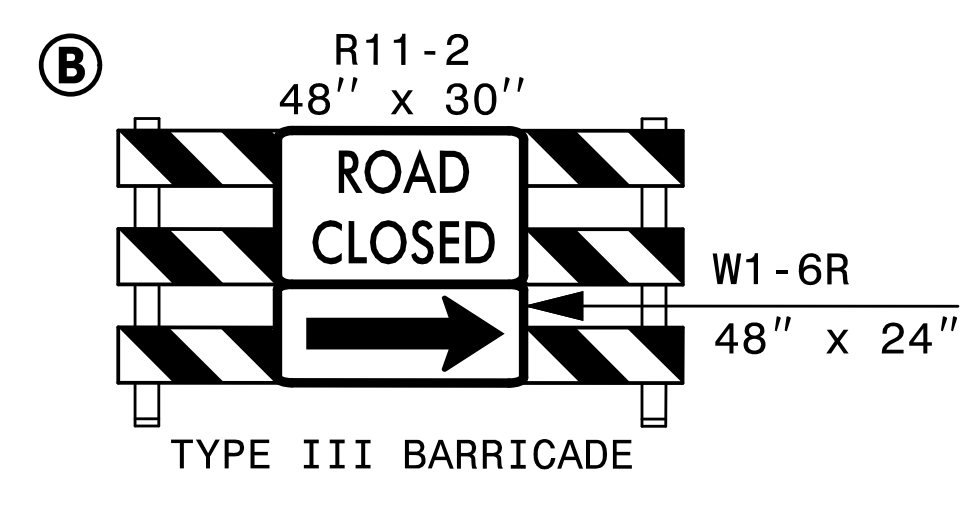

MATCHLINE
-Y14A- STA 36+50+/-
SEE SHEET TMP-99

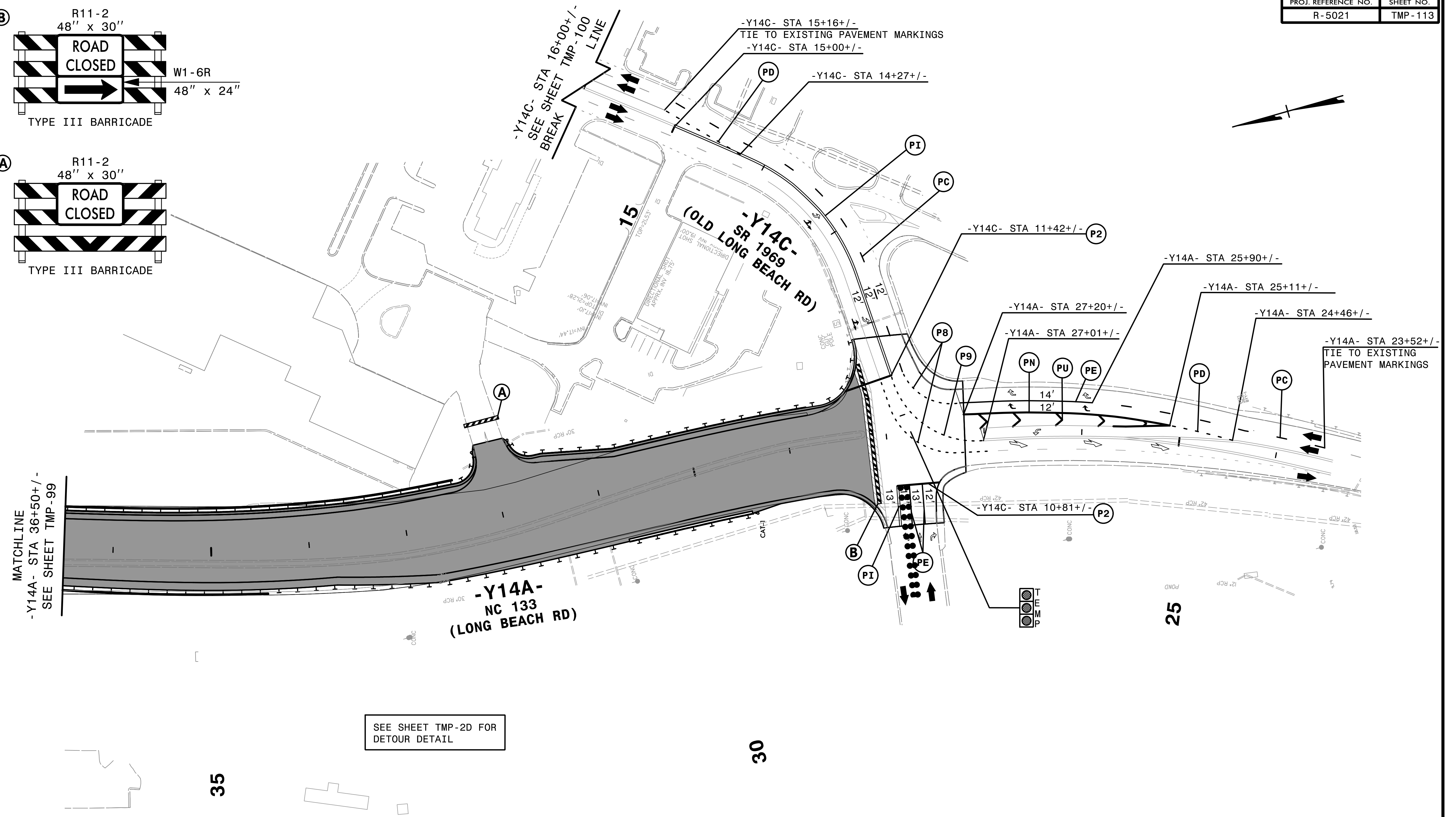

4:37:37 PM
\\TCFV\5021\TC\p1d34a.dgn
\$\$\$\$\$USERNAME\$\$\$\$\$

HNTB HNTB NORTH CAROLINA, P.C.
343 E. Six Forks Road, Suite 200
Raleigh, North Carolina 27609
NC License No: C-1554

APPROVED: *Helen Shyu*
DATE: 9/9/2021

SEAL

DOCUMENT NOT CONSIDERED FINAL
UNLESS ALL SIGNATURES COMPLETED

TRANSPORTATION
MANAGEMENT PLAN

PHASE II
DETAIL

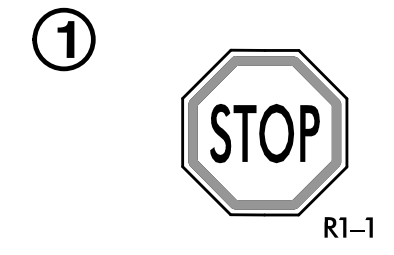
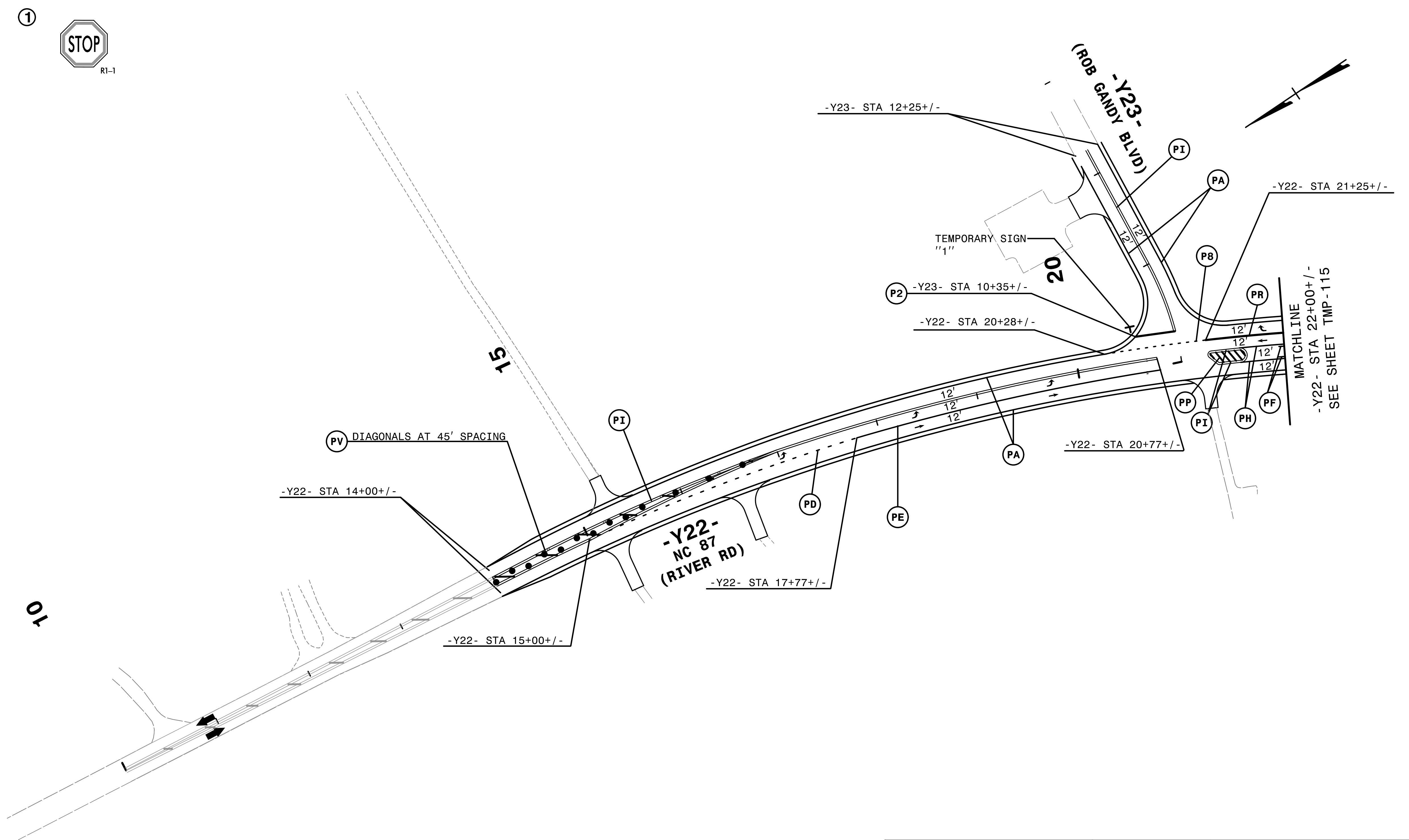

4:55:03 PM
 \\TCFV-5021\TC_P2d38.dgn
 \$\$\$USERNAME\$\$\$

HNTB HNTB NORTH CAROLINA, P.C.
 343 E. Six Forks Road, Suite 200
 Raleigh, North Carolina 27609
 NC License No: C-1554

APPROVED: *Helen Shyu*
 DATE: 9/9/2021
 SEAL
 PROFESSIONAL ENGINEER
 HELEN SHYU
 042517

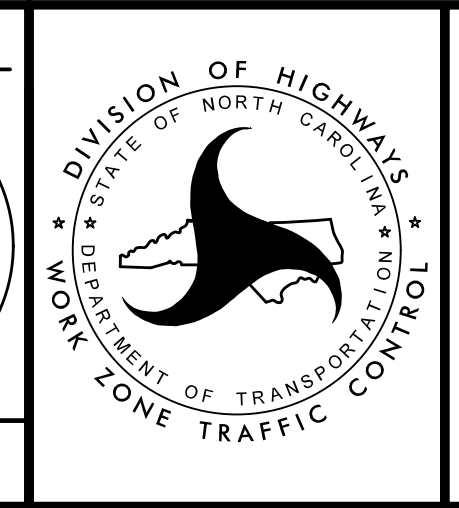

TRANSPORTATION
 MANAGEMENT PLAN

 PHASE II
 DETAIL

DOCUMENT NOT CONSIDERED FINAL UNLESS ALL SIGNATURES COMPLETED

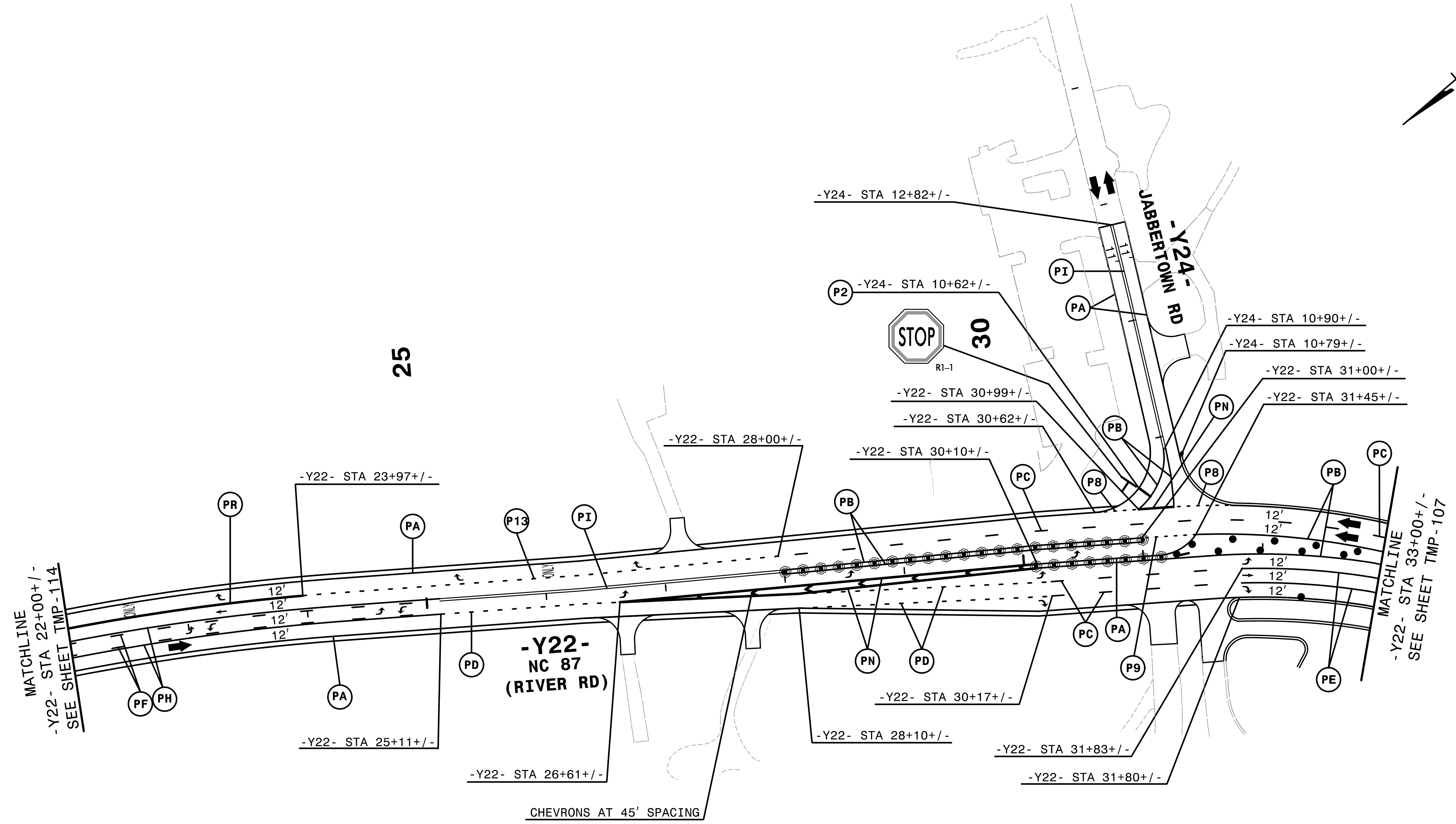

REMOVE CONFLICTING PAVEMENT MARKING.

4/14/23, PM
 \\TCF\...5021\...p2d39.dgn
 \$\$\$USERNAME\$\$\$

HNTB
 HNTB NORTH CAROLINA, P.C.
 343 E. Six Forks Road, Suite 200
 Raleigh, North Carolina 27609
 NC License No: C-1554

APPROVED: *Helen Shyu*
 DATE: 9/9/2021
 SEAL
 DOCUMENT NOT CONSIDERED FINAL
 UNLESS ALL SIGNATURES COMPLETED

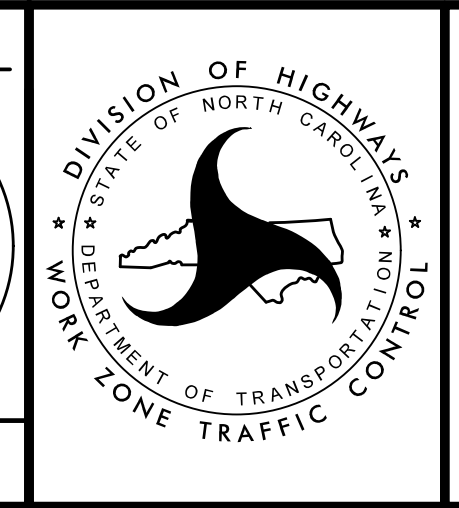
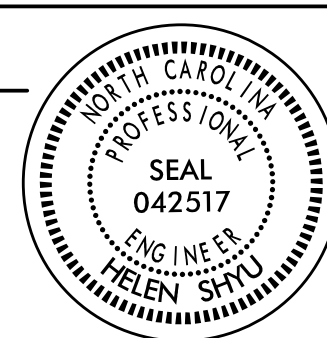

TRANSPORTATION
 MANAGEMENT PLAN

 PHASE II
 DETAIL

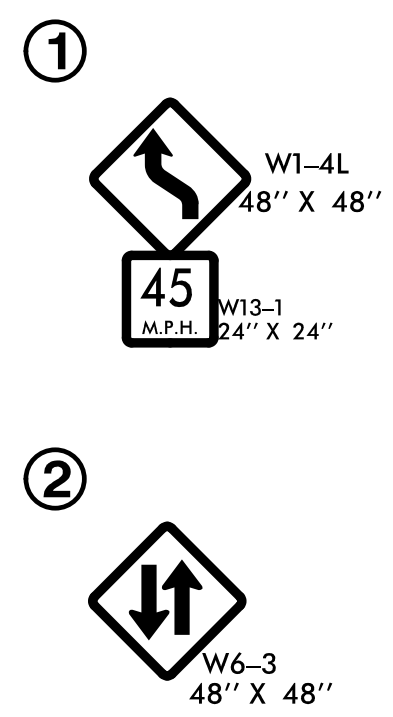
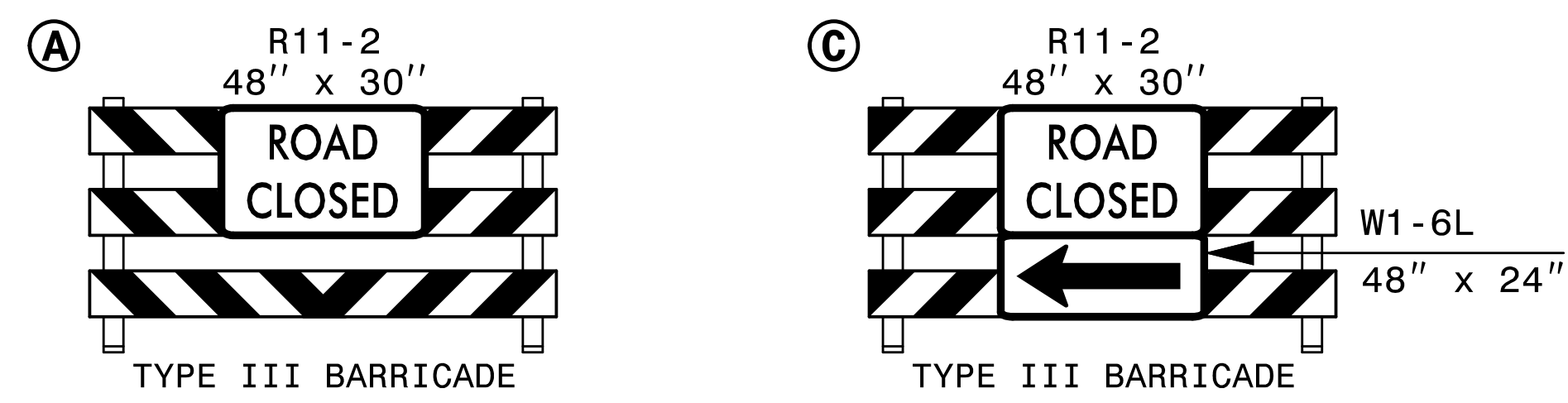

4:57:02 PM
\\15021.fc.p2d3.GreenT.Sidgn
\$\$\$\$\$USERNAME\$\$\$\$\$

52

REMOVE CONFLICTING PAVEMENT MARKING.

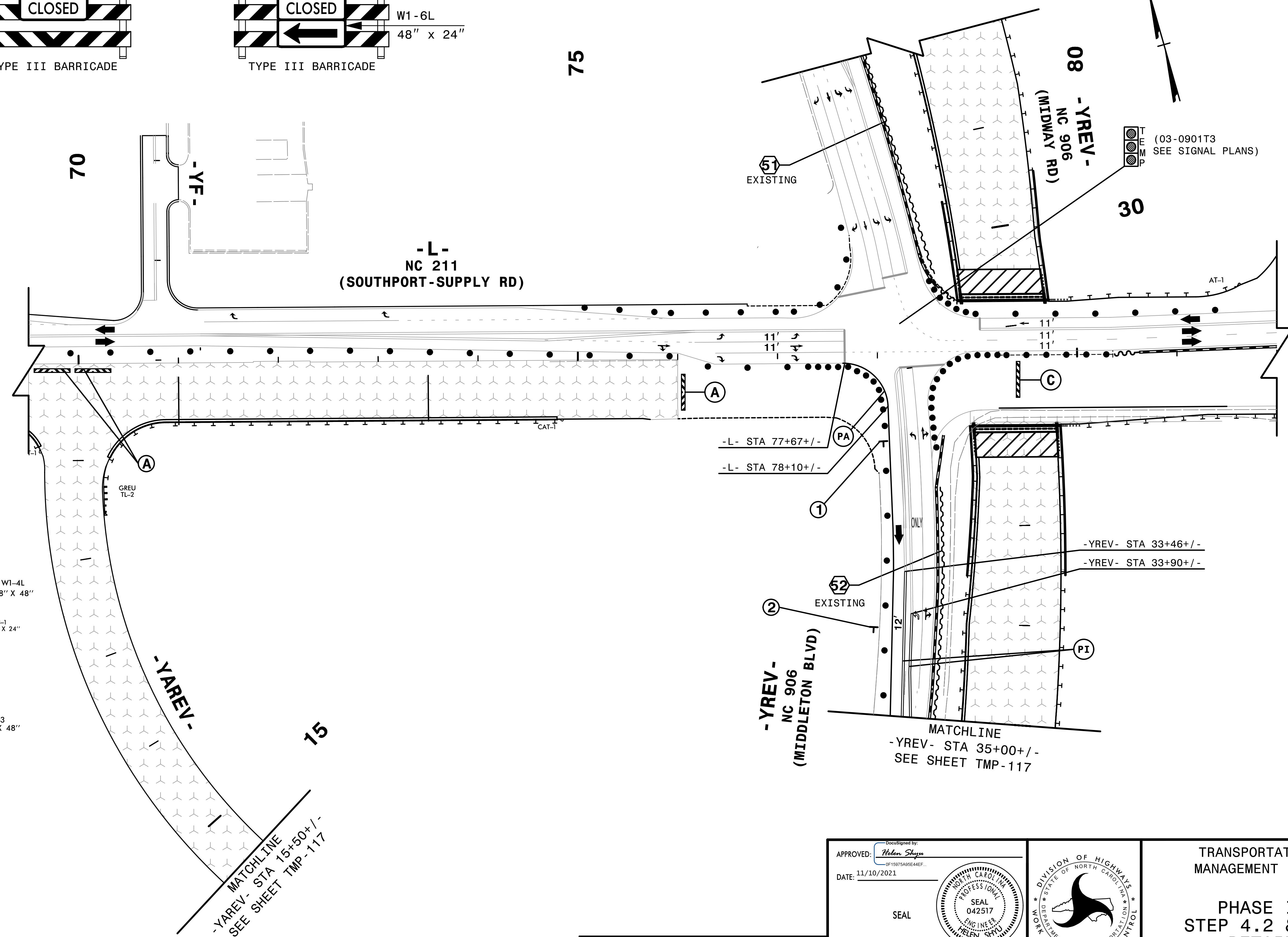

HNTB
 HNTB NORTH CAROLINA, P.C.
 343 E. Six Forks Road, Suite 200
 Raleigh, North Carolina 27609
 NC License No: C-1554

APPROVED: *Helen Shyn*
 DATE: 11/10/2021
 SEAL
 NORTH CAROLINA
 PROFESSIONAL
 SEAL
 042517
 ENGINEER
 HELEN SHYN

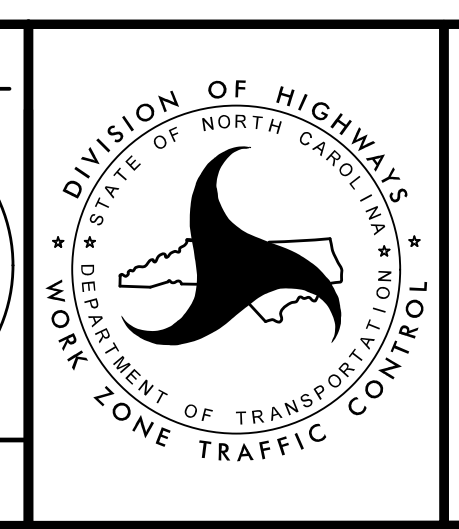

TRANSPORTATION
 MANAGEMENT PLAN
 PHASE II
 STEP 4.2 & 4.3
 DETAIL

DOCUMENT NOT CONSIDERED FINAL
UNLESS ALL SIGNATURES COMPLETED

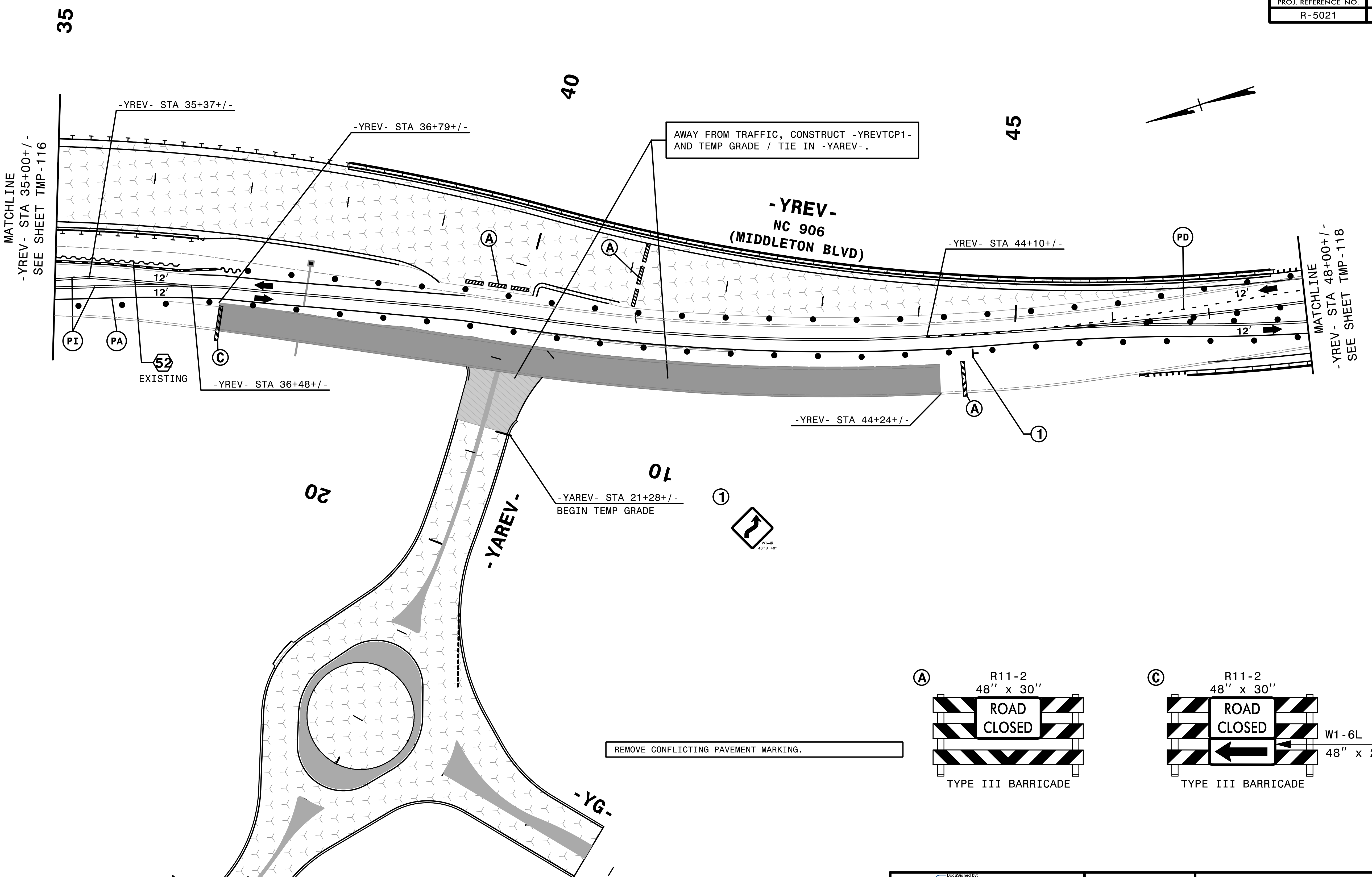

4:57:06 PM
 Y:\5021\TC_P2D30_GreenT_Sldgn
 \$\$\$USERNAME\$\$\$

MATCHLINE
 -YAREV- STA 15+50+/-
 SEE SHEET TMP-116

APPROVED: *Helen Shyu*
 DATE: 11/10/2021

SEAL

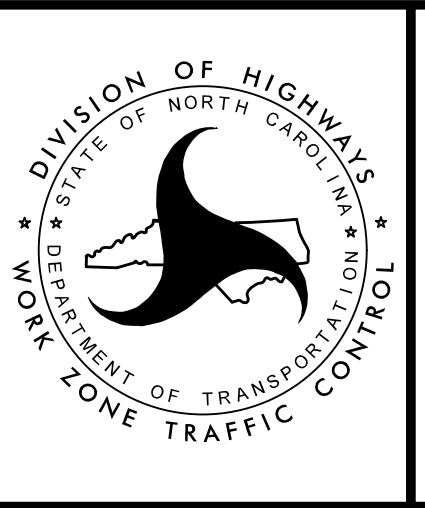

TRANSPORTATION
 MANAGEMENT PLAN

PHASE II
 STEPS 4.2 & 4.3
 DETAIL

HNTB HNTB NORTH CAROLINA, P.C.
 343 E. Six Forks Road, Suite 200
 Raleigh, North Carolina 27609
 NC License No: C-1554

DOCUMENT NOT CONSIDERED FINAL
 UNLESS ALL SIGNATURES COMPLETED

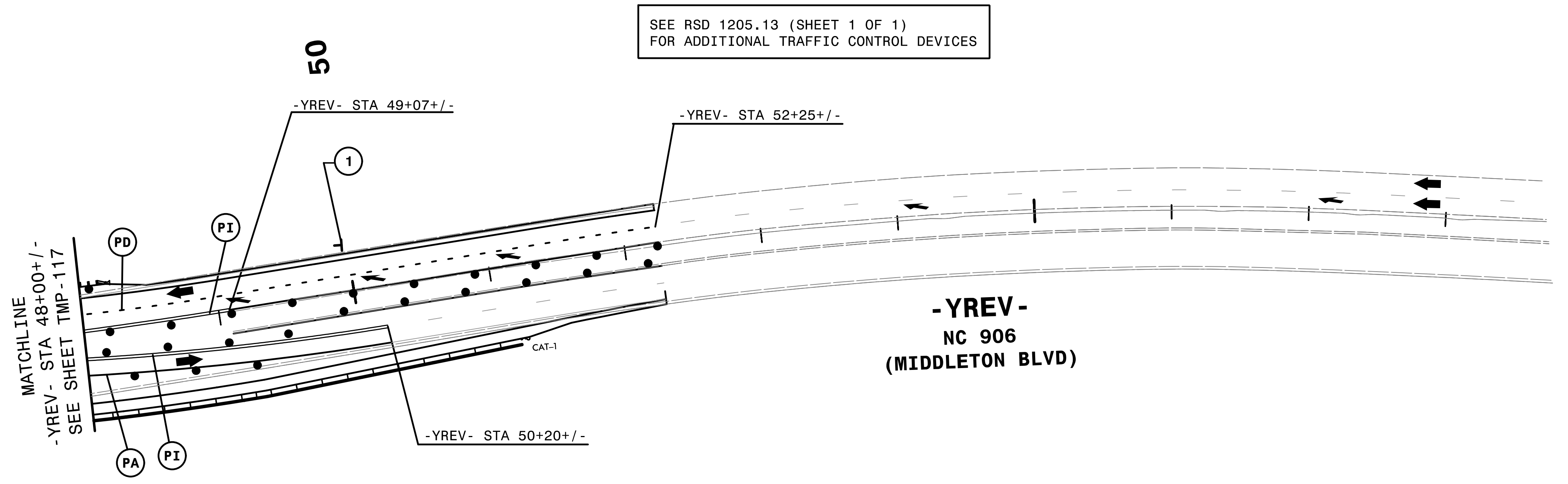
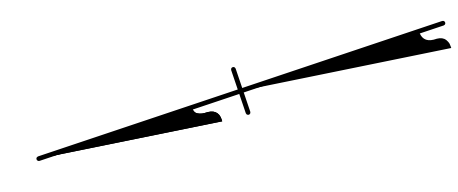
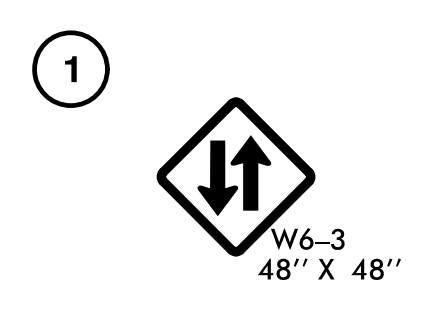

-YREV-
NC 906
(MIDDLETON BLVD)

REMOVE CONFLICTING PAVEMENT MARKING.

4:57:09 PM
 Y:\5021_Tc_p2d31\Green T_Six.dgn
 \$\$\$USERNAME\$\$\$

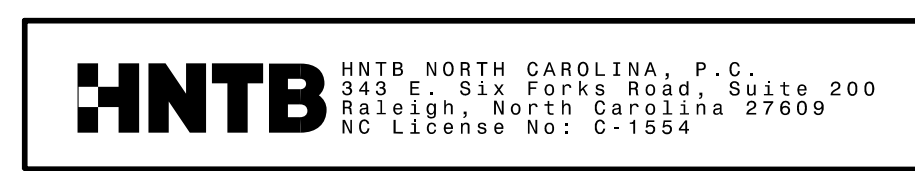

APPROVED: *Helen Shyu*
 DATE: 11/10/2021

SEAL

**DOCUMENT NOT CONSIDERED FINAL
 UNLESS ALL SIGNATURES COMPLETED**

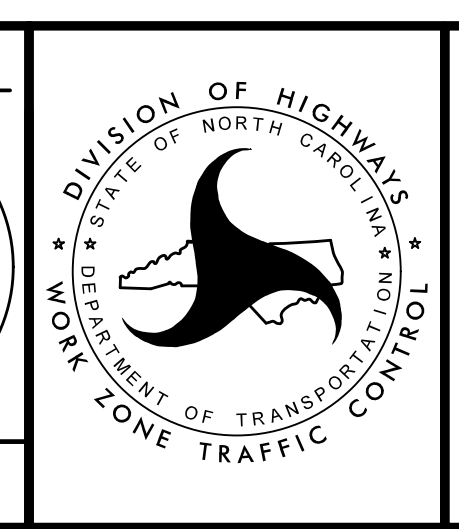

TRANSPORTATION
 MANAGEMENT PLAN

PHASE II
STEP 4.2 & 4.3
DETAIL

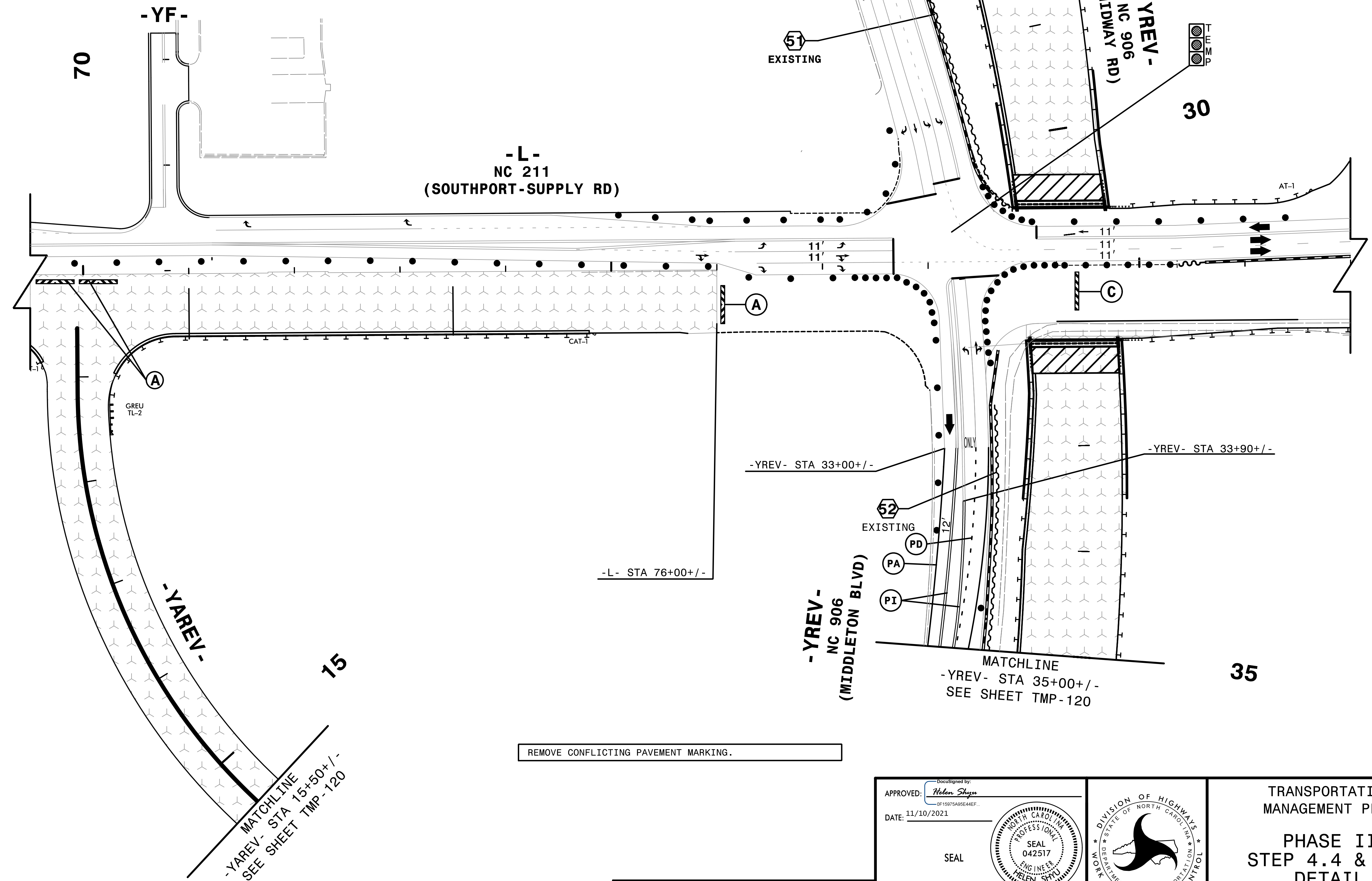
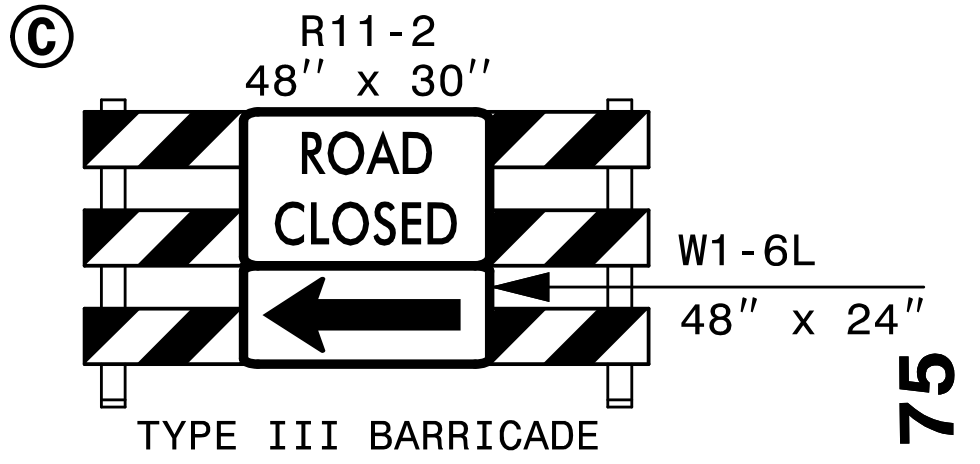
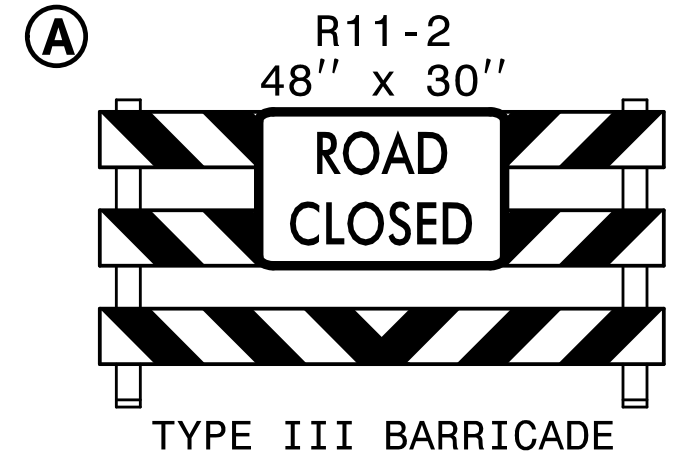

4:57:12 PM
Y:\5021\TC_P2d3_GreenT_S2.dgn
\$\$\$\$\$USERNAME\$\$\$\$\$

HNTB HNTB NORTH CAROLINA, P.C.
343 E. Six Forks Road, Suite 200
Raleigh, North Carolina 27603
NC License No: C-1554

APPROVED: *Helen Shyn*
DATE: 11/10/2021
SEAL

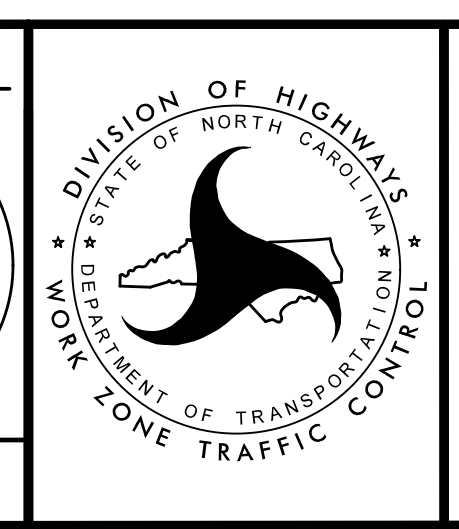

TRANSPORTATION
MANAGEMENT PLAN

PHASE II
STEP 4.4 & 4.5
DETAIL

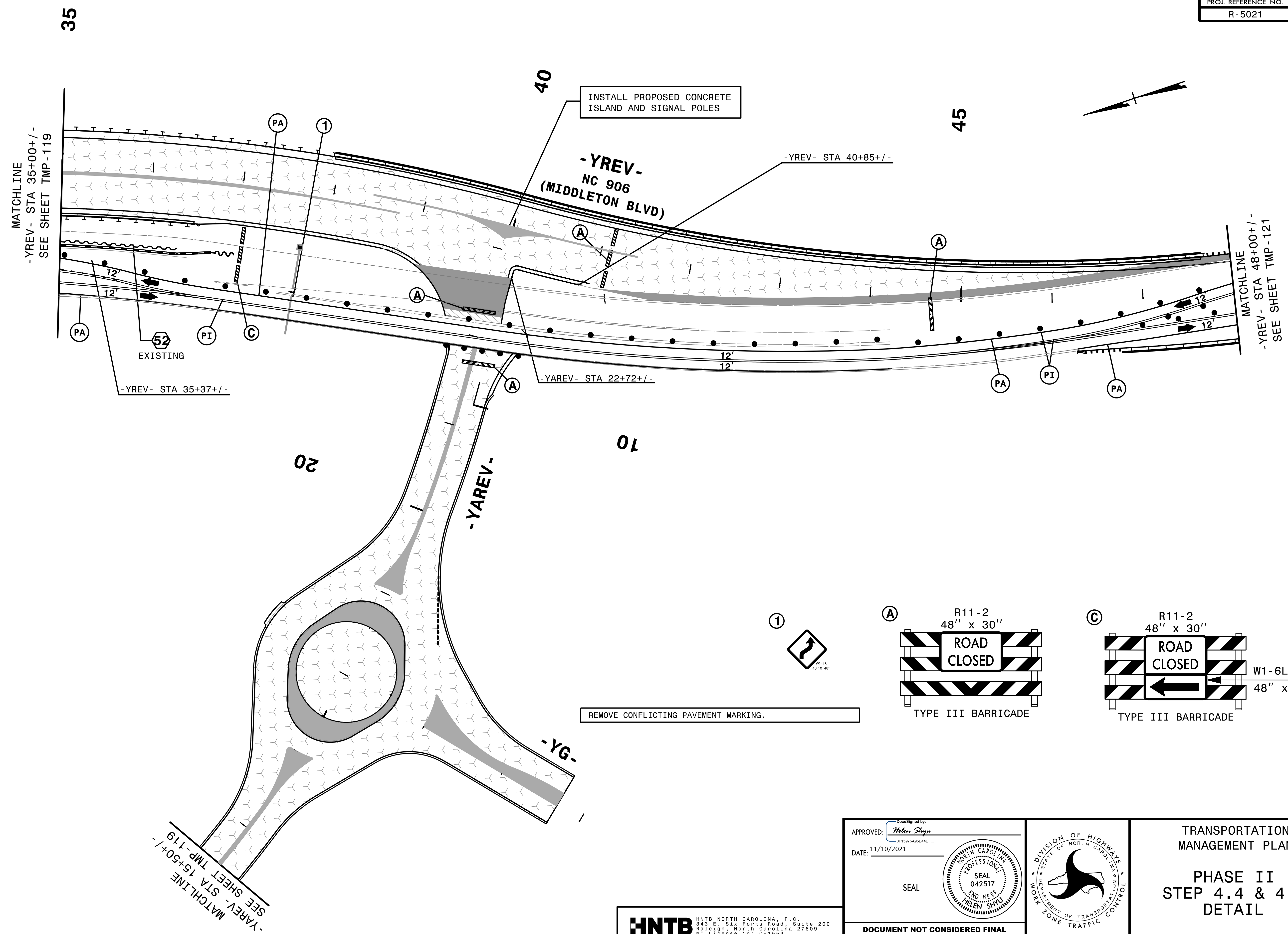

REMOVE CONFLICTING PAVEMENT MARKING.

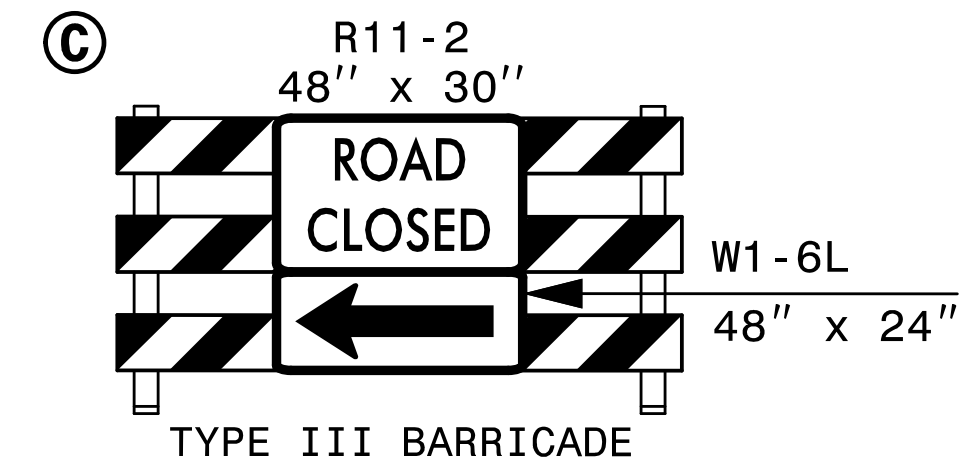
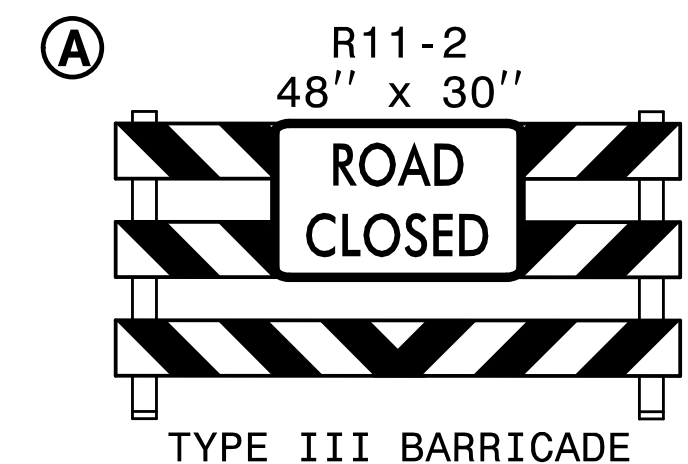
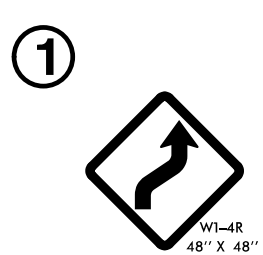

4:57:45 PM
 Y:\5021\TC_P2D30_GreenT_52.dgn
 \$\$\$USERNAME\$\$\$

MATCHLINE
 -YAREV- STA 15+50+/-
 SEE SHEET TMP-119

HNTB HNTB NORTH CAROLINA, P.C.
 343 E. Six Forks Road, Suite 200
 Raleigh, North Carolina 27609
 NC License No: C-1554

APPROVED: *Helen Shyu*
 DATE: 11/10/2021
 SEAL
 PROFESSIONAL ENGINEER
 HELEN SHYU
 042517

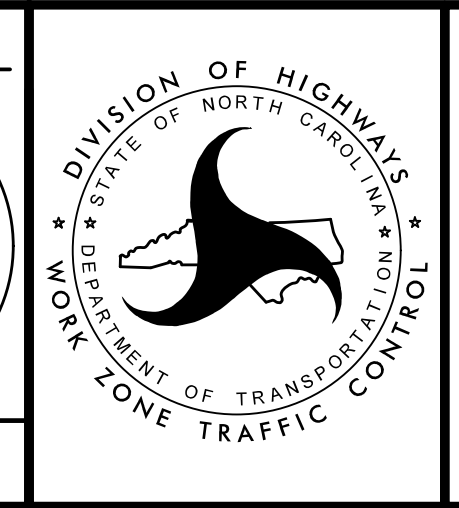

TRANSPORTATION
 MANAGEMENT PLAN
 PHASE II
 STEP 4.4 & 4.5
 DETAIL

DOCUMENT NOT CONSIDERED FINAL
 UNLESS ALL SIGNATURES COMPLETED

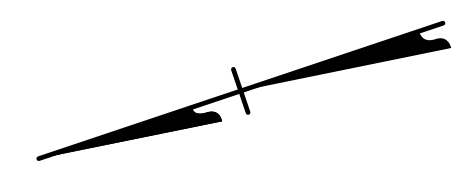
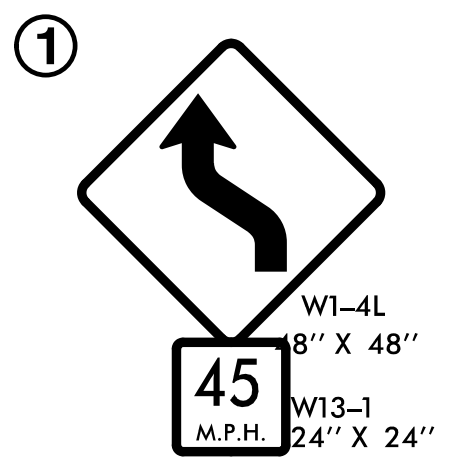
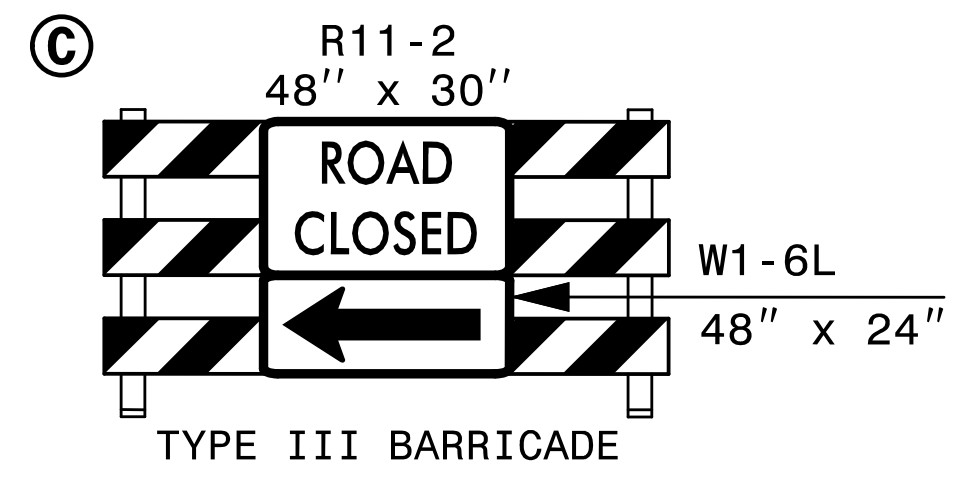

SEE RSD 1101.03 (SHEET 4 OF 9)
FOR ADDITIONAL TRAFFIC CONTROL
DEVICES

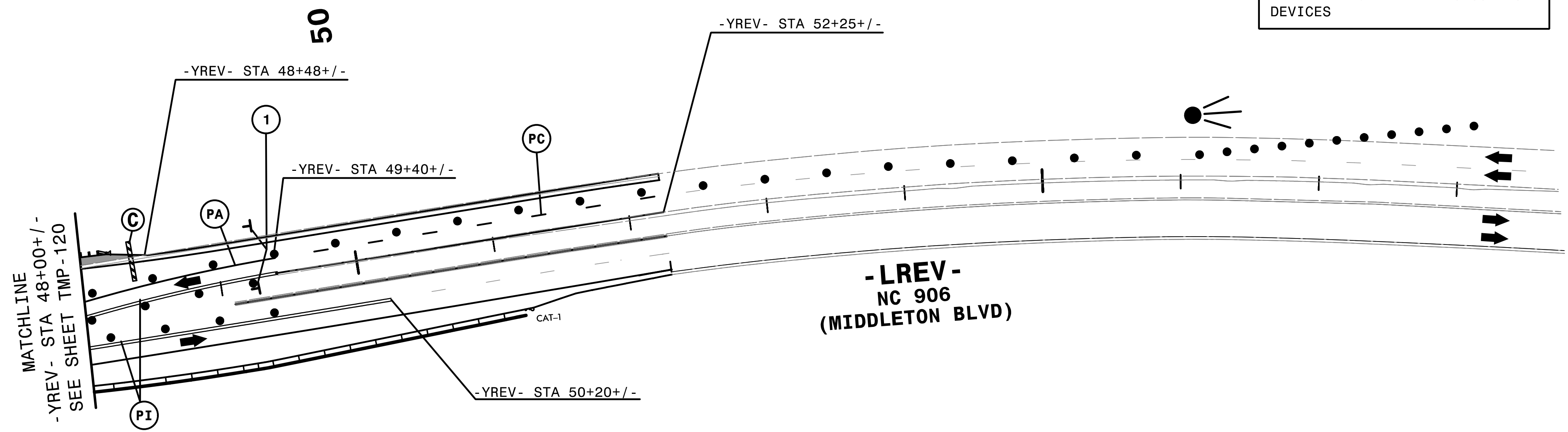

REMOVE CONFLICTING PAVEMENT MARKING.

4:57:48 PM
Y:\5021\TC_P2d3\Green T S2.dgn
\$\$\$\$\$USERNAME\$\$\$\$\$

HNTB HNTB NORTH CAROLINA, P.C.
343 E. Six Forks Road, Suite 200
Raleigh, North Carolina 27609
NC License No: C-1554

APPROVED: *Helen Shyu*
DATE: 11/10/2021
SEAL
DOCUMENT NOT CONSIDERED FINAL
UNLESS ALL SIGNATURES COMPLETED

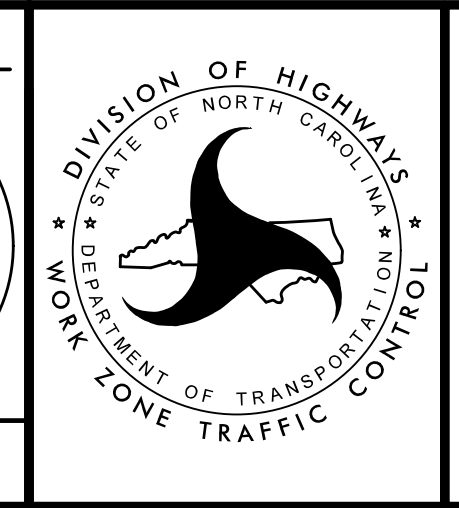

TRANSPORTATION
MANAGEMENT PLAN
PHASE II
STEP 4.4 & 4.5
DETAIL

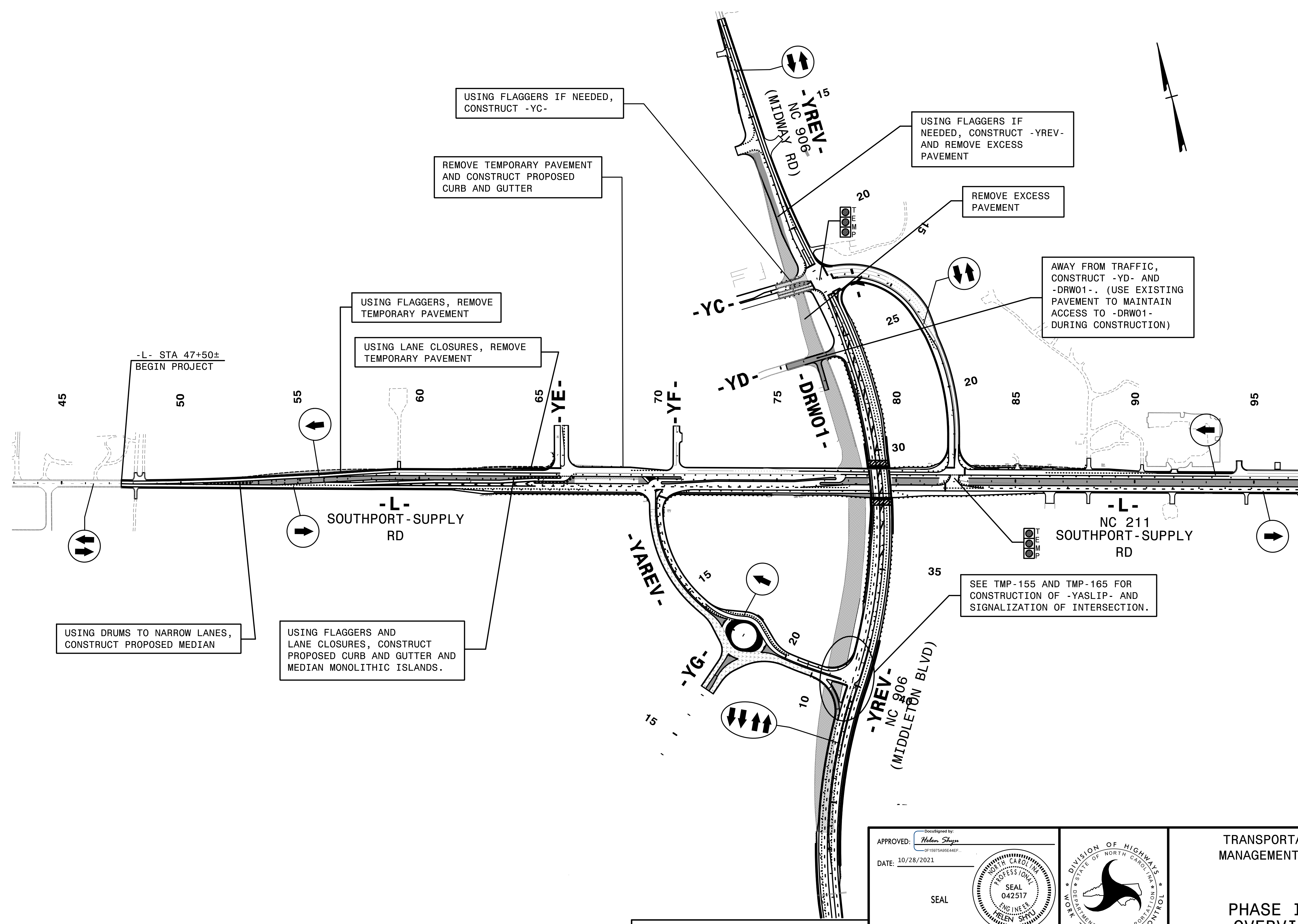

-L- STA 47+50±
BEGIN PROJECT

USING FLAGGERS, REMOVE
TEMPORARY PAVEMENT

USING LANE CLOSURES, REMOVE
TEMPORARY PAVEMENT

USING FLAGGERS IF NEEDED,
CONSTRUCT -YC-

REMOVE TEMPORARY PAVEMENT
AND CONSTRUCT PROPOSED
CURB AND GUTTER

USING FLAGGERS IF
NEEDED, CONSTRUCT -YREV-
AND REMOVE EXCESS
PAVEMENT

REMOVE EXCESS
PAVEMENT

AWAY FROM TRAFFIC,
CONSTRUCT -YD- AND
-DRW01-. (USE EXISTING
PAVEMENT TO MAINTAIN
ACCESS TO -DRW01-
DURING CONSTRUCTION)

USING DRUMS TO NARROW LANES,
CONSTRUCT PROPOSED MEDIAN

USING FLAGGERS AND
LANE CLOSURES, CONSTRUCT
PROPOSED CURB AND GUTTER AND
MEDIAN MONOLITHIC ISLANDS.

SEE TMP-155 AND TMP-165 FOR
CONSTRUCTION OF -YASLIP- AND
SIGNALIZATION OF INTERSECTION.

MATCHLINE
-L- STA 97+00+/-
SEE SHEET TMP-123

3:24:05 PM
TCDF5021.TC.P3 0V.s.dgn
\$\$\$\$\$USERNAME\$\$\$\$\$

HNTB
 HNTB NORTH CAROLINA, P.C.
 343 E. Six Forks Road, Suite 200
 Raleigh, North Carolina 27609
 NC License No: C-1554

APPROVED: *Helen Shyu*
 DATE: 10/28/2021
 SEAL
 DOCUMENT NOT CONSIDERED FINAL
 UNLESS ALL SIGNATURES COMPLETED

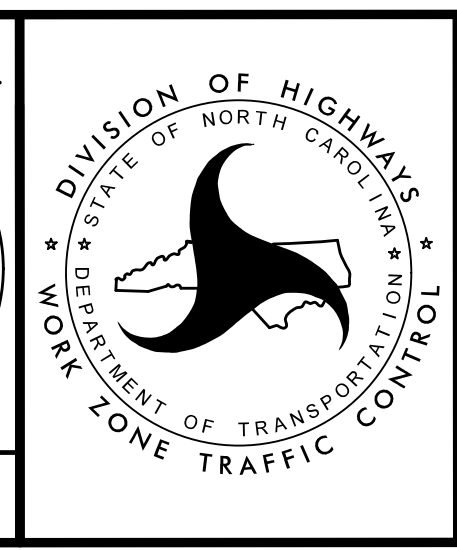

TRANSPORTATION
 MANAGEMENT PLAN

 PHASE III
 OVERVIEW

PROJ. REFERENCE NO.	SHEET NO.
R-5021	TMP-123

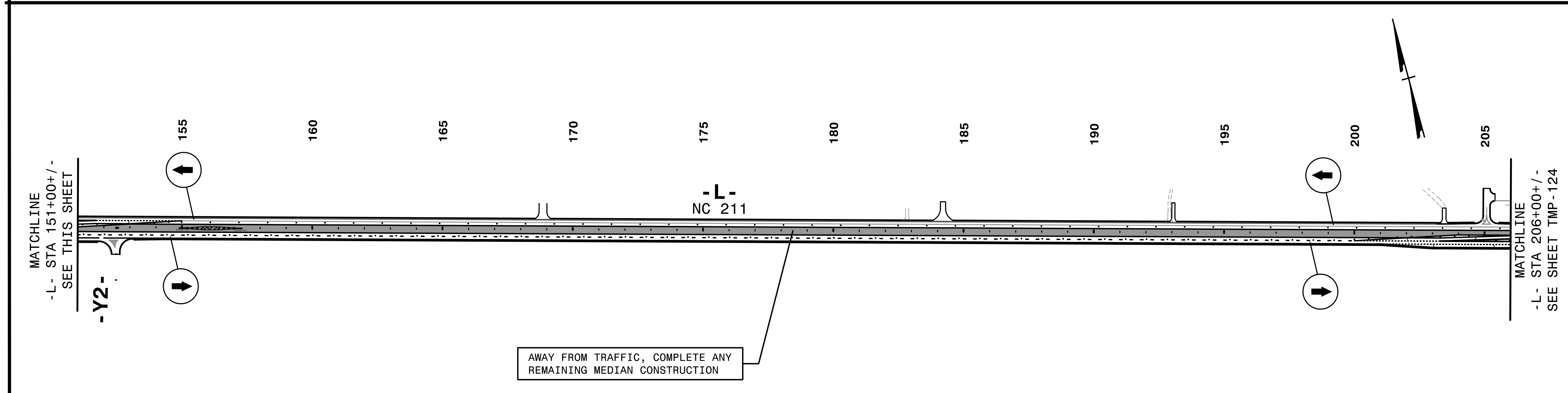
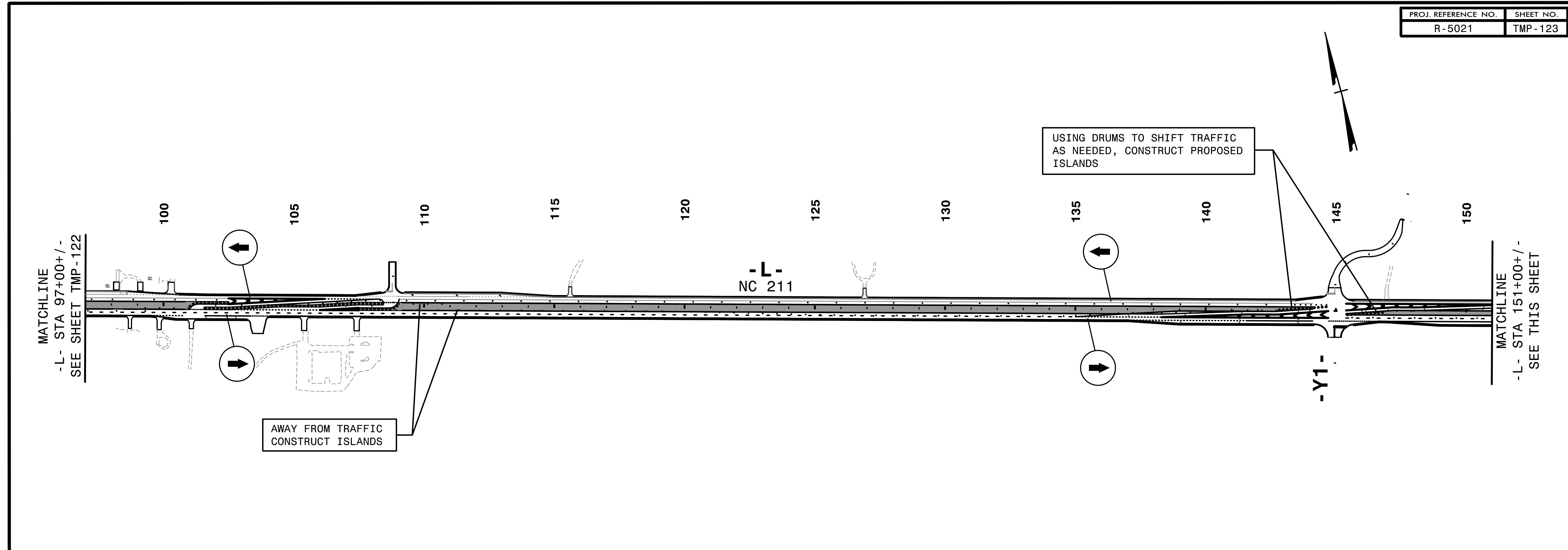

4:55:23 PM
 \\TCR\5021\TC_P3_0\vs.dgn
 \$\$\$USERNAME\$\$\$

HNTB HNTB NORTH CAROLINA, P.C.
 343 E. Six Forks Road, Suite 200
 Raleigh, North Carolina 27603
 NC License No: C-1554

APPROVED: *Helen Shyu*
 DATE: 9/9/2021

SEAL

Professional Engineer Seal: HELLEN SHYU, ENGINEER, SEAL 042517, NORTH CAROLINA PROFESSIONAL ENGINEERS

DOCUMENT NOT CONSIDERED FINAL
 UNLESS ALL SIGNATURES COMPLETED

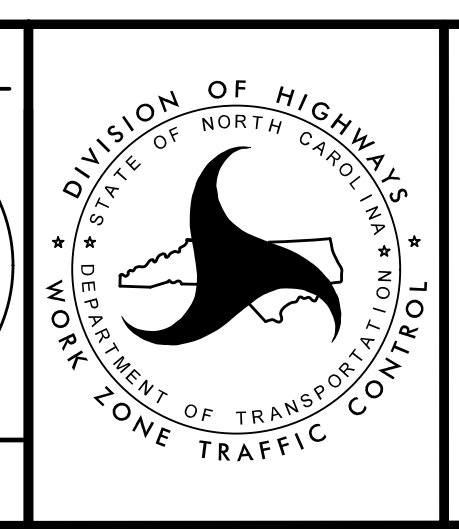

TRANSPORTATION
 MANAGEMENT PLAN

PHASE III
 OVERVIEW

PROJ. REFERENCE NO.	SHEET NO.
R-5021	TMP-124

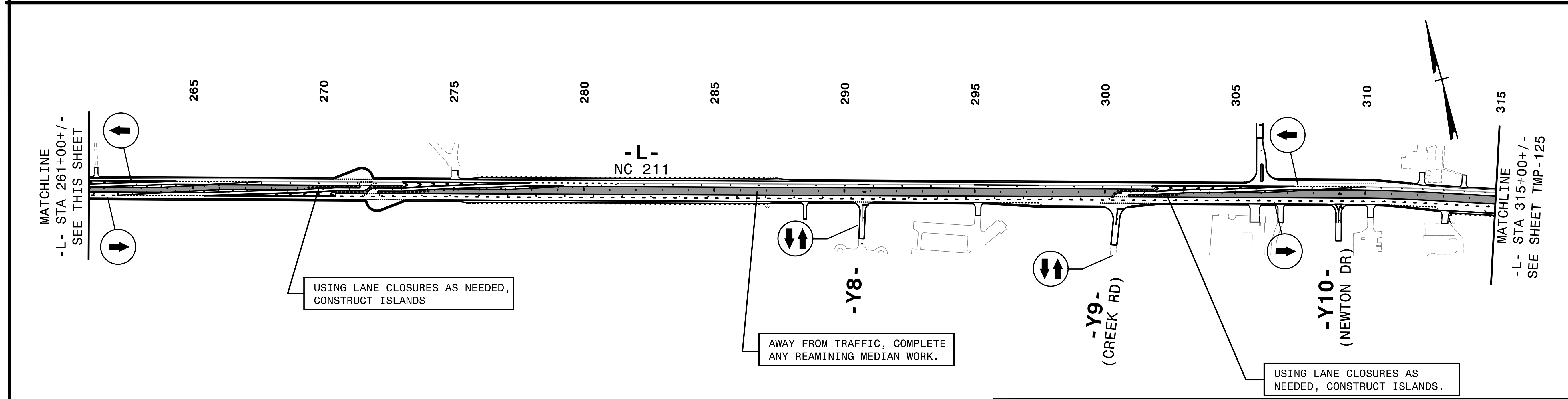
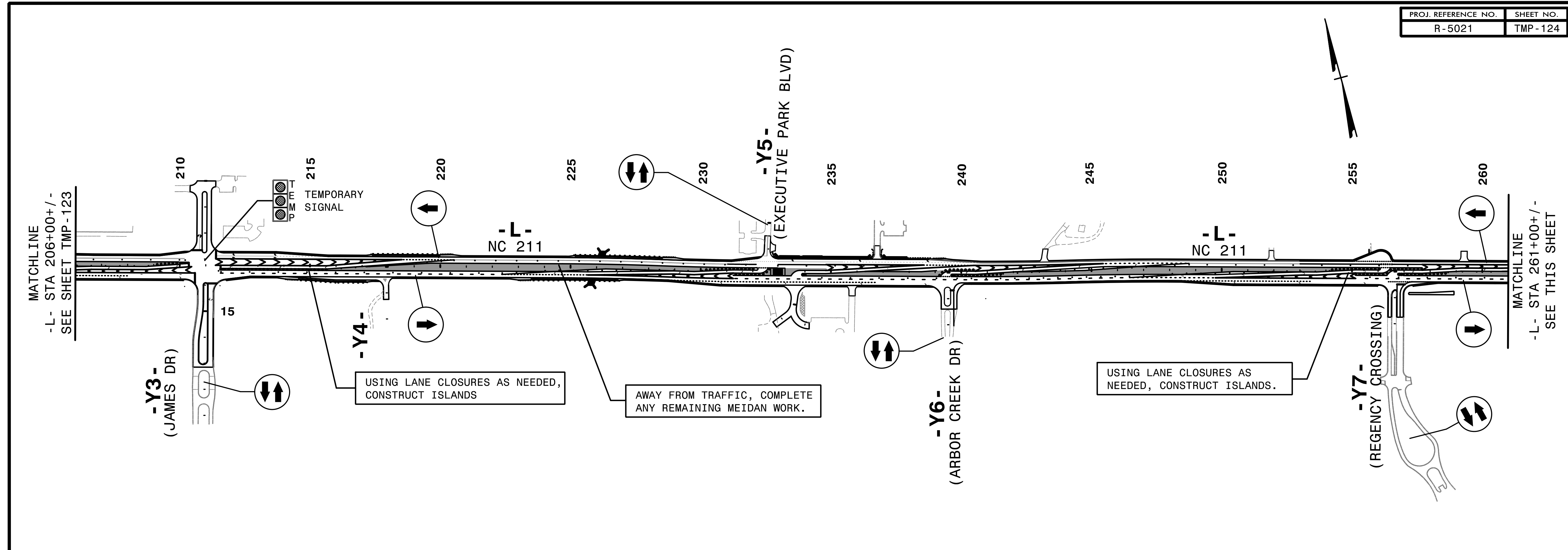

11:50:15 AM
\\TCF\5021\TC_P3_0\vs.dgn
\$\$\$\$\$USERNAME\$\$\$\$\$

HNTB
HNTB NORTH CAROLINA, P.C.
343 E. Six Forks Road, Suite 200
Raleigh, North Carolina 27609
NC License No: C-1554

APPROVED: *Helen Shyne*
DATE: 9/9/2021
SEAL
DOCUMENT NOT CONSIDERED FINAL
UNLESS ALL SIGNATURES COMPLETED

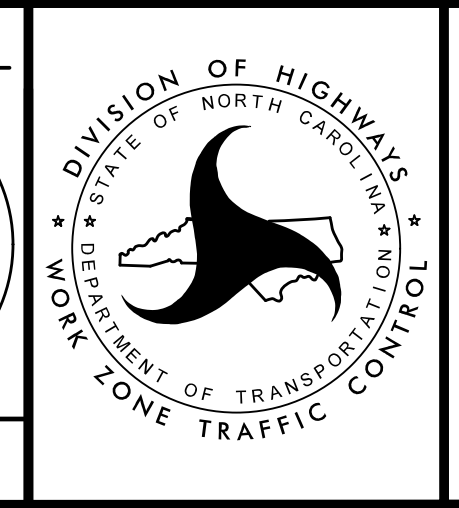

DIVISION OF HIGHWAYS
STATE OF NORTH CAROLINA
DEPARTMENT OF TRANSPORTATION
WORK ZONE TRAFFIC CONTROL

TRANSPORTATION
MANAGEMENT PLAN

PHASE III
OVERVIEW

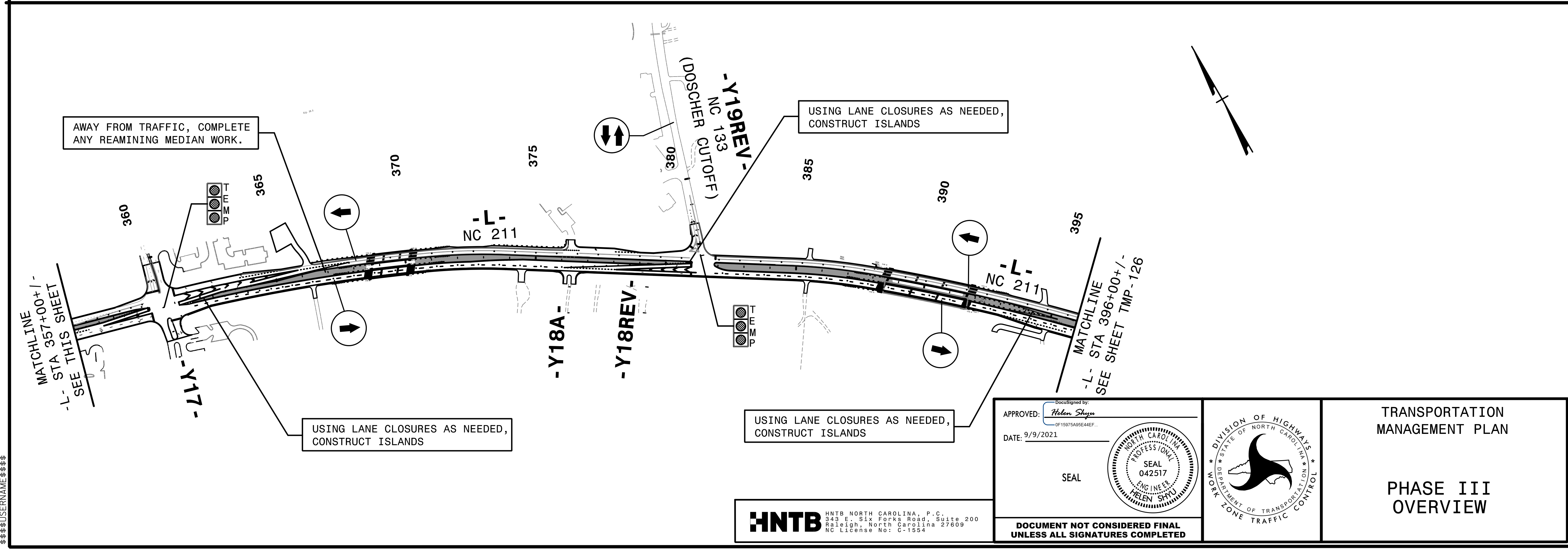
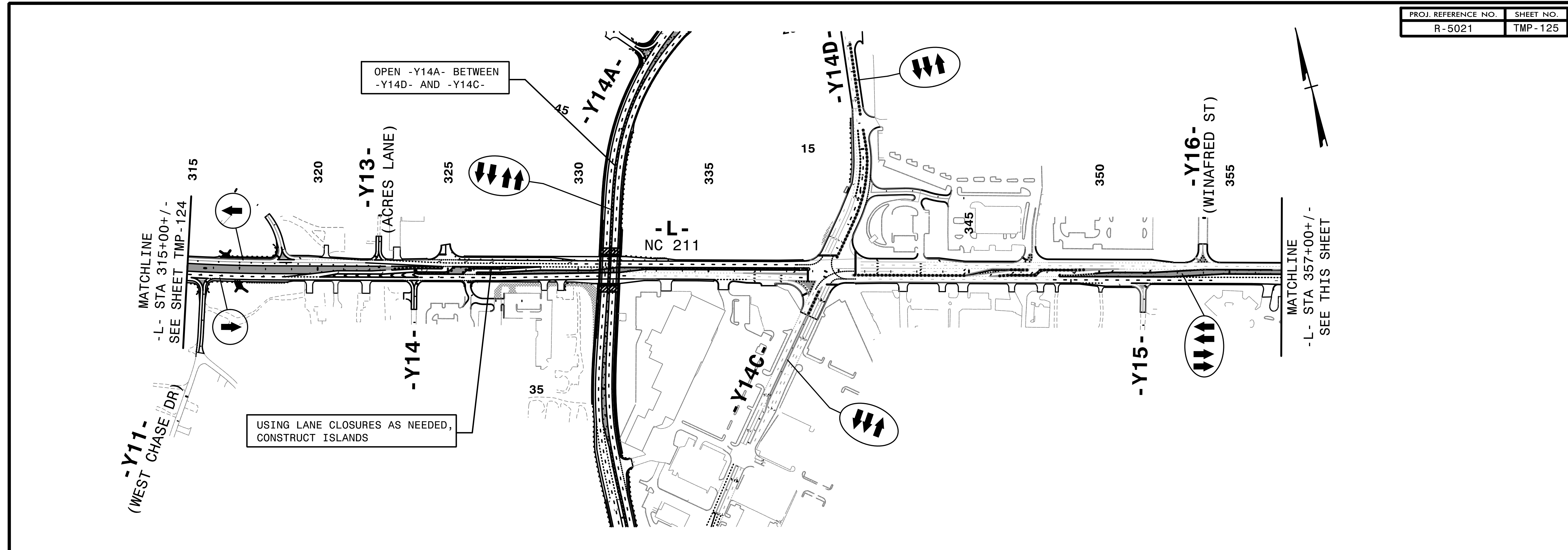

I:\5018_AM\15021\10_P3_0\vs.dgn
\$\$\$\$\$USERNAME\$\$\$\$\$

AWAY FROM TRAFFIC, COMPLETE ANY REAMINING MEDIAN WORK.

USING LANE CLOSURES AS NEEDED, CONSTRUCT ISLANDS

USING LANE CLOSURES AS NEEDED, CONSTRUCT ISLANDS

USING LANE CLOSURES AS NEEDED, CONSTRUCT ISLANDS

OPEN -Y14A- BETWEEN -Y14D- AND -Y14C-

USING LANE CLOSURES AS NEEDED, CONSTRUCT ISLANDS

APPROVED: *Helen Shyu*
DATE: 9/9/2021

SEAL

DOCUMENT NOT CONSIDERED FINAL UNLESS ALL SIGNATURES COMPLETED

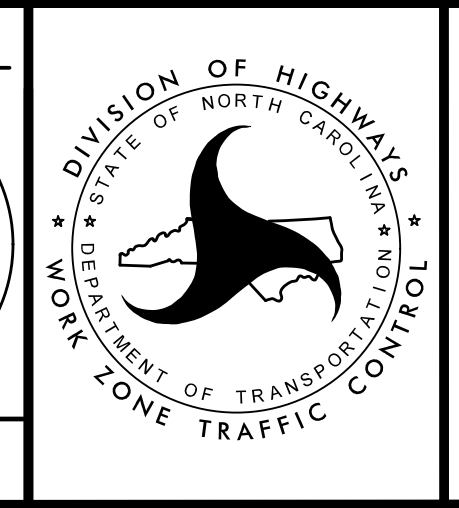

TRANSPORTATION MANAGEMENT PLAN

PHASE III OVERVIEW

HNTB HNTB NORTH CAROLINA, P.C.
343 E. Six Forks Road, Suite 200
Raleigh, North Carolina 27609
NC License No: C-1554

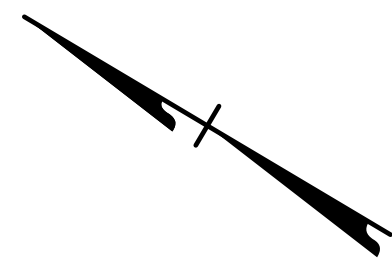
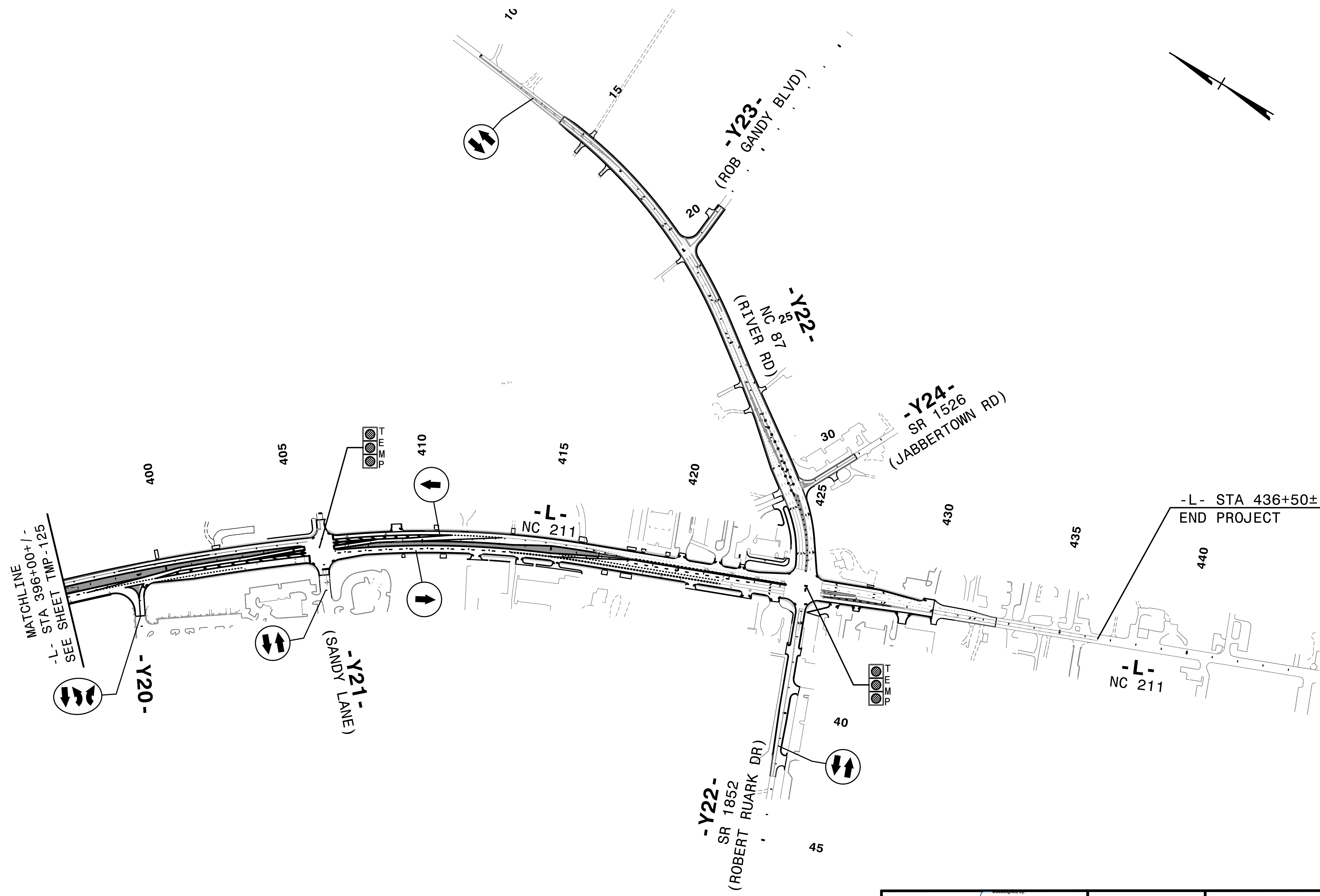

2/6/2019
ATCP-V-502L-1c-P3 0Vs.dgn
HNTB

HNTB
HNTB NORTH CAROLINA, P.C.
343 E. Six Forks Road, Suite 200
Raleigh, North Carolina 27609
NC License No: C-1554

APPROVED: *Helen Shyu*
DATE: 2/6/2019
SEAL
DOCUMENT NOT CONSIDERED FINAL
UNLESS ALL SIGNATURES COMPLETED

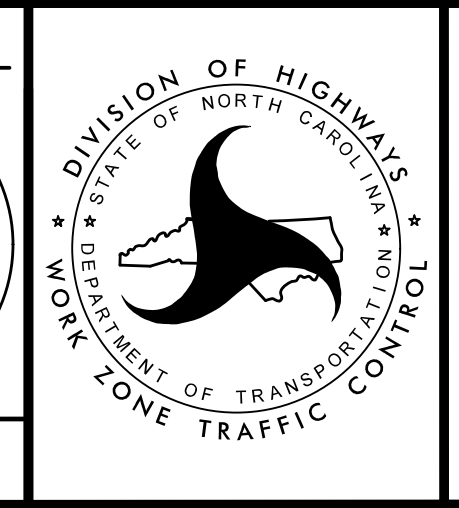
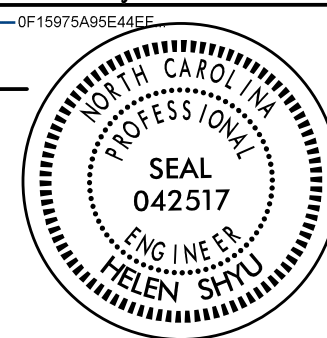

TRANSPORTATION
MANAGEMENT PLAN

PHASE III
OVERVIEW

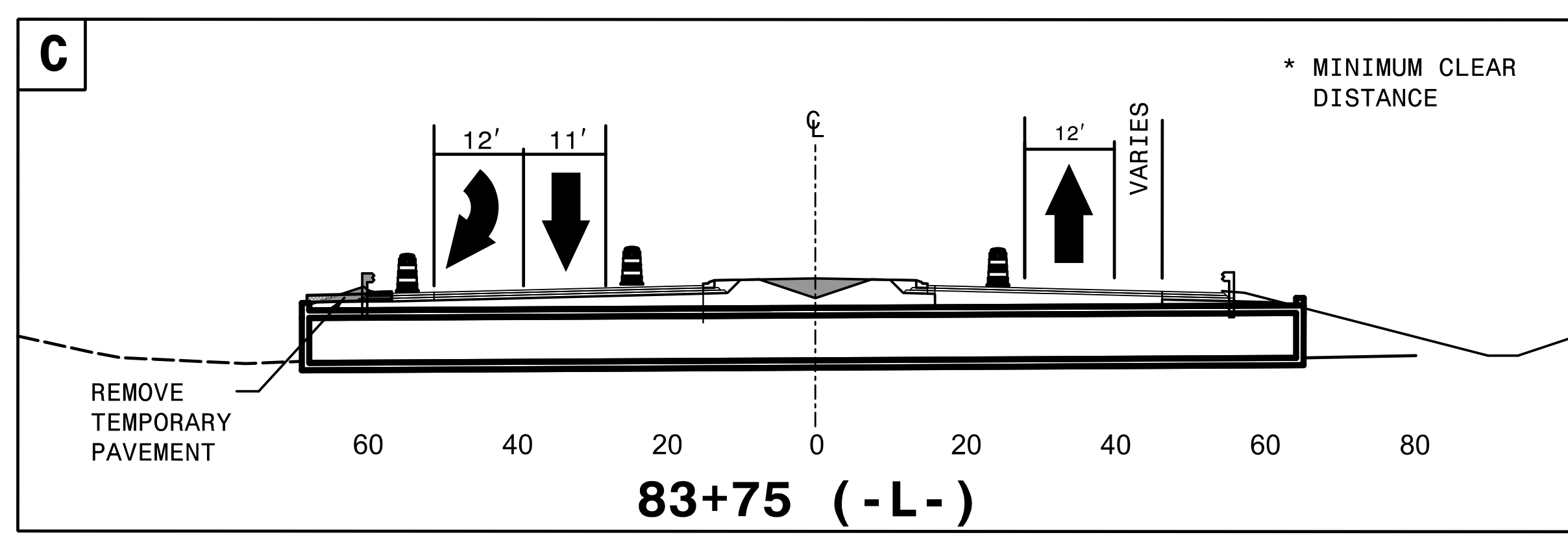
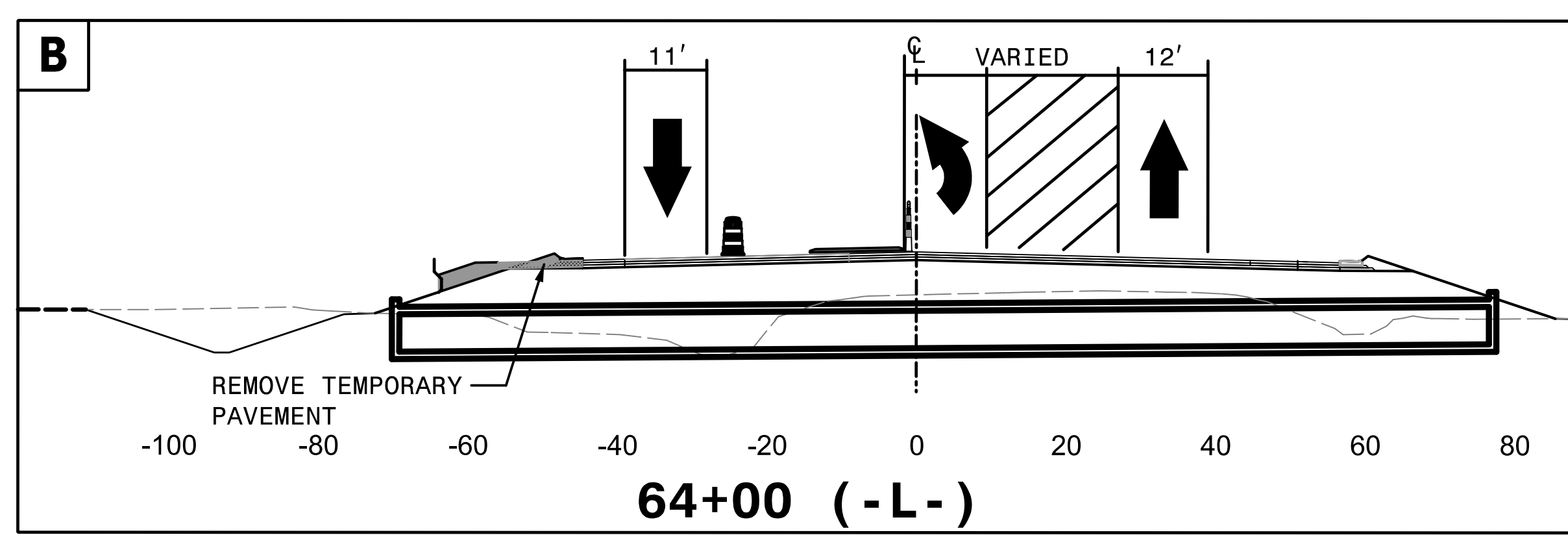
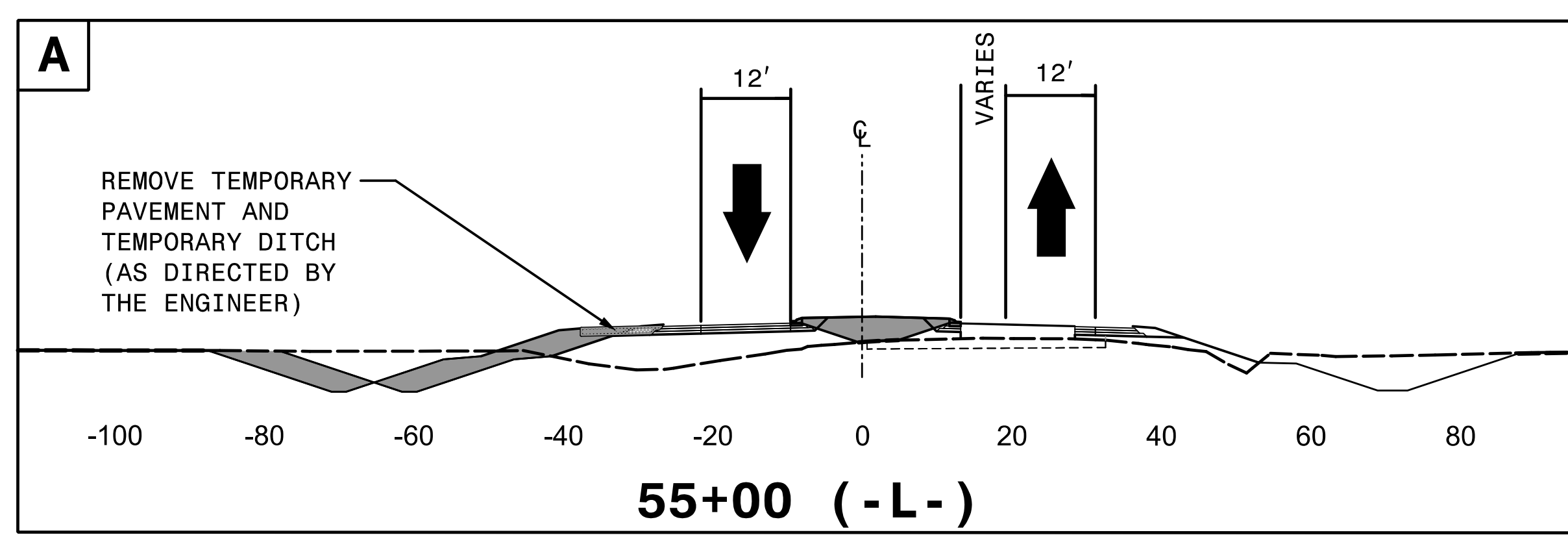

3:24:11 PM
\\TC\PROJECTS\5021\Tc_P3\cuts.dgn
\$\$\$\$\$USERNAME\$\$\$\$\$



APPROVED: *Helen Shyu*
DocuSigned by:
Helen Shyu
0F15075A0E44EF
 DATE: 10/28/2021

SEAL

**DOCUMENT NOT CONSIDERED FINAL
UNLESS ALL SIGNATURES COMPLETED**

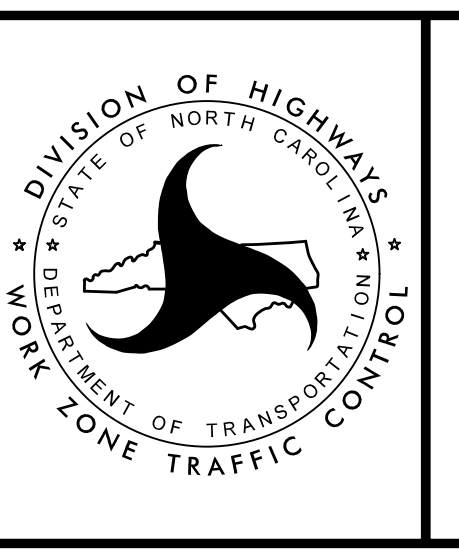

TRANSPORTATION
MANAGEMENT PLAN

PHASE III
CUT SECTIONS

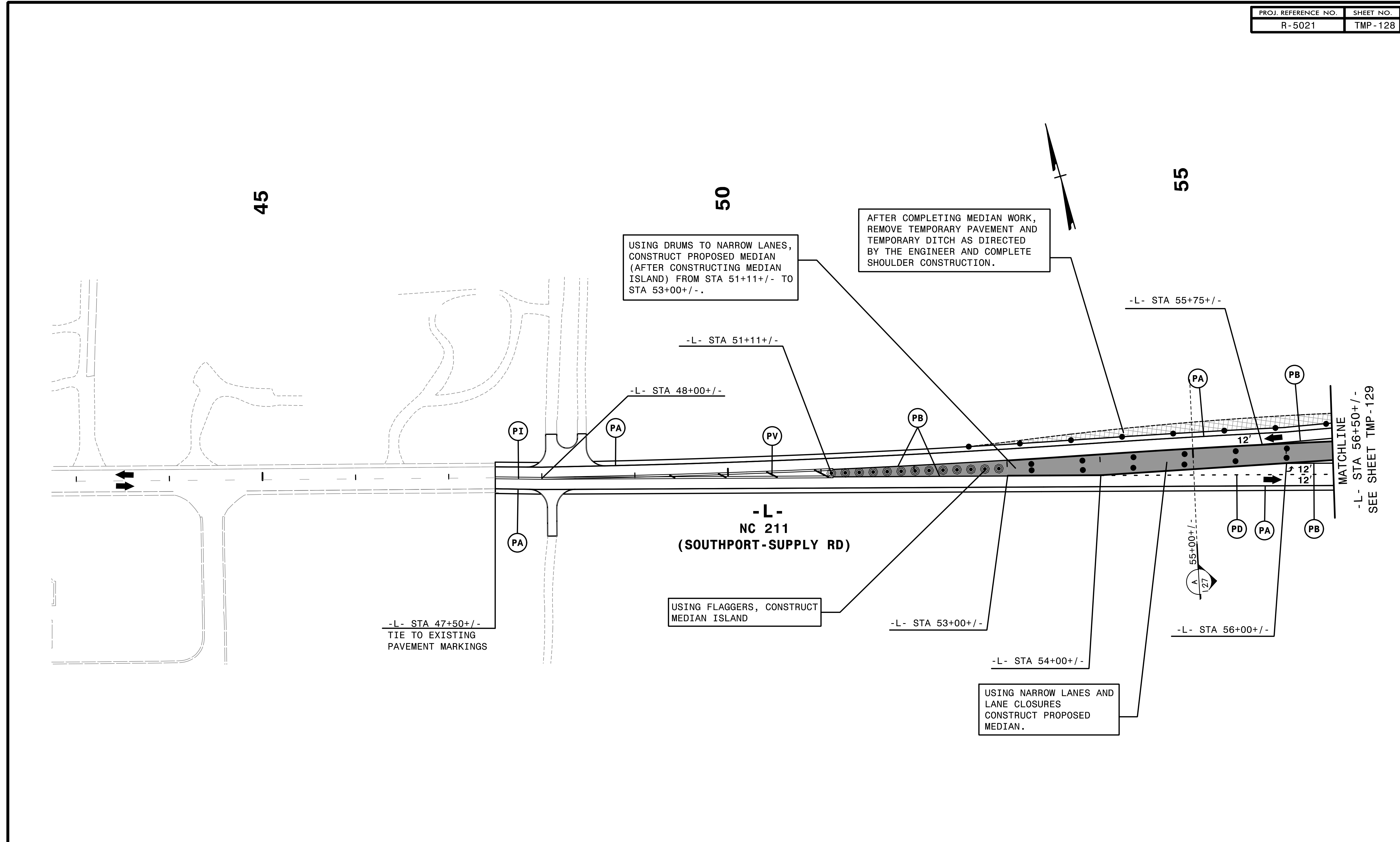

2/6/2019
TCR-V-5021-10-p3.dwg
HNTB

REMOVE CONFLICTING PAVEMENT MARKING.
INSTALLL APPLICABLE PERMANENT SIGNS.

HNTB HNTB NORTH CAROLINA, P.C.
343 E. Six Forks Road, Suite 200
Raleigh, North Carolina 27609
NC License No: C-1554

APPROVED: *Helen Shyu*
DATE: 2/6/2019
SEAL

PROFESSIONAL SEAL
042517
ENGINEER
HELEN SHYU

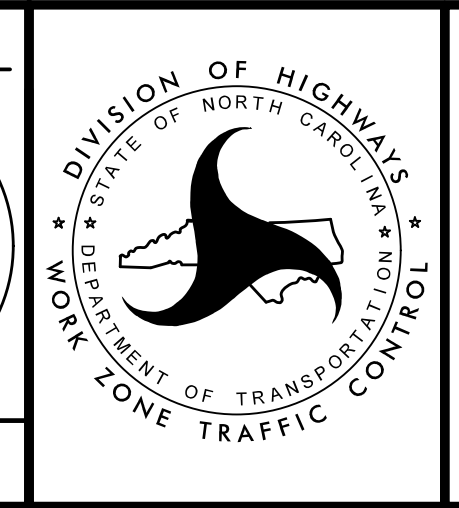

TRANSPORTATION MANAGEMENT PLAN

PHASE III DETAIL

DOCUMENT NOT CONSIDERED FINAL UNLESS ALL SIGNATURES COMPLETED

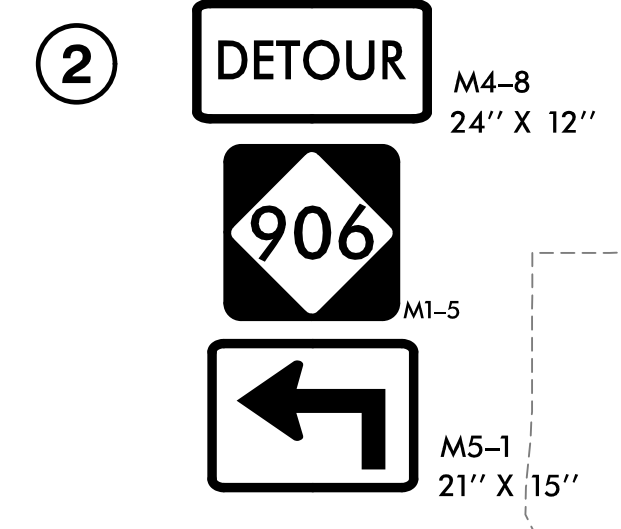
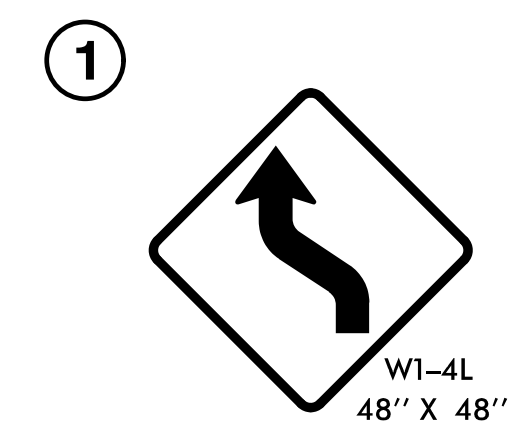

USING DRUMS AND LANE CLOSURES
CONSTRUCT PROPOSED CURB AND GUTTER
AND MEDIAN MONOLITHIC ISLANDS.

REMOVE TEMPORARY
PAVEMENT

REMOVE PCB, TEMP PAVEMENT
& SHORING. CONSTRUCT PROPOSED
SHOULDER & GUARDRAIL.

INSTALL PROPOSED
SIGN #403 AND 404.

REMOVE TEMPORARY PAVEMENT
CONSTRUCT PROPOSED CURB
AND GUTTER

MATCHLINE
-L- STA 56+50+/-
SEE SHEET TMP-128

MATCHLINE
-L- STA 69+50+/-
SEE SHEET TMP-130

-L-
NC 211
(SOUTHPORT-SUPPLY RD)

-L- STA 59+01+/-

-L- STA 58+47+/-

-L- STA 62+00+/-

-YE- STA 12+63+/-
-L- STA 65+17+/-

-L- STA 66+35

-L- STA 66+51

-L- STA 68+85+/-

-L- STA 57+30+/-

-L- STA 60+61+/-

-L- STA 61+56+/-

-L- STA 63+86+/-

-L- STA 64+86+/-

-L- STA 66+00+/-

-L- STA 67+98+/-

-L- STA 69+19+/-

PU CHEVRONS AT 55' SPACING

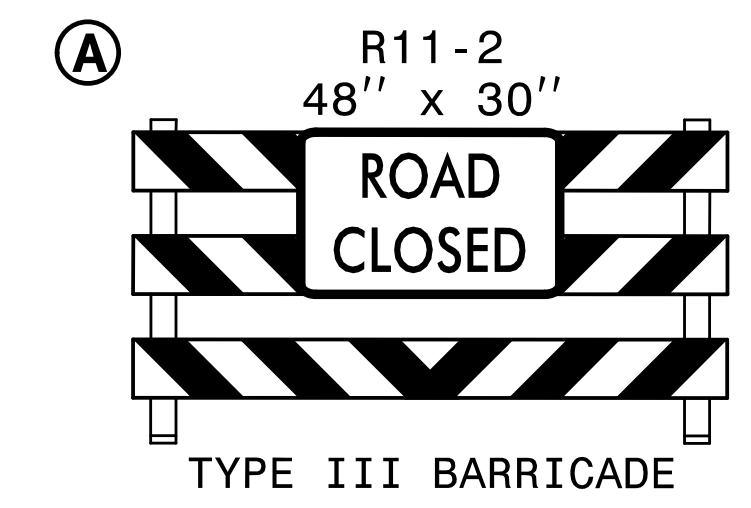

REMOVE CONFLICTING PAVEMENT MARKING.
INSTALL APPLICABLE PERMANENT SIGNS.

APPROVED: *Helen Shyu*
DATE: 10/28/2021
SEAL
DOCUMENT NOT CONSIDERED FINAL
UNLESS ALL SIGNATURES COMPLETED

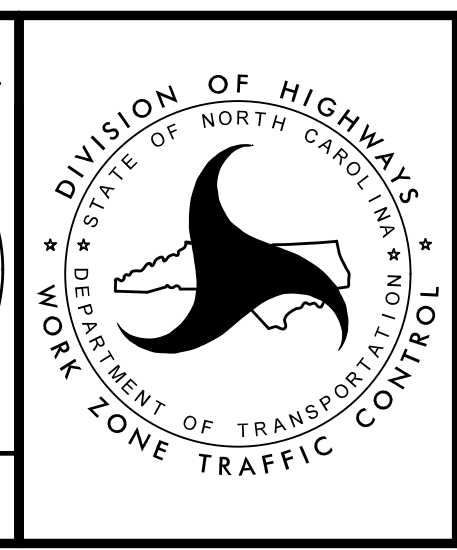

TRANSPORTATION
MANAGEMENT PLAN
PHASE III
DETAIL



3:24:14 PM
\\TC\p\5021\fc_dp3d2.dgn
\$\$\$\$\$USERNAME\$\$\$\$\$

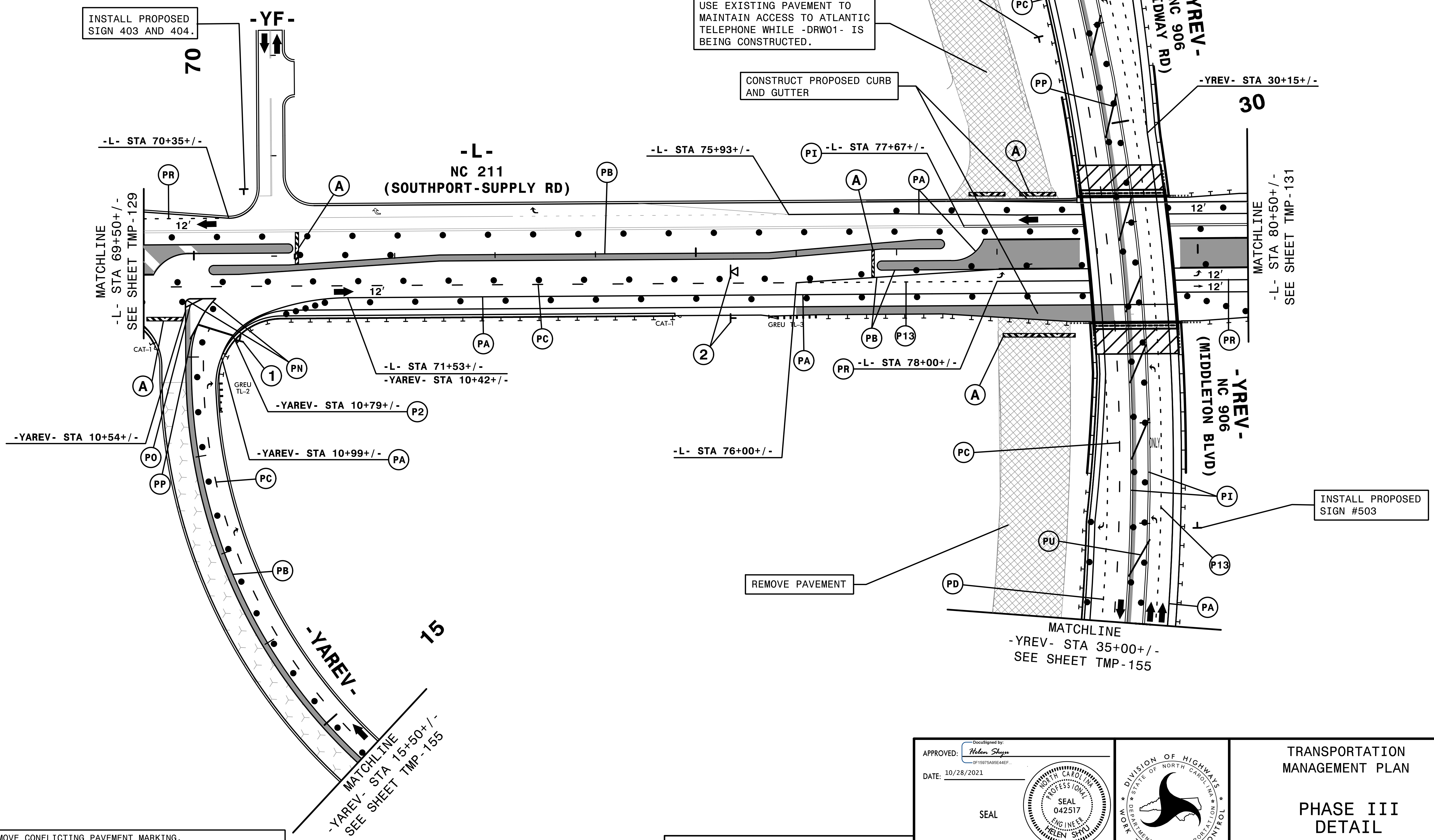
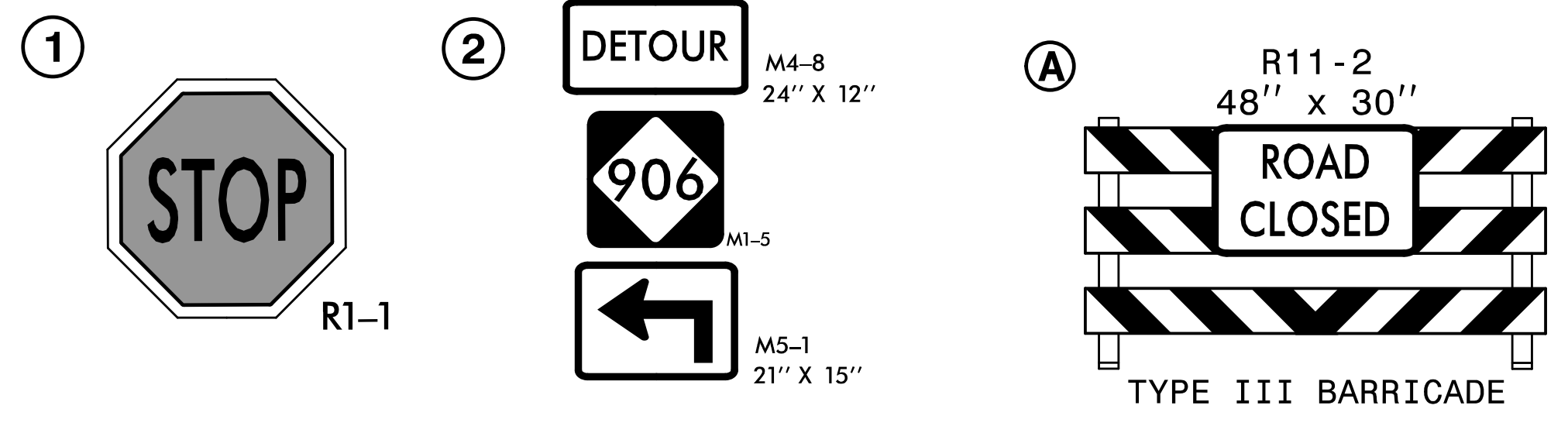

REMOVE CONFLICTING PAVEMENT MARKING.
INSTALL APPLICABLE PERMANENT SIGNS.

HNTB HNTB NORTH CAROLINA, P.C.
343 E. Six Forks Road, Suite 200
Raleigh, North Carolina 27609
NC License No: C-1554

APPROVED: *Helen Shyu*
DATE: 10/28/2021
SEAL
DOCUMENT NOT CONSIDERED FINAL
UNLESS ALL SIGNATURES COMPLETED

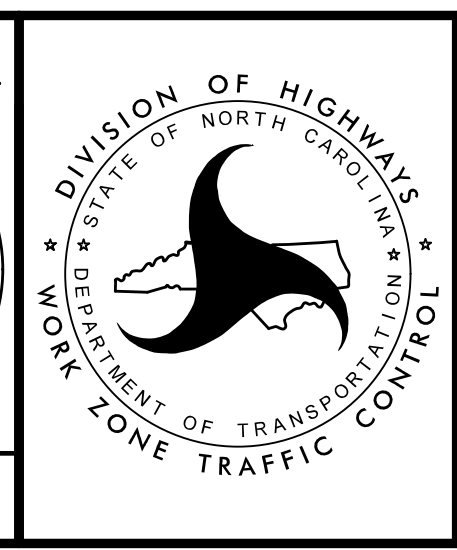

TRANSPORTATION
MANAGEMENT PLAN

PHASE III
DETAIL

10/4/21 4:46 AM
\\TCPCV5021\c_d3d3.dgn
\$\$\$\$\$USERNAME\$\$\$\$\$

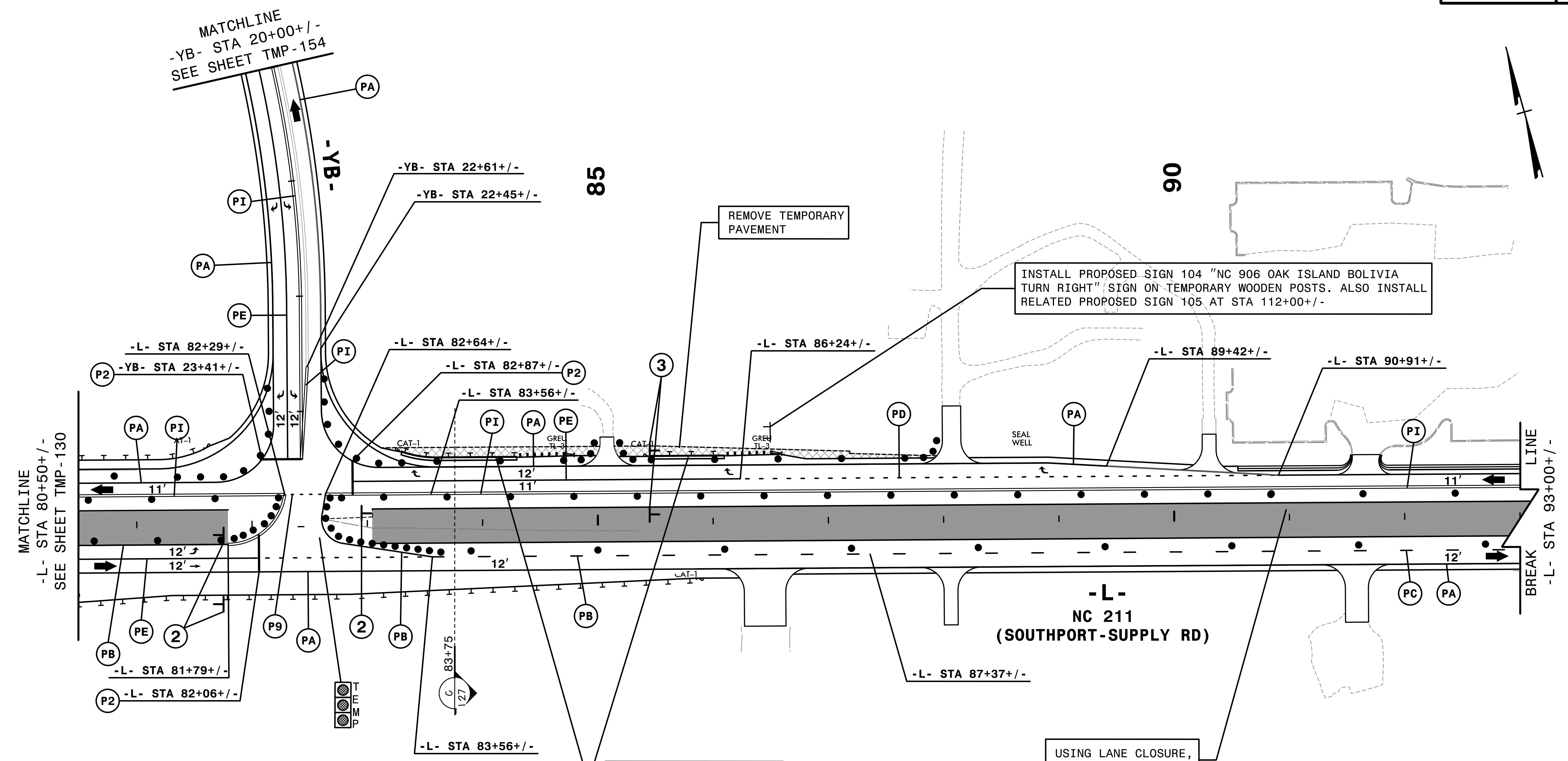

MATCHLINE
-L- STA 80+50+/-
SEE SHEET TMP-130

MATCHLINE
-YB- STA 20+00+/-
SEE SHEET TMP-154

INSTALL PROPOSED SIGN 104 "NC 906 OAK ISLAND BOLIVIA TURN RIGHT" SIGN ON TEMPORARY WOODEN POSTS. ALSO INSTALL RELATED PROPOSED SIGN 105 AT STA 112+00+/-

CONSTRUCT PROPOSED SHOULDER AND GUARDRAIL

USING LANE CLOSURE, CONSTRUCT PROPOSED MEDIAN

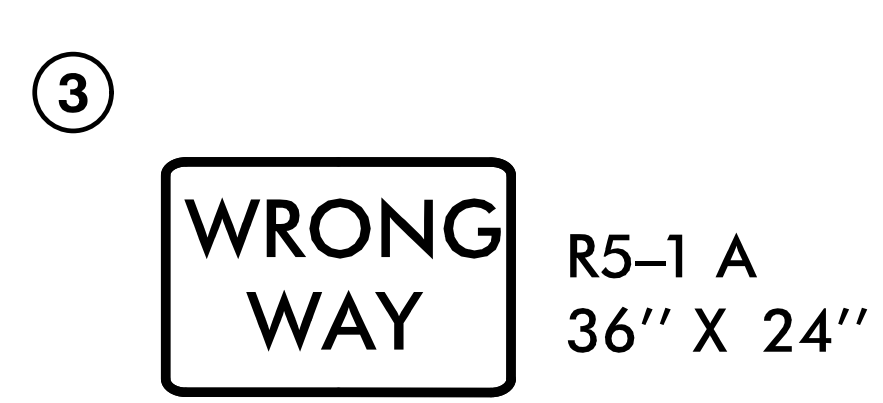
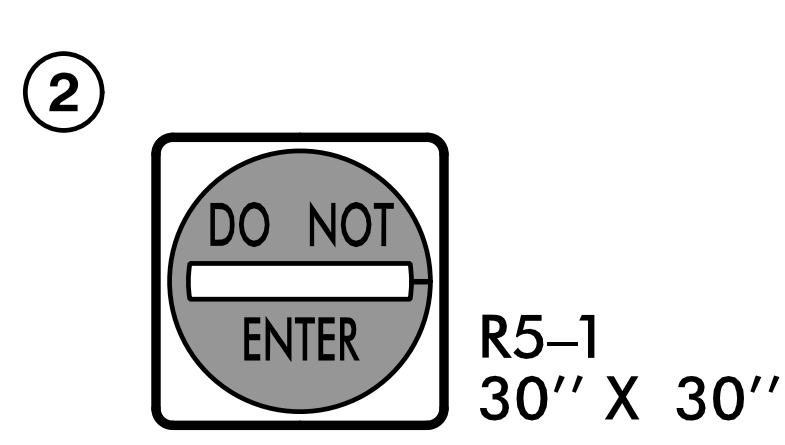

REMOVE CONFLICTING PAVEMENT MARKING.

INSTALL APPLICABLE PERMANENT SIGNS.

3:24:09 PM
\\TC\p\5021\fc_dp3d4.dgn
\$\$\$\$\$USERNAME\$\$\$\$\$



APPROVED: *Helen Shyu*
DATE: 10/28/2021

SEAL

DOCUMENT NOT CONSIDERED FINAL UNLESS ALL SIGNATURES COMPLETED

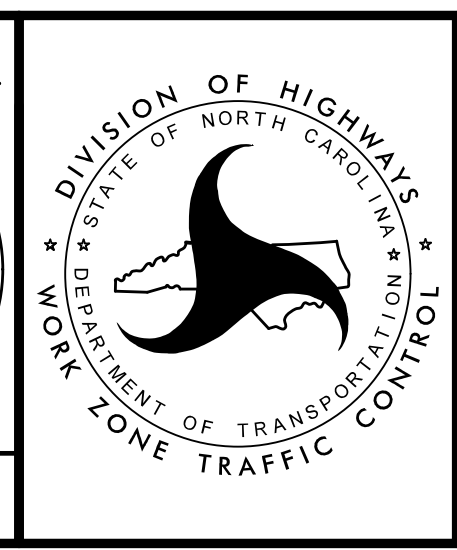

TRANSPORTATION MANAGEMENT PLAN

PHASE III DETAIL

PROJ. REFERENCE NO.	SHEET NO.
R-5021	TMP-132

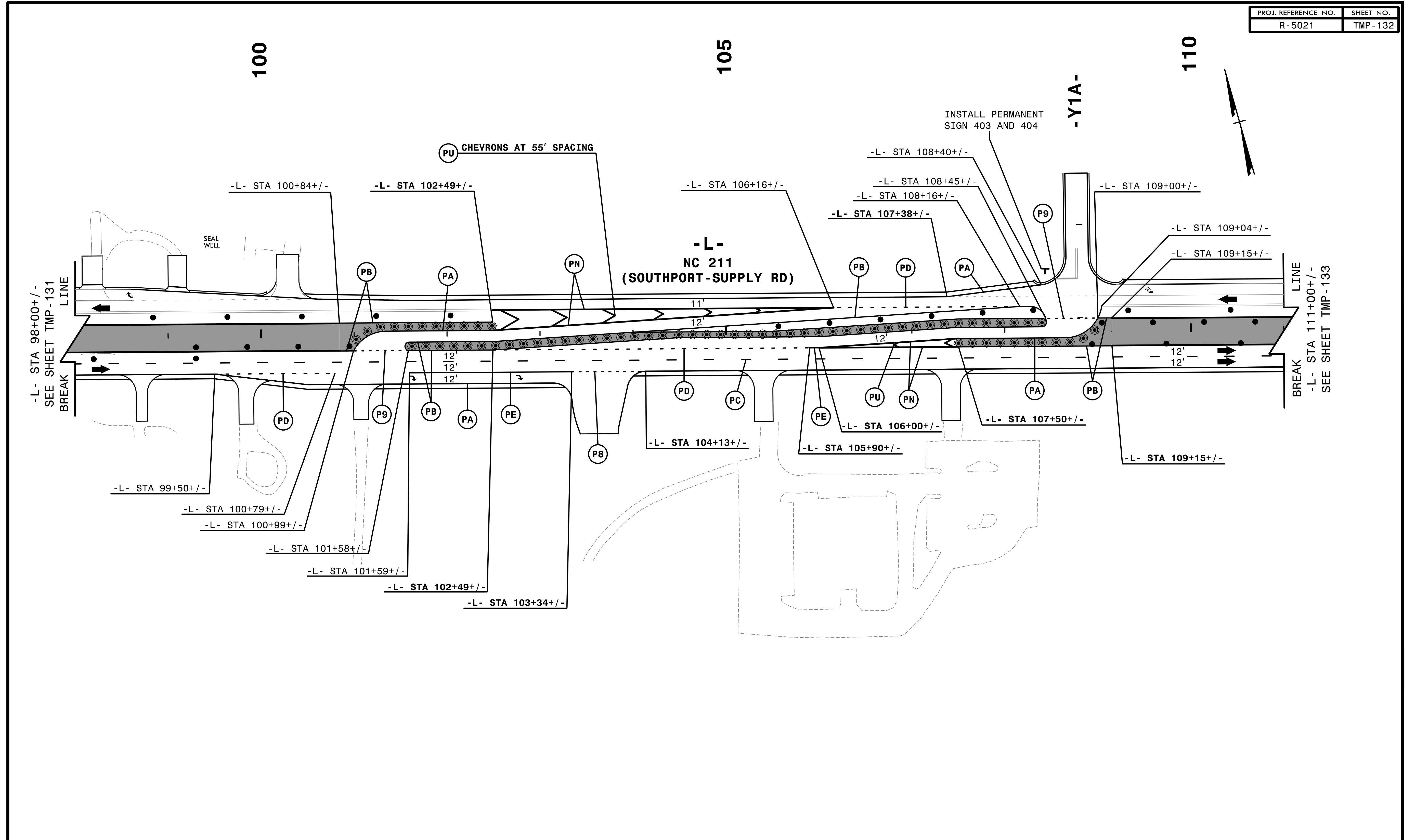

4:55:32 PM
 \\TCFV\F5021\TC_P3\cd5.dgn
 \$\$\$USERNAME\$\$\$

- REMOVE CONFLICTING PAVEMENT MARKING.
- INSTALL APPLICABLE PERMANENT SIGNS.

HNTB HNTB NORTH CAROLINA, P.C.
 343 E. Six Forks Road, Suite 200
 Raleigh, North Carolina 27609
 NC License No: C-1554

APPROVED: *Helen Shyu*
 DATE: 9/9/2021
 SEAL
 PROFESSIONAL SEAL
 042517
 ENGINEER
 HELEN SHYU

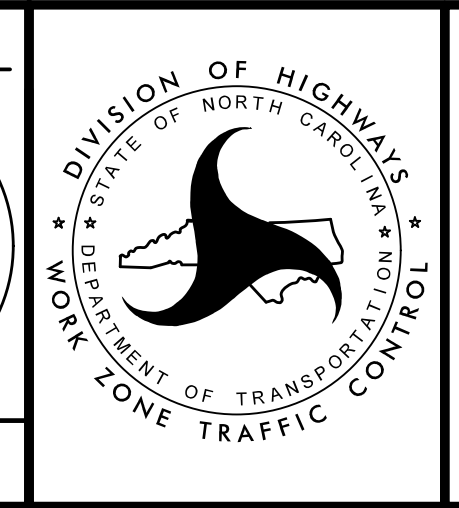

TRANSPORTATION
 MANAGEMENT PLAN
 PHASE III
 DETAIL

DOCUMENT NOT CONSIDERED FINAL
 UNLESS ALL SIGNATURES COMPLETED

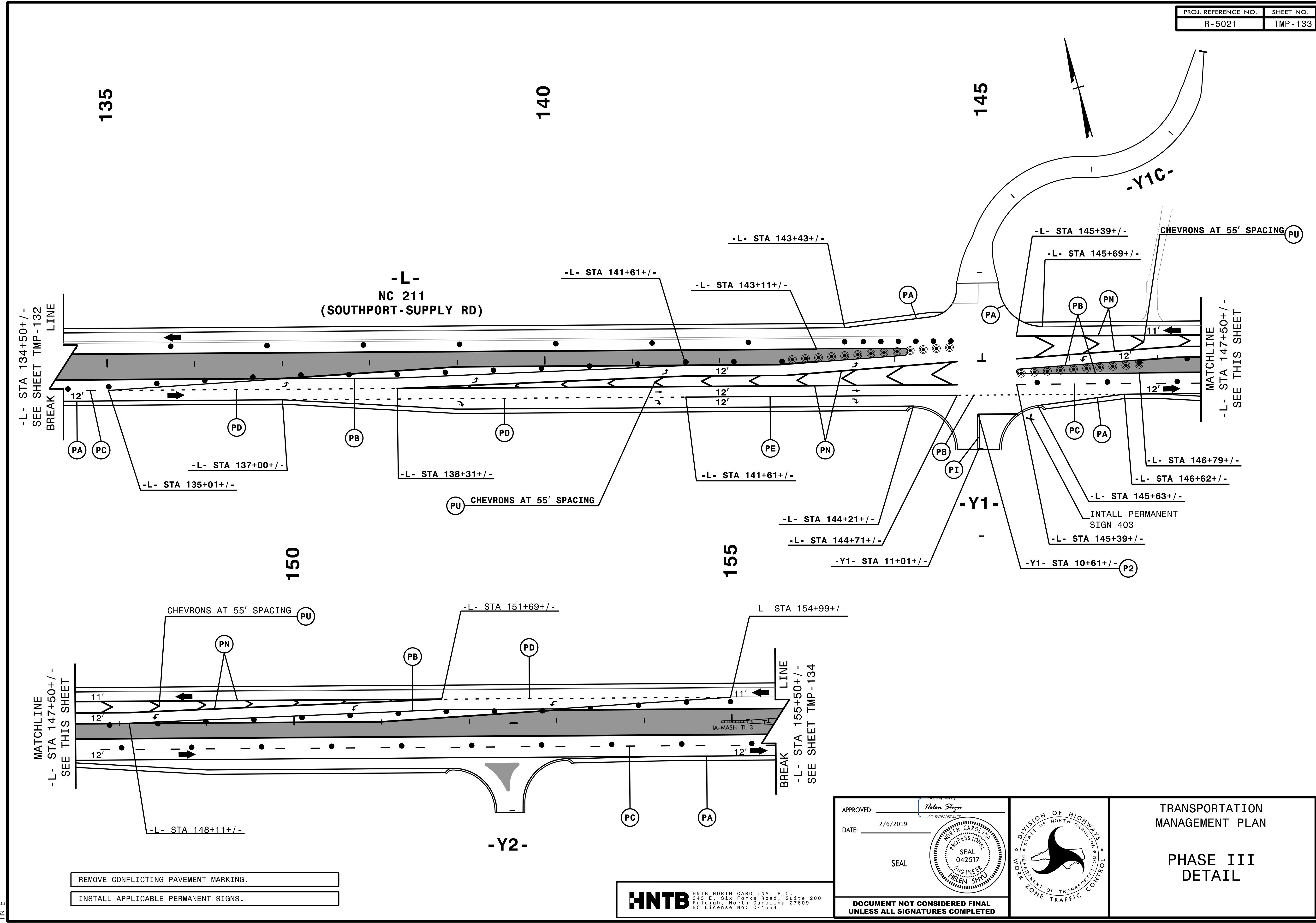

2/6/2019
 HNTB
 HNTB
 T:\CPV\5021\to_p3d6.dgn

- REMOVE CONFLICTING PAVEMENT MARKING.
- INSTALL APPLICABLE PERMANENT SIGNS.

HNTB HNTB NORTH CAROLINA, P.C.
 343 E. Six Forks Road, Suite 200
 Raleigh, North Carolina 27609
 NC License No: C-1554

APPROVED: *Helen Shyu*
 DATE: 2/6/2019
 SEAL
 PROFESSIONAL ENGINEER
 HELEN SHYU
 042517

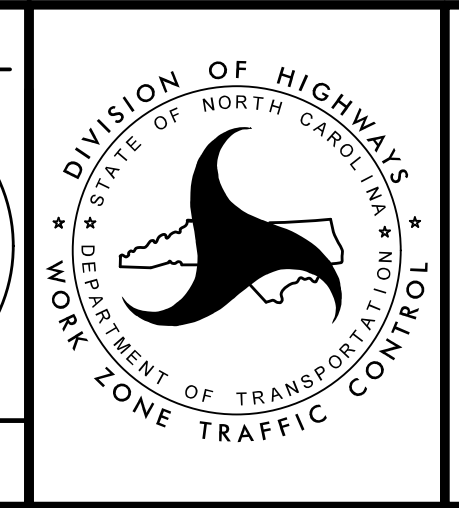

TRANSPORTATION
 MANAGEMENT PLAN
 PHASE III
 DETAIL

DOCUMENT NOT CONSIDERED FINAL
 UNLESS ALL SIGNATURES COMPLETED

PROJ. REFERENCE NO.	SHEET NO.
R-5021	TMP-134

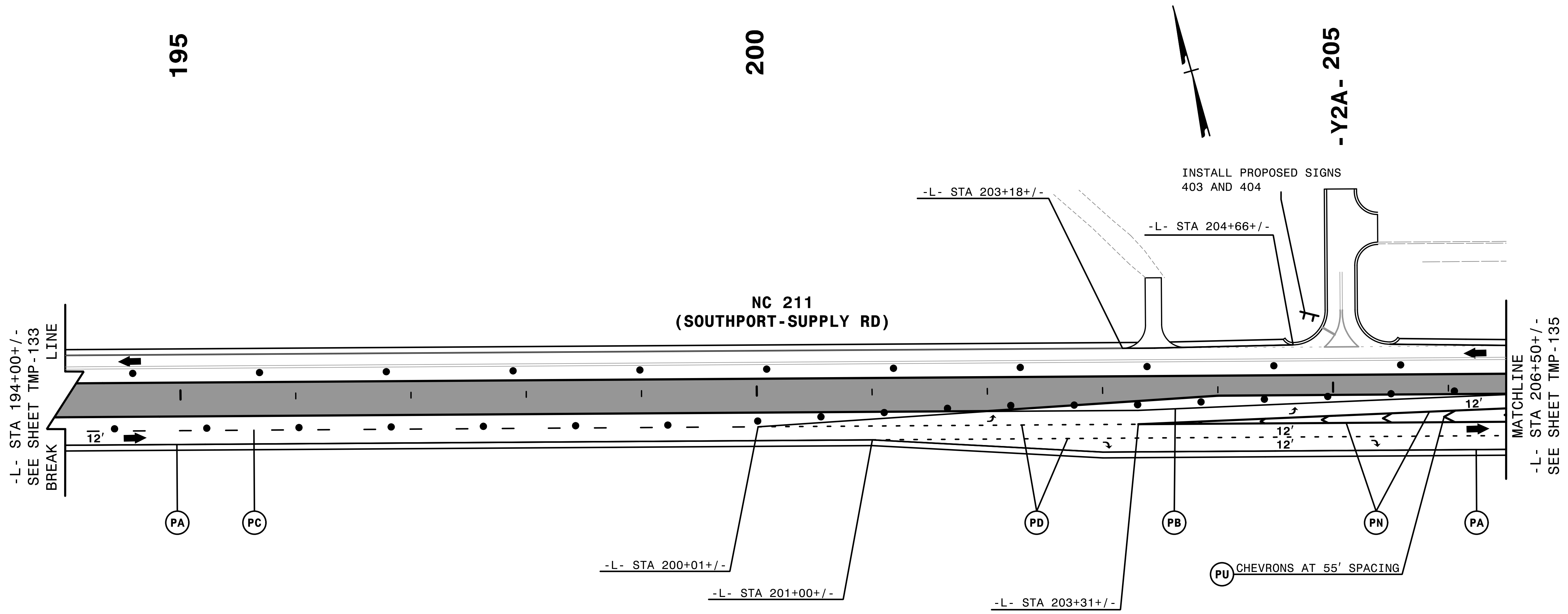

2/6/2019
 T:\CPV\5021\to.p3d8.dgn
 HNTB

- REMOVE CONFLICTING PAVEMENT MARKING.
- INSTALL APPLICABLE PERMANENT SIGNS.

HNTB HNTB NORTH CAROLINA, P.C.
 343 E. Six Forks Road, Suite 200
 Raleigh, North Carolina 27609
 NC License No: C-1554

APPROVED: *Helen Shyu*
 DATE: 2/6/2019

SEAL

PROFESSIONAL SEAL
 042517
 ENGINEER
 HELEN SHYU

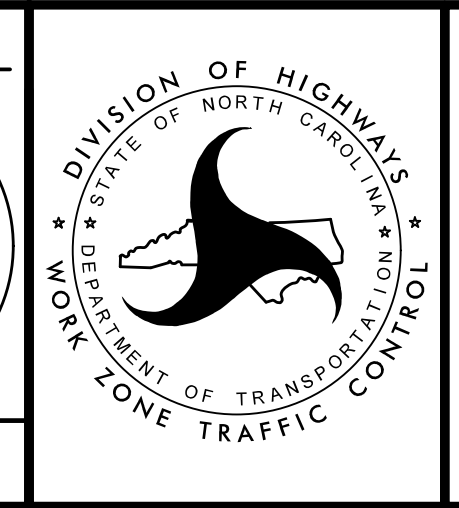

TRANSPORTATION
 MANAGEMENT PLAN

PHASE III
 DETAIL

DOCUMENT NOT CONSIDERED FINAL
 UNLESS ALL SIGNATURES COMPLETED

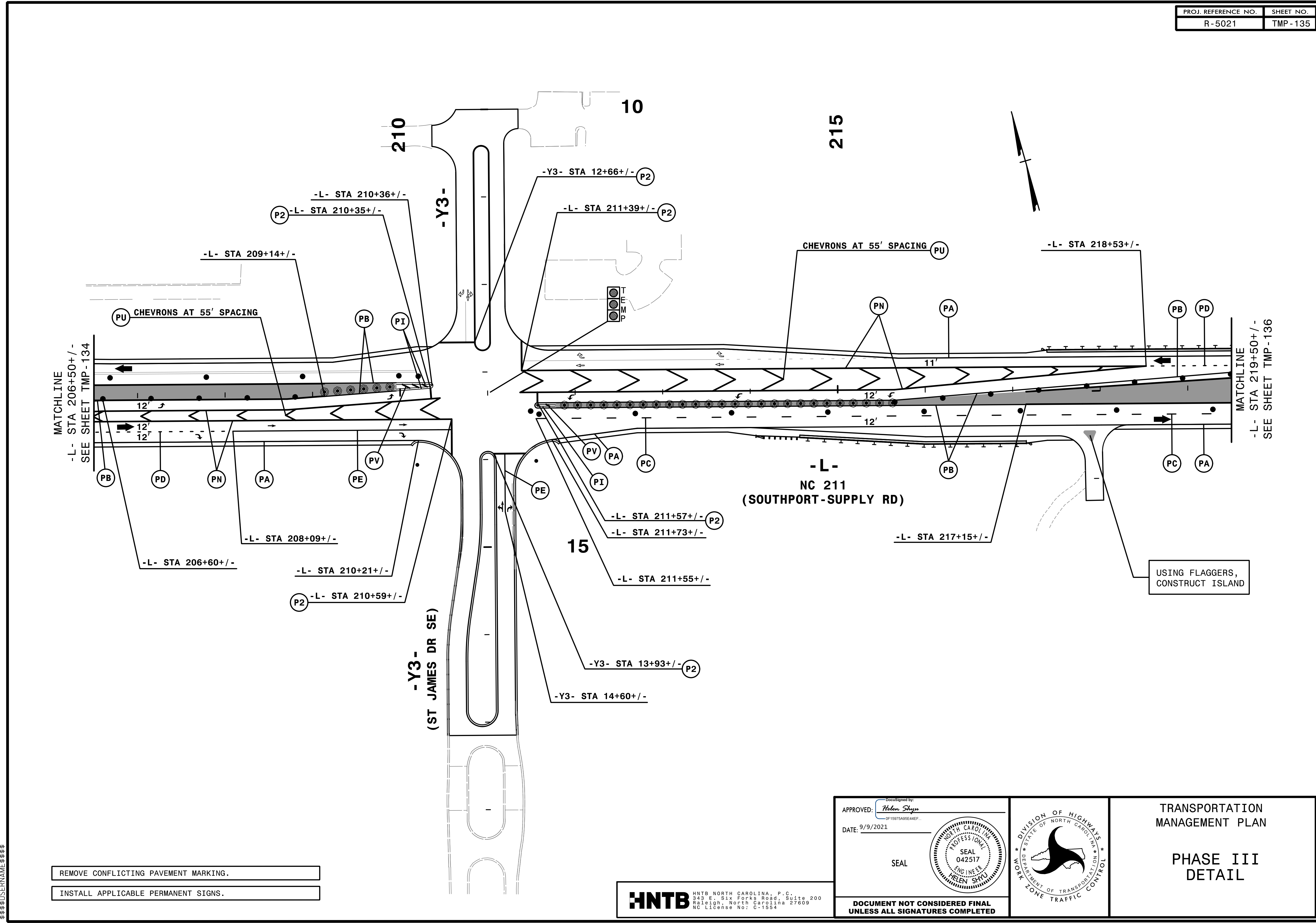

MATCHLINE
-L- STA 206+50+/-
SEE SHEET TMP-134

MATCHLINE
-L- STA 219+50+/-
SEE SHEET TMP-136

- REMOVE CONFLICTING PAVEMENT MARKING.
- INSTALL APPLICABLE PERMANENT SIGNS.

HNTB HNTB NORTH CAROLINA, P.C.
343 E. Six Forks Road, Suite 200
Raleigh, North Carolina 27609
NC License No: C-1554

APPROVED: *Helen Shyu*
DATE: 9/9/2021
SEAL
Professional Engineer Seal for Helen Shyu, No. 042517, State of North Carolina.

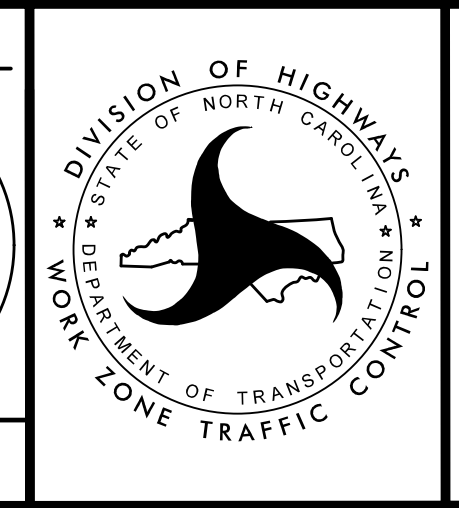

TRANSPORTATION
MANAGEMENT PLAN

PHASE III
DETAIL

4:55:34 PM
\\TCN15021\c_p3d9.dgn
\$\$\$\$\$USERNAME\$\$\$\$\$