

Br. No. = US 158-04-60
 County = Currituck
 #16

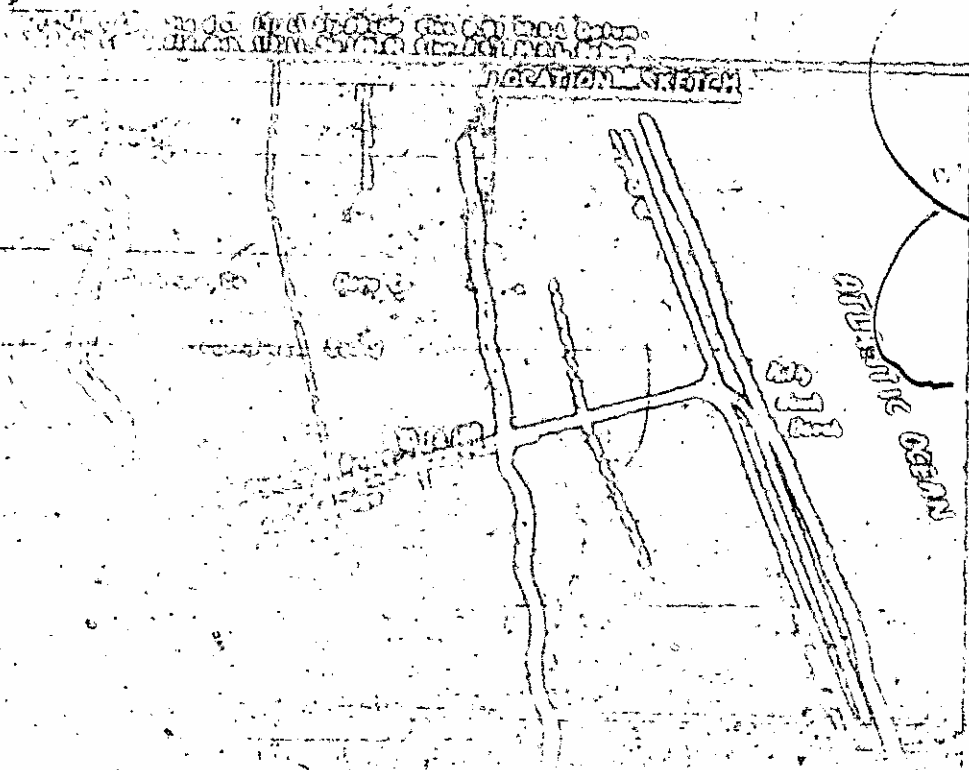

Swing Span
 March 4 STRAITS
 Br. No. # 73
 CARTERET County

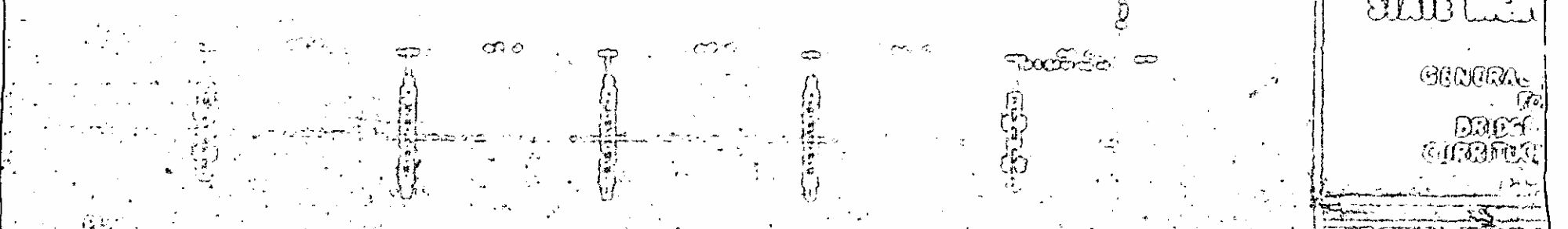
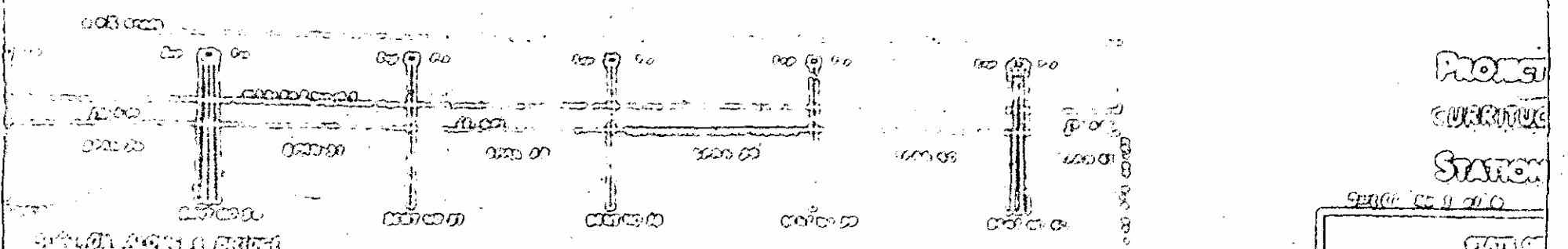
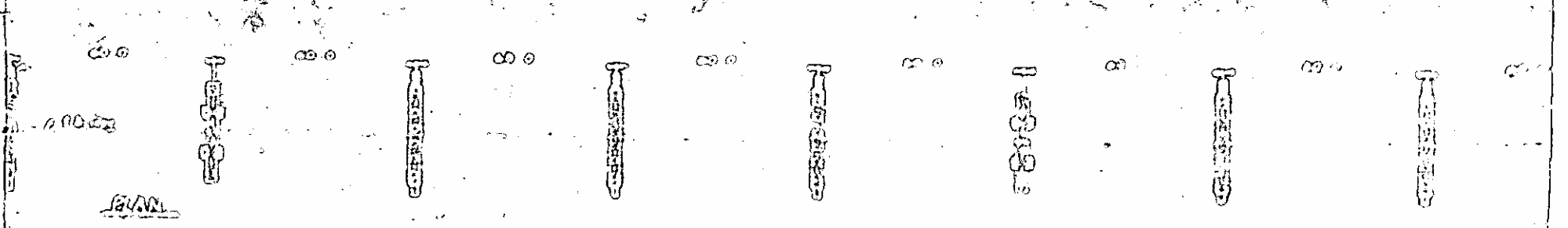
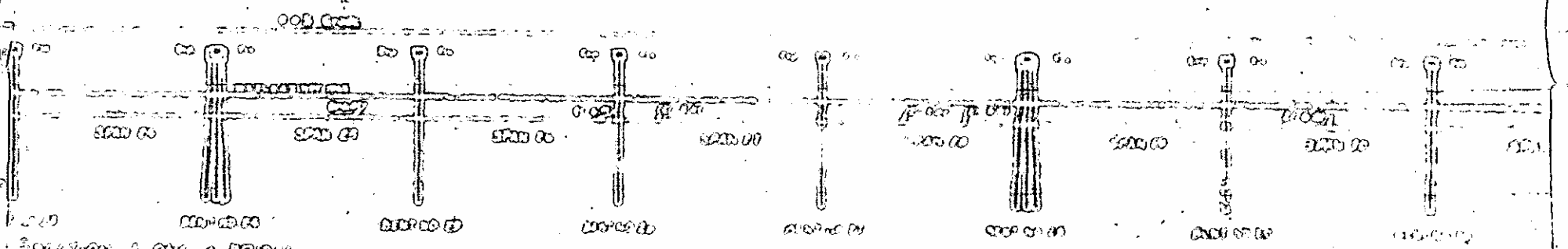
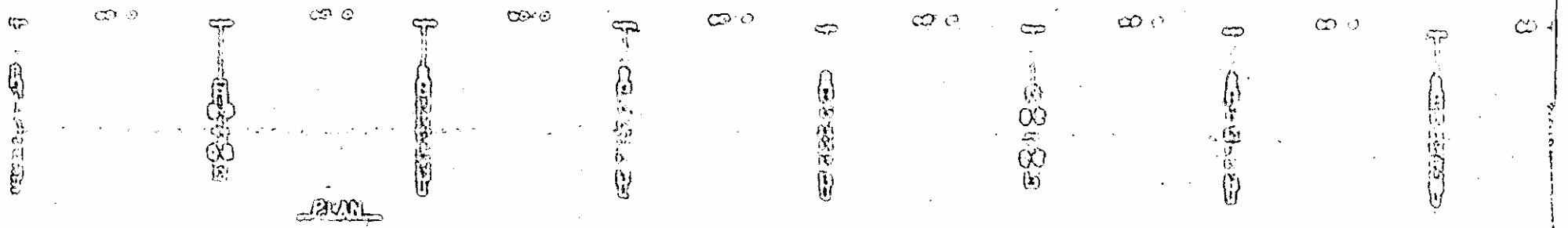
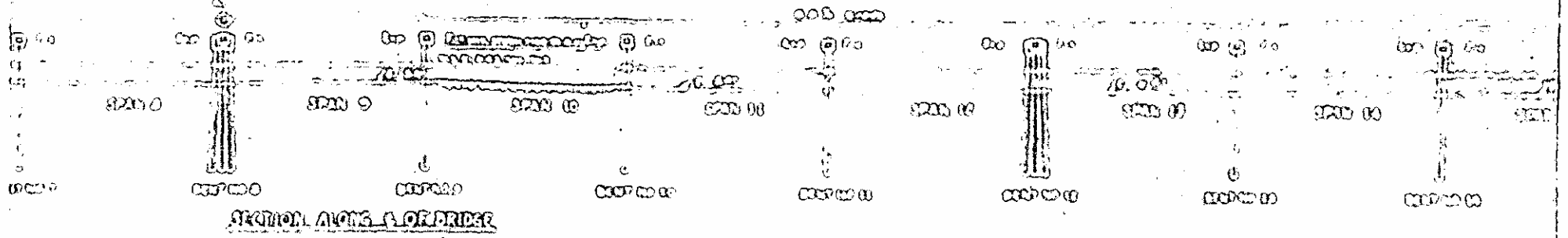

PROMPT
CURATIVE
STARCH

STATE MEN
GENERAL
BRIDGE
CURATIVE

Handwritten text or markings in the top left corner.

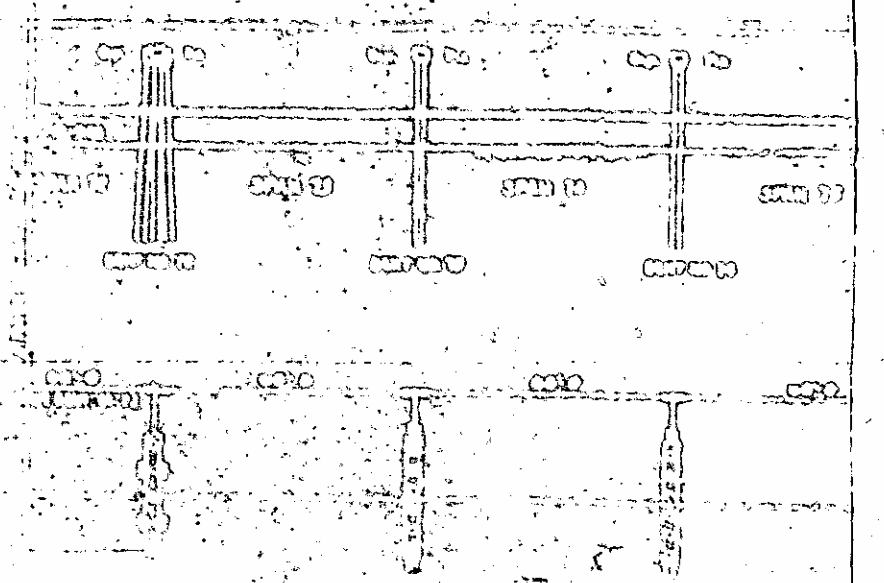
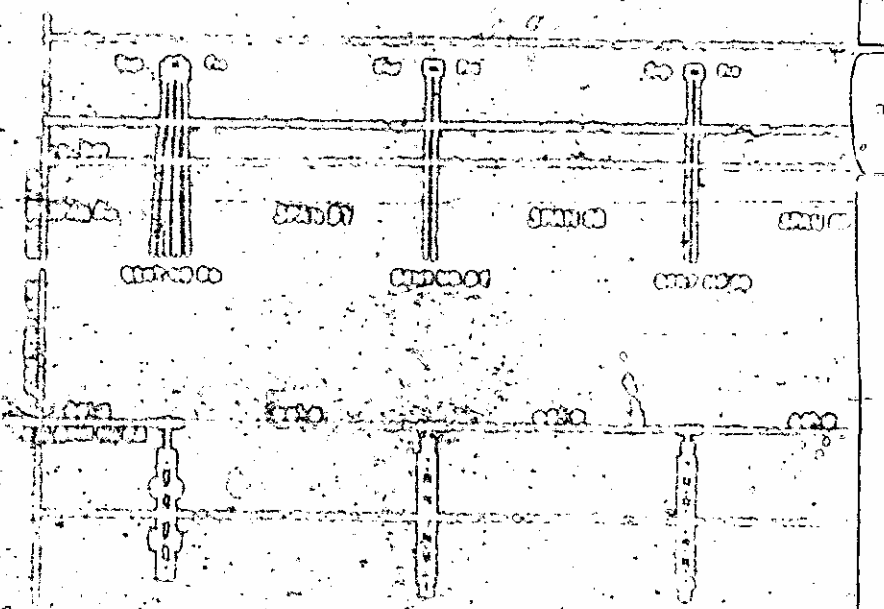
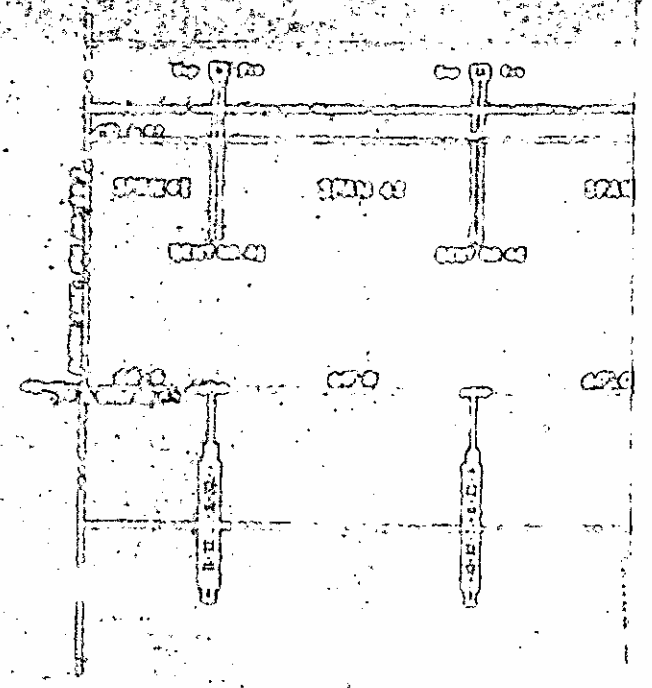

Handwritten text or markings in the bottom left corner.

Handwritten text or markings in the top left corner.

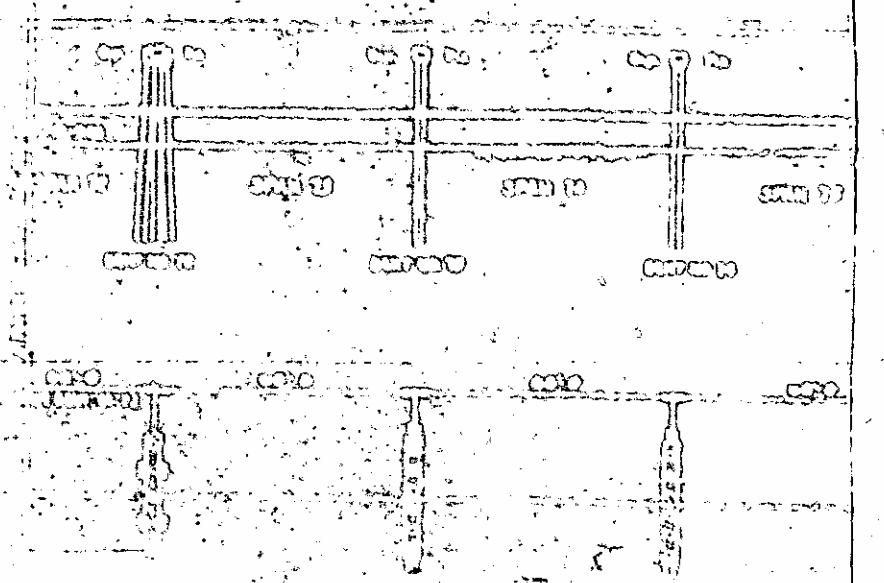
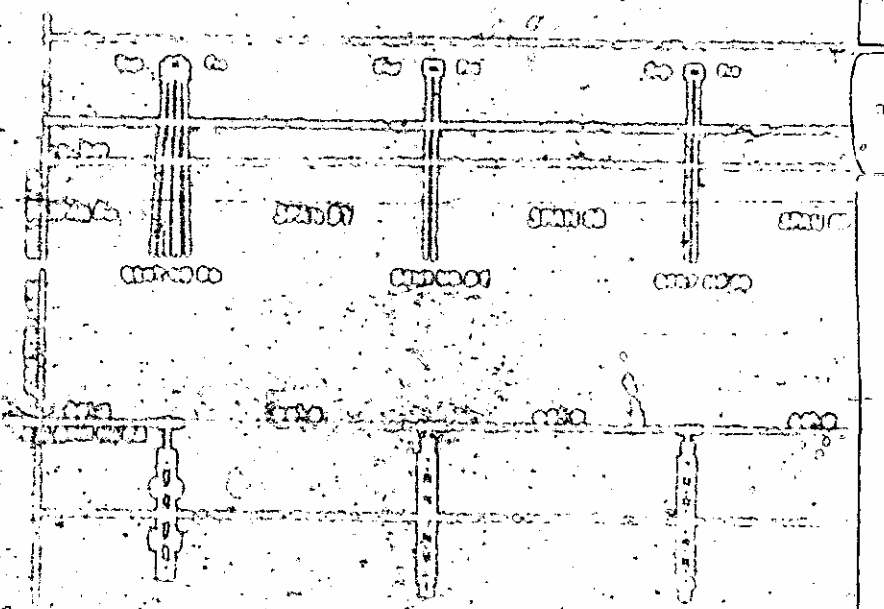
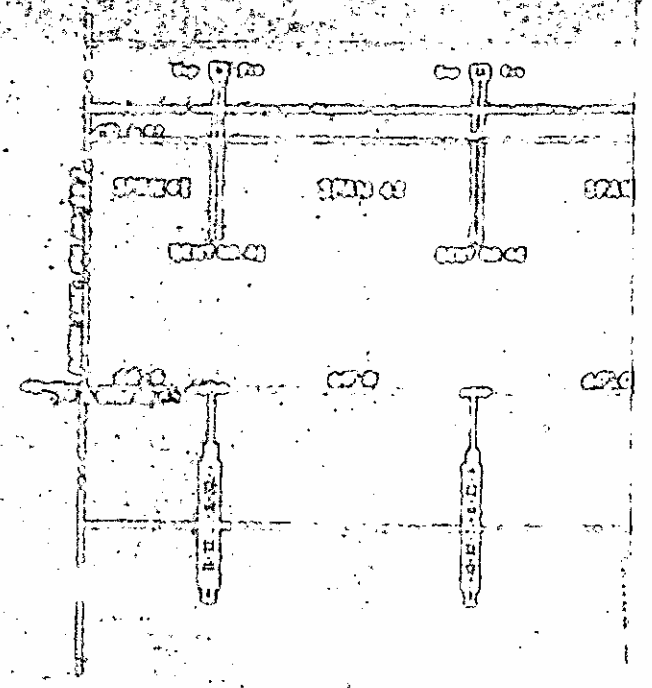

Handwritten text or markings in the bottom left corner.

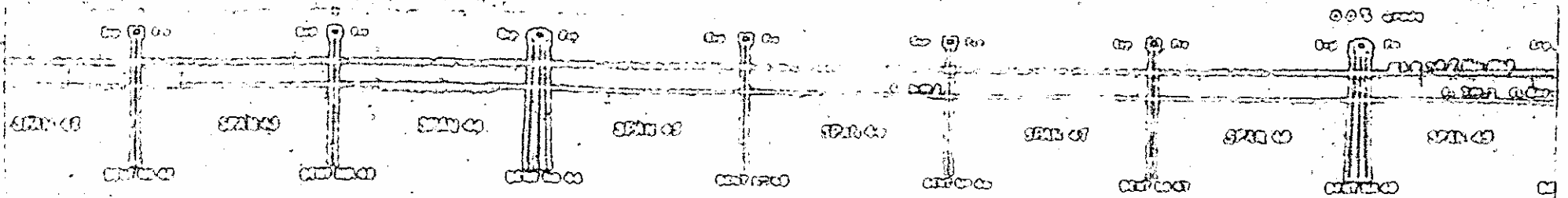

SECTION ALONG A BRIDGE

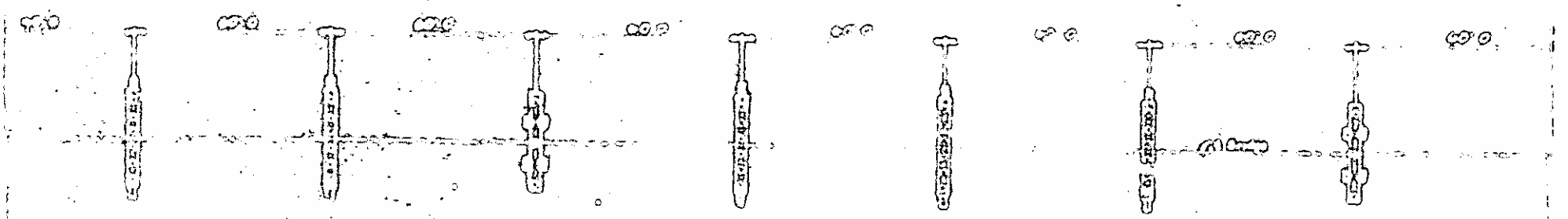

PLAN

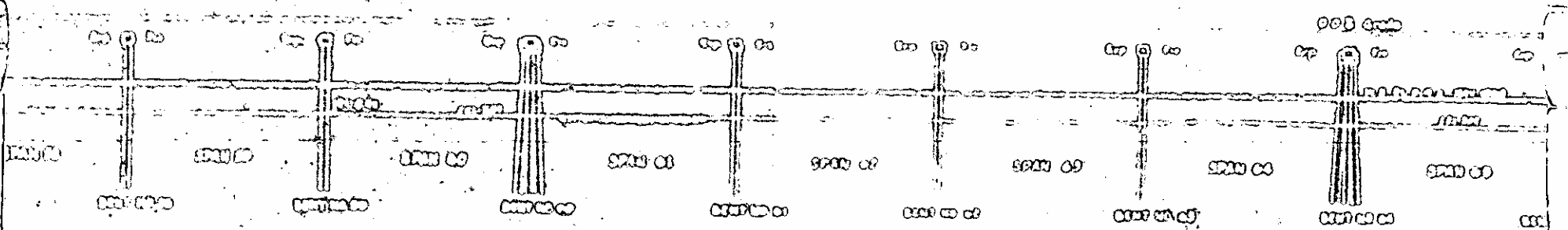

SECTION ALONG A BRIDGE

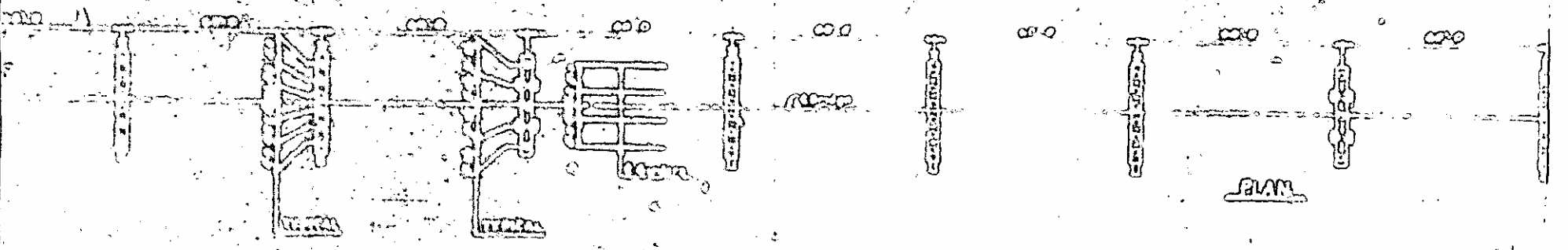

PLAN

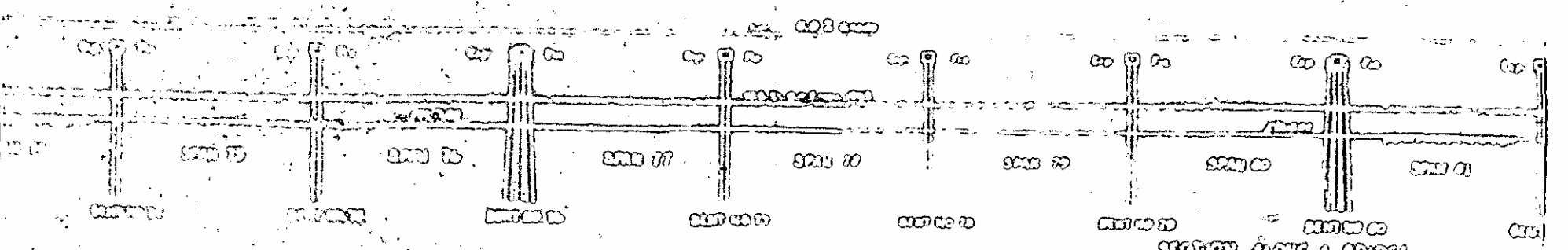

SECTION ALONG A BRIDGE

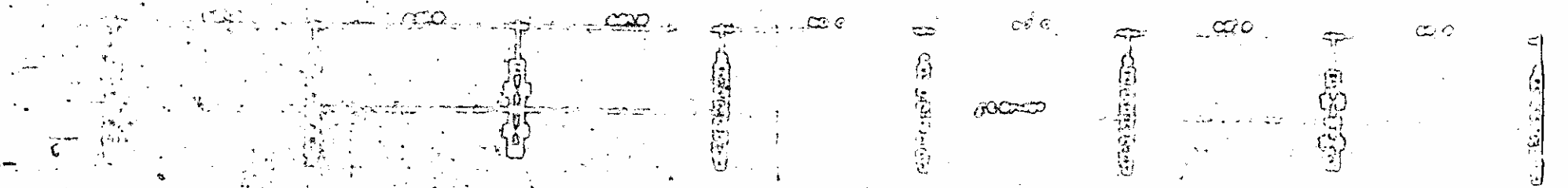

PLAN

7-11
100

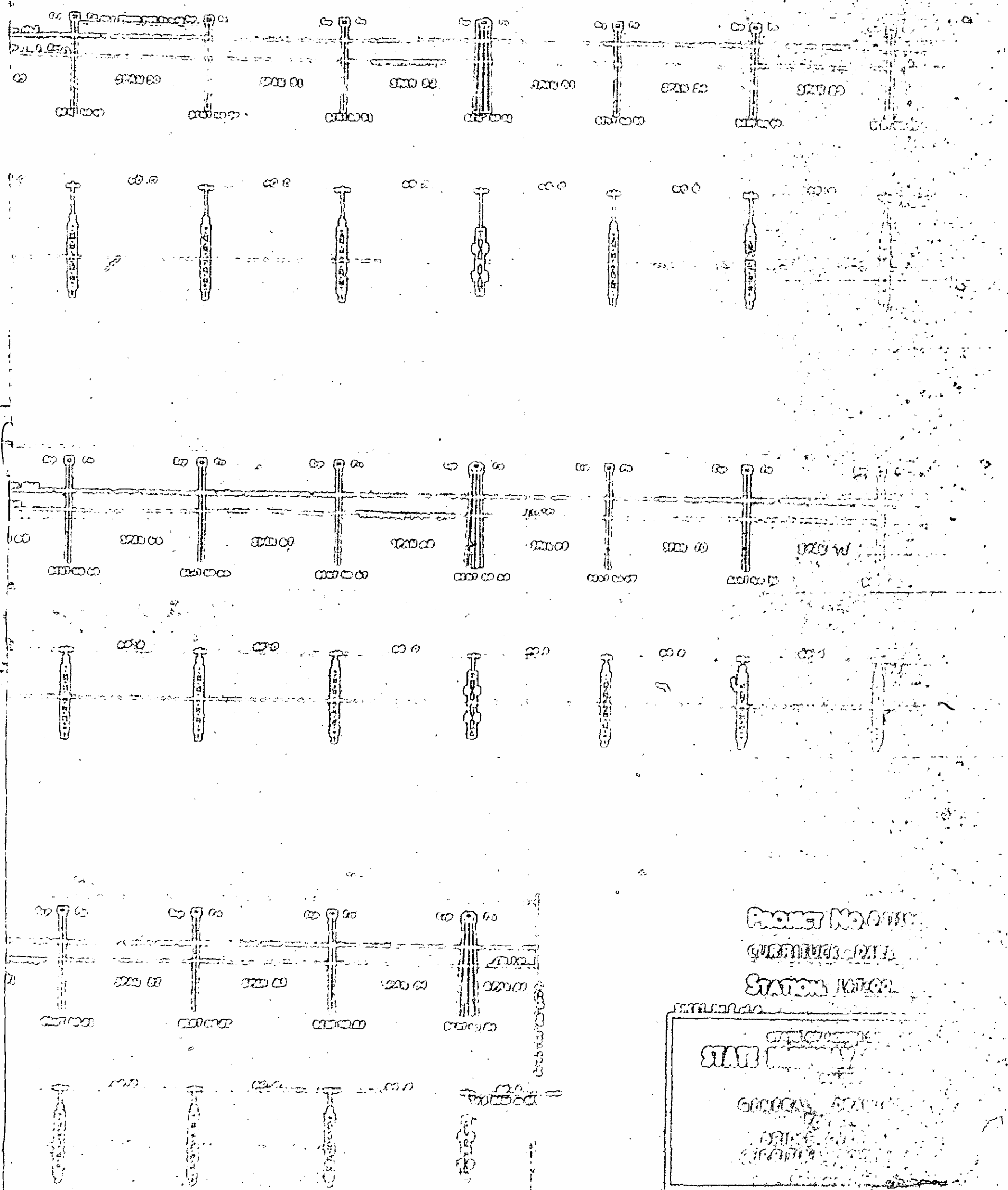

Project No. 0111
Quantity 1211
Station 1000

STATE
GEORGIA
BRIDGE

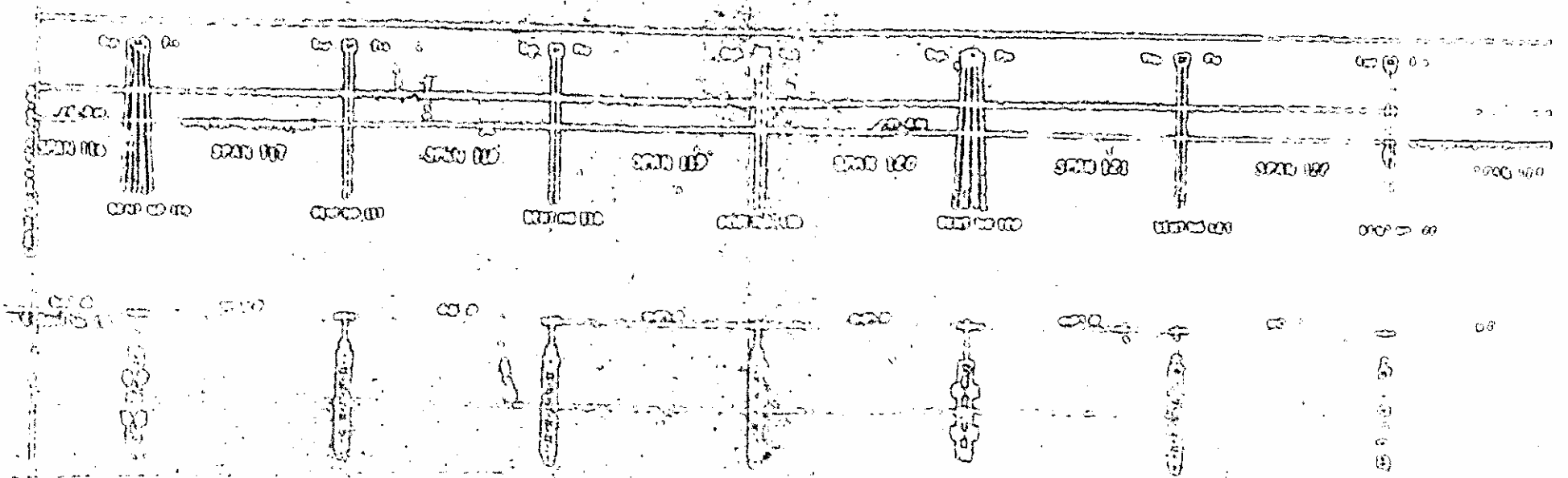
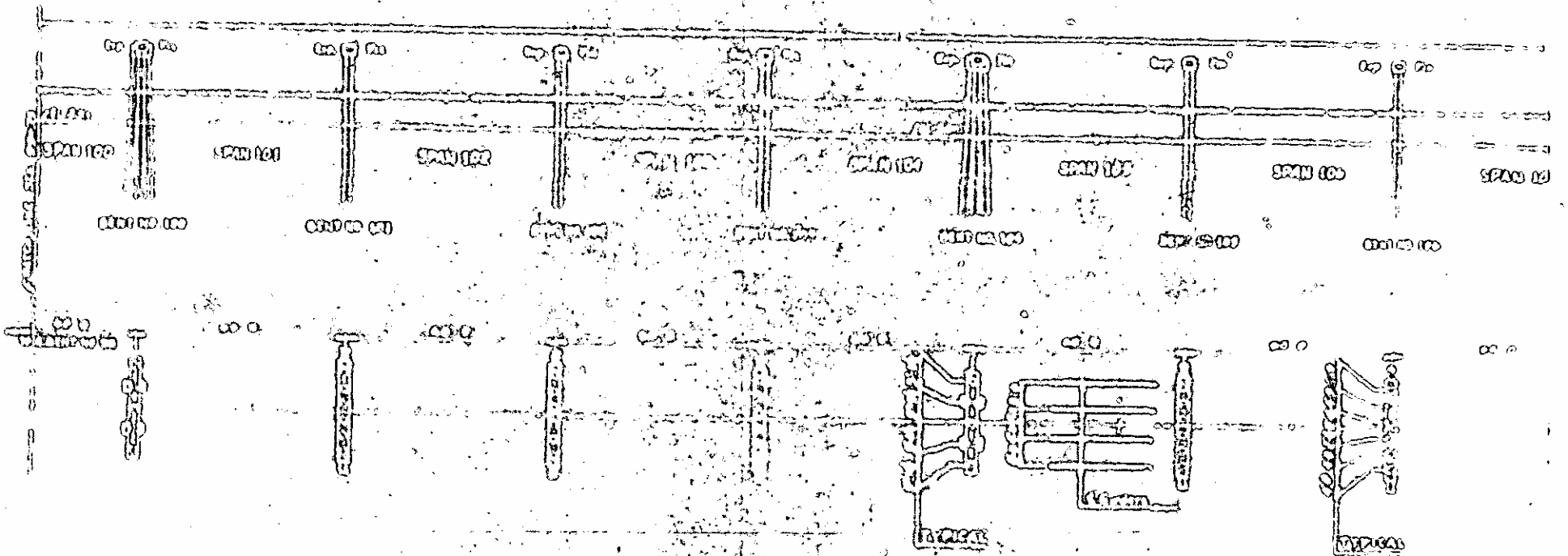
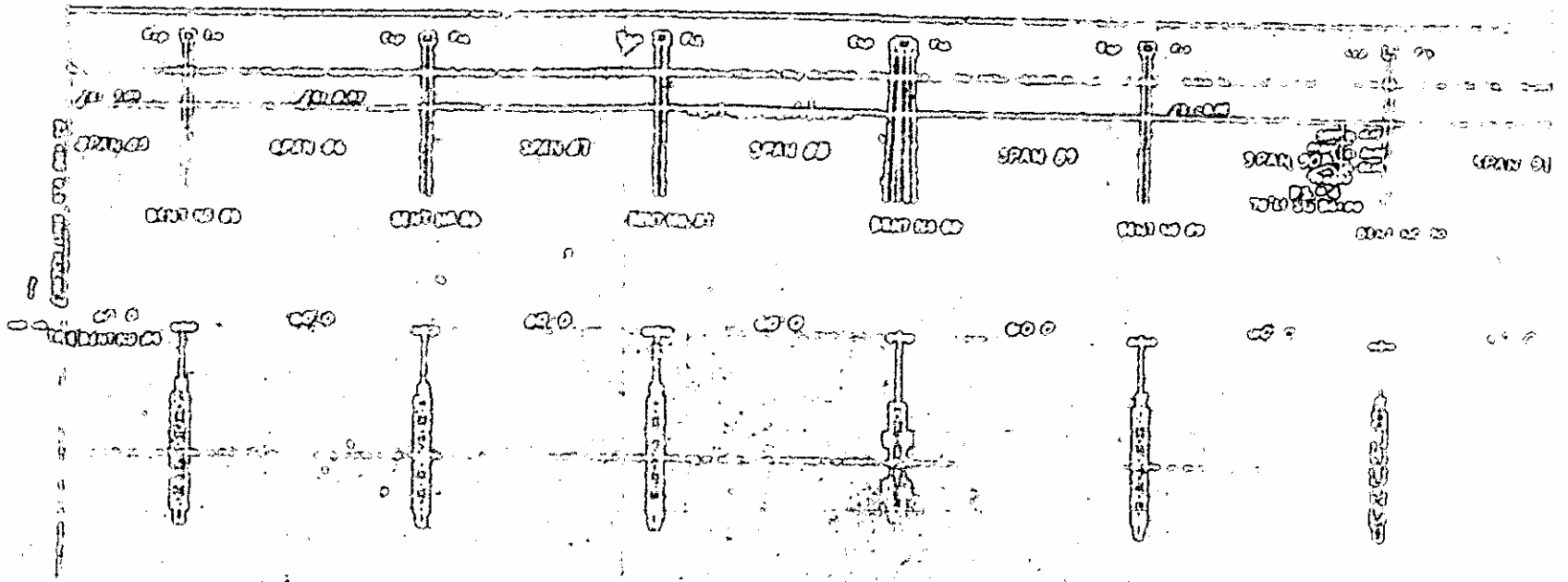

BRIDGE

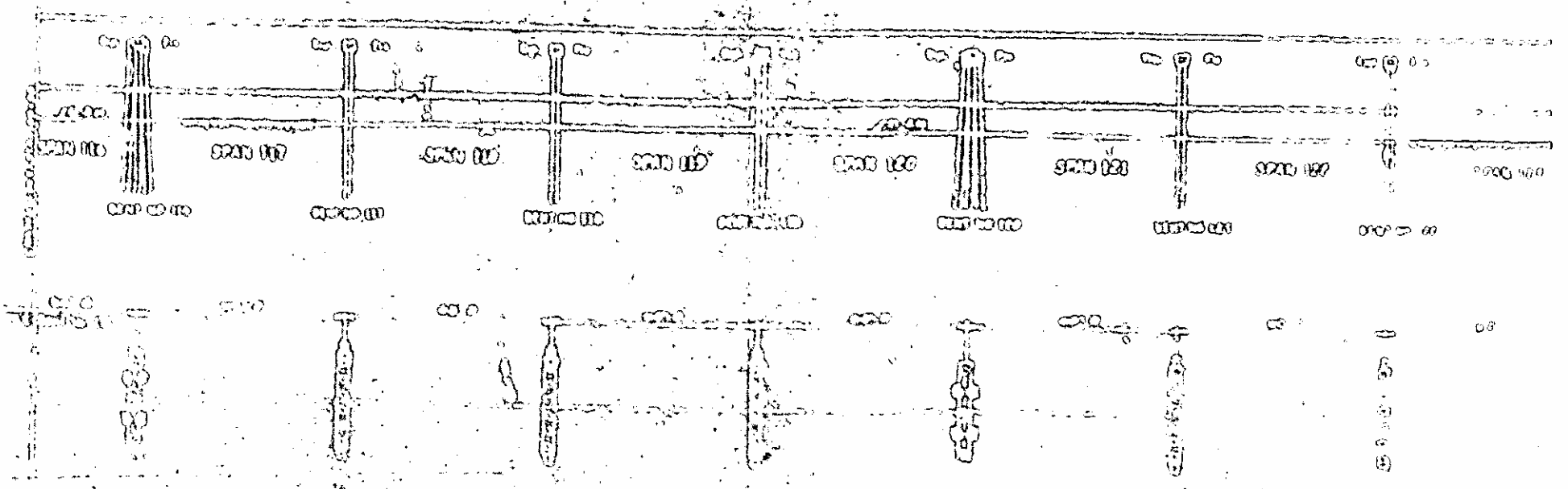
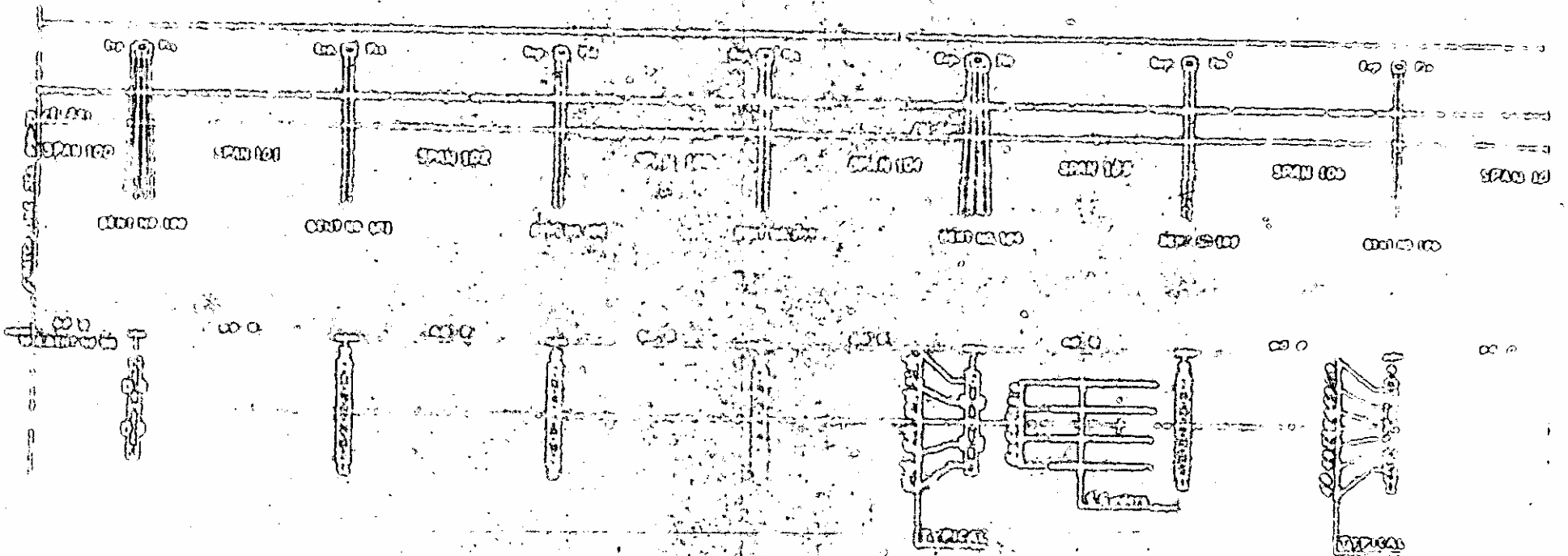
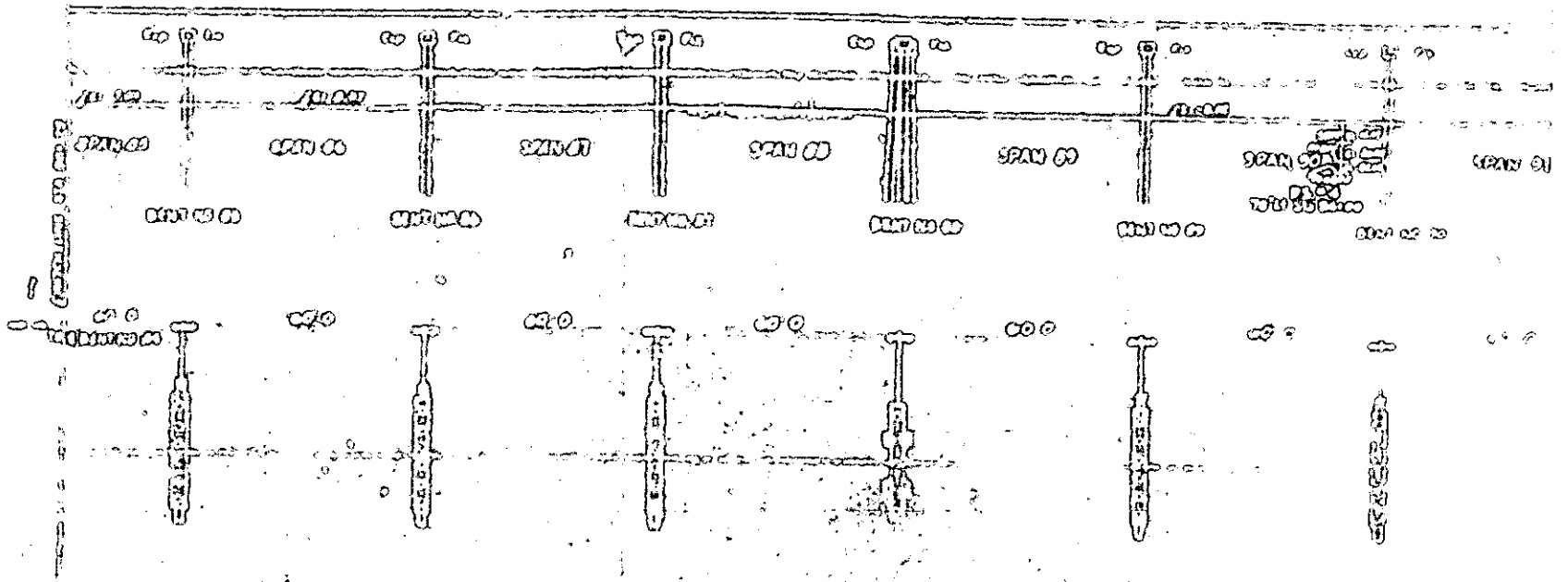

BRIDGE

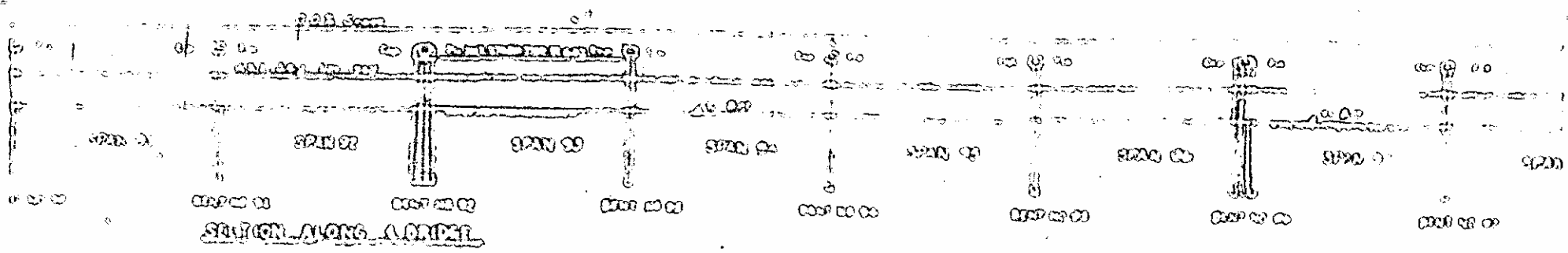

SECTION ALONG A BRIDGE

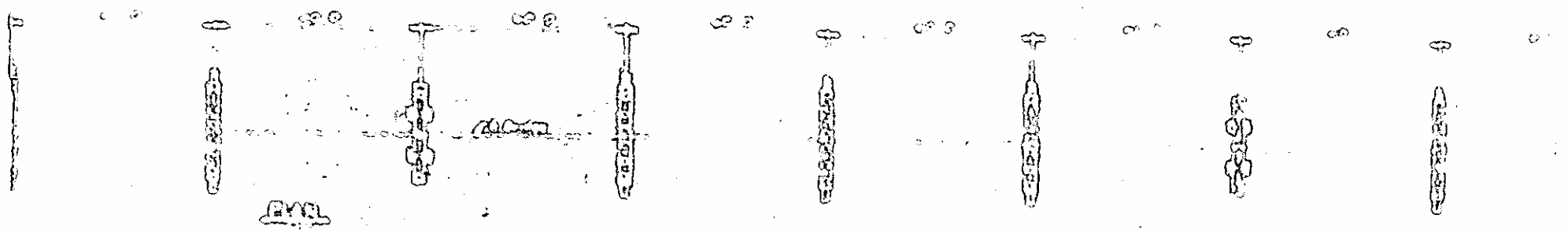

ELEV.

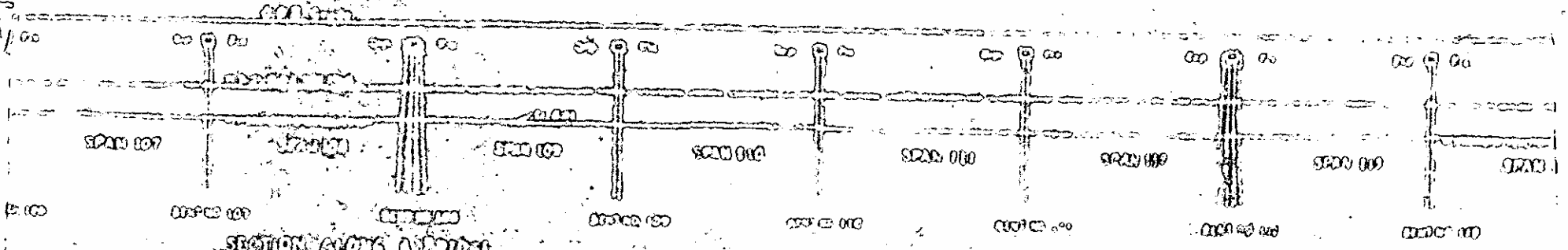

SECTION ALONG A BRIDGE

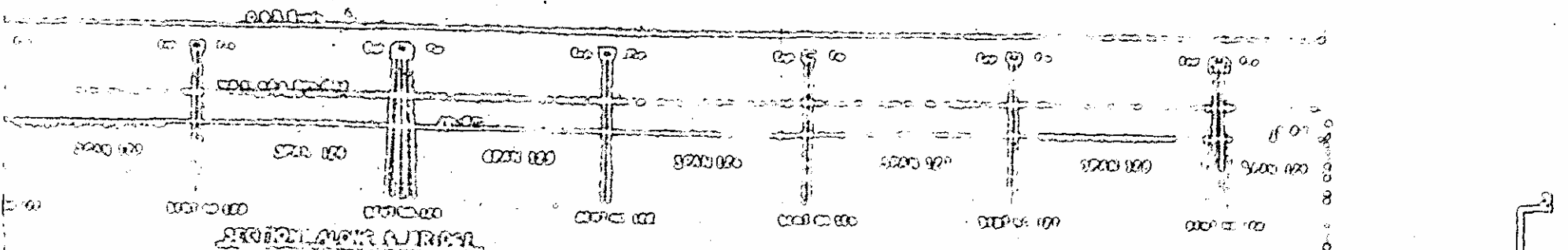
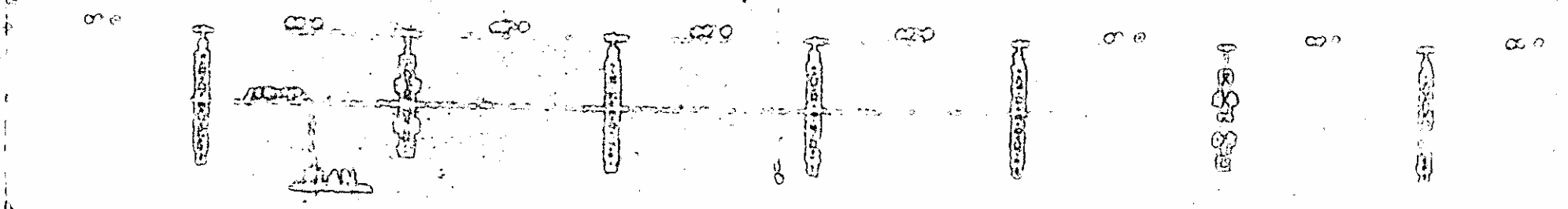

SECTION ALONG A BRIDGE

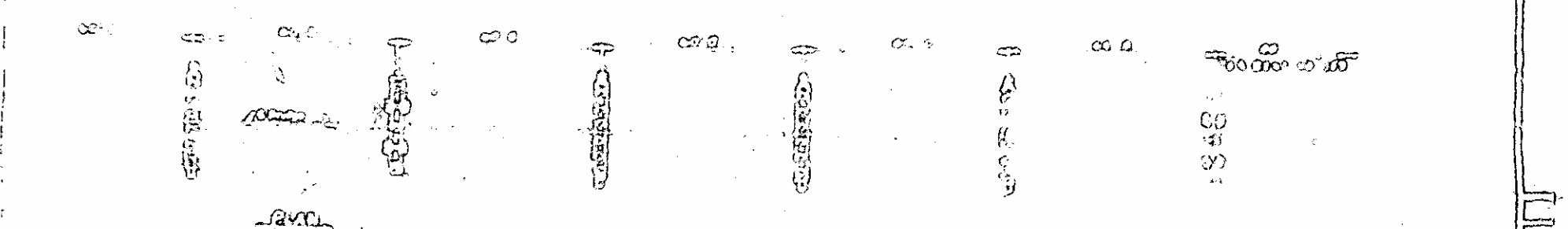

ELEV.

STATE OF MICHIGAN
DEPARTMENT OF HIGHWAYS

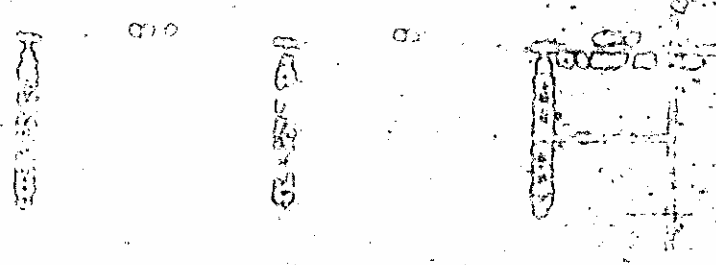
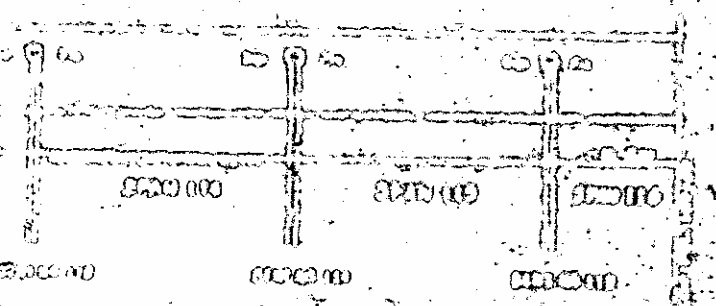
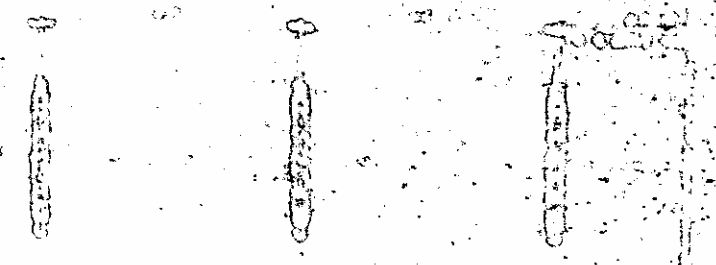
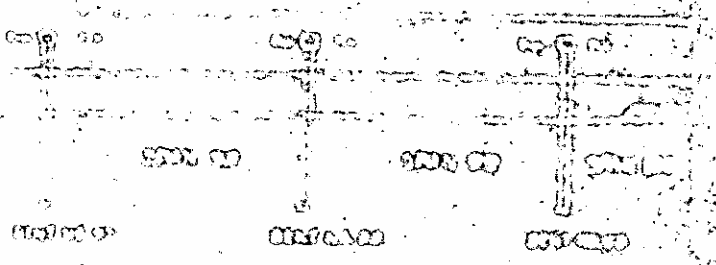

PROJECT No. 41152

CONTRACTOR DARE Co.

STATION 147+00

STATE OF MICHIGAN
STATE HIGHWAY COMMISSION
GENERAL DRAWING
FOR
BRIDGE OVER
COURTNEY CREEK
SECTION 16

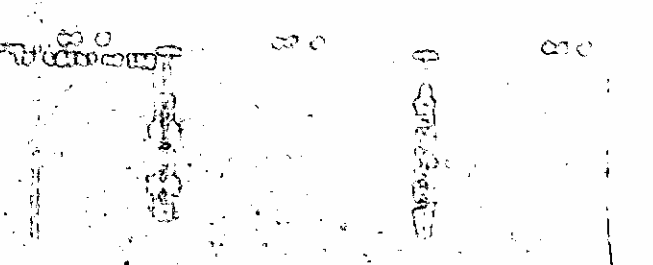
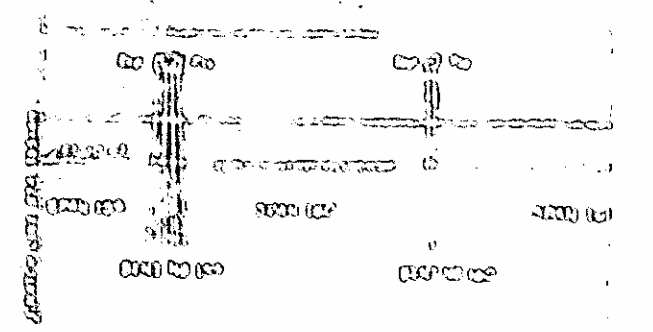
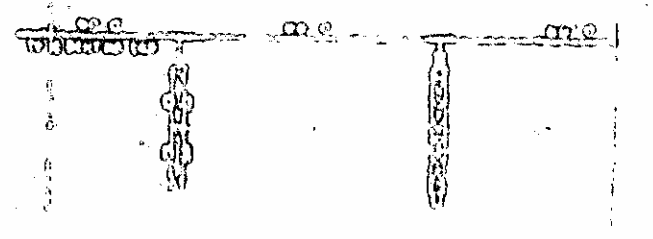
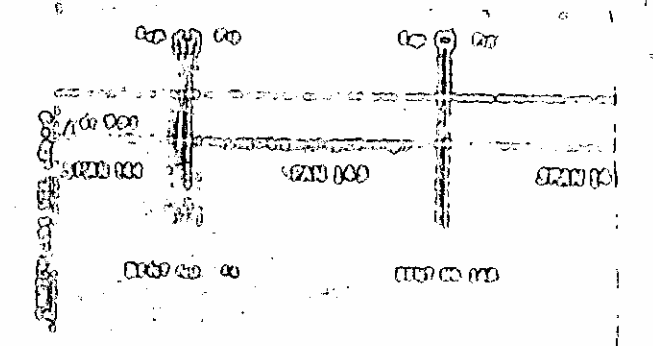
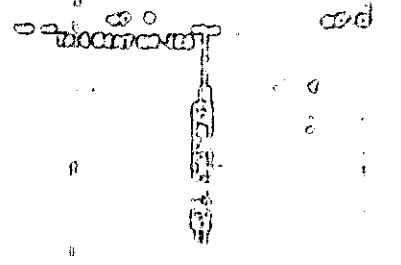
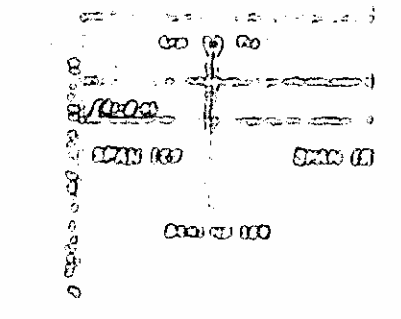

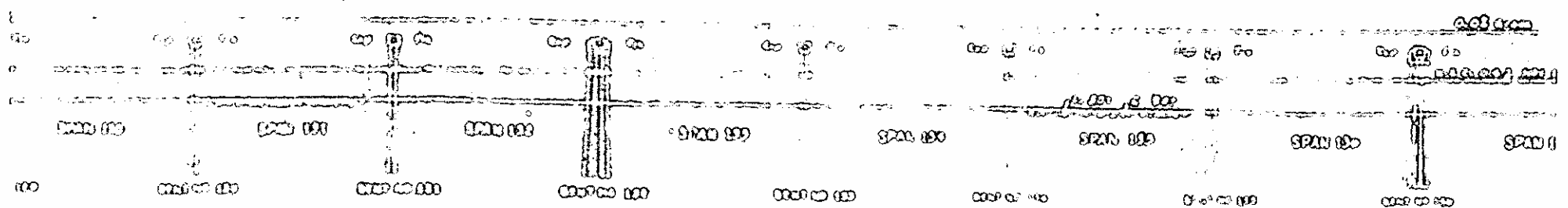

SECTION ALONG A BRIDGE

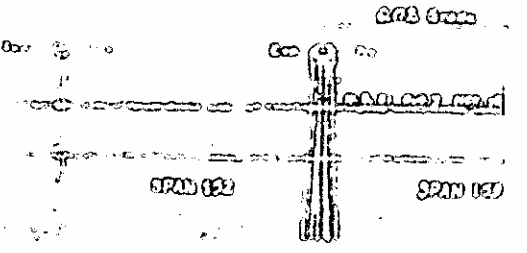
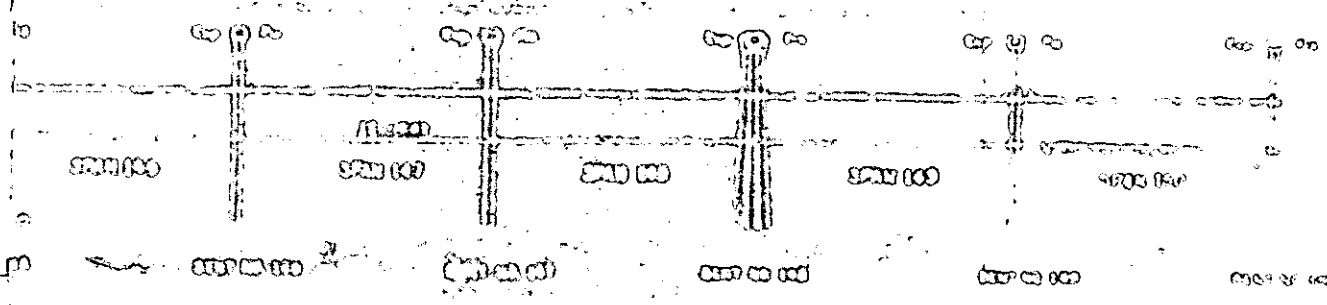
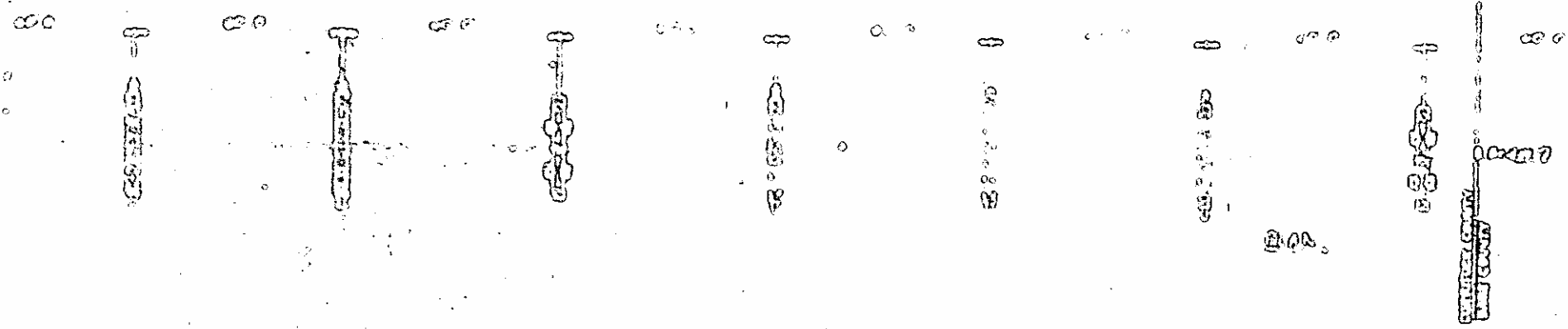

SECTION ALONG A BRIDGE

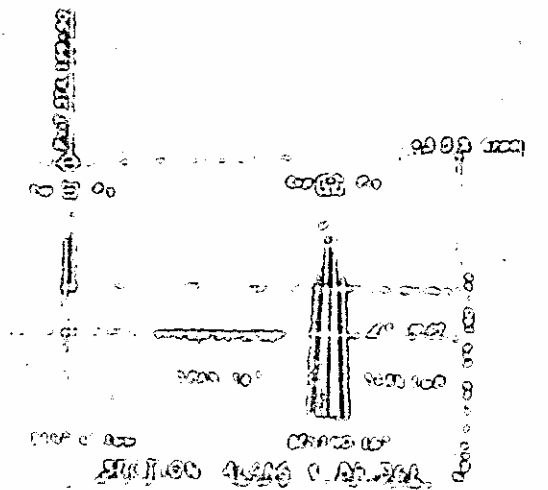
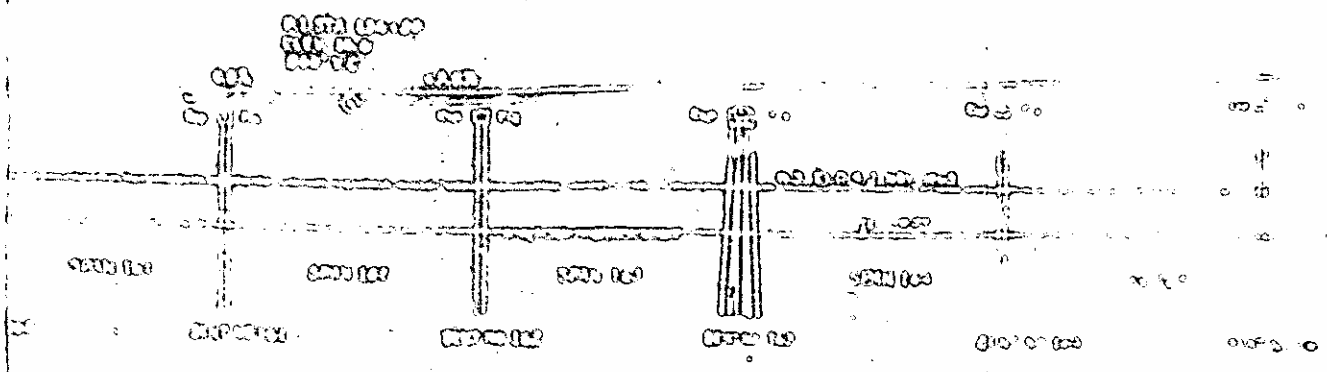
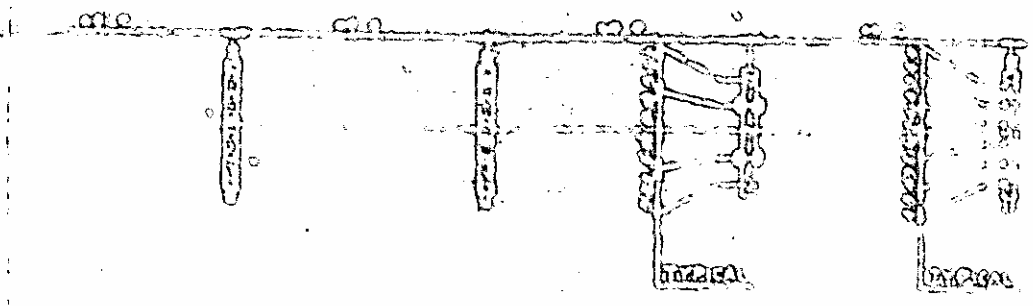
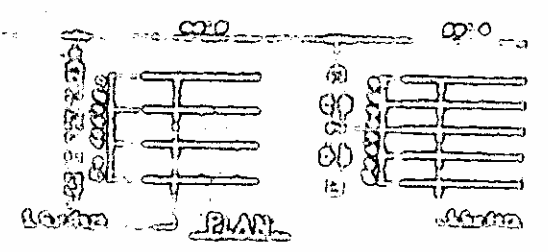

SECTION ALONG A BRIDGE

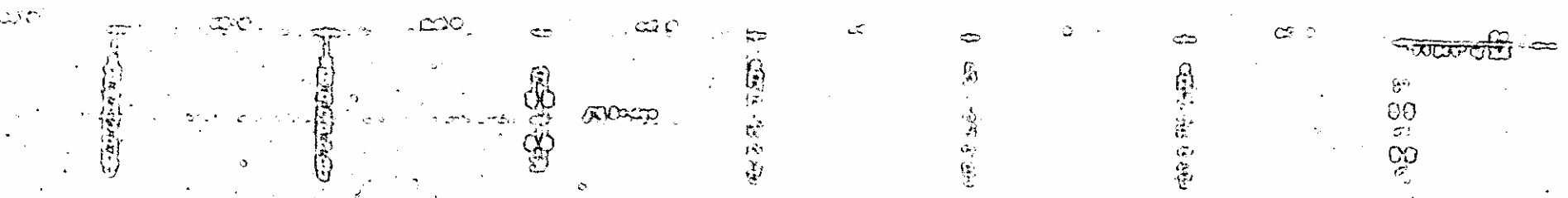

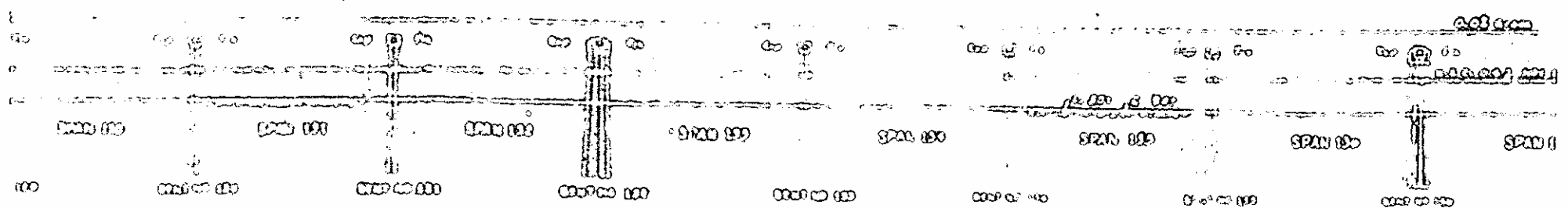

SECTION ALONG A BRIDGE

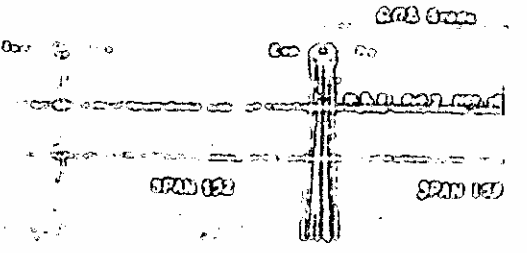
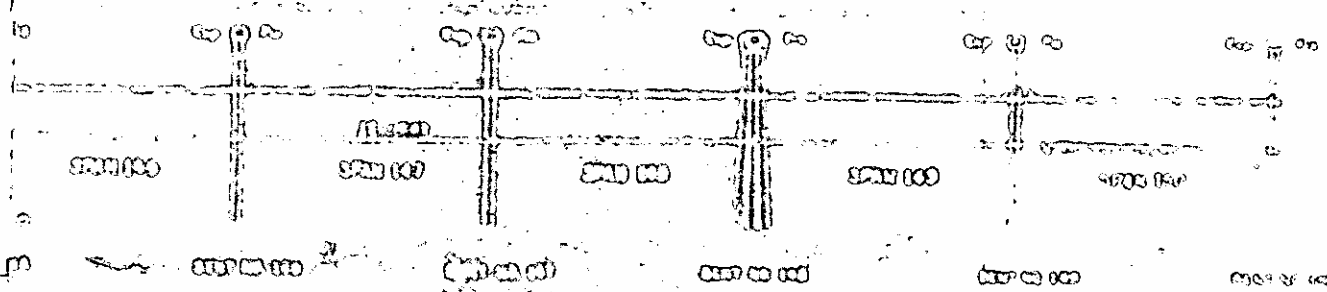
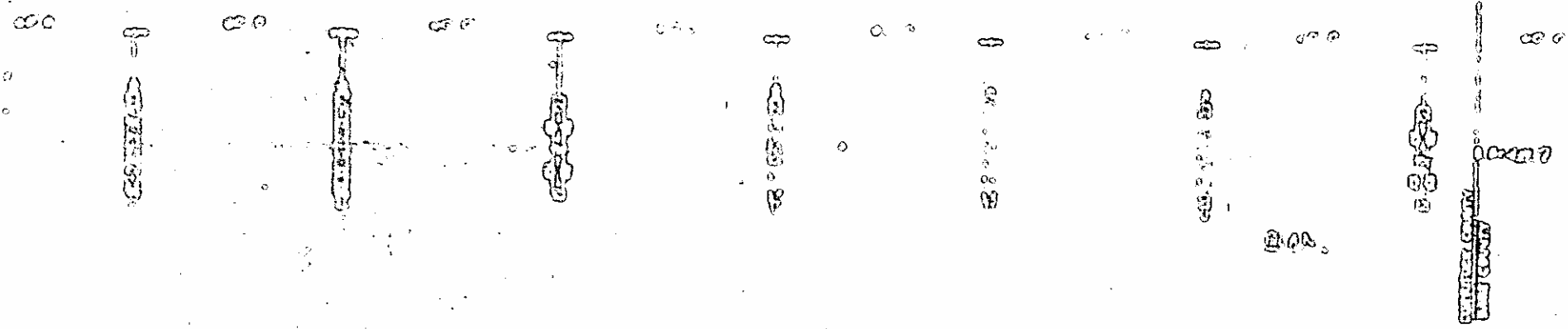

SECTION ALONG A BRIDGE

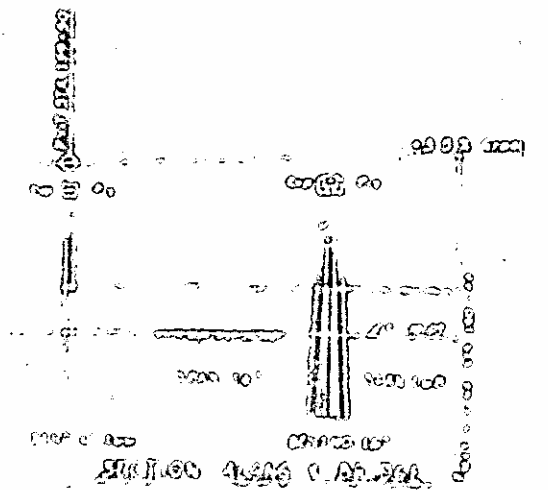
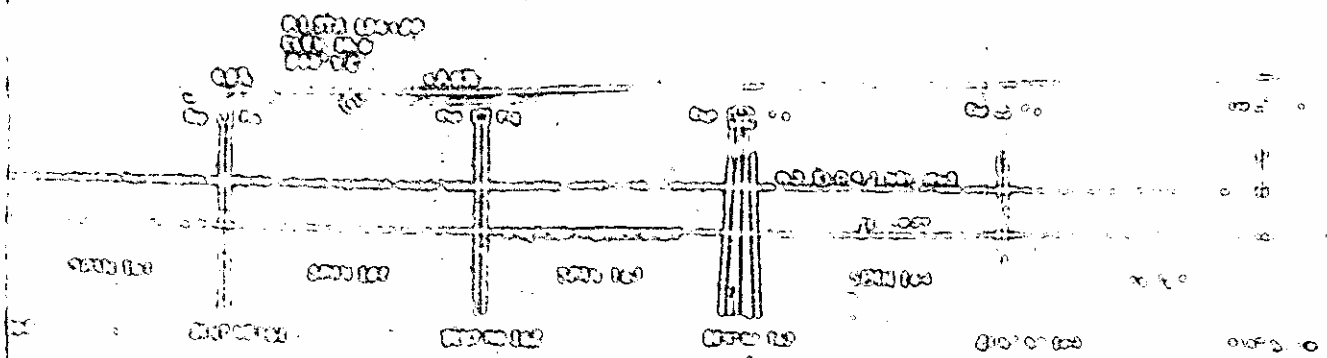
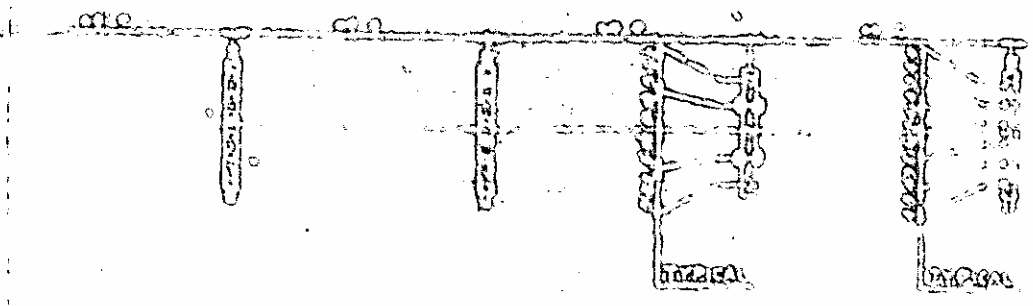
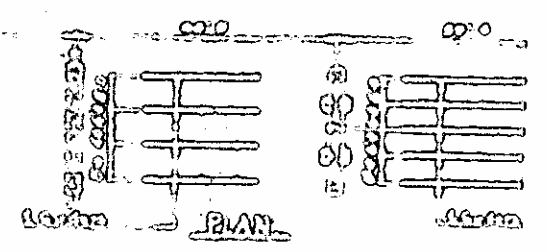

SECTION ALONG A BRIDGE

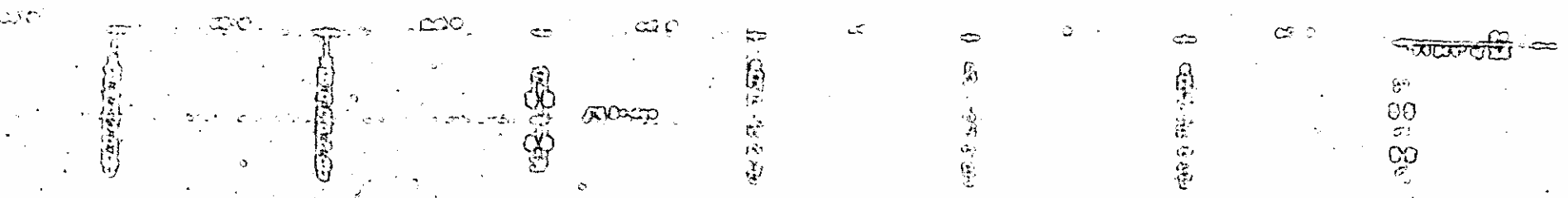

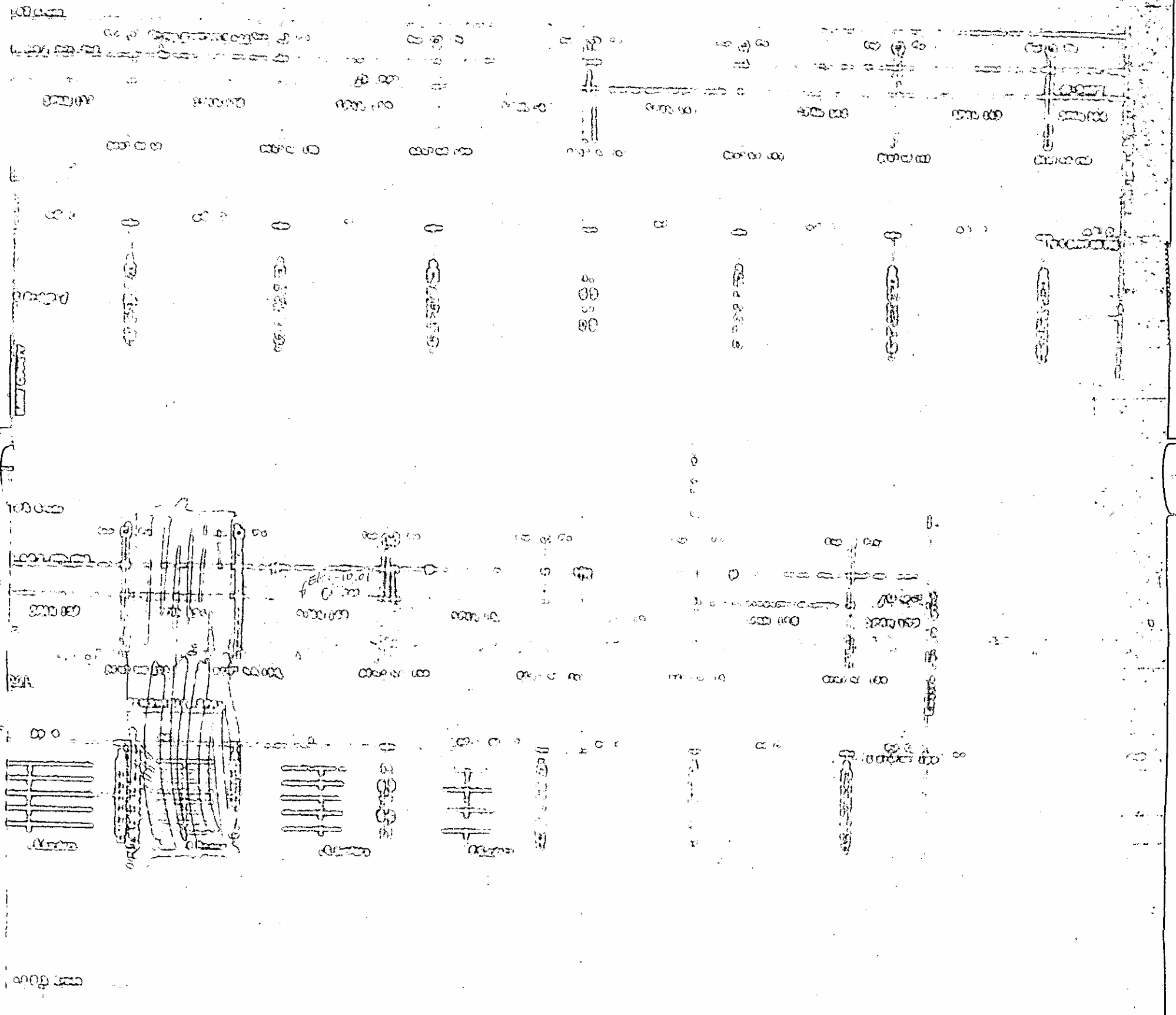

PROJECT No. 0 111111

STATE HIGHWAY COMMISSION

STATION 10+00

STATE OF KENTUCKY
STATE HIGHWAY COMMISSION
 COUNTY

GENERAL DRAWING
 FOR
 BRIDGE OVER
 CREEK

(111111)

111111
 111111
 111111
 111111

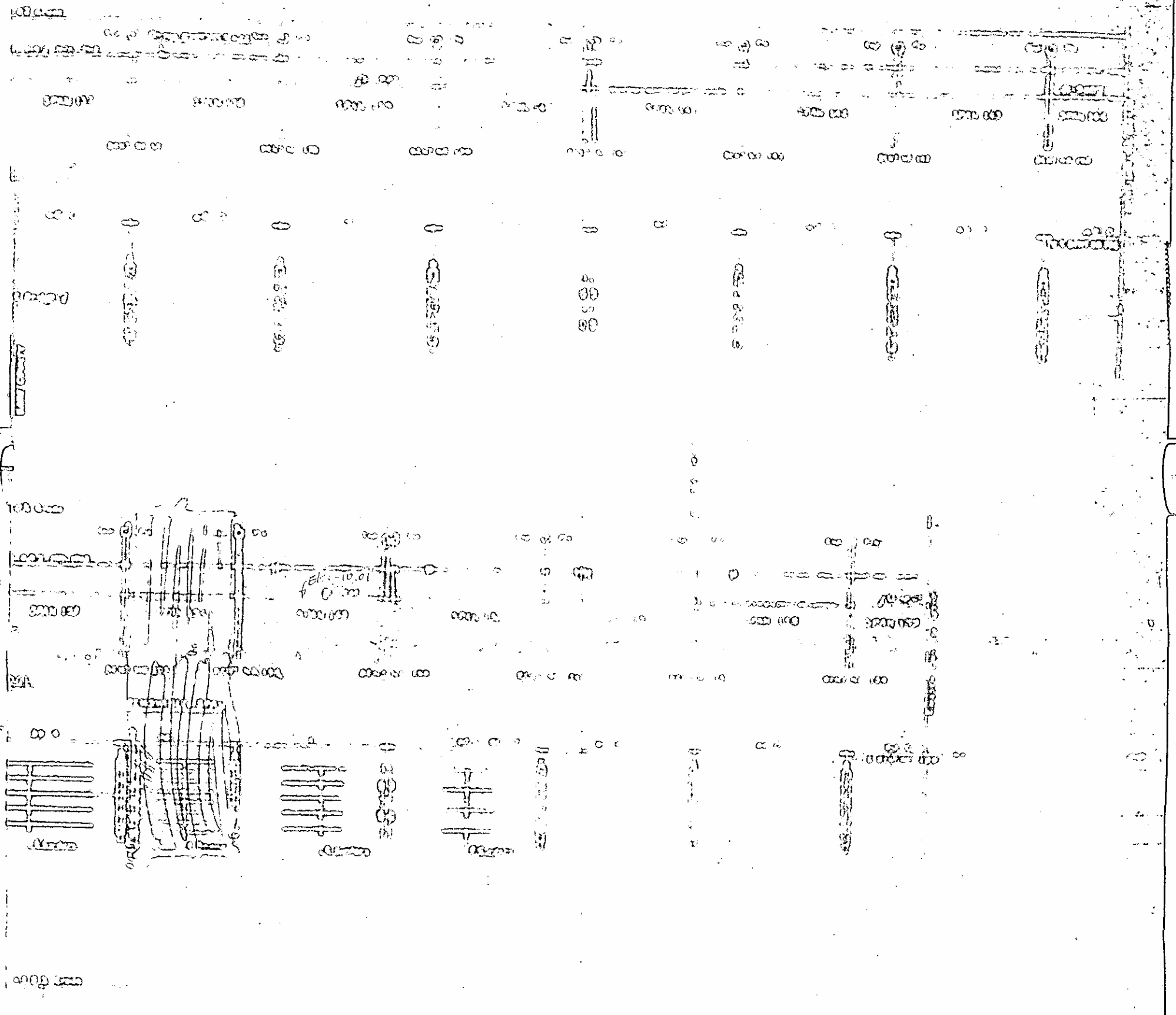

PROJECT No. 0 111111

STATE HIGHWAY COMMISSION

STATION 10+00

STATE OF KENTUCKY
STATE HIGHWAY COMMISSION
 COUNTY

GENERAL DRAWING
 FOR
 BRIDGE OVER
 CREEK

(111111)

111111
 111111
 111111
 111111

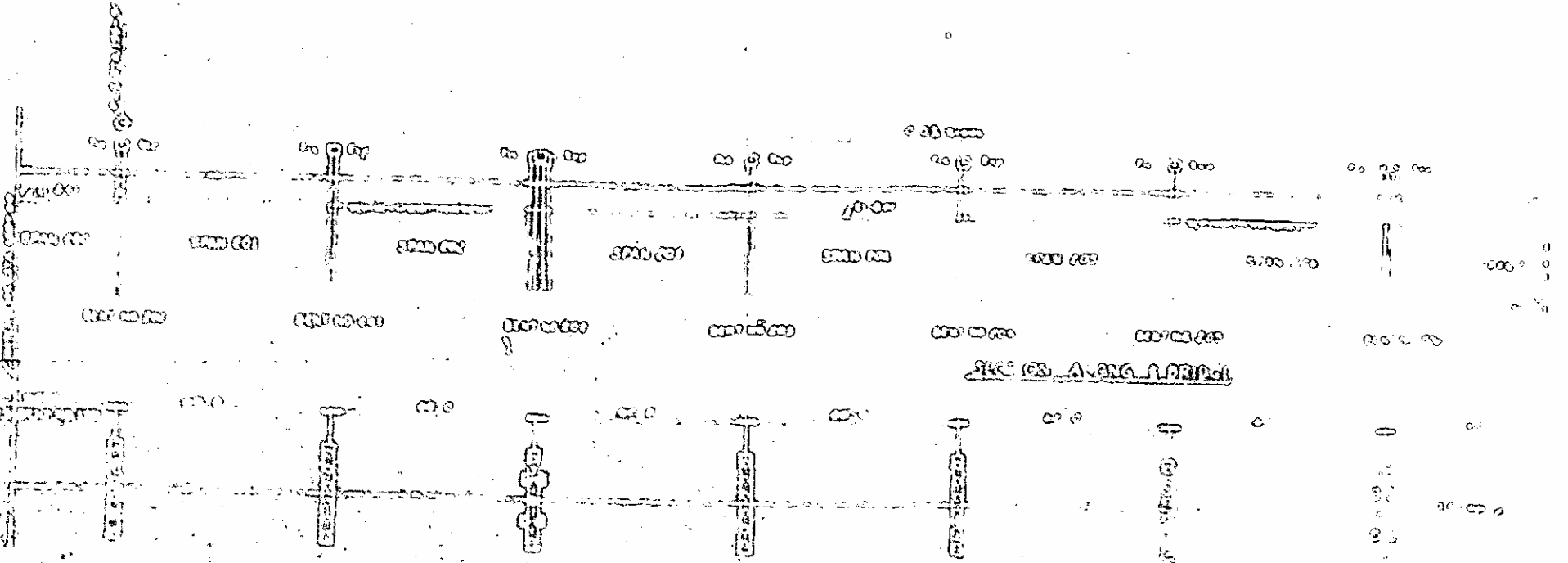
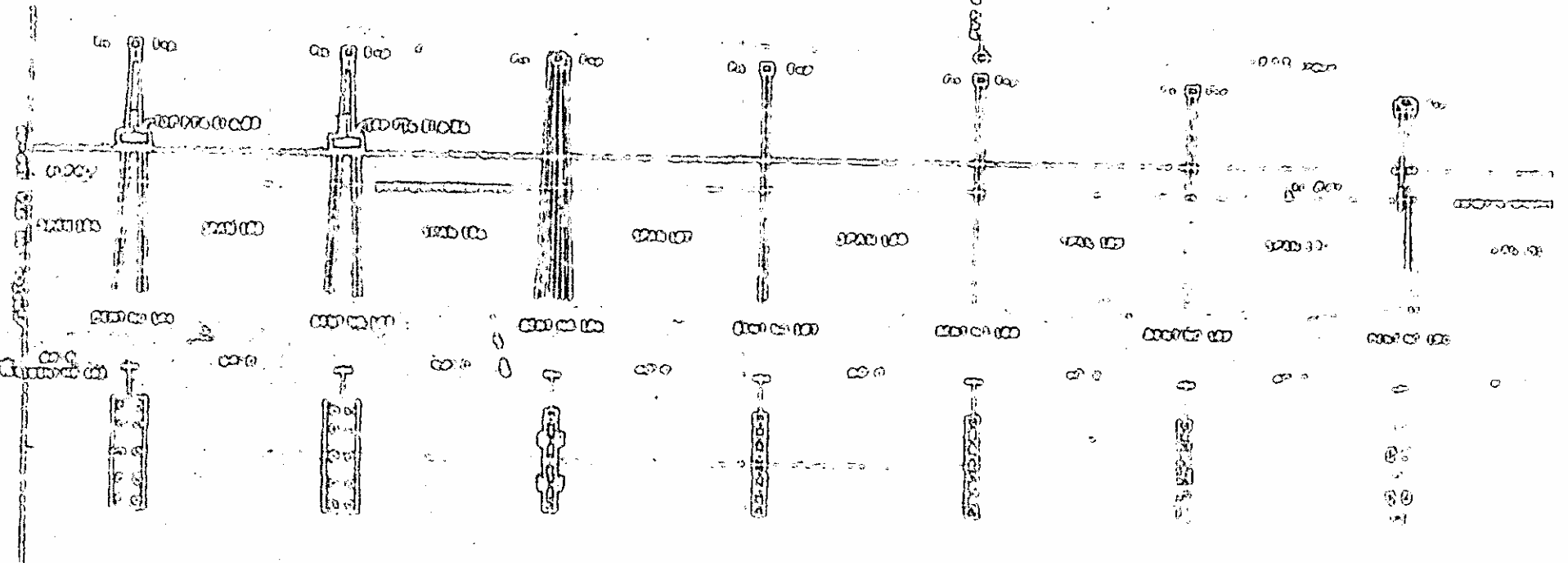
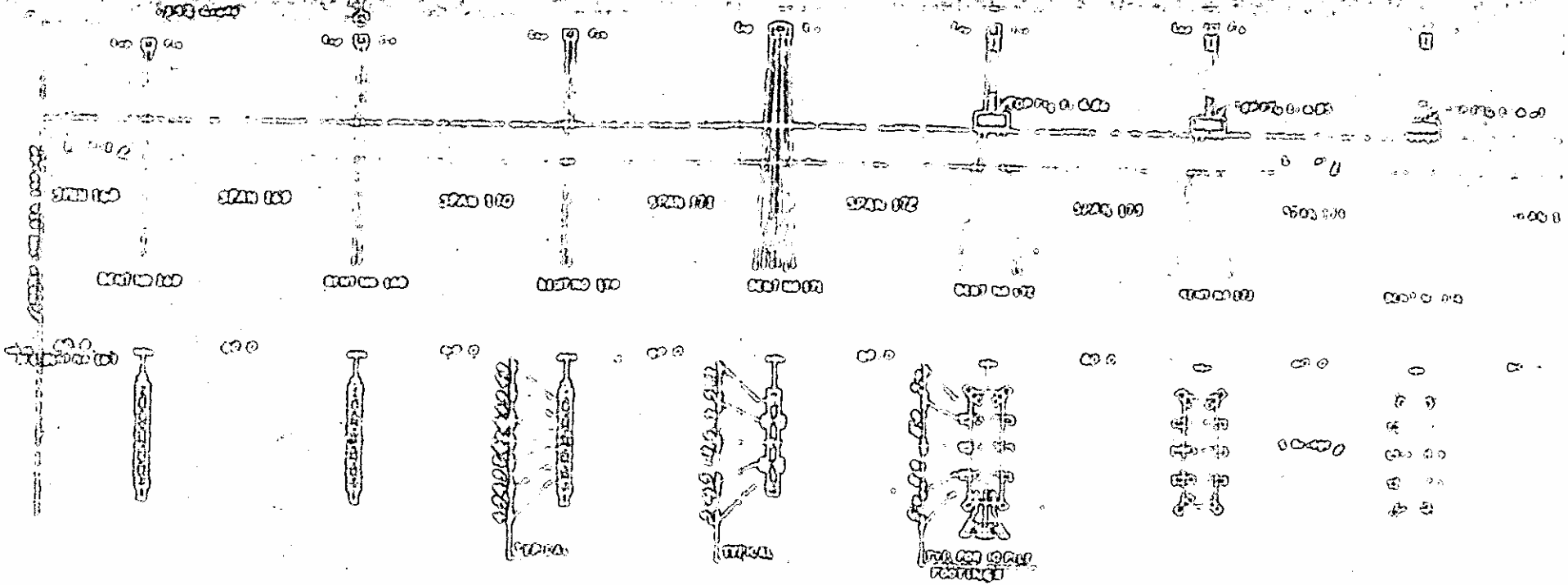

REVISED

DATE



STAS

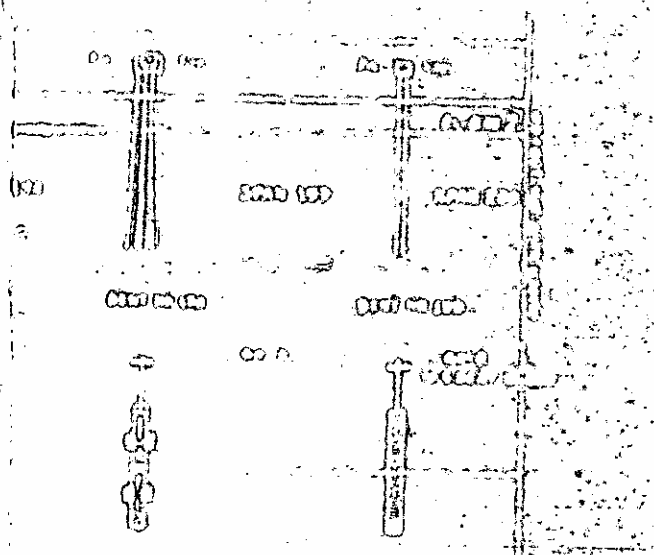
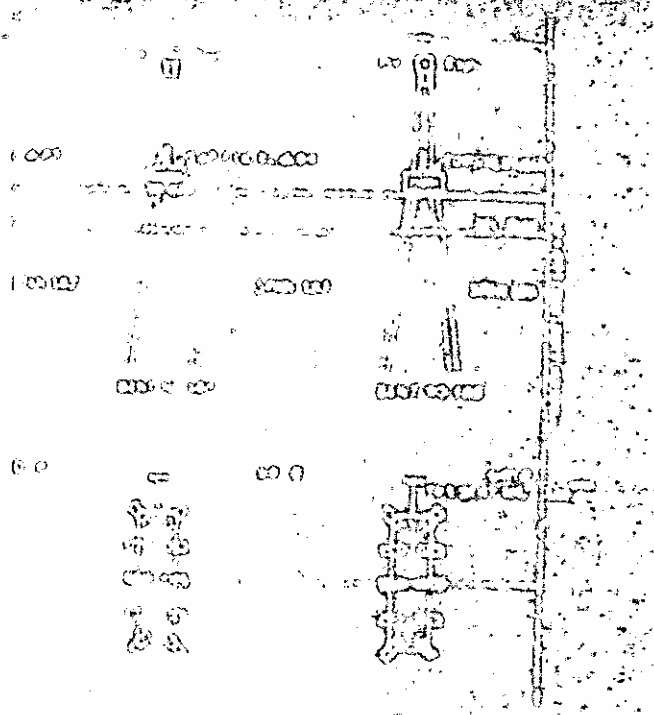

PROJECT NO. 11111
 CURRIWUCK - DARR CO.
 STATION 111111

STATE OF NEW YORK
 STATE ENGINEERING
 GENERAL DRAWING
 FOR
 BRIDGE OVER
 CURRIWUCK SOUND

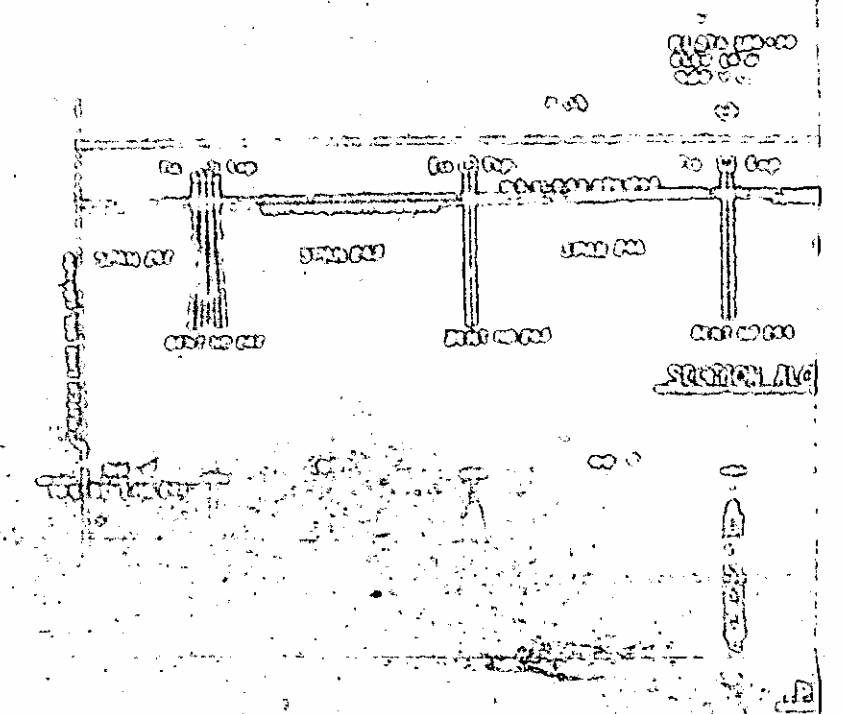
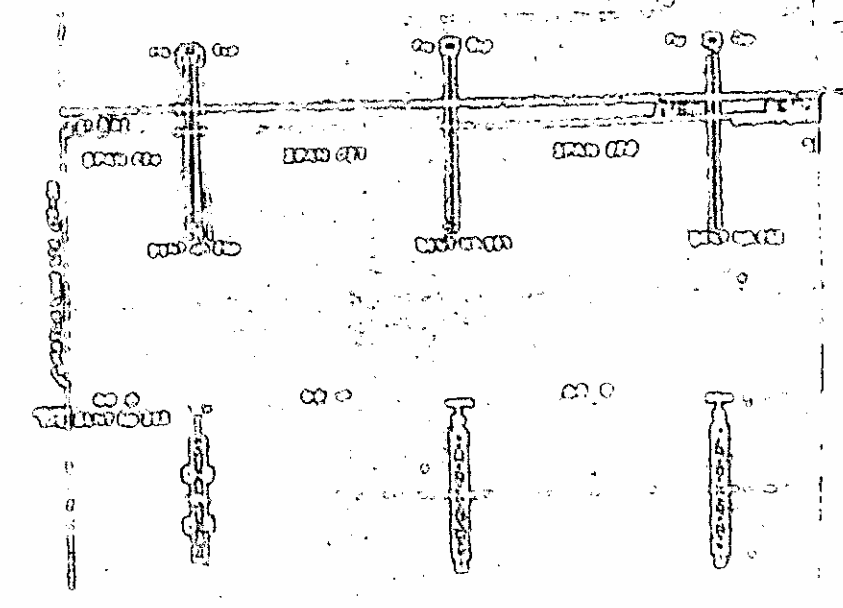
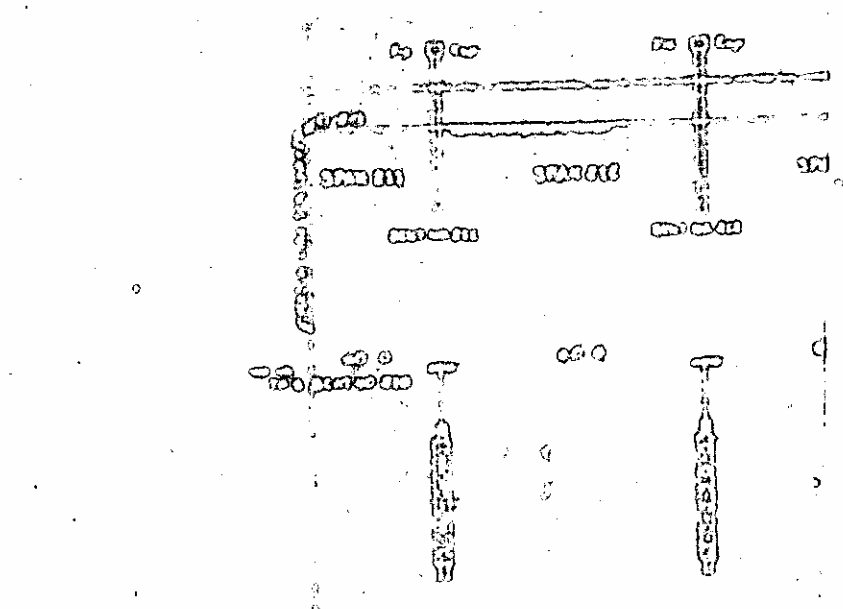

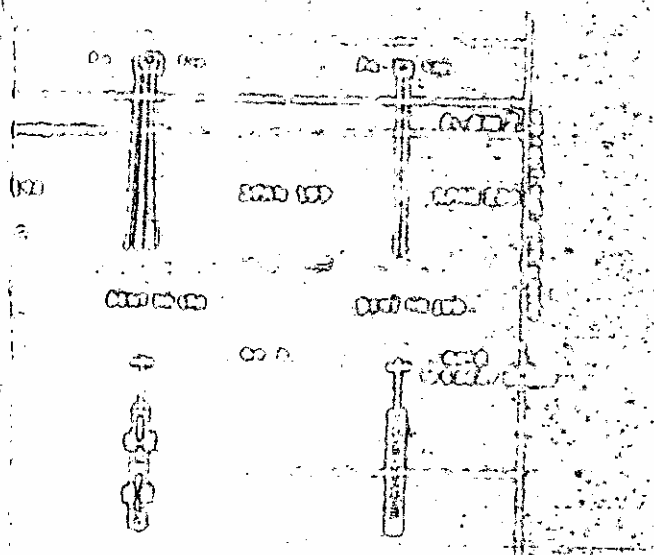
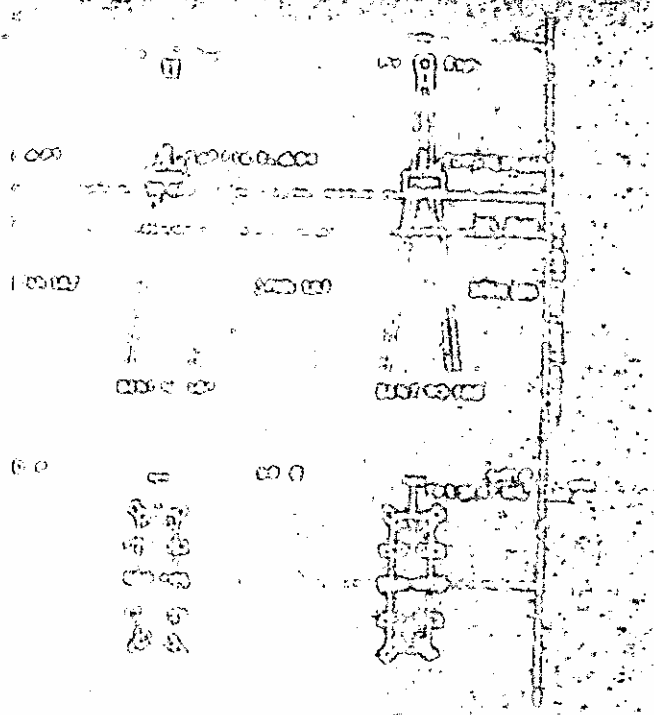

PROJECT NO. 1111
 CURRIEUCK - DARE CO.
 STATION 107+00

STATE OF NORTH CAROLINA
 STATE ENGINEERING
 GENERAL DIVISION
 FOR
 BRIDGE OVER
 CURRIEUCK SOUND

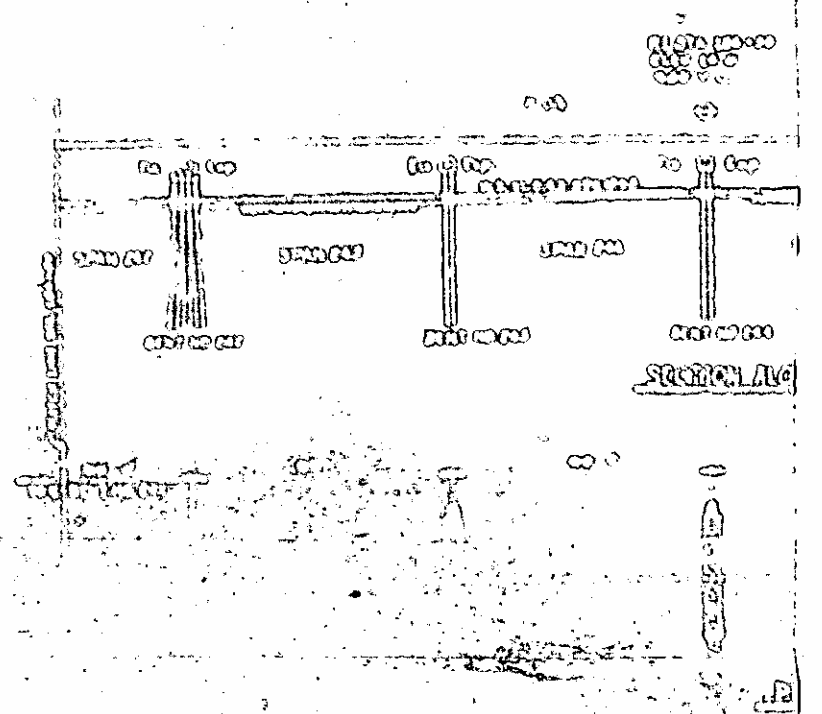
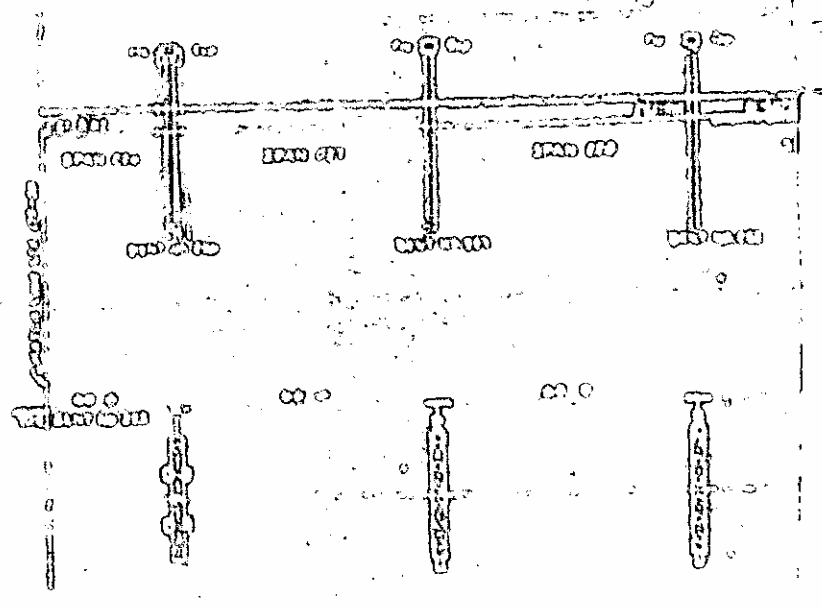
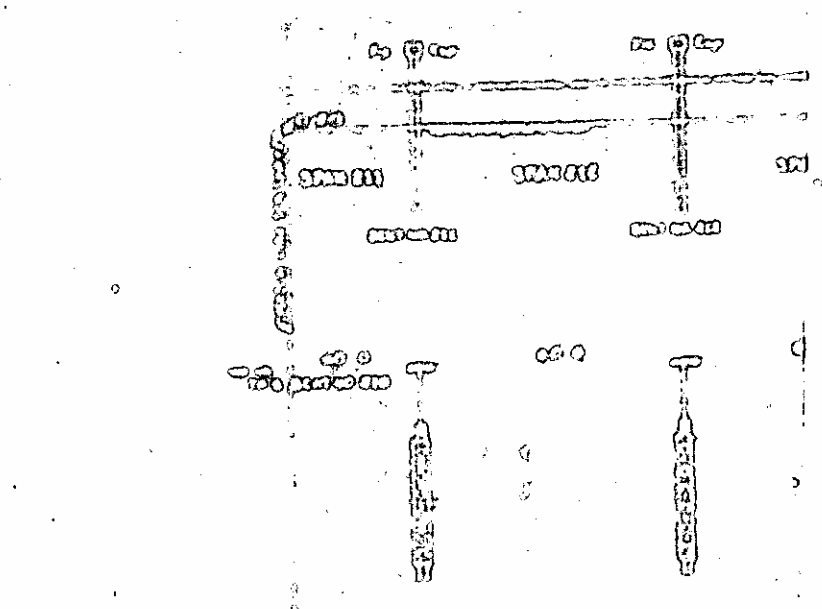

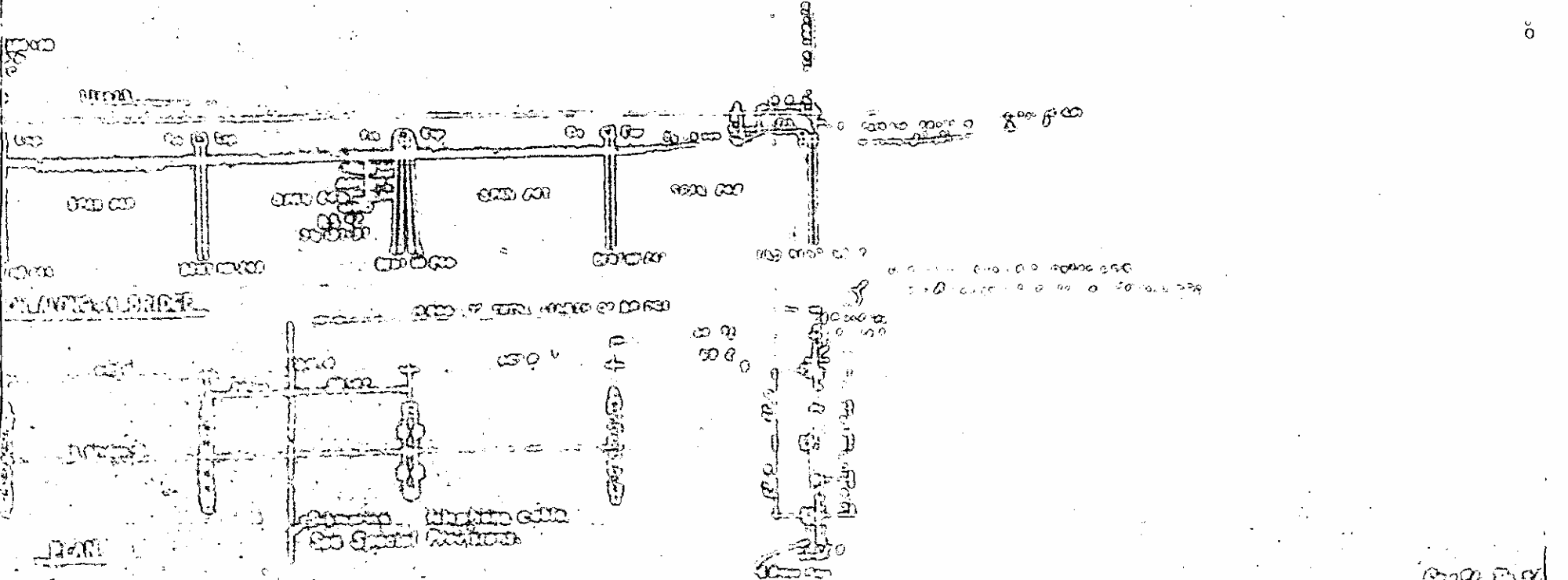
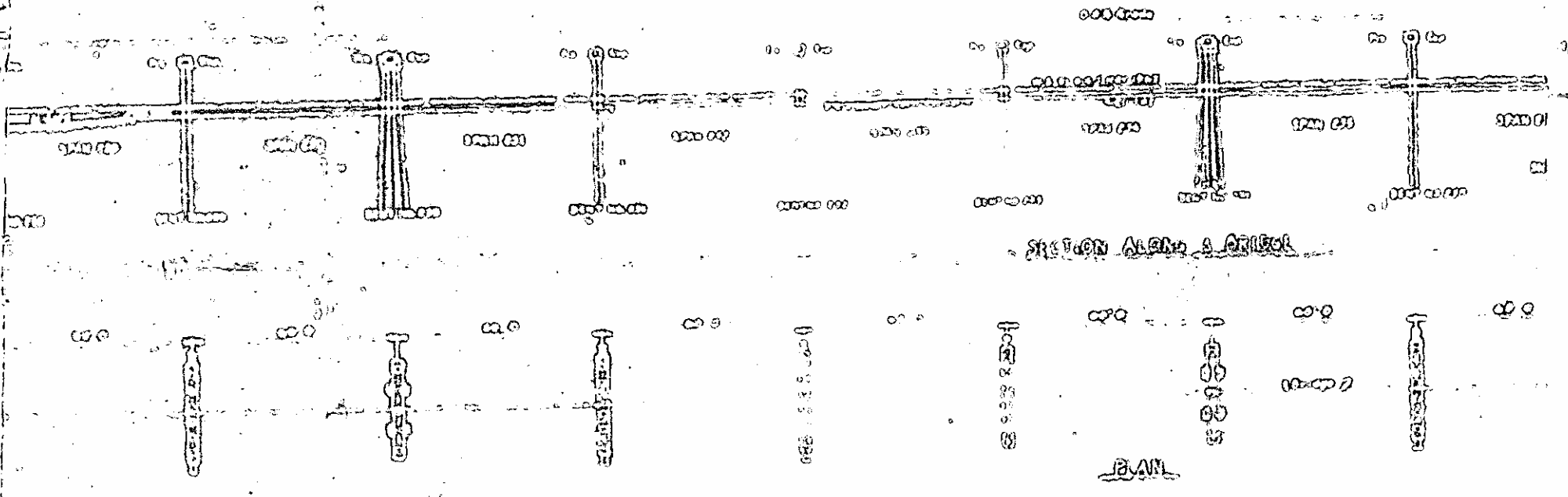
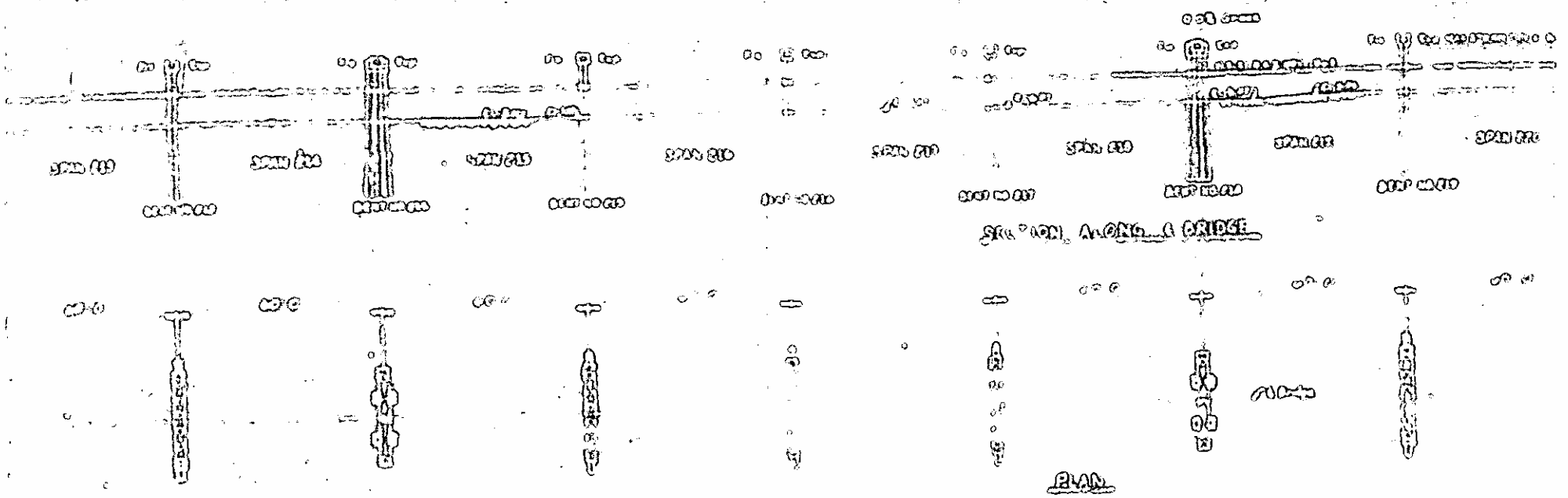

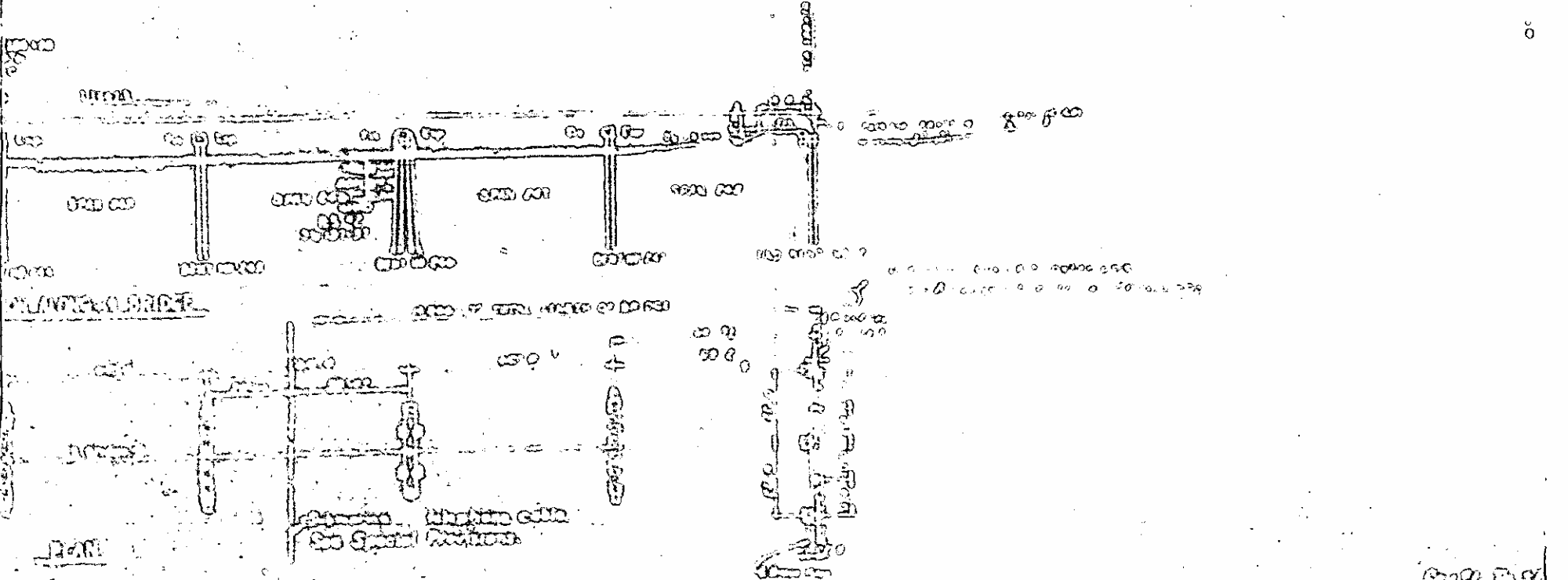
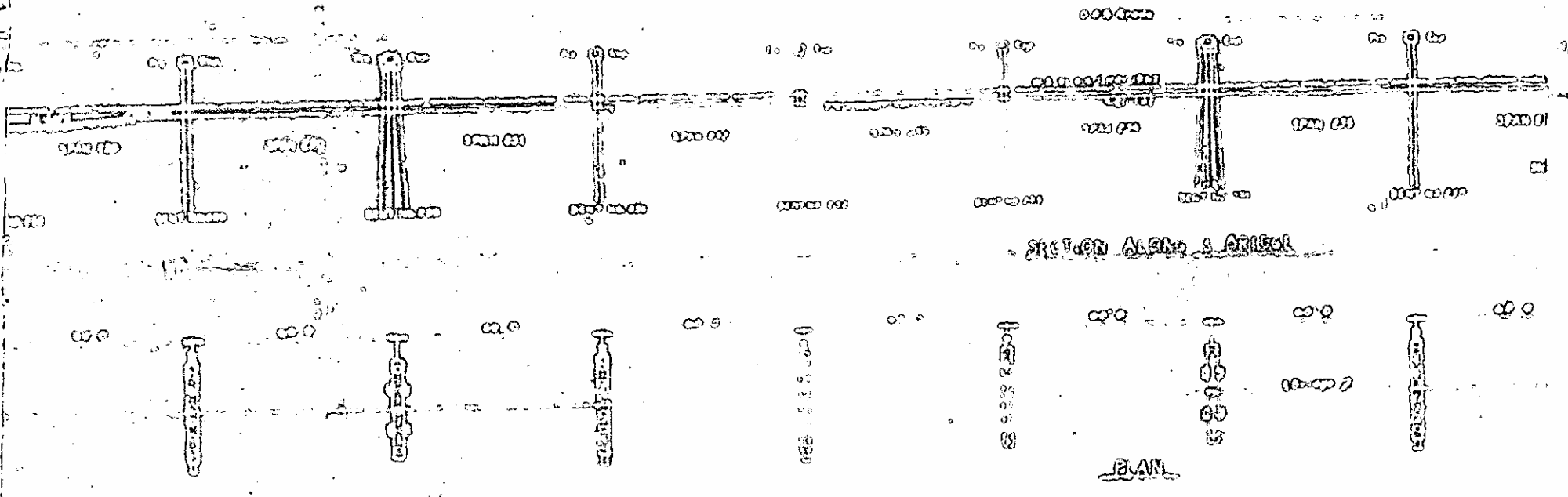
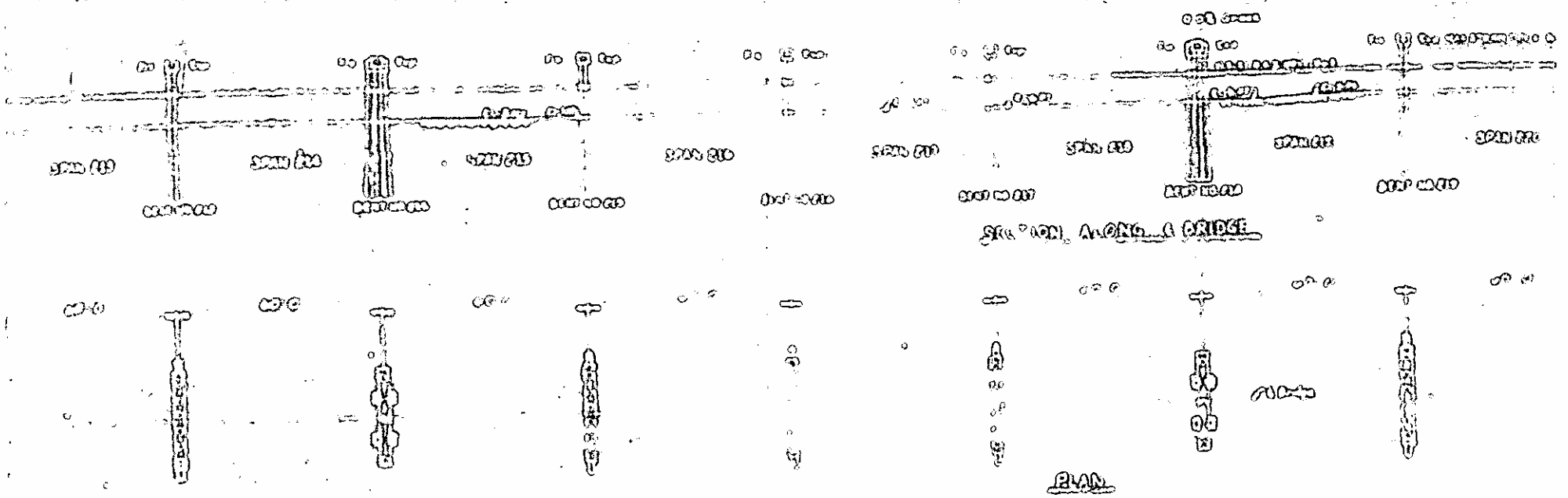

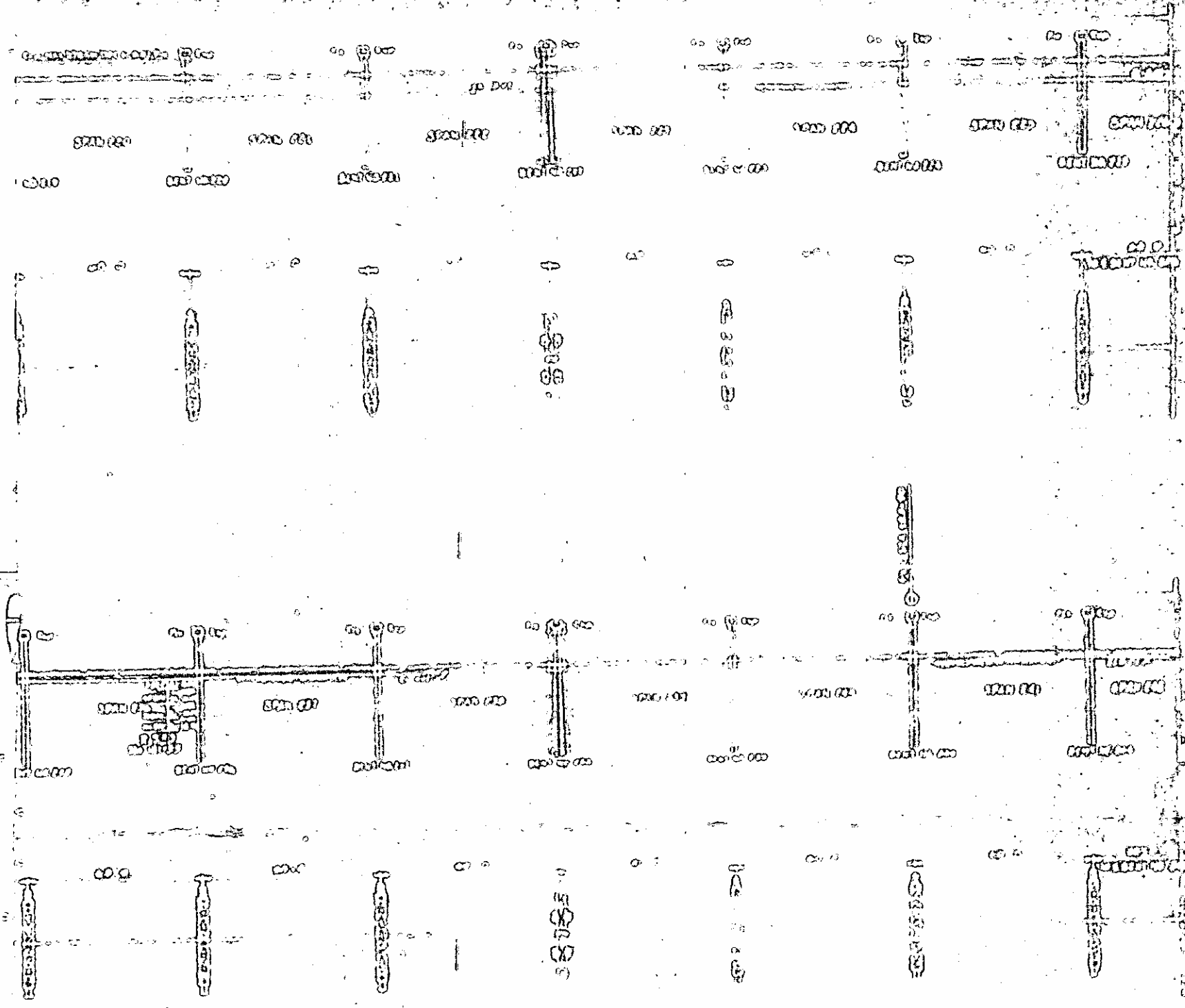

PROJECT No. 0 11127

STATE HIGHWAY COMMISSION

STATION 10+00

DATE 04 0 02 0

STATE OF NORTH CAROLINA
STATE HIGHWAY COMMISSION
 Raleigh

GENERAL DRAWING
 1927
 BRIDGE OVER
 CUPERTINO SOUND
 CUPERTINO

1927 State Highway Commission Raleigh N.C.

TOTAL BILL OF MATERIAL

QTY	DESCRIPTION	UNIT	QTY	DESCRIPTION	UNIT	QTY	DESCRIPTION	UNIT	QTY	DESCRIPTION	UNIT	QTY	DESCRIPTION	UNIT	QTY	DESCRIPTION	UNIT
100	Concrete	cu yd	100	Concrete	cu yd	100	Concrete	cu yd	100	Concrete	cu yd	100	Concrete	cu yd	100	Concrete	cu yd
100	Rebar	lb	100	Rebar	lb	100	Rebar	lb	100	Rebar	lb	100	Rebar	lb	100	Rebar	lb
100	Formwork	sq ft	100	Formwork	sq ft	100	Formwork	sq ft	100	Formwork	sq ft	100	Formwork	sq ft	100	Formwork	sq ft
100	Gravel	cu yd	100	Gravel	cu yd	100	Gravel	cu yd	100	Gravel	cu yd	100	Gravel	cu yd	100	Gravel	cu yd
100	Sand	cu yd	100	Sand	cu yd	100	Sand	cu yd	100	Sand	cu yd	100	Sand	cu yd	100	Sand	cu yd
100	Water	gal	100	Water	gal	100	Water	gal	100	Water	gal	100	Water	gal	100	Water	gal
100	Oil	gal	100	Oil	gal	100	Oil	gal	100	Oil	gal	100	Oil	gal	100	Oil	gal
100	Admixture	lb	100	Admixture	lb	100	Admixture	lb	100	Admixture	lb	100	Admixture	lb	100	Admixture	lb
100	Form Release	lb	100	Form Release	lb	100	Form Release	lb	100	Form Release	lb	100	Form Release	lb	100	Form Release	lb
100	Other	lb	100	Other	lb	100	Other	lb	100	Other	lb	100	Other	lb	100	Other	lb

NOTES

H20-516

1. All quantities are based on the design drawings and specifications.

2. The quantities are subject to change based on field conditions and engineering judgment.

3. The quantities are for the entire project and do not include any contingencies.

4. The quantities are based on the current market prices and are subject to change.

Reported for the project, the quantities are based on the design drawings and specifications.

General notes regarding the quantities and the project details.

QTY	DESCRIPTION	UNIT	QTY	DESCRIPTION	UNIT
100	Concrete	cu yd	100	Concrete	cu yd
100	Rebar	lb	100	Rebar	lb
100	Formwork	sq ft	100	Formwork	sq ft
100	Gravel	cu yd	100	Gravel	cu yd
100	Sand	cu yd	100	Sand	cu yd
100	Water	gal	100	Water	gal
100	Oil	gal	100	Oil	gal
100	Admixture	lb	100	Admixture	lb
100	Form Release	lb	100	Form Release	lb
100	Other	lb	100	Other	lb

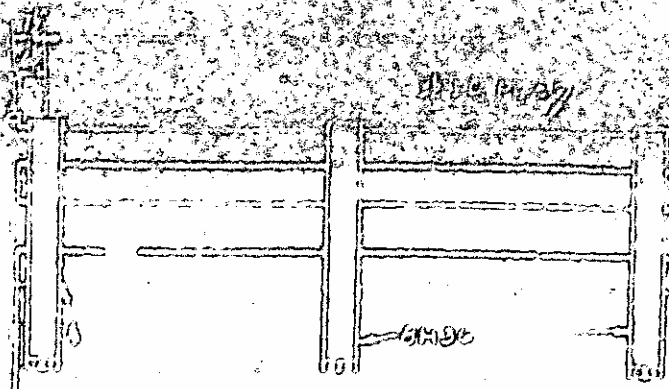

ELEVATION

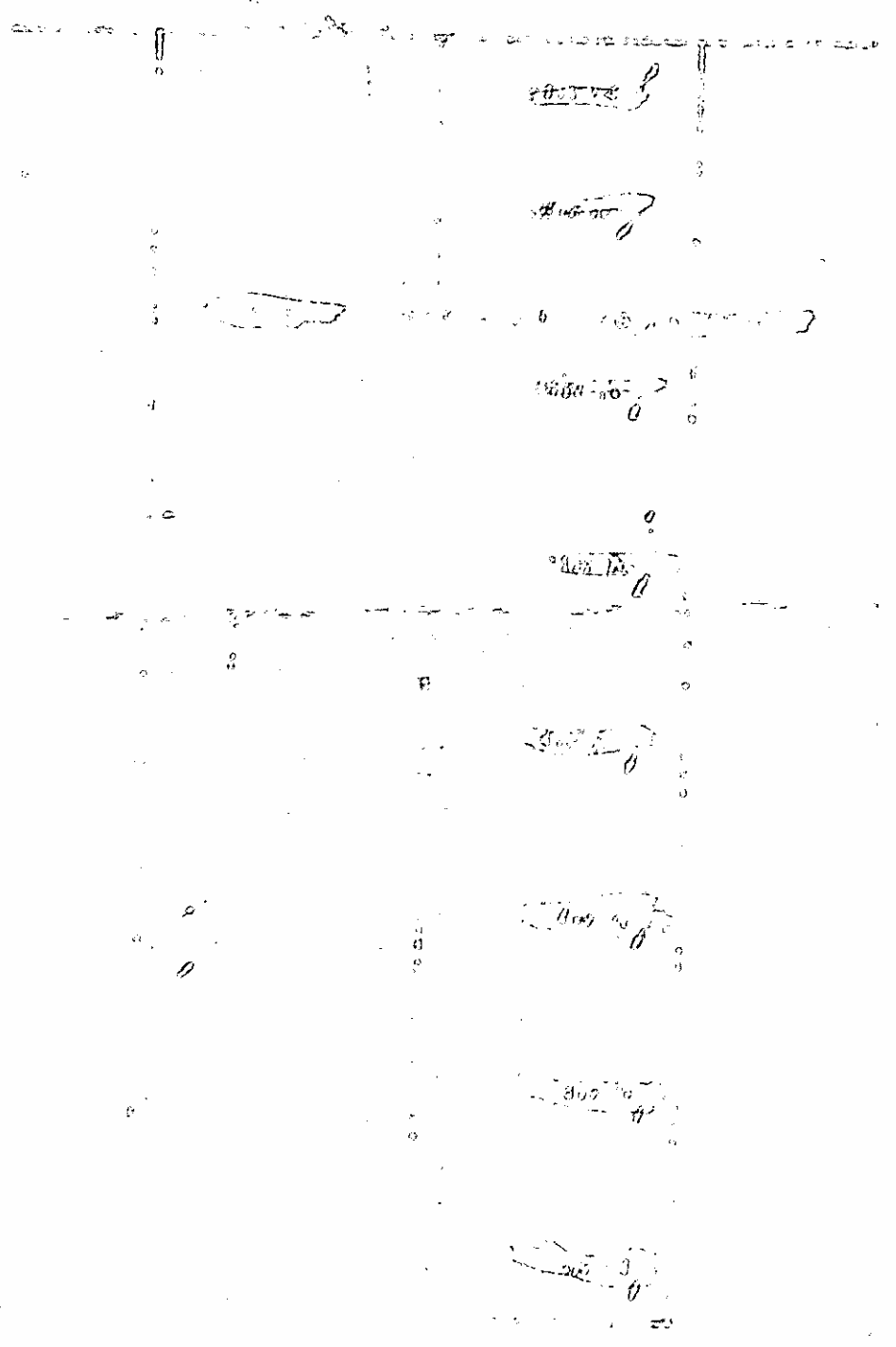
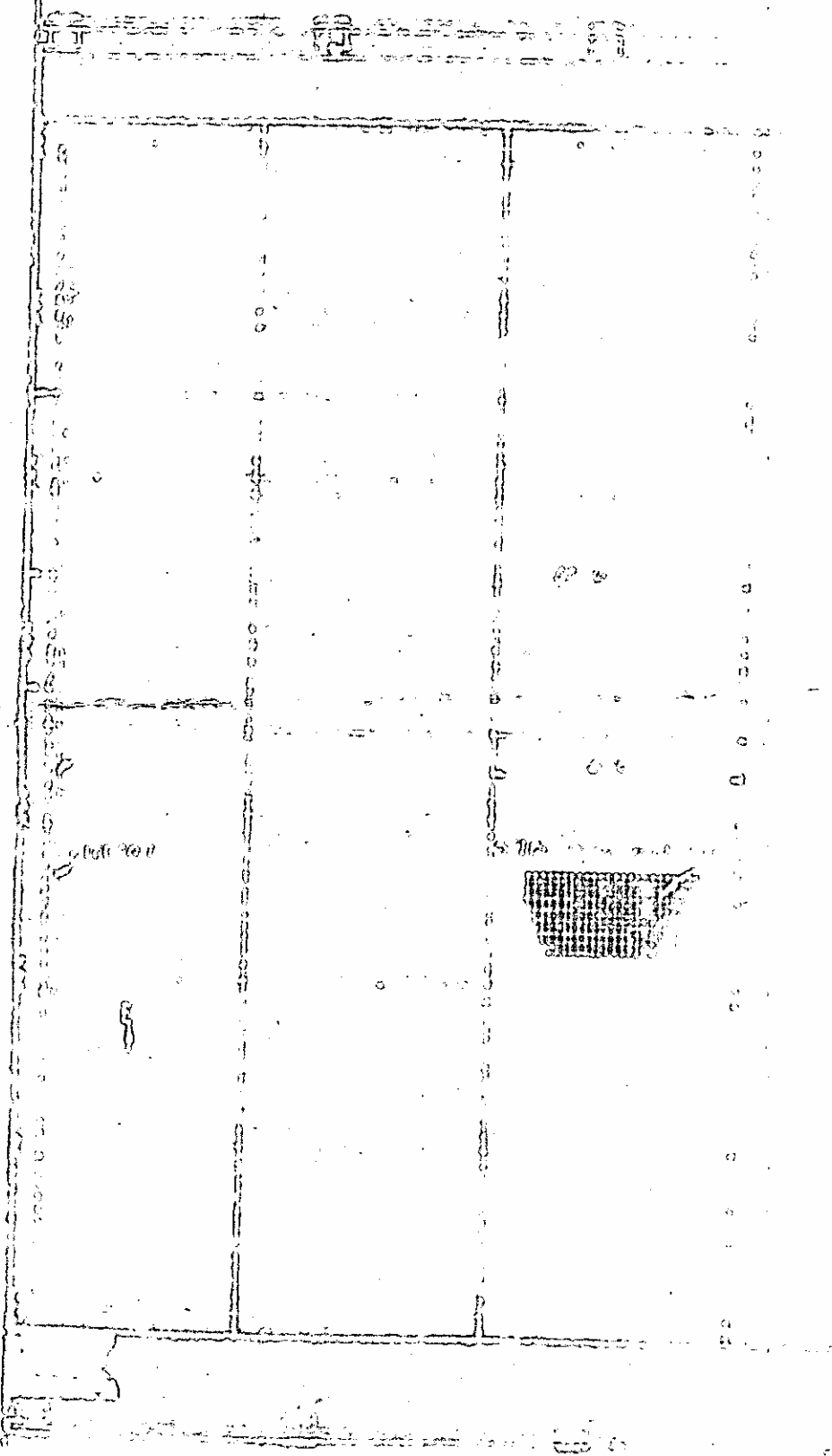

DATE	BY	NO.

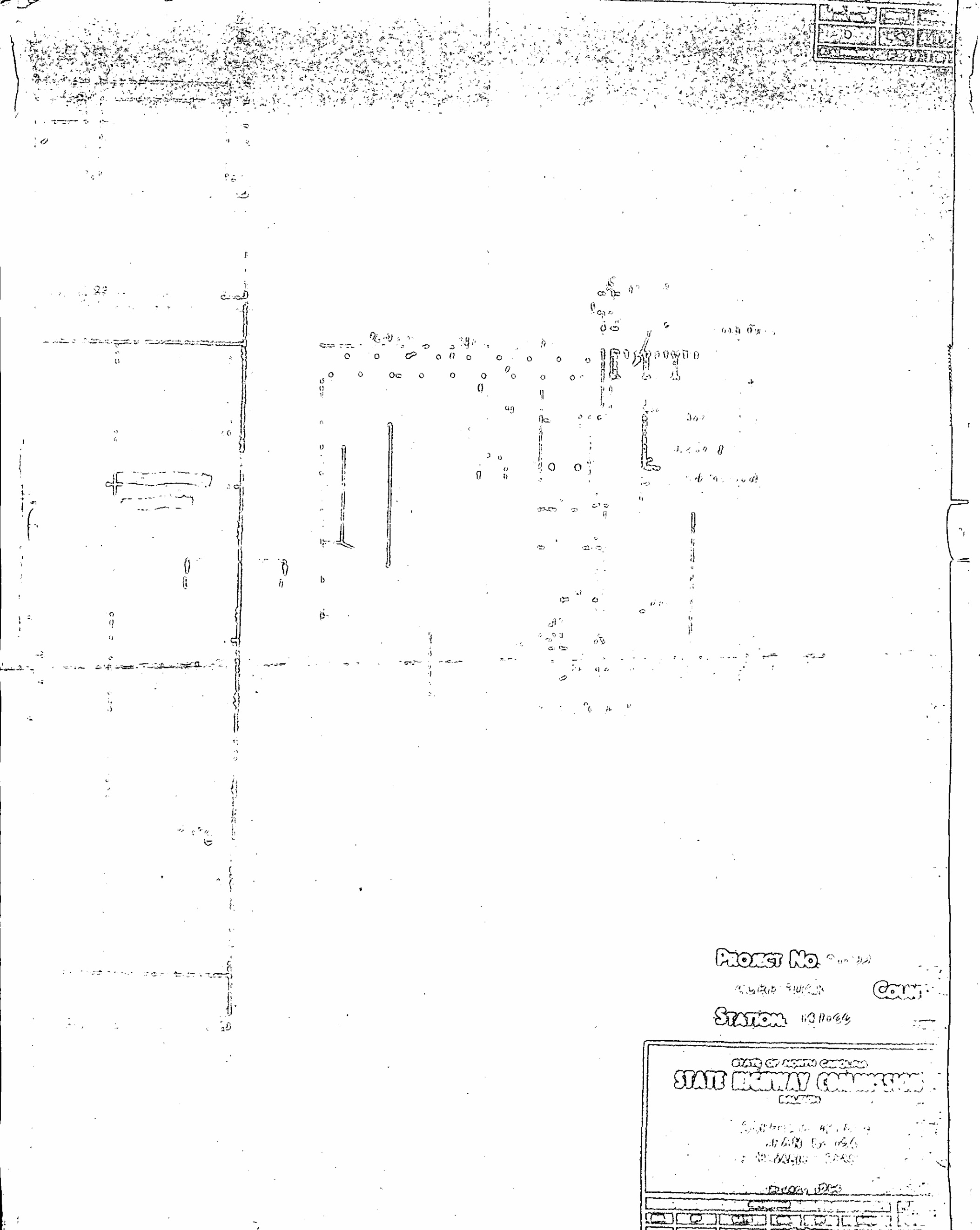

PROJECT No. 000000

10/12/10 5/10/11

CONTRACT

STATION 10+00.00

STATE OF NORTH CAROLINA
STATE HIGHWAY COMMISSION
 DIVISION OF HIGHWAYS

APPROVED FOR THE STATE HIGHWAY COMMISSION
 DATE 10/12/10 BY 10/12/10
 PROJECT NO. 000000

DESIGNED BY
 DRAWN BY

DATE	BY	NO.

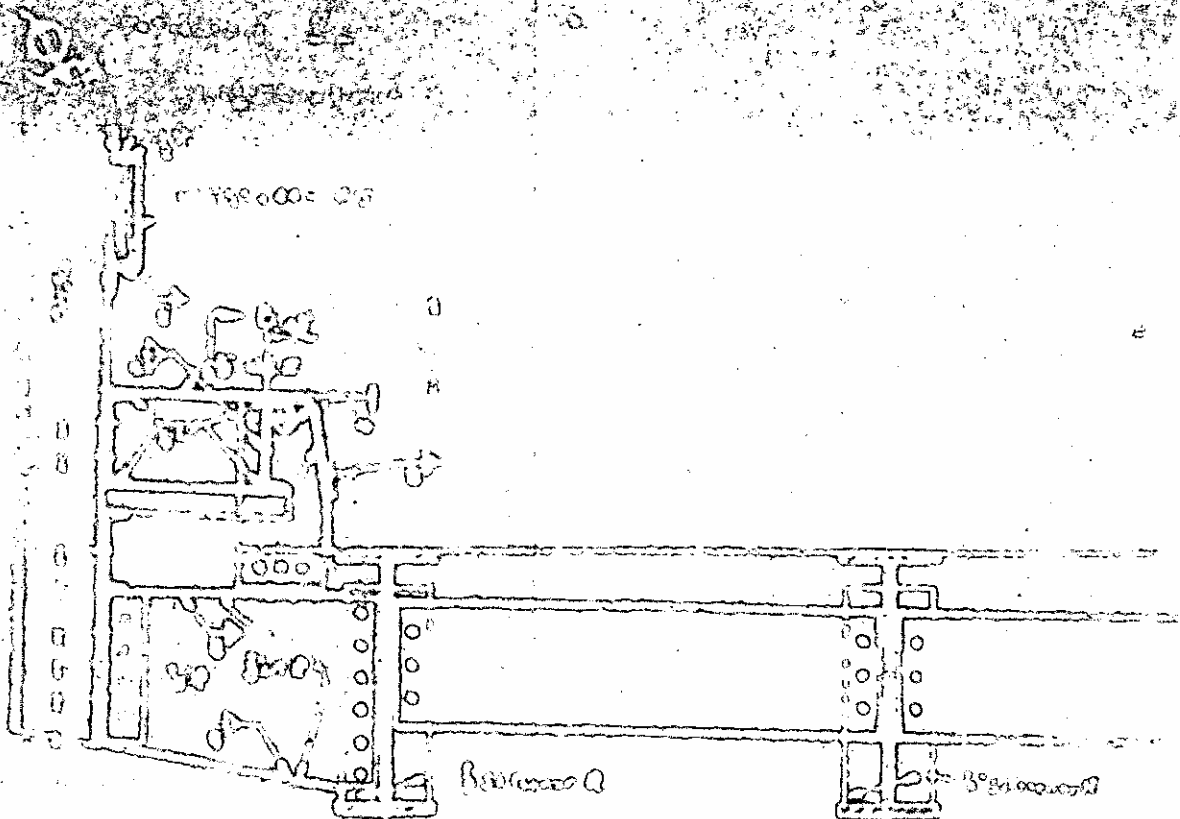

1-60
 Section line of ground floor
 (with stairs and other
 details as shown in
 section 1-60)

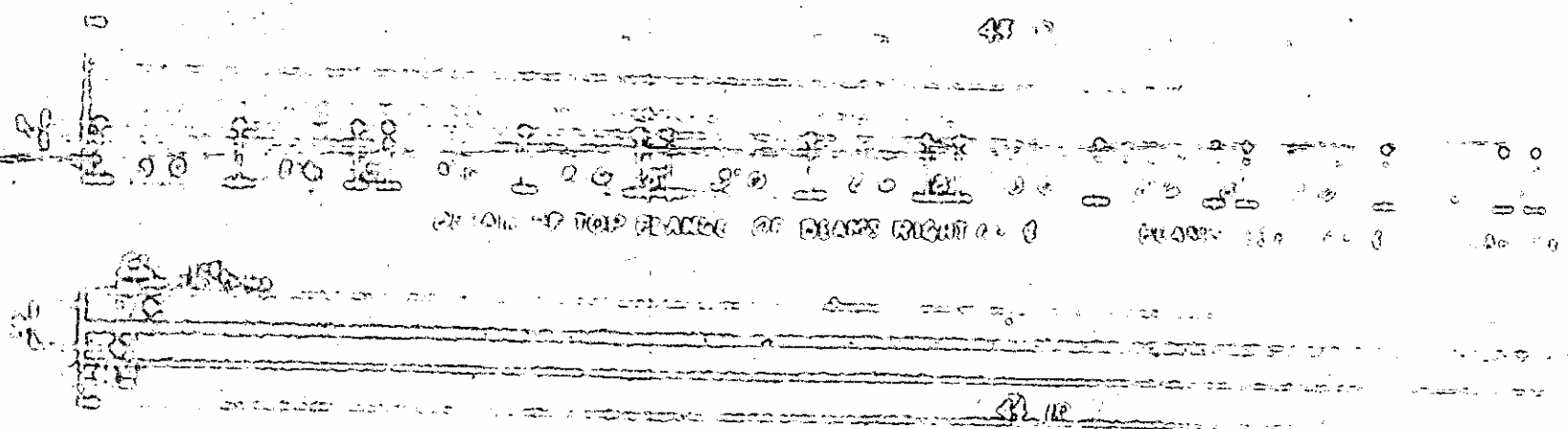

DETAIL OF BOTTOM FLOOR ALL FLOOR

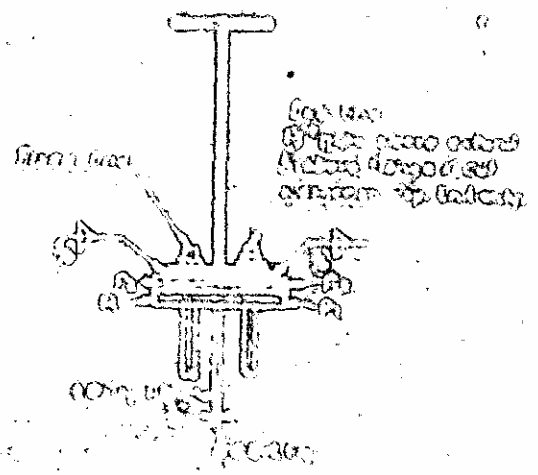

Section line
 of the
 ground floor
 (with stairs and
 other details as
 shown in section
 1-60)

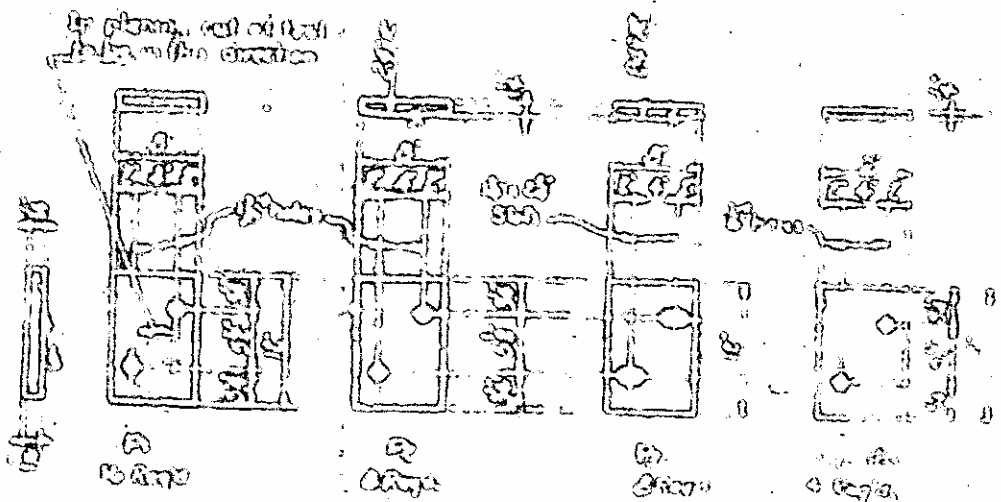

BEARING PLATE DETAILS
 (with stairs and other
 details as shown in
 section 1-60)

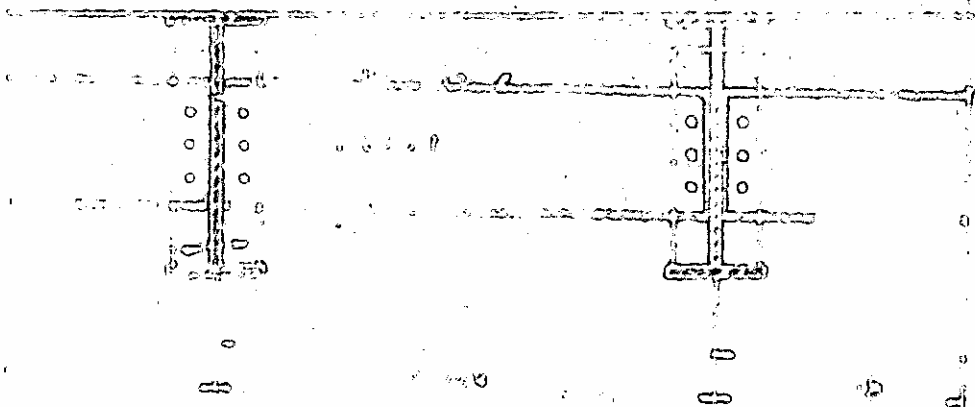

BEAM END

At the end of the beam...

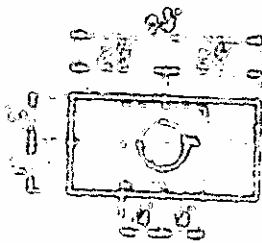
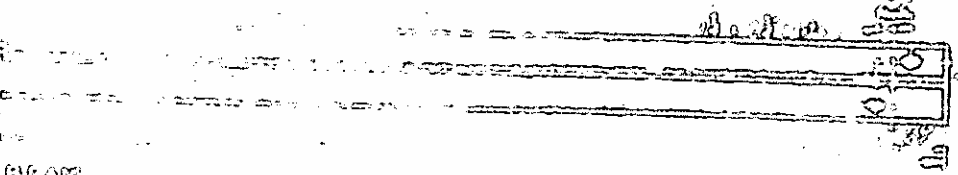
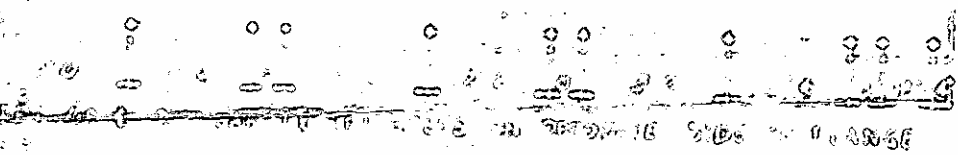

BEAM END

At the end of the beam...

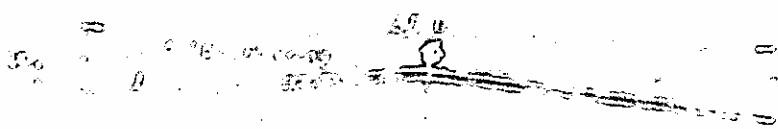

BEAM END

At the end of the beam...

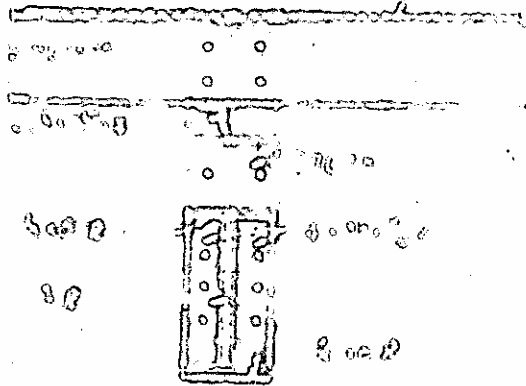

SECTION A

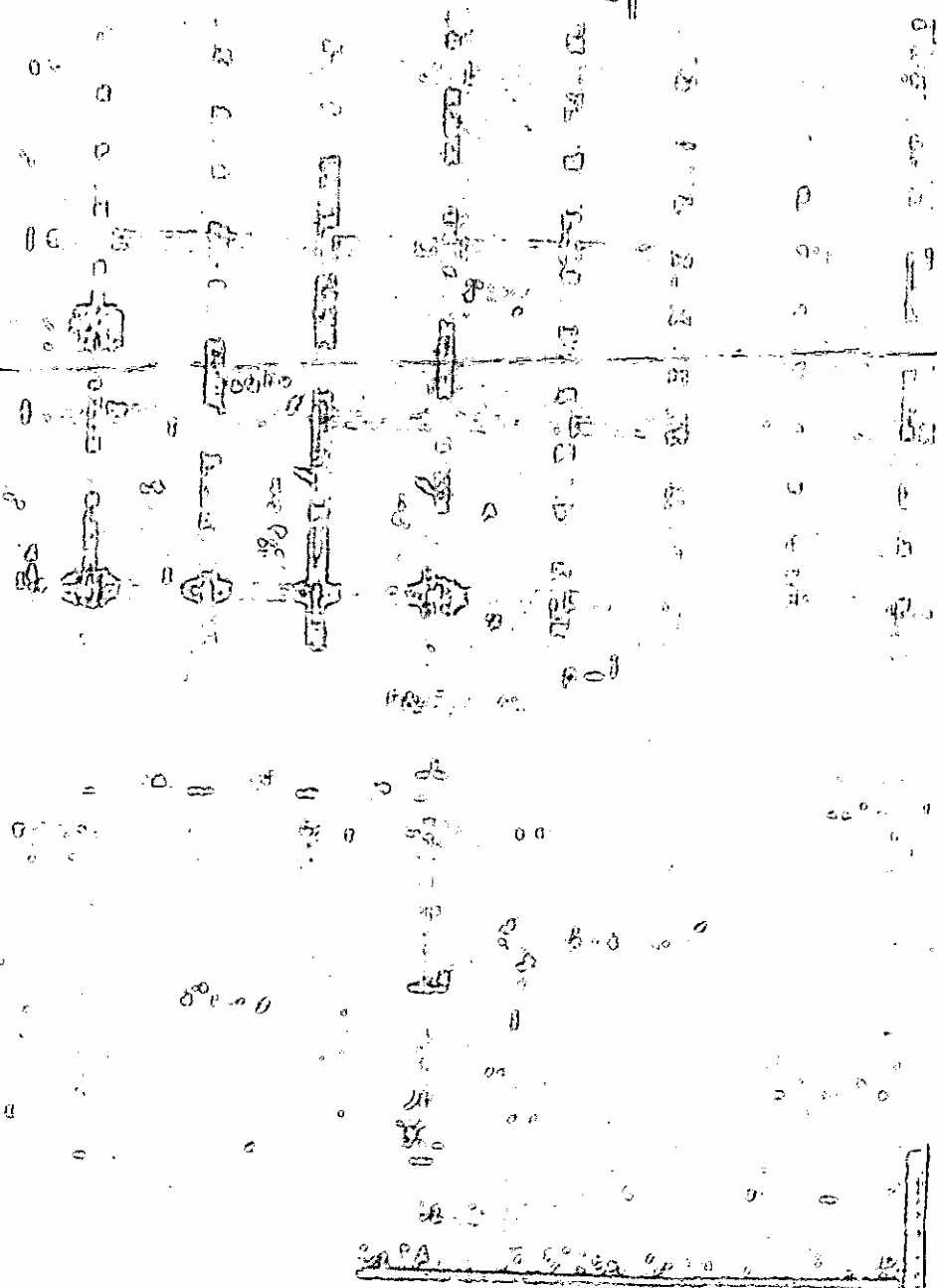

At the end of the beam...

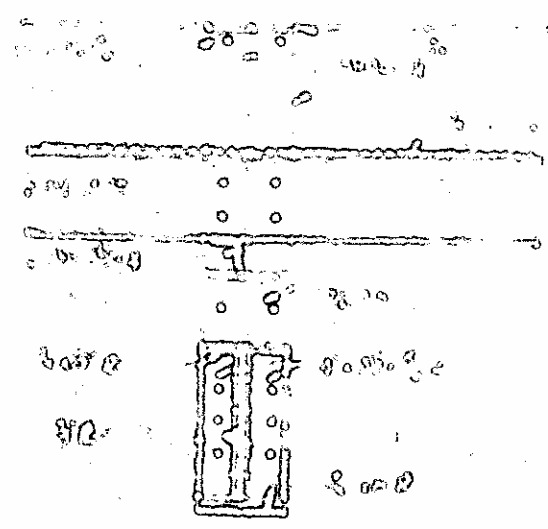

SECTION A-A

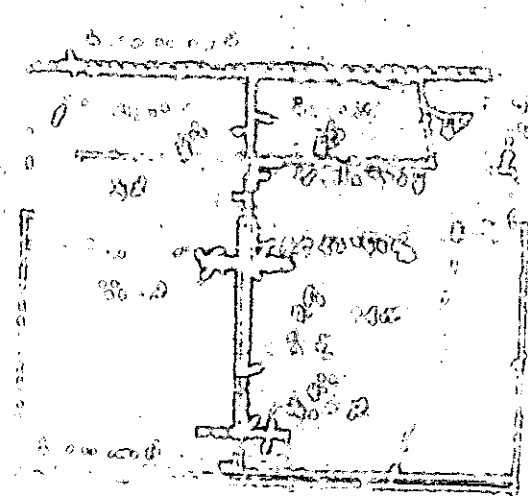

SECTION B-B

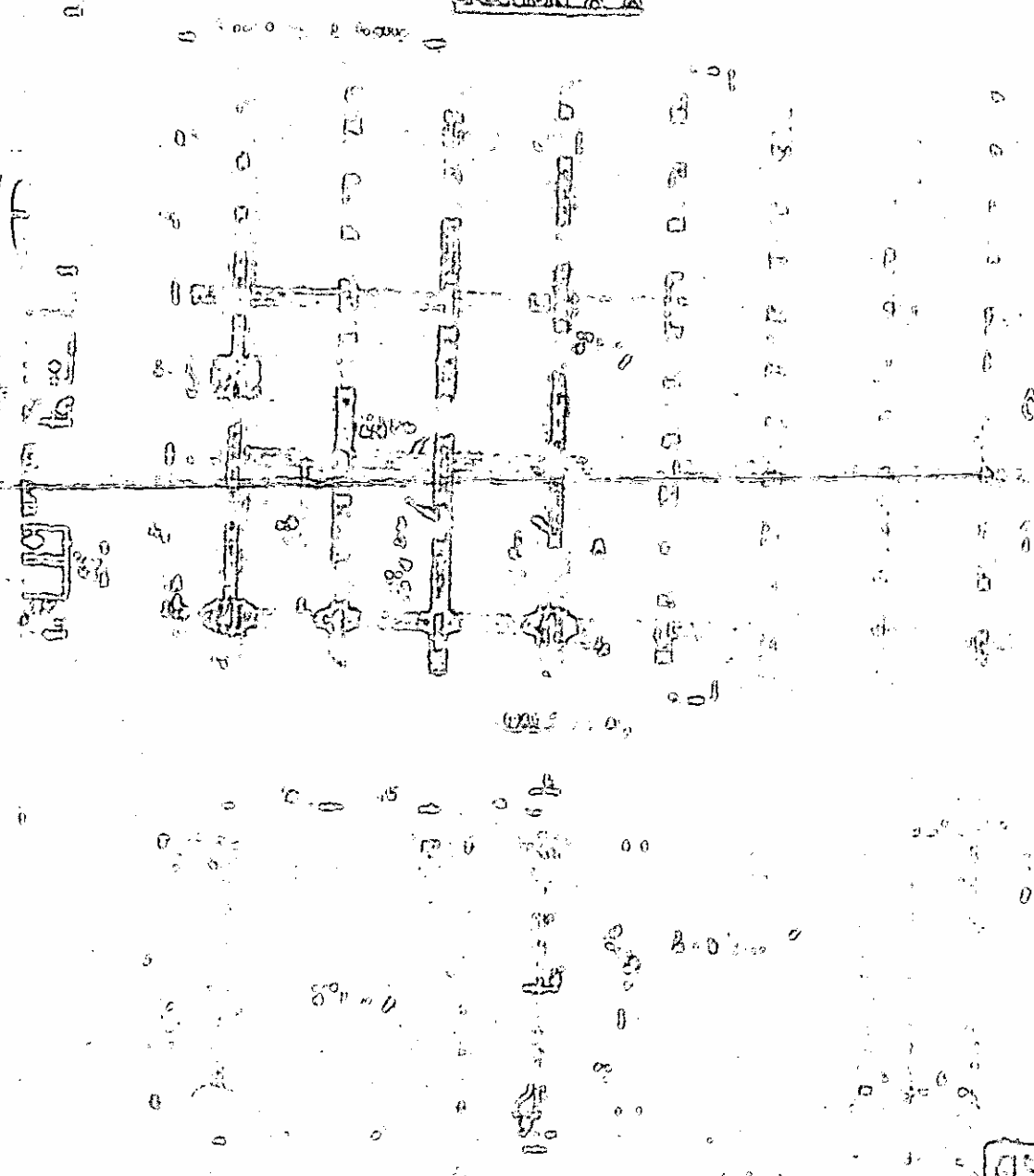

1. The design of the structure shall be based on the ultimate limit state design method.

2. The structure shall be designed to resist the following loads:

- Dead load (DL)
- Live load (LL)
- Wind load (WL)
- Seismic load (SL)

3. The structure shall be designed to resist the following actions:

- Temperature effects
- Shrinkage and creep
- Construction loads

4. The structure shall be designed to resist the following actions:

- Temperature effects
- Shrinkage and creep
- Construction loads

5. The structure shall be designed to resist the following actions:

- Temperature effects
- Shrinkage and creep
- Construction loads

SECTION C-C

