

INDEX OF CROSS SECTION SHEETS

-L1-	X-1 TO X-14
-L-	X-15 TO X-22
-RPA-	X-23 TO X-31
-RPB-	X-32 TO X-36
-RPC-	X-37 TO X-40
-RPD-	X-41 TO X-44
-Y1-	X-45 TO X-66
-Y2-	X-67 TO X-68
-Y3-	X-69 TO X-70
-DW1-	X-71 TO X-72
-RPC_DET-	X-73 TO X-75
-RPD_DET-	X-76 TO X-77

Note: "Quantities are approximate only.
The Resident Engineer will
re-cross-section the work accurately
when the project is staked out. These
cross-section notes will be used in
computing the final quantities for
which the contractor will be paid."

150 140 130 120 110 100 90 80 70 60 50 40 30 20 10 0 10 20 30 40 50 60 70 80 90 100 110 120 130 140 150

- SHALLOW UNDERCUT
- UNCLASSIFIED EXCAVATION ACCEPTABLE
- UNSUITABLE UNCLASSIFIED EXCAVATION

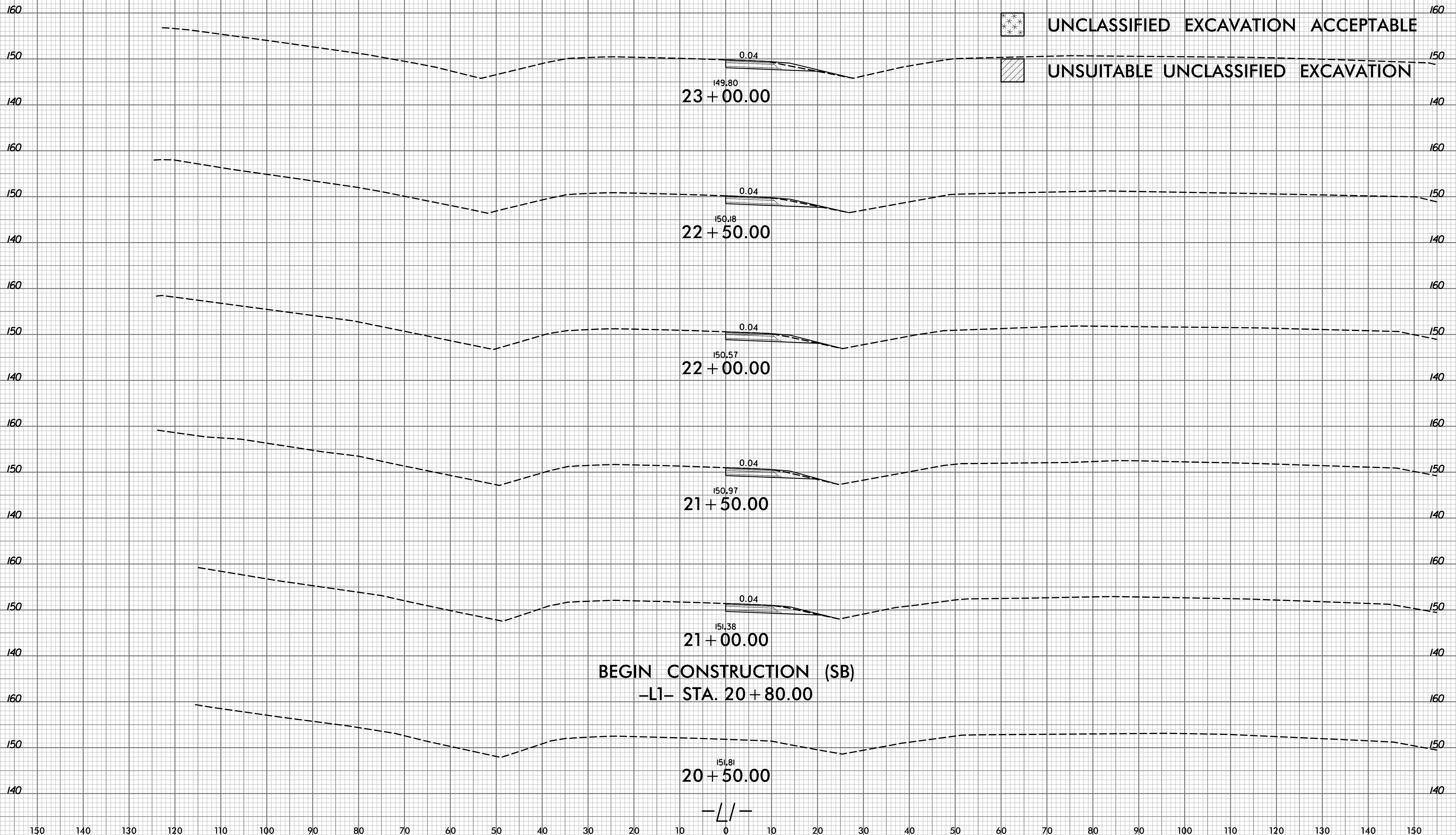

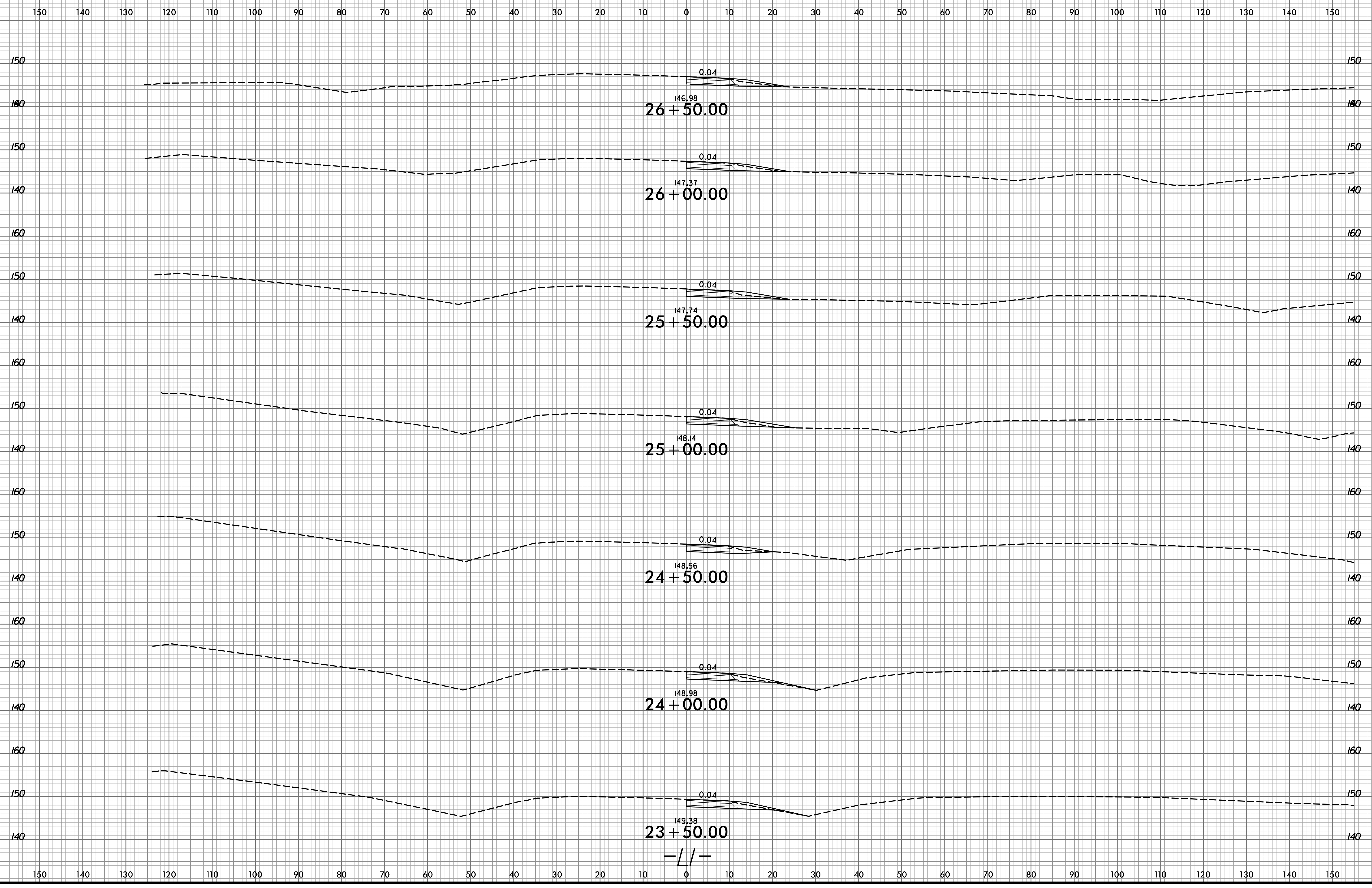

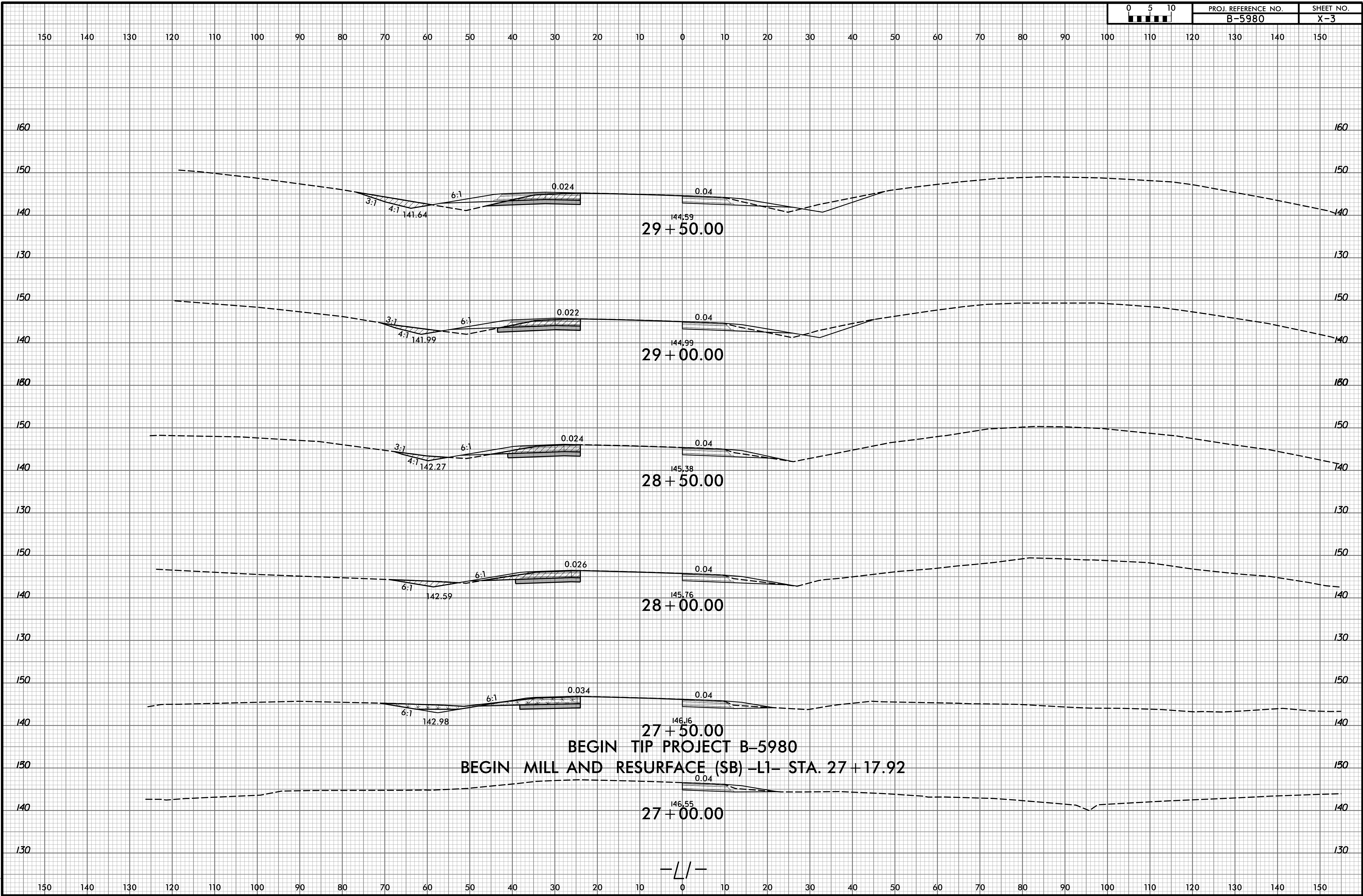

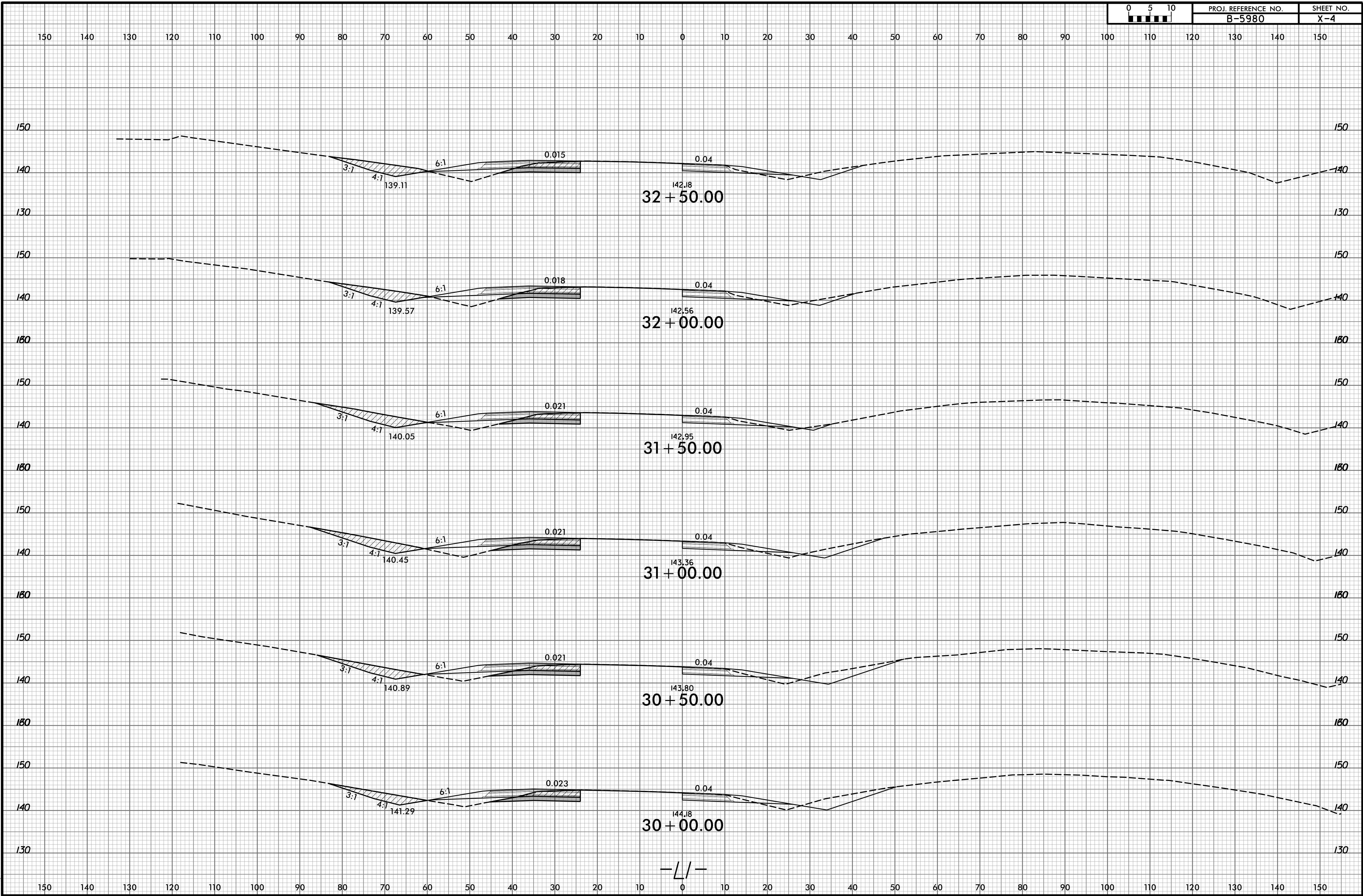

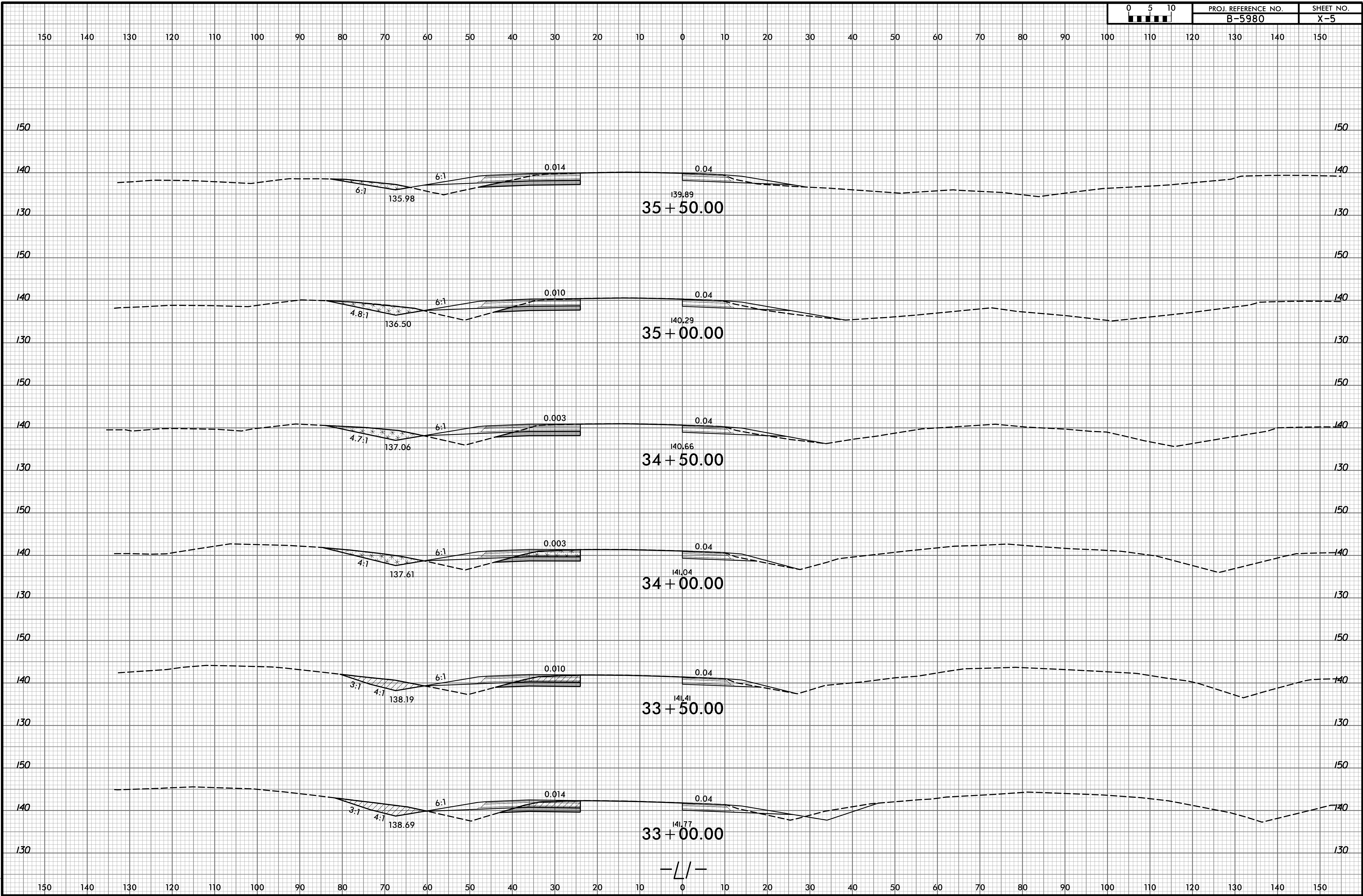

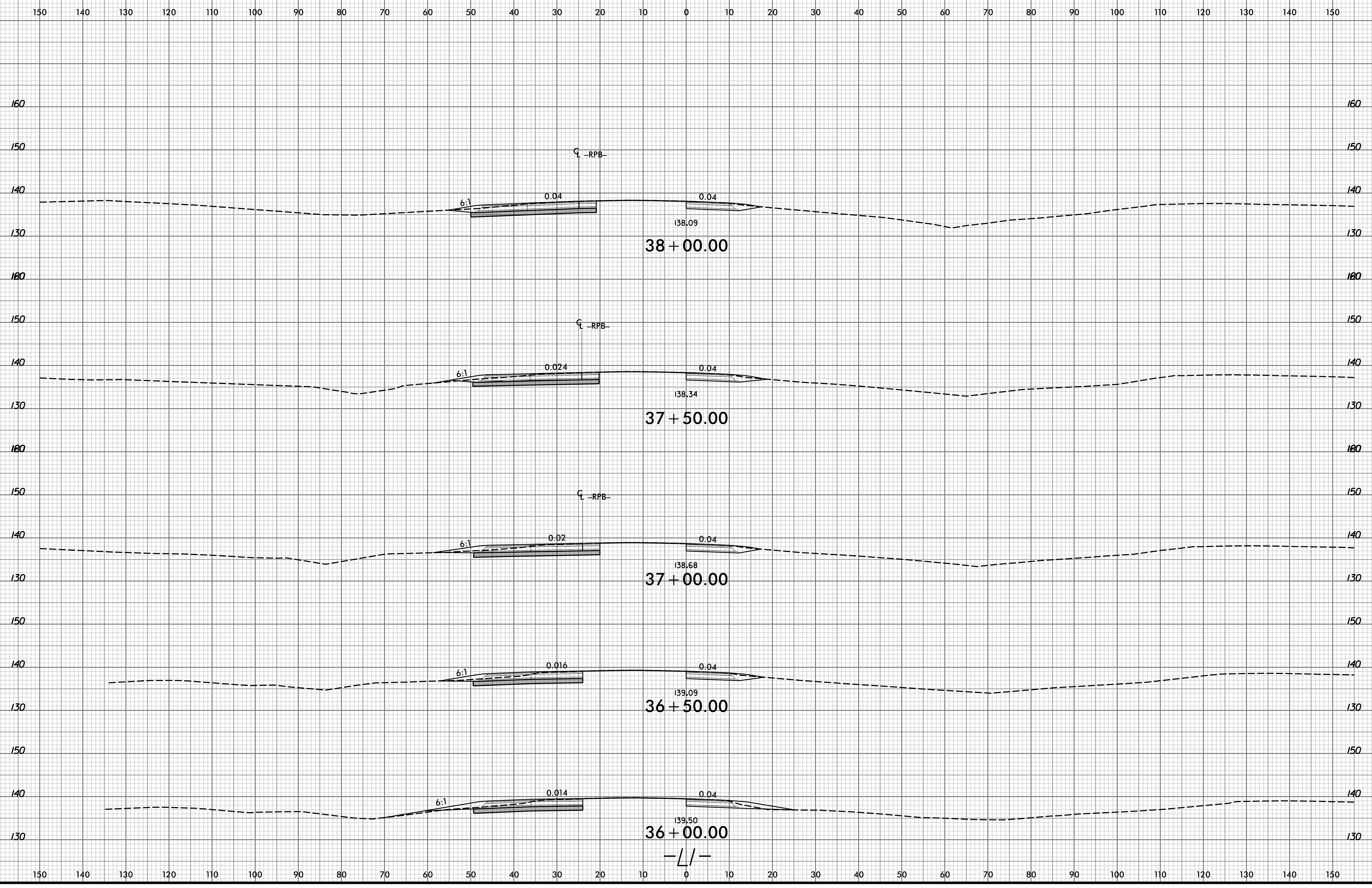

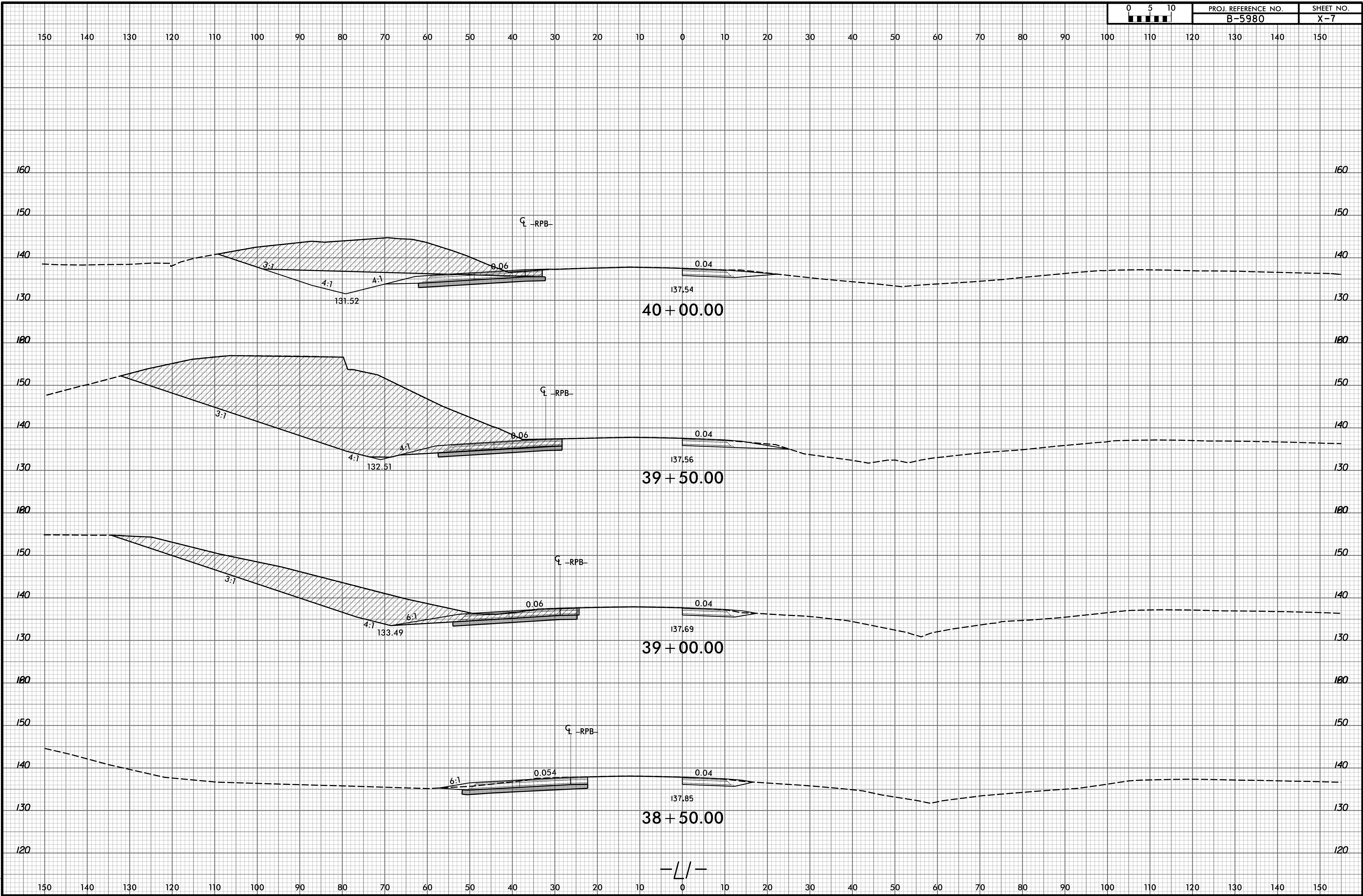

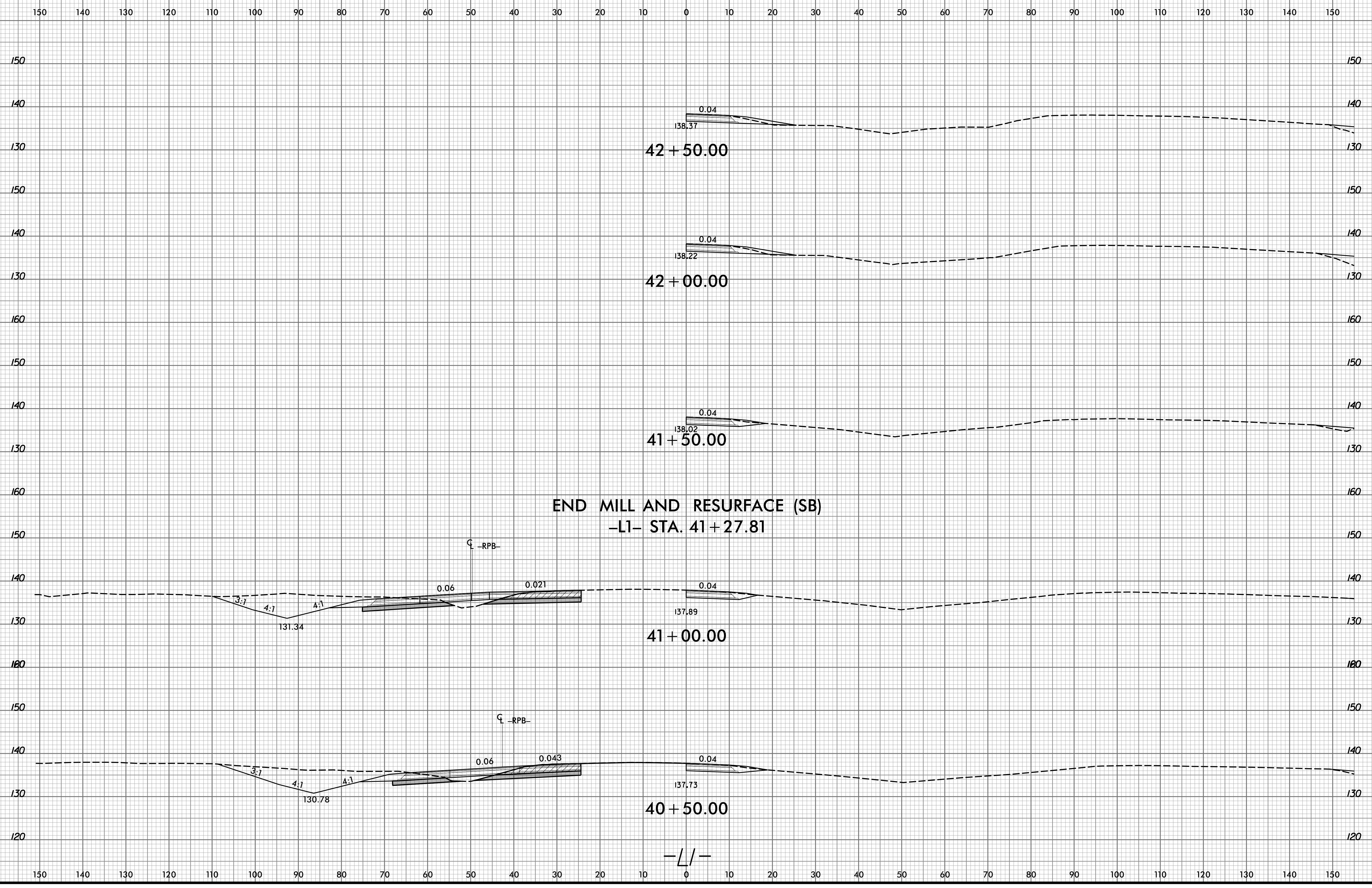

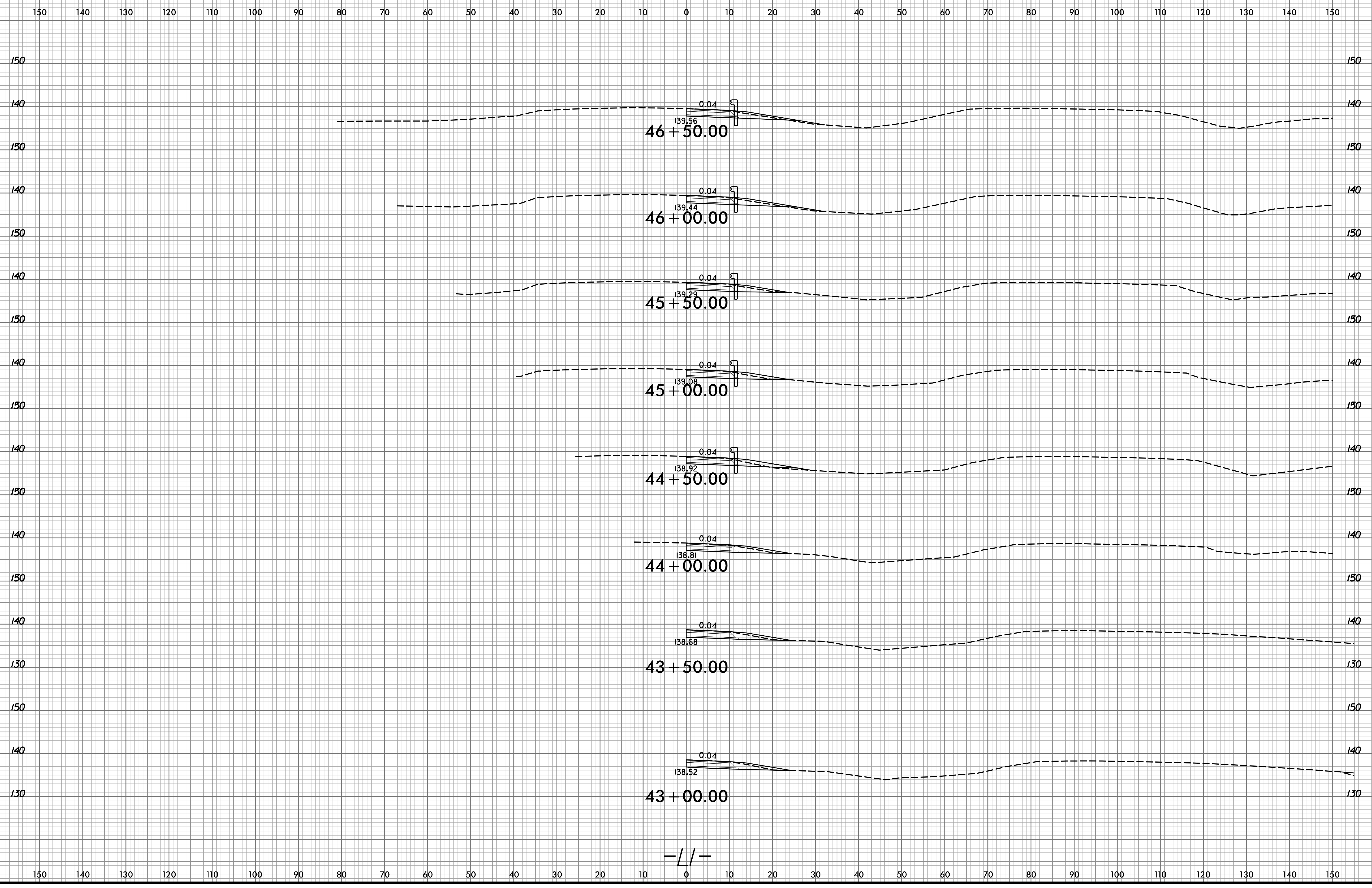

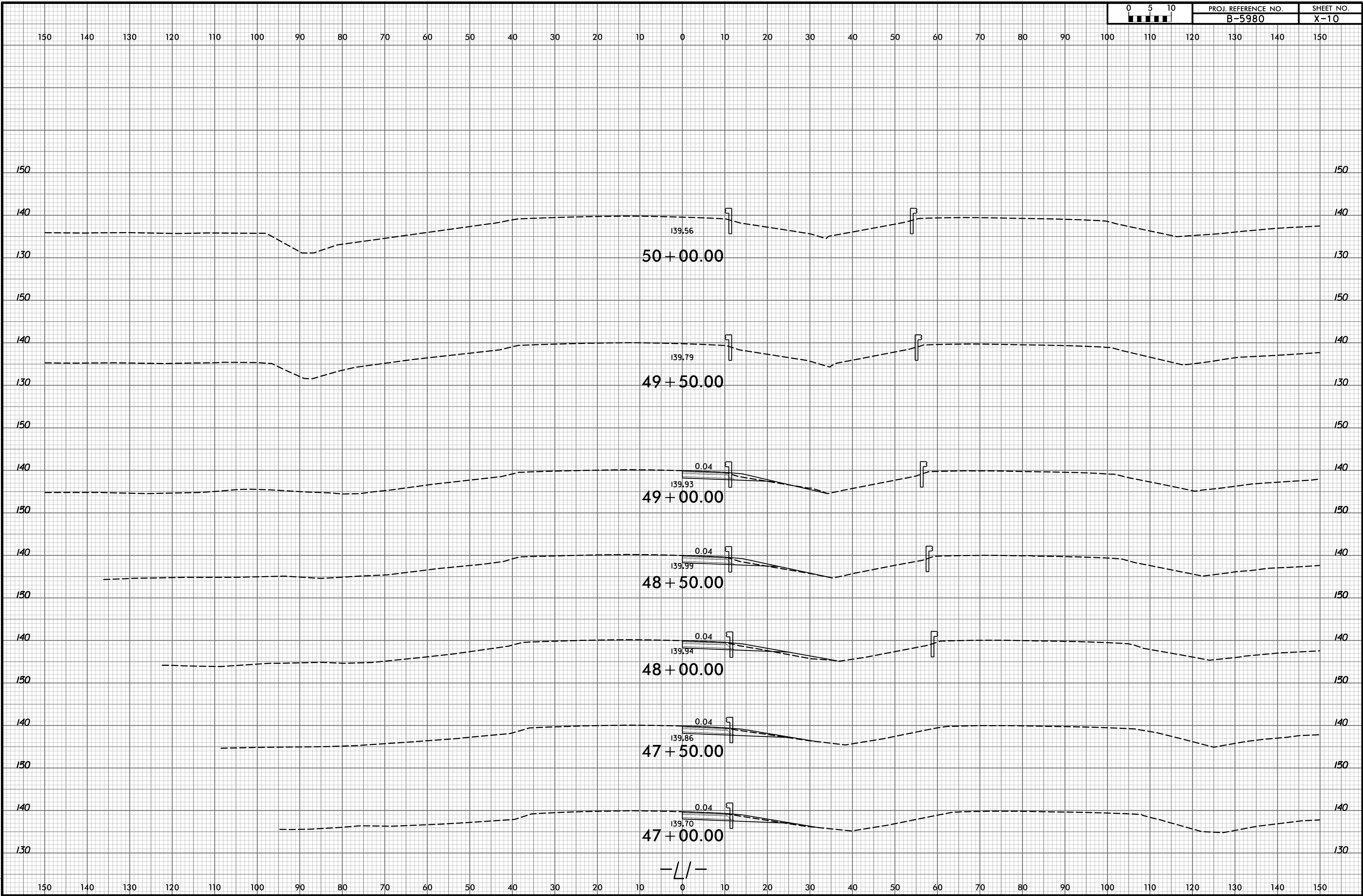

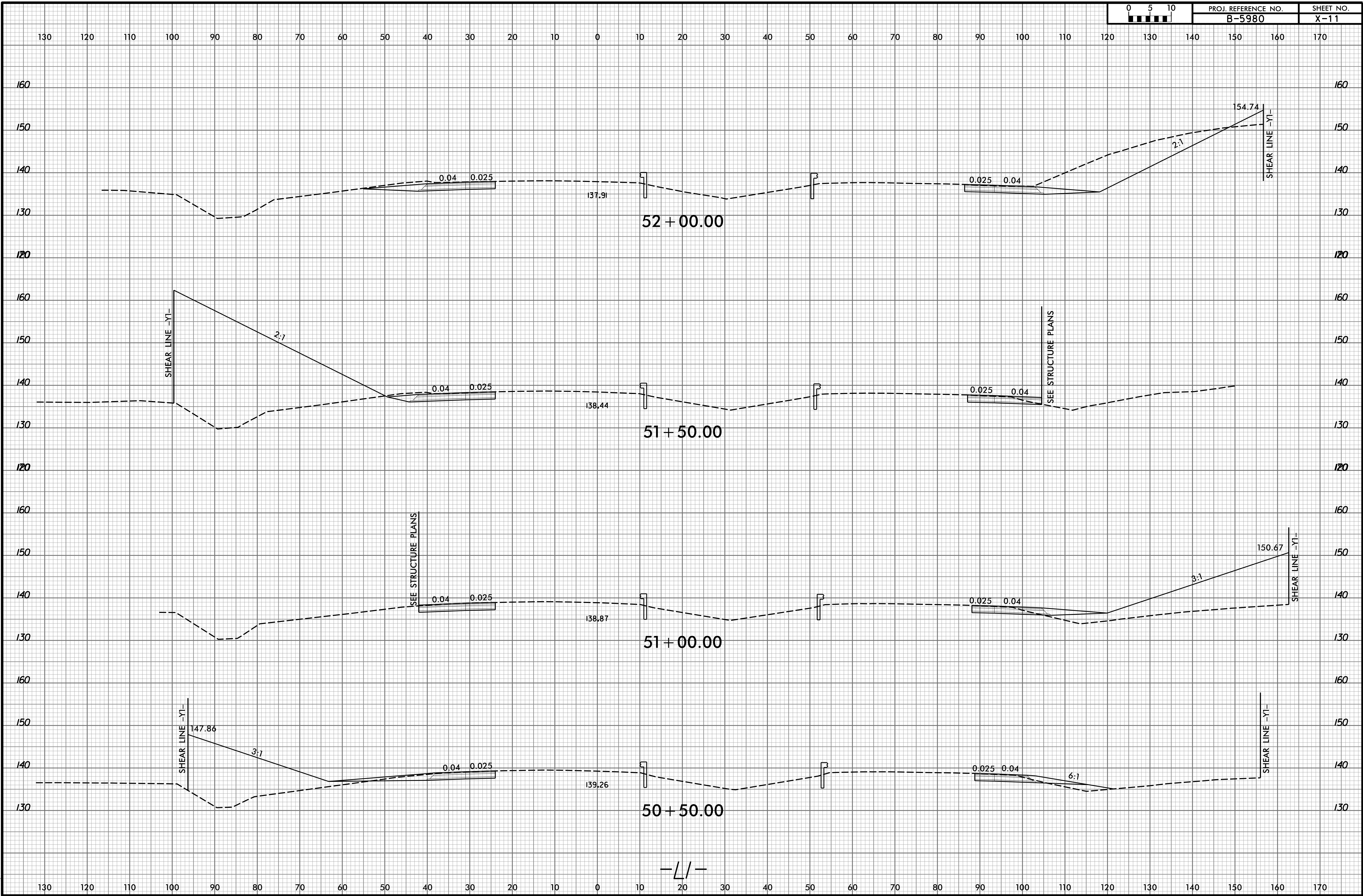

6/23/16

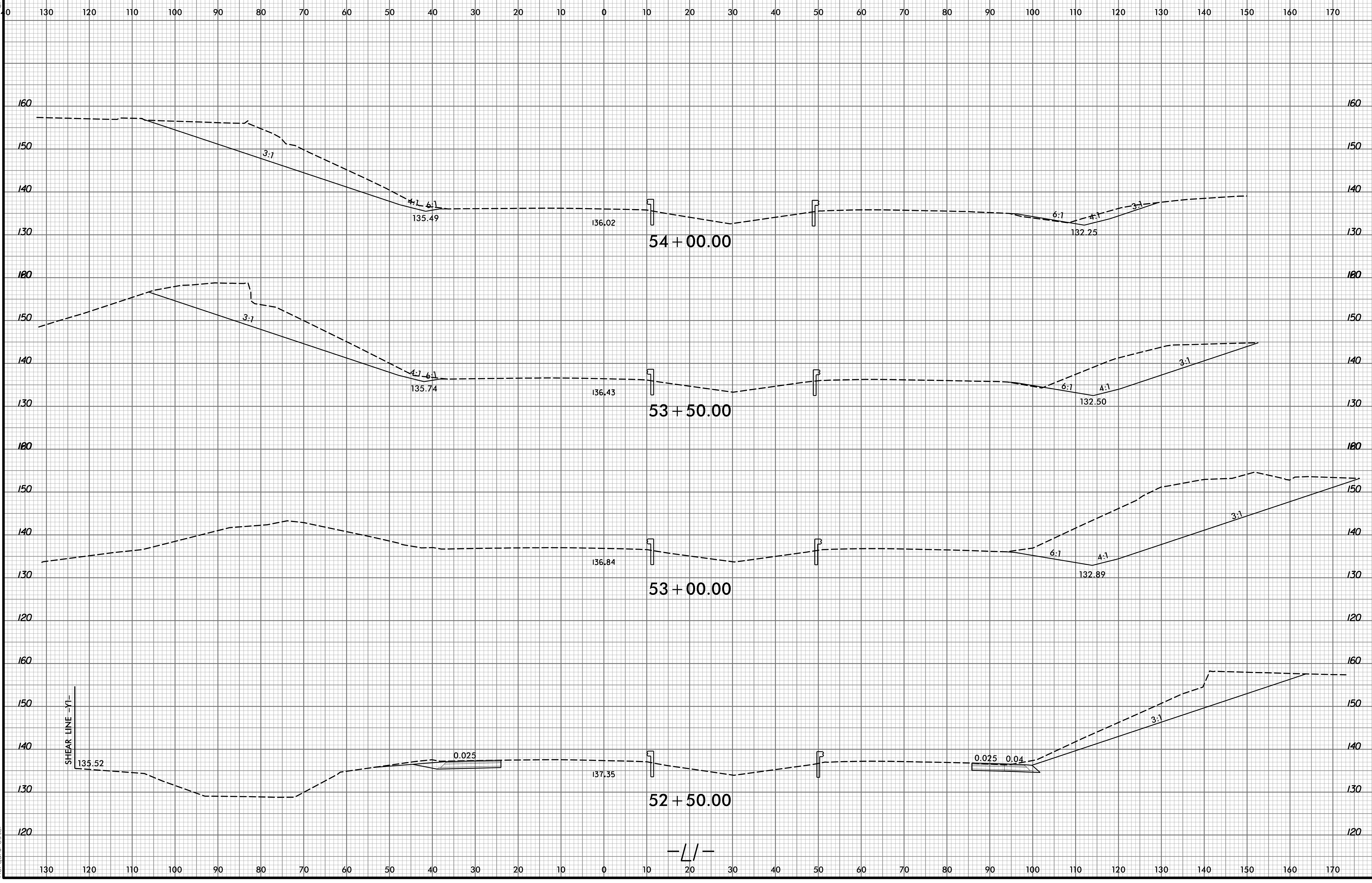

4/13/2020
 R:\Roadway\CorridorModeling\B5980_rdu_xpl_1.dgn
 Morgan, Foster

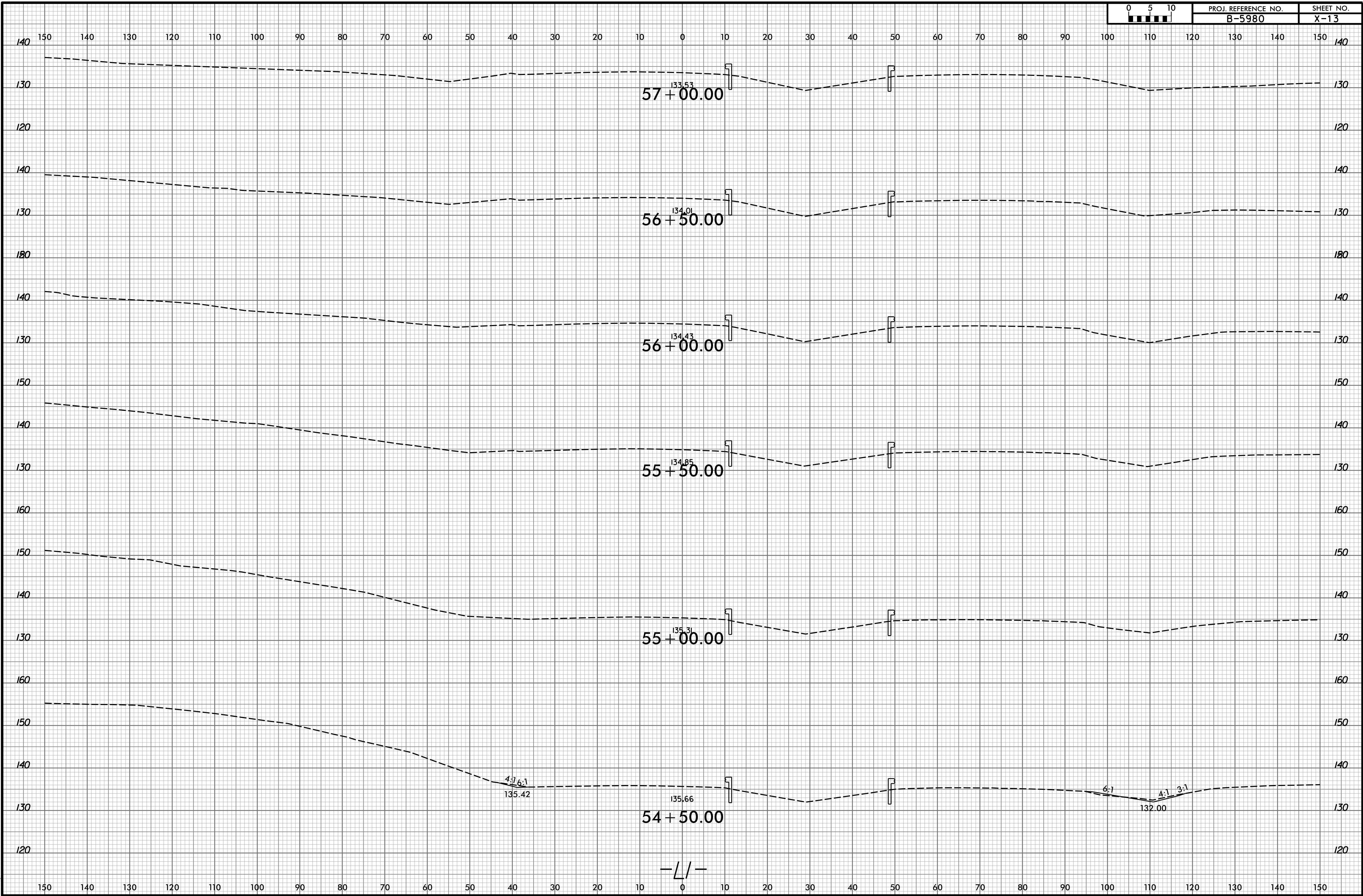

150 140 130 120 110 100 90 80 70 60 50 40 30 20 10 0 10 20 30 40 50 60 70 80 90 100 110 120 130 140 150

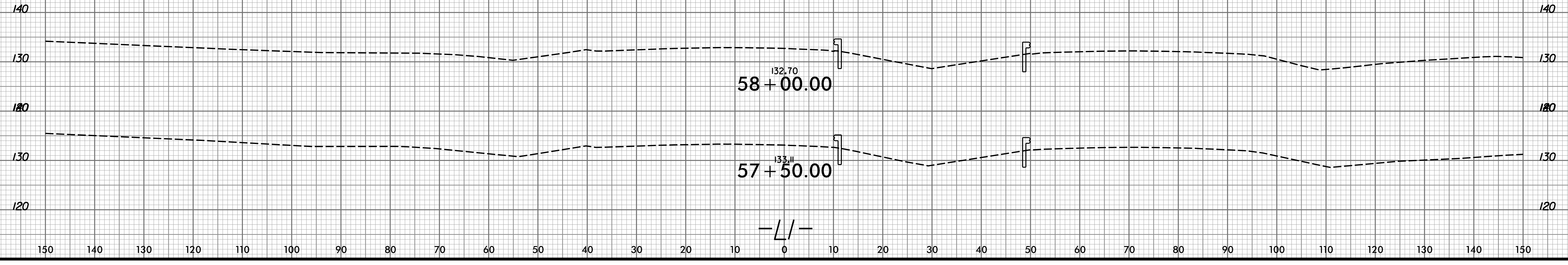

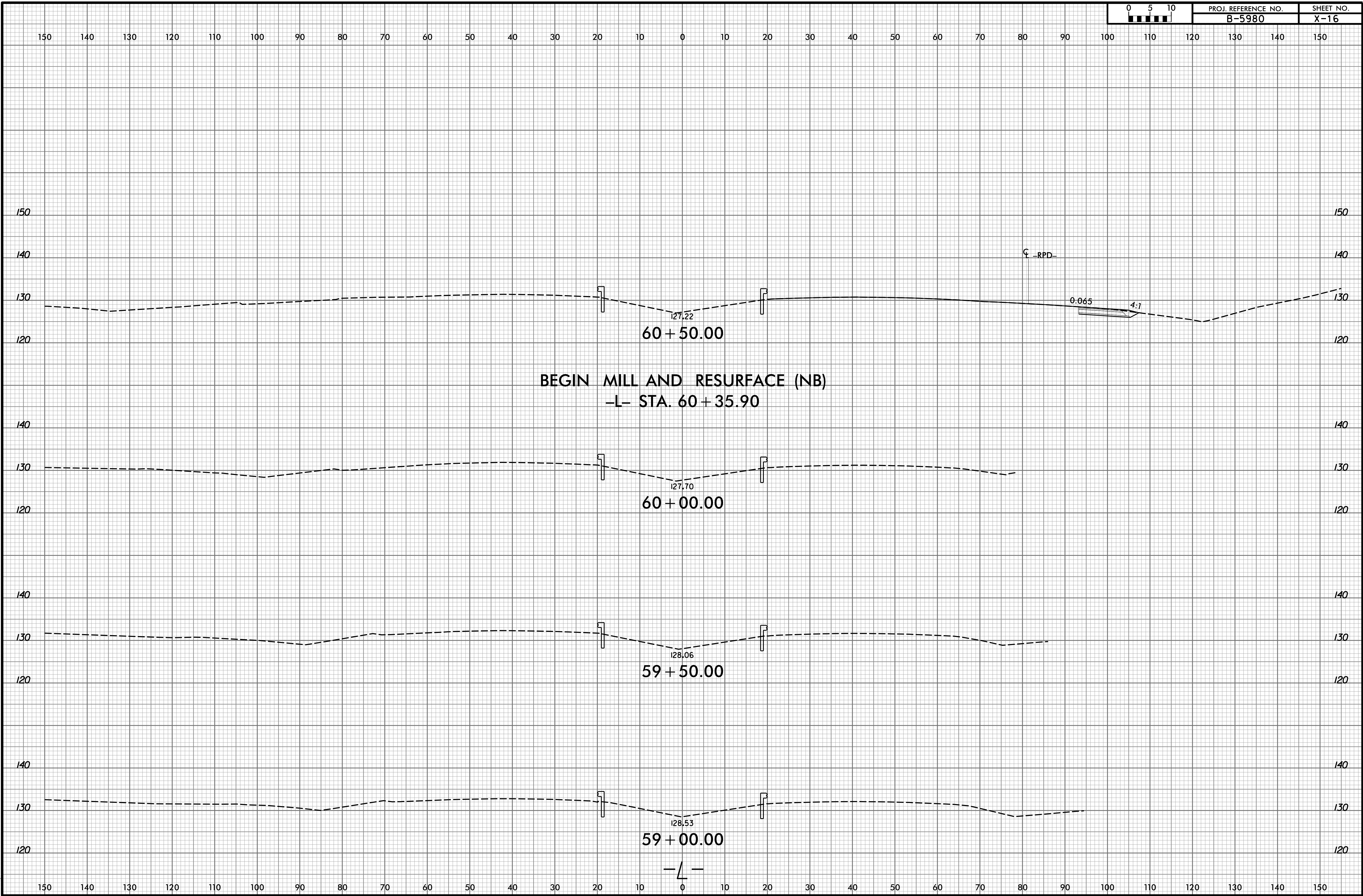

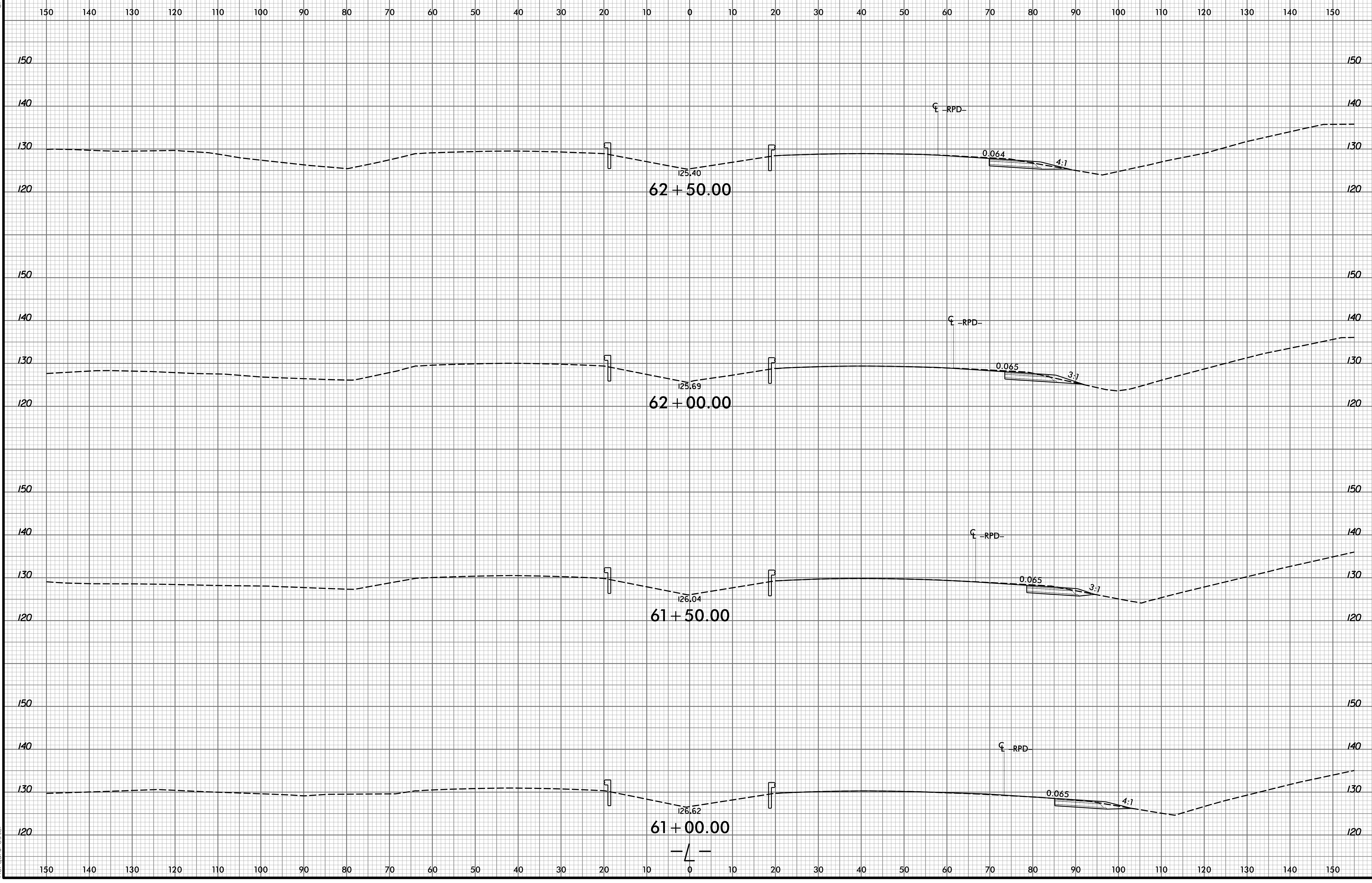

END TIP PROJECT B-5980
 END MILL AND RESURFACE (NB)
 -L- STA. 64 + 50.07

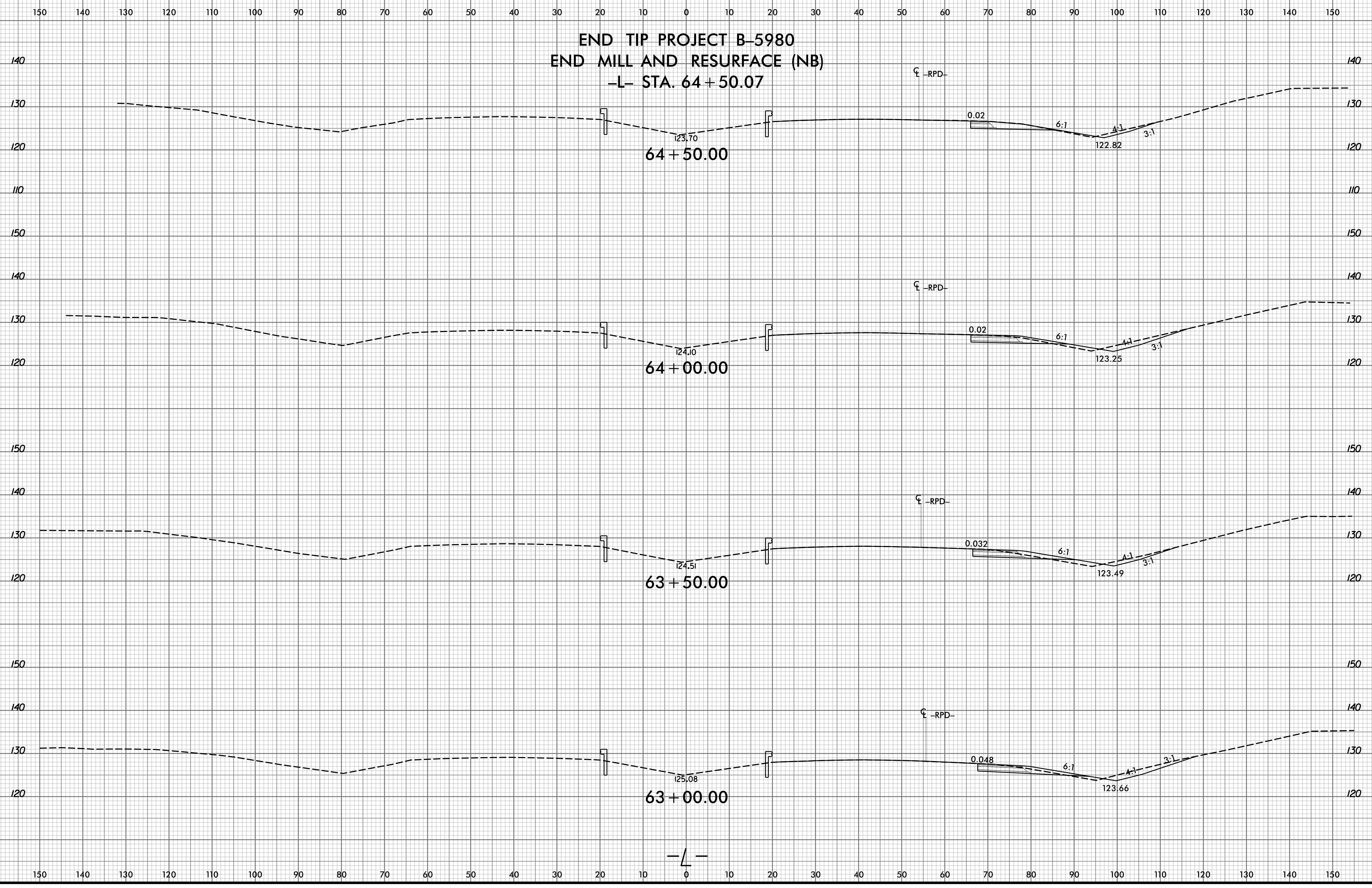

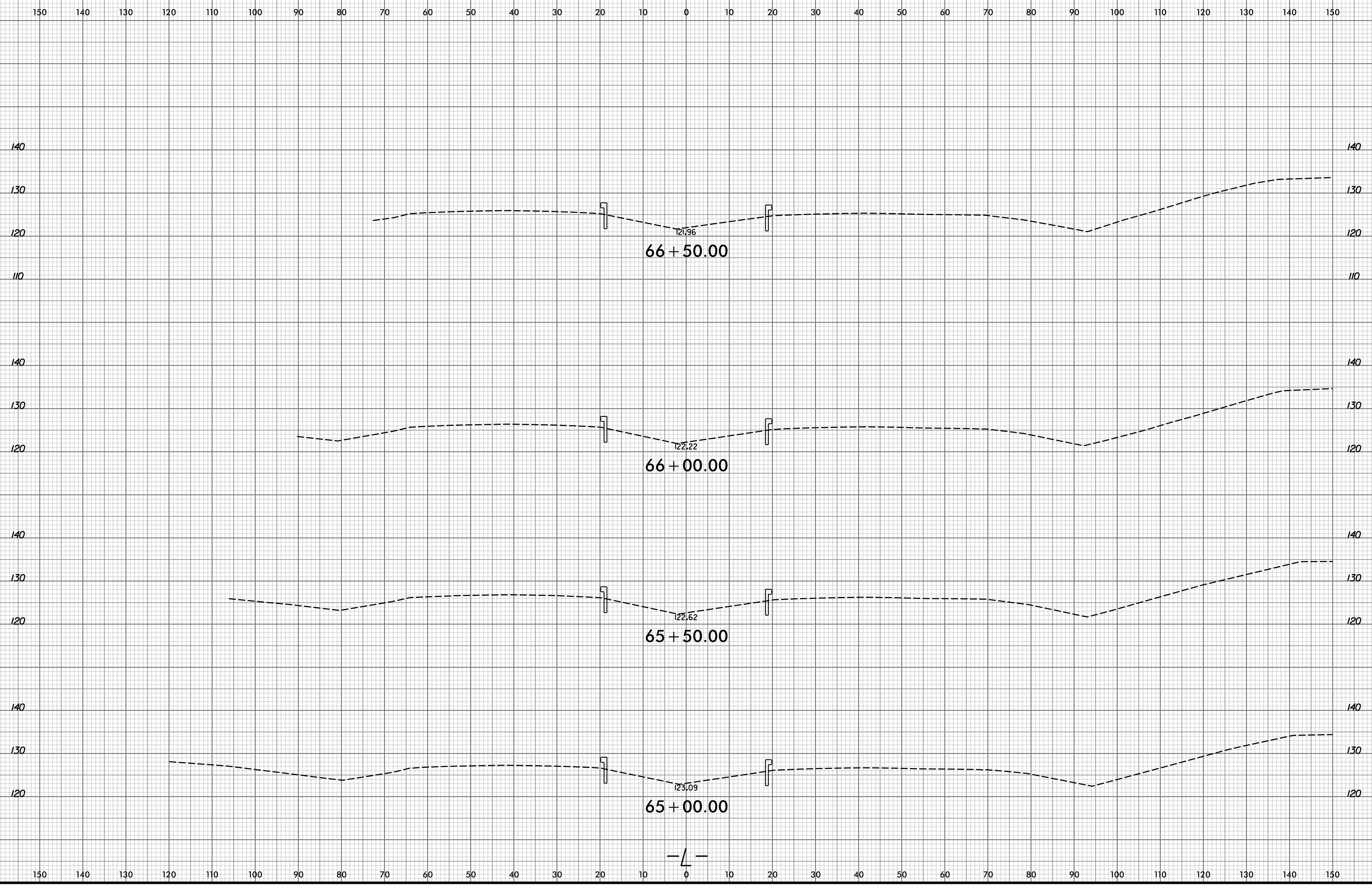

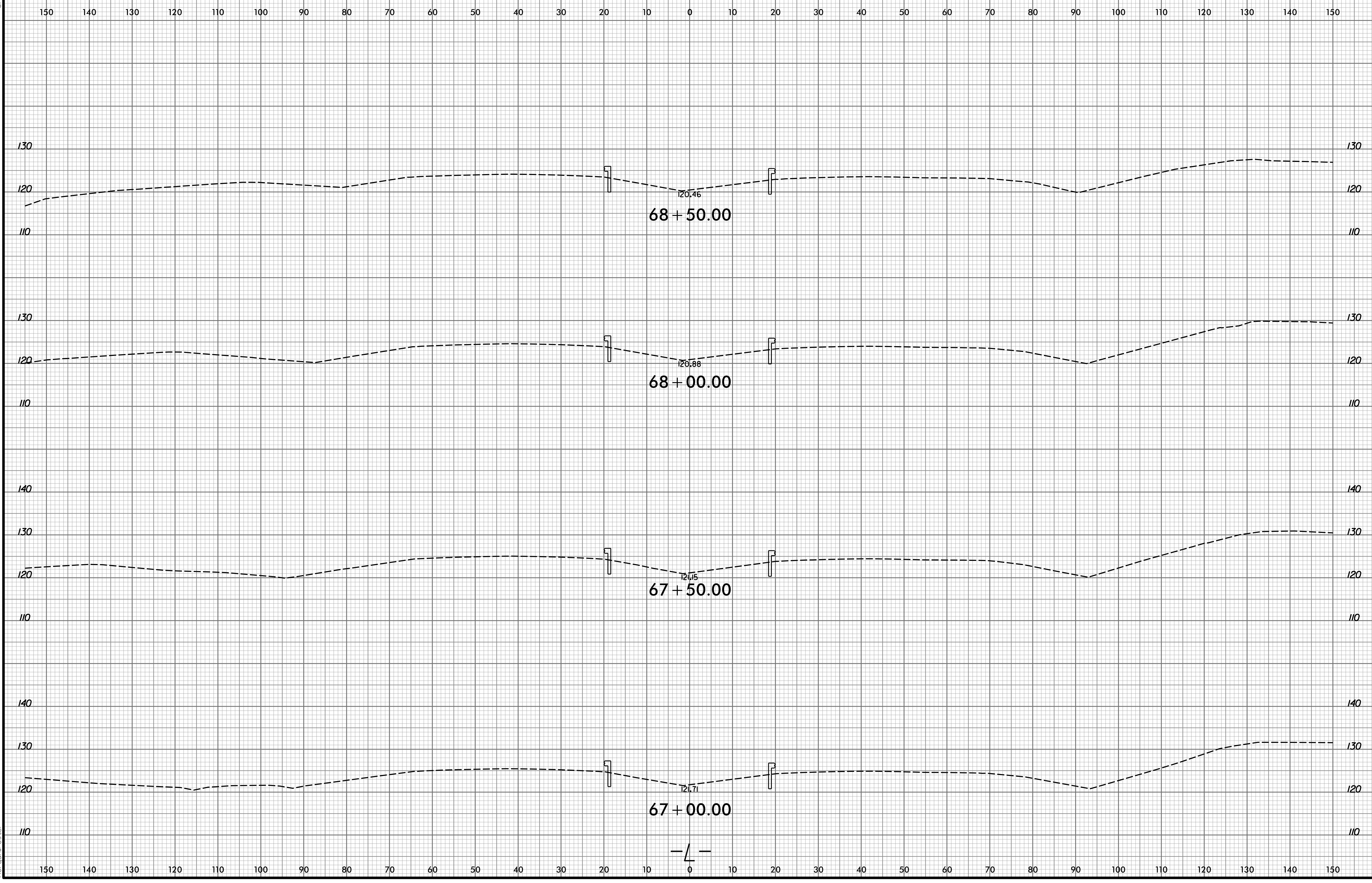

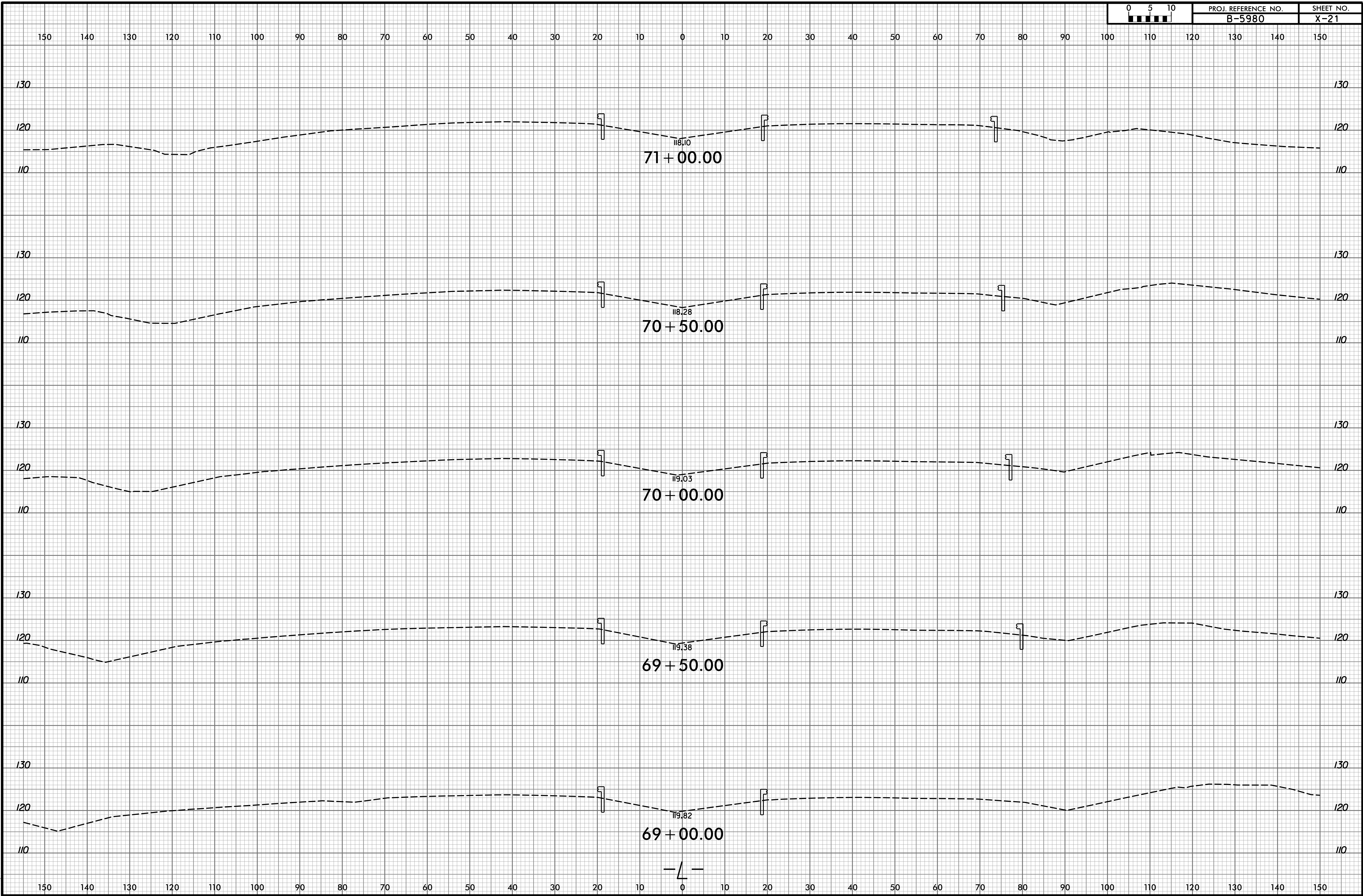

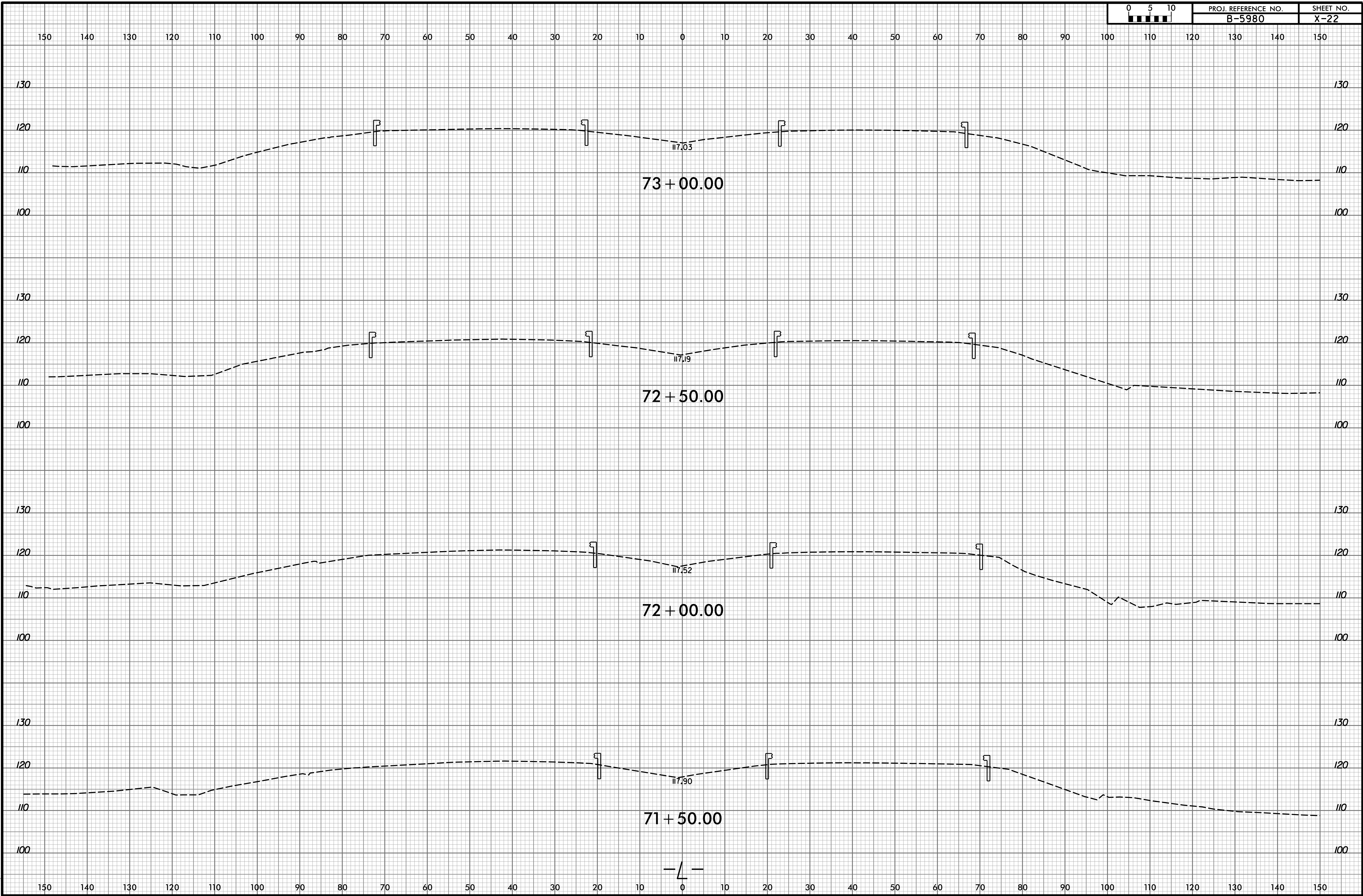

150 140 130 120 110 100 90 80 70 60 50 40 30 20 10 0 10 20 30 40 50 60 70 80 90 100 110 120 130 140 150

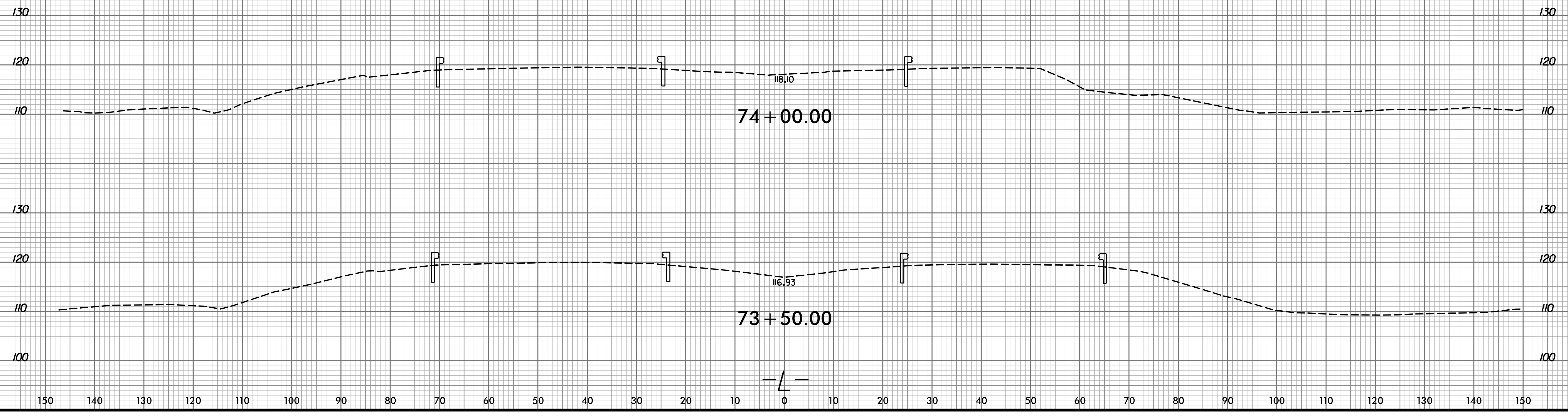

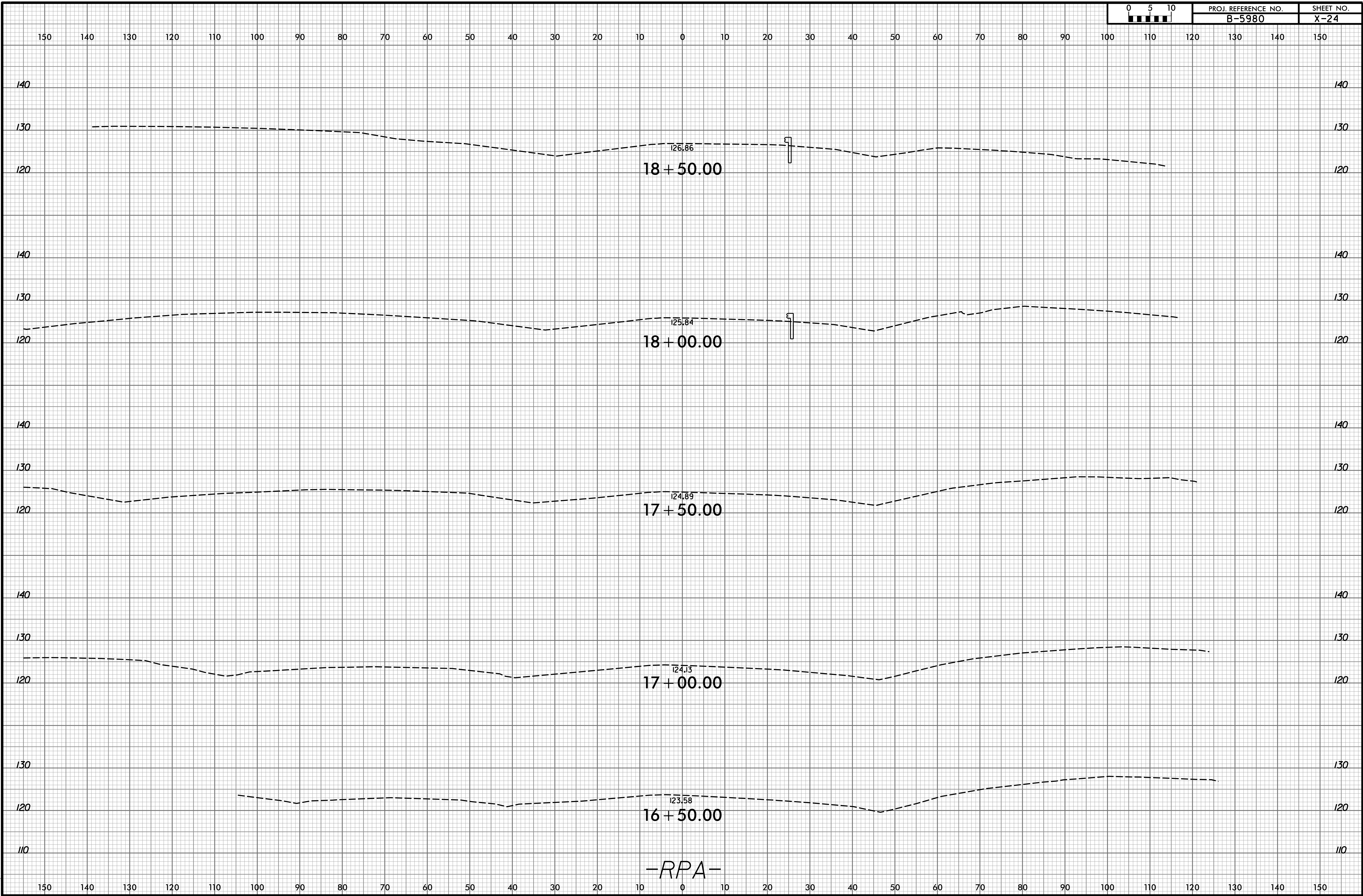

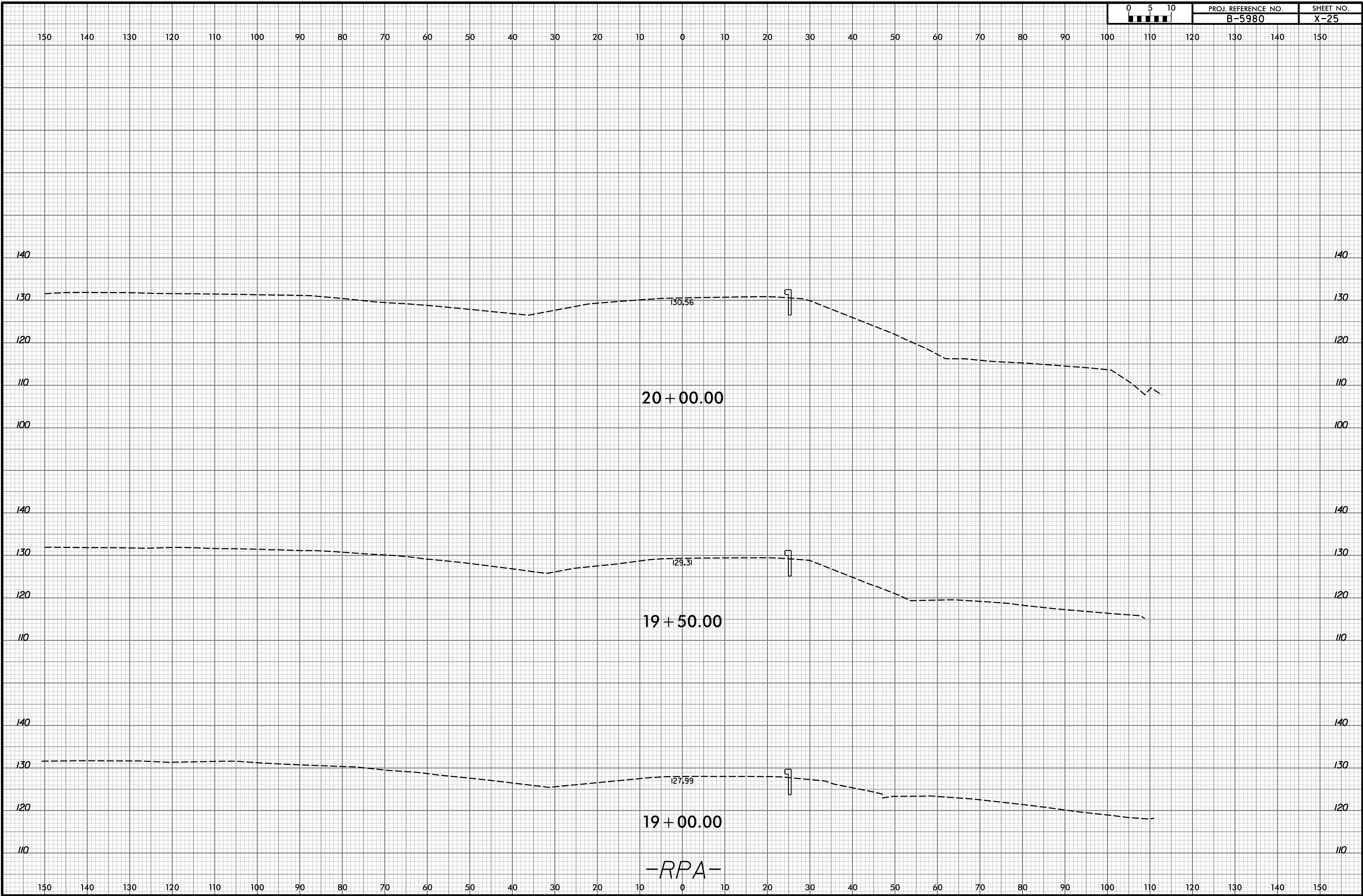

-RPA-

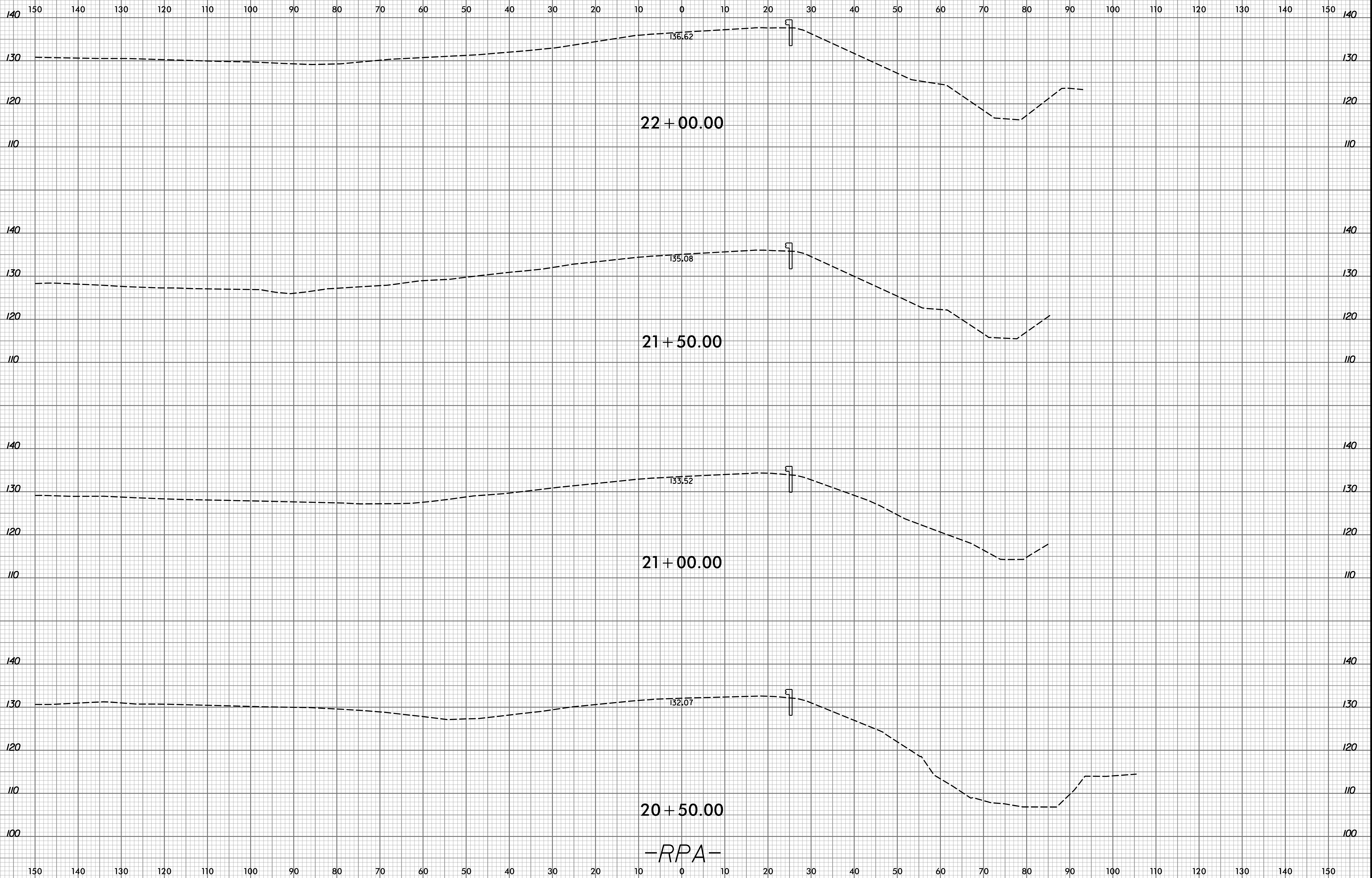

-RPA-

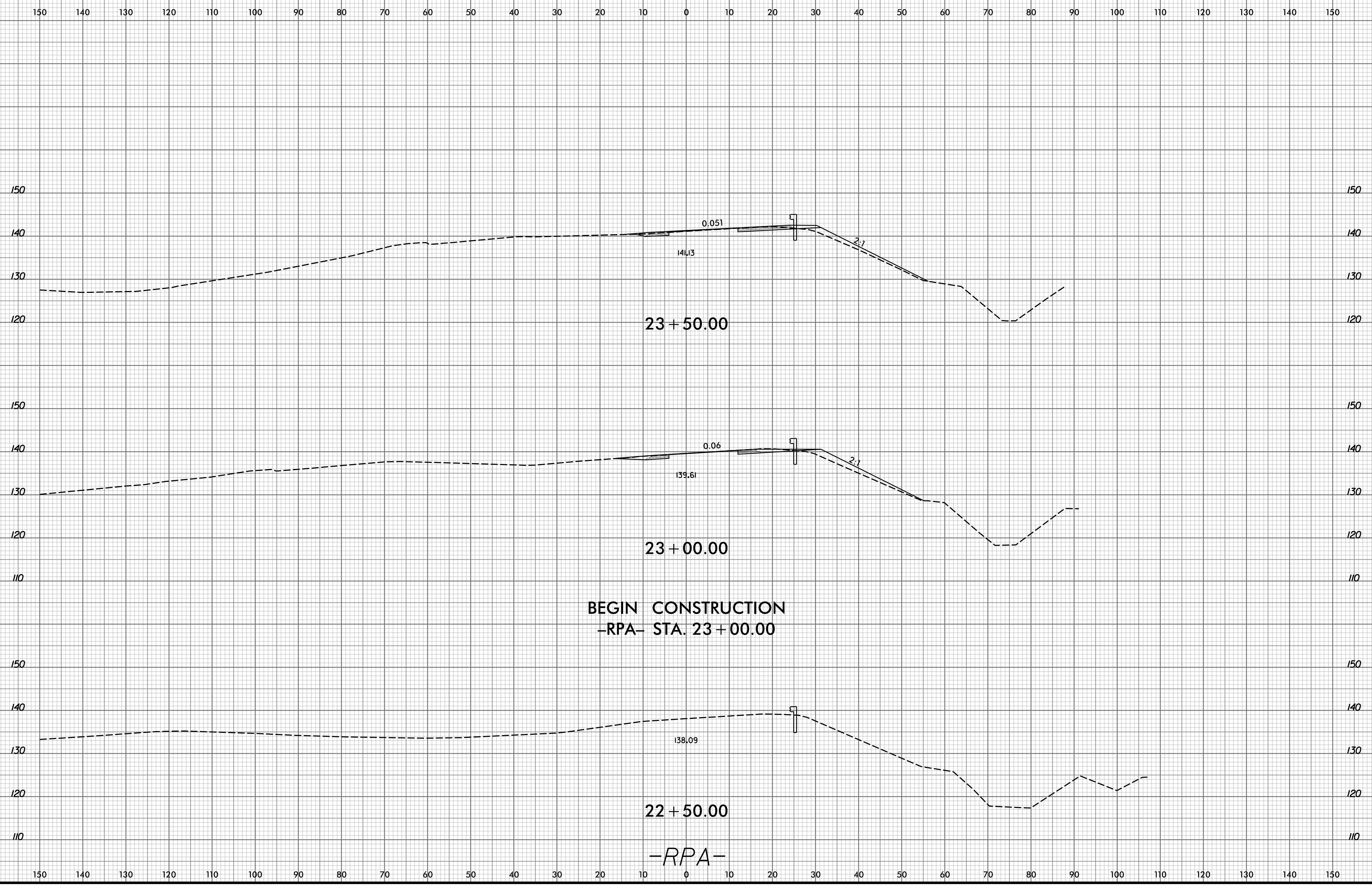

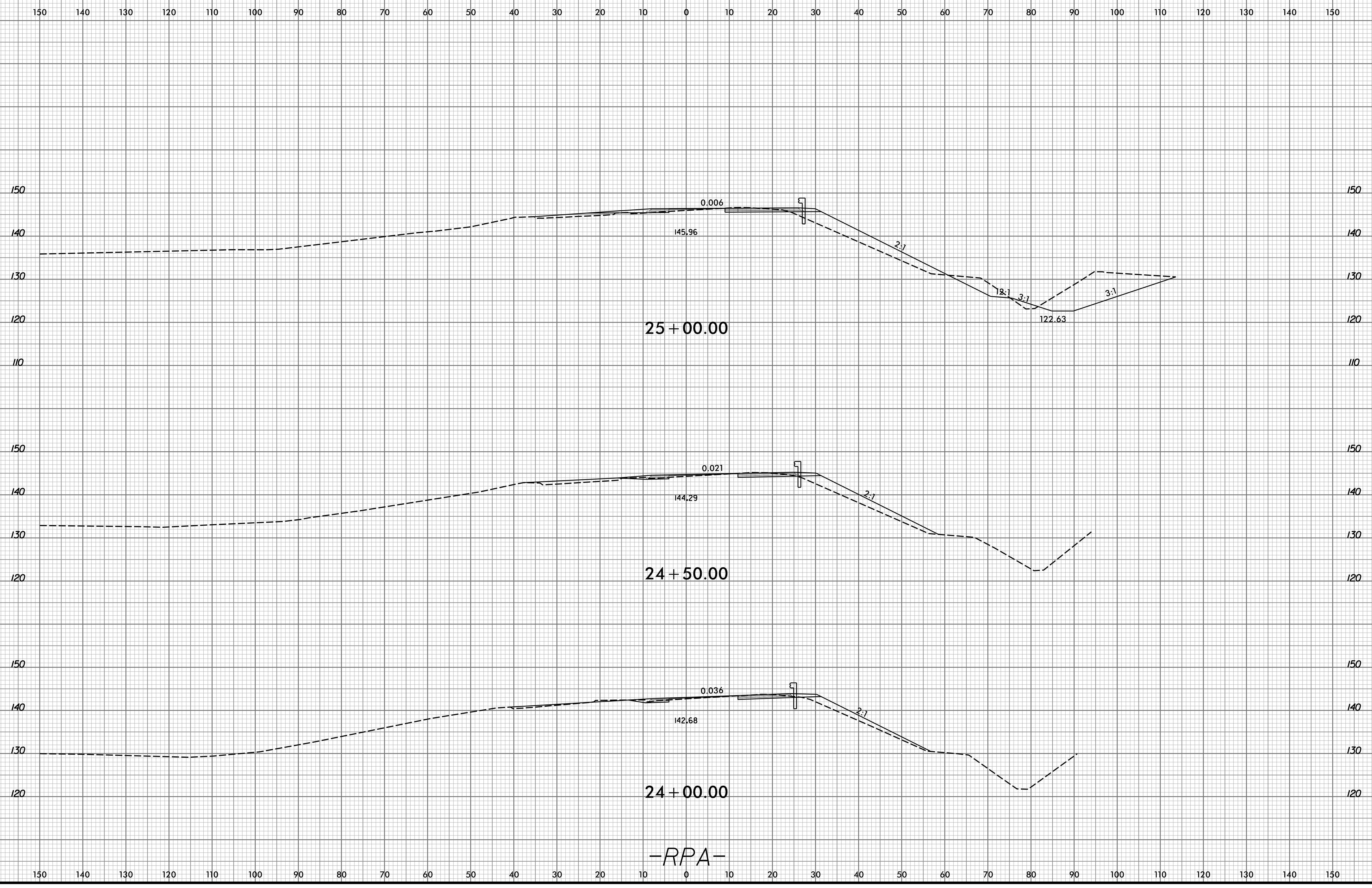

-RPA-

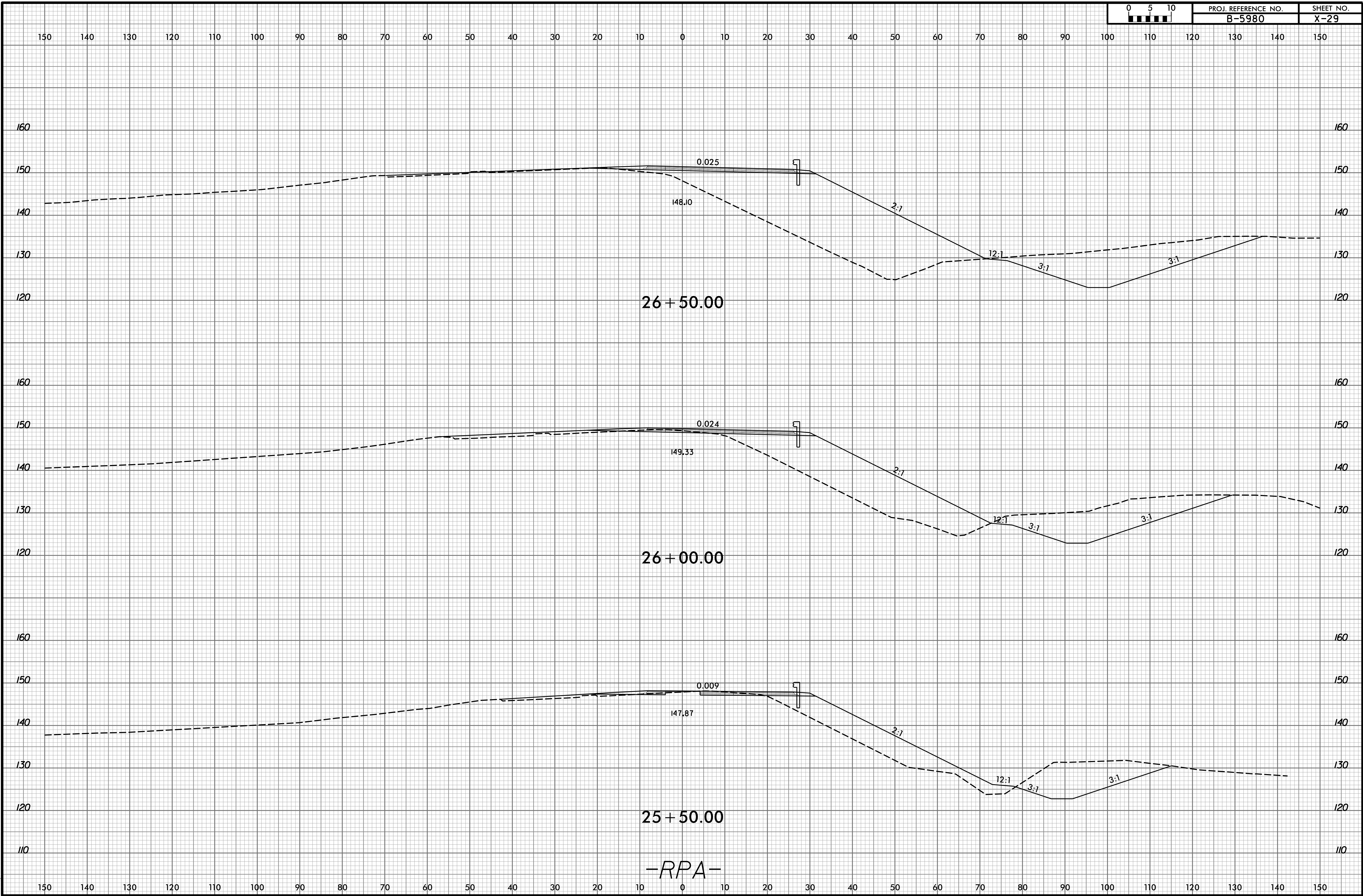

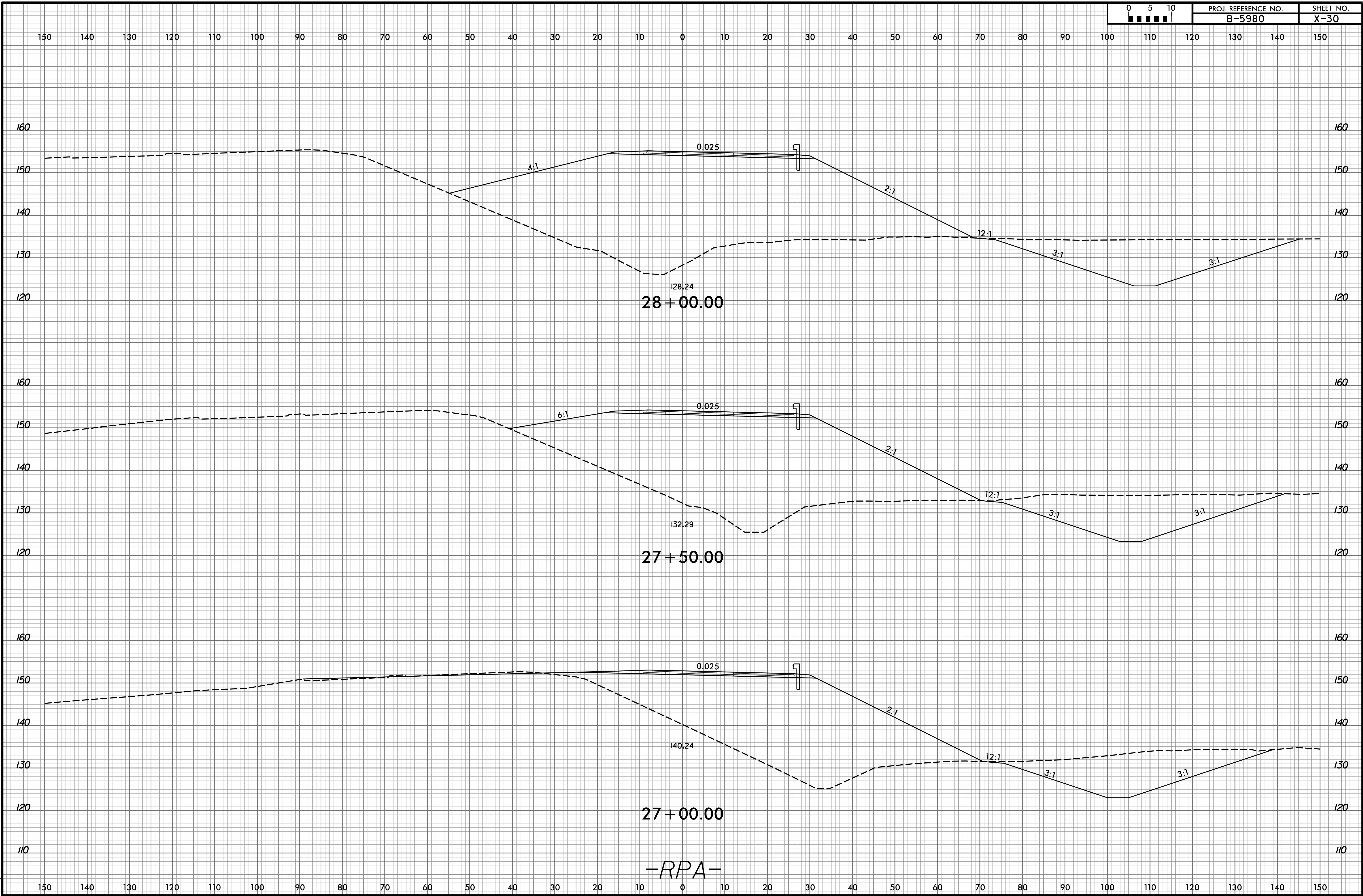

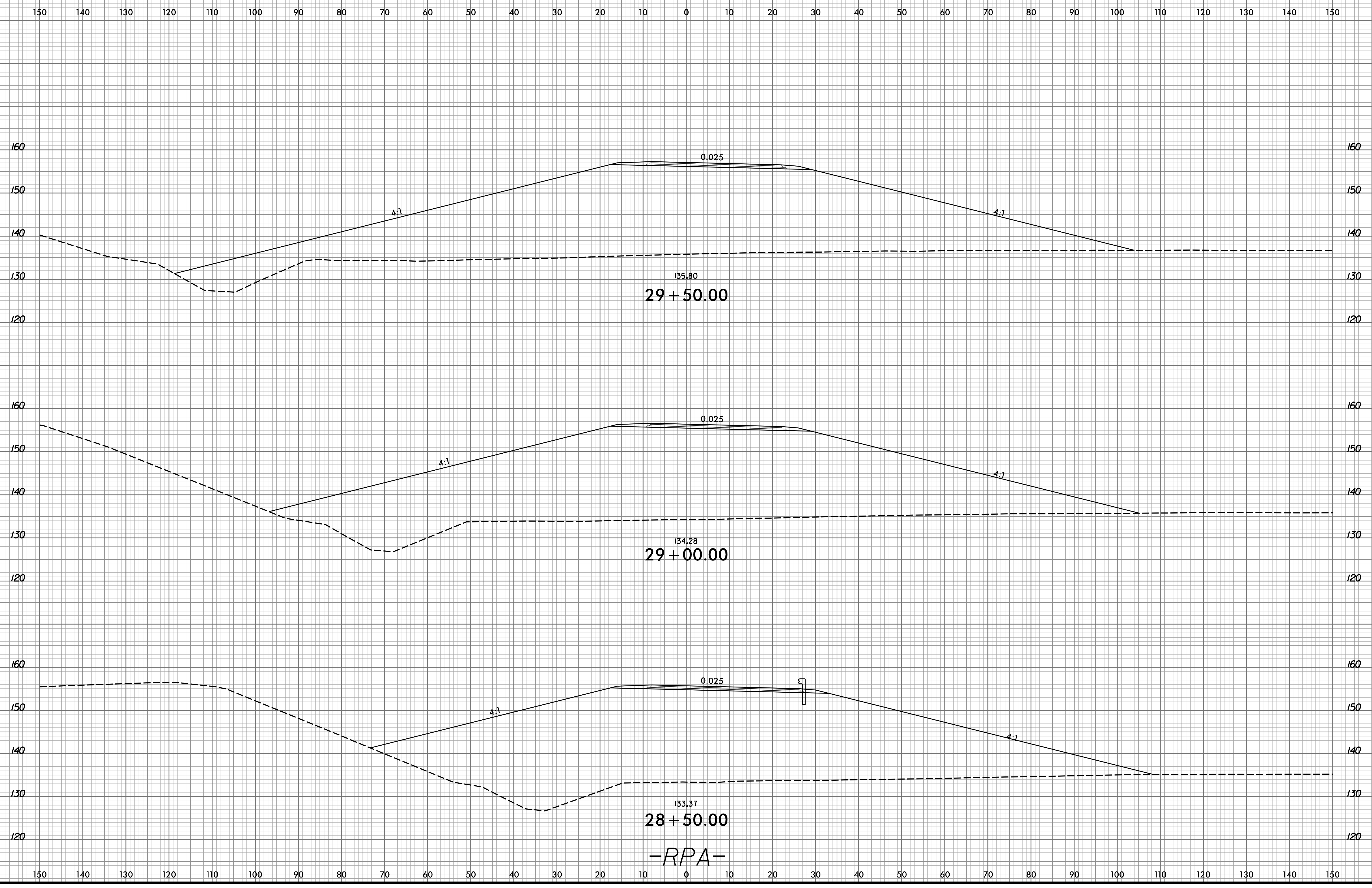

-RPA-

150 140 130 120 110 100 90 80 70 60 50 40 30 20 10 0 10 20 30 40 50 60 70 80 90 100 110 120 130 140 150

END CONSTRUCTION
-RPA- STA. 31 + 43.86

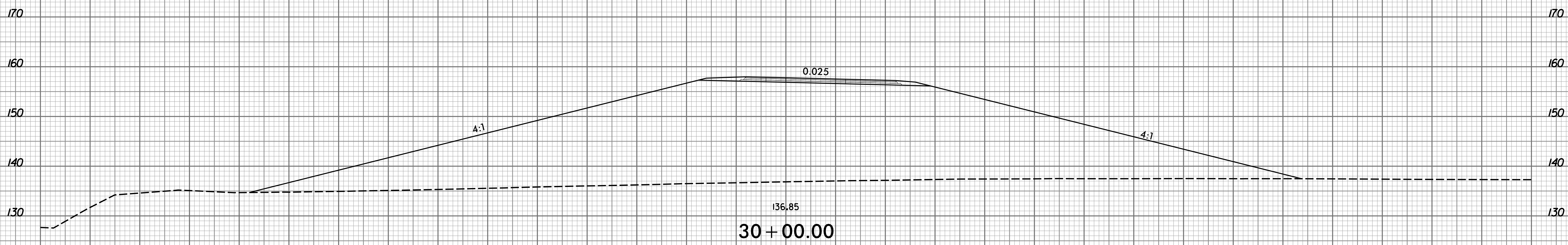
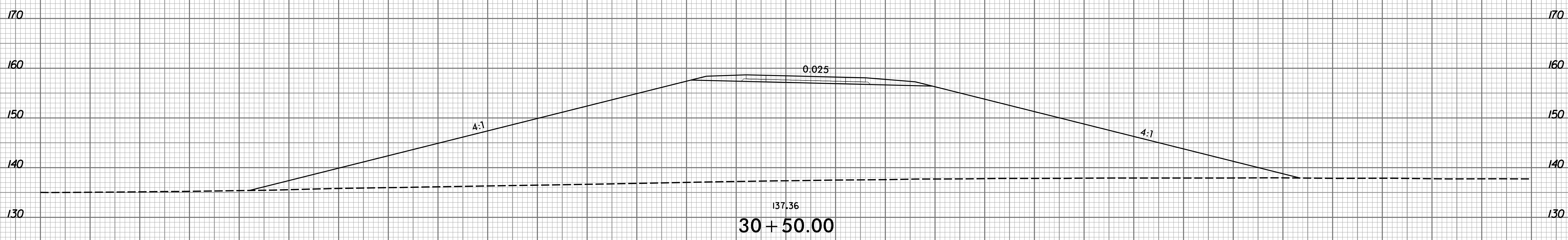
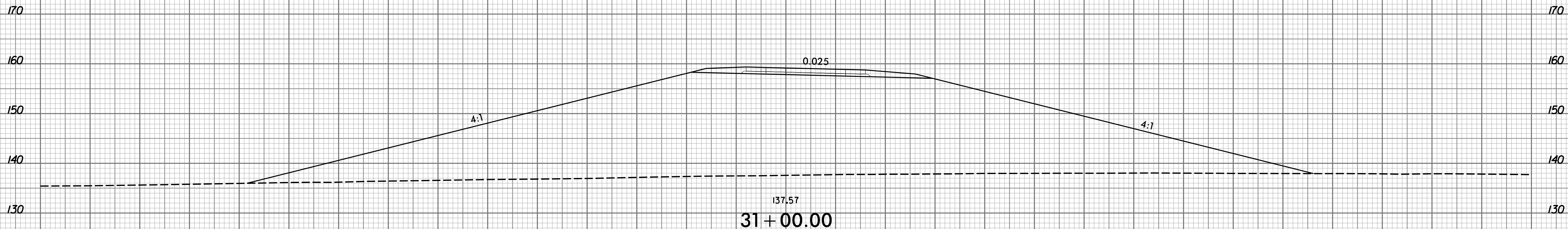

-RPA-

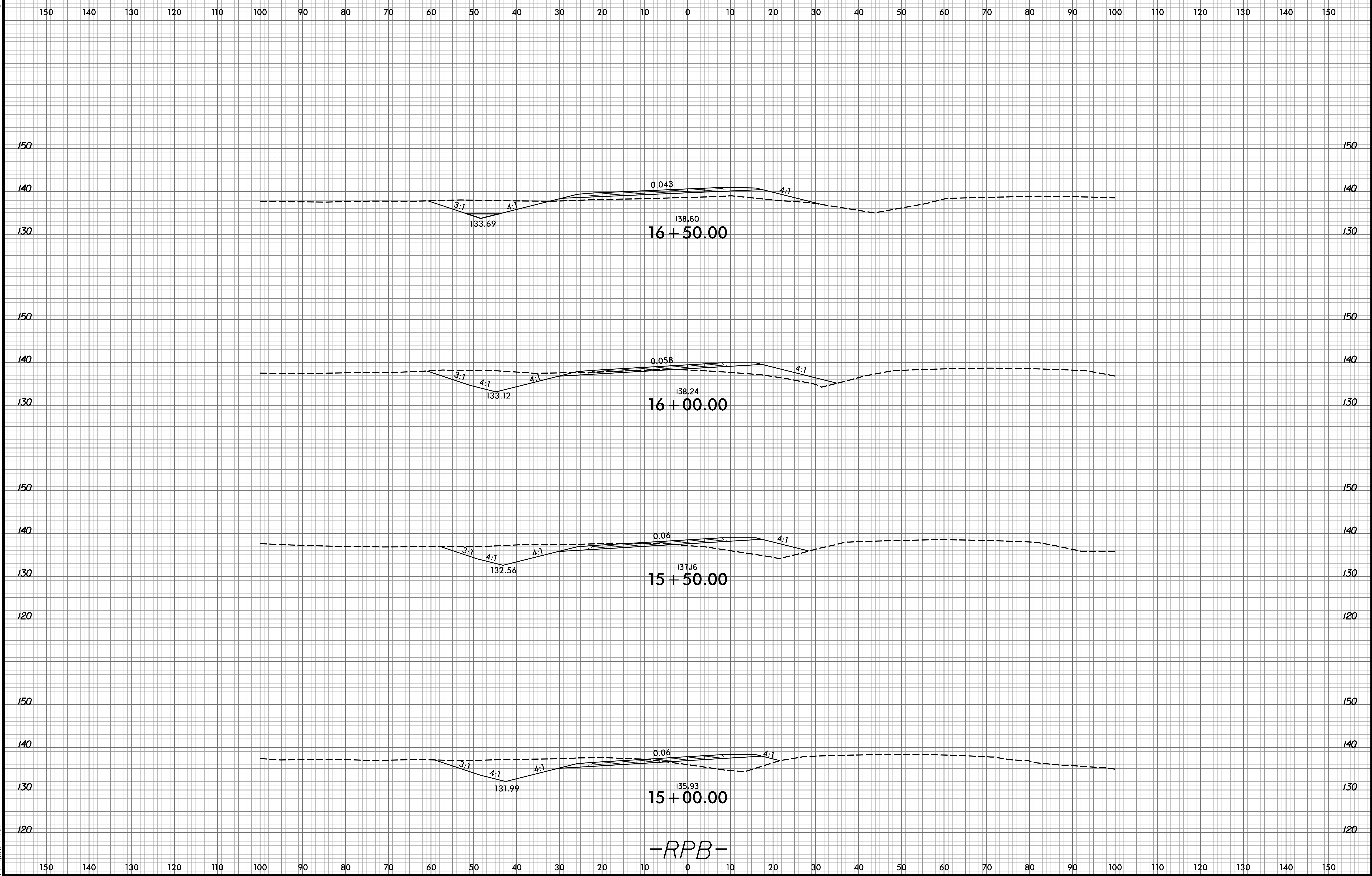

-RPB-

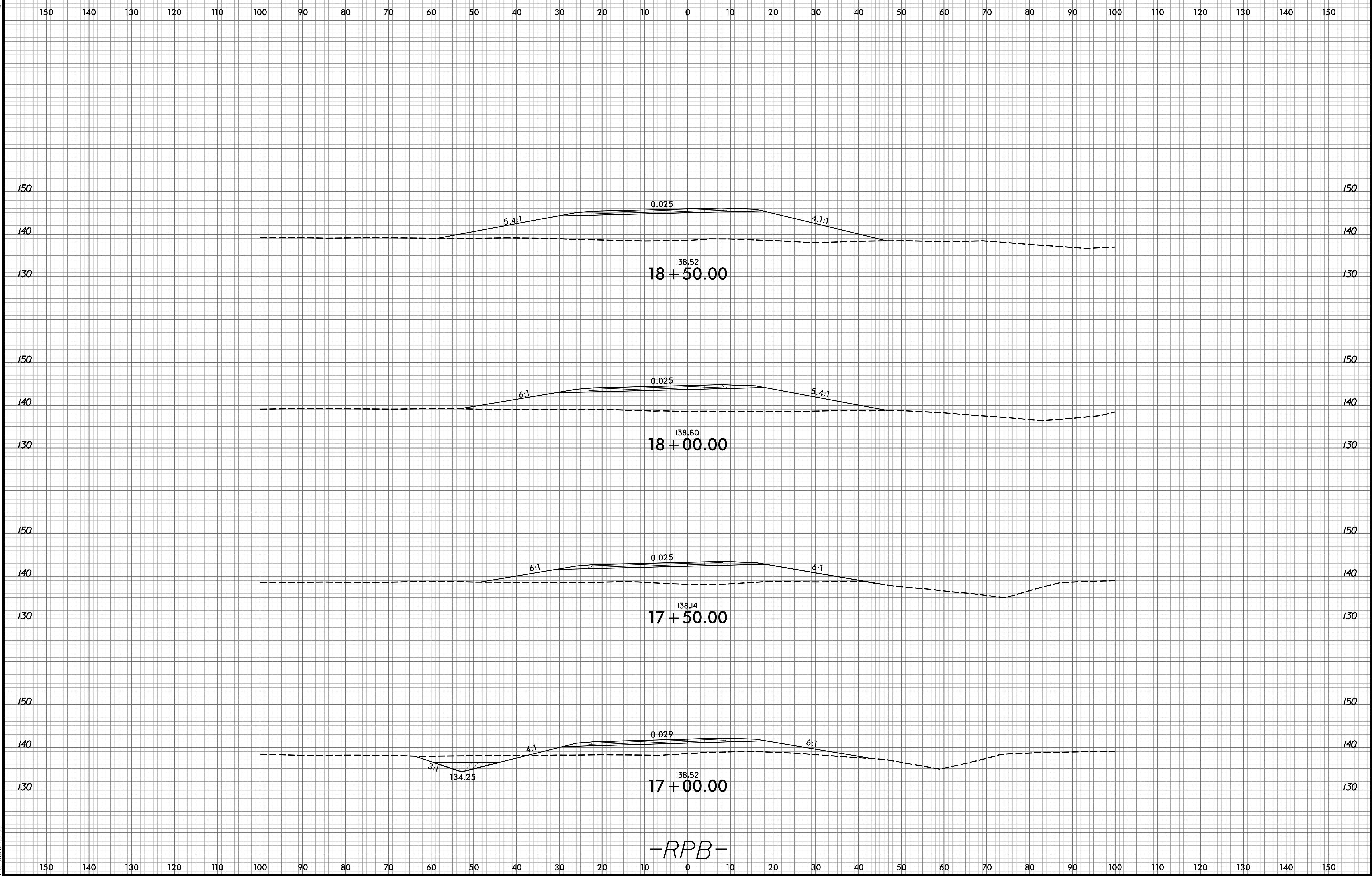

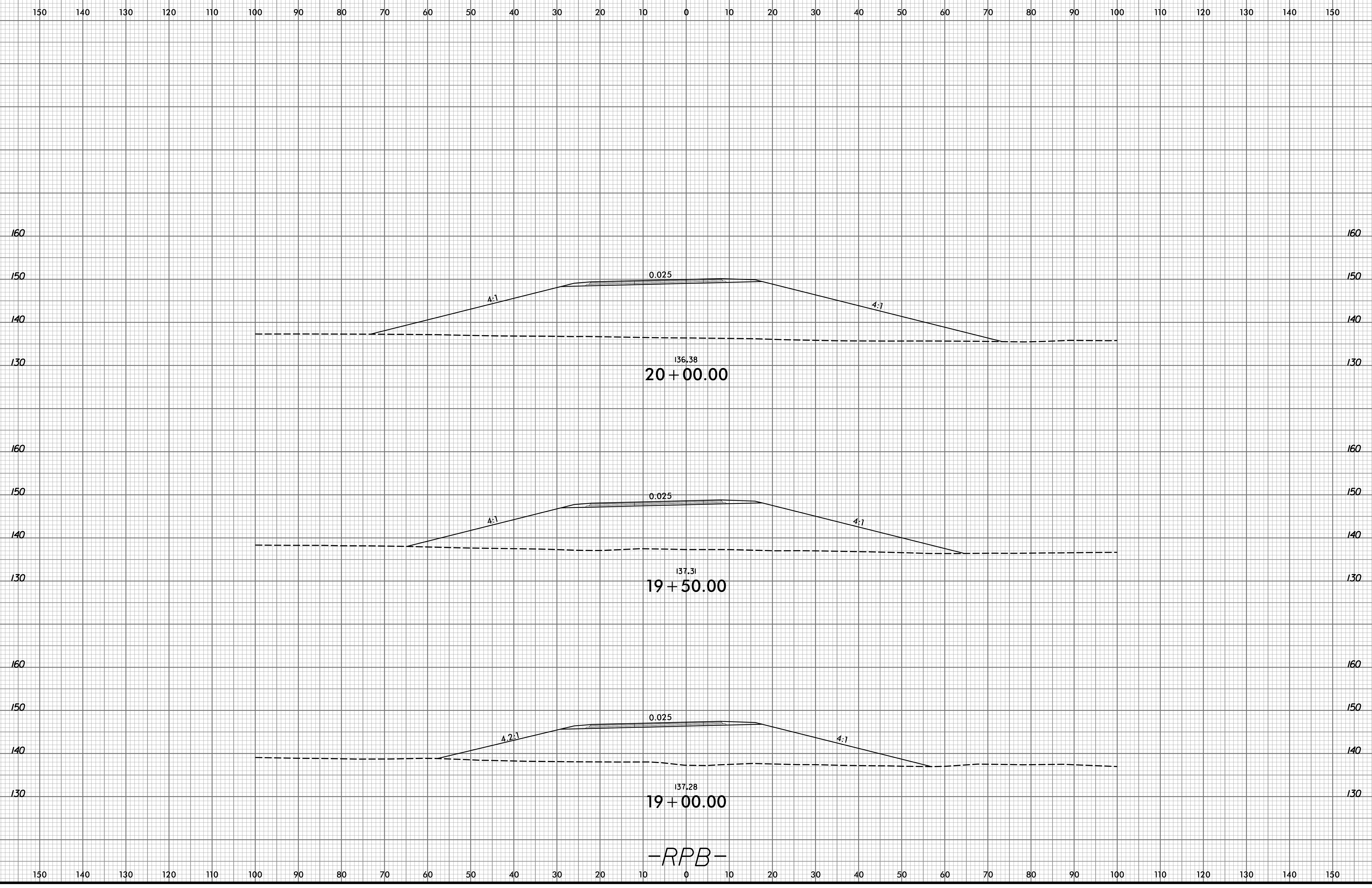

-RPB-

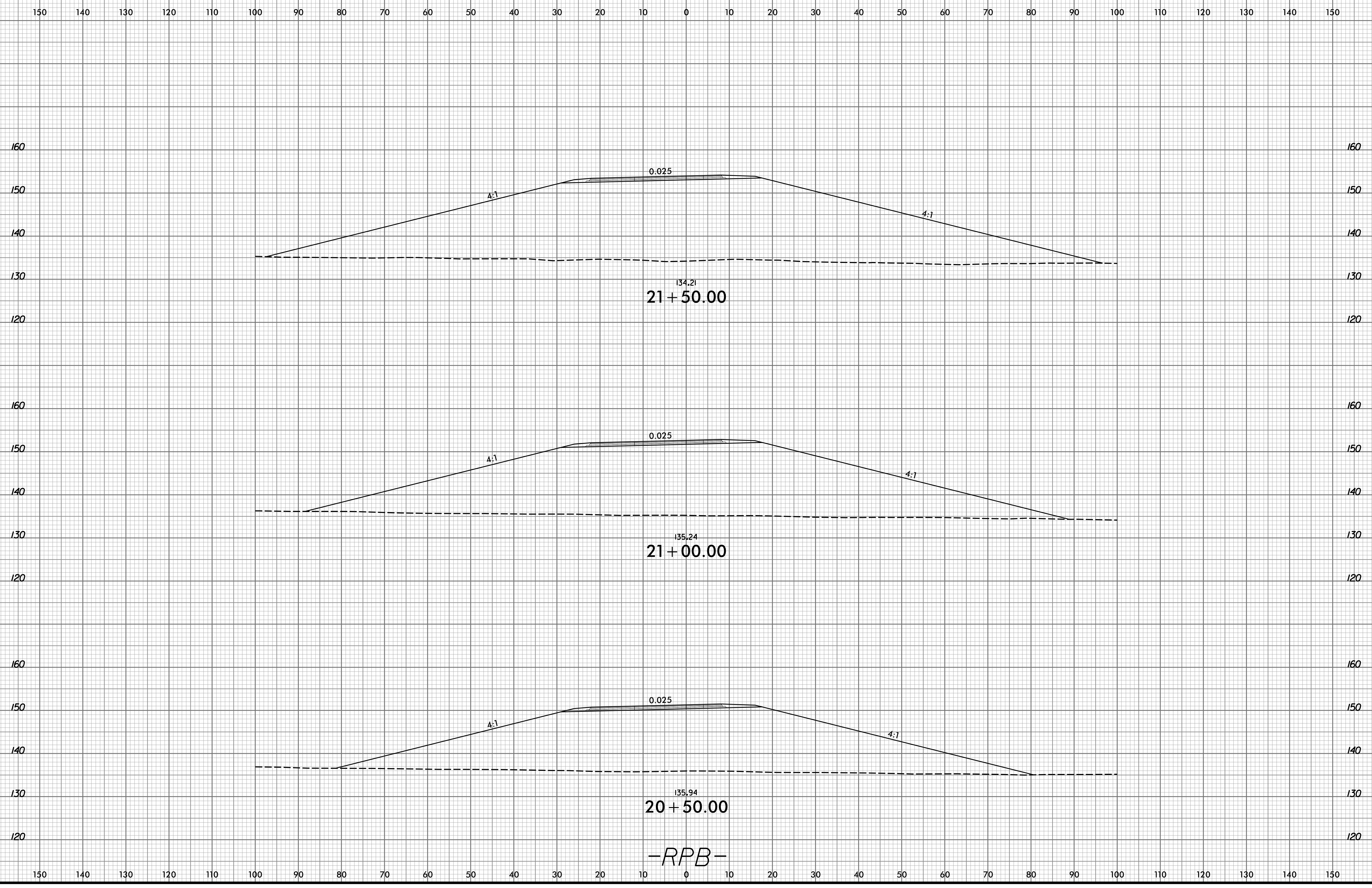

-RPB-

6/23/16

150 140 130 120 110 100 90 80 70 60 50 40 30 20 10 0 10 20 30 40 50 60 70 80 90 100 110 120 130 140 150

END CONSTRUCTION
-RPB- STA. 23 + 60.76

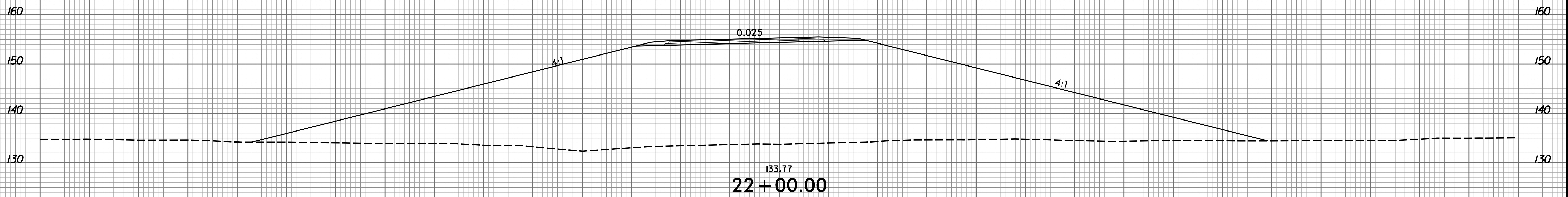

-RPB-

150 140 130 120 110 100 90 80 70 60 50 40 30 20 10 0 10 20 30 40 50 60 70 80 90 100 110 120 130 140 150

4/13/2020
 R:\Roadway\CorridorModeling\B5980_rdu_xpl_RPB.dgn
 Morgan, Foster

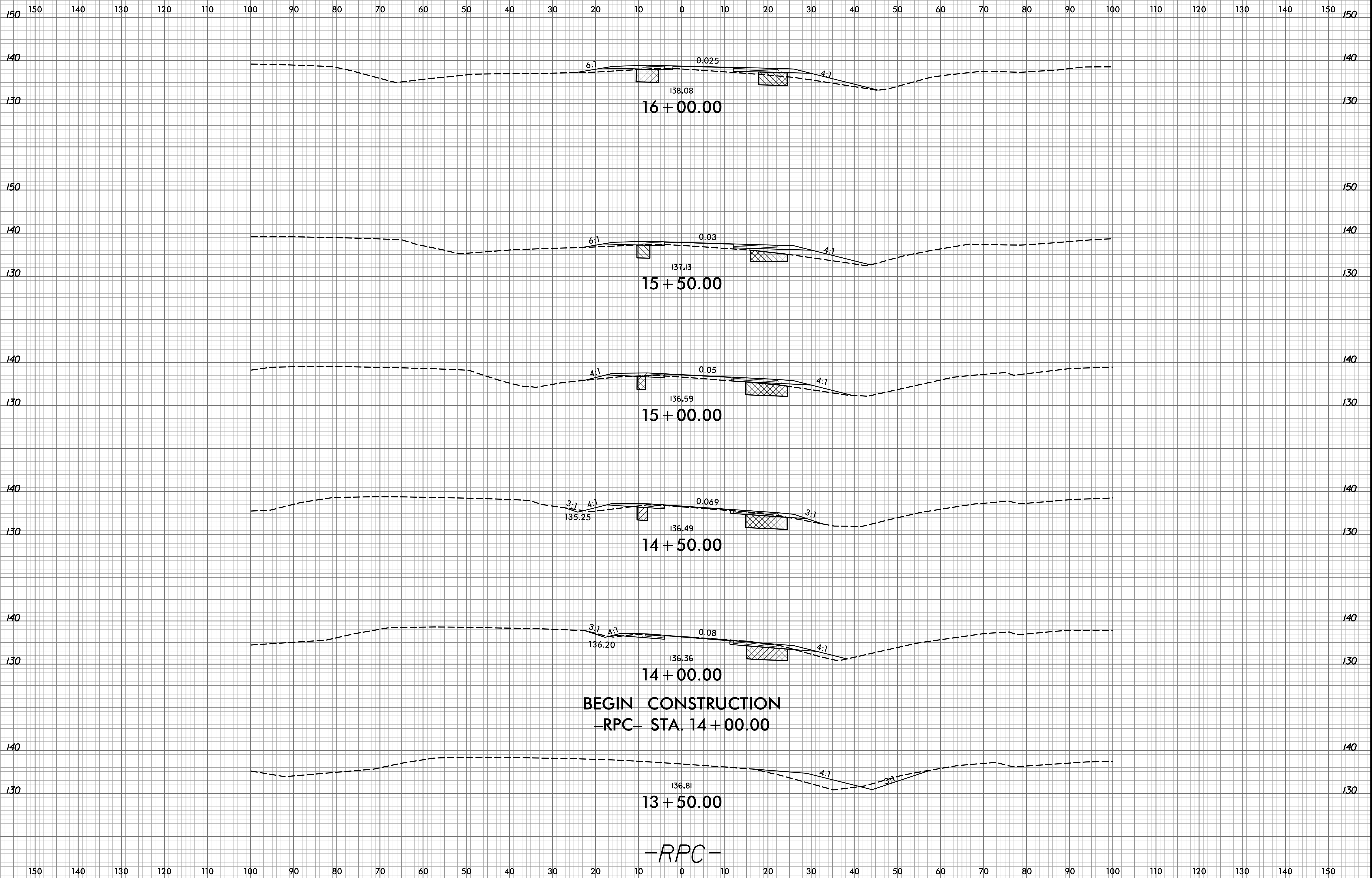

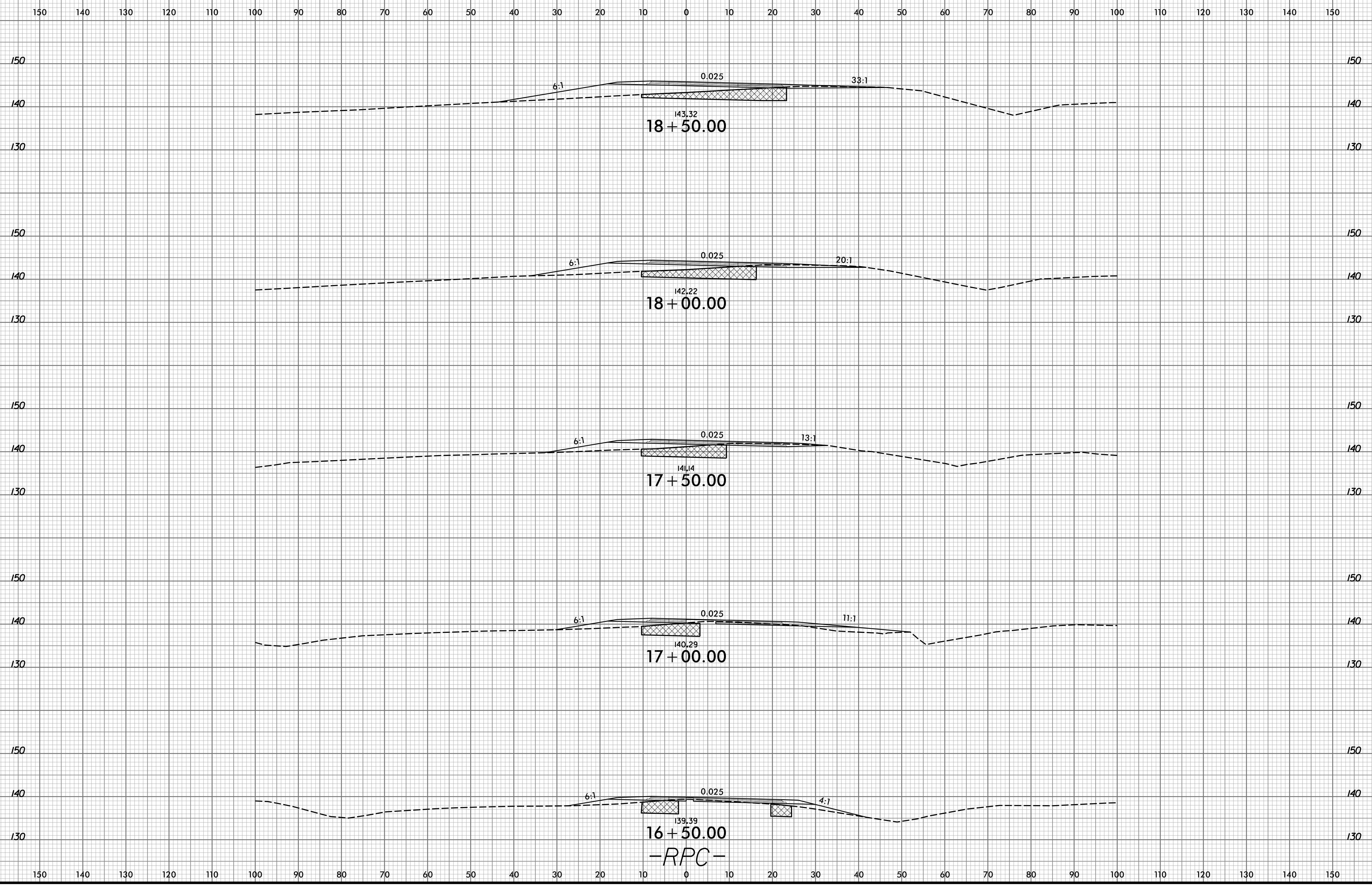

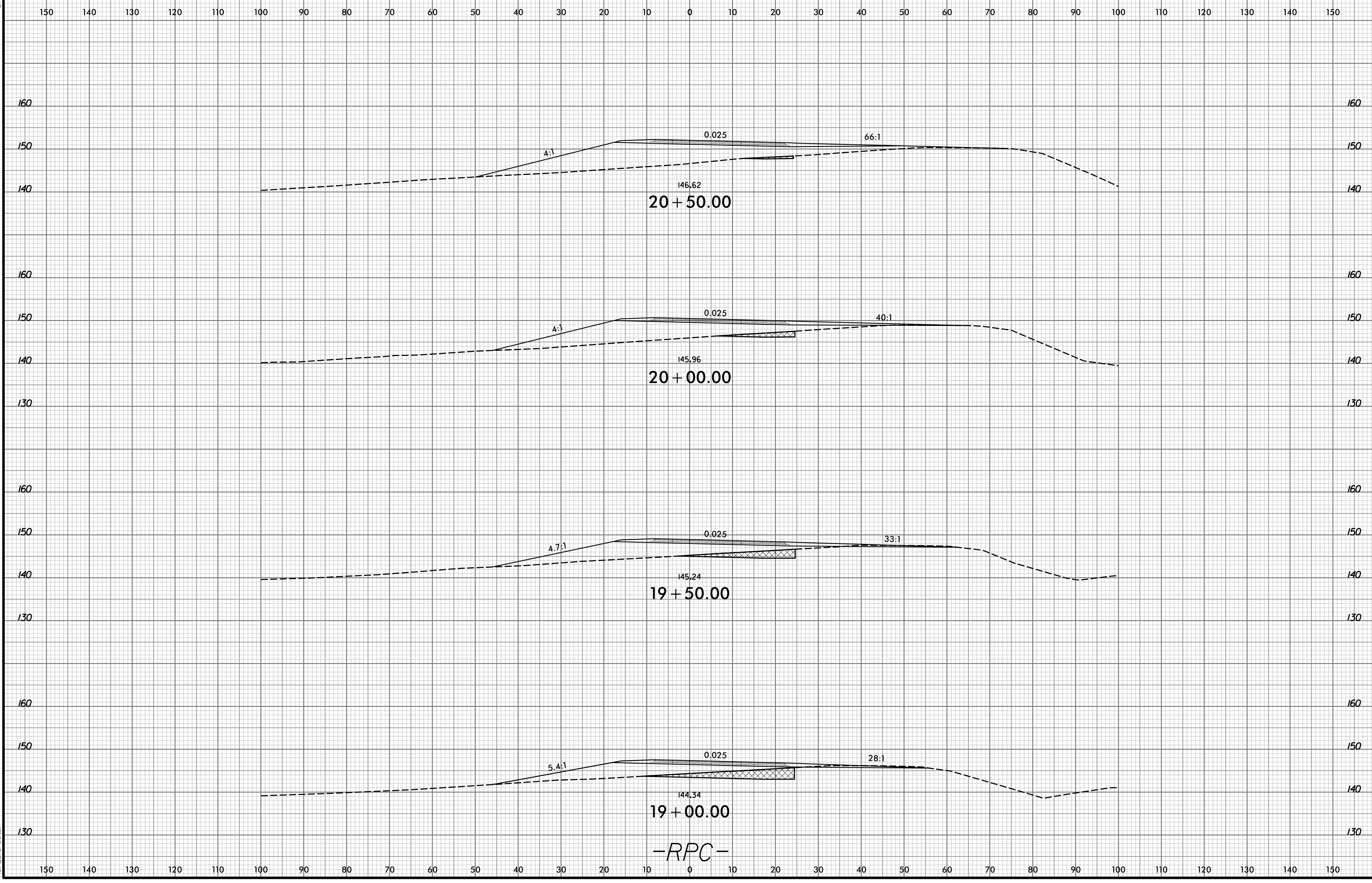

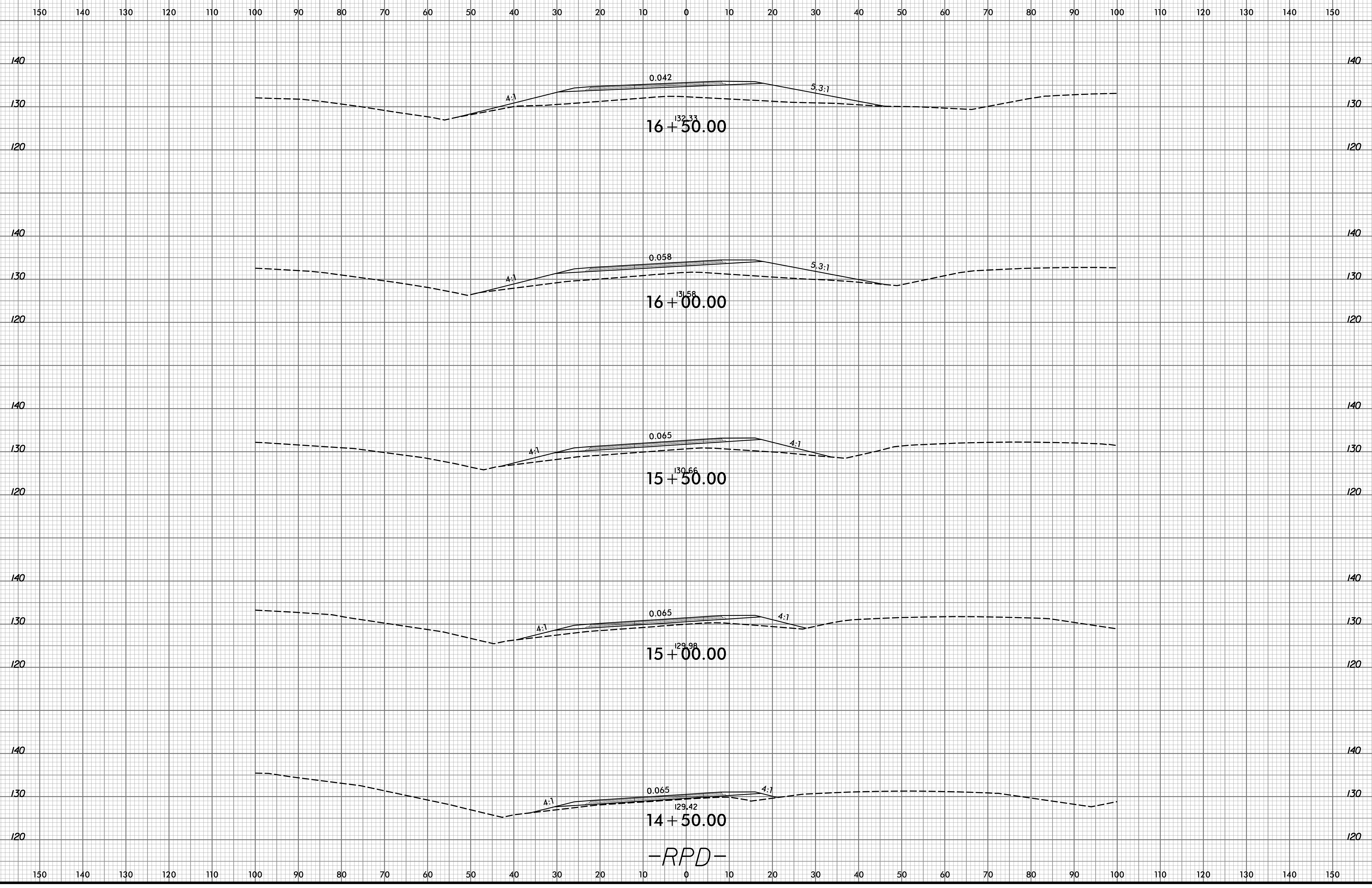

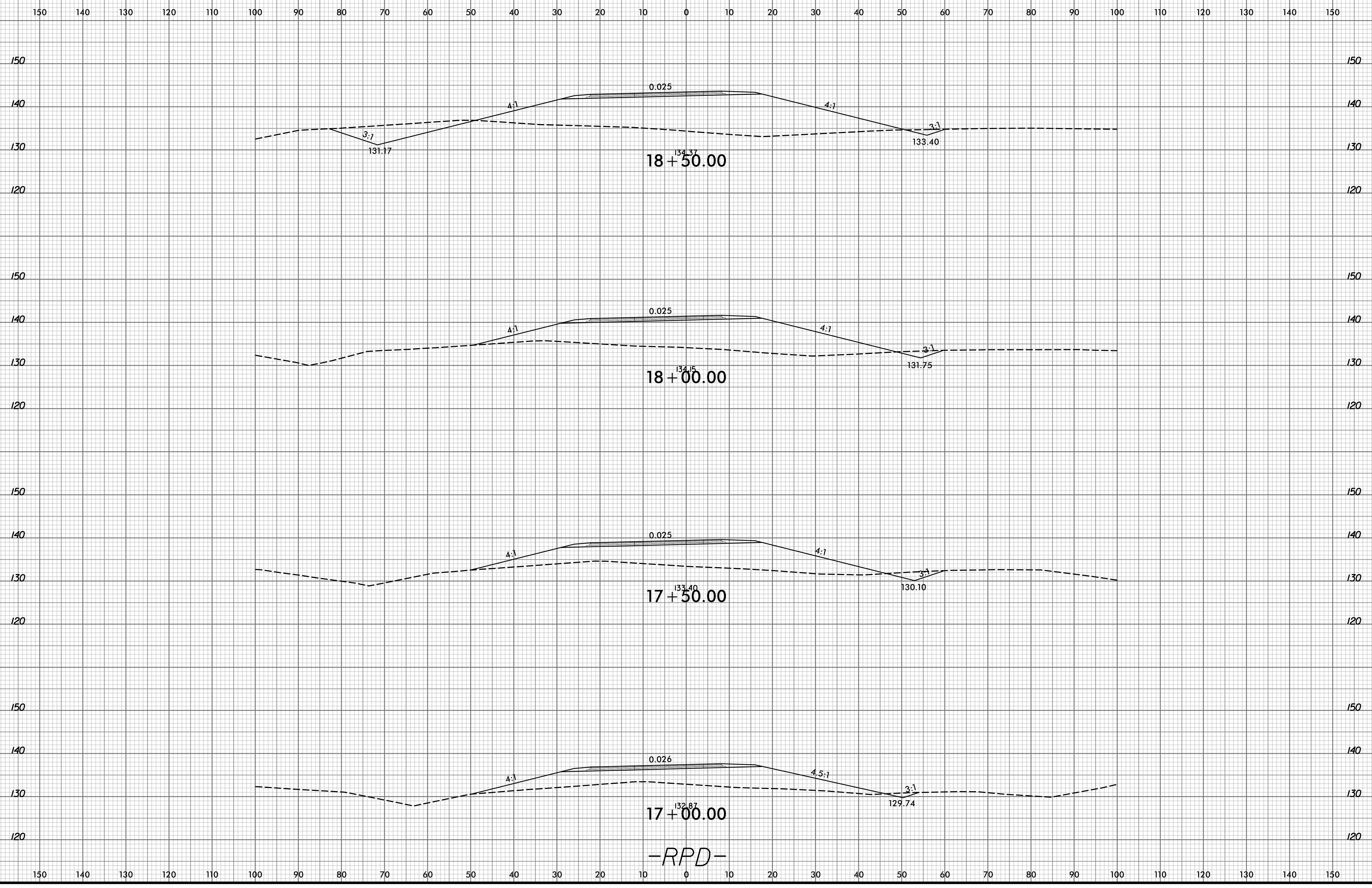

-RPD-

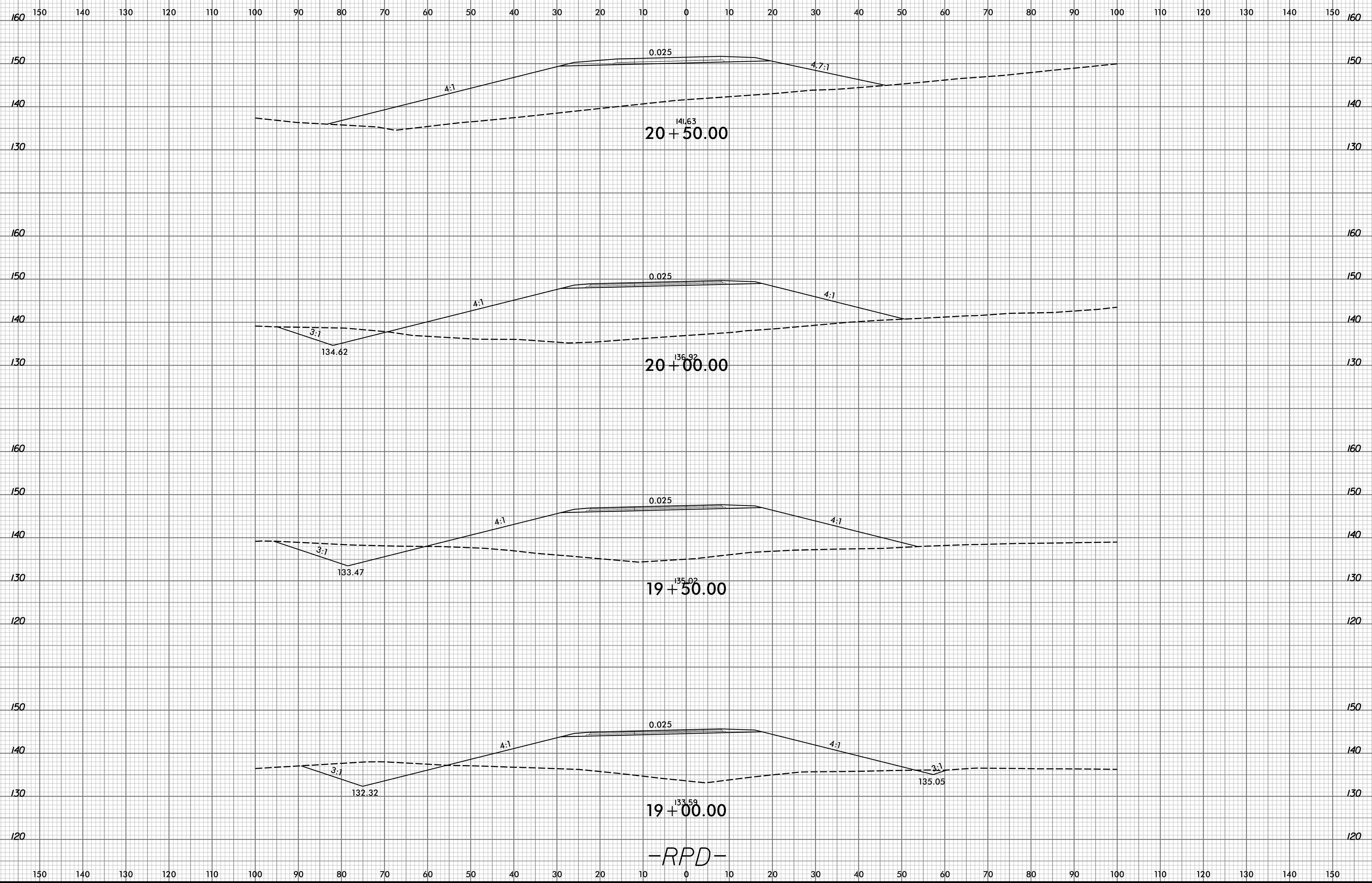

-RPD-

150 140 130 120 110 100 90 80 70 60 50 40 30 20 10 0 10 20 30 40 50 60 70 80 90 100 110 120 130 140 150

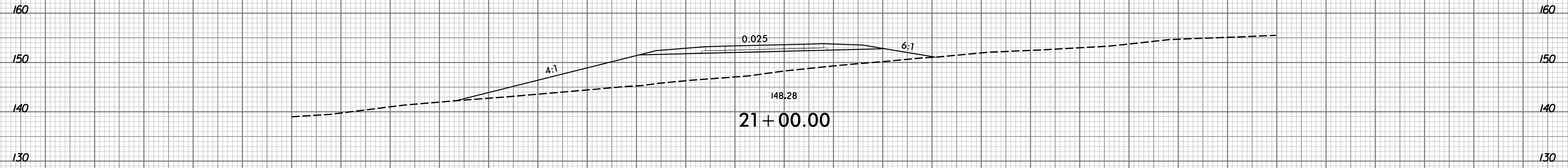

150 140 130 120 110 100 90 80 70 60 50 40 30 20 10 0 10 20 30 40 50 60 70 80 90 100 110 120 130 140 150

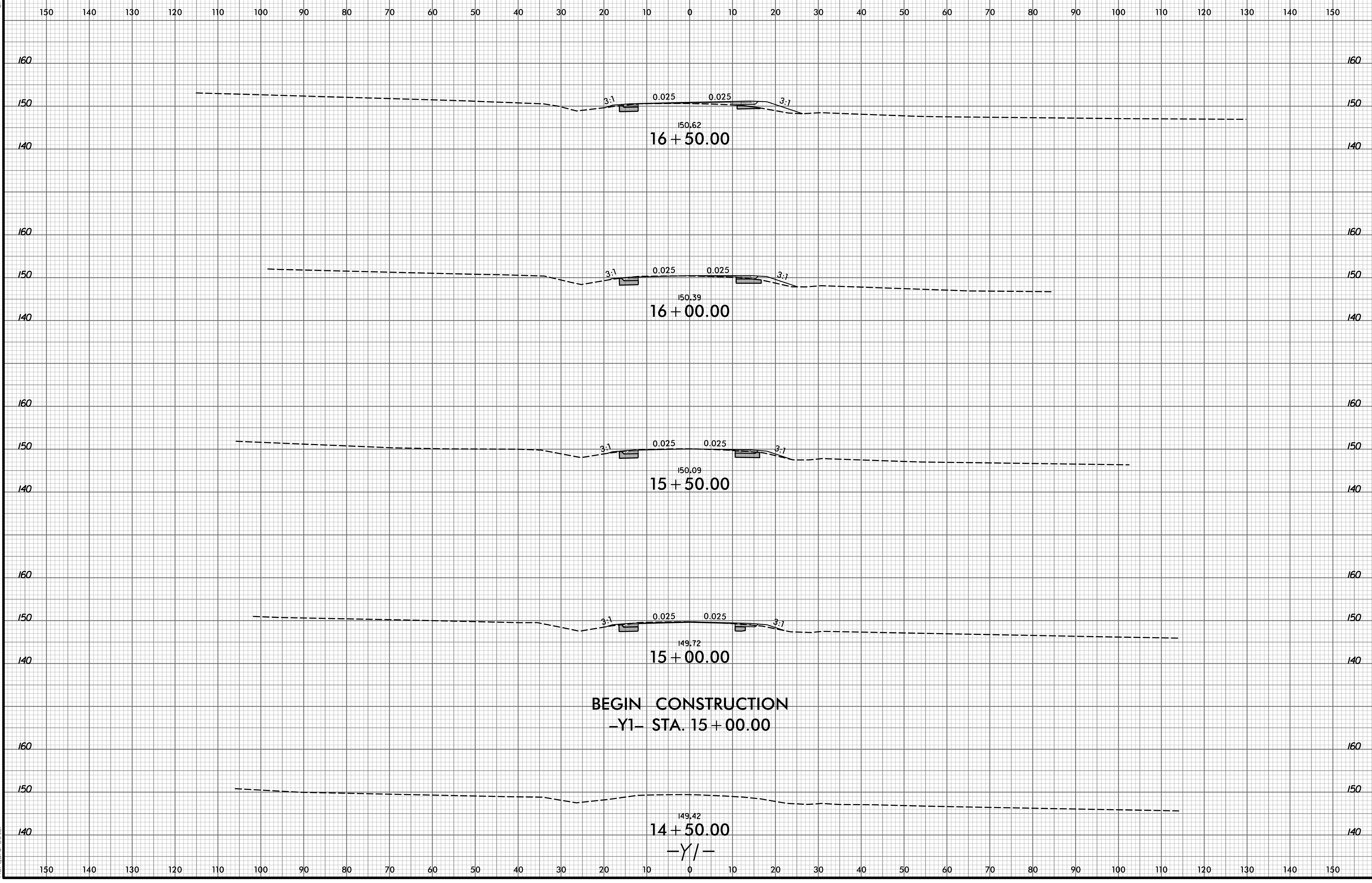

BEGIN CONSTRUCTION
-Y1- STA. 15 + 00.00

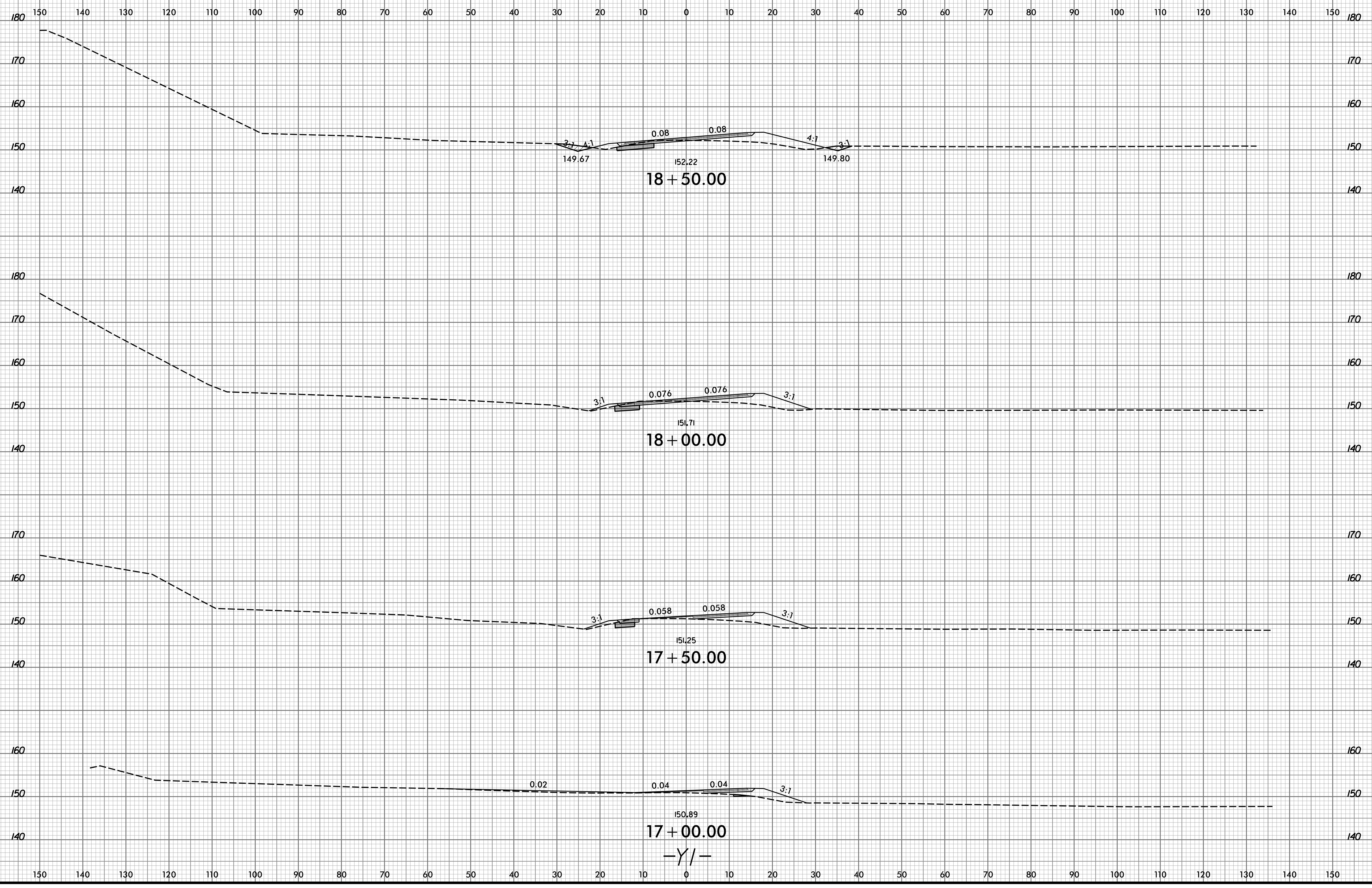

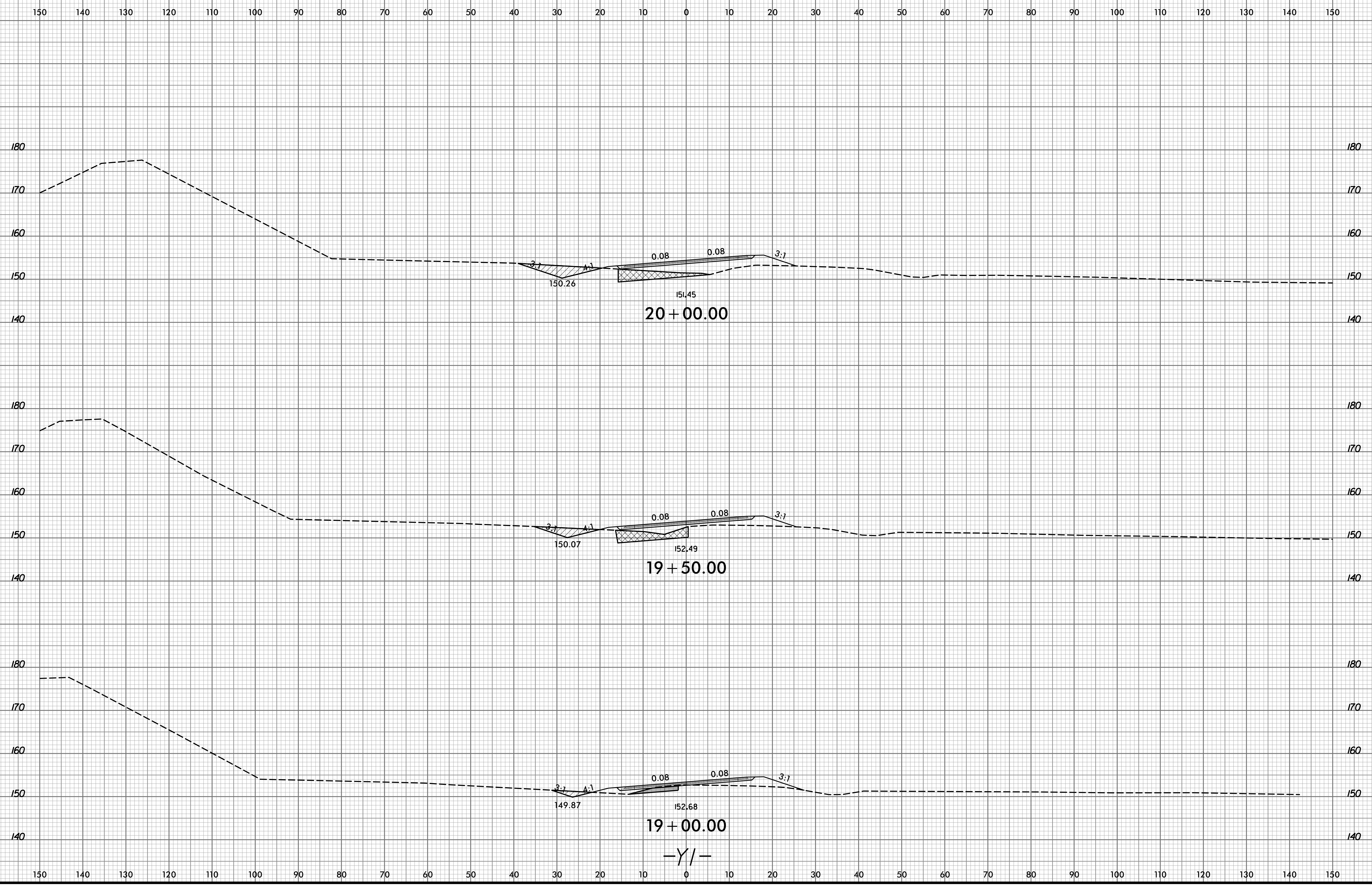

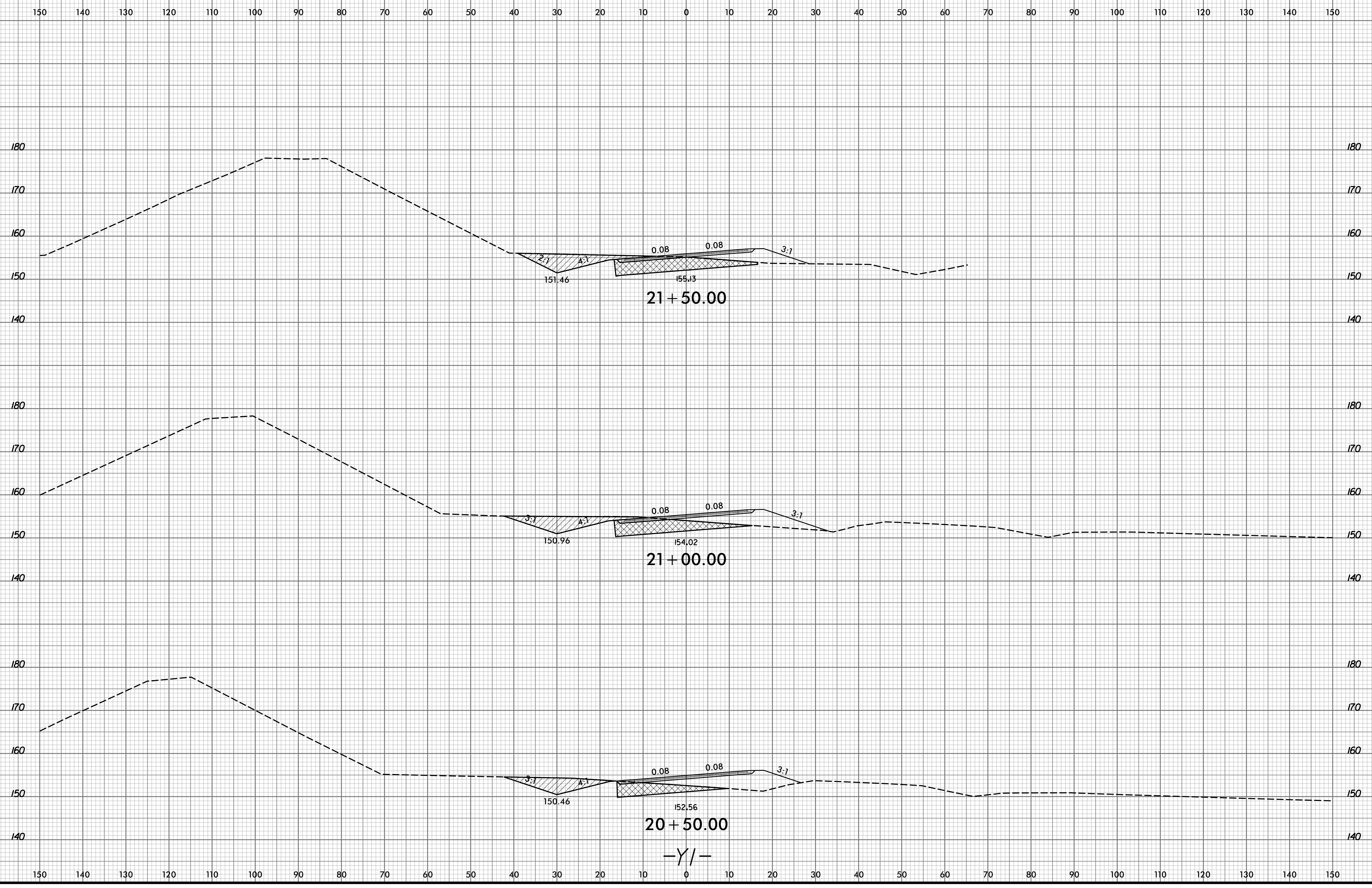

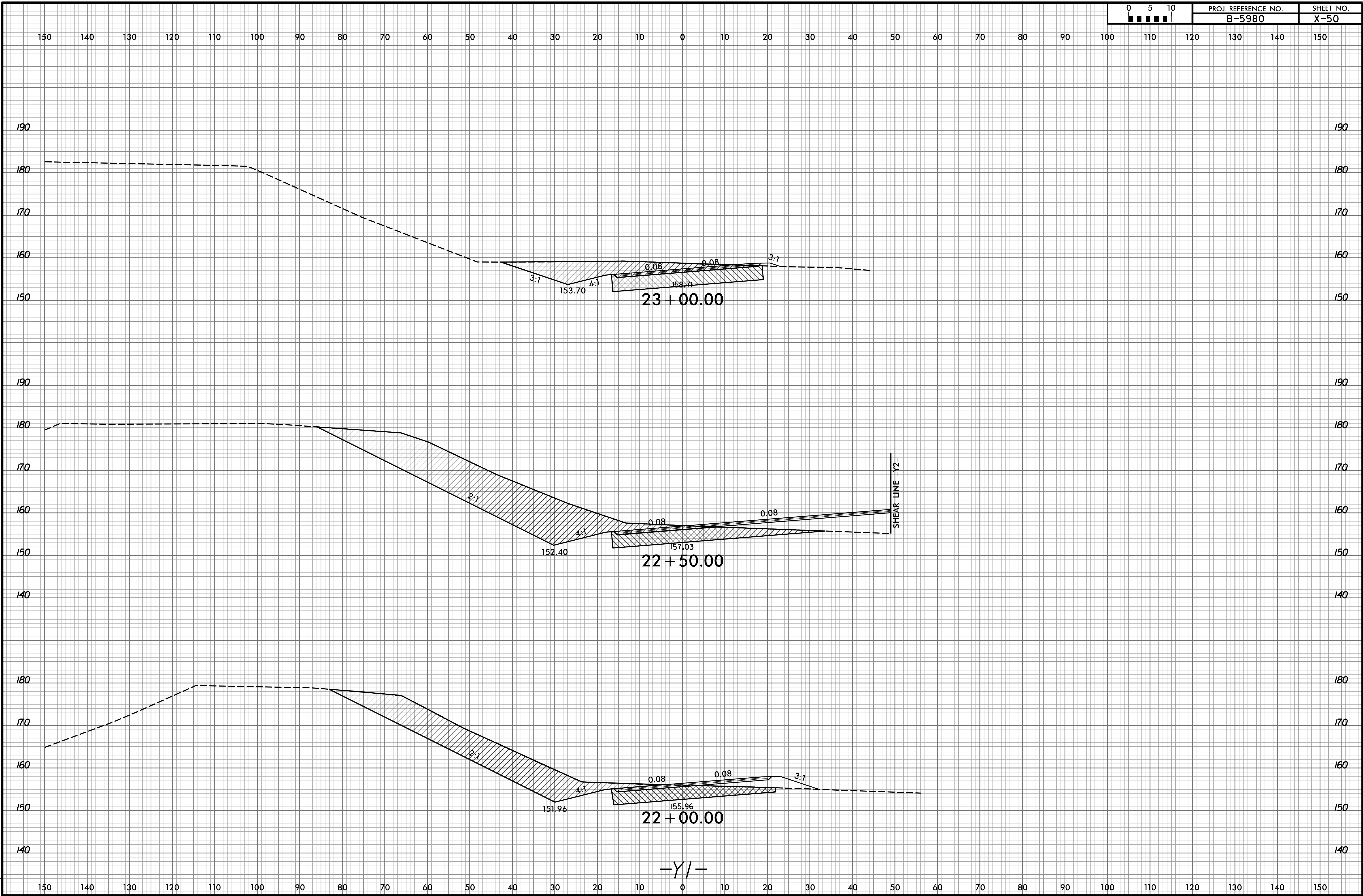

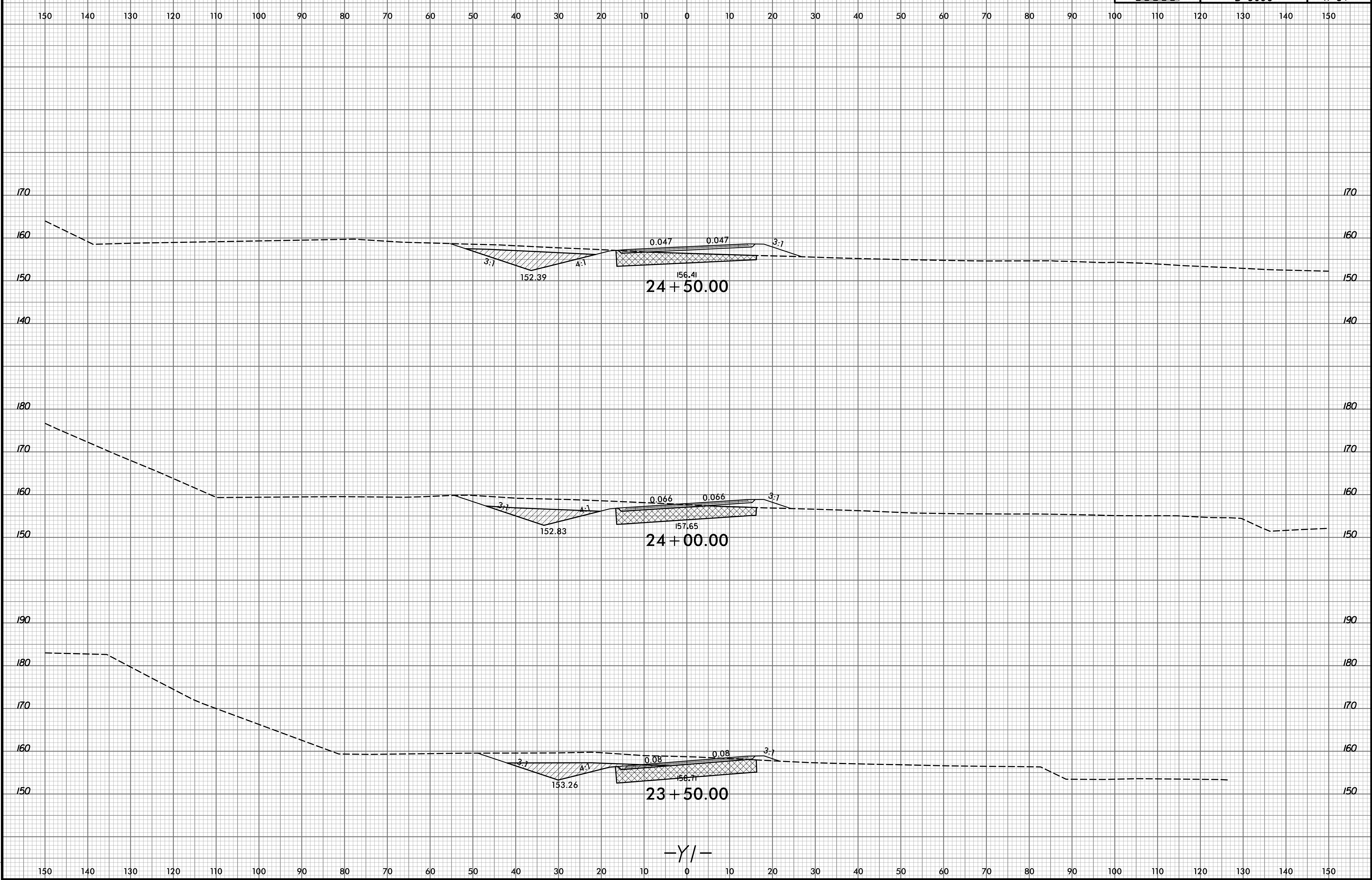

-Y/-

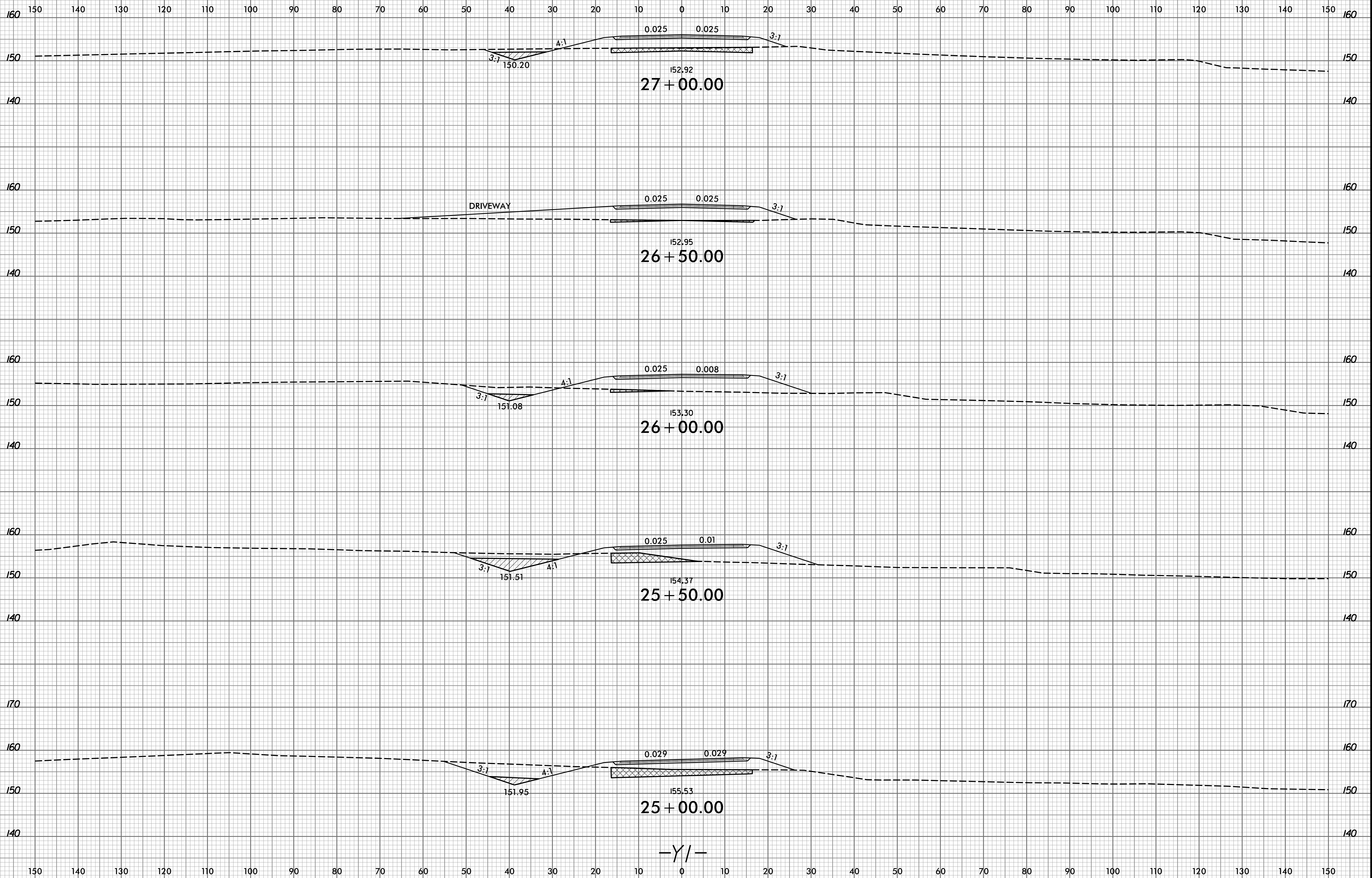

-Y/-

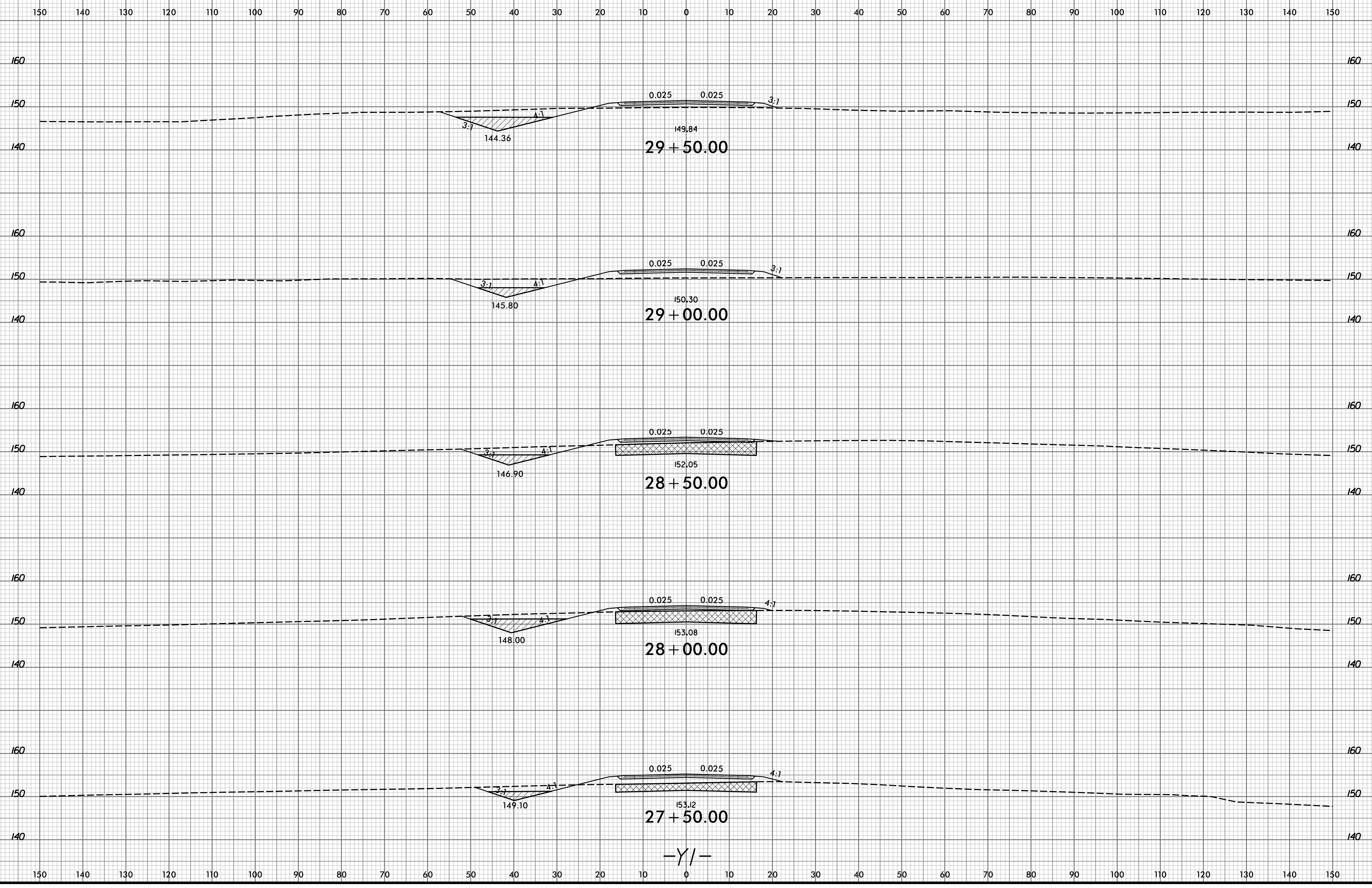

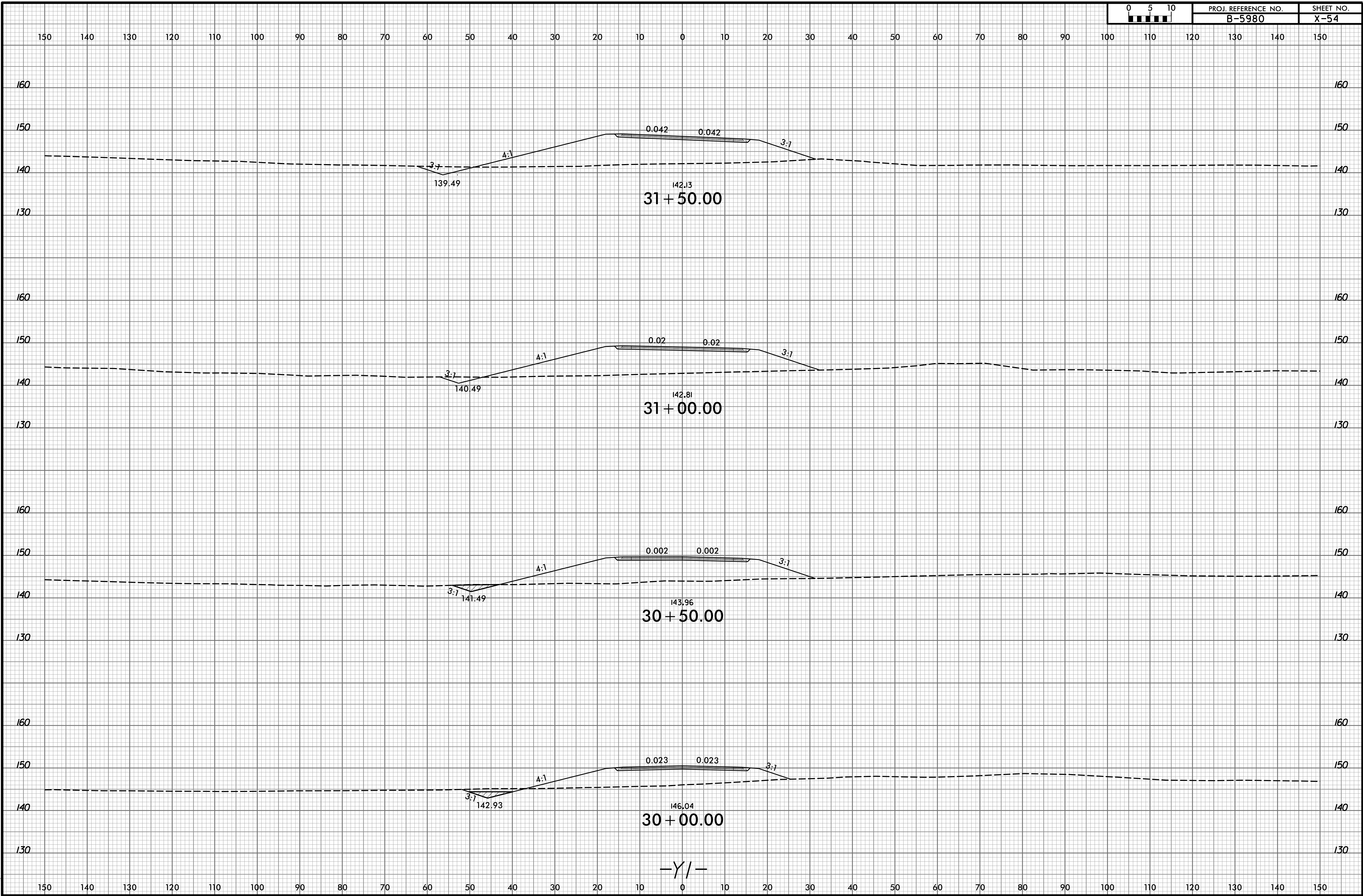

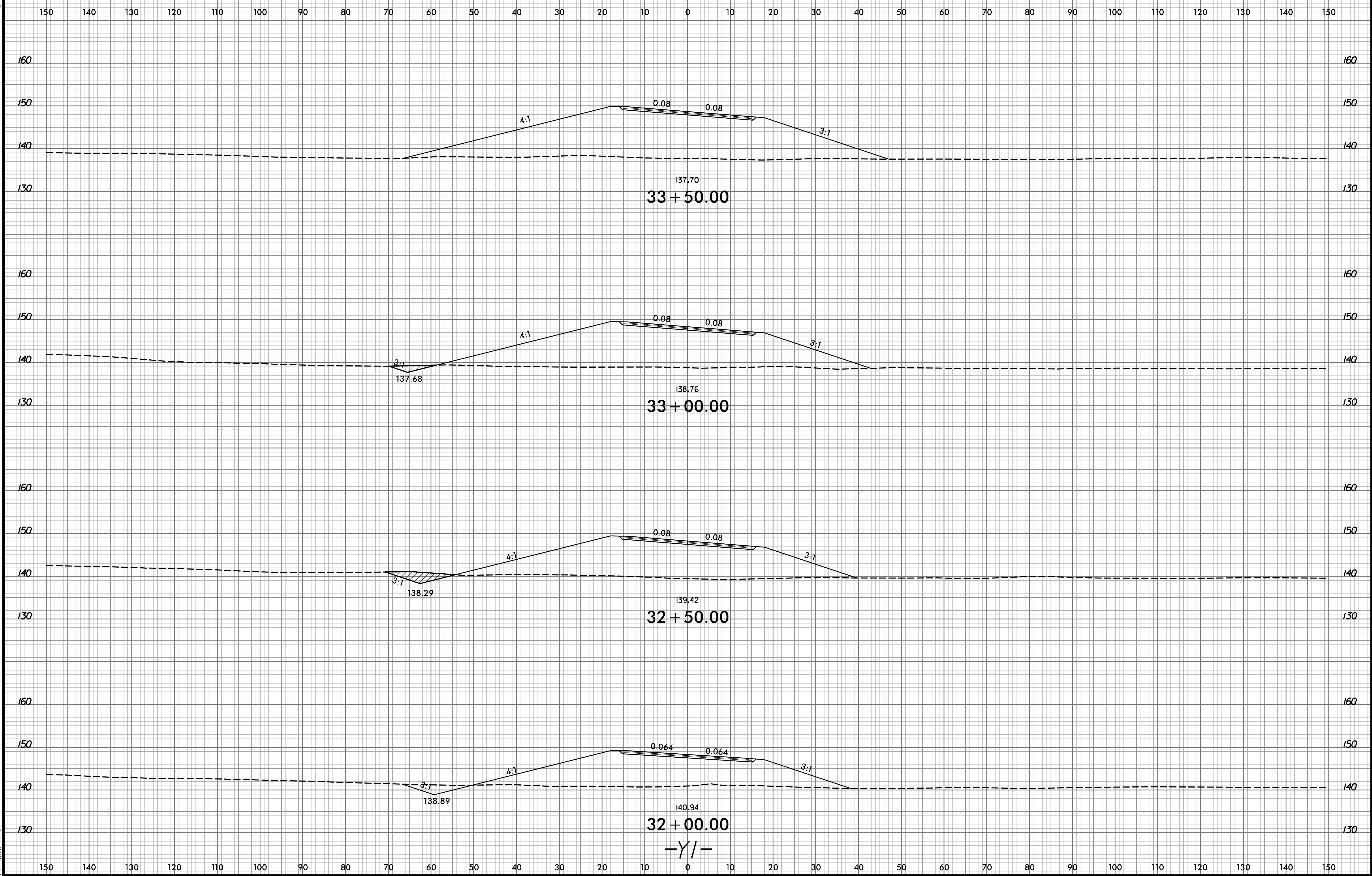

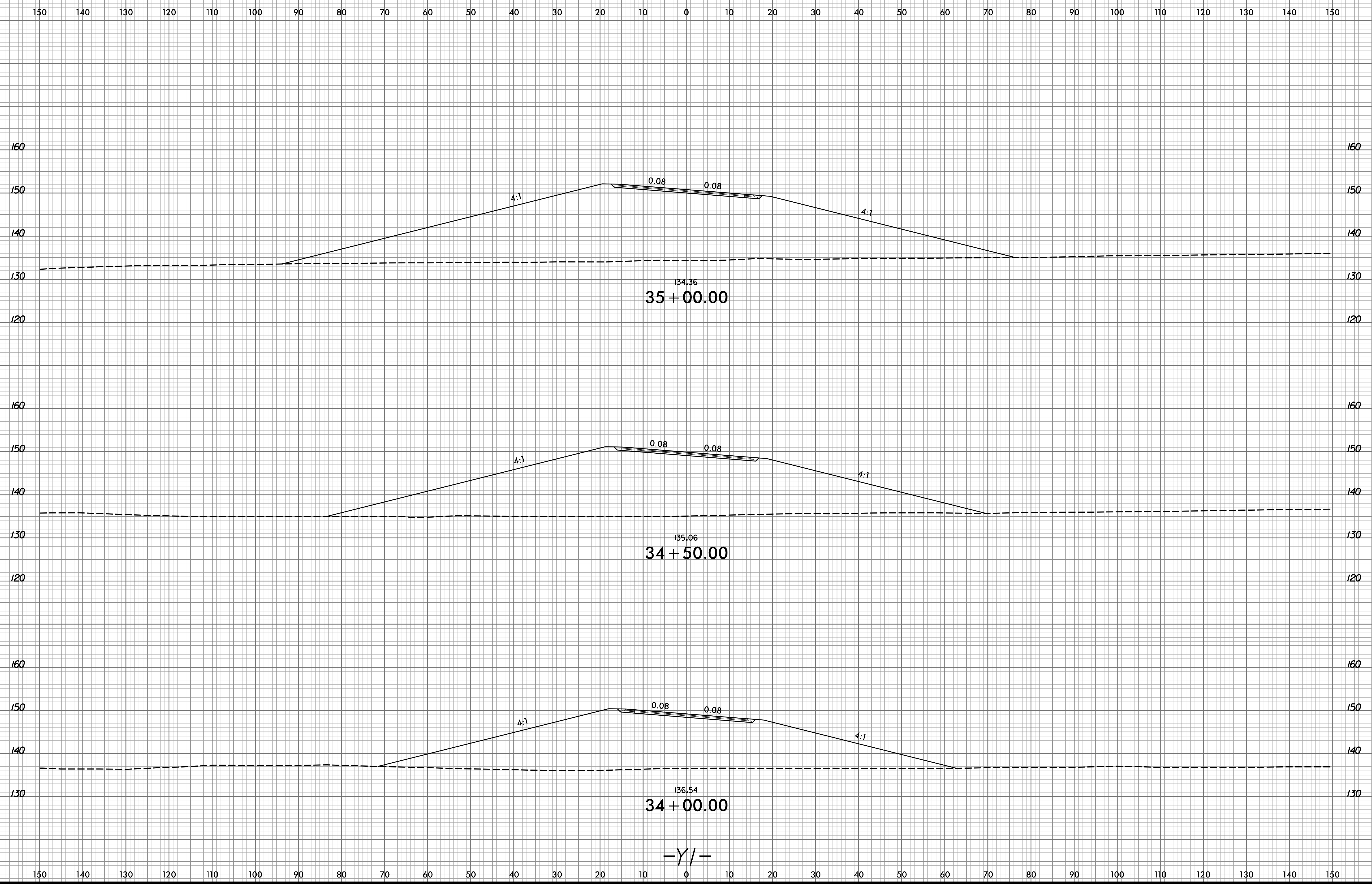

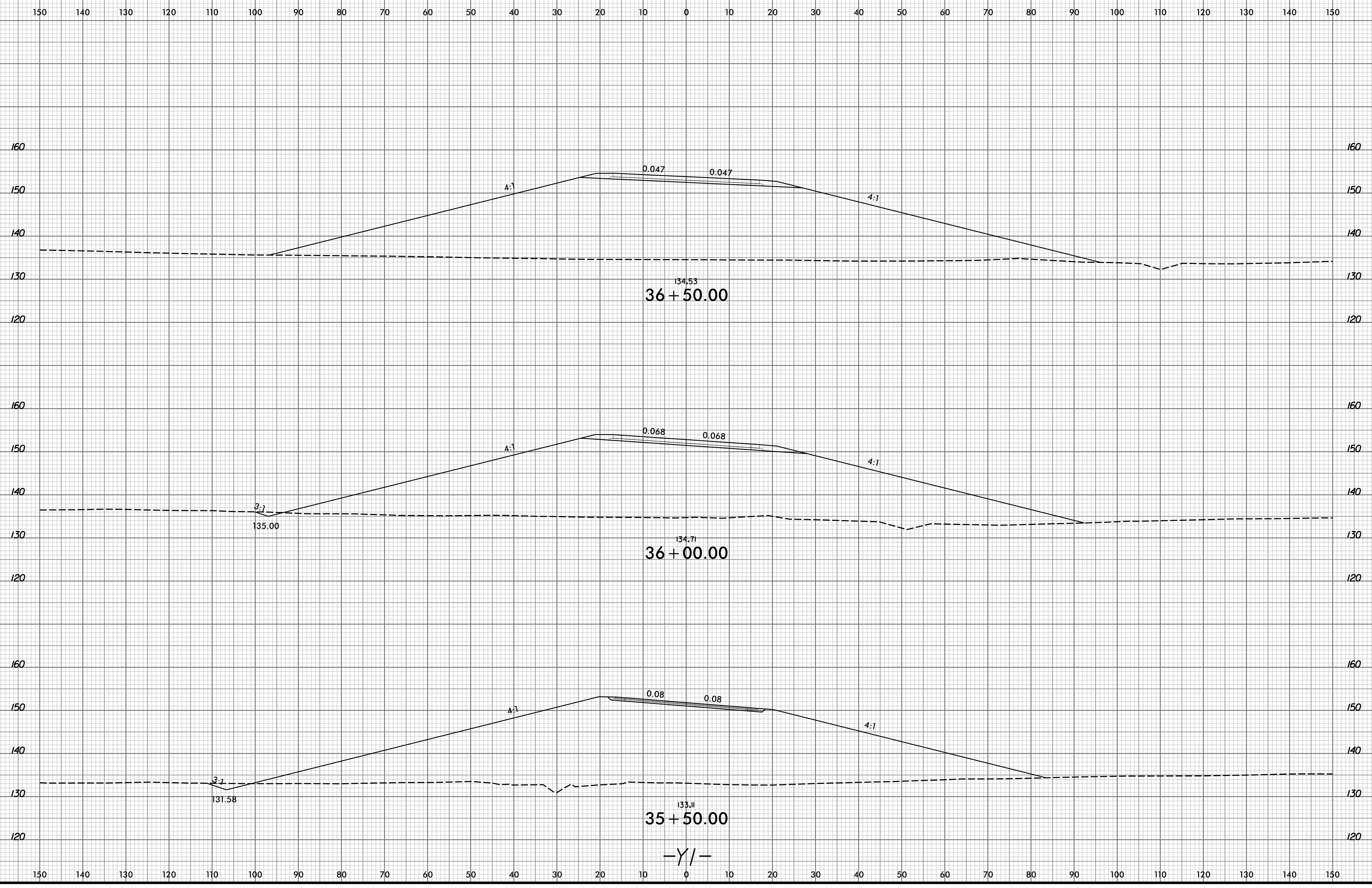

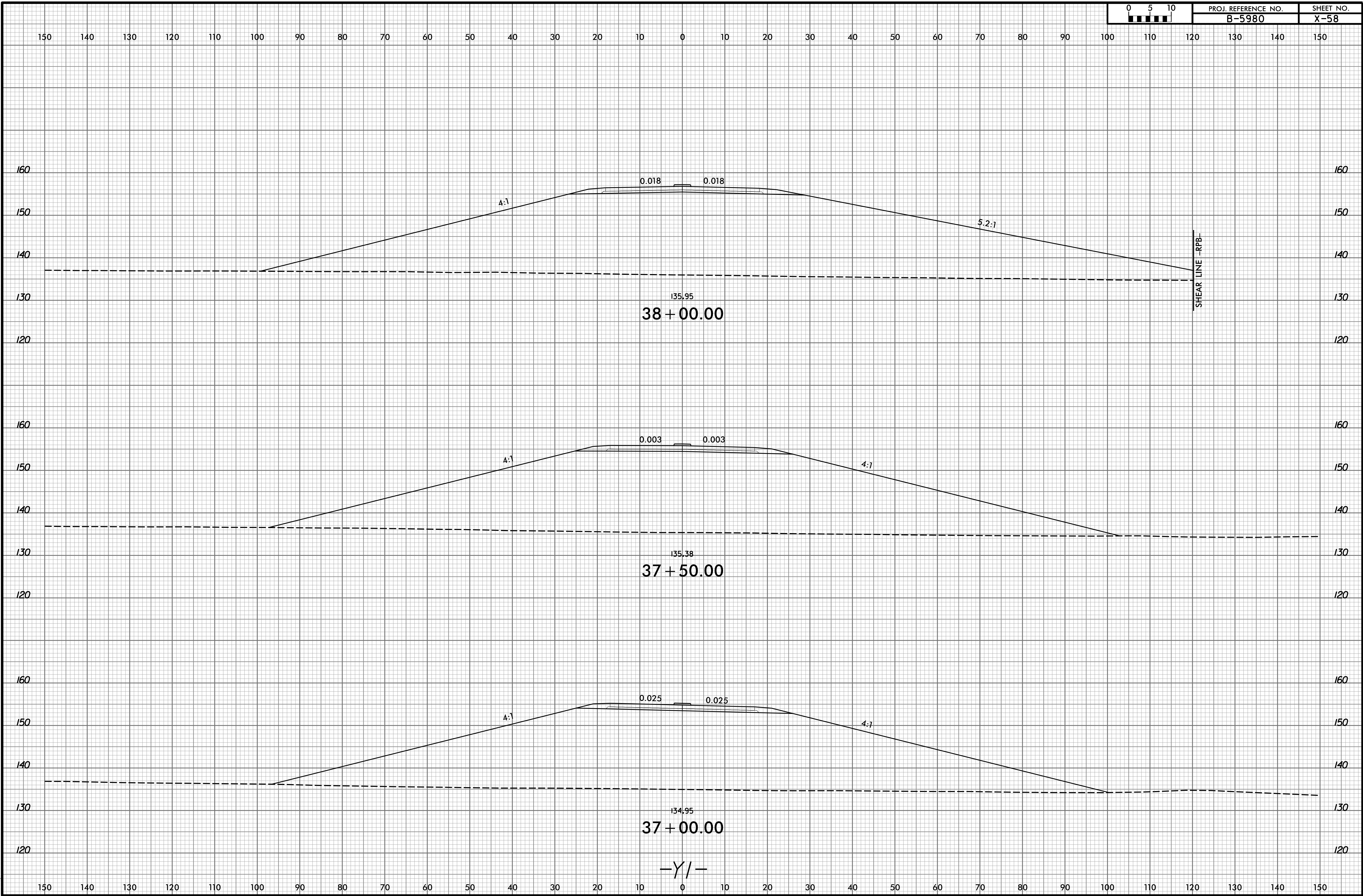

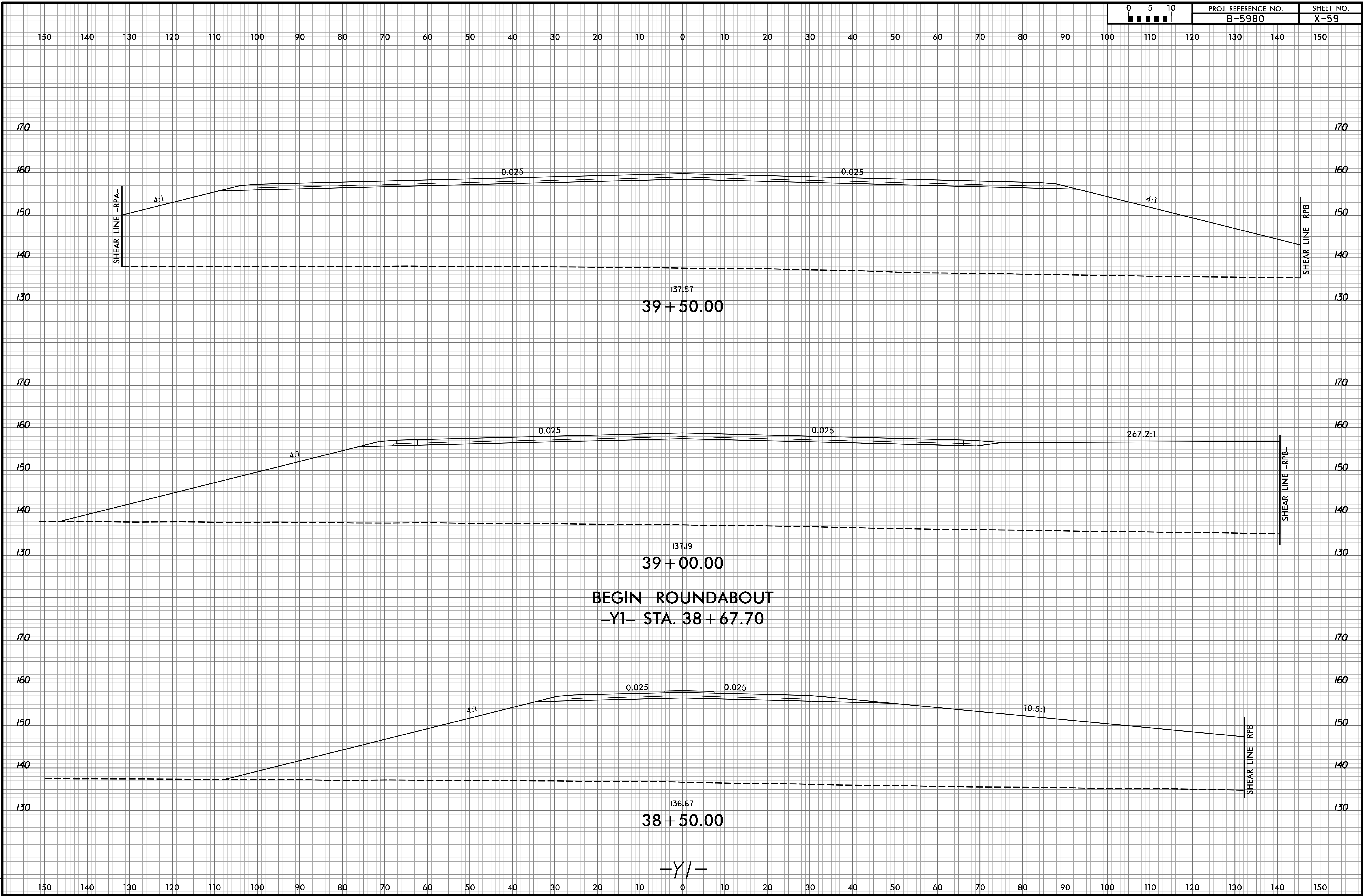

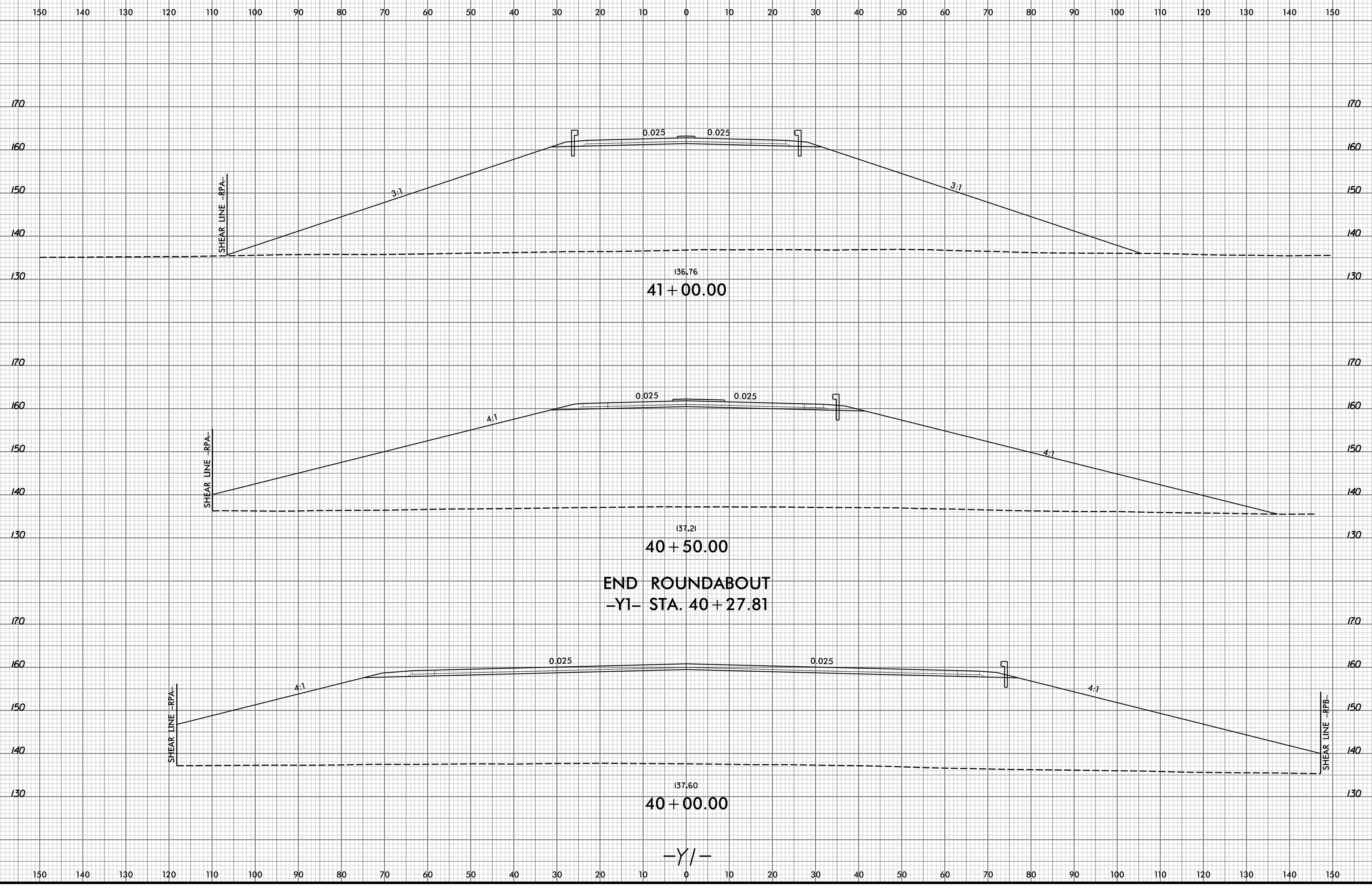

END ROUNDABOUT
-Y1- STA. 40 + 27.81

-Y1-

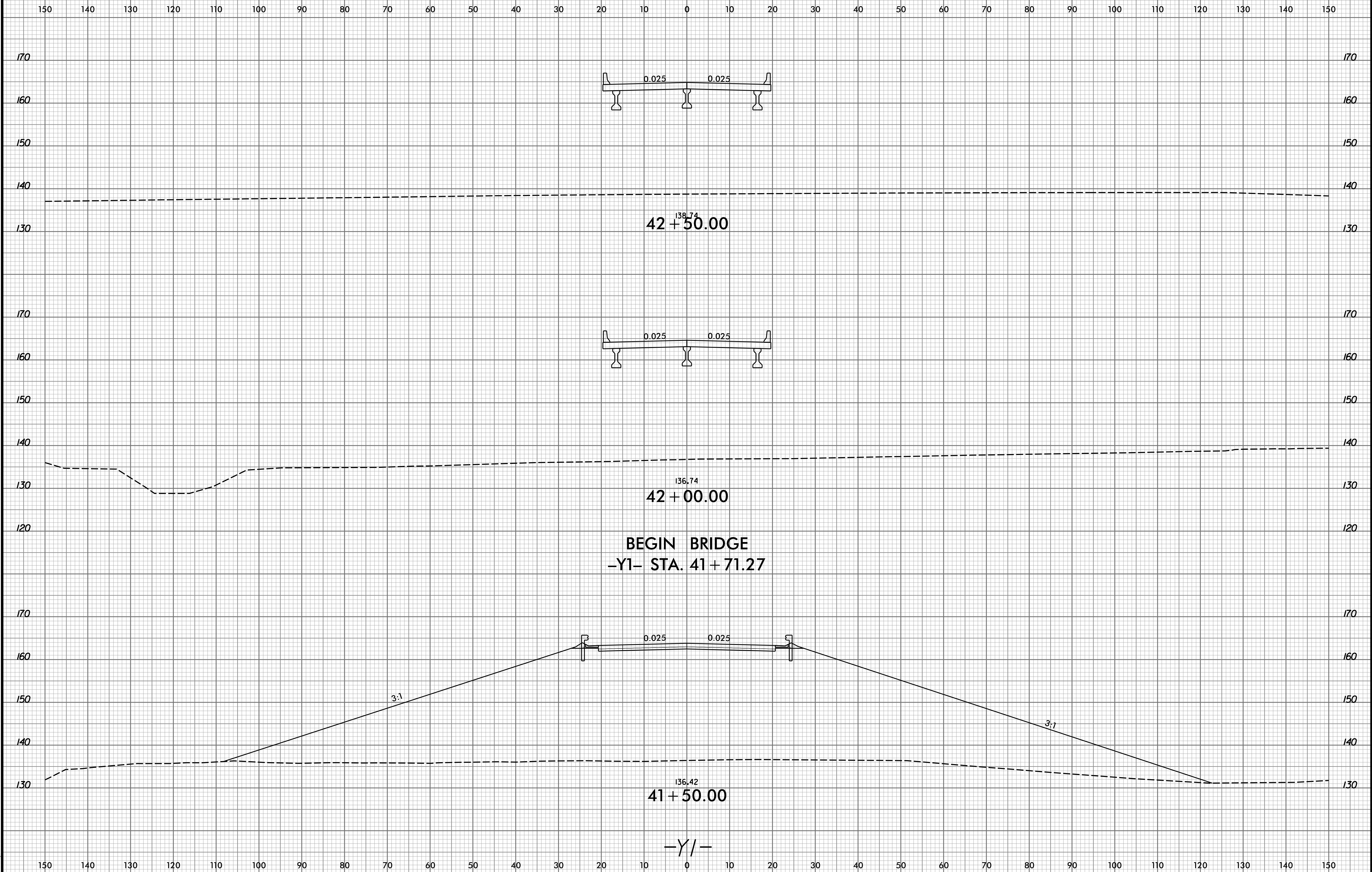

150 140 130 120 110 100 90 80 70 60 50 40 30 20 10 0 10 20 30 40 50 60 70 80 90 100 110 120 130 140 150

END BRIDGE
-Y1- STA. 44 + 03.26

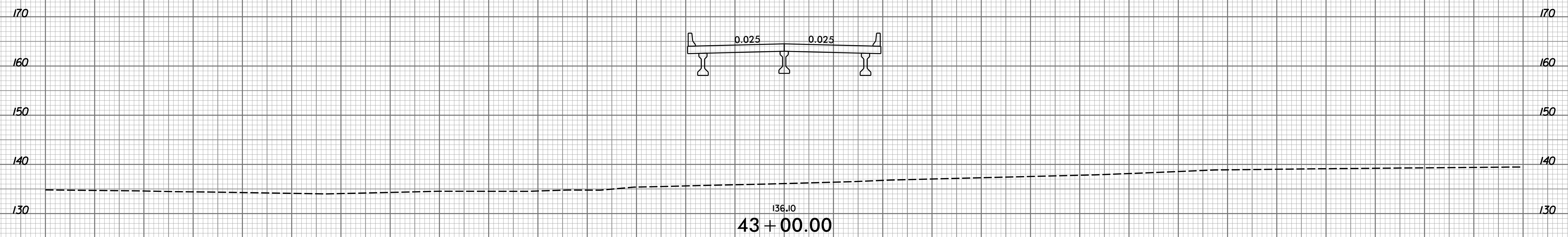
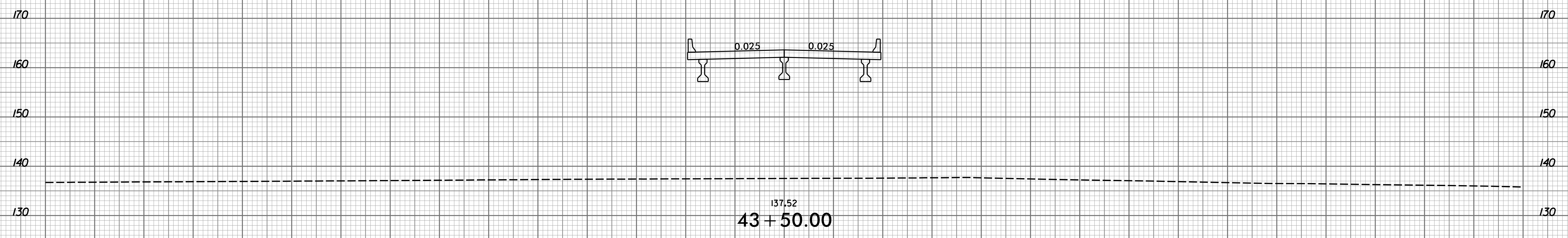
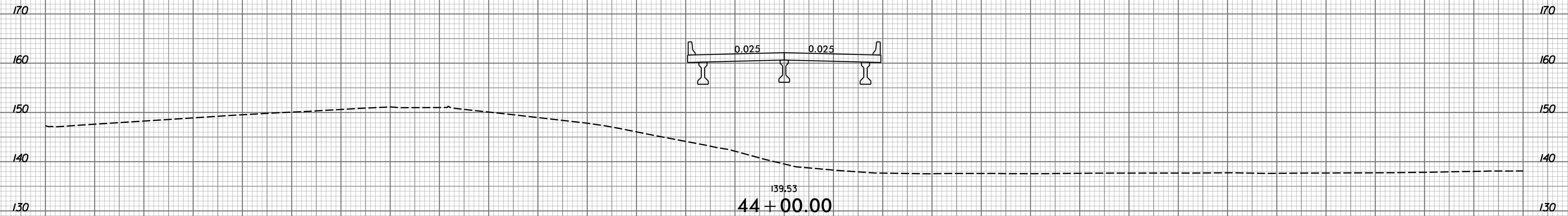

-Y1-

150 140 130 120 110 100 90 80 70 60 50 40 30 20 10 0 10 20 30 40 50 60 70 80 90 100 110 120 130 140 150

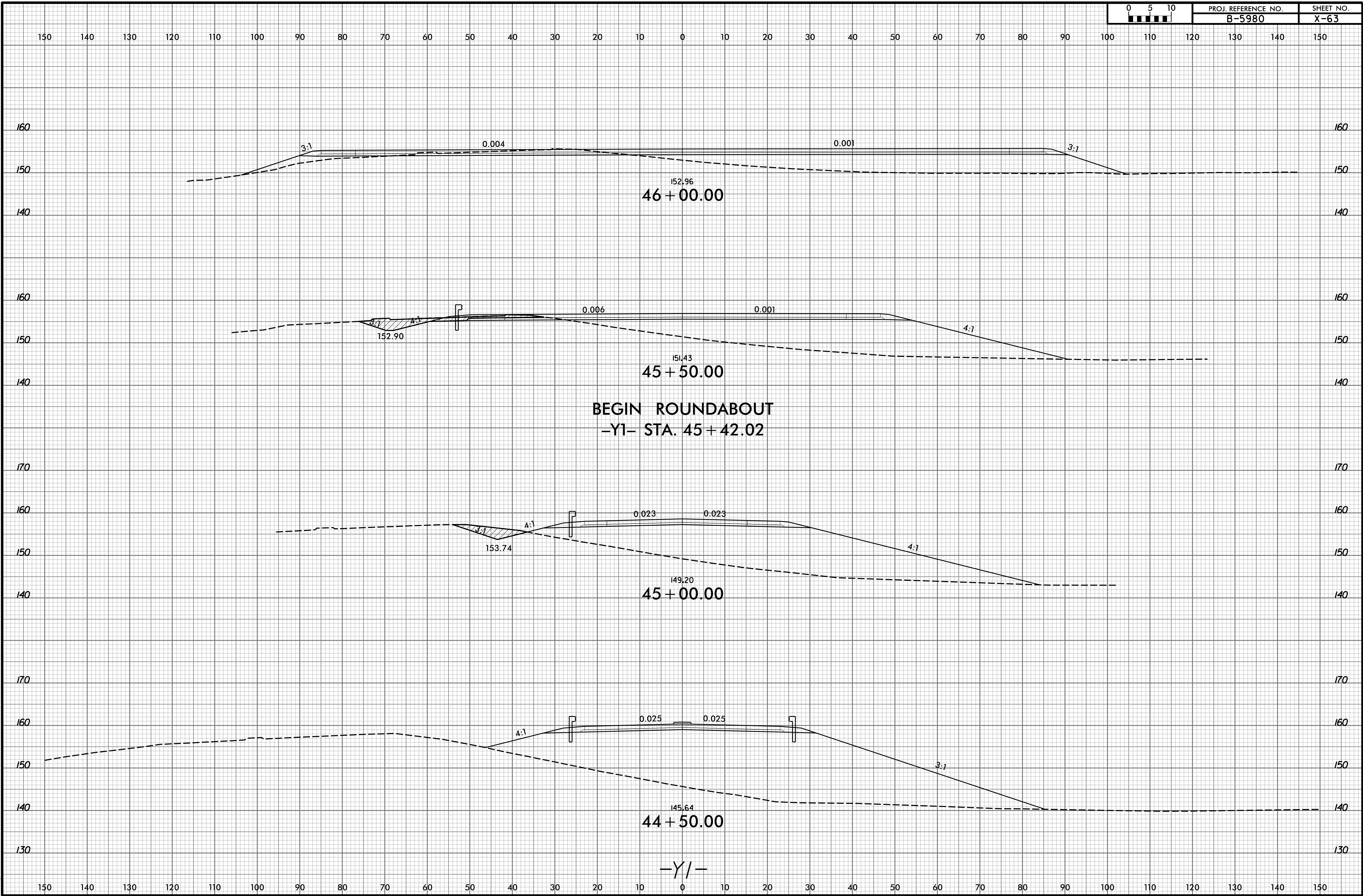

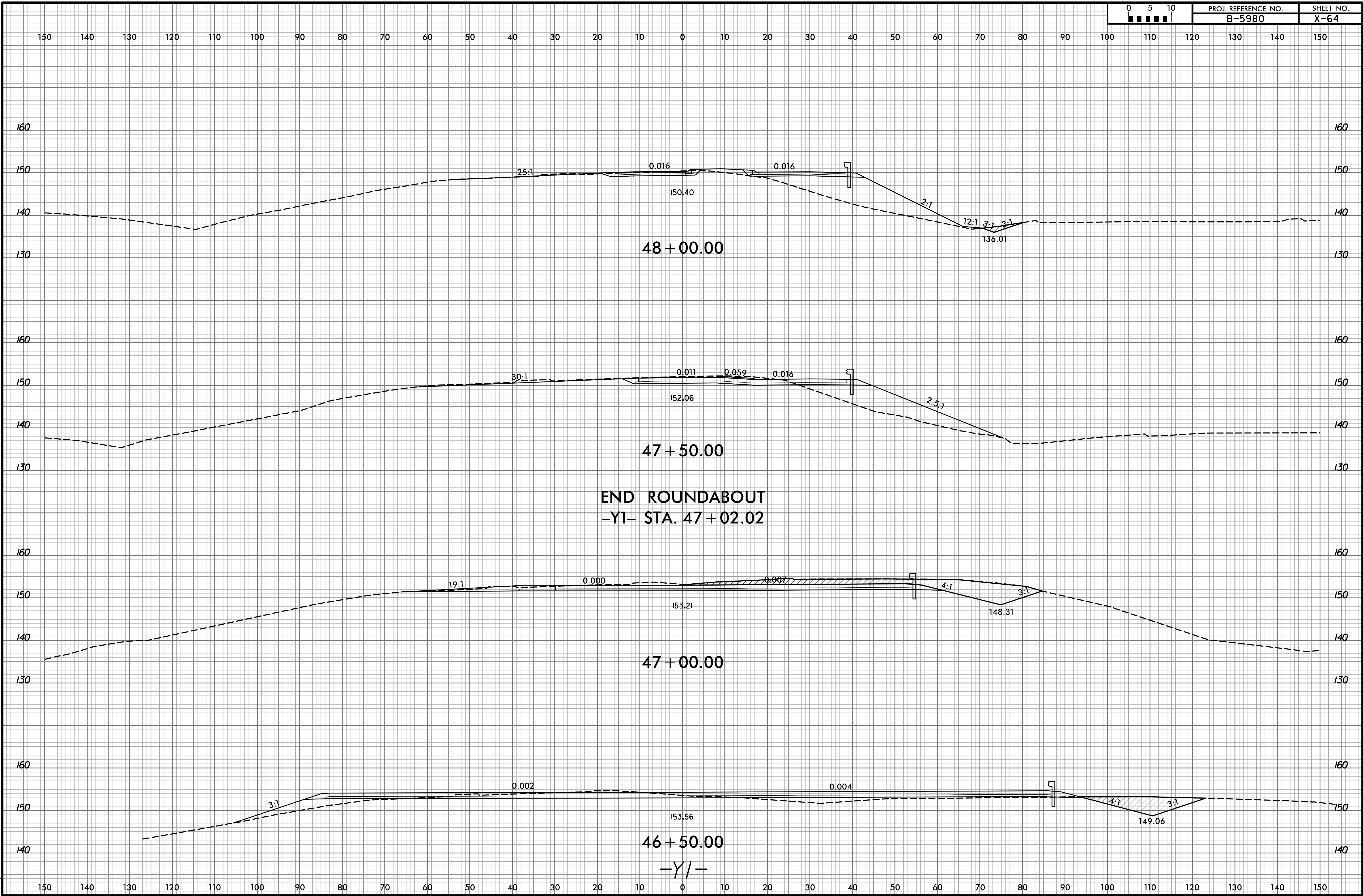

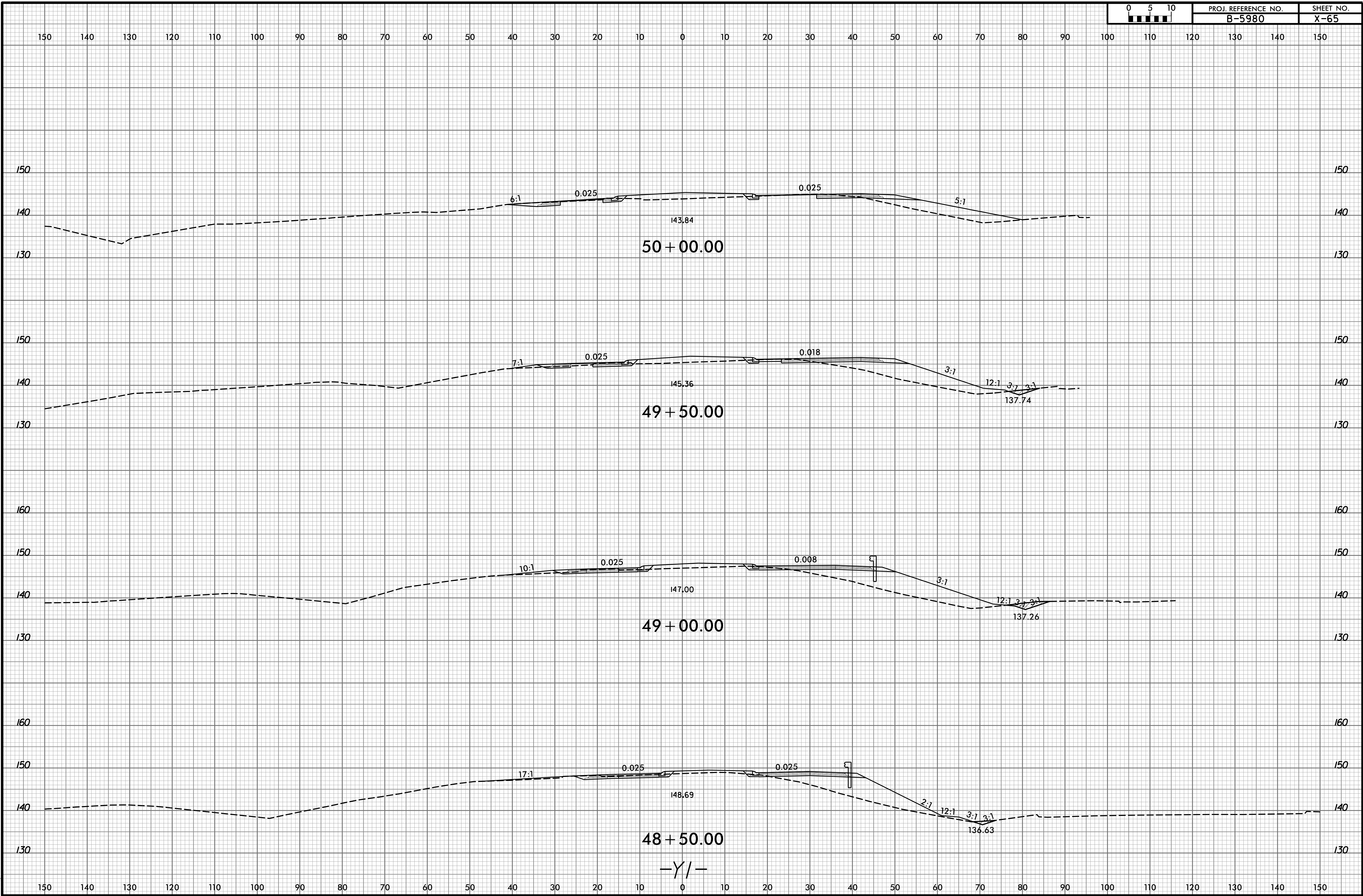

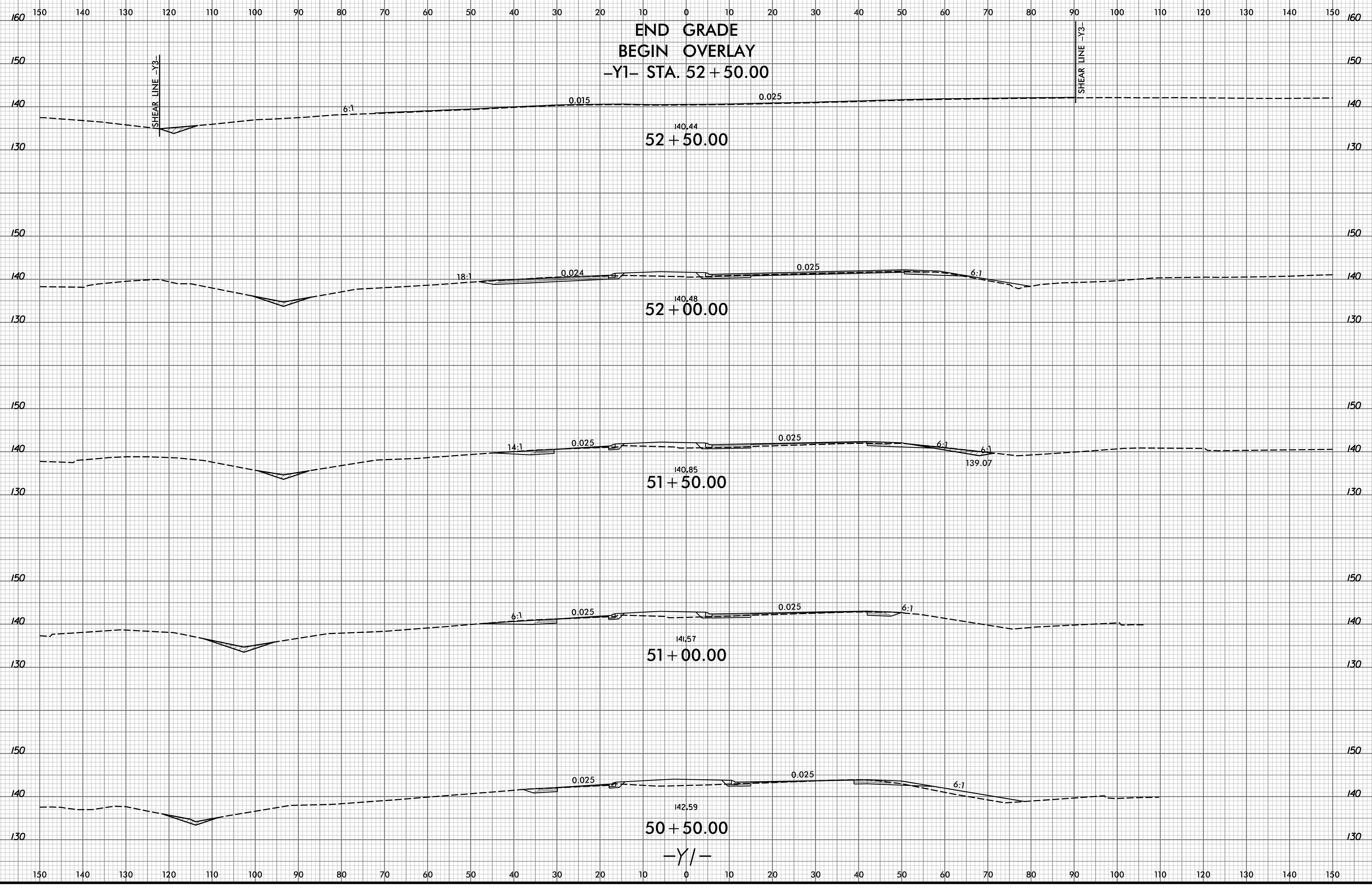

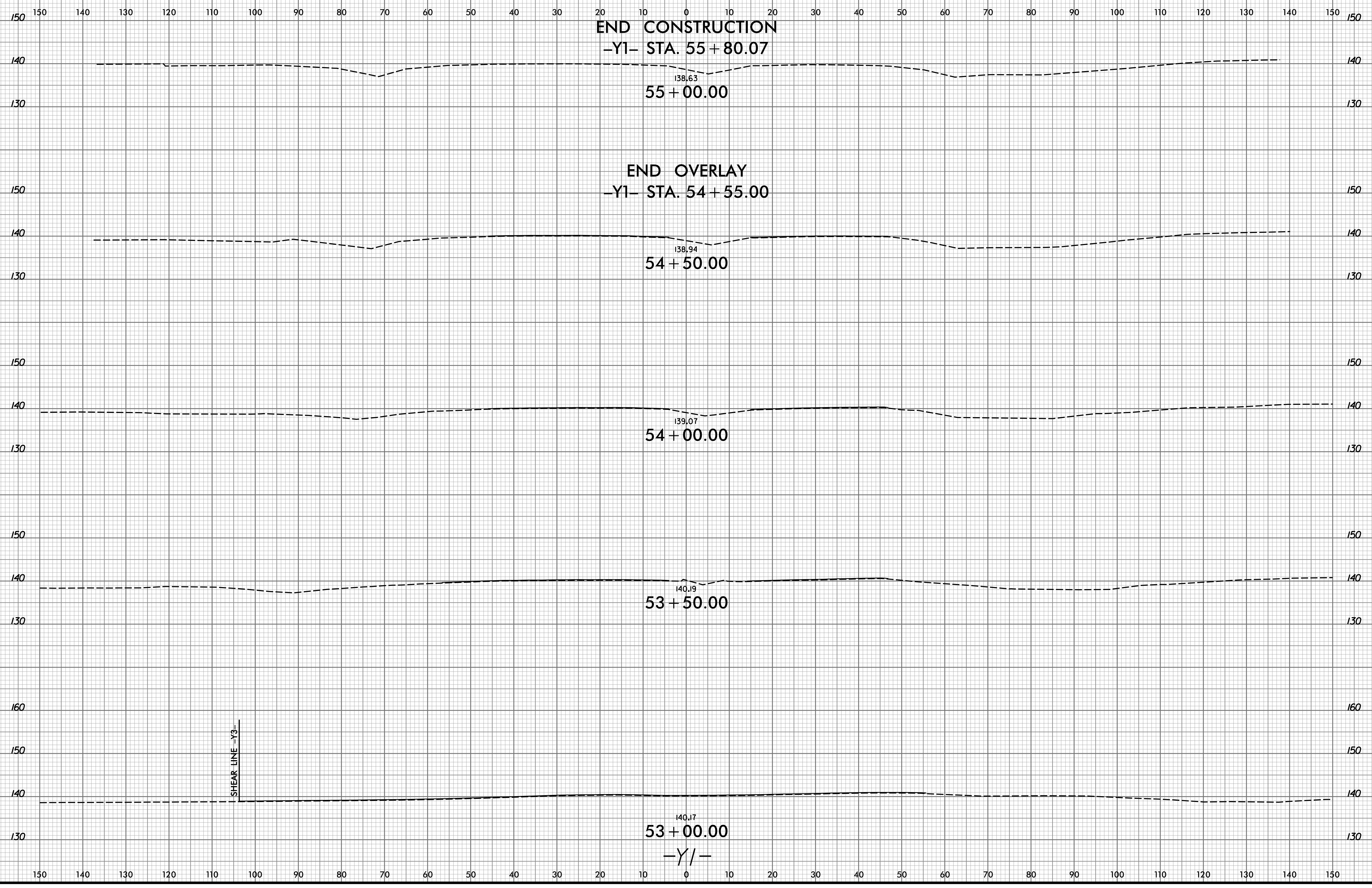

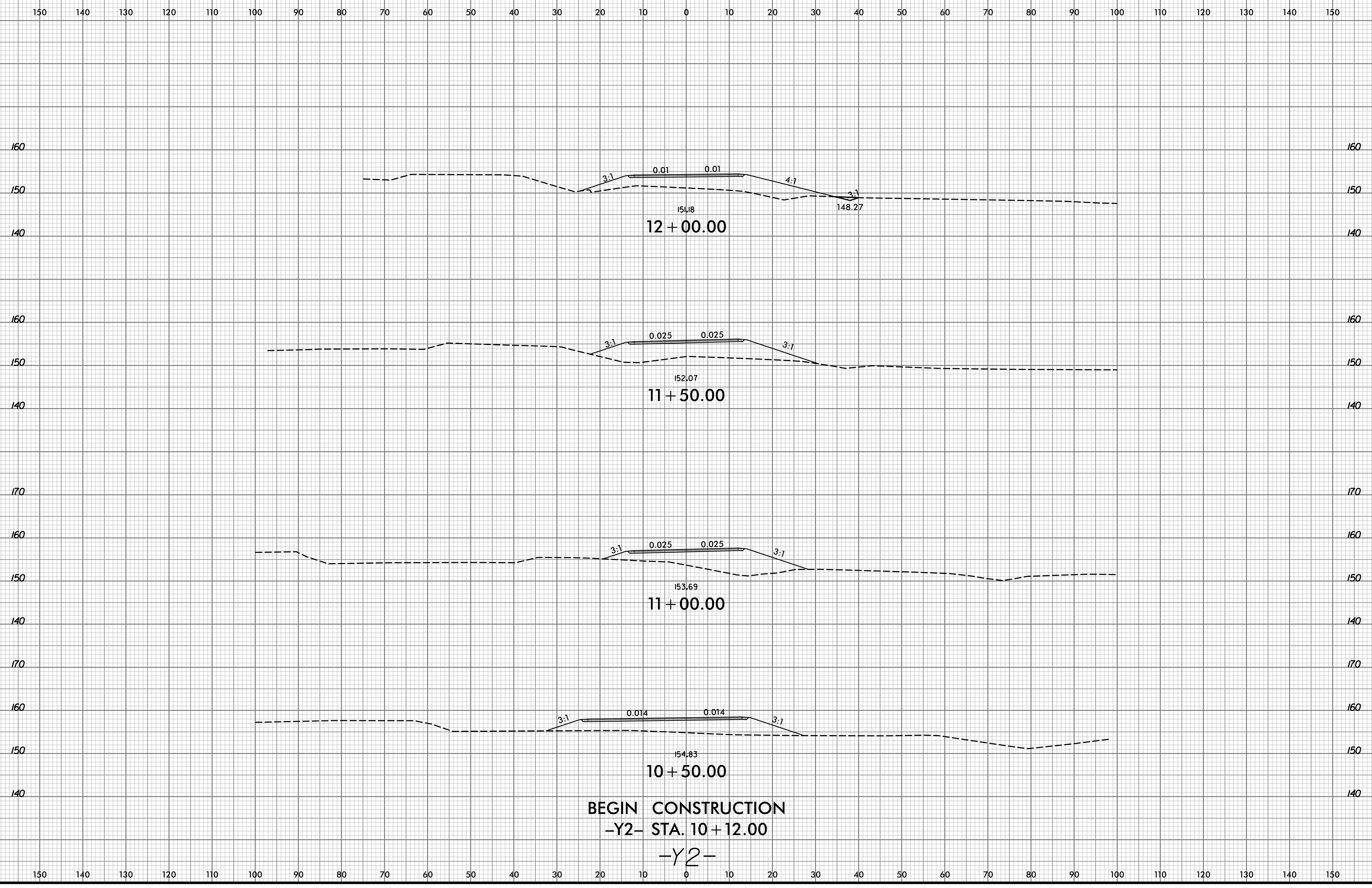

BEGIN CONSTRUCTION
 -Y2- STA. 10+12.00
 -Y2-

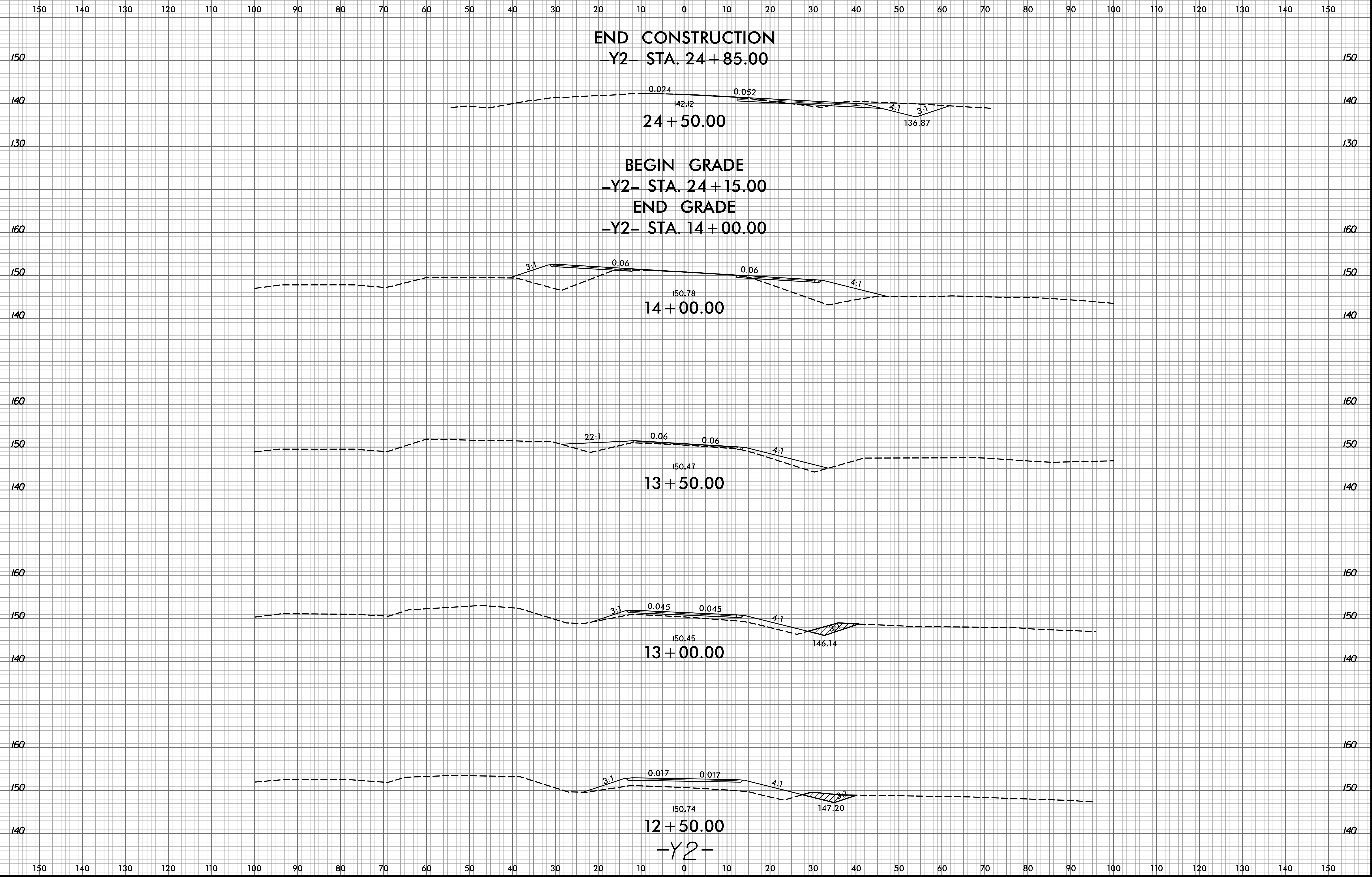

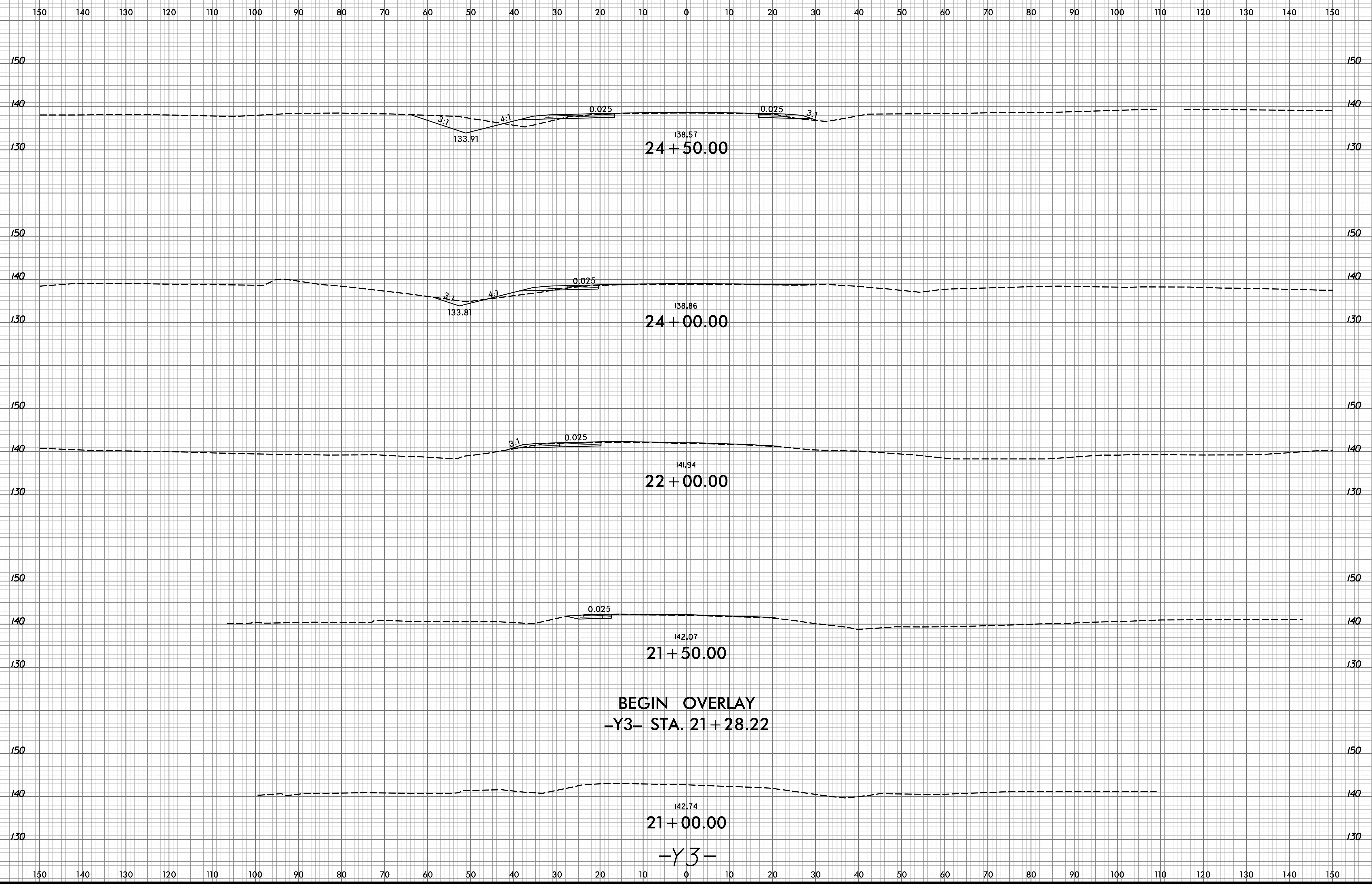

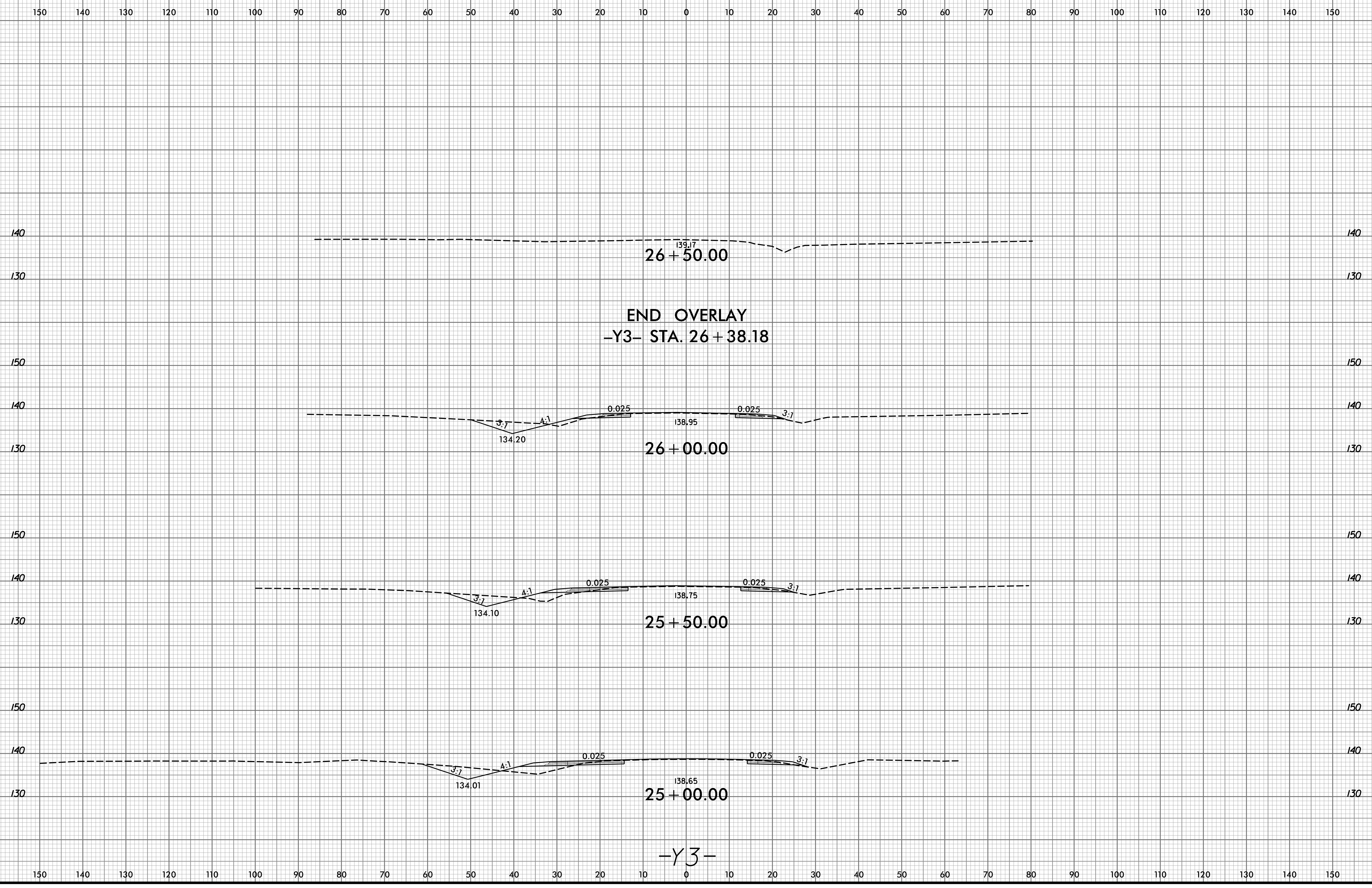

END OVERLAY
-Y3- STA. 26 + 38.18

-Y3-

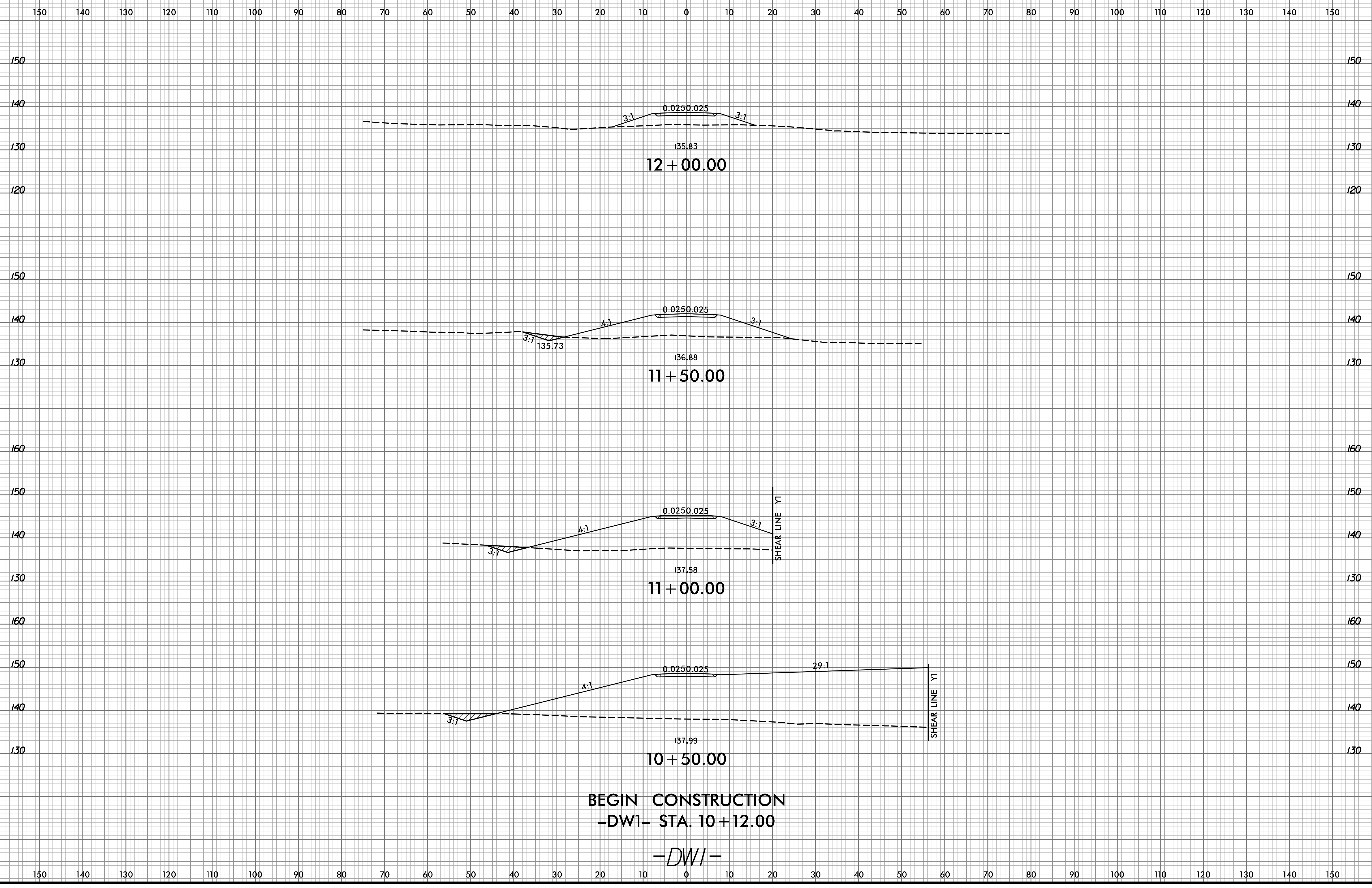

BEGIN CONSTRUCTION
 -DWI- STA. 10+12.00
 -DWI-

150 140 130 120 110 100 90 80 70 60 50 40 30 20 10 0 10 20 30 40 50 60 70 80 90 100 110 120 130 140 150

END CONSTRUCTION
-DW1- 12 + 80.00

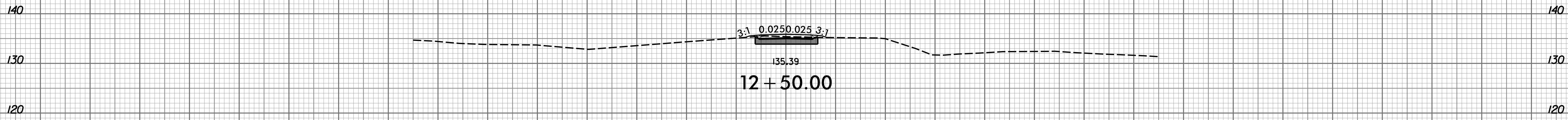

3:1 0.025 0.025 3:1

135.39

12 + 50.00

-DW1-

150 140 130 120 110 100 90 80 70 60 50 40 30 20 10 0 10 20 30 40 50 60 70 80 90 100 110 120 130 140 150

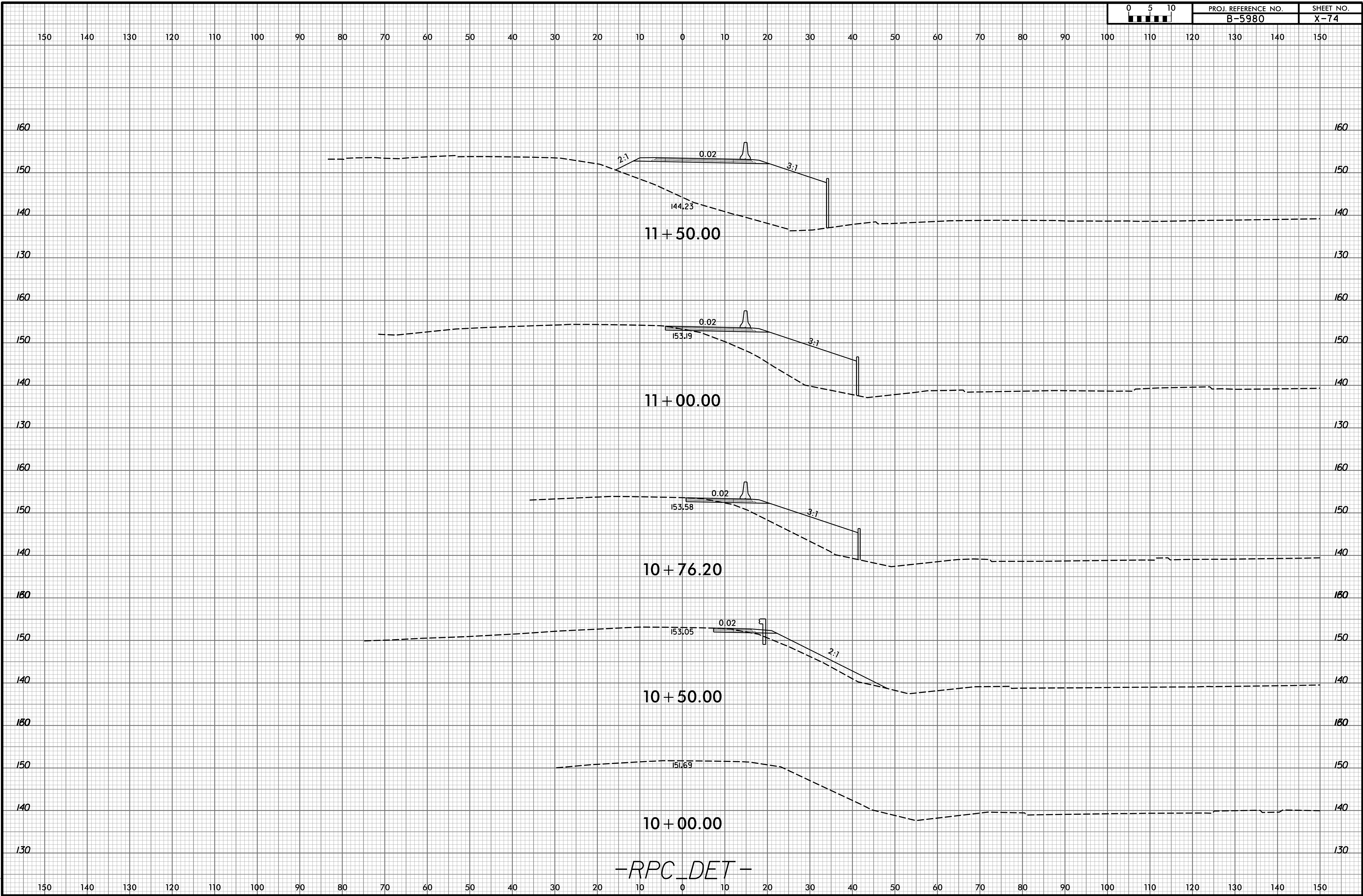

-RPC_DET-

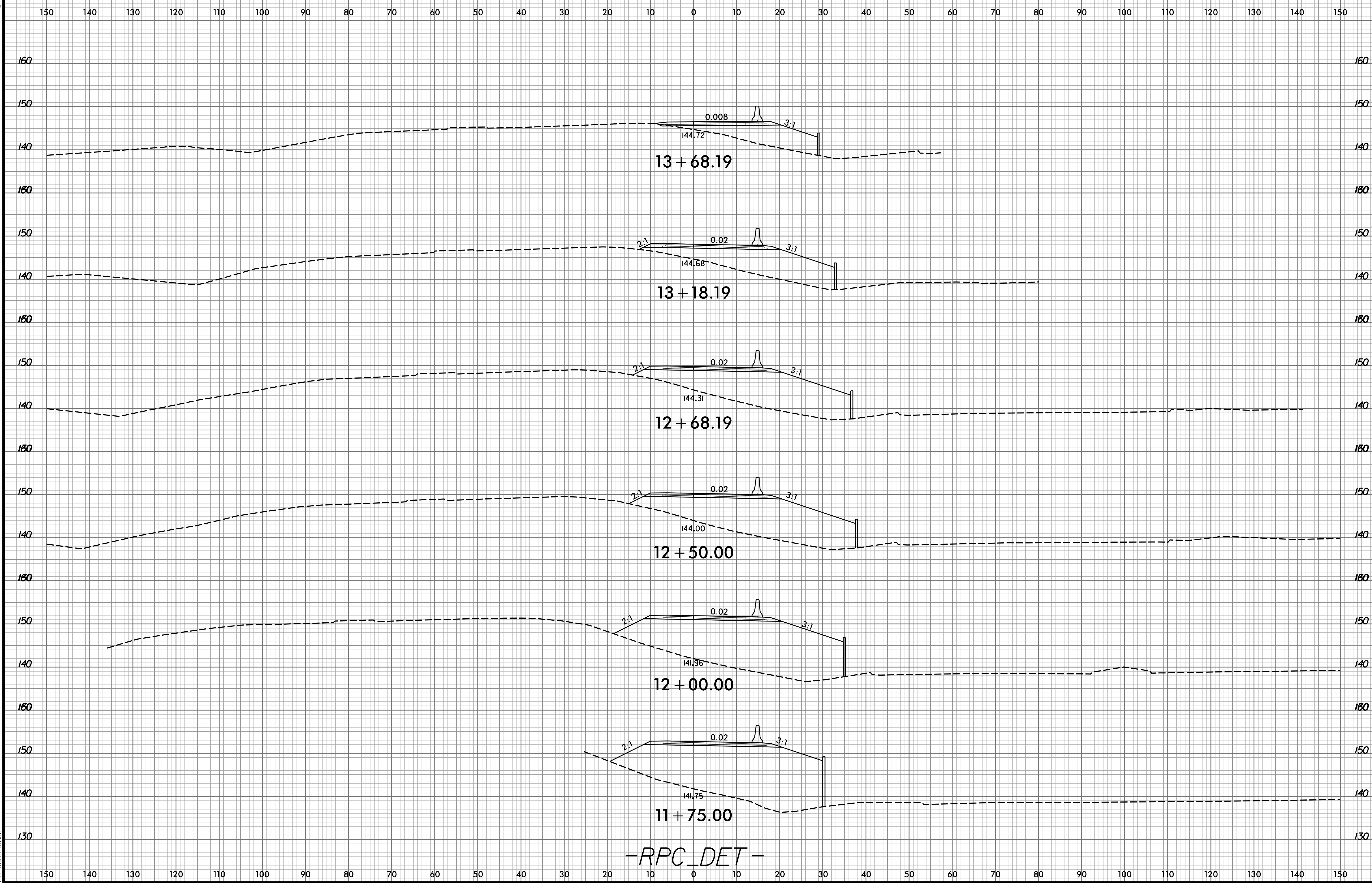

-RPC_DET-

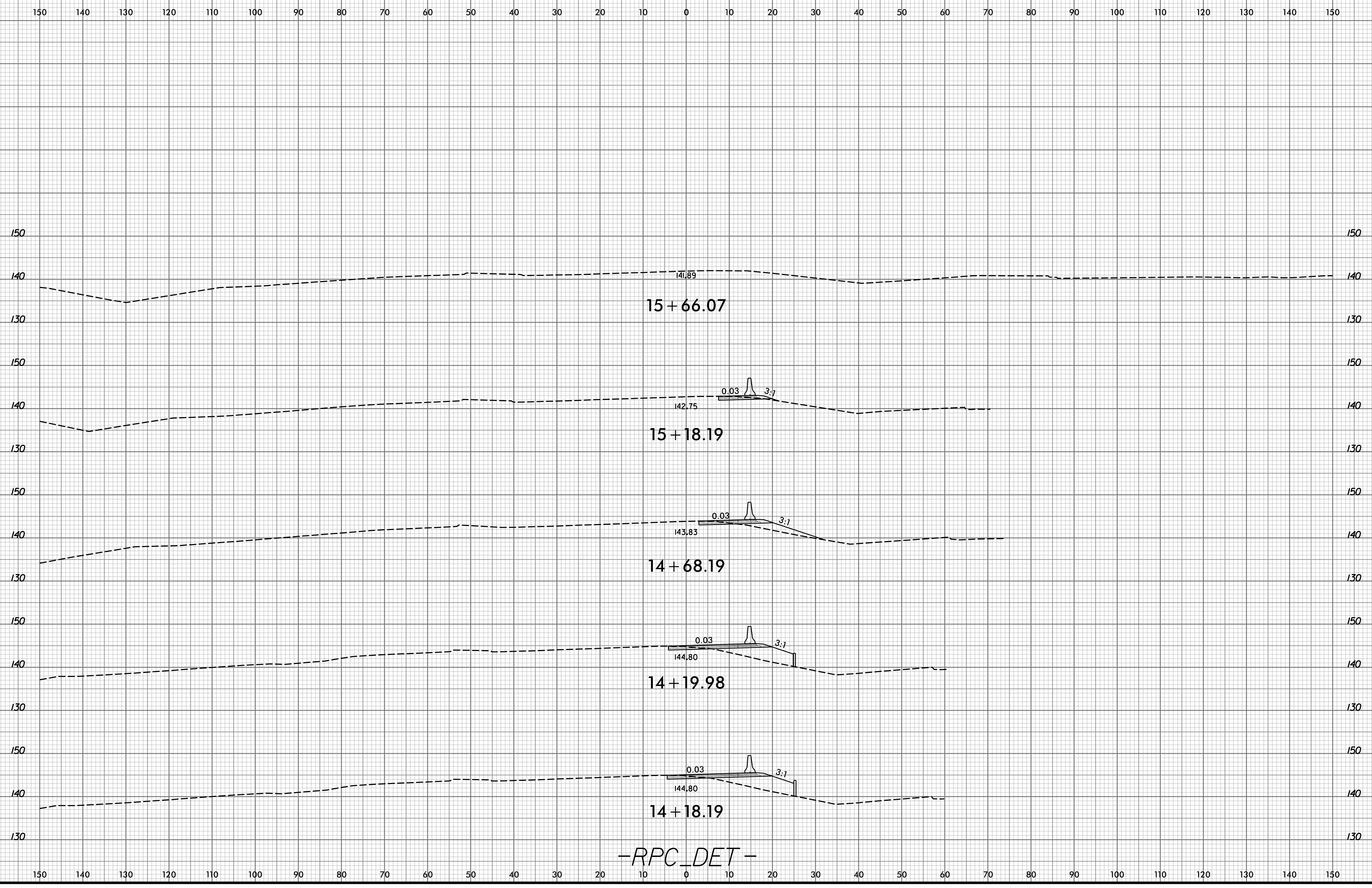

-RPC_DET-

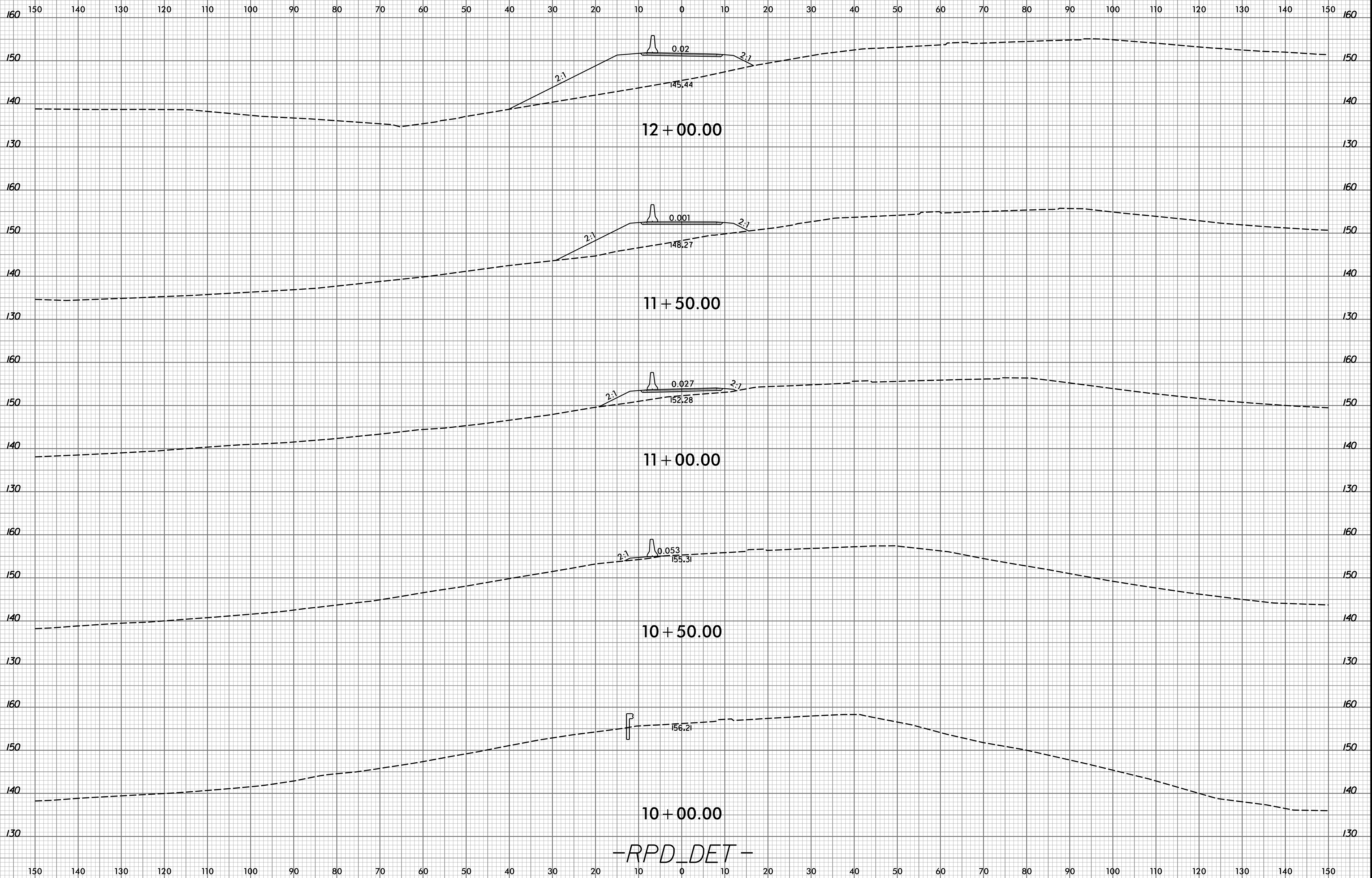

-RPD_DET-

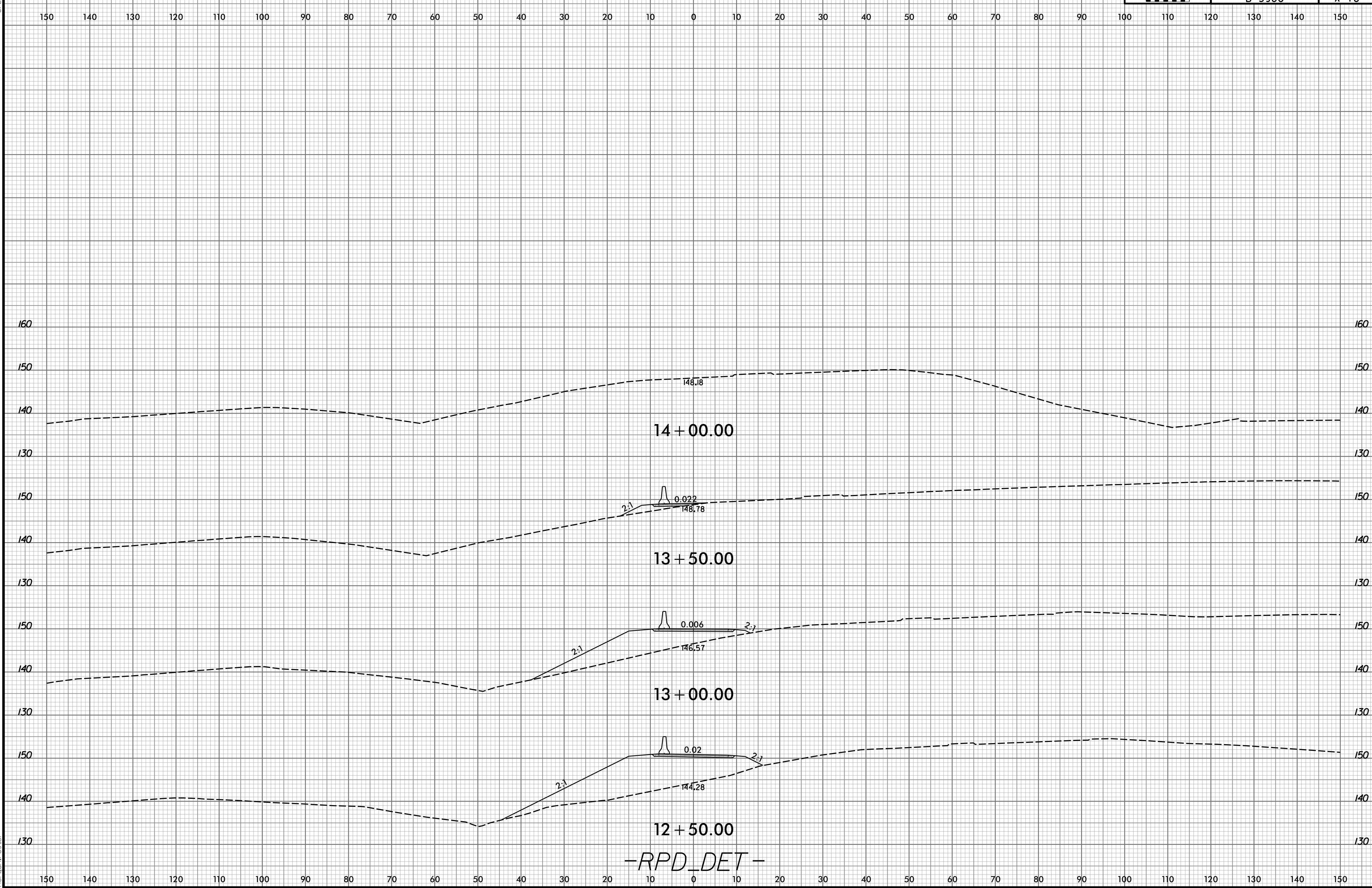

-RPD_DET-