

| | | | |
|-----------------|-----------------------------|-------------|--------------|
| STATE | STATE PROJECT REFERENCE NO. | SHEET NO. | TOTAL SHEETS |
| N.C. | R-4707 | RF-1 | |
| STATE PROJ. NO. | F.A. PROJ. NO. | DESCRIPTION | |
| | | | |

PLANTING DETAILS

SEEDLING / LINER BAREROOT PLANTING DETAIL

HEALING IN

1. Locate a healing-in site in a shady, well protected area.
2. Excavate a flat bottom trench 12 inches deep and provide drainage.

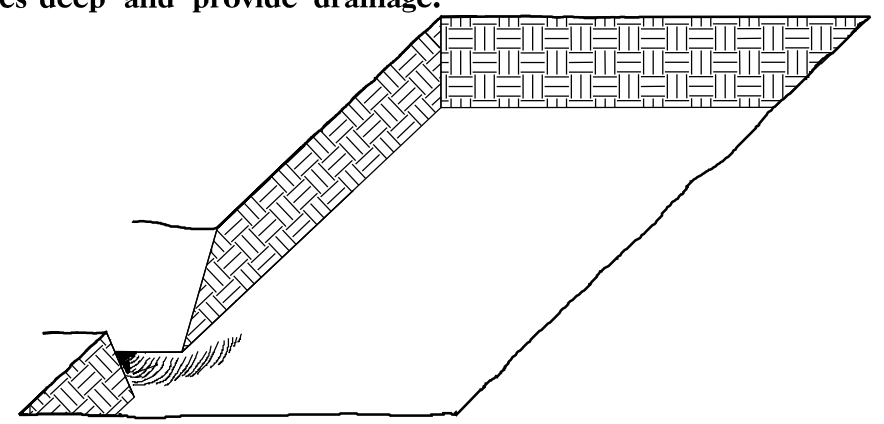

3. Backfill the trench with 2 inches well rotted sawdust. Place a 2 inch layer of well rotted sawdust at a sloping angle at one end of the trench.

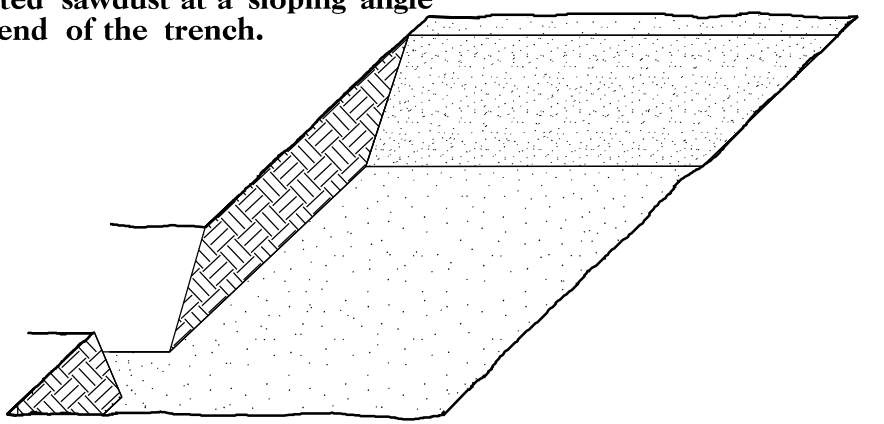

4. Place a single layer of plants against the sloping end so that the root collar is at ground level.

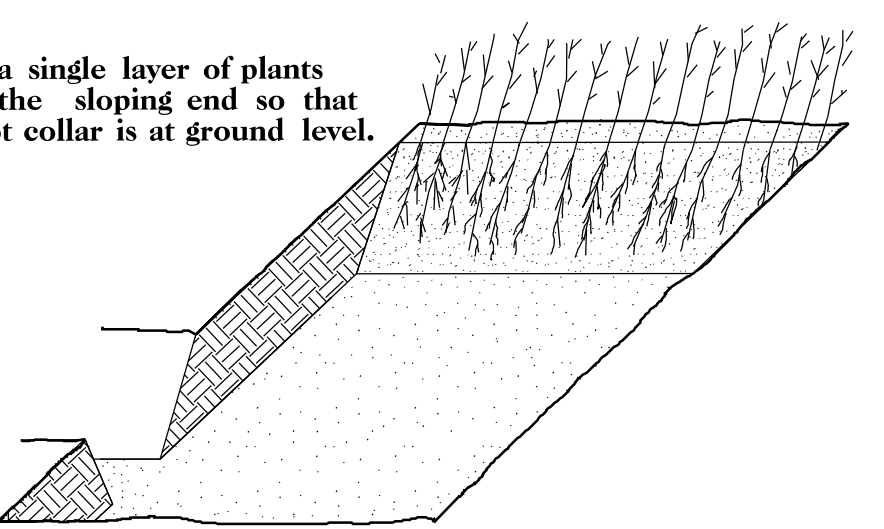

5. Place a 2 inch layer of well rotted sawdust over the roots maintaining a sloping angle.

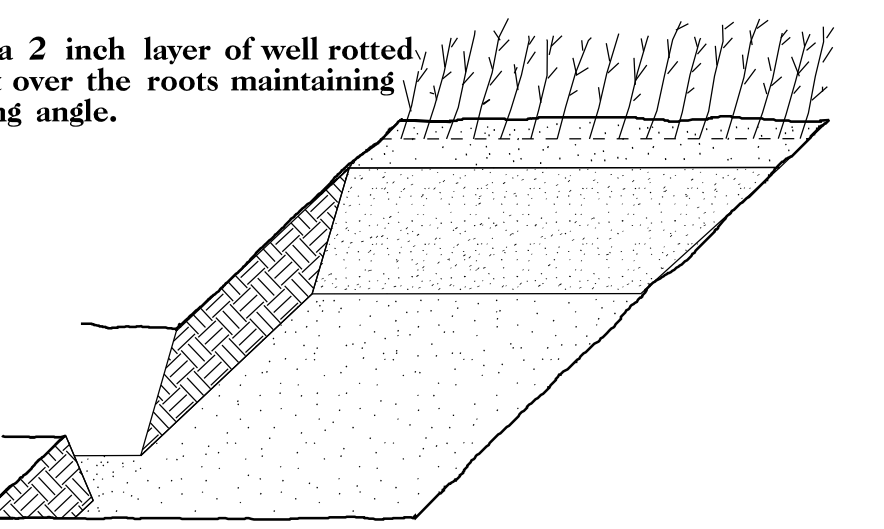

6. Repeat layers of plants and sawdust as necessary and water thoroughly.

DIBBLE PLANTING METHOD USING THE KBC PLANTING BAR

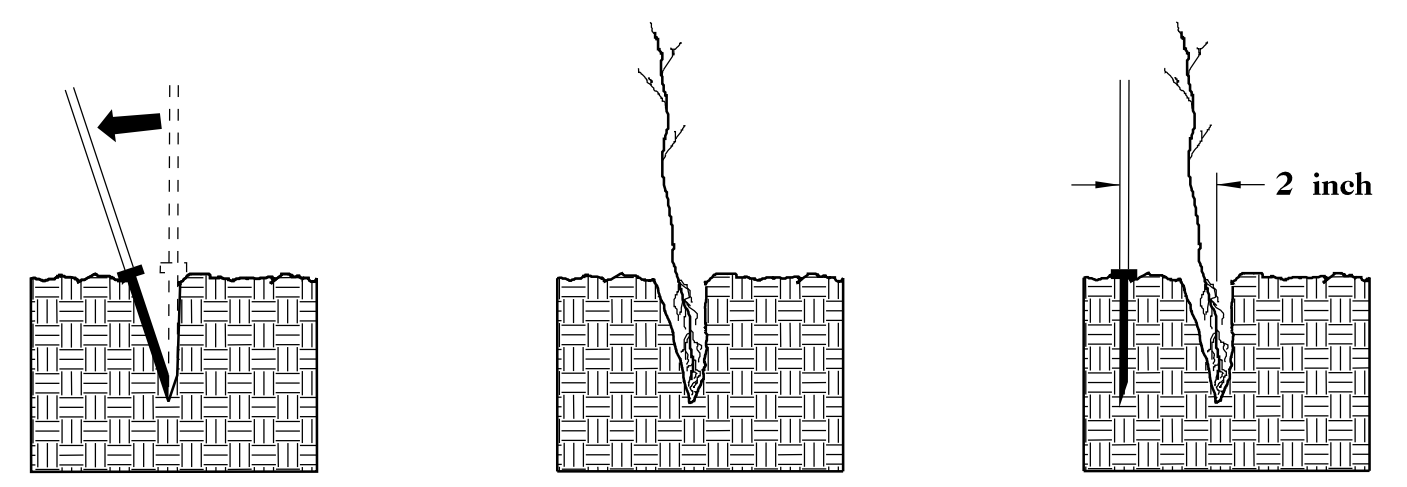

1. Insert planting bar as shown and pull handle toward planter.
2. Remove planting bar and place seedling at correct depth.
3. Insert planting bar 2 inches toward planter from seedling.

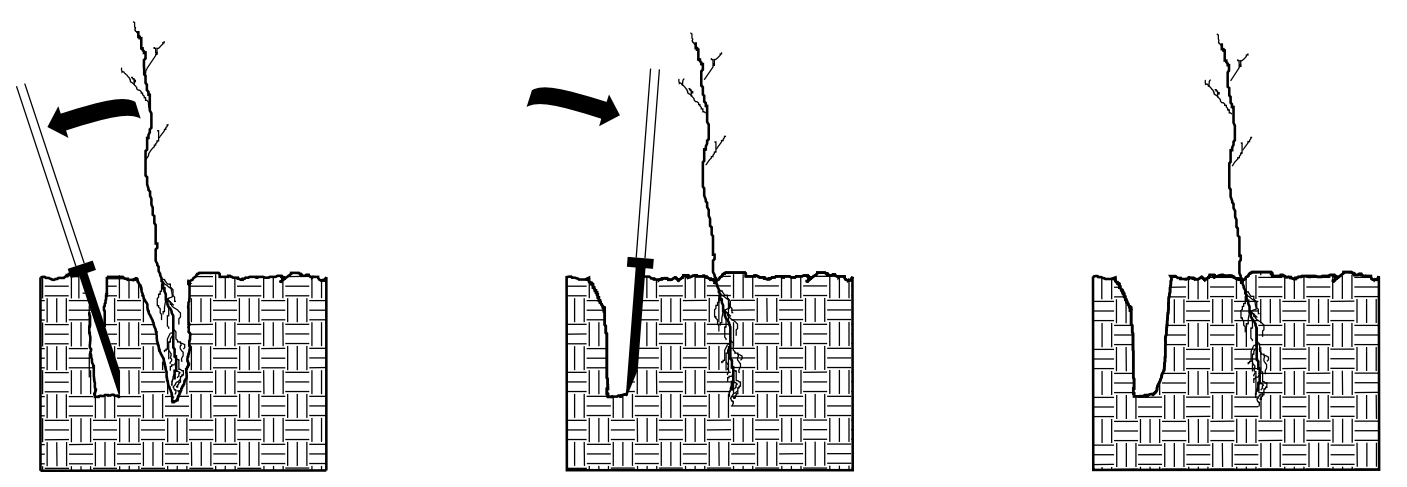

4. Pull handle of bar toward planter, firming soil at bottom.
5. Push handle forward firming soil at top.
6. Leave compaction hole open. Water thoroughly.

PLANTING NOTES:

PLANTING BAG
During planting, seedlings shall be kept in a moist canvas bag or similar container to prevent the root systems from drying.



KBC PLANTING BAR
Planting bar shall have a blade with a triangular cross section, and shall be 12 inches long, 4 inches wide and 1 inch thick at center.

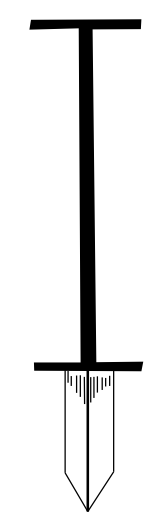

ROOT PRUNING
All seedlings shall be root pruned, if necessary, so that no roots extend more than 10 inches below the root collar.

REFORESTATION

- TREE REFORESTATION SHALL BE PLANTED 6 FT. TO 10 FT. ON CENTER, RANDOM SPACING, AVERAGING 8 FT. ON CENTER, APPROXIMATELY 680 PLANTS PER ACRE.

| REFORESTATION | | |
|--|-------------------|------------------|
| MIXTURE, TYPE, SIZE, AND FURNISH SHALL CONFORM TO THE FOLLOWING: | | |
| 25% LIRIODENDRON TULIPIFERA | TULIP POPLAR | 12 in - 18 in BR |
| 25% PLATANUS OCCIDENTALIS | AMERICAN SYCAMORE | 12 in - 18 in BR |
| 25% NYSSA SYLVATICA | BLACK GUM | 12 in - 18 in BR |
| 25% BETULA NIGRA | RIVER BIRCH | 12 in - 18 in BR |

REFORESTATION DETAIL SHEET

N.C.D.O.T. - ROADSIDE ENVIRONMENTAL UNIT

PLANTING DETAILS

LIVE STAKES PLANTING DETAIL

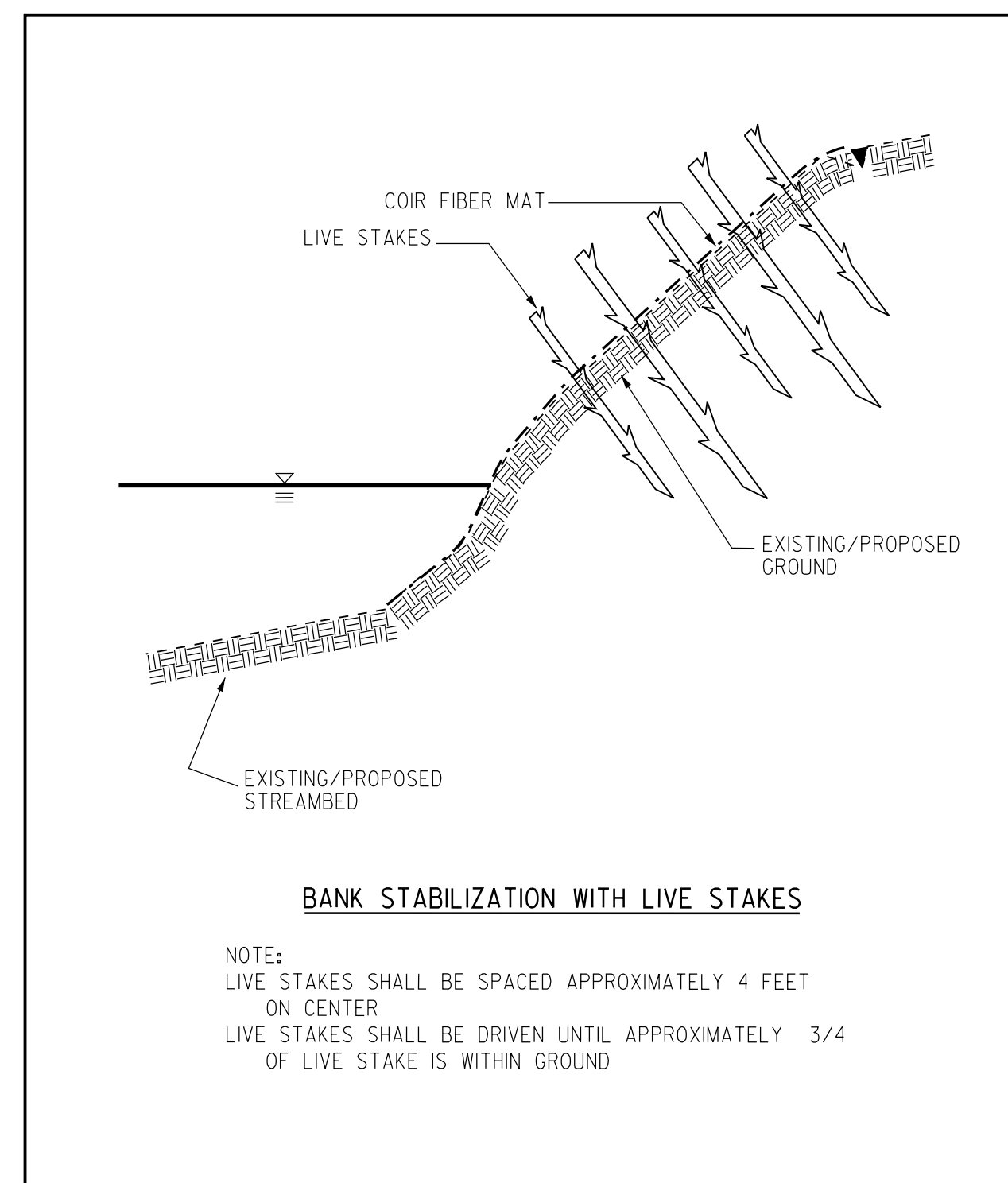
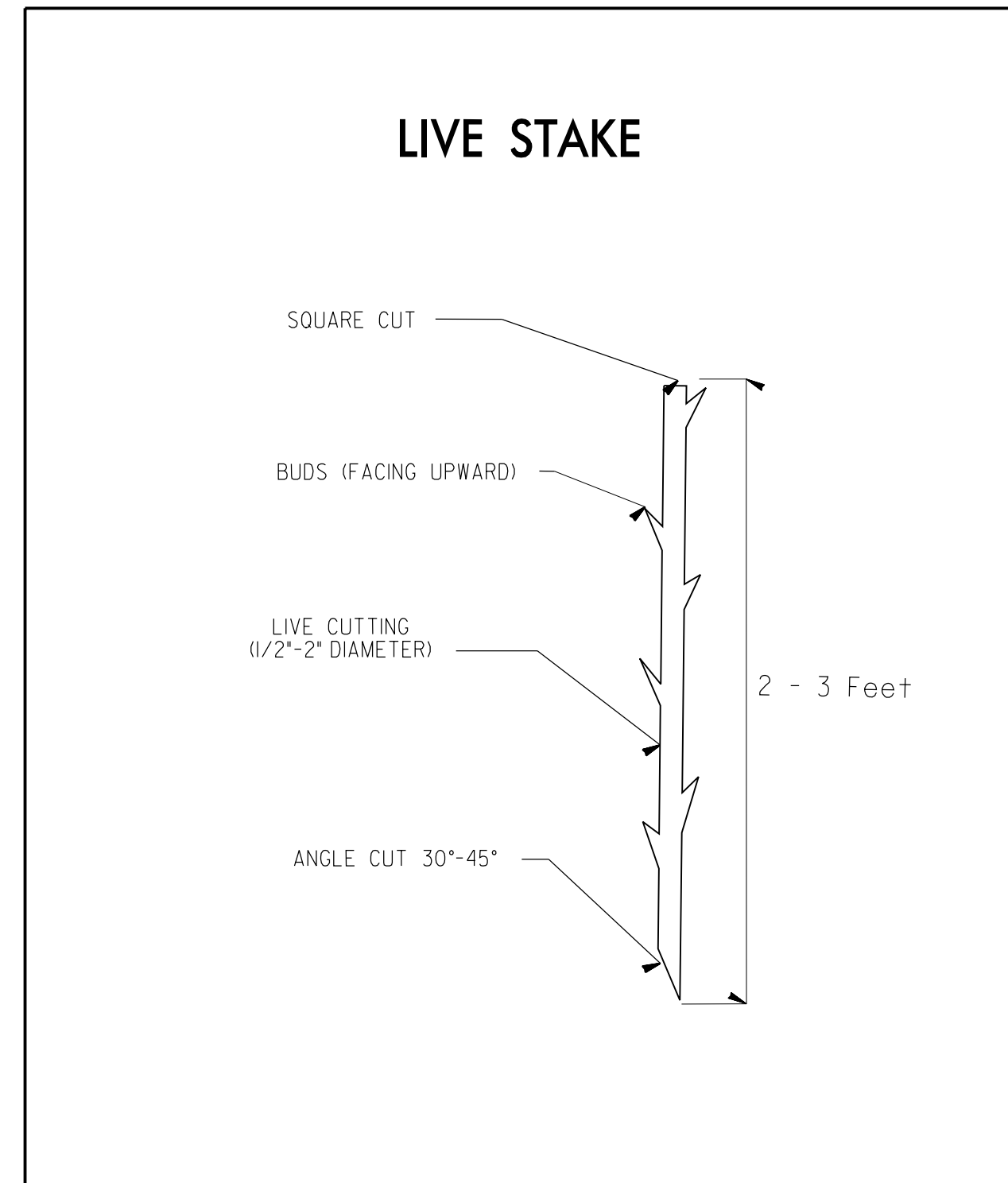

BAREROOT PLANTING DETAIL DIBBLE PLANTING METHOD USING THE KBC PLANTING BAR

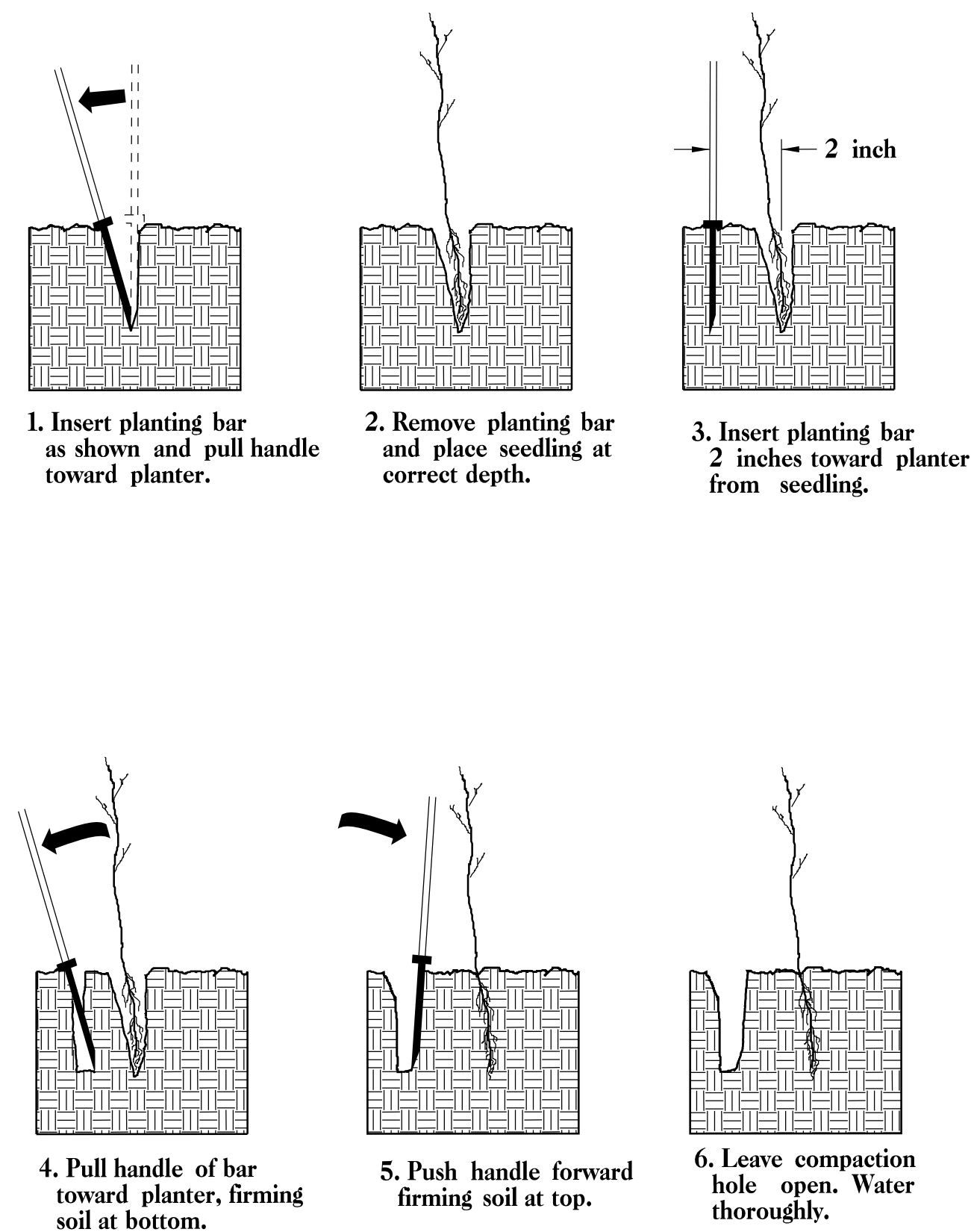

PLANTING NOTES:

PLANTING BAG
During planting, seedlings shall be kept in a moist canvas bag or similar container to prevent the root systems from drying.



KBC PLANTING BAR
Planting bar shall have a blade with a triangular cross section, and shall be 12 inches long, 4 inches wide and 1 inch thick at center.

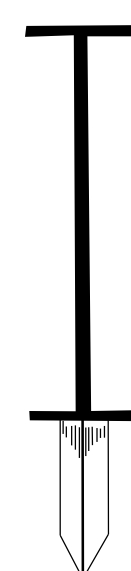

ROOT PRUNING
All seedlings shall be root pruned, if necessary, so that no roots extend more than 10 inches below the root collar.

- TYPE 1 STREAMBANK REFORESTATION SHALL BE PLANTED 3 FT. TO 5 FT. ON CENTER, RANDOM SPACING, AVERAGING 4 FT. ON CENTER, APPROXIMATELY 2724 PLANTS PER ACRE.
- TYPE 2 STREAMBANK REFORESTATION SHALL BE PLANTED 6 FT. TO 10 FT. ON CENTER, RANDOM SPACING, AVERAGING 8 FT. ON CENTER, APPROXIMATELY 680 PLANTS PER ACRE.
- NOTE: TYPE 1 AND TYPE 2 STREAMBANK REFORESTATION SHALL BE PAID FOR AS "STREAMBANK REFORESTATION"

STREAMBANK REFORESTATION TYPICAL

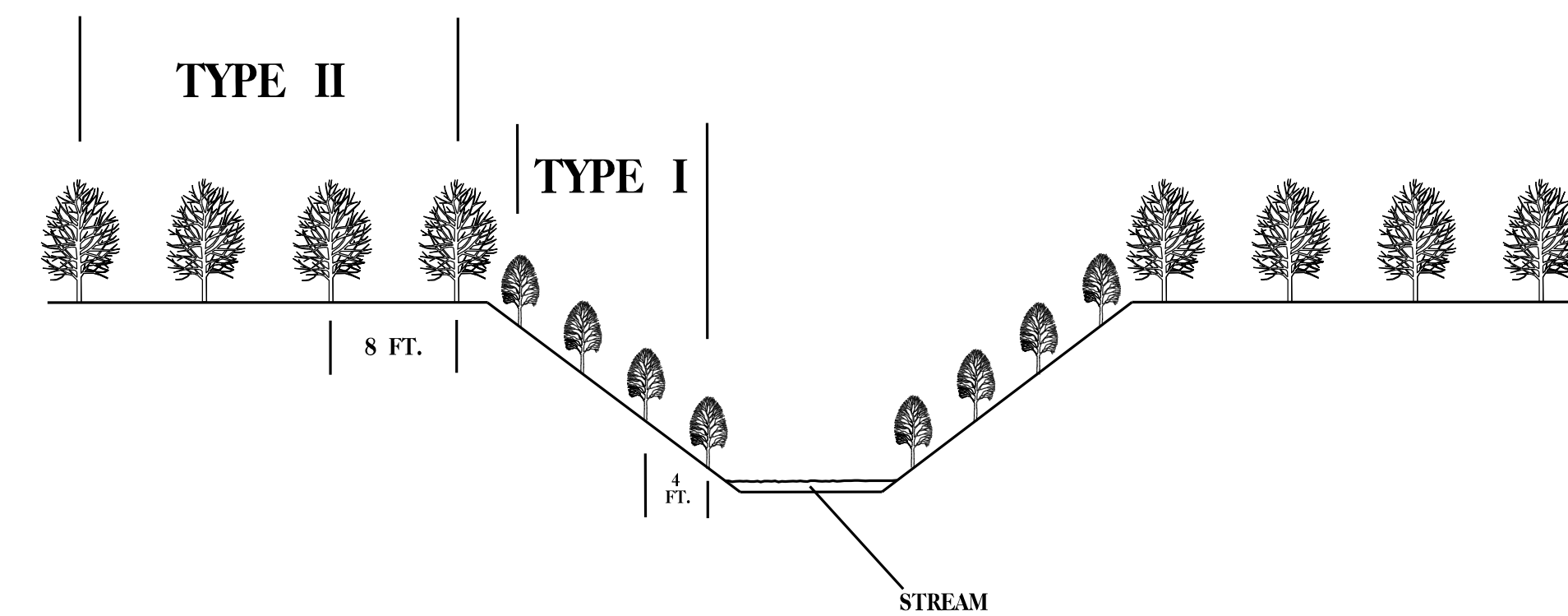

STREAMBANK REFORESTATION

MIXTURE, TYPE, SIZE, AND FURNISH SHALL CONFORM TO THE FOLLOWING:

TYPE 1

| | | |
|-------------------|---------------|-------------------------|
| 50% SALIX NIGRA | BLACK WILLOW | 2 ft - 3 ft LIVE STAKES |
| 50% CORNUS AMOMUM | SILKY DOGWOOD | 2 ft - 3 ft LIVE STAKES |

TYPE 2

| | | |
|-----------------------------|--------------|------------------|
| 25% LIRIODENDRON TULIPIFERA | TULIP POPLAR | 12 in - 18 in BR |
| 25% PLATANUS OCCIDENTALIS | SYCAMORE | 12 in - 18 in BR |
| 25% NYSSA SYLVATICA | BLACK GUM | 12 in - 18 in BR |
| 25% BETULA NIGRA | RIVER BIRCH | 12 in - 18 in BR |

- SEE PLAN SHEETS FOR AREAS TO BE PLANTED

STREAMBANK REFORESTATION

DETAIL SHEET 1 OF 2

| | |
|--|--------------------------|
| PROJECT REFERENCE NO. <i>R-4707</i> | SHEET NO. <i>RF-3</i> |
| RW SHEET NO. | |
| ROADWAY DESIGN ENGINEER | HYDRAULICS ENGINEER |

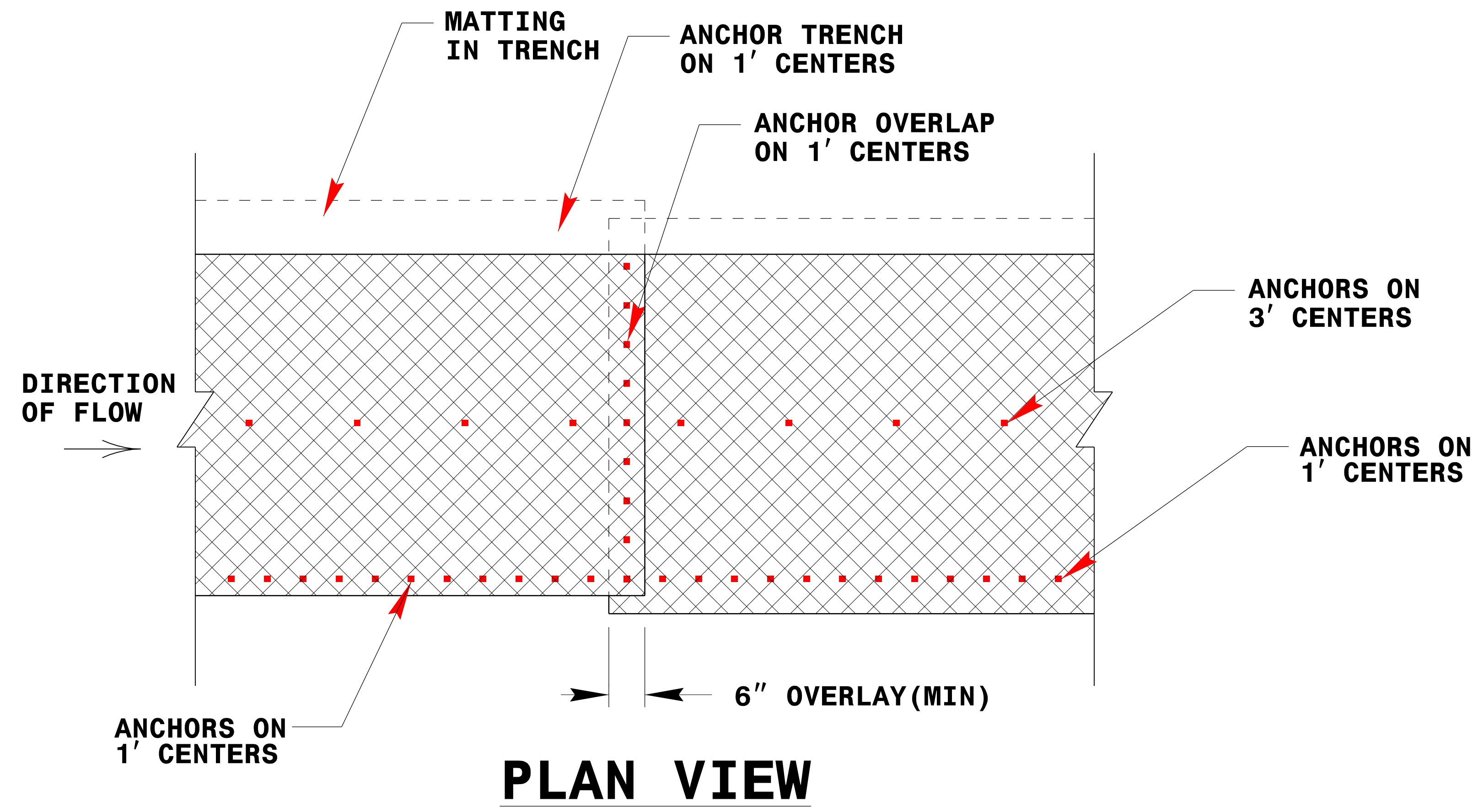

PLAN VIEW

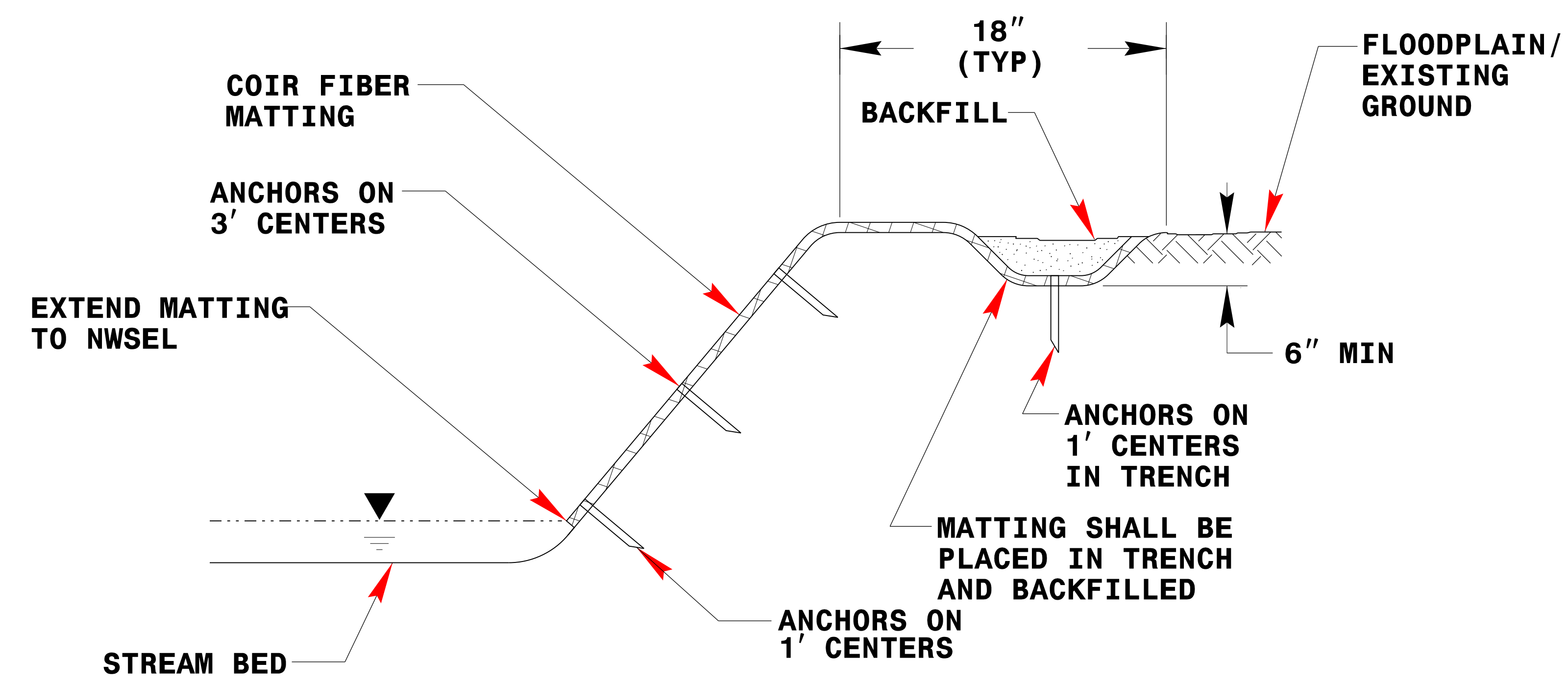

TYPICAL CROSS SECTION

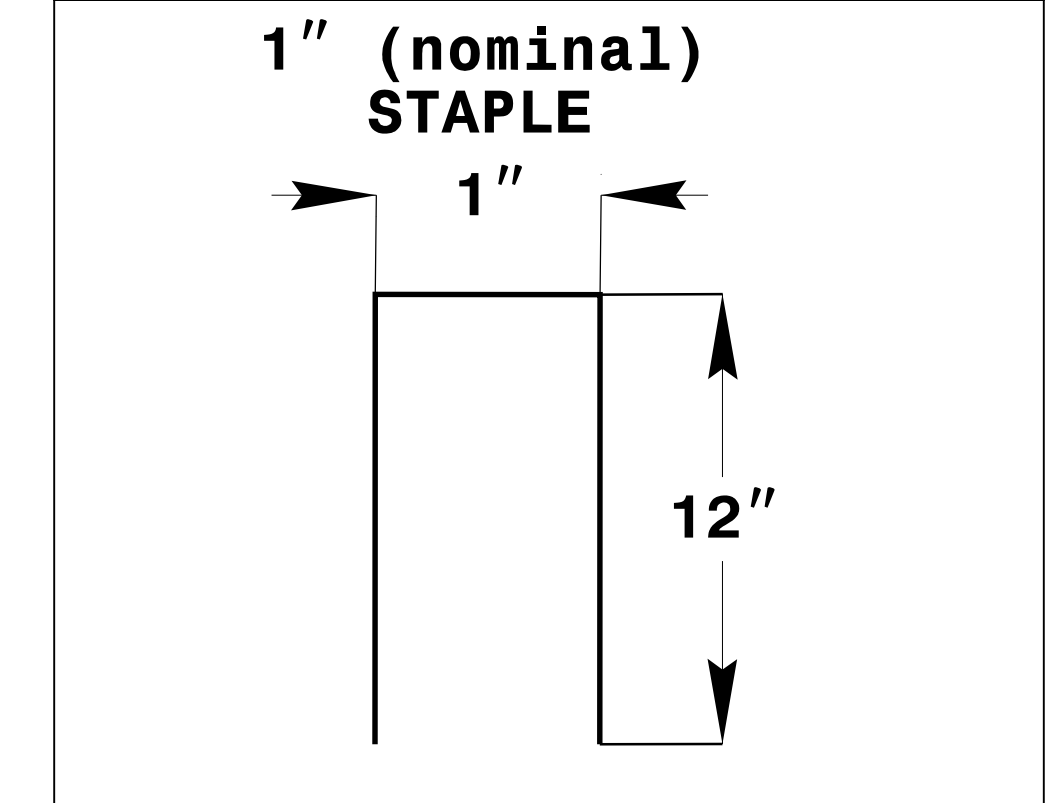
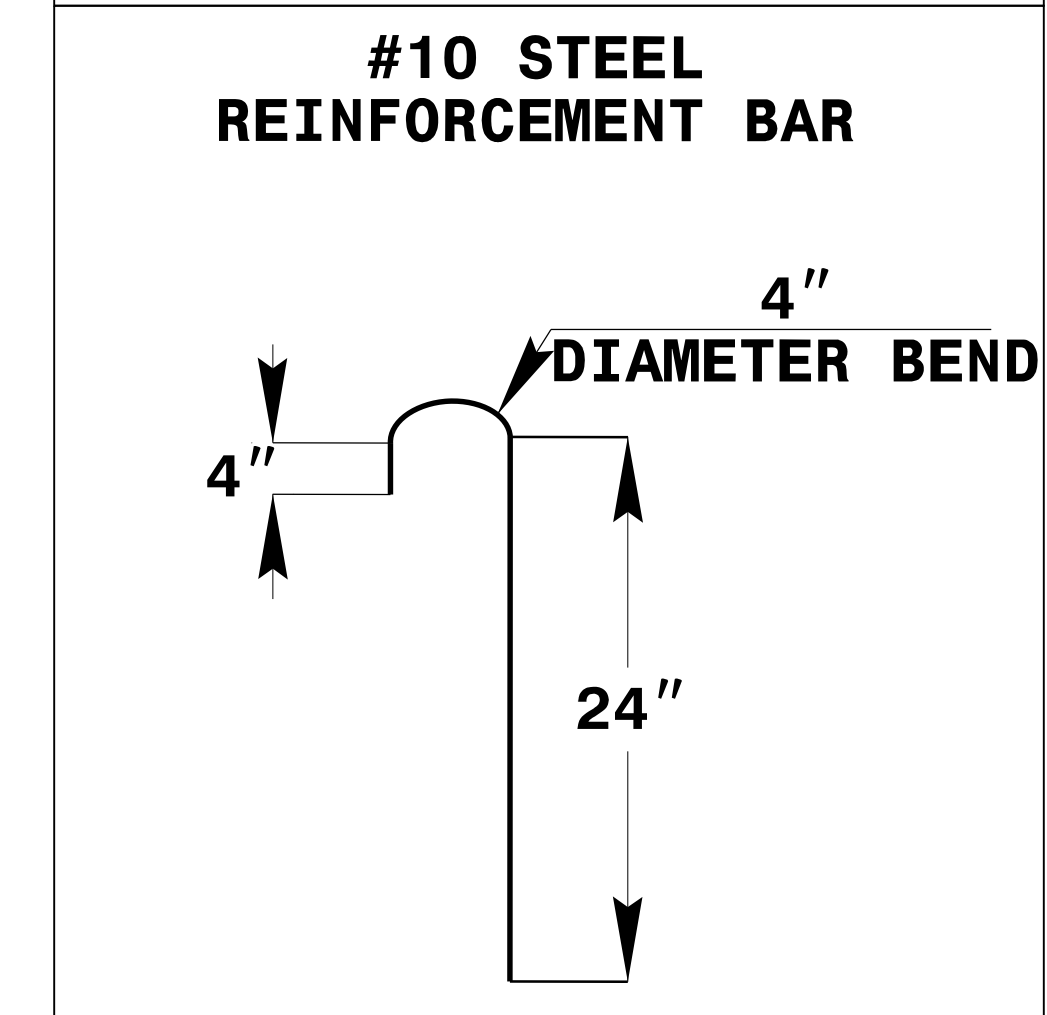
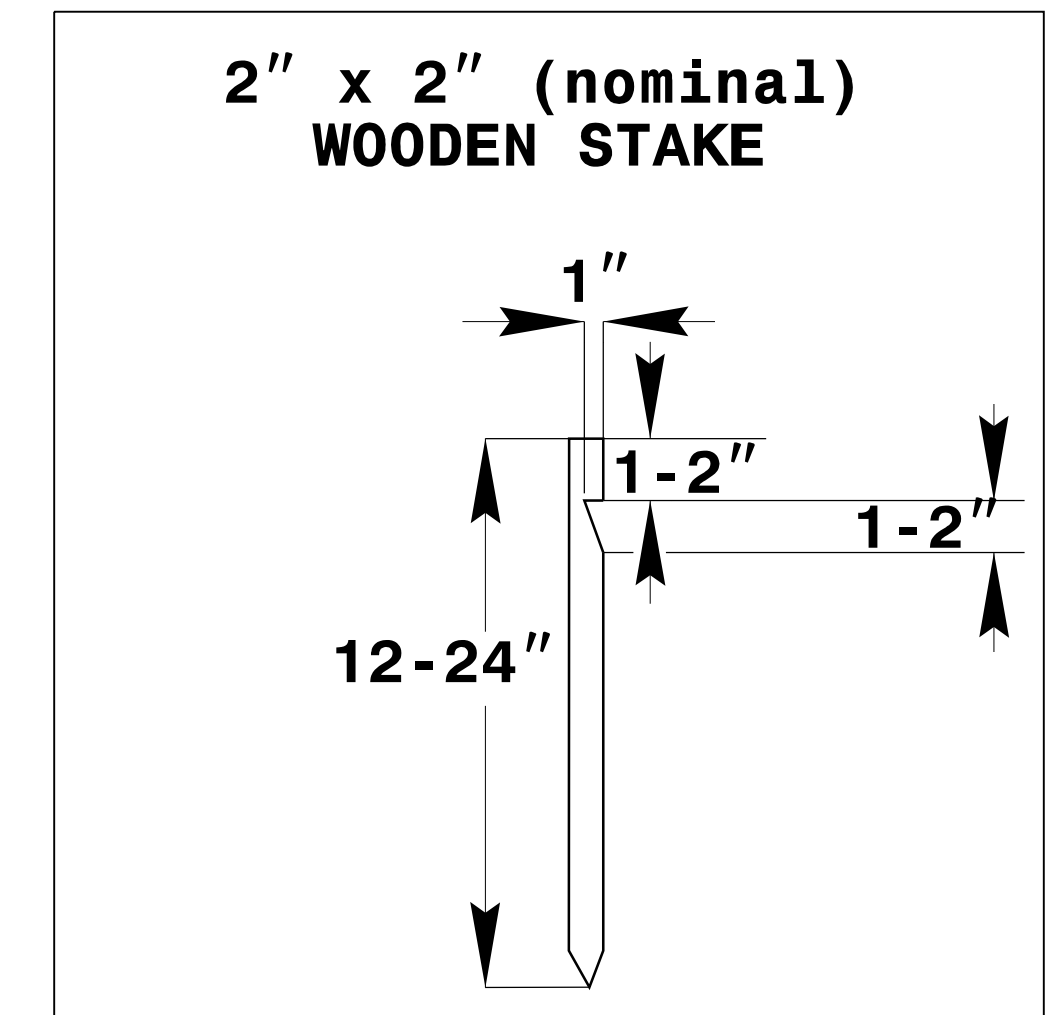

ANCHOR OPTIONS

COIR FIBER MATTING DETAIL

NOT TO SCALE