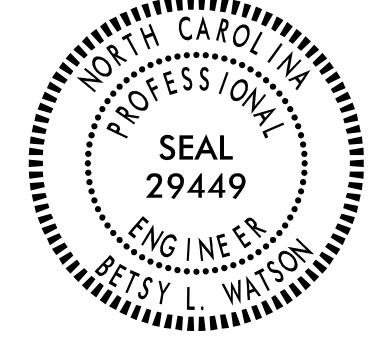

**STATE OF NORTH CAROLINA
DEPARTMENT OF TRANSPORTATION**

**SIGNING PLAN
JOHNSTON COUNTY**

LOCATION: US 70 FROM EAST OF US 70 BUSINESS TO WEST OF NEUSE RIVER.

TIP NO. W-5600	SHEET NO. SIGN-1
APPROVED: <u>Betsy L. Watson</u> DATE: <u>5/28/2020</u>	
SEAL 	
DOCUMENT NOT CONSIDERED FINAL UNLESS ALL SIGNATURES COMPLETED	

T.I.P.: W-5600

SUMMARY OF QUANTITIES

ITEM NO.	ITEM DESCRIPTION		QUANTITY	UNIT
DESC. NO.	SECT. NO.			
4048000000	902	REINFORCED CONCRETE SIGN FOUNDATION.....	14	C.Y.
4054000000	902	PLAIN CONCRETE SIGN FOUNDATION.....	1	C.Y.
4057000000	SP	OVERHEAD FOOTING.....	28	C.Y.
4060000000	903	SUPPORTS, BREAKAWAY STEEL BEAM.....	12684	LB
4066000000	903	SUPPORTS, SIMPLE STEEL BEAM.....	2681	LB
4072000000	903	SUPPORTS, 3 LB STEEL U-CHANNEL.....	4172	L.F.
4082100000	SP	SUPPORTS, OVERHEAD SIGN STRUCTURE @ -L- Sta. 233+00.....	1	LS
4096000000	904	SIGN ERECTION, TYPE D.....	14	EA.
4102000000	904	SIGN ERECTION, TYPE E.....	174	EA.
4108000000	904	SIGN ERECTION, TYPE F.....	28	EA.
4109000000	904	SIGN ERECTION, TYPE A (OVERHEAD).....	2	EA.
4109000000	904	SIGN ERECTION, TYPE B (OVERHEAD).....	2	EA.
4110000000	904	SIGN ERECTION, TYPE A (GROUND MOUNTED).....	18	EA.
4110000000	904	SIGN ERECTION, TYPE B (GROUND MOUNTED).....	12	EA.
4114000000	904	SIGN ERECTION, MILEMARKERS.....	20	EA.
4116100000	904	SIGN ERECTION, RELOCATE SIGN TYPE D.....	7	EA.
4152000000	907	DISPOSAL OF SIGN SYSTEM, STEEL BEAM.....	10	EA.
4155000000	907	DISPOSAL OF SIGN SYSTEM, U-CHANNEL.....	179	EA.
4158000000	907	DISPOSAL OF SIGN SYSTEM, WOOD.....	4	EA.
4192000000	907	DISPOSAL OF SUPPORT, U-CHANNEL.....	7	EA.
4238500000	907	DISPOSAL OF SIGN, MILEMARKERS.....	2	EA.

GENERAL NOTES

- . SIGNS FURNISHED BY STATE
- . CONFIRM IN WRITING AT LEAST 4 MONTHS IN ADVANCE, THE ACTUAL DATE THE DEPARTMENT FURNISHED SIGNS WILL BE REQUIRED.
- . ALL TYPE 'D' SIGNS SHALL BE MOUNTED ON TWO U-CHANNEL POSTS UNLESS OTHERWISE INDICATED ON THE PLANS.
- . IF REMOVAL OR RELOCATION OF SIGNS ON PRIVATE STREET (NON-STATE MAINTAINED) IS REQUIRED DUE TO CONSTRUCTION, THE CONTRACTOR SHALL INFORM THE ENGINEER. THE WORK WILL BE COMPLETED BY OTHERS.
- . WHEN NOT STATIONED OR DIMENSIONED ON PLANS, ALL 'E' AND 'F' SIGNS SHALL BE FIELD LOCATED BY THE ENGINEER
- . ALL EXISTING SIGNS ON "U" CHANNEL POST WITHIN THE PROJECT LIMITS SHALL BE REMOVED AND DISPOSED OF UNLESS OTHERWISE NOTED ON PLANS.
- . WHEN EXISTING SIGNS ARE REMOVED AND INSTALLED ON NEW SUPPORTS, THE RE-ERECTION SHALL IMMEDIATELY FOLLOW THE REMOVAL.
- . THE BACKGROUND FOR TYPE E & F SIGNS SHALL BE TYPE C REFLECTIVE SHEETING.
- . SEE ROADWAY PLANS FOR GUARD/GUIDE RAIL DETAILS.

ROADWAY STANDARD DRAWING

THE FOLLOWING ROADWAY STANDARDS AS APPEAR IN "ROADWAY STANDARD DRAWINGS" - N.C. DEPARTMENT OF TRANSPORTATION - RALEIGH, N.C., DATED JANUARY 2018 ARE APPLICABLE TO THIS PROJECT AND BY REFERENCE HEREBY ARE CONSIDERED A PART OF THESE PLANS:

STD. NO.	TITLE
901.10	TYPE 'A' SIGNS
901.20	TYPE 'B' SIGNS
901.50	ARROWS AND SHIELDS
901.70	SIGN STRINGERS AND SUPPORT SPACING
901.80	SIGN MOUNTING DETAILS - FOR TYPE A AND TYPE B SIGNS
903.10	GROUND MOUNTED SIGN SUPPORTS
904.10	ORIENTATION OF GROUND MOUNTED SIGNS
904.20	SECONDARY SIGN MOUNTING
904.40	MILEPOST AND PLACEMENT
904.50	MOUNTING OF TYPE 'D', 'E' AND 'F' SIGNS ON 'U' CHANNEL POSTS
910.50	SIGNING FOR SPEED REDUCTION ZONE
1264.01	OBJECT MARKERS (TYPES)
1264.02	OBJECT MARKERS (INSTALLATION)

INDEX

SHEET NO.	DESCRIPTION
SIGN-1	TITLE SHEET
SIGN-2	GROUND MOUNTED SIGN SUPPORTS
SIGN-3	STRUCTURE LINE DRAWING
SIGN-4-4K	SIGN DESIGNS, E & F SIGNS, & MILEMARKER SHEETS
SIGN-5-34	SIGNING PLAN SHEETS

CONTRACT:

PLAN PREPARED FOR THE N.C.D.O.T. SIGNING AND DELINEATION UNIT

Ayman I. Alqudwah, P.E. Signing & Delineation Regional Engineer
Eric Ward Signing & Delineation Design Engineer

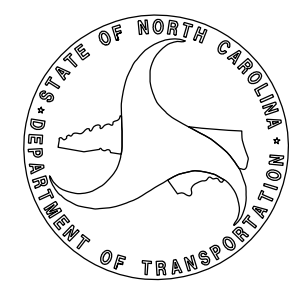



Stantec Consulting Services Inc.
801 Jones Franklin Road
Suite 300
Raleigh, NC 27606
Tel. (919) 851-6866
Fax. (919) 851-7024
www.stantec.com
License No. F-0672

PLAN PREPARED BY: Stantec Consulting Services, Inc.

Betsy L. Watson, PE Senior Principal
James Hambright Senior Transportation Technician



TIP NO. W-5600	SHEET NO. SIGN-3
APPROVED: <i>Betsy L. Watson</i> <small>35E67B84F8743F...</small>	
DATE: 5/20/2019	
	
DOCUMENT NOT CONSIDERED FINAL UNLESS ALL SIGNATURES COMPLETED	
	

Overhead Sign Structure "A" @ -L- Sta. 233 + 00

US 70 Bypass (Wesbound Lanes)
Right Support at 66.00' LT

(Crossection @ -L- STA. 233 + 00)

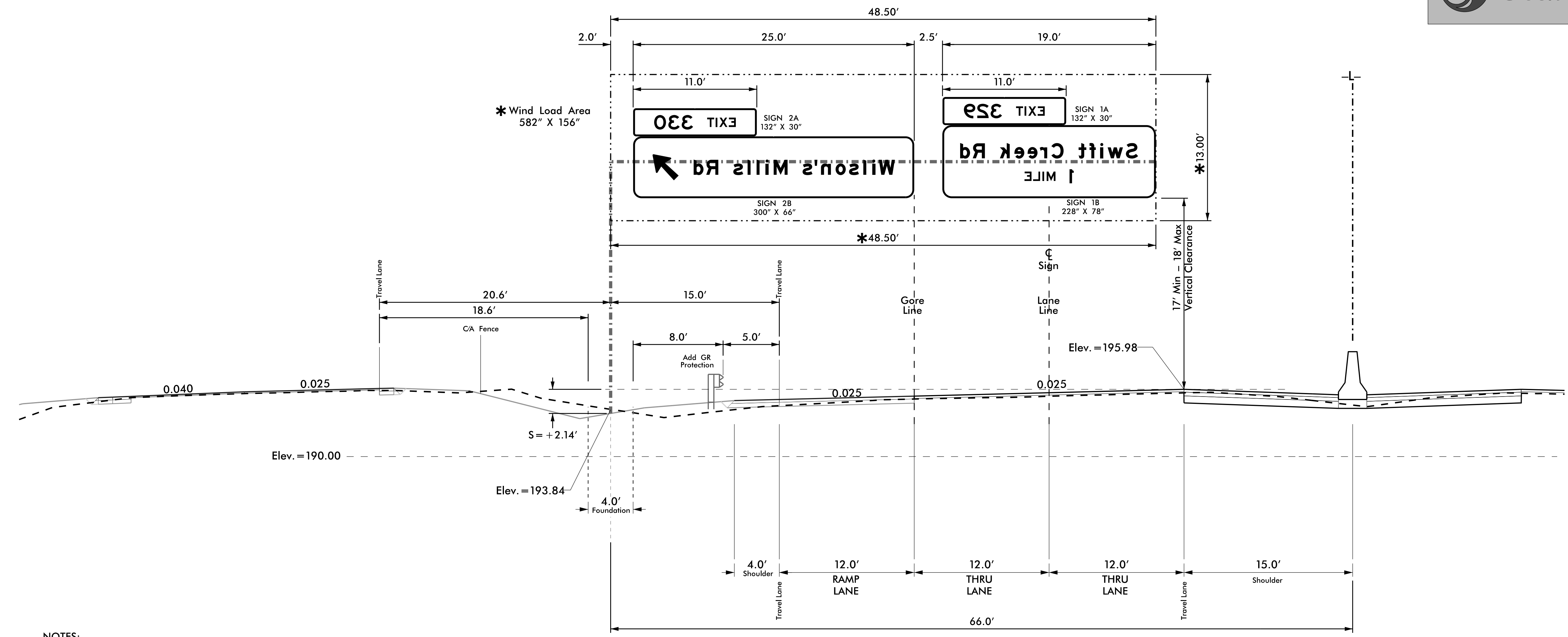

NOTES:

1. IF THE CONTRACTOR BIDS ALUMINUM SIGN STRUCTURE, EACH SHALL BE PROVIDED WITH AN APPROVED HIGHWAY TRUSS DAMPER DEVICE IN ACCORDANCE WITH AASHTO SPECIFICATIONS.
2. MOUNT SIGNS VERTICALLY CENTERED ON HORIZONTAL MEMBER OF STRUCTURE.
3. FIELD VERIFICATION SHALL BE REQUIRED FOR ALL FOOTING ELEVATIONS, PER THE LATEST NCDOT STANDARD SPECIFICATIONS FOR ROADS AND STRUCTURES. PROVIDE FIELD VERIFICATION TO THE SIGNING SECTION.
4. THE TOP OF THE FOOTING SHALL EXTEND AT LEAST 4 INCHES AND NOT MORE THAN 24 INCHES ABOVE THE HIGHEST POINT OF THE GROUND SURFACE AT THE FOOTING.
5. SIGN HANGERS AND ATTACHMENT HARDWARE SHALL BE PROVIDED AND INSTALLED ON THE ASSEMBLY TO ACCOMMODATE ALL SIGNS SHOWN IN THIS PLAN SHEET.
6. DESIGN AND CONSTRUCTION REQUIREMENTS FOR SIGN STRUCTURES SHALL ACCOMMODATE WIND VELOCITY OF 100 M.P.H.

* THESE DIMENSIONS SHALL BE USED FOR WIND LOAD AND DEAD LOAD COMPUTATIONS IN DESIGN OF STRUCTURE AND FOOTINGS. DESIGN AND CONSTRUCTION REQUIREMENTS FOR SIGN STRUCTURES SHALL ACCOMMODATE WIND VELOCITY OF 100 MPH.

STRUCTURE LINE DRAWING
OVERHEAD SIGN STRUCTURE "A"

\$\$\$SYTIME\$\$\$\$
 \$\$\$DGN\$\$\$\$
 \$\$\$USERNAME\$\$\$\$

APPROVED: *Betsy L. Watson*
35E67B834F87A3F...
 DATE: 5/20/2019

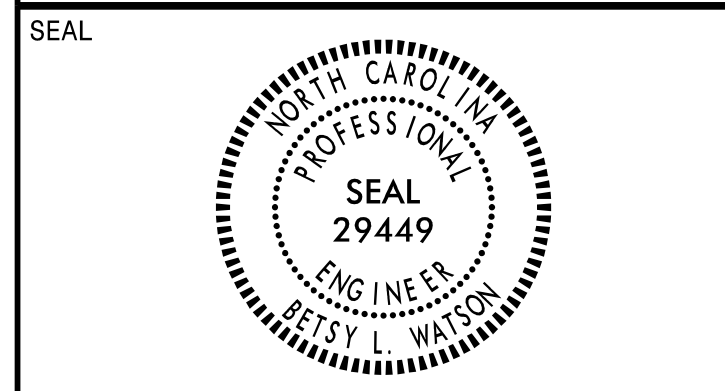

DOCUMENT NOT CONSIDERED FINAL
 UNLESS ALL SIGNATURES COMPLETED



SIGN NUMBER: 1A
 TYPE: B (OVHD)
 QUANTITY: 1
 SIGN WIDTH: 11'-0"
 HEIGHT: 2'-6"
 TOTAL AREA: 27.5 Sq.Ft.
 BORDER TYPE: FLUSH
 RECESS: 0"
 WIDTH: 2"
 RADII: 3"
 No. Z BARS: 2
 LENGTH: 124.0

BACKG COLOR: Green
 COPY COLOR: White
 SYMBOL X Y WID HT
 MAT'L: 0.125" (3.2 mm) ALUMINUM

PROJECT ID: W-5600
 DESIGN BY: James Hambricht
 LOCATION: Above Sign #18
 CHECKED BY: Name
 DIVISION: 4
 DATE: Nov 01, 2018

Spacing Factor is 1 unless specified otherwise

NOTES:
 1. Legend and border shall be direct applied, Grade "A" sheeting (except those that are colored black).
 2. Background shall be Grade "C" reflective sheeting.

LETTER POSITIONS

Letter spacings are to start of next letter

Series/Size	Text Length
E 2000	86.3
E	22.9
X	8.9
I	10.7
T	3.5
3	7.5
2	15
9	14.3
	14.3
	12.2
	22.9

FILENAME: Sign Designs - Fwy Intermediate - Revised
 NORTH CAROLINA D.O.T. SIGN DETAIL

SIGN NUMBER: 1B
 TYPE: A (OVHD)
 QUANTITY: 1
 SIGN WIDTH: 19'-0"
 HEIGHT: 6'-6"
 TOTAL AREA: 123.5 Sq.Ft.
 BORDER TYPE: FLUSH
 RECESS: 0"
 WIDTH: 2"
 RADII: 9"
 No. Z BARS: 2
 LENGTH: 220.0

BACKG COLOR: Green
 COPY COLOR: White
 SYMBOL X Y WID HT
 MAT'L: 0.125" (3.2 mm) ALUMINUM

PROJECT ID: W-5600
 DESIGN BY: James Hambricht
 LOCATION: Overhead Sign Structure "A" @ -L- Sta. 233+00 (LT)
 CHECKED BY: Name
 DIVISION: 4
 DATE: Nov 01, 2018

Spacing Factor is 1 unless specified otherwise

NOTES:
 1. Legend and border shall be direct applied, Grade "A" sheeting (except those that are colored black).
 2. Background shall be Grade "C" reflective sheeting.

LETTER POSITIONS

Letter spacings are to start of next letter

Series/Size	Text Length
EM 2000	189.9
E 2000	52.6
S	19
w	16.2
i	21
f	8
t	10.1
C	8.3
r	16
e	17.4
e	10.4
k	14.1
R	15.5
d	10.6
	16
	15.8
	10.6
	19
	87.7
	4.5
	15
	12
	4.4
	9.2
	7.5
	87.7

FILENAME: Sign Designs - Fwy Intermediate - Revised
 NORTH CAROLINA D.O.T. SIGN DETAIL

SIGN NUMBER: 2A
 TYPE: B (OVHD)
 QUANTITY: 1
 SIGN WIDTH: 11'-0"
 HEIGHT: 2'-6"
 TOTAL AREA: 27.5 Sq.Ft.
 BORDER TYPE: FLUSH
 RECESS: 0"
 WIDTH: 2"
 RADII: 3"
 No. Z BARS: 2
 LENGTH: 124.0

BACKG COLOR: Green
 COPY COLOR: White
 SYMBOL X Y WID HT
 MAT'L: 0.125" (3.2 mm) ALUMINUM

PROJECT ID: W-5600
 DESIGN BY: James Hambricht
 LOCATION: Above Sign #28
 CHECKED BY: Name
 DIVISION: 4
 DATE: Nov 01, 2018

Spacing Factor is 1 unless specified otherwise

NOTES:
 1. Legend and border shall be direct applied, Grade "A" sheeting (except those that are colored black).
 2. Background shall be Grade "C" reflective sheeting.

LETTER POSITIONS

Letter spacings are to start of next letter

Series/Size	Text Length
E 2000	87.2
E	22.4
X	8.9
I	10.7
T	3.5
3	7.5
3	15
0	14.3
	14.7
	12.6
	22.4

FILENAME: Sign Designs - Fwy Intermediate - Revised
 NORTH CAROLINA D.O.T. SIGN DETAIL

SIGN NUMBER: 2B
 TYPE: A (OVHD)
 QUANTITY: 1
 SIGN WIDTH: 25'-0"
 HEIGHT: 5'-6"
 TOTAL AREA: 137.5 Sq.Ft.
 BORDER TYPE: FLUSH
 RECESS: 0"
 WIDTH: 2"
 RADII: 9"
 No. Z BARS: 2
 LENGTH: 292.0

BACKG COLOR: Green
 COPY COLOR: White
 SYMBOL X Y WID HT
 AR_Type A 251.5 19.1 22.4 35.3
 MAT'L: 0.125" (3.2 mm) ALUMINUM

PROJECT ID: W-5600
 DESIGN BY: James Hambricht
 LOCATION: Overhead Sign Structure "A" @ -L- Sta. 233+00 (LT)
 CHECKED BY: Name
 DIVISION: 4
 DATE: Oct 10, 2018

Spacing Factor is 1 unless specified otherwise

NOTES:
 1. Legend and border shall be direct applied, Grade "A" sheeting (except those that are colored black).
 2. Background shall be Grade "C" reflective sheeting.
 3. Shields and Type "A", "B", and "C" Arrows shall be demountable and made from 0.032" (0.8mm) aluminum.

LETTER POSITIONS

Letter spacings are to start of next letter

Series/Size	Text Length
EM 2000	214.7
W	20.7
i	20.8
i	9.6
s	7.8
o	14.1
n	15.8
'	14.4
s	5.3
M	10.6
i	16
i	20.3
i	9.6
s	9.6
R	7.8
d	10.6
	16
	15.8
	10.6
	54.5

FILENAME: Sign Designs - Fwy Intermediate - Revised
 NORTH CAROLINA D.O.T. SIGN DETAIL

\$\$\$SYTIME\$\$\$\$
 \$\$\$DDGN\$\$\$\$
 \$\$\$USERNAM\$\$\$\$
 \$\$\$

SIGN DESIGNS
 (TYPE "A" & "B")

TIP NO.	SHEET NO.
W-5600	SIGN-4B
APPROVED: <i>Betsy H. Watson</i> <small>DocuSigned by: Betsy H. Watson 35E67B84F87A3F...</small>	
DATE: 5/20/2019	
DOCUMENT NOT CONSIDERED FINAL UNLESS ALL SIGNATURES COMPLETED	

SIGN NUMBER: 103B **BACKG COLOR: Green**
TYPE: A **COPY COLOR: White**
QUANTITY: 1

SYMBOL	X	Y	WID	HT
MT_4	69	99.9	36	36

SIGN WIDTH: 14'-6"
 HEIGHT: 14'-0"
 TOTAL AREA: 203.0 Sq.Ft.

BORDER TYPE: FLUSH
 RECESS: 0"
 WIDTH: 2"
 RADII: 12"

MAT'L: 0.125" (3.2 mm) ALUMINUM

No. Z BARS: 4
 LENGTH: 166.0

PROJECT ID: W-5600 CHECKED BY: Name DIVISION: 4
 DESIGN BY: James Hambricht DATE: Nov 05, 2018
 LOCATION: -L- Sta. 57+00 (LT)

Spacing Factor is 1 unless specified otherwise

LETTER POSITIONS

Letter spacings are to start of next letter											Series/Size	Text Length
B	U	S	I	N	E	S	S				E 2000	71.9
51.1	10.1	10.1	10.1	4.4	10.7	8.9	9.5	8.1	51		EM 2000	132.8
S	m	i	t	h	f	i	e	l	d		EM 2000	95.8
20.6	17.9	24	8	13.4	15.4	11.7	8.2	15.5	8.2	10.6	E 2000	47.6
C	l	o	y	t	o	n						
39.1	17.4	8.2	15.2	16.6	12	15.8	10.6	39.1				
t	M	I	L	E								
63.2	4.5	10	12	4.4	9.2	7.5	63.2					

FILENAME: Sign Designs - Fwy Intermediate - Revised NORTH CAROLINA D.O.T. SIGN DETAIL

SIGN NUMBER: 104A, 105A, 106A, 109A, 111A **BACKG COLOR: Green**
TYPE: B **COPY COLOR: White**
QUANTITY: 5

SYMBOL	X	Y	WID	HT

SIGN WIDTH: 11'-0"
 HEIGHT: 2'-6"
 TOTAL AREA: 27.5 Sq.Ft.

BORDER TYPE: FLUSH
 RECESS: 0"
 WIDTH: 2"
 RADII: 3"

MAT'L: 0.125" (3.2 mm) ALUMINUM

No. Z BARS: 2
 LENGTH: 124.0

PROJECT ID: W-5600 CHECKED BY: Name DIVISION: 4
 DESIGN BY: James Hambricht DATE: Nov 01, 2018
 LOCATION: Above Signs 104A, 105A, 106A, 109A, & 111A

Spacing Factor is 1 unless specified otherwise

LETTER POSITIONS

Letter spacings are to start of next letter											Series/Size	Text Length
E	X	I	T	3	2	9					E 2000	86.3
22.9	8.9	10.7	3.5	7.5	15	14.3	14.3	12.2	22.9			

FILENAME: Sign Designs - Fwy Intermediate - Revised NORTH CAROLINA D.O.T. SIGN DETAIL

SIGN NUMBER: 104B **BACKG COLOR: Green**
TYPE: A **COPY COLOR: White**
QUANTITY: 1

SYMBOL	X	Y	WID	HT

SIGN WIDTH: 19'-0"
 HEIGHT: 6'-6"
 TOTAL AREA: 123.5 Sq.Ft.

BORDER TYPE: FLUSH
 RECESS: 0"
 WIDTH: 2"
 RADII: 9"

MAT'L: 0.125" (3.2 mm) ALUMINUM

No. Z BARS: 2
 LENGTH: 220.0

PROJECT ID: W-5600 CHECKED BY: Name DIVISION: 4
 DESIGN BY: James Hambricht DATE: Oct 10, 2018
 LOCATION: -L- Sta. 66+00 (RT)

Spacing Factor is 1 unless specified otherwise

LETTER POSITIONS

Letter spacings are to start of next letter											Series/Size	Text Length	
S	w	i	f	t	C	r	e	e	k	R	d	EM 2000	189.9
19	16.2	21	8	10.1	8.3	16	17.4	10.4	14.1	15.5	10.6	E 2000	91.6
1		1/4		M	I	L	E	S					
68.2	4.5	7.5	22	15	12	4.4	9.2	8.9	8.1	68.2			

FILENAME: Sign Designs - Fwy Intermediate - Revised NORTH CAROLINA D.O.T. SIGN DETAIL

SIGN NUMBER: 105B, 111B **BACKG COLOR: Green**
TYPE: A **COPY COLOR: White**
QUANTITY: 2

SYMBOL	X	Y	WID	HT

SIGN WIDTH: 19'-0"
 HEIGHT: 6'-6"
 TOTAL AREA: 123.5 Sq.Ft.

BORDER TYPE: FLUSH
 RECESS: 0"
 WIDTH: 2"
 RADII: 10"

MAT'L: 0.125" (3.2 mm) ALUMINUM

No. Z BARS: 2
 LENGTH: 220.0

PROJECT ID: W-5600 CHECKED BY: Name DIVISION: 4
 DESIGN BY: James Hambricht DATE: Oct 10, 2018
 LOCATION: -L- Sta. 107+60 (RT)
 -L- Sta. 202+00 (RT)

Panel Style: guide_fwy_intermediate.ssi
 M.U.T.C.D.: 2009 Edition

Spacing Factor is 1 unless specified otherwise

LETTER POSITIONS

Letter spacings are to start of next letter											Series/Size	Text Length	
S	w	i	f	t	C	r	e	e	k	R	d	EM 2000	189.9
19	16.2	21	8	10.1	8.3	16	17.4	10.4	14.1	15.5	10.6	E 2000	70.1
1/2				M	I	L	E						
79	22	15	12	4.4	9.2	7.5	79						

FILENAME: Sign Designs - Fwy Intermediate - Revised NORTH CAROLINA D.O.T. SIGN DETAIL

\$\$\$\$\$SYTIME\$\$\$\$\$
 \$\$\$DDCN\$\$\$\$\$
 \$\$\$USERNAM\$\$\$\$\$

SIGN DESIGNS
 (TYPE "A" & "B")

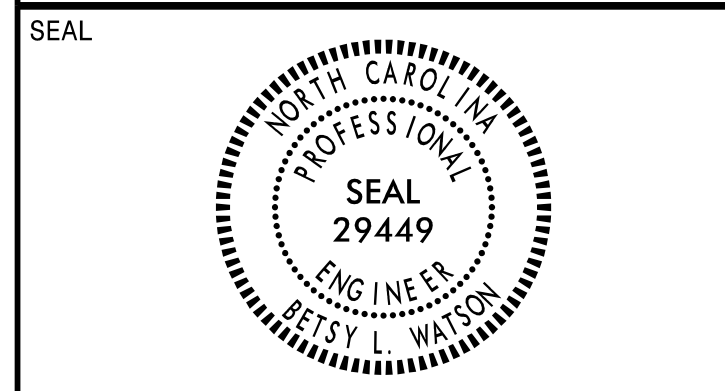

DOCUMENT NOT CONSIDERED FINAL
 UNLESS ALL SIGNATURES COMPLETED



SIGN NUMBER: 106B, 109B

TYPE: A
 QUANTITY: 2

BACKG COLOR: Green
 COPY COLOR: White

SYMBOL	X	Y	WID	HT
AR_Type A	100.1	20.1	22.4	35.3

SIGN WIDTH: 19'-0"
 HEIGHT: 8'-0"
 TOTAL AREA: 152.0 Sq.Ft.

BORDER TYPE: FLUSH
 RECESS: 0"
 WIDTH: 2"
 RADII: 12"

MAT'L: 0.125" (3.2 mm) ALUMINUM

No. Z BARS: 3
 LENGTH: 220.0

PROJECT ID: W-5600
 DESIGN BY: James Hambricht
 LOCATION: -L- Sta. 134+00 (RT)
 -L- Sta. 176+00 (RT)

CHECKED BY: Name
 DIVISION: 4
 DATE: Oct 10, 2018

Spacing Factor is 1 unless specified otherwise

LETTER POSITIONS

Letter spacings are to start of next letter

Series/Size	Text Length
EM 2000	189.9

FILENAME: Sign Designs - Fwy Intermediate - Revised
 NORTH CAROLINA D.O.T. SIGN DETAIL

SIGN NUMBER: 107A, 108A, 110A, 112A, 113A

TYPE: B
 QUANTITY: 5

BACKG COLOR: Green
 COPY COLOR: White

SYMBOL	X	Y	WID	HT
--------	---	---	-----	----

SIGN WIDTH: 11'-0"
 HEIGHT: 2'-6"
 TOTAL AREA: 27.5 Sq.Ft.

BORDER TYPE: FLUSH
 RECESS: 0"
 WIDTH: 2"
 RADII: 3"

MAT'L: 0.125" (3.2 mm) ALUMINUM

No. Z BARS: 2
 LENGTH: 124.0

PROJECT ID: W-5600
 DESIGN BY: James Hambricht
 LOCATION: Above Signs 107B, 108B, 110B, 112B, & 113B

CHECKED BY: Name
 DIVISION: 4
 DATE: Nov 01, 2018

Spacing Factor is 1 unless specified otherwise

LETTER POSITIONS

Letter spacings are to start of next letter

Series/Size	Text Length
E 2000	87.2

FILENAME: Sign Designs - Fwy Intermediate - Revised
 NORTH CAROLINA D.O.T. SIGN DETAIL

SIGN NUMBER: 107B, 113B

TYPE: A
 QUANTITY: 2

BACKG COLOR: Green
 COPY COLOR: White

SYMBOL	X	Y	WID	HT
--------	---	---	-----	----

SIGN WIDTH: 21'-0"
 HEIGHT: 6'-6"
 TOTAL AREA: 136.5 Sq.Ft.

BORDER TYPE: FLUSH
 RECESS: 0"
 WIDTH: 2"
 RADII: 9"

MAT'L: 0.125" (3.2 mm) ALUMINUM

No. Z BARS: 2
 LENGTH: 244.0

PROJECT ID: W-5600
 DESIGN BY: James Hambricht
 LOCATION: -L- Sta. 146+50 (RT)
 -L- Sta. 285+80 (RT) (Beyond Project Limits)

CHECKED BY: Name
 DIVISION: 4
 DATE: Oct 10, 2018

Spacing Factor is 1 unless specified otherwise

LETTER POSITIONS

Letter spacings are to start of next letter

Series/Size	Text Length
EM 2000	214.7
E 2000	52.6

FILENAME: Sign Designs - Fwy Intermediate - Revised
 NORTH CAROLINA D.O.T. SIGN DETAIL

SIGN NUMBER: 108B, 112B

TYPE: A
 QUANTITY: 2

BACKG COLOR: Green
 COPY COLOR: White

SYMBOL	X	Y	WID	HT
--------	---	---	-----	----

SIGN WIDTH: 21'-0"
 HEIGHT: 6'-6"
 TOTAL AREA: 136.5 Sq.Ft.

BORDER TYPE: FLUSH
 RECESS: 0"
 WIDTH: 2"
 RADII: 9"

MAT'L: 0.125" (3.2 mm) ALUMINUM

No. Z BARS: 2
 LENGTH: 244.0

PROJECT ID: W-5600
 DESIGN BY: James Hambricht
 LOCATION: -L- Sta. 171+10 (RT)
 -L- Sta. 259+40 (RT)

CHECKED BY: Name
 DIVISION: 4
 DATE: Oct 10, 2018

Spacing Factor is 1 unless specified otherwise

LETTER POSITIONS

Letter spacings are to start of next letter

Series/Size	Text Length
EM 2000	214.7
E 2000	70.1

FILENAME: Sign Designs - Fwy Intermediate - Revised
 NORTH CAROLINA D.O.T. SIGN DETAIL

\$\$\$\$\$SYTIME\$\$\$\$\$
 \$\$\$\$\$\$DGN\$\$\$\$\$
 \$\$\$\$\$\$USERNAM\$\$\$\$\$

SIGN DESIGNS
 (TYPE "A" & "B")

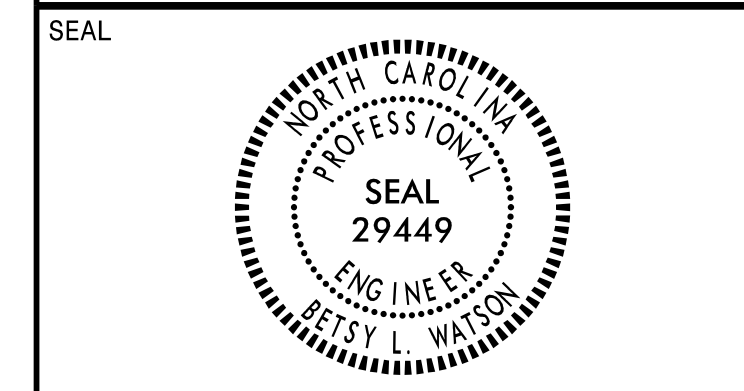

DOCUMENT NOT CONSIDERED FINAL
 UNLESS ALL SIGNATURES COMPLETED



SIGN NUMBER: 110B

TYPE: A
 QUANTITY: 1

BACKG COLOR: Green
 COPY COLOR: White

SYMBOL	X	Y	WID	HT
AR_Type A	112.1	20.1	22.4	35.3

SIGN WIDTH: 21'-0"
 HEIGHT: 8'-0"
 TOTAL AREA: 168.0 Sq.Ft.

BORDER TYPE: FLUSH
 RECESS: 0"
 WIDTH: 2"
 RADII: 12"

MAT'L: 0.125" (3.2 mm) ALUMINUM

No. Z BARS: 3
 LENGTH: 244.0

NOTES:
 1. Legend and border shall be direct applied, Grade "C" sheeting (except those that are colored black).
 2. Background shall be Grade "C" reflective sheeting.
 3. Shields and Type "A", "B", and "C" Arrows shall be demountable and made from 0.032" (0.8mm) aluminum.

PROJECT ID: W-5600
 DESIGN BY: James Hambricht
 LOCATION: -L- Sta. 197+50 (RT)
 CHECKED BY: Name
 DIVISION: 4
 DATE: Oct 10, 2018

LETTER POSITIONS

Letter spacings are to start of next letter

Series/Size	Text Length
EM 2000	214.7

W i l s o n ' s M i l l s R d

FILENAME: Sign Designs - Fwy Intermediate - Revised

NORTH CAROLINA D.O.T. SIGN DETAIL

SIGN NUMBER: 201,202

TYPE: A
 QUANTITY: 2

BACKG COLOR: Green
 COPY COLOR: White

SYMBOL	X	Y	WID	HT
AR_Type A	6.7	6	18.6	29.2

SIGN WIDTH: 8'-0"
 HEIGHT: 5'-0"
 TOTAL AREA: 40.0 Sq.Ft.

BORDER TYPE: FLUSH
 RECESS: 0"
 WIDTH: 1.5"
 RADII: 6"

MAT'L: 0.125" (3.2 mm) ALUMINUM

No. Z BARS: 2
 LENGTH: 88.0

NOTES:
 1. Legend and border shall be direct applied, Grade "C" sheeting (except those that are colored black).
 2. Background shall be Grade "C" reflective sheeting.
 3. Shields and Type "A", "B", and "C" Arrows shall be demountable and made from 0.032" (0.8mm) aluminum.

PROJECT ID: W-5600
 DESIGN BY: James Hambricht
 LOCATION: -L- Sta. 142+67 (RT)
 -L- Sta. 168+36 (RT)
 CHECKED BY: Name
 DIVISION: 4
 DATE: Feb 27, 2019

LETTER POSITIONS

Letter spacings are to start of next letter

Series/Size	Text Length
E 2000	44.4
E 2000	48.8

E X I T 3 2 9

FILENAME: Sign Designs - Fwy Intermediate - Revised

NORTH CAROLINA D.O.T. SIGN DETAIL

SIGN NUMBER: 203,204

TYPE: A
 QUANTITY: 2

BACKG COLOR: Green
 COPY COLOR: White

SYMBOL	X	Y	WID	HT
AR_Type A	6.7	6	18.6	29.2

SIGN WIDTH: 8'-0"
 HEIGHT: 5'-0"
 TOTAL AREA: 40.0 Sq.Ft.

BORDER TYPE: FLUSH
 RECESS: 0"
 WIDTH: 1.5"
 RADII: 6"

MAT'L: 0.125" (3.2 mm) ALUMINUM

No. Z BARS: 2
 LENGTH: 88.0

NOTES:
 1. Legend and border shall be direct applied, Grade "C" sheeting (except those that are colored black).
 2. Background shall be Grade "C" reflective sheeting.
 3. Shields and Type "A", "B", and "C" Arrows shall be demountable and made from 0.032" (0.8mm) aluminum.

PROJECT ID: W-5600
 DESIGN BY: James Hambricht
 LOCATION: -L- Sta. 209+35 (RT)
 -L- Sta. 227+39 (RT)
 CHECKED BY: Name
 DIVISION: 4
 DATE: Feb 27, 2019

LETTER POSITIONS

Letter spacings are to start of next letter

Series/Size	Text Length
E 2000	44.4
E 2000	49.9

E X I T 3 3 0

FILENAME: Sign Designs - Fwy Intermediate - Revised

NORTH CAROLINA D.O.T. SIGN DETAIL

\$\$\$\$\$SYTIME\$\$\$\$\$
 \$\$\$DDCN\$\$\$\$\$
 \$\$\$USERNAME\$\$\$\$\$

SIGN DESIGNS
 (TYPE "A" & "B")

APPROVED: *Etay J. Watson*
35E978B34F8743F
 5/28/2020



DOCUMENT NOT CONSIDERED FINAL
 UNLESS ALL SIGNATURES COMPLETED



SIGN NUMBER: 301 **BACKG COLOR: Green** **CHECKED BY: Name** **DIVISION: 4**
TYPE: D **COPY COLOR: White** **DESIGN BY: James Hambricht** **DATE: Feb 27, 2019**
QUANTITY: 1 **LOCATION: -Y7- (Swift Creek Rd) @ -Y7- Sta. 21+05 (RT)**

SYMBOL	X	Y	WID	HT
AR_Type D	9.5	17.8	6	9
AR_Type D	8	4.7	6	9

SIGN WIDTH: 5'-6"
 HEIGHT: 2'-6"
 TOTAL AREA: 13.8 Sq.Ft.

BORDER TYPE: FLUSH
 RECESS: 0"
 WIDTH: 0.75"
 RADII: 3"

MAT'L: 0.125" (3.2 mm) ALUMINUM

No. Z BARS:
 LENGTH:

NOTES:

- Legend and border shall be direct applied, Grade "C" sheeting (except those that are colored black).
- Background shall be Grade "C" reflective sheeting.

Spacing Factor is 1 unless specified otherwise

LETTER POSITIONS

Letter spacings are to start of next letter											Series/Size	
											Text Length	
	G	o	l	d	s	b	o	r	o			D 2000
23	5	4.6	1.9	4.4	3.6	4.3	4.6	2.8	3.7	8		35
	G	a	r	n	e	r						D 2000
23	5	4.6	3	4.4	4.4	2.3	19.4					23.6

FILENAME: Sign Designs - Fwy Intermediate - Revised **NORTH CAROLINA D.O.T. SIGN DETAIL**

SIGN NUMBER: 302 **BACKG COLOR: Green** **CHECKED BY: Name** **DIVISION: 4**
TYPE: D **COPY COLOR: White** **DESIGN BY: James Hambricht** **DATE: Oct 10, 2018**
QUANTITY: 1 **LOCATION: -Y7- (Swift Creek Rd) @ -Y7- Sta. 29+11 (RT)**

SYMBOL	X	Y	WID	HT
AR_Type D	49	6	6	9

SIGN WIDTH: 5'-6"
 HEIGHT: 1'-6"
 TOTAL AREA: 8.3 Sq.Ft.

BORDER TYPE: FLUSH
 RECESS: 0"
 WIDTH: 0.75"
 RADII: 3"

MAT'L: 0.125" (3.2 mm) ALUMINUM

No. Z BARS:
 LENGTH:

NOTES:

- Legend and border shall be direct applied, Grade "C" sheeting (except those that are colored black).
- Background shall be Grade "C" reflective sheeting.

Spacing Factor is 1 unless specified otherwise

LETTER POSITIONS

Letter spacings are to start of next letter											Series/Size	
											Text Length	
	G	o	l	d	s	b	o	r	o			D 2000
8	5	4.6	1.9	4.4	3.6	4.3	4.6	2.8	3.7	23		35

FILENAME: Sign Designs - Fwy Intermediate - Revised **NORTH CAROLINA D.O.T. SIGN DETAIL**

SIGN NUMBER: 303 **BACKG COLOR: Green** **CHECKED BY: Name** **DIVISION: 4**
TYPE: D **COPY COLOR: White** **DESIGN BY: James Hambricht** **DATE: Feb 27, 2019**
QUANTITY: 1 **LOCATION: -Y7- (Swift Creek Rd) @ -Y7- Sta. 34+33 (LT)**

SYMBOL	X	Y	WID	HT
AR_Type D	9.5	17.8	6	9
AR_Type D	8	4.8	6	9

SIGN WIDTH: 5'-6"
 HEIGHT: 2'-6"
 TOTAL AREA: 13.8 Sq.Ft.

BORDER TYPE: FLUSH
 RECESS: 0"
 WIDTH: 0.75"
 RADII: 3"

MAT'L: 0.125" (3.2 mm) ALUMINUM

No. Z BARS:
 LENGTH:

NOTES:

- Legend and border shall be direct applied, Grade "C" sheeting (except those that are colored black).
- Background shall be Grade "C" reflective sheeting.

Spacing Factor is 1 unless specified otherwise

LETTER POSITIONS

Letter spacings are to start of next letter											Series/Size	
											Text Length	
	G	o	r	n	e	r						D 2000
23	5	4.6	3	4.4	4.4	2.3	19.3					23.6
	G	o	l	d	s	b	o	r	o			D 2000
23	5	4.6	1.9	4.4	3.6	4.3	4.6	2.8	3.7	8		35

FILENAME: Sign Designs - Fwy Intermediate - Revised **NORTH CAROLINA D.O.T. SIGN DETAIL**

SIGN NUMBER: 304 **BACKG COLOR: Green** **CHECKED BY: Name** **DIVISION: 4**
TYPE: D **COPY COLOR: White** **DESIGN BY: James Hambricht** **DATE: Feb 27, 2019**
QUANTITY: 1 **LOCATION: -Y7- (Swift Creek Rd) @ -Y7- Sta. 25+94 (LT)**

SYMBOL	X	Y	WID	HT
AR_Type D	6.1	17.8	6	9
AR_Type D	46.3	4.8	6	9

SIGN WIDTH: 6'-0"
 HEIGHT: 2'-6"
 TOTAL AREA: 15.0 Sq.Ft.

BORDER TYPE: FLUSH
 RECESS: 0"
 WIDTH: 0.75"
 RADII: 3"

MAT'L: 0.125" (3.2 mm) ALUMINUM

No. Z BARS:
 LENGTH:

NOTES:

- Legend and border shall be direct applied, Grade "C" sheeting (except those that are colored black).
- Background shall be Grade "C" reflective sheeting.

Spacing Factor is 1 unless specified otherwise

LETTER POSITIONS

Letter spacings are to start of next letter													Series/Size			
													Text Length			
	W	i	l	s	o	n	'	s	M	i	l	l	s		D 2000	
18.2	6.1	2.2	1.8	3.4	4.6	4.3	1.6	2.8	6	6	2.2	2.2	1.8	2.8	6.1	47.7
	G	o	r	n	e	r										D 2000
16.7	5	4.6	3	4.4	4.4	2.3	31.7									23.6

FILENAME: Sign Designs - Fwy Intermediate - Revised **NORTH CAROLINA D.O.T. SIGN DETAIL**

\$\$\$\$\$SYTIME\$\$\$\$\$
 \$\$\$DDGN\$\$\$\$\$
 \$\$\$USERNAM\$\$\$\$\$

SIGN DESIGNS
 (TYPE "D")

APPROVED: *Betsy L. Watson*
 DATE: 5/28/2020



DOCUMENT NOT CONSIDERED FINAL
 UNLESS ALL SIGNATURES COMPLETED



SIGN NUMBER: 305 PROJECT ID: W-5600 CHECKED BY: Name DIVISION: 4
 DESIGN BY: James Hambricht DATE: Jun 26, 2018
 LOCATION: -RPC- @ -Y7RPC- Sta. 29+65 (RT)

TYPE: D QUANTITY: 1
 SIGN WIDTH: 6'-6" HEIGHT: 1'-6" TOTAL AREA: 9.8 Sq.Ft.
 BORDER TYPE: FLUSH RECESS: 0" WIDTH: 0.75" RADII: 3"
 No. Z BARS: LENGTH:

SYMBOL		X	Y	WID	HT
AR_Type D		7.6	6	6	9

BACKG COLOR: Green COPY COLOR: White
 MAT'L: 0.125" (3.2 mm) ALUMINUM

Panel Style: Standard 6 Inch_D.ssi M.U.T.C.D.: 2009 Edition

Spacing Factor is 1 unless specified otherwise

LETTER POSITIONS

Letter spacings are to start of next letter															Series/Size	Text Length	
															D 2000	47.7	
22.7	6.1	2.2	1.8	3.4	4.6	4.3	1.6	2.8	6	6	2.2	2.2	1.8	2.8	7.6		

FILENAME: Sign Designs - Fwy Intermediate NORTH CAROLINA D.O.T. SIGN DETAIL

SIGN NUMBER: 306 PROJECT ID: W-5600 CHECKED BY: Name DIVISION: 4
 DESIGN BY: James Hambricht DATE: Jun 26, 2018
 LOCATION: -RPA- @ -Y7RPA- Sta. 26+43 (RT)

TYPE: D QUANTITY: 1
 SIGN WIDTH: 6'-6" HEIGHT: 1'-6" TOTAL AREA: 9.8 Sq.Ft.
 BORDER TYPE: FLUSH RECESS: 0" WIDTH: 0.75" RADII: 3"
 No. Z BARS: LENGTH:

SYMBOL		X	Y	WID	HT
AR_Type D		61.4	6	6	9

BACKG COLOR: Green COPY COLOR: White
 MAT'L: 0.125" (3.2 mm) ALUMINUM

Panel Style: Standard 6 Inch_D.ssi M.U.T.C.D.: 2009 Edition

Spacing Factor is 1 unless specified otherwise

LETTER POSITIONS

Letter spacings are to start of next letter															Series/Size	Text Length	
															D 2000	47.7	
7.6	6.1	2.2	1.8	3.4	4.6	4.3	1.6	2.8	6	6	2.2	2.2	1.8	2.8	22.7		

FILENAME: Sign Designs - Fwy Intermediate NORTH CAROLINA D.O.T. SIGN DETAIL

SIGN NUMBER: 307 PROJECT ID: W-5600 CHECKED BY: Name DIVISION: 4
 DESIGN BY: James Hambricht DATE: Feb 27, 2019
 LOCATION: -Y9- (Wilson's Mills Rd) @ -Y9- Sta. 16+71 (RT)

TYPE: D QUANTITY: 1
 SIGN WIDTH: 5'-0" HEIGHT: 2'-6" TOTAL AREA: 12.5 Sq.Ft.
 BORDER TYPE: FLUSH RECESS: 0" WIDTH: 0.75" RADII: 3"
 No. Z BARS: LENGTH:

SYMBOL		X	Y	WID	HT
AR_Type D		6.5	17.8	6	9
AR_Type D		40.3	4.8	6	9

BACKG COLOR: Green COPY COLOR: White
 MAT'L: 0.125" (3.2 mm) ALUMINUM

Panel Style: Standard 6 Inch_D.ssi M.U.T.C.D.: 2009 Edition

Spacing Factor is 1 unless specified otherwise

LETTER POSITIONS

Letter spacings are to start of next letter												Series/Size	Text Length	
												D 2000	35	
18.5	5	4.6	1.9	4.4	3.6	4.3	4.6	2.8	3.7	6.5				
10.7	5	4.6	3	4.4	4.4	2.3	25.7							

FILENAME: Sign Designs - Fwy Intermediate - Revised NORTH CAROLINA D.O.T. SIGN DETAIL

SIGN NUMBER: 308 PROJECT ID: W-5600 CHECKED BY: Name DIVISION: 4
 DESIGN BY: James Hambricht DATE: Feb 27, 2019
 LOCATION: -Y9- (Wilson's Mills Rd) @ -Y9- Sta. 21+34 (RT)

TYPE: D QUANTITY: 1
 SIGN WIDTH: 5'-6" HEIGHT: 2'-6" TOTAL AREA: 13.8 Sq.Ft.
 BORDER TYPE: FLUSH RECESS: 0" WIDTH: 0.75" RADII: 3"
 No. Z BARS: LENGTH:

SYMBOL		X	Y	WID	HT
AR_Type D		9.1	17.8	6	9
AR_Type D		7.6	4.8	6	9

BACKG COLOR: Green COPY COLOR: White
 MAT'L: 0.125" (3.2 mm) ALUMINUM

Panel Style: Standard 6 Inch_D.ssi M.U.T.C.D.: 2009 Edition

Spacing Factor is 1 unless specified otherwise

LETTER POSITIONS

Letter spacings are to start of next letter															Series/Size	Text Length
															D 2000	35.8
22.6	5	7.1	1.6	3.1	4.3	2.9	1.9	4.4	1.9	3.6	7.6					
22.6	5	4.6	1.9	4.4	3.6	4.3	4.6	2.8	3.7	8.4						

FILENAME: Sign Designs - Fwy Intermediate - Revised NORTH CAROLINA D.O.T. SIGN DETAIL

\$\$\$\$\$SYTIME\$\$\$\$\$
 \$\$\$DDGN\$\$\$\$\$
 \$\$\$USERNAME\$\$\$\$\$

SIGN DESIGNS
 (TYPE "D")

APPROVED: *Betsy L. Watson*
35E67B84F87A3F...
 DATE: 5/20/2019



DOCUMENT NOT CONSIDERED FINAL
 UNLESS ALL SIGNATURES COMPLETED



SIGN NUMBER: 309

TYPE: D
 QUANTITY: 1

BACKG COLOR: Green
 COPY COLOR: White

SYMBOL	X	Y	WID	HT
AR_Type D	15.2	17.8	6	9
AR_Type D	49	4.8	6	9

MAT'L: 0.125" (3.2 mm) ALUMINUM

PROJECT ID: W-5600
 DESIGN BY: James Hambricht
 LOCATION: -Y9- (Wilson's Mills Rd) @ -Y9- Sta. 25+50 (LT)
 CHECKED BY: Name
 DIVISION: 4
 DATE: Feb 27, 2019

SIGN WIDTH: 5'-6"
 HEIGHT: 2'-6"
 TOTAL AREA: 13.8 Sq.Ft.

BORDER TYPE: FLUSH
 RECESS: 0"
 WIDTH: 0.75"
 RADII: 3"

No. Z BARS:
 LENGTH:

NOTES:
 1. Legend and border shall be direct applied, Grade "C" sheeting (except those that are colored black).
 2. Background shall be Grade "C" reflective sheeting.

Spacing Factor is 1 unless specified otherwise

LETTER POSITIONS

Letter spacings are to start of next letter													Series/Size
													Text Length
													D 2000
27.2	5	4.6	3	4.4	4.4	2.3	15.2						23.6
													D 2000
8	5	4.6	1.9	4.4	3.6	4.3	4.6	2.8	3.7	2.3			35

FILENAME: Sign Designs - Fwy Intermediate - Revised
 NORTH CAROLINA D.O.T. SIGN DETAIL

SIGN NUMBER: 310

TYPE: D
 QUANTITY: 1

BACKG COLOR: Green
 COPY COLOR: White

SYMBOL	X	Y	WID	HT
AR_Type D	9.5	17.8	6	9
AR_Type D	8	4.8	6	9

MAT'L: 0.125" (3.2 mm) ALUMINUM

PROJECT ID: W-5600
 DESIGN BY: James Hambricht
 LOCATION: -Y9- (Wilson's Mills Rd) @ -Y9- Sta. 20+28 (LT)
 CHECKED BY: Name
 DIVISION: 4
 DATE: Feb 27, 2019

SIGN WIDTH: 6'-6"
 HEIGHT: 2'-6"
 TOTAL AREA: 16.3 Sq.Ft.

BORDER TYPE: FLUSH
 RECESS: 0"
 WIDTH: 0.75"
 RADII: 3"

No. Z BARS:
 LENGTH:

NOTES:
 1. Legend and border shall be direct applied, Grade "C" sheeting (except those that are colored black).
 2. Background shall be Grade "C" reflective sheeting.

Spacing Factor is 1 unless specified otherwise

LETTER POSITIONS

Letter spacings are to start of next letter													Series/Size
													Text Length
													D 2000
22.4	6.1	2.2	1.8	3.4	4.6	4.3	1.6	2.8	6	6	2.2	2.2	47.7
													D 2000
22.4	5	4.6	3	4.4	4.4	2.3	3.2						23.6

FILENAME: Sign Designs - Fwy Intermediate - Revised
 NORTH CAROLINA D.O.T. SIGN DETAIL

SIGN NUMBER: 311

TYPE: D
 QUANTITY: 1

BACKG COLOR: Green
 COPY COLOR: White

SYMBOL	X	Y	WID	HT
AR_Type D	7.7	19.3	6	9
AR_Type D	55.4	4.8	6	9

MAT'L: 0.125" (3.2 mm) ALUMINUM

PROJECT ID: W-5600
 DESIGN BY: James Hambricht
 LOCATION: -RPC- @ -Y9RPC- Sta. 24+26 (RT)
 CHECKED BY: Name
 DIVISION: 4
 DATE: Feb 27, 2019

SIGN WIDTH: 6'-6"
 HEIGHT: 2'-6"
 TOTAL AREA: 16.3 Sq.Ft.

BORDER TYPE: FLUSH
 RECESS: 0"
 WIDTH: 0.75"
 RADII: 3"

No. Z BARS:
 LENGTH:

NOTES:
 1. Legend and border shall be direct applied, Grade "C" sheeting (except those that are colored black).
 2. Background shall be Grade "C" reflective sheeting.

Spacing Factor is 1 unless specified otherwise

LETTER POSITIONS

Letter spacings are to start of next letter													Series/Size
													Text Length
													D 2000
22.7	6.1	2.2	1.8	3.4	4.6	4.3	1.6	2.8	6	6	2.2	2.2	47.7
													D 2000
13.6	5	7.1	1.6	3.1	4.3	2.9	1.9	4.4	1.9	3.6	28.6		35.8

FILENAME: Sign Designs - Fwy Intermediate - Revised
 NORTH CAROLINA D.O.T. SIGN DETAIL

SIGN NUMBER: 312

TYPE: D
 QUANTITY: 1

BACKG COLOR: Green
 COPY COLOR: White

SYMBOL	X	Y	WID	HT
AR_Type D	13.6	19.3	6	9
AR_Type D	61.4	4.8	6	9

MAT'L: 0.125" (3.2 mm) ALUMINUM

PROJECT ID: W-5600
 DESIGN BY: James Hambricht
 LOCATION: -RPA- @ -Y9RPA- Sta. 24+44 (RT)
 CHECKED BY: Name
 DIVISION: 4
 DATE: Mar 06, 2019

SIGN WIDTH: 6'-6"
 HEIGHT: 2'-6"
 TOTAL AREA: 16.3 Sq.Ft.

BORDER TYPE: FLUSH
 RECESS: 0"
 WIDTH: 0.75"
 RADII: 3"

No. Z BARS:
 LENGTH:

NOTES:
 1. Legend and border shall be direct applied, Grade "C" sheeting (except those that are colored black).
 2. Background shall be Grade "C" reflective sheeting.

Spacing Factor is 1 unless specified otherwise

LETTER POSITIONS

Letter spacings are to start of next letter													Series/Size
													Text Length
													D 2000
28.6	5	7.1	1.6	3.1	4.3	2.9	1.9	4.4	1.9	3.6	13.6		35.8
													D 2000
7.6	6.1	2.2	1.8	3.4	4.6	4.3	1.6	2.8	6	6	2.2	2.2	47.7

FILENAME: Sign Designs - Fwy Intermediate - Revised
 NORTH CAROLINA D.O.T. SIGN DETAIL

\$\$\$\$\$SYTIME\$\$\$\$\$
 \$\$\$USERNAM\$\$\$\$\$

SIGN DESIGNS
 (TYPE "D")

APPROVED: *Eckey H. Watson*
DATE: 5/20/2019

SEAL

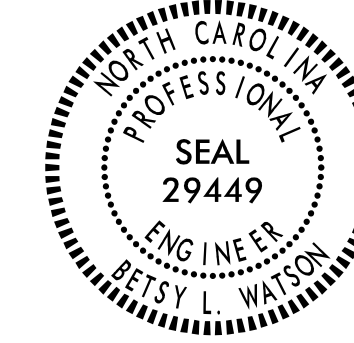

DOCUMENT NOT CONSIDERED FINAL
UNLESS ALL SIGNATURES COMPLETED



SIGN NUMBER: 313

TYPE: D
QUANTITY: 1

BACKG COLOR: Green
COPY COLOR: White

SYMBOL	X	Y	WID	HT
AR_Type D	20	3.5	4	8

MAT'L: 0.125" (3.2 mm) ALUMINUM

No. Z BARS:
LENGTH:

NOTES:
1. Legend and border shall be direct applied, Grade "C" sheeting (except those that are colored black).
2. Background shall be Grade "C" reflective sheeting.

PROJECT ID: W-5600
DESIGN BY: James Hambricht
LOCATION: SR 1913 (Wilson's Mills Rd - NB) @ Turnage Rd (Off Project)
CHECKED BY: Name
DIVISION: 7
DATE: Nov 01, 2018

BORDER R=1.5" TH=0.5"

Spacing Factor is 1 unless specified otherwise

LETTER POSITIONS

Letter spacings are to start of next letter														Series/Size			
														Text Length			
		N	C	D	E	P	A	R	T	M	E	N	T			C 2000	
		5.4	3	2.2	4	3	2.7	2.7	3.1	2.6	2.6	3.5	2.7	2.8	2	5.4	37.2
		C	O	R	R	E	C	T	I	O	N	S					C 2000
		9.2	3	3.2	2.9	2.9	2.6	2.7	2.6	1.4	3.2	2.9	2.2	9.2			29.6

SIGN NUMBER: 314

TYPE: D
QUANTITY: 1

BACKG COLOR: Green
COPY COLOR: White

SYMBOL	X	Y	WID	HT
AR_Type D	20	3.5	4	8

MAT'L: 0.125" (3.2 mm) ALUMINUM

No. Z BARS:
LENGTH:

NOTES:
1. Legend and border shall be direct applied, Grade "C" sheeting (except those that are colored black).
2. Background shall be Grade "C" reflective sheeting.

PROJECT ID: W-5600
DESIGN BY: James Hambricht
LOCATION: SR 1913 (Wilson's Mills Rd - SB) @ Turnage Rd (Off Project)
CHECKED BY: Name
DIVISION: 7
DATE: Nov 01, 2018

BORDER R=1.5" TH=0.5"

Spacing Factor is 1 unless specified otherwise

LETTER POSITIONS

Letter spacings are to start of next letter														Series/Size			
														Text Length			
		N	C	D	E	P	A	R	T	M	E	N	T			C 2000	
		5.4	3	2.2	4	3	2.7	2.7	3.1	2.6	2.6	3.5	2.7	2.8	2	5.4	37.2
		C	O	R	R	E	C	T	I	O	N	S					C 2000
		9.2	3	3.2	2.9	2.9	2.6	2.7	2.6	1.4	3.2	2.9	2.2	9.2			29.6

\$\$\$\$\$SYTIME\$\$\$\$\$
\$\$\$\$\$DDGN\$\$\$\$\$
\$\$\$\$\$USERNAM\$\$\$\$\$

SIGN DESIGNS
(TYPE "D")

TIP NO. W-5600	SHEET NO. SIGN-4I
APPROVED: <i>Betsy F. Watson</i> DATE: 5/20/2019	
SEAL 	
DOCUMENT NOT CONSIDERED FINAL UNLESS ALL SIGNATURES COMPLETED	



401 QUANTITY REQ'D 8



36" X 24"
R5-1a

ONE "U" POST PER SIGN

402 QUANTITY REQ'D 15



36" X 36"
R1-1

TWO "U" POST PER SIGN

403 QUANTITY REQ'D 4



54" X 18"
R6-1

Mount signs back to back with #404 in 2 installations

TWO "U" POST PER SIGN

404 QUANTITY REQ'D 2



54" X 18"
R6-1

Mount signs back to back with #403 in 2 installations

TWO "U" POST PER SIGN

405 QUANTITY REQ'D 14

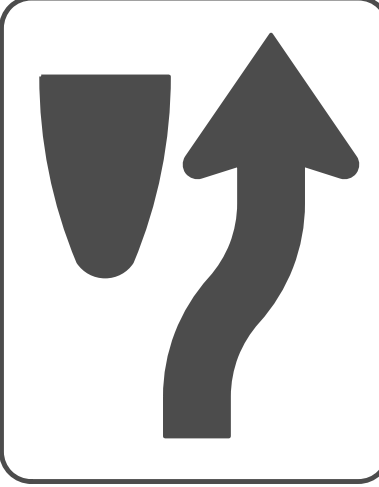

24" X 30"
R4-7

ONE "U" POST PER SIGN

406 QUANTITY REQ'D 4

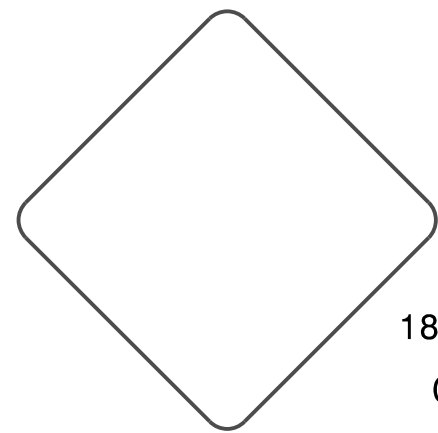

18" X 18"
OM1-3

(MOUNT BELOW SIGN #405 IN 4 INSTALLATIONS)

407 QUANTITY REQ'D 6



30" X 30"
R5-1

ONE "U" POST PER SIGN

408 QUANTITY REQ'D 6

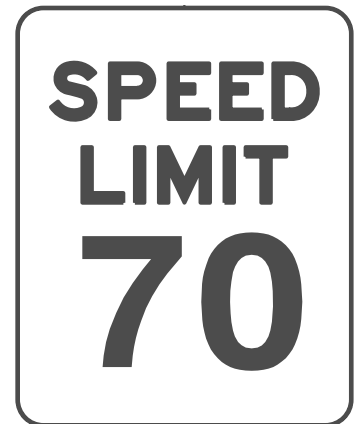

48" X 60"
R2-1

TWO "U" POST PER SIGN

409 QUANTITY REQ'D 2



36" X 48"
R2-1

TWO "U" POST PER SIGN

410 QUANTITY REQ'D 7



30" X 36"
R2-1

ONE "U" POST PER SIGN

411 QUANTITY REQ'D 1

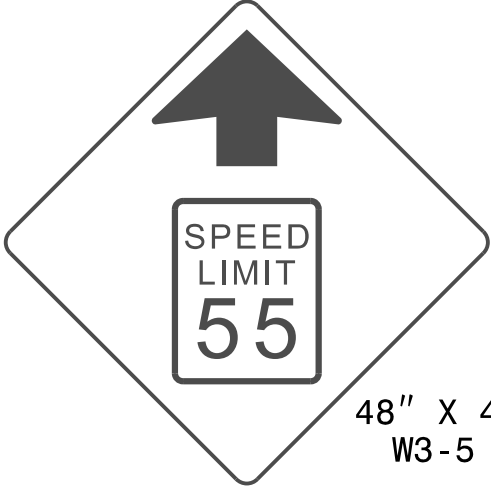

48" X 48"
W3-5

TWO "U" POST PER SIGN

412 QUANTITY REQ'D 9

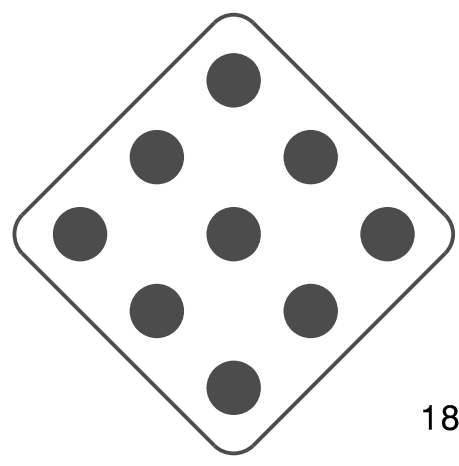

18" X 18"
OM4-1

ONE "U" POST PER SIGN

413 QUANTITY REQ'D 8

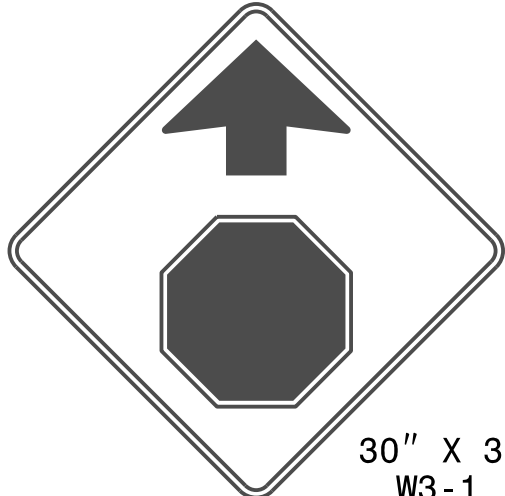

30" X 30"
W3-1

ONE "U" POST PER SIGN

414 QUANTITY REQ'D 3



30" X 30"
W14-2

ONE "U" POST PER SIGN

415 QUANTITY REQ'D 4



30" X 30"
W14-1

ONE "U" POST PER SIGN

416 QUANTITY REQ'D 4

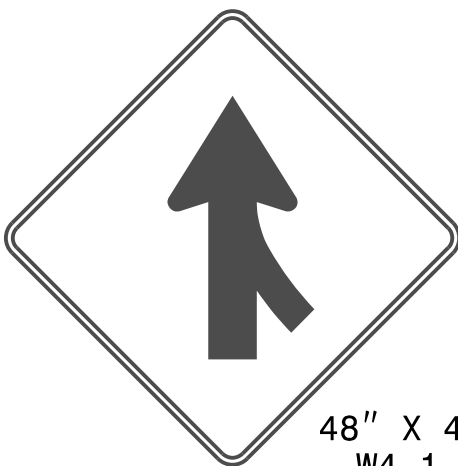

48" X 48"
W4-1

TWO "U" POST PER SIGN

417 QUANTITY REQ'D 2

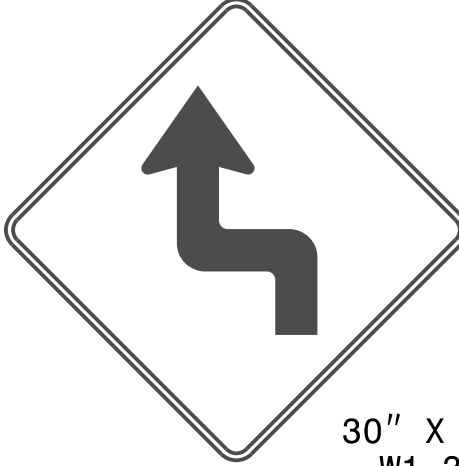

30" X 30"
W1-3

ONE "U" POST PER SIGN

418 QUANTITY REQ'D 2

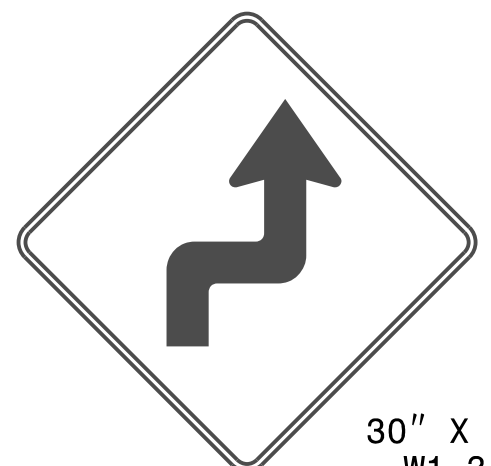

30" X 30"
W1-3

ONE "U" POST PER SIGN

419 QUANTITY REQ'D 1

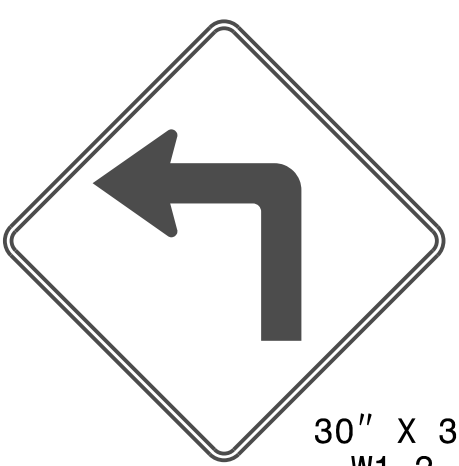

30" X 30"
W1-2

ONE "U" POST PER SIGN

420 QUANTITY REQ'D 1

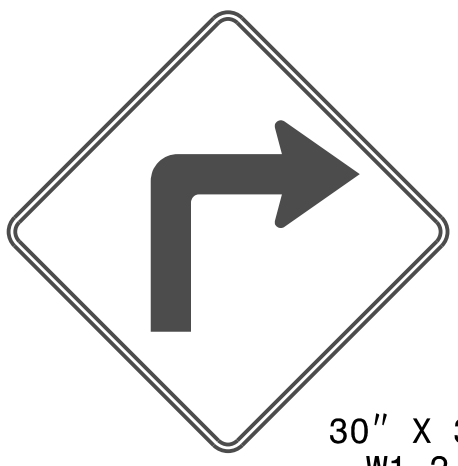

30" X 30"
W1-2

ONE "U" POST PER SIGN

421 QUANTITY REQ'D 1



30" X 36"
R2-1

ONE "U" POST PER SIGN

422 QUANTITY REQ'D 1

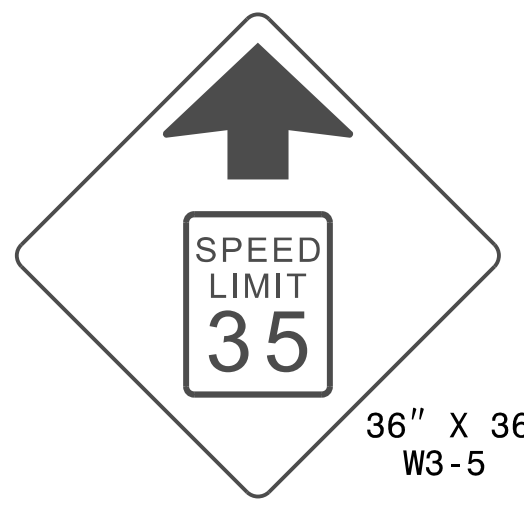

36" X 36"
W3-5

TWO "U" POST PER SIGN

423 QUANTITY REQ'D 6



18" X 18"
W13-1P

(MOUNT BELOW SIGN #417, #418, #419, & #420 IN 6 INSTALLATIONS)

424 QUANTITY REQ'D 9



30" X 36"
R2-1

ONE "U" POST PER SIGN

425 QUANTITY REQ'D 27

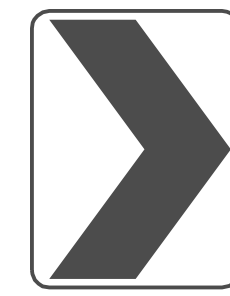

18" X 24"
W1-8

ONE "U" POST PER SIGN

426 QUANTITY REQ'D 27

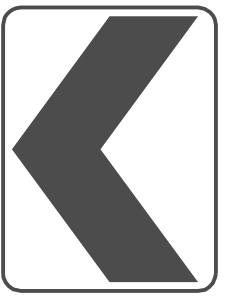

18" X 24"
W1-8

ONE "U" POST PER SIGN

\$\$\$\$\$SYTIME\$\$\$\$\$
\$\$\$\$\$DGN\$\$\$\$\$
\$\$\$\$\$USERNAM\$\$\$\$\$

TYPE "E" SIGNS

TIP NO. W-5600	SHEET NO. SIGN-4J
APPROVED: <i>Betsy L. Watson</i> 35E67B84F87A3F...	
DATE: 5/20/2019	
SEAL 	
DOCUMENT NOT CONSIDERED FINAL UNLESS ALL SIGNATURES COMPLETED	



501 QUANTITY REQ'D 3
523
525

ONE "U" POST PER SIGN

502 QUANTITY REQ'D 3
522
524

ONE "U" POST PER SIGN

503 QUANTITY REQ'D 4
526
527
528

ONE "U" POST PER SIGN

504 QUANTITY REQ'D 1

TWO "U" POSTS PER SIGN

505 QUANTITY REQ'D 1

TWO "U" POSTS PER SIGN

506 QUANTITY REQ'D 1

ONE "U" POST PER SIGN

507 QUANTITY REQ'D 1

ONE "U" POST PER SIGN

508 QUANTITY REQ'D 1

TWO "U" POSTS PER SIGN

509 QUANTITY REQ'D 1

TWO "U" POSTS PER SIGN

510 QUANTITY REQ'D 1

ONE "U" POST PER SIGN

511 QUANTITY REQ'D 1

ONE "U" POST PER SIGN

512 QUANTITY REQ'D 1

TWO "U" POSTS PER SIGN

513 QUANTITY REQ'D 1

TWO "U" POSTS PER SIGN

514 QUANTITY REQ'D 1

ONE "U" POST PER SIGN

515 QUANTITY REQ'D 1

ONE "U" POST PER SIGN

516 QUANTITY REQ'D 1

TWO "U" POSTS PER SIGN

517 QUANTITY REQ'D 1

TWO "U" POSTS PER SIGN

518 QUANTITY REQ'D 1

ONE "U" POST PER SIGN

519 QUANTITY REQ'D 1

ONE "U" POST PER SIGN

520 QUANTITY REQ'D 1

MOUNT BELOW SIGN #305

521 QUANTITY REQ'D 1

MOUNT BELOW SIGN #306

\$\$\$\$\$SYTIME\$\$\$\$\$
\$\$\$\$\$DGN\$\$\$\$\$
\$\$\$\$\$USERNAM\$\$\$\$\$

TYPE "F" SIGNS

APPROVED: *Betsy L. Watson*
35E67B834F8743F...
 DATE: 5/20/2019



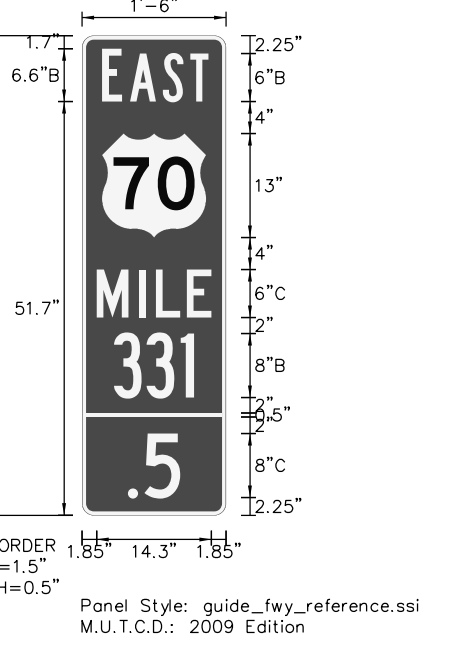
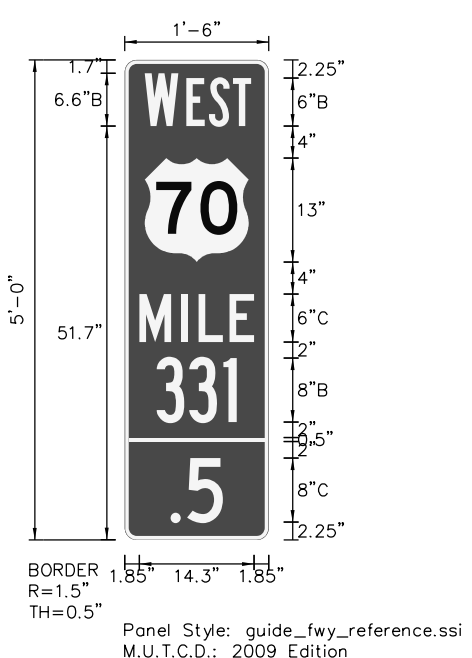
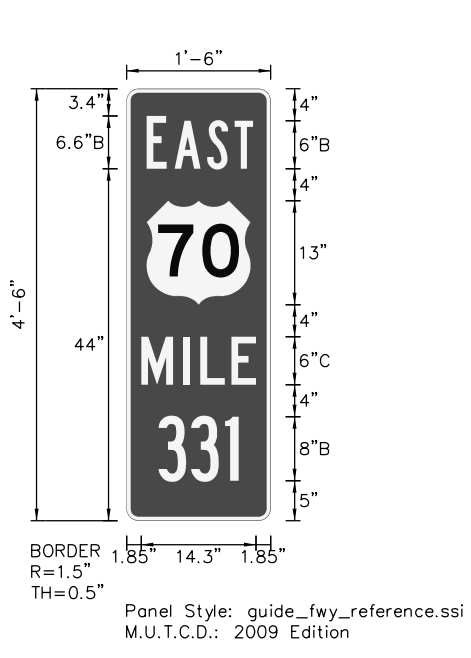
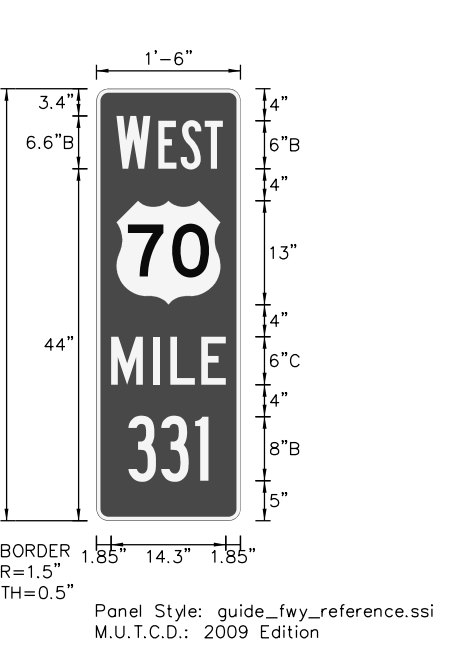
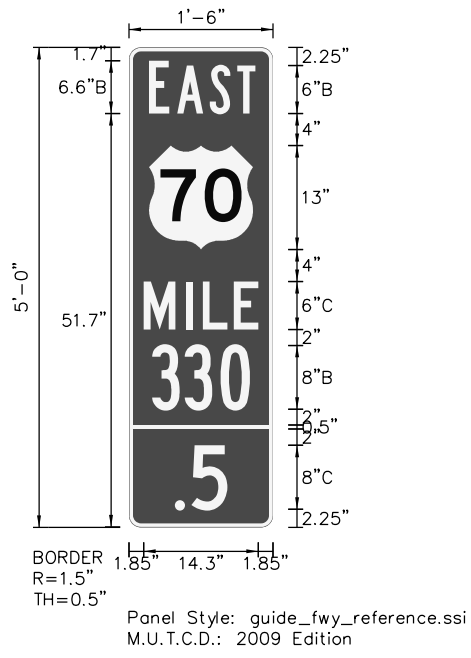
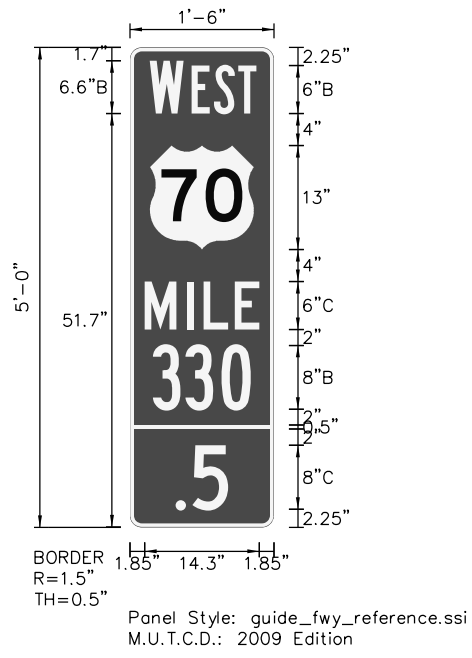
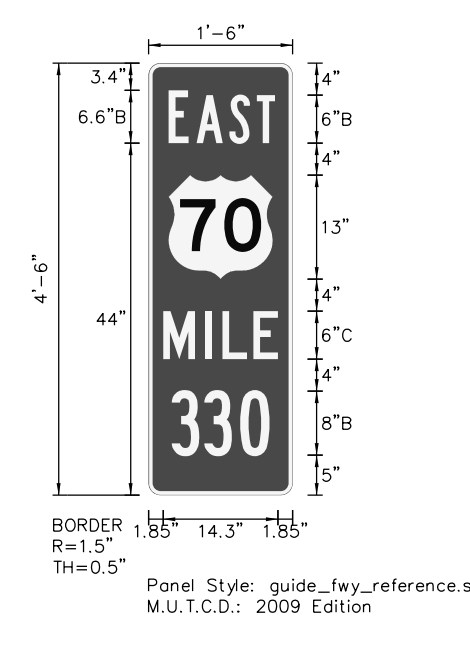
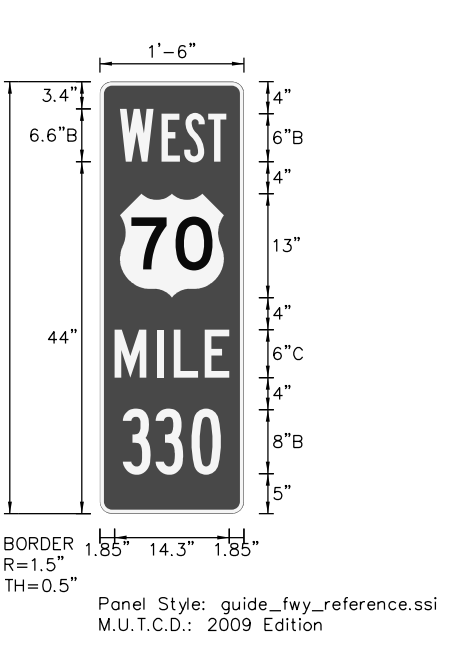
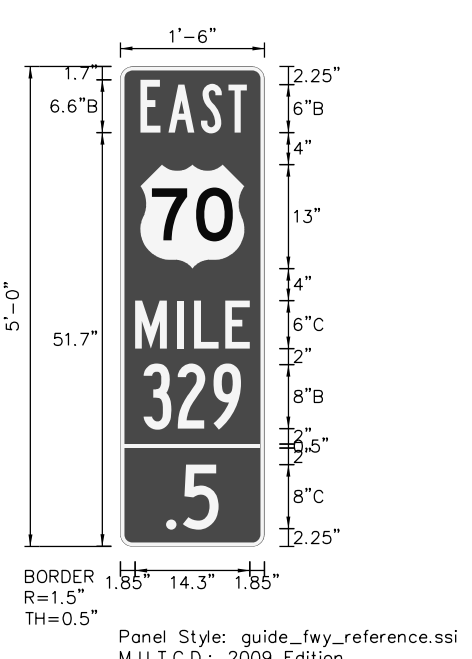
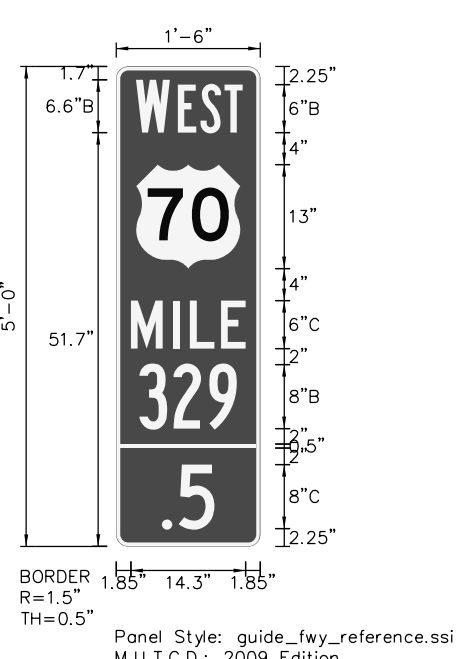
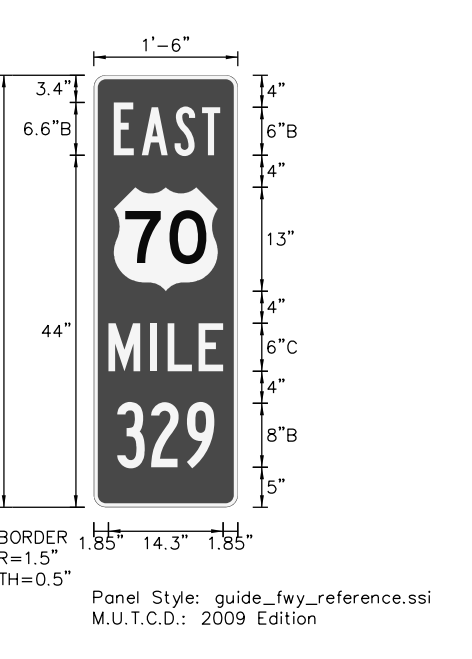
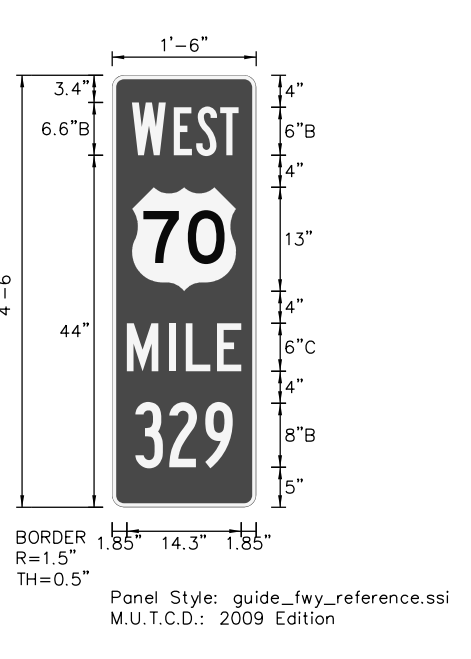
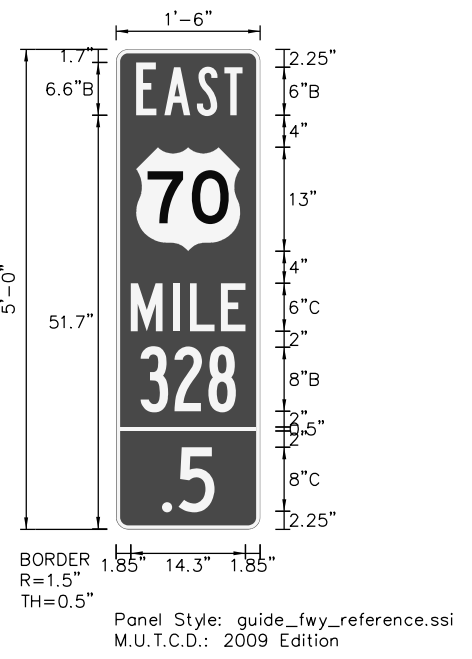
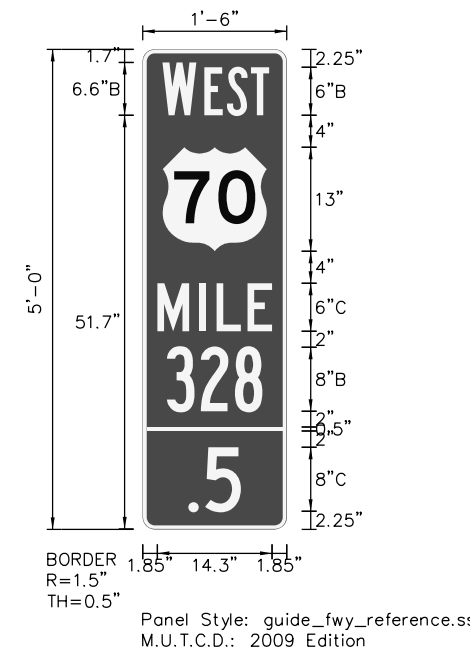
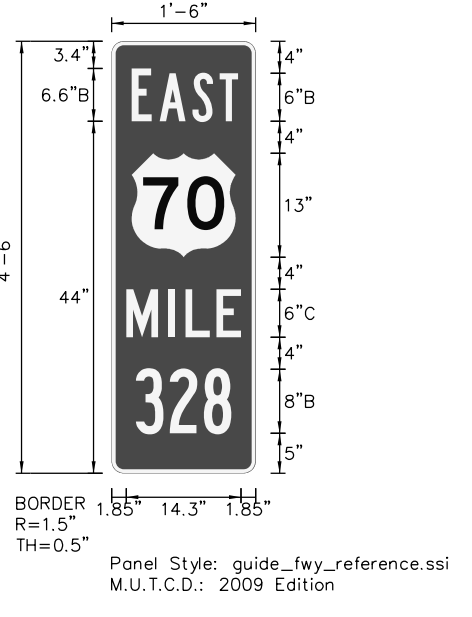
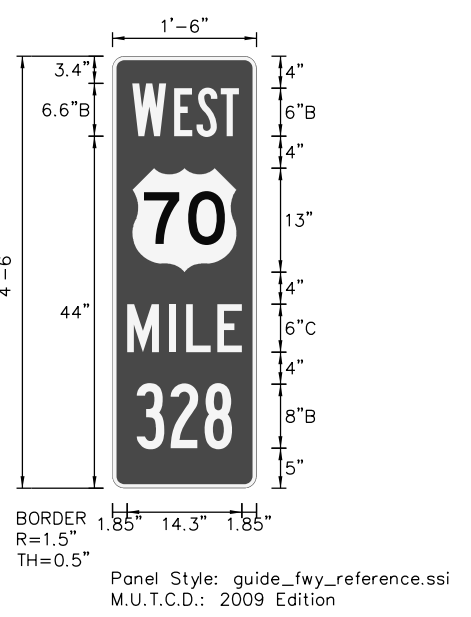
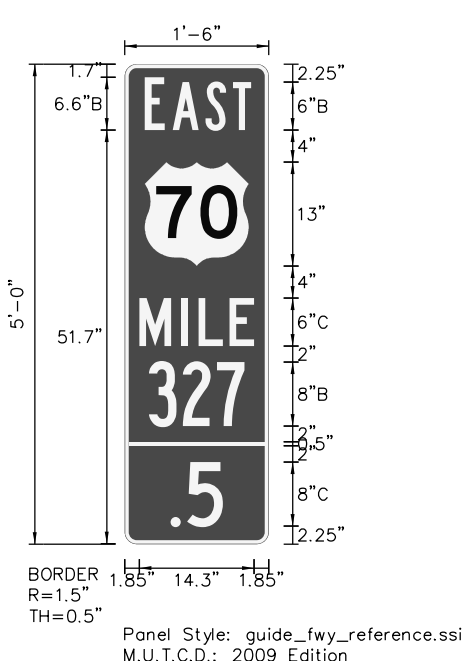
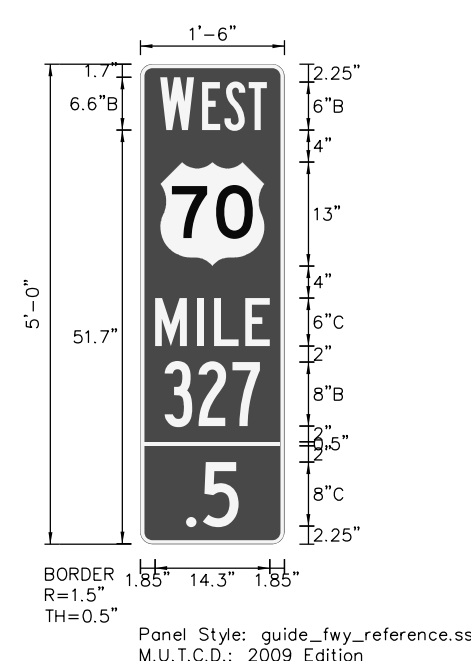
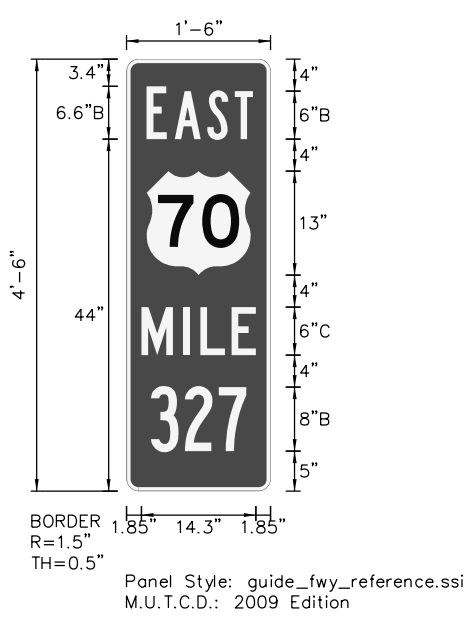
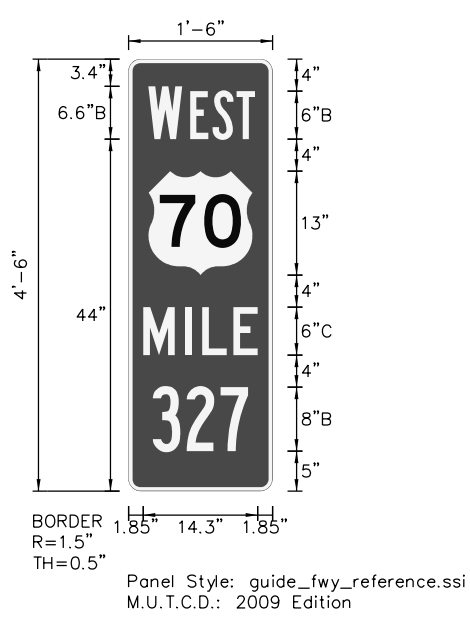

**DOCUMENT NOT CONSIDERED FINAL
 UNLESS ALL SIGNATURES COMPLETED**

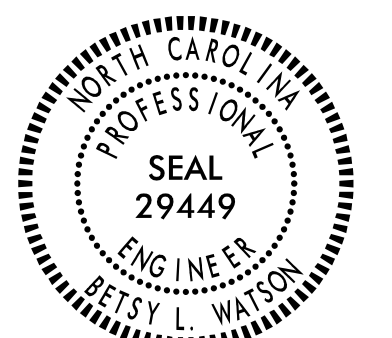

\$\$\$\$\$SYTIME\$\$\$\$\$
 \$\$\$DDGN\$\$\$\$\$
 \$\$\$USERNAM\$\$\$\$\$

MILEMARKERS

TIP NO. W-5600	SHEET NO. SIGN-5
APPROVED: <i>Betsy L. Watson</i> <small>DocuSigned by: Betsy L. Watson 35E67B84F8743F...</small>	
DATE: 5/20/2019	
SEAL 	
DOCUMENT NOT CONSIDERED FINAL UNLESS ALL SIGNATURES COMPLETED	
	

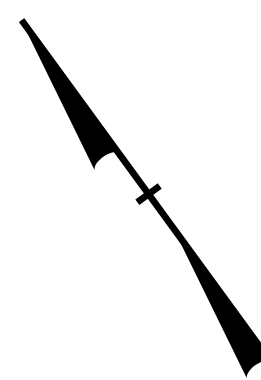

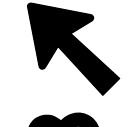
EXIT
326 B 
SIGN TO REMAIN

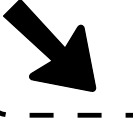
EXIT
326 
SIGN TO REMAIN

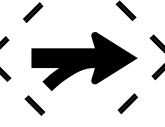
SIGN TO REMAIN

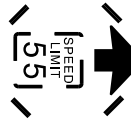
SEE NOTE 2
(2 SIGNS)

SPEED
LIMIT
55
SEE NOTE 2
(2 SIGNS)



MATCHLINE SEE SHEET SIGN-6

PROJECT NOTES

- 1 DISPOSAL OF SIGN SYSTEM, STEEL BEAM
- 2 DISPOSAL OF SIGN SYSTEM, U-CHANNEL
- 3 DISPOSAL OF SIGN SYSTEM, WOOD
- 4 DISPOSAL OF SUPPORT, U-CHANNEL
- 5 DISPOSAL OF SUPPORT, WOOD
- 6 DISPOSAL OF SIGN, MILEMARKER
- 7 SIGN ERECTION, TYPE A (OVERHEAD)
- 8 SIGN ERECTION, TYPE B (OVERHEAD)
- 9 SIGN ERECTION, TYPE A (GROUND MOUNTED)
- 10 SIGN ERECTION, TYPE B (GROUND MOUNTED)
- 11 SIGN ERECTION, TYPE D, E, AND F
- 12 SIGN ERECTION, MILEMARKERS
- 13 RELOCATE SIGN, TYPE D

EXISTING SIGNING

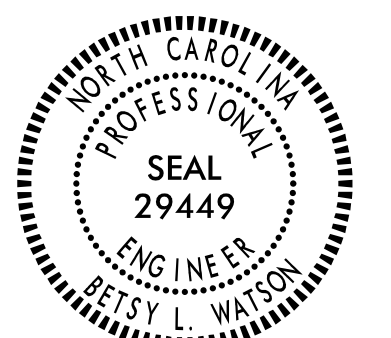
\$\$\$\$\$SYTIME\$\$\$\$\$
\$\$\$\$\$DDGN\$\$\$\$\$
\$\$\$\$\$USERNAME\$\$\$\$\$

TIP NO. W-5600	SHEET NO. SIGN-6
APPROVED: <i>Betsy H. Watson</i> <small>DocuSigned by: Betsy H. Watson 35E67B84F8743F...</small>	
DATE: 5/20/2019	
SEAL 	
DOCUMENT NOT CONSIDERED FINAL UNLESS ALL SIGNATURES COMPLETED	
	

MATCHLINE SEE SHEET SIGN-5

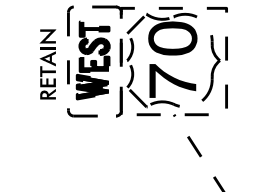
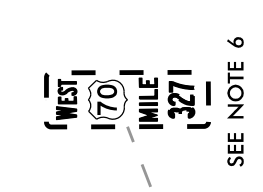
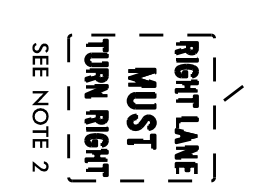
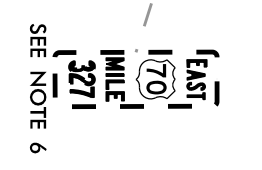
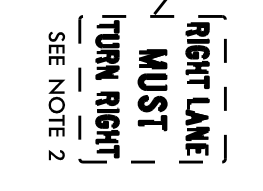
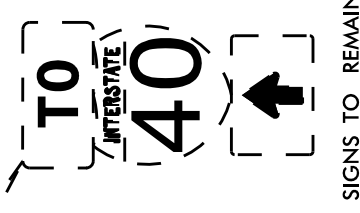
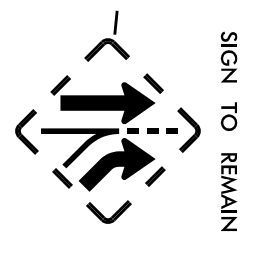

MATCHLINE
-L- STA. 23+50
SEE SHEET SIGN-7

MATCHLINE
-SR2- STA. 15+50
SEE SHEET SIGN-7

PROJECT NOTES

- 1 DISPOSAL OF SIGN SYSTEM, STEEL BEAM
- 2 DISPOSAL OF SIGN SYSTEM, U-CHANNEL
- 3 DISPOSAL OF SIGN SYSTEM, WOOD
- 4 DISPOSAL OF SUPPORT, U-CHANNEL
- 5 DISPOSAL OF SUPPORT, WOOD
- 6 DISPOSAL OF SIGN, MILEMARKER
- 7 SIGN ERECTION, TYPE A (OVERHEAD)
- 8 SIGN ERECTION, TYPE B (OVERHEAD)
- 9 SIGN ERECTION, TYPE A (GROUND MOUNTED)
- 10 SIGN ERECTION, TYPE B (GROUND MOUNTED)
- 11 SIGN ERECTION, TYPE D, E, AND F
- 12 SIGN ERECTION, MILEMARKERS
- 13 RELOCATE SIGN, TYPE D

EXISTING SIGNING

\$\$\$\$\$SYTIME\$\$\$\$\$
 \$\$\$DDGN\$\$\$\$\$
 \$\$\$USERNAME\$\$\$\$\$

TIP NO. W-5600	SHEET NO. SIGN-7
APPROVED: <i>Betsy L. Watson</i> 35E67B84F8743F...	
DATE: 5/20/2019	
SEAL 	
DOCUMENT NOT CONSIDERED FINAL UNLESS ALL SIGNATURES COMPLETED	

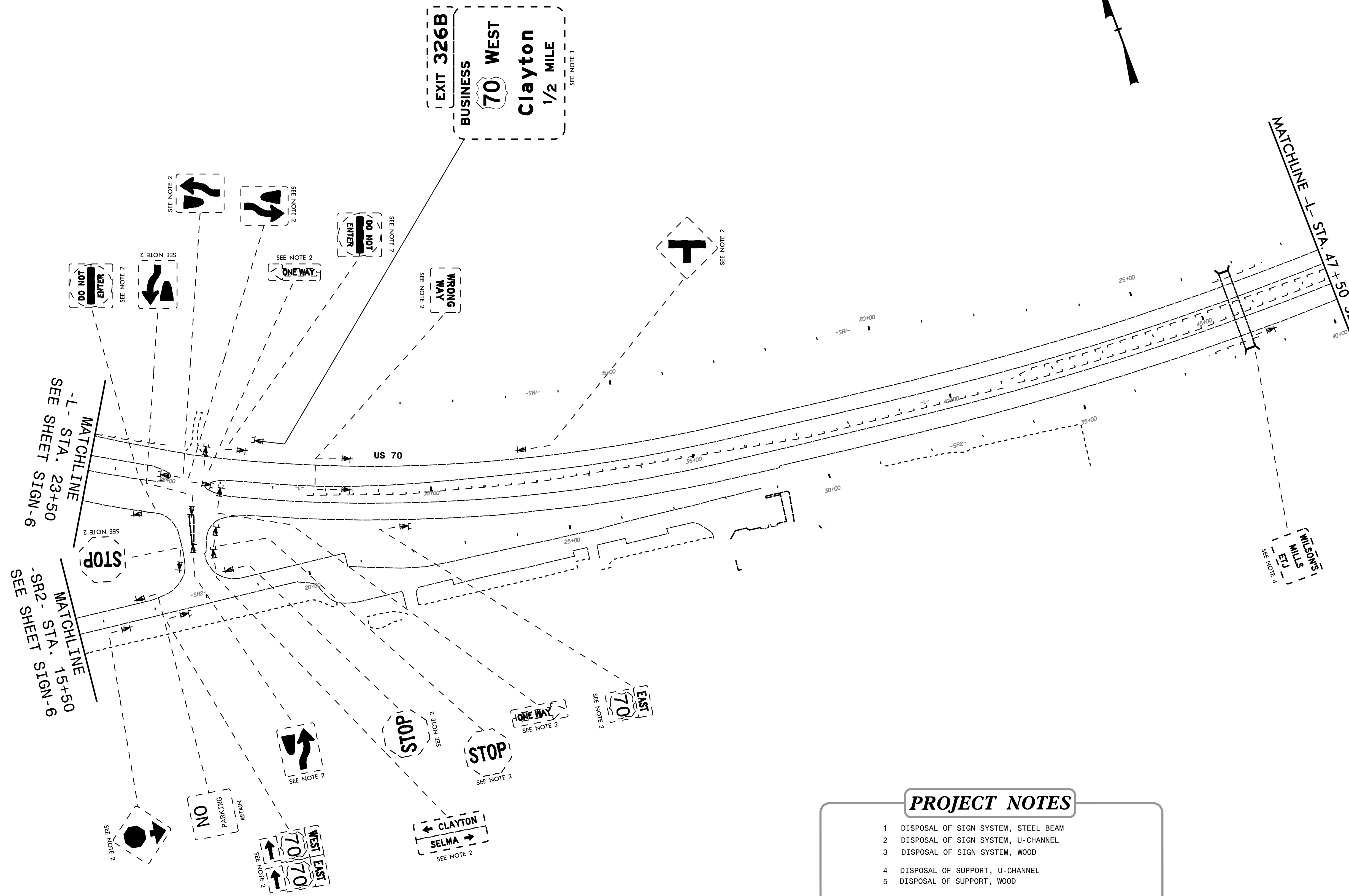



PROJECT NOTES

- DISPOSAL OF SIGN SYSTEM, STEEL BEAM
- DISPOSAL OF SIGN SYSTEM, U-CHANNEL
- DISPOSAL OF SIGN SYSTEM, WOOD
- DISPOSAL OF SUPPORT, U-CHANNEL
- DISPOSAL OF SUPPORT, WOOD
- DISPOSAL OF SIGN, MILEMARKER
- SIGN ERECTION, TYPE A (OVERHEAD)
- SIGN ERECTION, TYPE B (OVERHEAD)
- SIGN ERECTION, TYPE A (GROUND MOUNTED)
- SIGN ERECTION, TYPE B (GROUND MOUNTED)
- SIGN ERECTION, TYPE D, E, AND F
- SIGN ERECTION, MILEMARKERS
- RELOCATE SIGN, TYPE D

EXISTING SIGNING

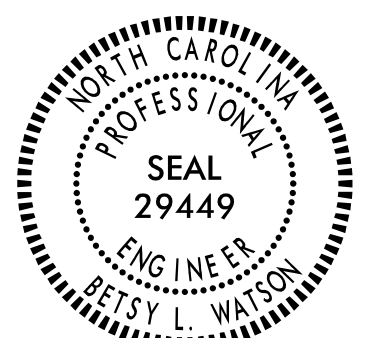
\$\$\$\$\$SYTIME\$\$\$\$\$
\$\$\$\$\$DDGN\$\$\$\$\$
\$\$\$\$\$USERNAM\$\$\$\$\$

TIP NO. W-5600	SHEET NO. SIGN-8
APPROVED: <i>Betsy L. Watson</i> 35E67B84F8743F...	
DATE: 5/20/2019	
SEAL 	
DOCUMENT NOT CONSIDERED FINAL UNLESS ALL SIGNATURES COMPLETED	
	

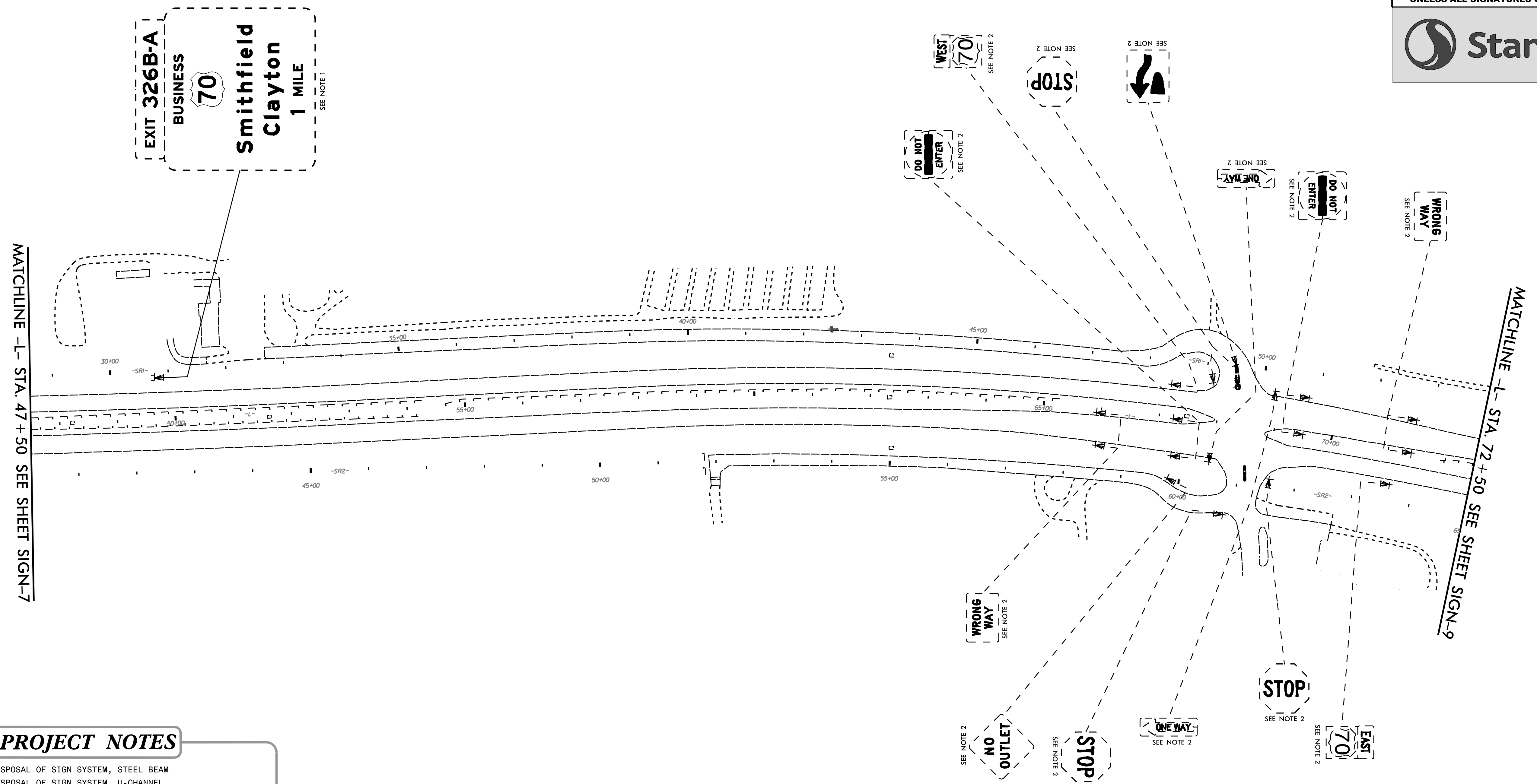



PROJECT NOTES

- 1 DISPOSAL OF SIGN SYSTEM, STEEL BEAM
- 2 DISPOSAL OF SIGN SYSTEM, U-CHANNEL
- 3 DISPOSAL OF SIGN SYSTEM, WOOD
- 4 DISPOSAL OF SUPPORT, U-CHANNEL
- 5 DISPOSAL OF SUPPORT, WOOD
- 6 DISPOSAL OF SIGN, MILEMARKER
- 7 SIGN ERECTION, TYPE A (OVERHEAD)
- 8 SIGN ERECTION, TYPE B (OVERHEAD)
- 9 SIGN ERECTION, TYPE A (GROUND MOUNTED)
- 10 SIGN ERECTION, TYPE B (GROUND MOUNTED)
- 11 SIGN ERECTION, TYPE D, E, AND F
- 12 SIGN ERECTION, MILEMARKERS
- 13 RELOCATE SIGN, TYPE D

\$\$\$\$\$SYTIME\$\$\$\$\$
 \$\$\$DDGN\$\$\$\$\$
 \$\$\$USERNAM\$\$\$\$\$

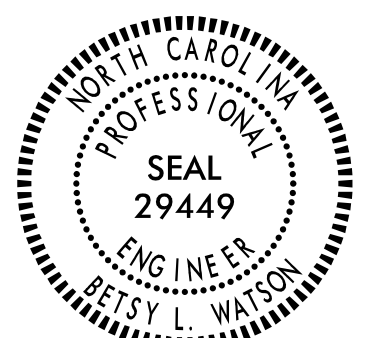
EXISTING SIGNING

TIP NO. W-5600	SHEET NO. SIGN-9
APPROVED: <i>Betsy L. Watson</i> 35E67B84F8743F...	
DATE: 5/20/2019	
SEAL 	
DOCUMENT NOT CONSIDERED FINAL UNLESS ALL SIGNATURES COMPLETED	
	

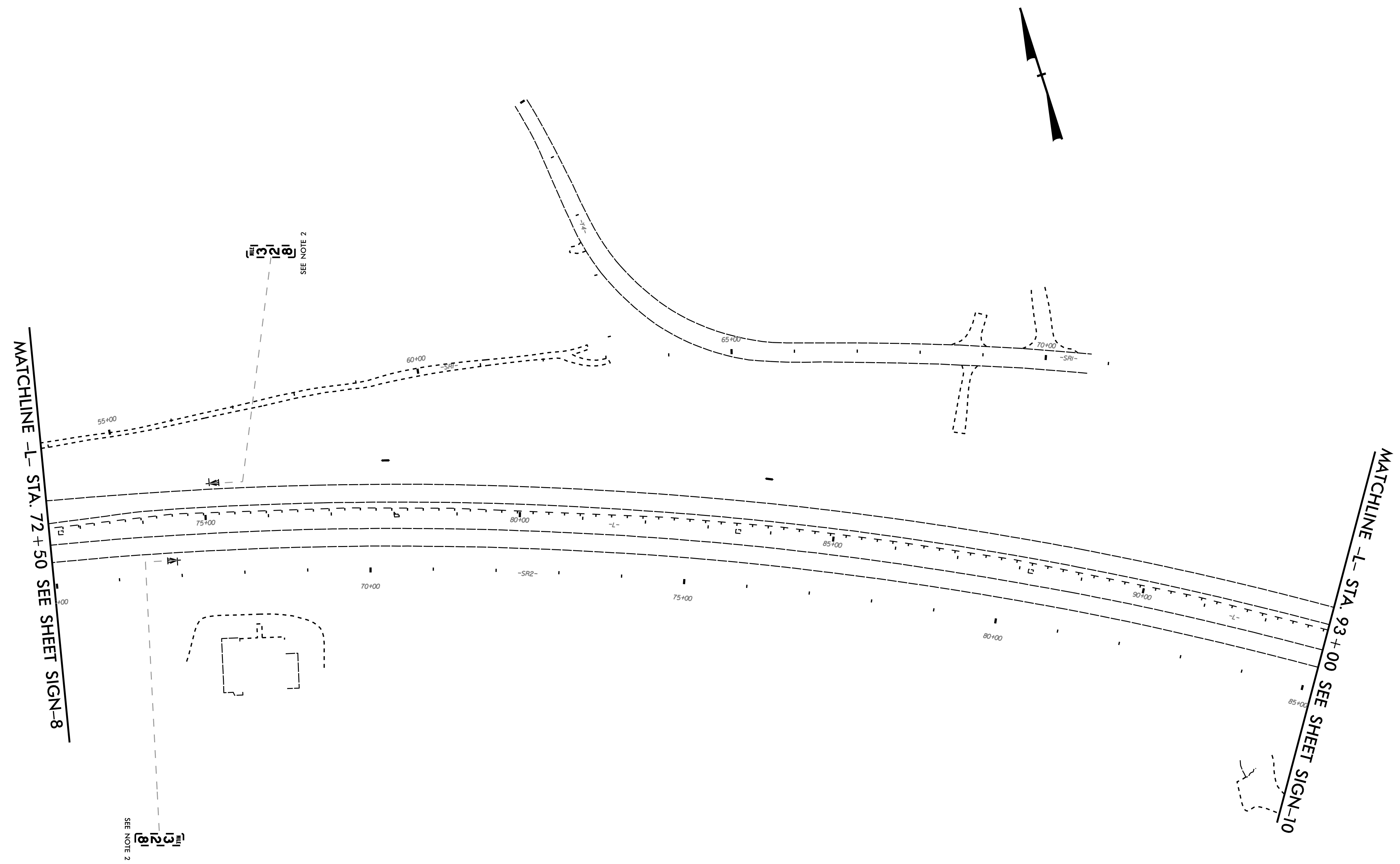



PROJECT NOTES

- 1 DISPOSAL OF SIGN SYSTEM, STEEL BEAM
- 2 DISPOSAL OF SIGN SYSTEM, U-CHANNEL
- 3 DISPOSAL OF SIGN SYSTEM, WOOD
- 4 DISPOSAL OF SUPPORT, U-CHANNEL
- 5 DISPOSAL OF SUPPORT, WOOD
- 6 DISPOSAL OF SIGN, MILEMARKER
- 7 SIGN ERECTION, TYPE A (OVERHEAD)
- 8 SIGN ERECTION, TYPE B (OVERHEAD)
- 9 SIGN ERECTION, TYPE A (GROUND MOUNTED)
- 10 SIGN ERECTION, TYPE B (GROUND MOUNTED)
- 11 SIGN ERECTION, TYPE D, E, AND F
- 12 SIGN ERECTION, MILEMARKERS
- 13 RELOCATE SIGN, TYPE D

EXISTING SIGNING

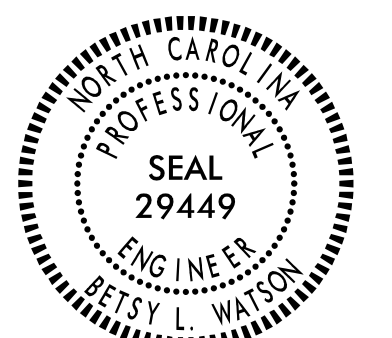
\$\$\$\$\$SYTIME\$\$\$\$\$
\$\$\$\$\$DGN\$\$\$\$\$
\$\$\$\$\$USERNAME\$\$\$\$\$

TIP NO. W-5600	SHEET NO. SIGN - 10
APPROVED: <i>Betsy H. Watson</i> 35E678B34F8743F...	
DATE: 5/20/2019	
SEAL 	
DOCUMENT NOT CONSIDERED FINAL UNLESS ALL SIGNATURES COMPLETED	
	

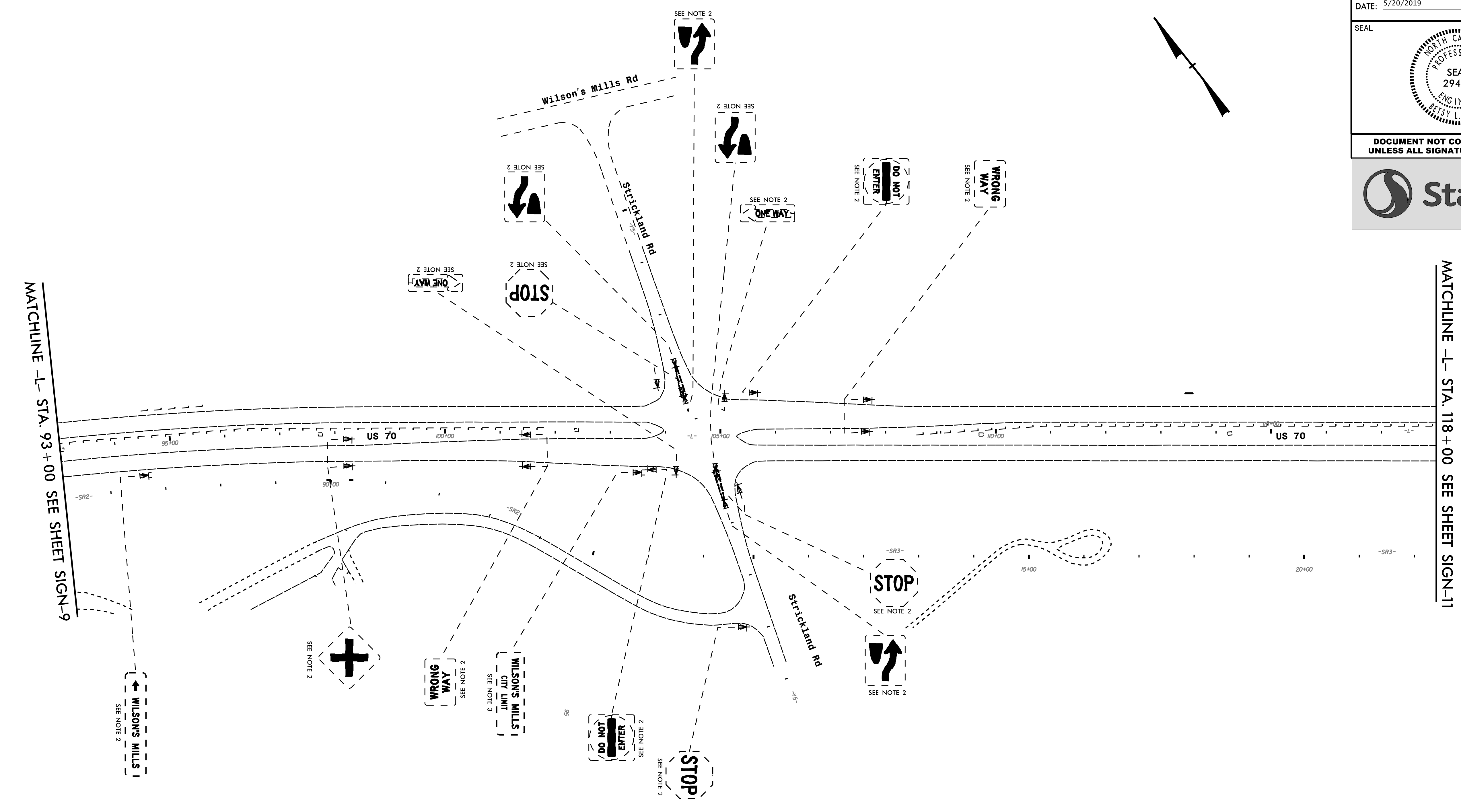



PROJECT NOTES

- 1 DISPOSAL OF SIGN SYSTEM, STEEL BEAM
- 2 DISPOSAL OF SIGN SYSTEM, U-CHANNEL
- 3 DISPOSAL OF SIGN SYSTEM, WOOD
- 4 DISPOSAL OF SUPPORT, U-CHANNEL
- 5 DISPOSAL OF SUPPORT, WOOD
- 6 DISPOSAL OF SIGN, MILEMARKER
- 7 SIGN ERECTION, TYPE A (OVERHEAD)
- 8 SIGN ERECTION, TYPE B (OVERHEAD)
- 9 SIGN ERECTION, TYPE A (GROUND MOUNTED)
- 10 SIGN ERECTION, TYPE B (GROUND MOUNTED)
- 11 SIGN ERECTION, TYPE D, E, AND F
- 12 SIGN ERECTION, MILEMARKERS
- 13 RELOCATE SIGN, TYPE D

EXISTING SIGNING

\$\$\$\$\$SYTIME\$\$\$\$\$
 \$\$\$DDGN\$\$\$\$\$
 \$\$\$USERNAM\$\$\$\$\$

TIP NO. W-5600	SHEET NO. SIGN-11
APPROVED: <i>Betsy L. Watson</i> 35E67B84F87A3F...	
DATE: 5/20/2019	
SEAL 	
DOCUMENT NOT CONSIDERED FINAL UNLESS ALL SIGNATURES COMPLETED	
	

MATCHLINE -L- STA. 118 + 00 SEE SHEET SIGN-10

MATCHLINE -L- STA. 143 + 00 SEE SHEET SIGN-12

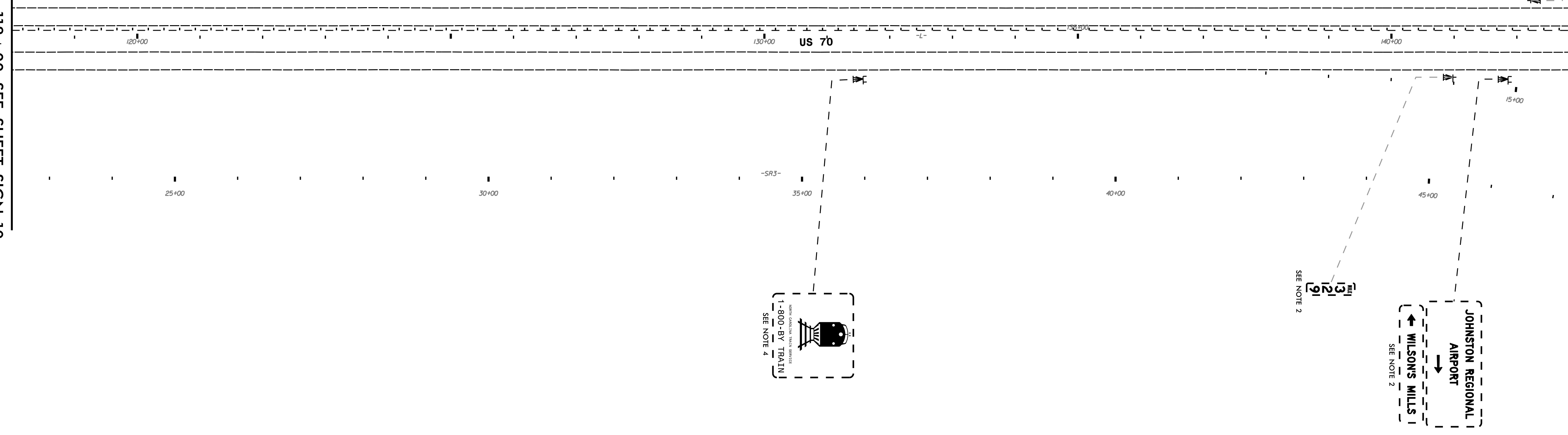



PROJECT NOTES

- 1 DISPOSAL OF SIGN SYSTEM, STEEL BEAM
- 2 DISPOSAL OF SIGN SYSTEM, U-CHANNEL
- 3 DISPOSAL OF SIGN SYSTEM, WOOD
- 4 DISPOSAL OF SUPPORT, U-CHANNEL
- 5 DISPOSAL OF SUPPORT, WOOD
- 6 DISPOSAL OF SIGN, MILEMARKER
- 7 SIGN ERECTION, TYPE A (OVERHEAD)
- 8 SIGN ERECTION, TYPE B (OVERHEAD)
- 9 SIGN ERECTION, TYPE A (GROUND MOUNTED)
- 10 SIGN ERECTION, TYPE B (GROUND MOUNTED)
- 11 SIGN ERECTION, TYPE D, E, AND F
- 12 SIGN ERECTION, MILEMARKERS
- 13 RELOCATE SIGN, TYPE D

EXISTING SIGNING

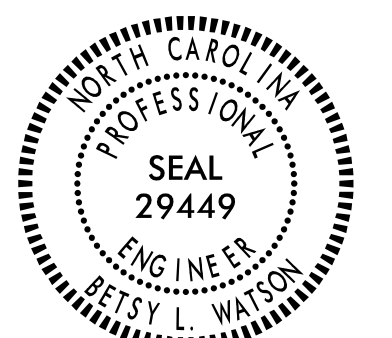
\$\$\$SYTIME\$\$\$\$
\$\$\$DGN\$\$\$\$
\$\$\$USERNAM\$\$\$\$
\$\$\$\$

TIP NO. W-5600	SHEET NO. SIGN-12
APPROVED: <i>Betsy H. Watson</i> <small>35E67B84F8743F...</small>	
DATE: 5/20/2019	
SEAL 	
DOCUMENT NOT CONSIDERED FINAL UNLESS ALL SIGNATURES COMPLETED	
	

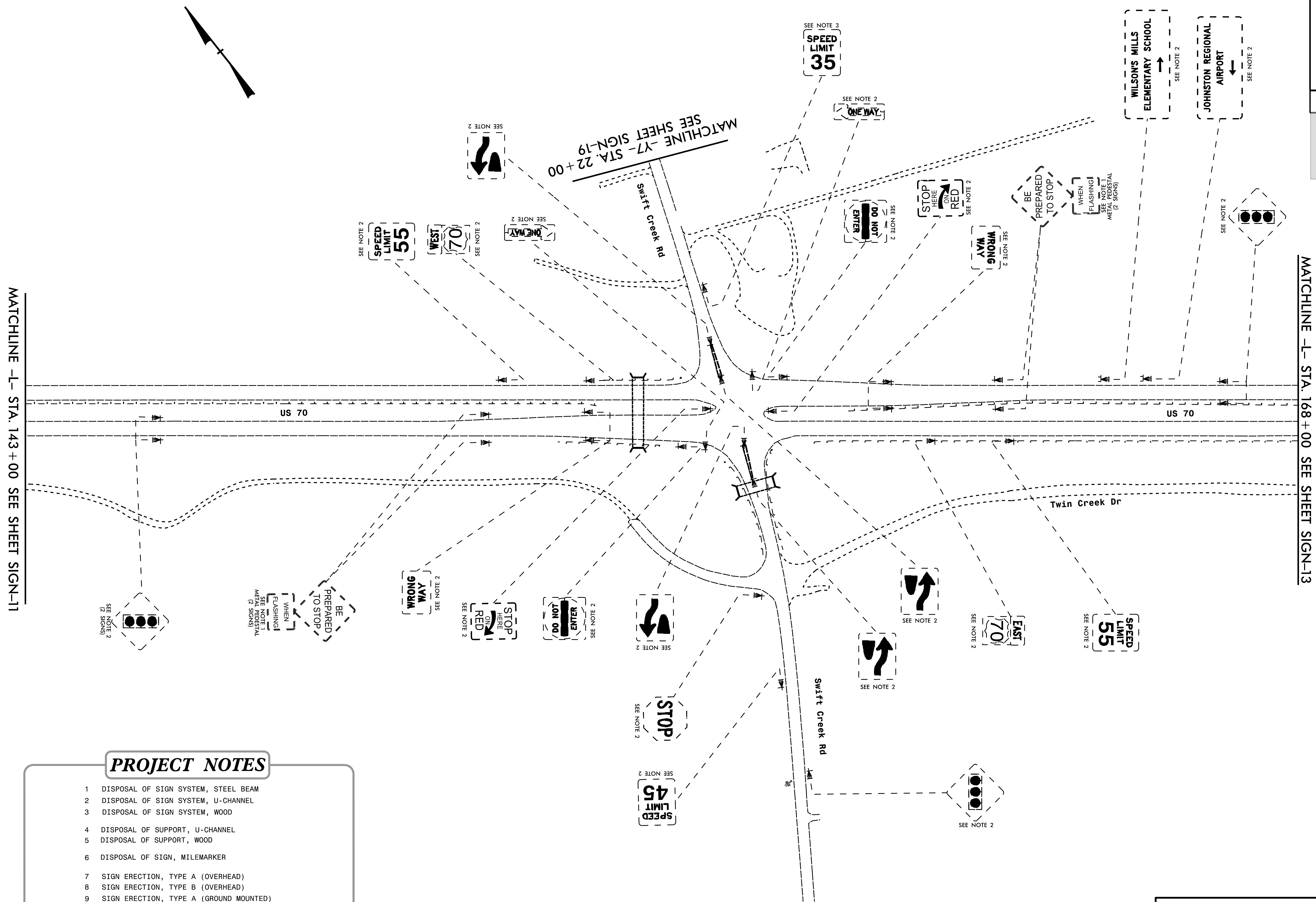



PROJECT NOTES

- DISPOSAL OF SIGN SYSTEM, STEEL BEAM
- DISPOSAL OF SIGN SYSTEM, U-CHANNEL
- DISPOSAL OF SIGN SYSTEM, WOOD
- DISPOSAL OF SUPPORT, U-CHANNEL
- DISPOSAL OF SUPPORT, WOOD
- DISPOSAL OF SIGN, MILEMARKER
- SIGN ERECTION, TYPE A (OVERHEAD)
- SIGN ERECTION, TYPE B (OVERHEAD)
- SIGN ERECTION, TYPE A (GROUND MOUNTED)
- SIGN ERECTION, TYPE B (GROUND MOUNTED)
- SIGN ERECTION, TYPE D, E, AND F
- SIGN ERECTION, MILEMARKERS
- RELOCATE SIGN, TYPE D

EXISTING SIGNING

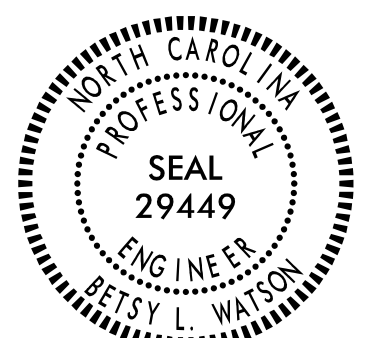
\$\$\$\$\$SYTIME\$\$\$\$\$
 \$\$\$DDGN\$\$\$\$\$
 \$\$\$USERNAM\$\$\$\$\$

TIP NO.	SHEET NO.
W-5600	SIGN-13
APPROVED: <i>Betsy L. Watson</i> 35E67B84F8743F	
DATE: 5/20/2019	
SEAL 	
DOCUMENT NOT CONSIDERED FINAL UNLESS ALL SIGNATURES COMPLETED	
	

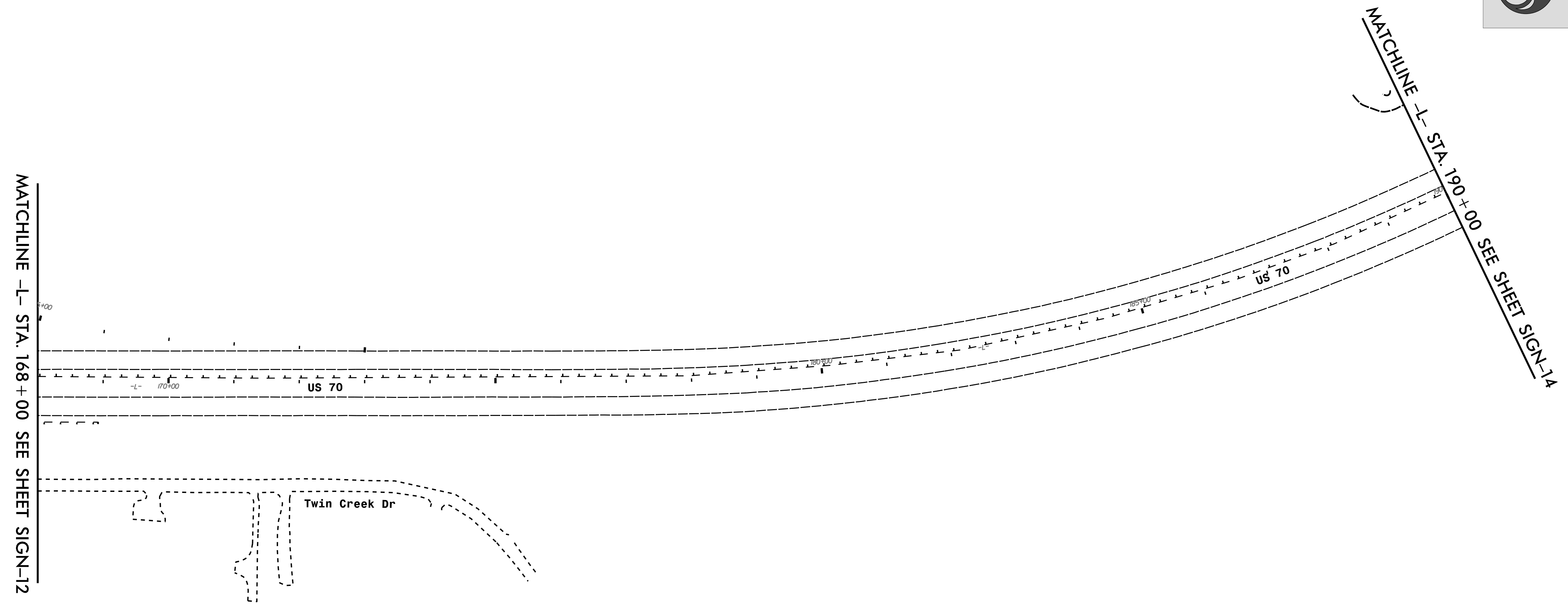
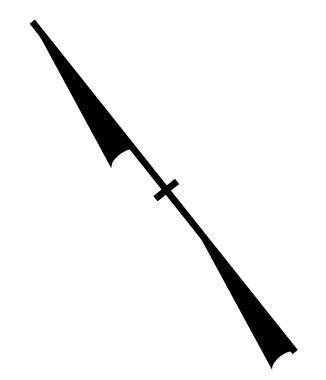



PROJECT NOTES

- 1 DISPOSAL OF SIGN SYSTEM, STEEL BEAM
- 2 DISPOSAL OF SIGN SYSTEM, U-CHANNEL
- 3 DISPOSAL OF SIGN SYSTEM, WOOD
- 4 DISPOSAL OF SUPPORT, U-CHANNEL
- 5 DISPOSAL OF SUPPORT, WOOD
- 6 DISPOSAL OF SIGN, MILEMARKER
- 7 SIGN ERECTION, TYPE A (OVERHEAD)
- 8 SIGN ERECTION, TYPE B (OVERHEAD)
- 9 SIGN ERECTION, TYPE A (GROUND MOUNTED)
- 10 SIGN ERECTION, TYPE B (GROUND MOUNTED)
- 11 SIGN ERECTION, TYPE D, E, AND F
- 12 SIGN ERECTION, MILEMARKERS
- 13 RELOCATE SIGN, TYPE D

EXISTING SIGNING

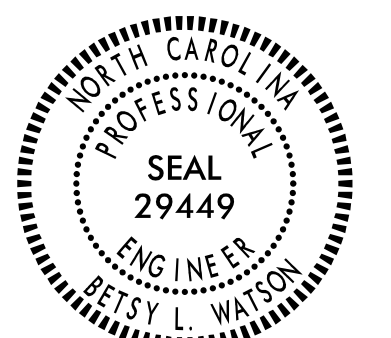
\$\$\$\$\$SYTIME\$\$\$\$\$
\$\$\$\$\$DGN\$\$\$\$\$
\$\$\$\$\$USERNAME\$\$\$\$\$

TIP NO. W-5600	SHEET NO. SIGN-14
APPROVED: <i>Betsy L. Watson</i> <small>35E67B84F8743F...</small>	
DATE: 5/20/2019	
	
DOCUMENT NOT CONSIDERED FINAL UNLESS ALL SIGNATURES COMPLETED	
	

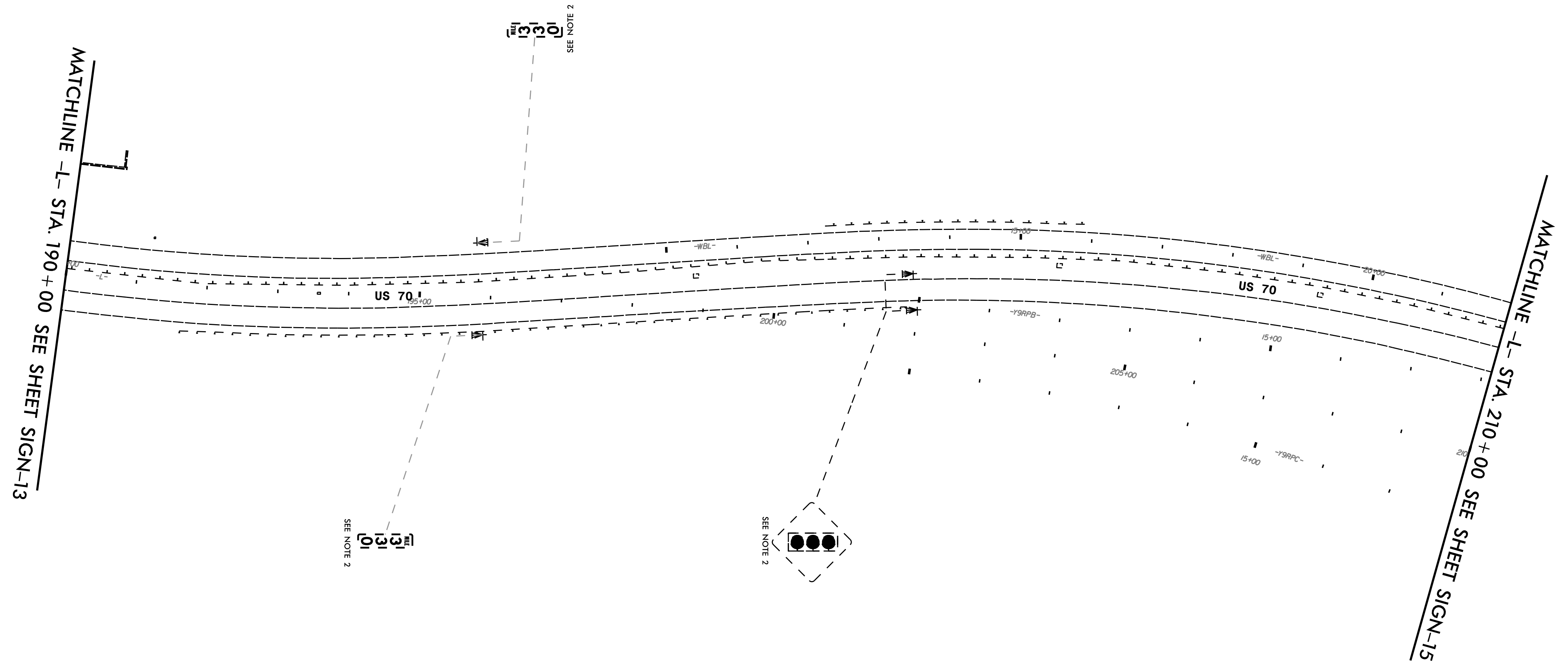



PROJECT NOTES

- 1 DISPOSAL OF SIGN SYSTEM, STEEL BEAM
- 2 DISPOSAL OF SIGN SYSTEM, U-CHANNEL
- 3 DISPOSAL OF SIGN SYSTEM, WOOD
- 4 DISPOSAL OF SUPPORT, U-CHANNEL
- 5 DISPOSAL OF SUPPORT, WOOD
- 6 DISPOSAL OF SIGN, MILEMARKER
- 7 SIGN ERECTION, TYPE A (OVERHEAD)
- 8 SIGN ERECTION, TYPE B (OVERHEAD)
- 9 SIGN ERECTION, TYPE A (GROUND MOUNTED)
- 10 SIGN ERECTION, TYPE B (GROUND MOUNTED)
- 11 SIGN ERECTION, TYPE D, E, AND F
- 12 SIGN ERECTION, MILEMARKERS
- 13 RELOCATE SIGN, TYPE D

EXISTING SIGNING

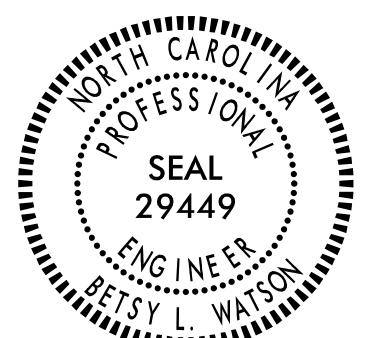
\$\$\$\$\$SYTIME\$\$\$\$\$
 \$\$\$\$\$\$DGN\$\$\$\$\$
 \$\$\$\$\$\$USERNAM\$\$\$\$\$

TIP NO. W-5600	SHEET NO. SIGN - 15
APPROVED: <i>Betsy H. Watson</i> <small>35E67B84F8743F...</small>	
DATE: 5/20/2019	
SEAL 	
DOCUMENT NOT CONSIDERED FINAL UNLESS ALL SIGNATURES COMPLETED	
	

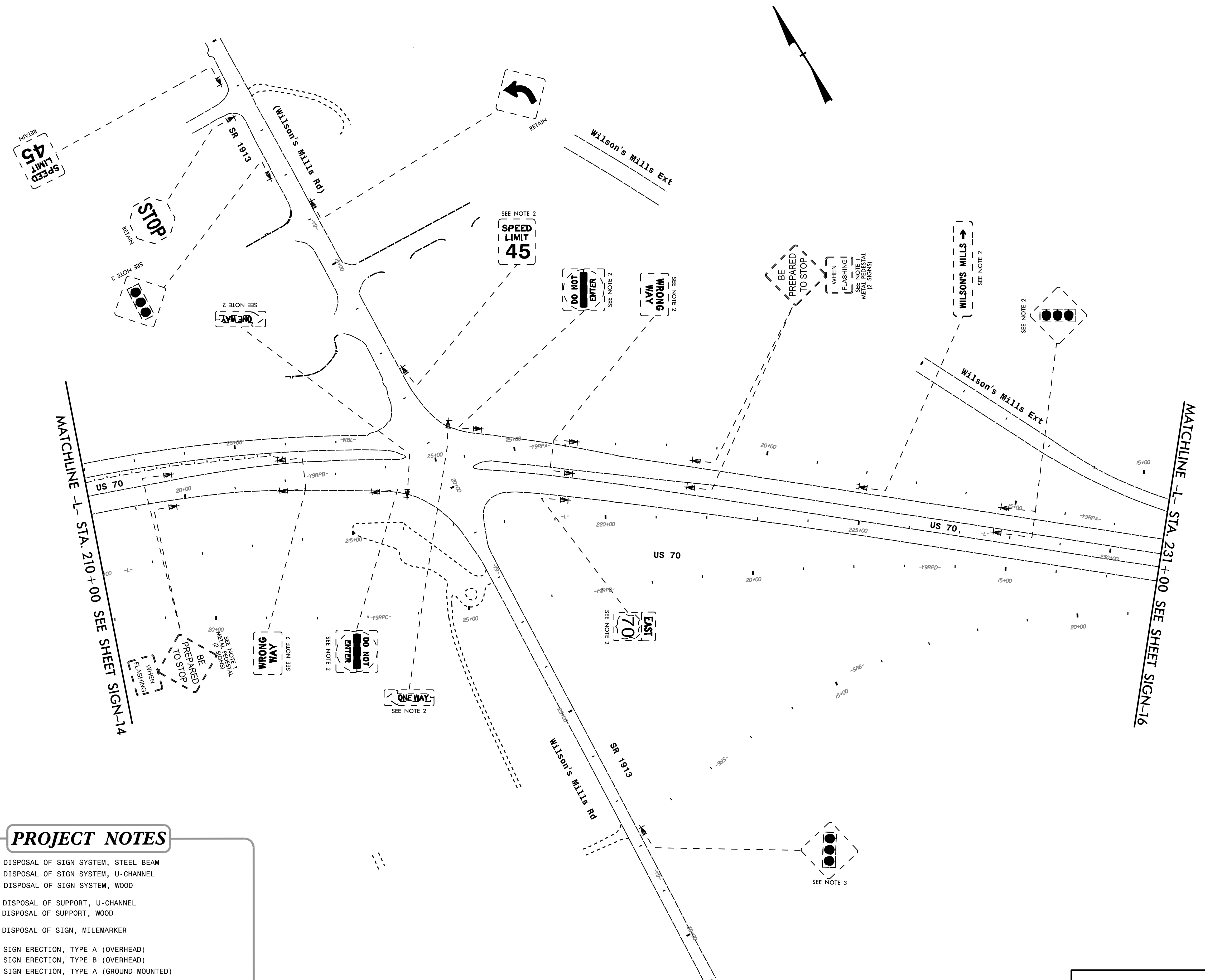



PROJECT NOTES

- DISPOSAL OF SIGN SYSTEM, STEEL BEAM
- DISPOSAL OF SIGN SYSTEM, U-CHANNEL
- DISPOSAL OF SIGN SYSTEM, WOOD
- DISPOSAL OF SUPPORT, U-CHANNEL
- DISPOSAL OF SUPPORT, WOOD
- DISPOSAL OF SIGN, MILEMARKER
- SIGN ERECTION, TYPE A (OVERHEAD)
- SIGN ERECTION, TYPE B (OVERHEAD)
- SIGN ERECTION, TYPE A (GROUND MOUNTED)
- SIGN ERECTION, TYPE B (GROUND MOUNTED)
- SIGN ERECTION, TYPE D, E, AND F
- SIGN ERECTION, MILEMARKERS
- RELOCATE SIGN, TYPE D

\$\$\$\$\$SYTIME\$\$\$\$\$
 \$\$\$DDGN\$\$\$\$\$
 \$\$\$USERNAM\$\$\$\$\$

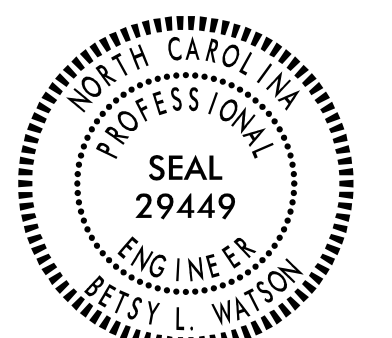
EXISTING SIGNING

TIP NO. W-5600	SHEET NO. SIGN-16
APPROVED: <i>Betsy H. Watson</i> 35E67884F8743F...	
DATE: 5/20/2019	
SEAL 	
DOCUMENT NOT CONSIDERED FINAL UNLESS ALL SIGNATURES COMPLETED	
	

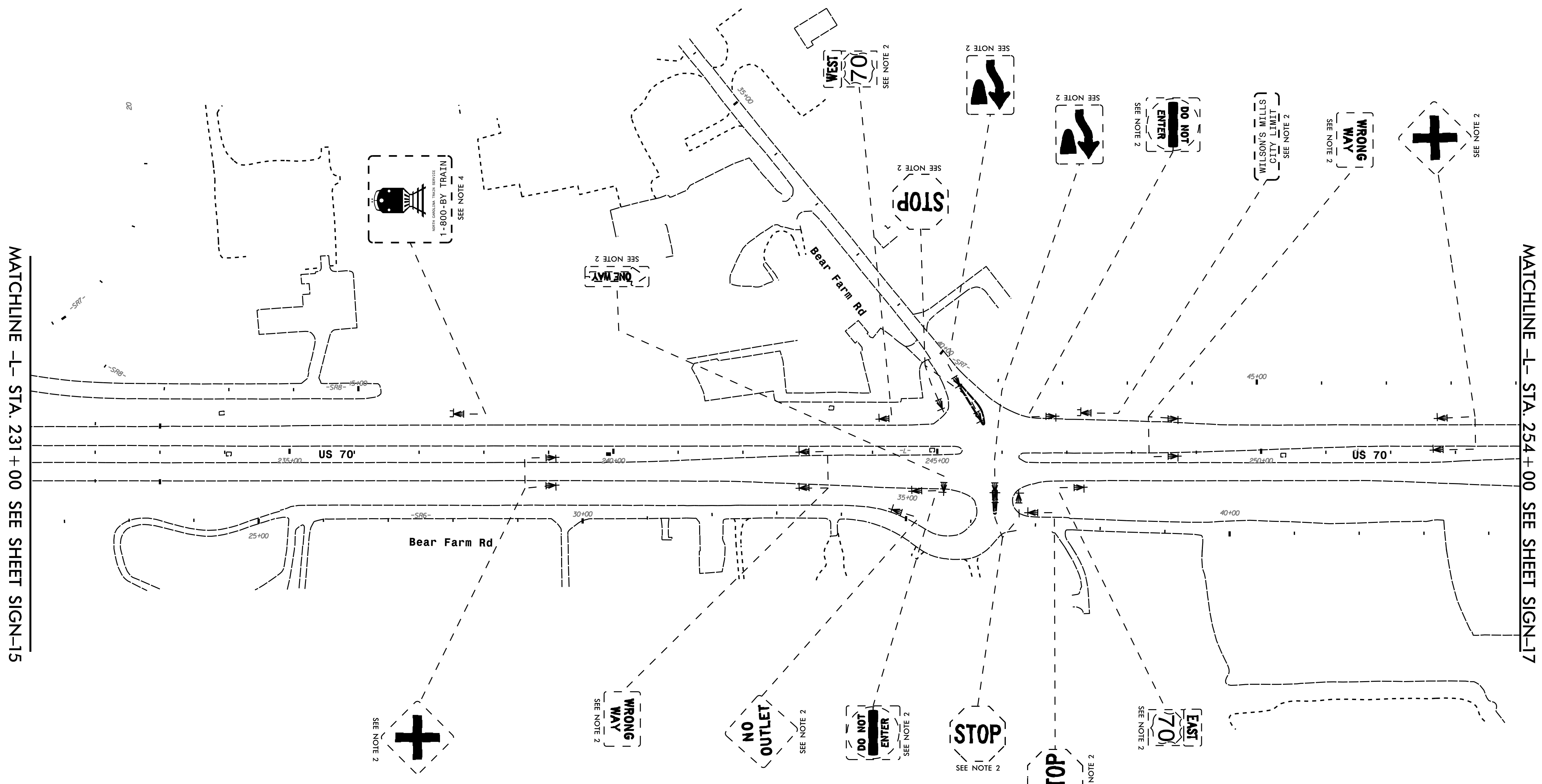

MATCHLINE -L- STA. 231 + 00 SEE SHEET SIGN-15

MATCHLINE -L- STA. 254 + 00 SEE SHEET SIGN-17

PROJECT NOTES

- 1 DISPOSAL OF SIGN SYSTEM, STEEL BEAM
- 2 DISPOSAL OF SIGN SYSTEM, U-CHANNEL
- 3 DISPOSAL OF SIGN SYSTEM, WOOD
- 4 DISPOSAL OF SUPPORT, U-CHANNEL
- 5 DISPOSAL OF SUPPORT, WOOD
- 6 DISPOSAL OF SIGN, MILEMARKER
- 7 SIGN ERECTION, TYPE A (OVERHEAD)
- 8 SIGN ERECTION, TYPE B (OVERHEAD)
- 9 SIGN ERECTION, TYPE A (GROUND MOUNTED)
- 10 SIGN ERECTION, TYPE B (GROUND MOUNTED)
- 11 SIGN ERECTION, TYPE D, E, AND F
- 12 SIGN ERECTION, MILEMARKERS
- 13 RELOCATE SIGN, TYPE D

EXISTING SIGNING

\$\$\$\$\$SYTIME\$\$\$\$\$
\$\$\$\$\$DGN\$\$\$\$\$
\$\$\$\$\$USERNAM\$\$\$\$\$

TIP NO. W-5600	SHEET NO. SIGN-17
APPROVED: <i>Petsy L. Watson</i> 35E67B84F8743F...	
DATE: 5/20/2019	
SEAL 	
DOCUMENT NOT CONSIDERED FINAL UNLESS ALL SIGNATURES COMPLETED	

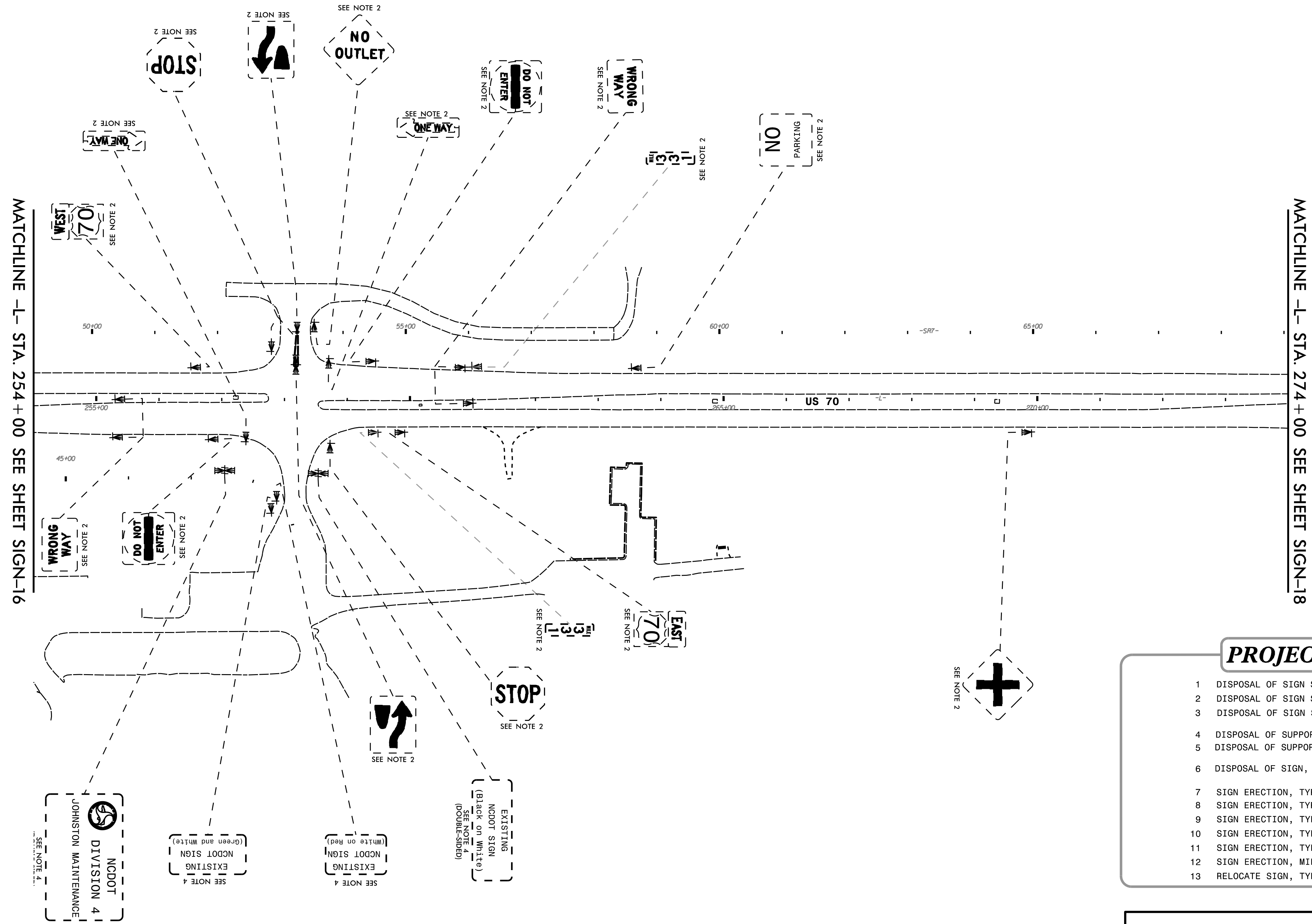
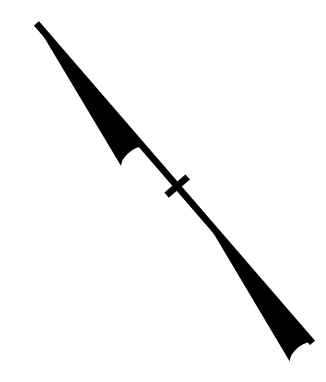

PROJECT NOTES

- 1 DISPOSAL OF SIGN SYSTEM, STEEL BEAM
- 2 DISPOSAL OF SIGN SYSTEM, U-CHANNEL
- 3 DISPOSAL OF SIGN SYSTEM, WOOD
- 4 DISPOSAL OF SUPPORT, U-CHANNEL
- 5 DISPOSAL OF SUPPORT, WOOD
- 6 DISPOSAL OF SIGN, MILEMARKER
- 7 SIGN ERECTION, TYPE A (OVERHEAD)
- 8 SIGN ERECTION, TYPE B (OVERHEAD)
- 9 SIGN ERECTION, TYPE A (GROUND MOUNTED)
- 10 SIGN ERECTION, TYPE B (GROUND MOUNTED)
- 11 SIGN ERECTION, TYPE D, E, AND F
- 12 SIGN ERECTION, MILEMARKERS
- 13 RELOCATE SIGN, TYPE D

EXISTING SIGNING

\$\$\$\$\$SYTIME\$\$\$\$\$
 \$\$\$DDGN\$\$\$\$\$
 \$\$\$USERNAME\$\$\$\$\$