



**This electronic collection of documents is provided  
for the convenience of the user  
and is Not a Certified Document –**

**The documents contained herein were originally issued  
and sealed by the individuals whose names and license  
numbers appear on each page, on the dates appearing  
with their signature on that page.**

**This file or an individual page  
shall not be considered a certified document.**

### PROJECT NOTES

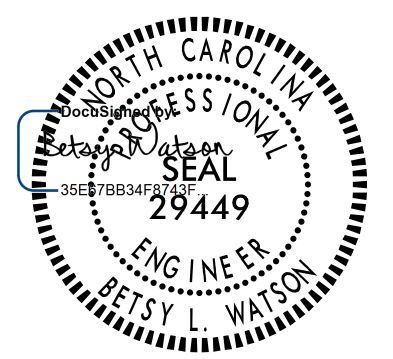
- 1 DISPOSAL OF SIGN SYSTEM, OVERHEAD
- 2 DISPOSAL OF SIGN SYSTEM, STEEL BEAM
- 3 DISPOSAL OF SIGN SYSTEM, U-CHANNEL
- 4 DISPOSAL OF SIGN, A OR B (OVERHEAD)
- 5 DISPOSAL OF SIGN, D, E OR F
- 6 DISPOSAL OF LIGHTING SYSTEM
- 7 DISPOSAL OF WALKWAY
  
- 8 SIGN ERECTION, TYPE A (OVERHEAD)
- 9 SIGN ERECTION, TYPE B (OVERHEAD)
- 10 SIGN ERECTION, TYPE A (GROUND MOUNTED)
- 11 SIGN ERECTION, TYPE D, E, AND F
- 12 SIGN ERECTION, OVERLAY (OVERHEAD)
- 13 DISPOSAL OF OVERLAY (OVERHEAD)
- 14 CUTTING OF SIGN HANGERS (OVERHEAD)

TIP NO.	SHEET NO.
U-5754	SIGN - 10
APPROVED: _____	
DATE: _____	
SEAL	
	
1/16/2019	
DOCUMENT NOT CONSIDERED FINAL UNLESS ALL SIGNATURES COMPLETED	
	

MATCHLINE SEE SHEET SIGN-9



I-40 WBL/BUS I-85 SBL

SEE NOTE 12  
Overlay Panel #702  
165" x 24"

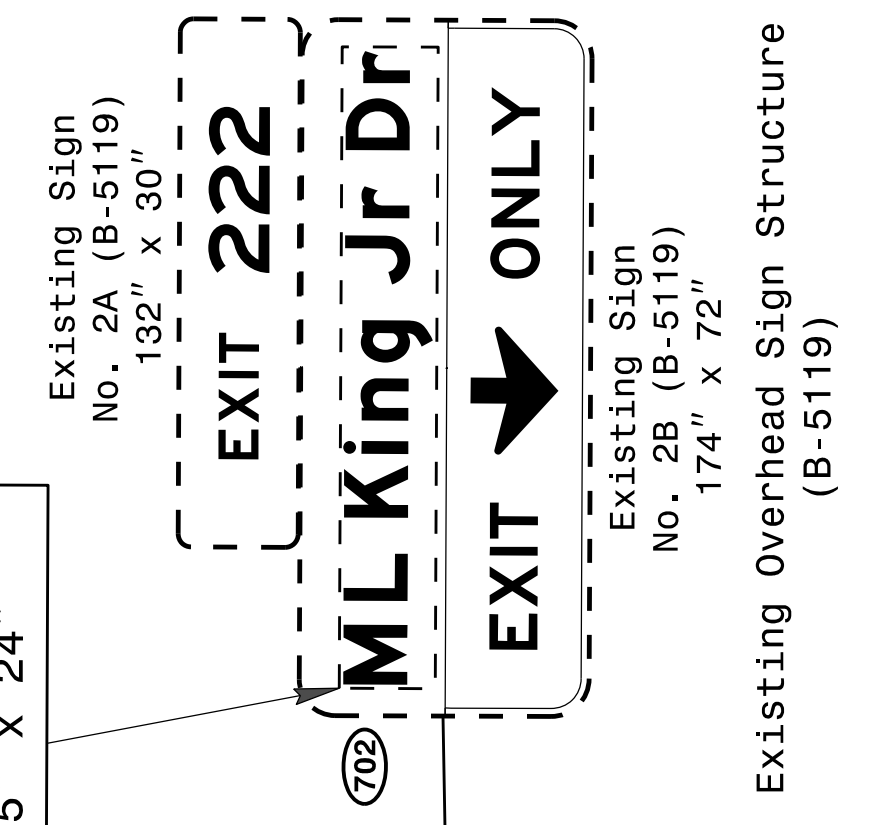

Existing Sign No. 2B (B-5119)  
174" x 72"  
Existing Overhead Sign Structure (B-5119)

MATCHLINE SEE SHEET SIGN-11

I-40 EBL/BUS I-85 NBL

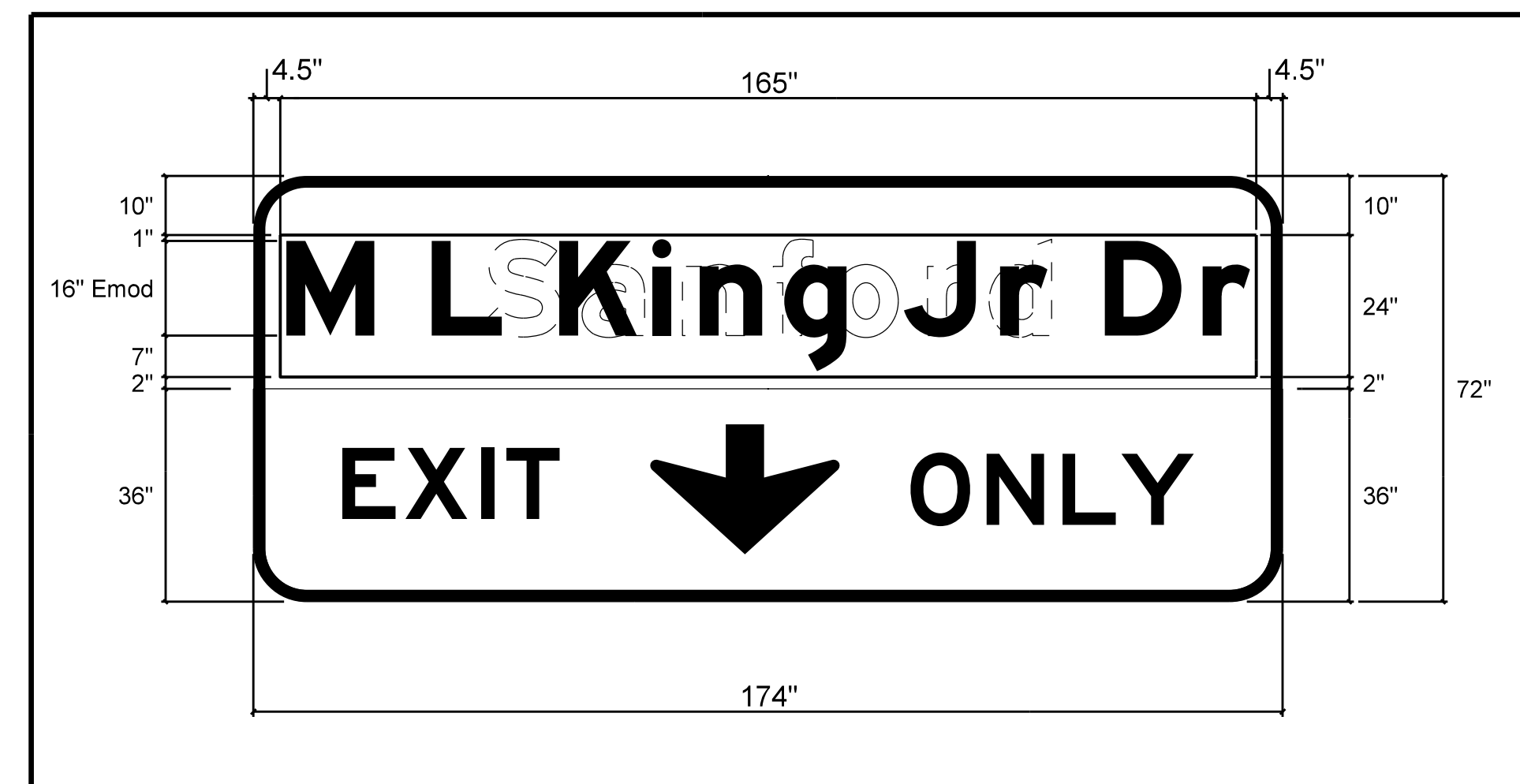

Overlay Placement Detail  
Overlay Panel #702  
(165" x 24")



\$\$\$\$\$SYTIME\$\$\$\$\$  
\$\$\$\$\$DGN\$\$\$\$\$  
\$\$\$\$\$USERNAM\$\$\$\$\$

EXISTING/PROPOSED SIGNING



**PROJECT NOTES**

- 1 DISPOSAL OF SIGN SYSTEM, OVERHEAD
- 2 DISPOSAL OF SIGN SYSTEM, STEEL BEAM
- 3 DISPOSAL OF SIGN SYSTEM, U-CHANNEL
- 4 DISPOSAL OF SIGN, A OR B (OVERHEAD)
- 5 DISPOSAL OF SIGN, D, E OR F
- 6 DISPOSAL OF LIGHTING SYSTEM
- 7 DISPOSAL OF WALKWAY
  
- 8 SIGN ERECTION, TYPE A (OVERHEAD)
- 9 SIGN ERECTION, TYPE B (OVERHEAD)
- 10 SIGN ERECTION, TYPE A (GROUND MOUNTED)
- 11 SIGN ERECTION, TYPE D, E, AND F
- 12 SIGN ERECTION, OVERLAY (OVERHEAD)
- 13 DISPOSAL OF OVERLAY (OVERHEAD)
- 14 CUTTING OF SIGN HANGERS (OVERHEAD)

TIP NO. U-5754	SHEET NO. SIGN-11
APPROVED: _____	
DATE: _____	
SEAL	
	
1/16/2019	
DOCUMENT NOT CONSIDERED FINAL UNLESS ALL SIGNATURES COMPLETED	
	

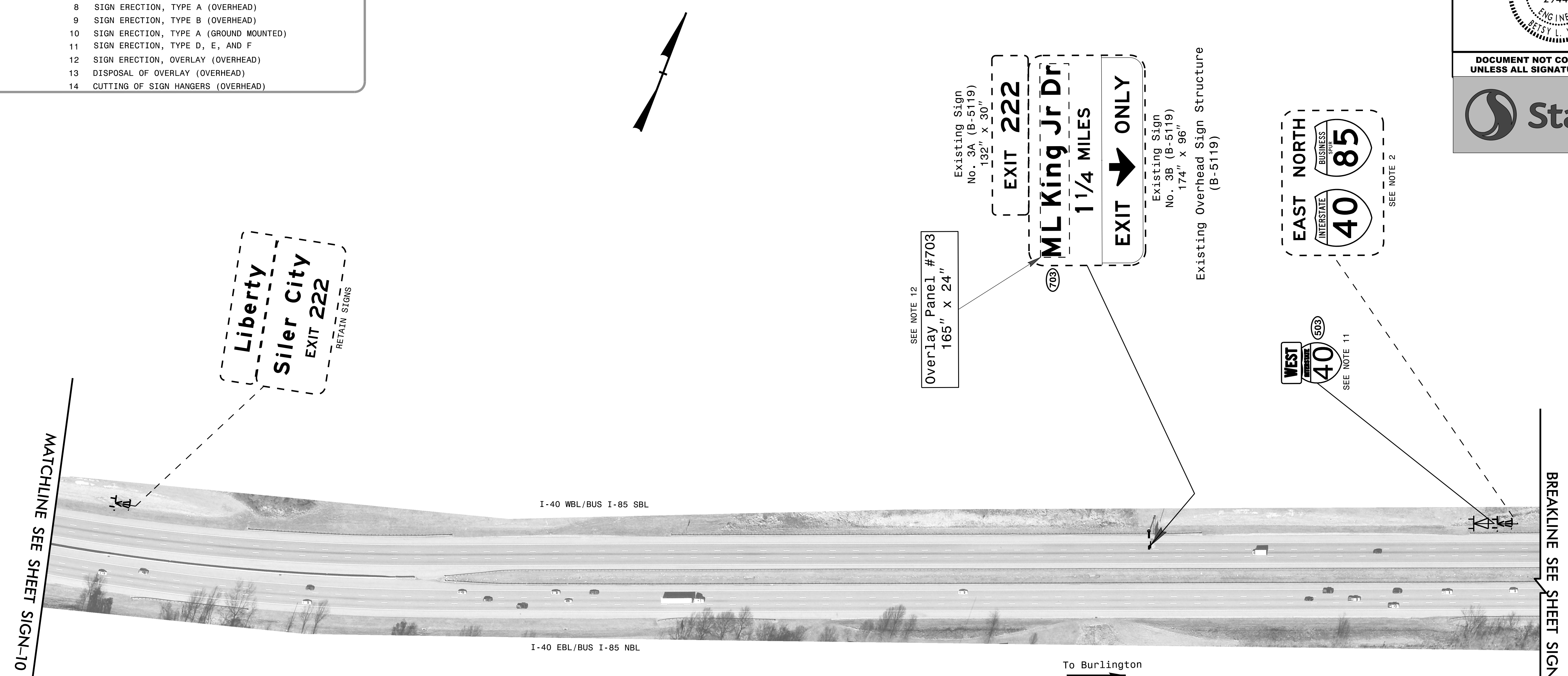

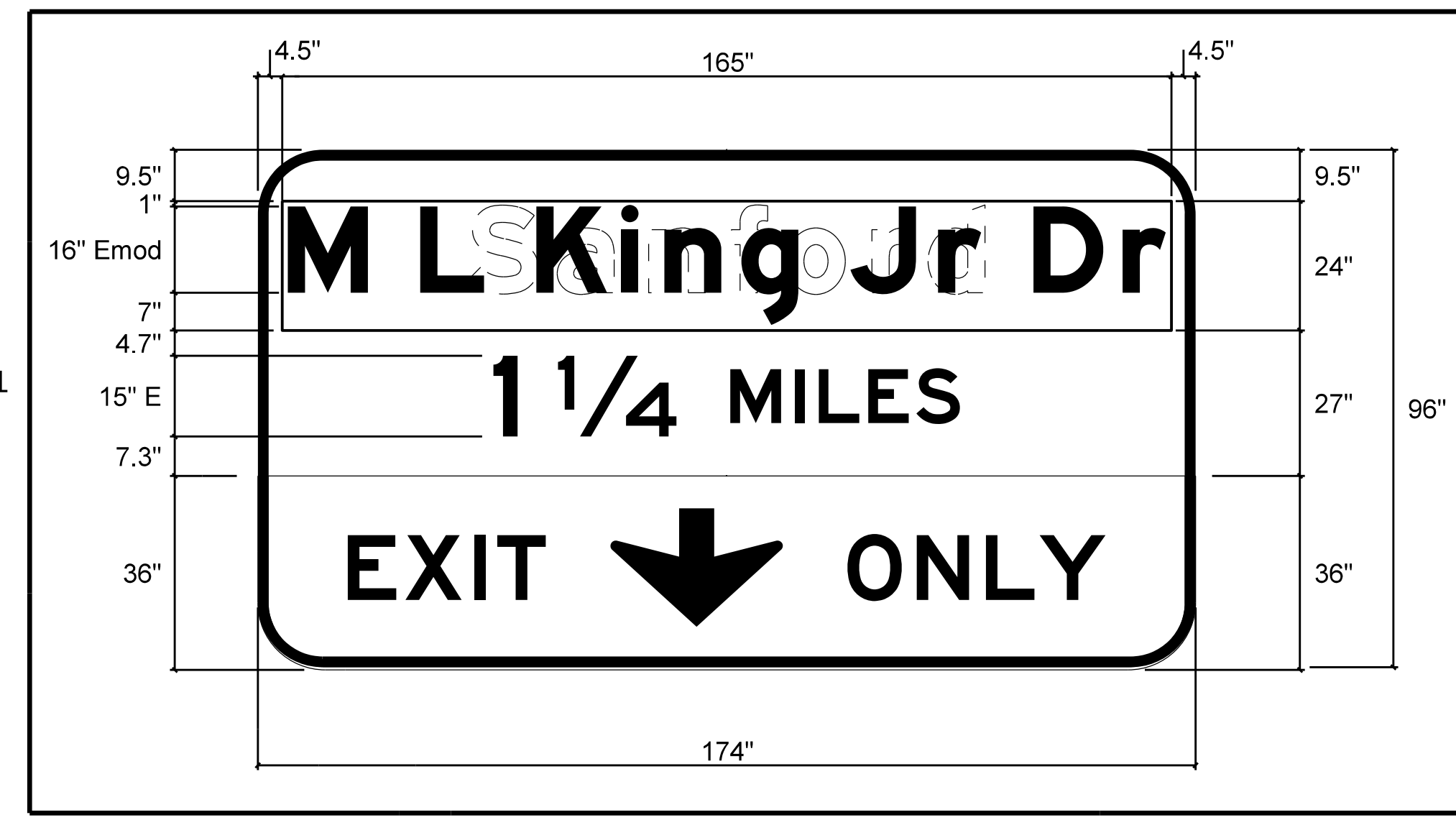

Overlay Placement Detail  
Overlay Panel #703  
(165" x 24")



EXISTING/PROPOSED SIGNING

\$\$\$\$\$SYTIME\$\$\$\$\$  
\$\$\$\$\$DGN\$\$\$\$\$  
\$\$\$\$\$USERNAM\$\$\$\$\$

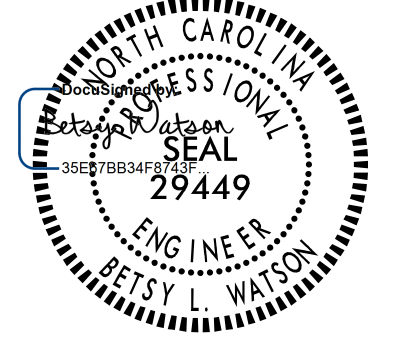

TIP NO. U-5754	SHEET NO. SIGN - 12
APPROVED: _____	
DATE: _____	
SEAL	
	
1/16/2019	
DOCUMENT NOT CONSIDERED FINAL UNLESS ALL SIGNATURES COMPLETED	
	

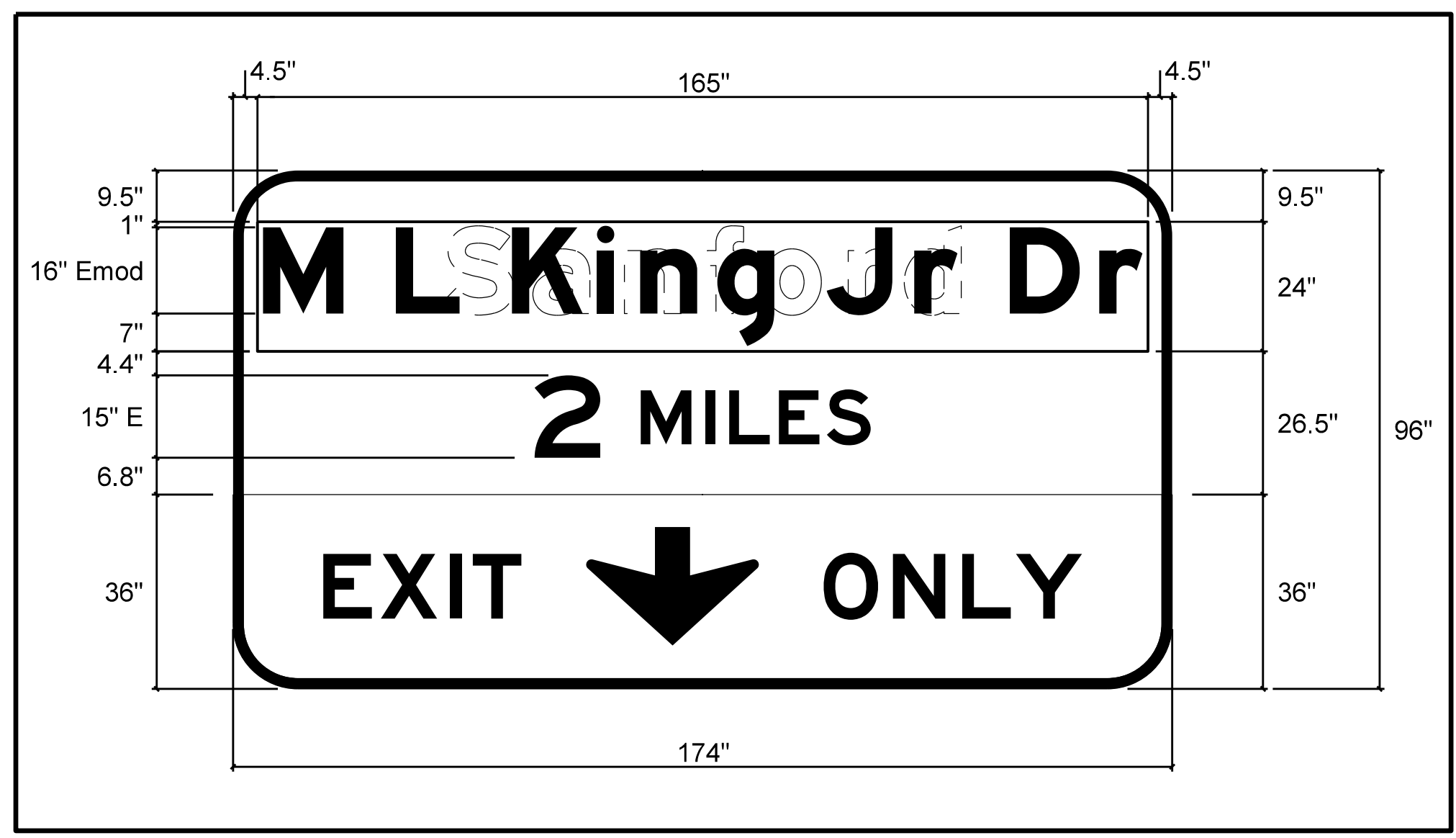

Overlay Placement Detail  
Overlay Panel #704  
(165" x 24")

BREAKLINE SEE SHEET SIGN-11

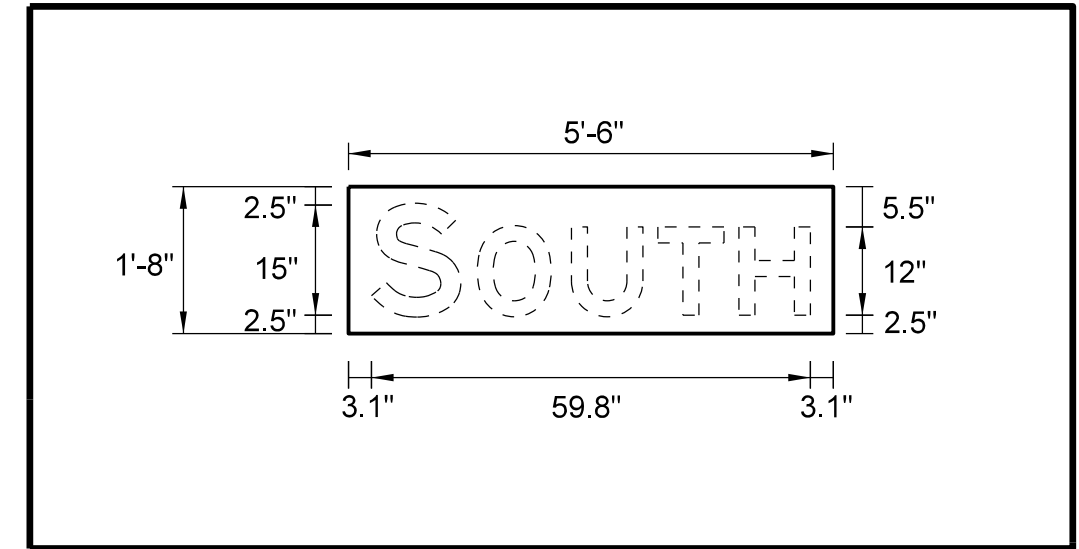
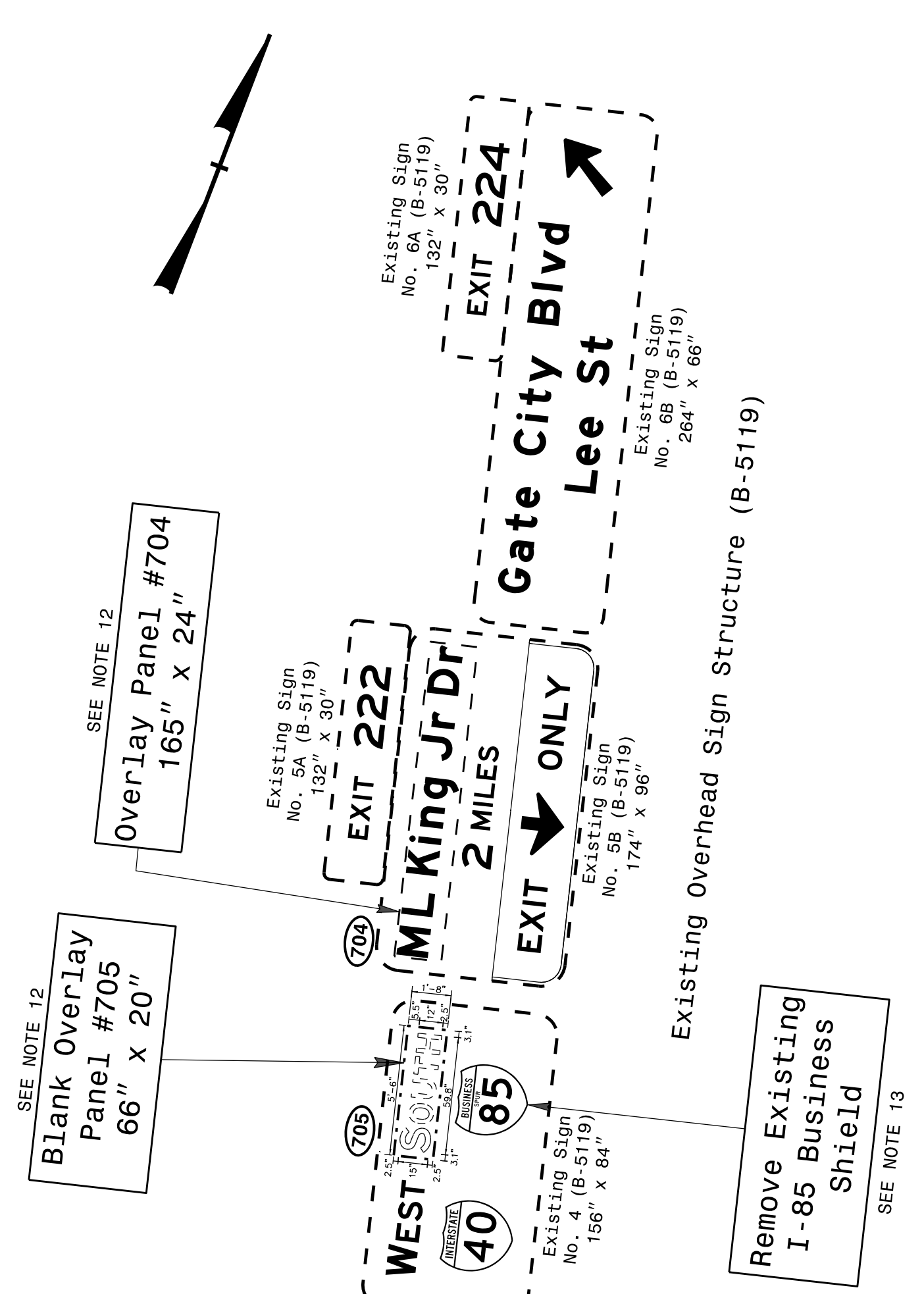
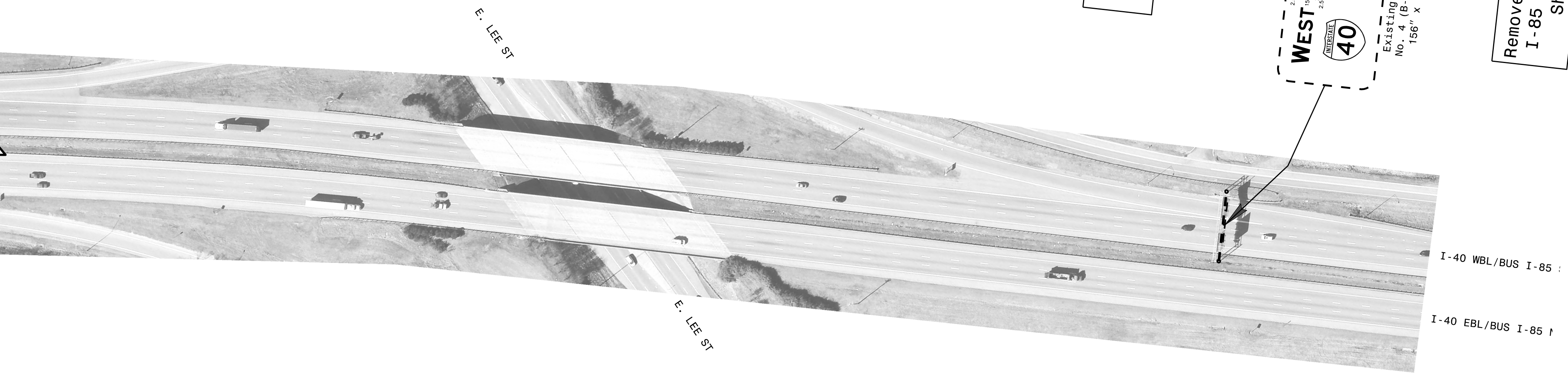

Overlay Placement Detail  
Overlay Panel #705  
(66" x 20")

**PROJECT NOTES**

- 1 DISPOSAL OF SIGN SYSTEM, OVERHEAD
- 2 DISPOSAL OF SIGN SYSTEM, STEEL BEAM
- 3 DISPOSAL OF SIGN SYSTEM, U-CHANNEL
- 4 DISPOSAL OF SIGN, A OR B (OVERHEAD)
- 5 DISPOSAL OF SIGN, D, E OR F
- 6 DISPOSAL OF LIGHTING SYSTEM
- 7 DISPOSAL OF WALKWAY
- 8 SIGN ERECTION, TYPE A (OVERHEAD)
- 9 SIGN ERECTION, TYPE B (OVERHEAD)
- 10 SIGN ERECTION, TYPE A (GROUND MOUNTED)
- 11 SIGN ERECTION, TYPE D, E, AND F
- 12 SIGN ERECTION, OVERLAY (OVERHEAD)
- 13 DISPOSAL OF OVERLAY (OVERHEAD)
- 14 CUTTING OF SIGN HANGERS (OVERHEAD)

EXISTING AND PROPOSED SIGNING  
EXISTING OVERHEAD SIGN STRUCTURE #5

\$\$\$\$\$SYTIME\$\$\$\$\$  
\$\$\$\$\$USER\$\$\$\$\$  
\$\$\$\$\$USER\$\$\$\$\$



TIP NO. U-5754	SHEET NO. SIGN-13
APPROVED: _____	
DATE: _____	
SEAL	
1/16/2019	
DOCUMENT NOT CONSIDERED FINAL UNLESS ALL SIGNATURES COMPLETED	

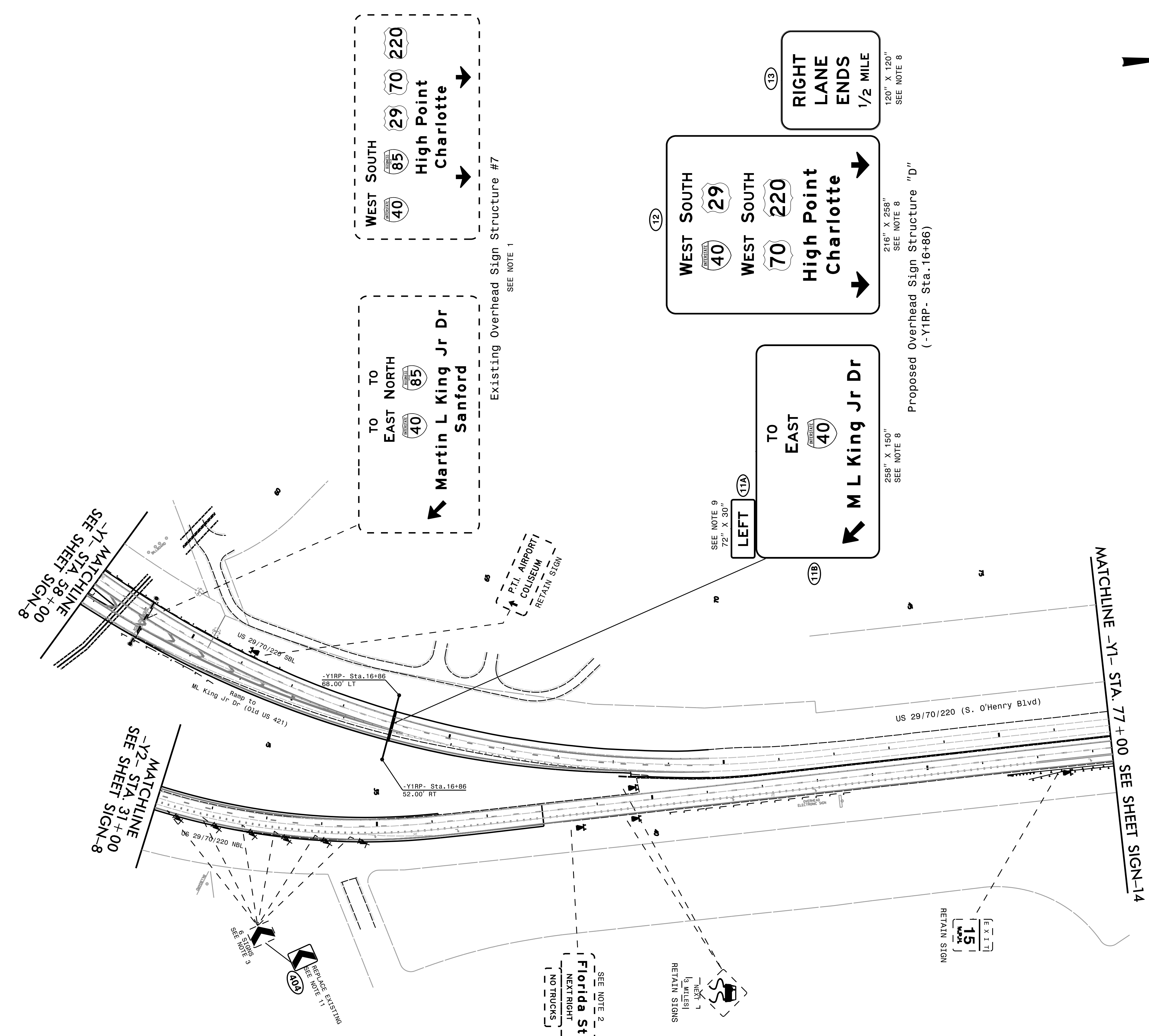

**PROJECT NOTES**

- 1 DISPOSAL OF SIGN SYSTEM, OVERHEAD
- 2 DISPOSAL OF SIGN SYSTEM, STEEL BEAM
- 3 DISPOSAL OF SIGN SYSTEM, U-CHANNEL
- 4 DISPOSAL OF SIGN, A OR B (OVERHEAD)
- 5 DISPOSAL OF SIGN, D, E OR F
- 6 DISPOSAL OF LIGHTING SYSTEM
- 7 DISPOSAL OF WALKWAY
- 8 SIGN ERECTION, TYPE A (OVERHEAD)
- 9 SIGN ERECTION, TYPE B (OVERHEAD)
- 10 SIGN ERECTION, TYPE A (GROUND MOUNTED)
- 11 SIGN ERECTION, TYPE D, E, AND F
- 12 SIGN ERECTION, OVERLAY (OVERHEAD)
- 13 DISPOSAL OF OVERLAY (OVERHEAD)
- 14 CUTTING OF SIGN HANGERS (OVERHEAD)

EXISTING AND PROPOSED SIGNING  
 PROPOSED OVERHEAD SIGN STRUCTURE "D"  
 EXISTING OVERHEAD SIGN STRUCTURE #7

\$\$\$\$\$SYTIME\$\$\$\$\$  
 \$\$\$DDGN\$\$\$\$\$  
 \$\$\$USERNAME\$\$\$\$\$



TIP NO.	SHEET NO.
U-5754	SIGN-14

APPROVED: \_\_\_\_\_  
DATE: \_\_\_\_\_

SEAL

1/16/2019

**DOCUMENT NOT CONSIDERED FINAL  
UNLESS ALL SIGNATURES COMPLETED**

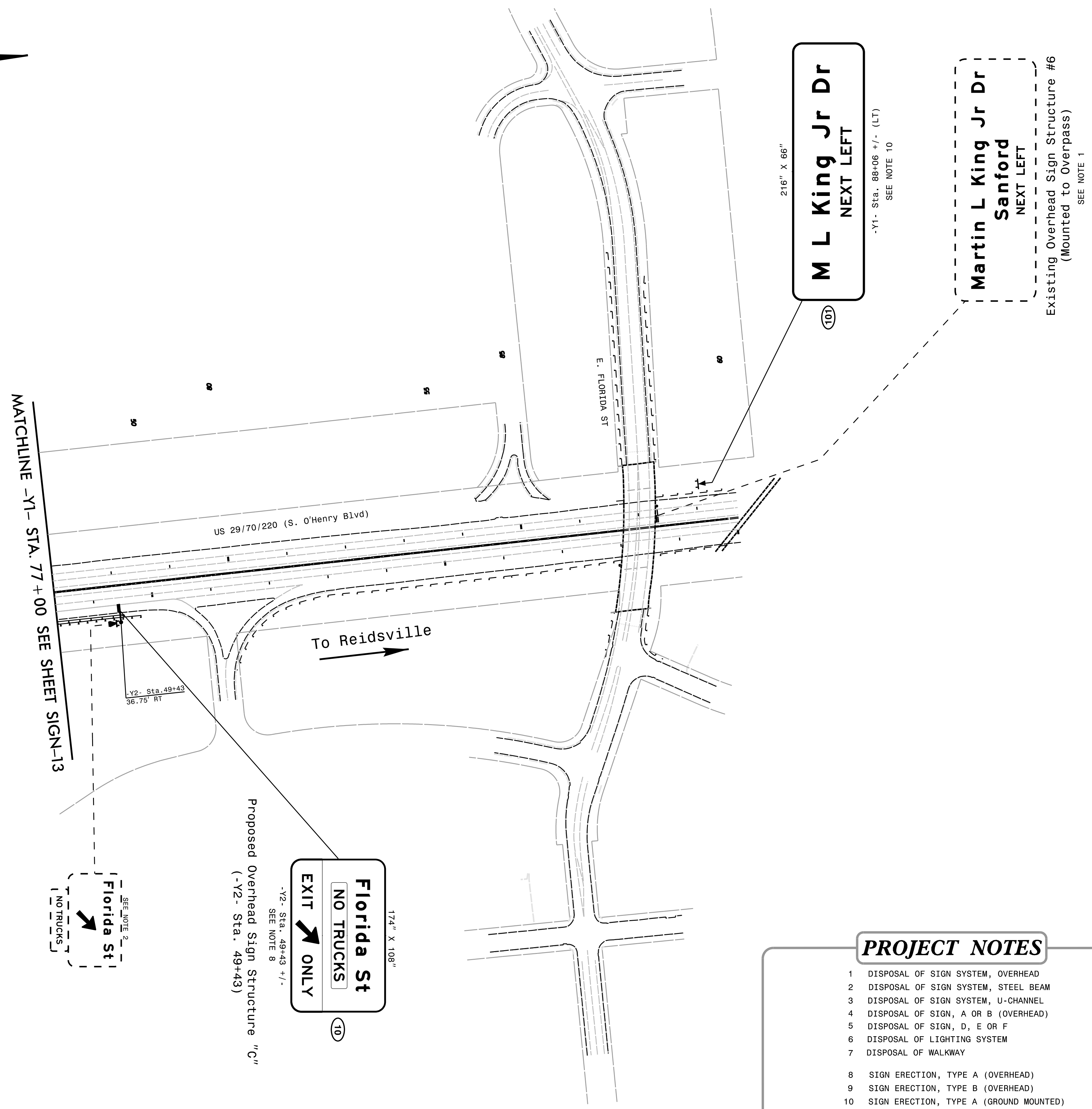
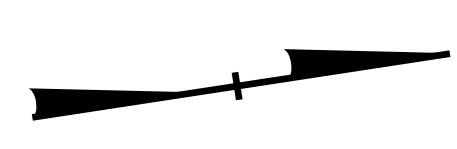

- PROJECT NOTES**
- DISPOSAL OF SIGN SYSTEM, OVERHEAD
  - DISPOSAL OF SIGN SYSTEM, STEEL BEAM
  - DISPOSAL OF SIGN SYSTEM, U-CHANNEL
  - DISPOSAL OF SIGN, A OR B (OVERHEAD)
  - DISPOSAL OF SIGN, D, E OR F
  - DISPOSAL OF LIGHTING SYSTEM
  - DISPOSAL OF WALKWAY
  - SIGN ERECTION, TYPE A (OVERHEAD)
  - SIGN ERECTION, TYPE B (OVERHEAD)
  - SIGN ERECTION, TYPE A (GROUND MOUNTED)
  - SIGN ERECTION, TYPE D, E, AND F
  - SIGN ERECTION, OVERLAY (OVERHEAD)
  - DISPOSAL OF OVERLAY (OVERHEAD)
  - CUTTING OF SIGN HANGERS (OVERHEAD)

**EXISTING AND PROPOSED SIGNING  
PROPOSED OVERHEAD SIGN STRUCTURE "C"  
EXISTING OVERHEAD SIGN STRUCTURE #6**

\$\$\$\$\$SYTIME\$\$\$\$\$  
\$\$\$\$\$DDGN\$\$\$\$\$  
\$\$\$\$\$USERNAME\$\$\$\$\$