

PLAN

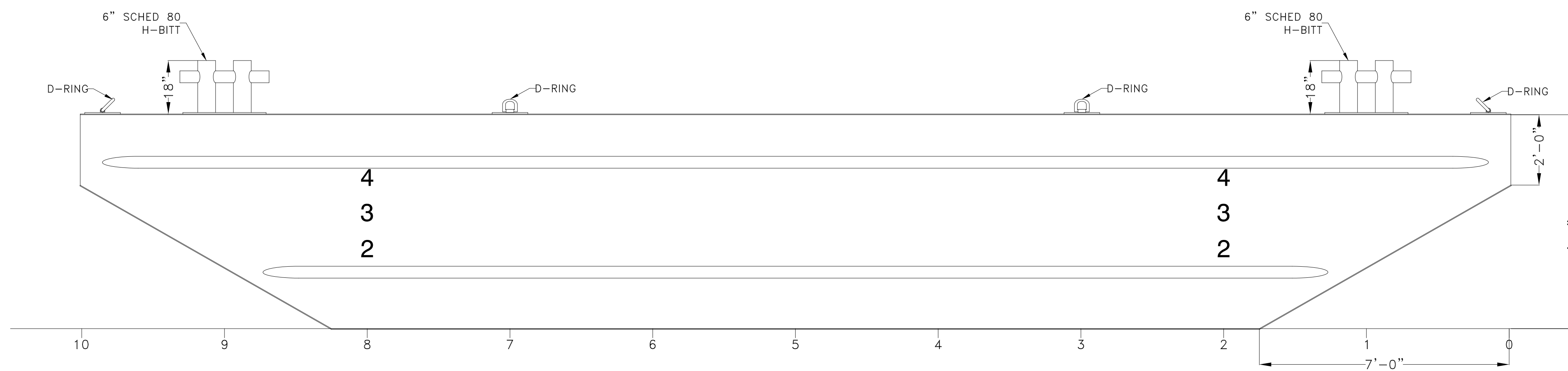

PROFILE

DECK BARGE PARTICULARS

LOA: 40'-0"
 BEAM: 18'-0"
 DEPTH: 6'-0"

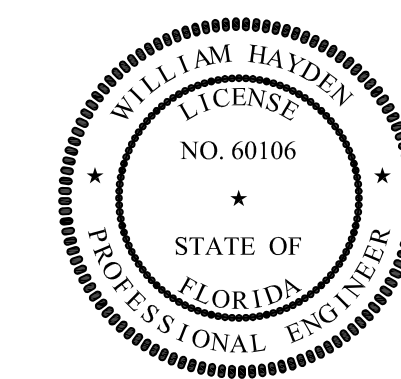

PROFESSIONAL ENGINEER

This document discloses neither in which DeJong & Lebet, Incorporated has proprietary rights, neither confers any possession thereof, neither on transfer nor right to reproduce, disclose or use in any manner this document in whole or in part or any information contained herein, except by written permission, or written agreement with DeJong & Lebet, Incorporated.

In the event of a purchase of this document the purchaser is authorized to contract for more than one device to accord herewith, unless otherwise agreed to in writing by DeJong & Lebet, Incorporated.

© 2018 by DeJong & Lebet, Inc.

DeJong & Lebet, Inc.
 Naval Architects
 Marine Engineers
 Consultants
 Surveyors

1724 Emerson Street
 Jacksonville, Florida 32207
 www.dejongandlebet.com

Phone: (904) 399-3473
 Fax: (904) 399-1522
 info@dejongandlebet.com

Title: 40'x18'x6.0' NCDOT DECK BARGE

PROFILE & ARRANGEMENTS

Dwg. No. 1393C-100 Alt. No. 0
 Sh. 1 of 1

Drawn By: JACOB CONNALLY Date: JANUARY 2, 2019
 Checked By: _____ Date: _____
 App'd By: _____ Scale: 1/2" = 1'-0"
 ABS App'l: _____ USCG App'l: _____

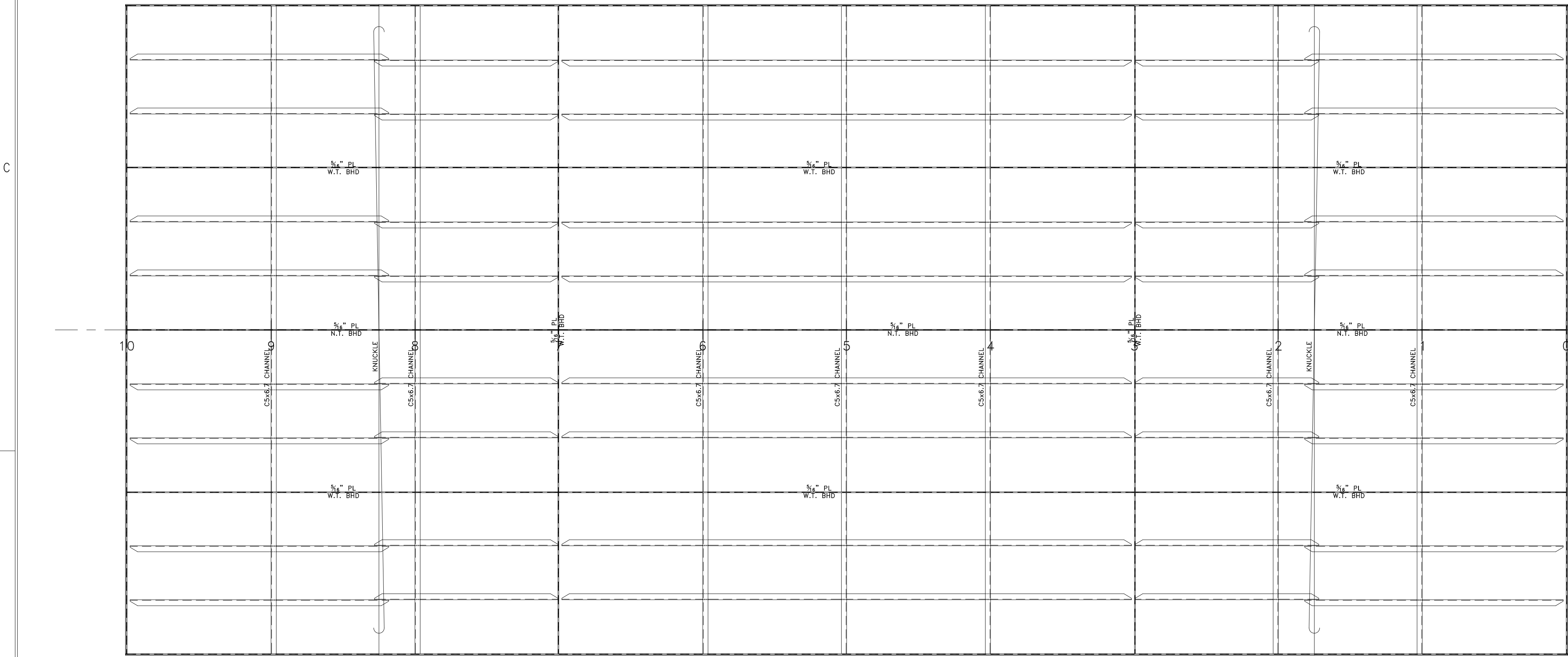

5/16" PL BOTTOMSHELL
W/ 3x2x1/4" L STIFFENERS ON 18" CNTRS
UNLESS OTHERWISE NOTED

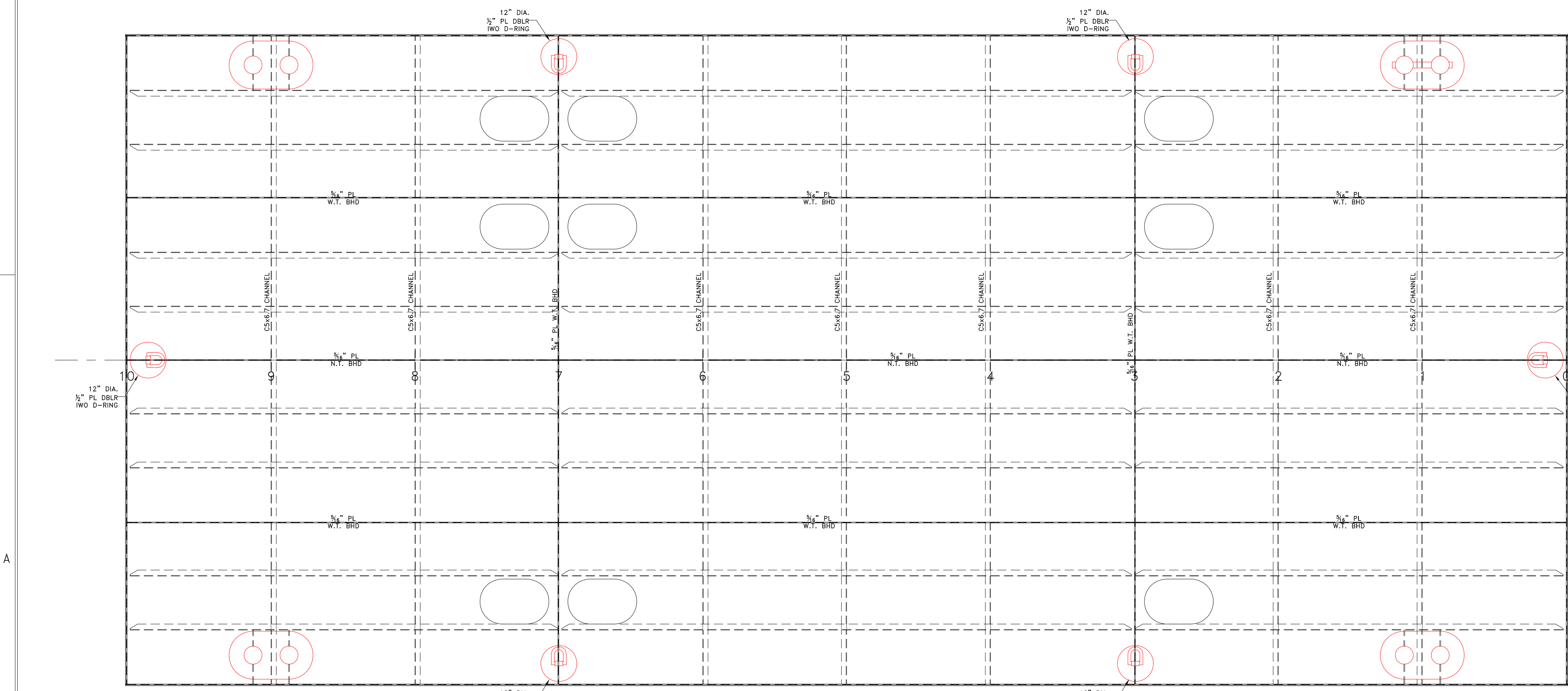

5/16" PL MAIN DECK
W/ 3x2x1/4" L STIFFENERS ON 18" CNTRS
UNLESS OTHERWISE NOTED

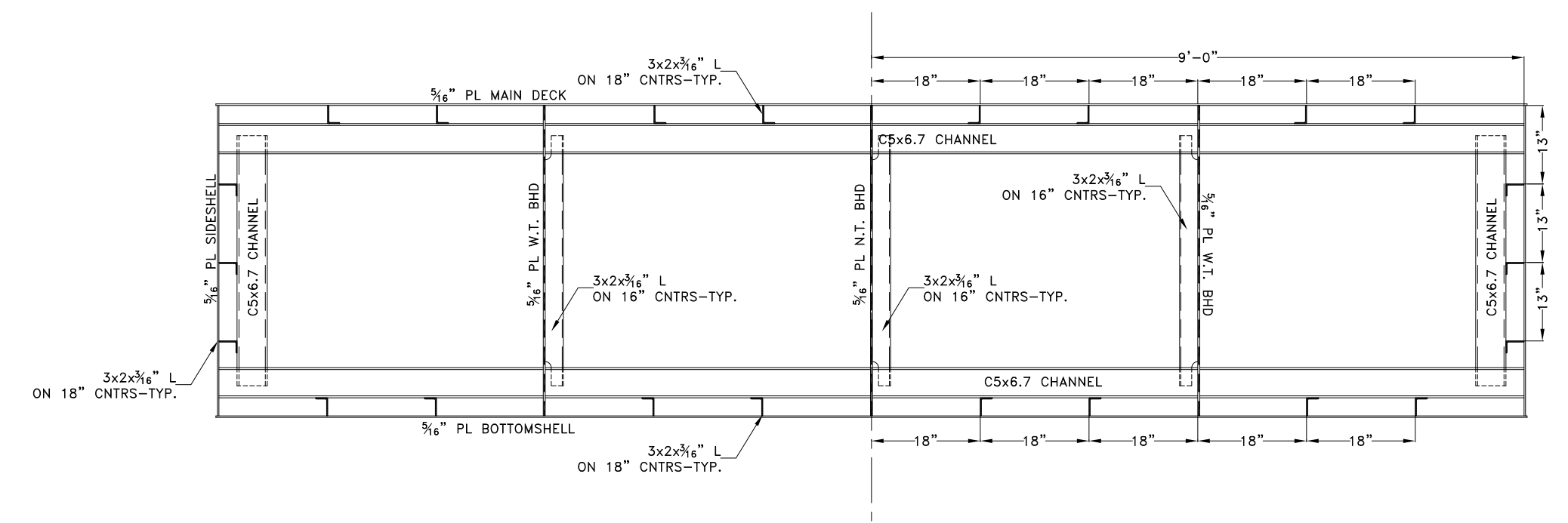

XVERSE STRUCTURAL DETAILS @ FR 1
SHOWN LKG FWD
DETAILS @ FR 9 SIM. OPP. HAND

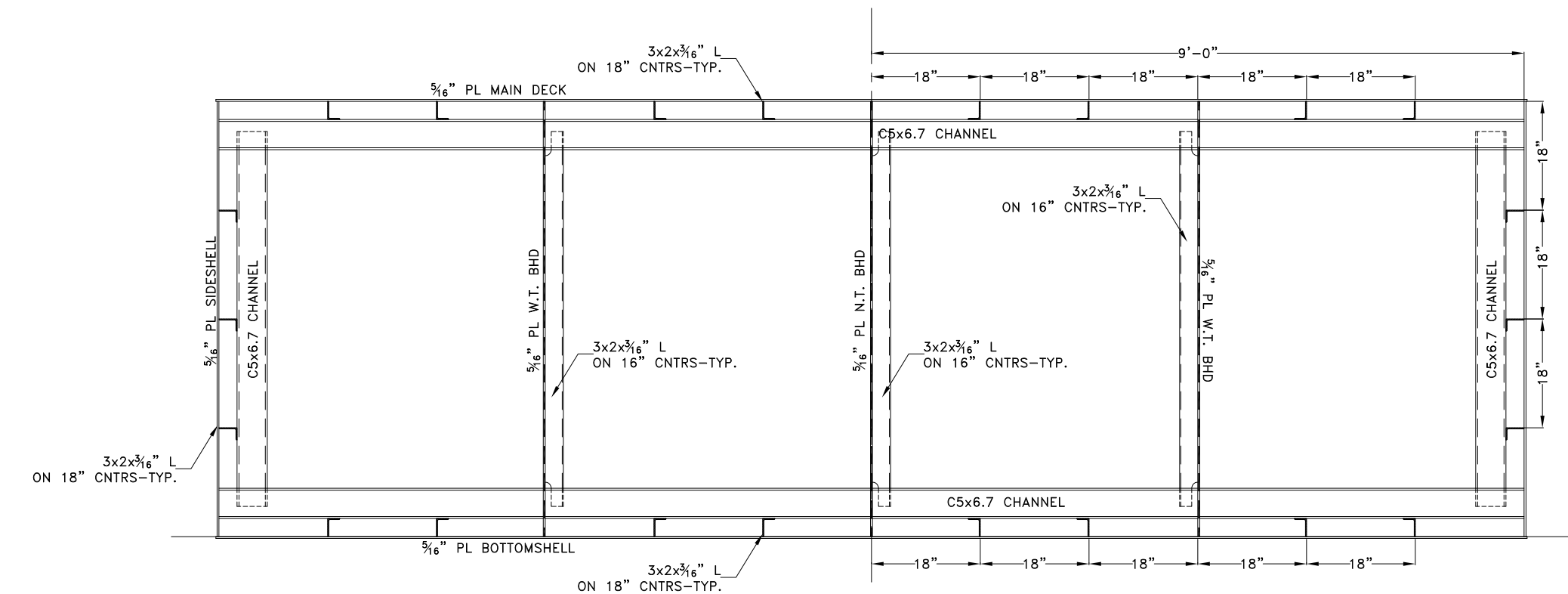

XVERSE STRUCTURAL DETAILS @ FR 5
SHOWN LKG FWD
DETAILS @ FR 2, 4, 6 & 8 SIMILAR
6 & 8 OPP. HAND

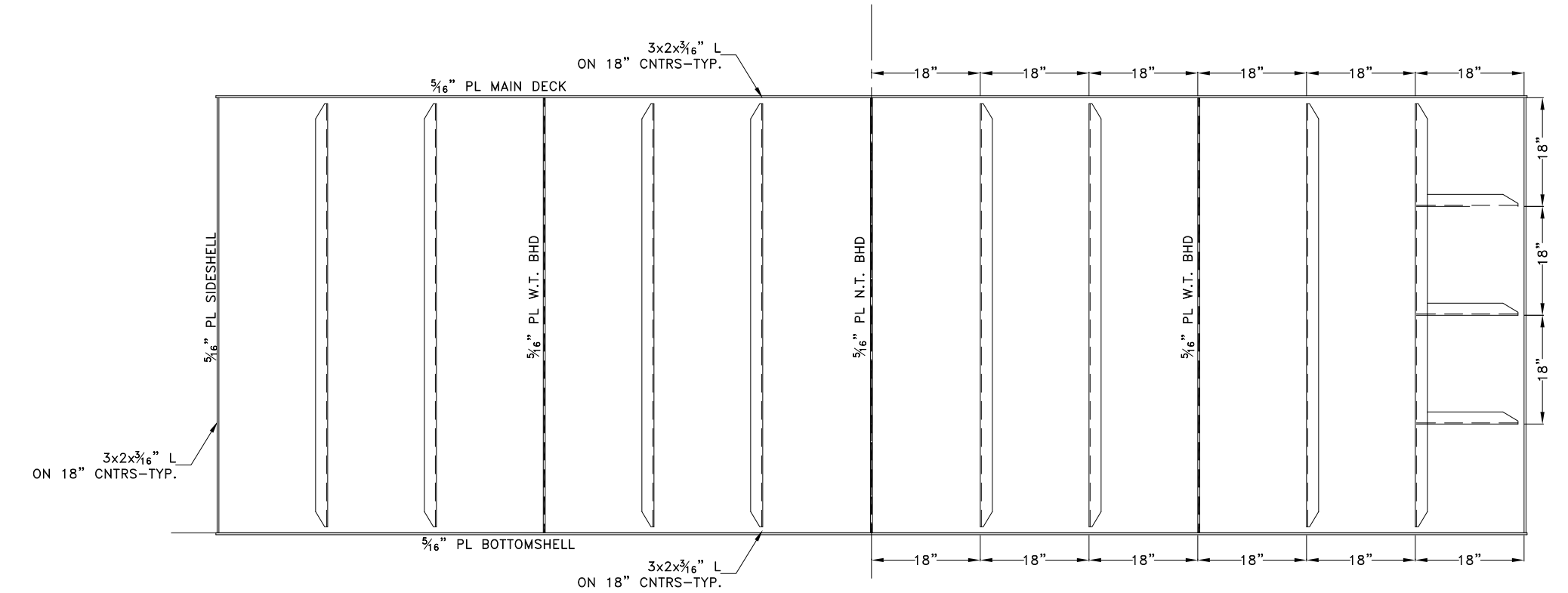

1/4" PL W.T. BHD @ FR 3
W/ 3x2x1/4" L STIFFENERS ON 18" CNTRS
SHOWN LKG FWD
DETAILS @ FR 7 SIMILAR OPP. HAND

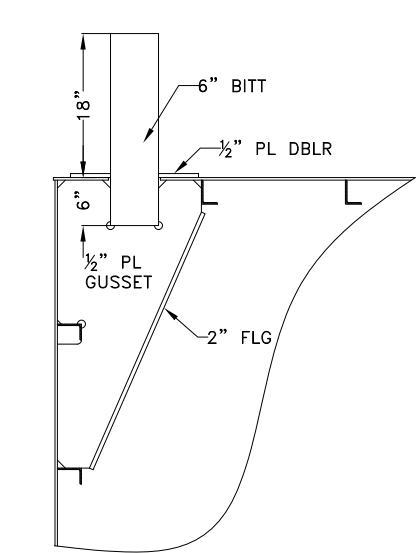

TYPICAL XVERSE SECTION IWO PIPE BITS



PROPERTY RIGHTS
This document contains neither the design nor the construction details of the project. It is the property of DeJong & Lebel, Inc. and is not to be reproduced, stored in a retrieval system, or transmitted in any form or by any means, electronic, mechanical, photocopying, recording, or by any information storage and retrieval system, without the prior written permission of DeJong & Lebel, Inc.

© 2018 by DeJong & Lebel, Inc.

DeJong & Lebel, Inc.
Naval Architects
Marine Engineers
Consultants
Surveyors

1734 Emerson Street
Jacksonville, Florida 32207
www.dejongandlebel.com

Phone: (904) 399-3473
Fax: (904) 399-1522
info@dejongandlebel.com

Title: 40'x18'x6.0' NCDOT DECK BARGE

STRUCTURAL DETAILS

Dwg. No. **1393C-110** Alt. No. **0**
Sh. 1 of 2

Drawn By: **JACOB CONNALLY** Date: **JANUARY 2, 2019**
Checked By: _____ Date: _____
App'd By: _____ Scale: **1/2" = 1'-0"**
ABS App'l: _____ USCG App'l: _____

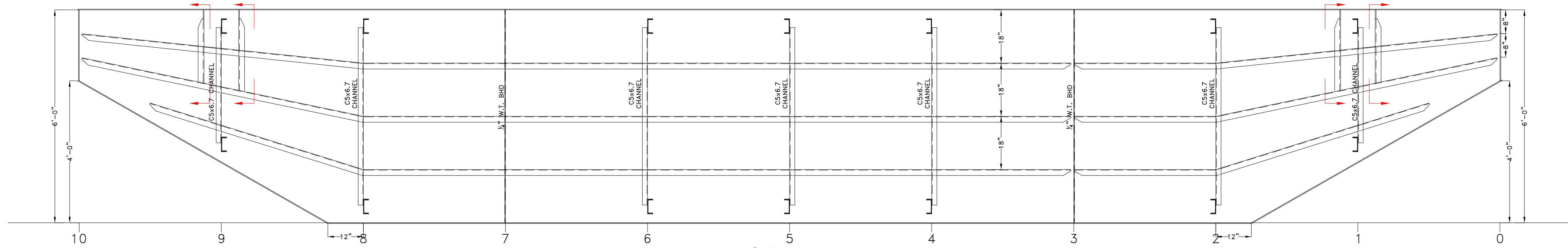

5/16" PL SIDESHELL
W/ 3x2x3/16" L STIFFENERS ON 18" CNTRS
PORT SIDE SHOWN LKG PORT
STBD SIMILAR OPP. HAND

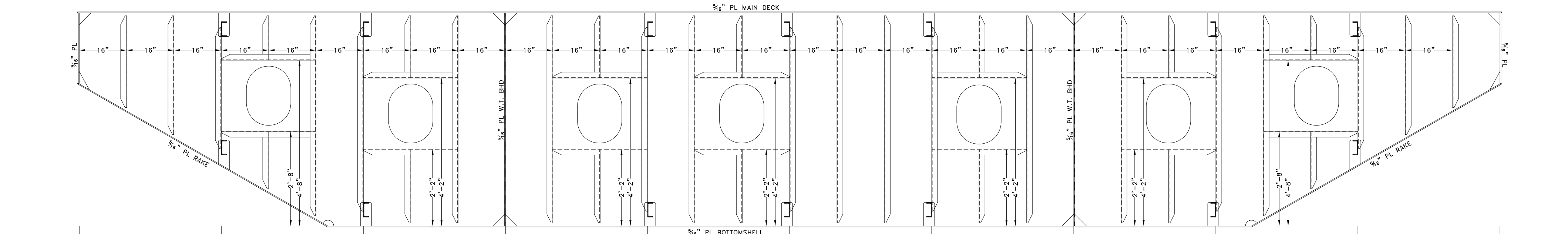

5/16" PL N.T. BHD @ CENTERLINE
W/ 3x2x3/16" L STIFFENERS ON 16" CNTRS
SHOWN LKG OUTBD PORT

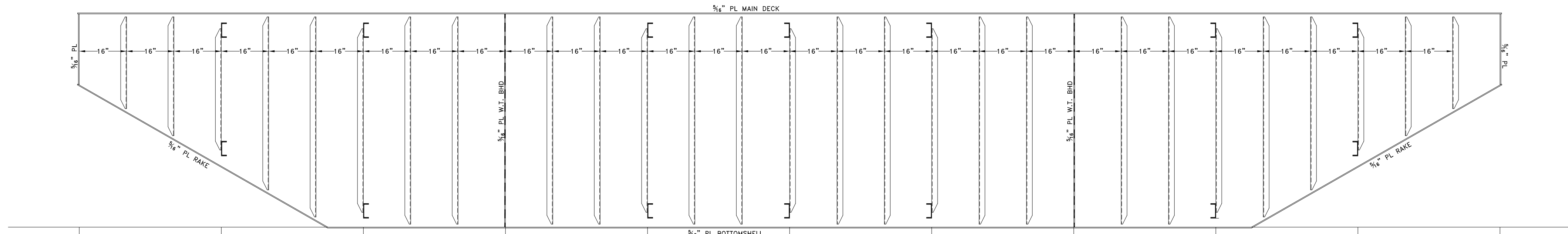

5/16" PL W.T. BHD @ 4'-6" OCL P&S
W/ 3x2x3/16" L STIFFENERS ON 16" CNTRS
PORT SIDE SHOWN LKG OUTBD
STBD SIMILAR OPP. HAND

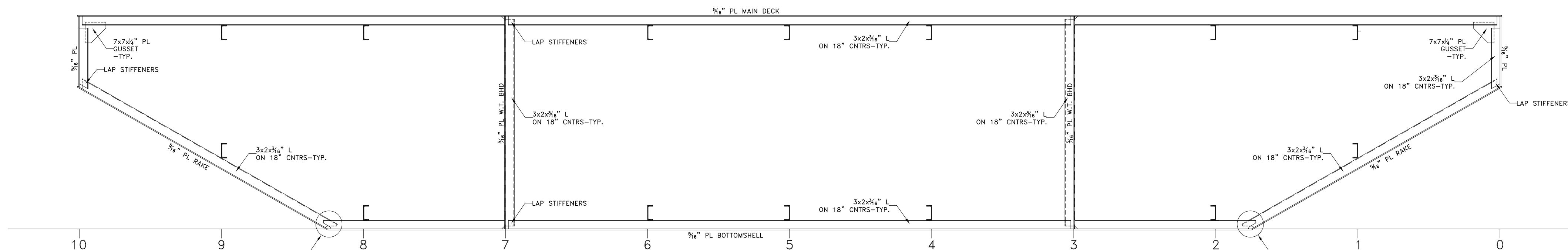

LONGITUDINAL SECTION
IWO TYPICAL FRAMING

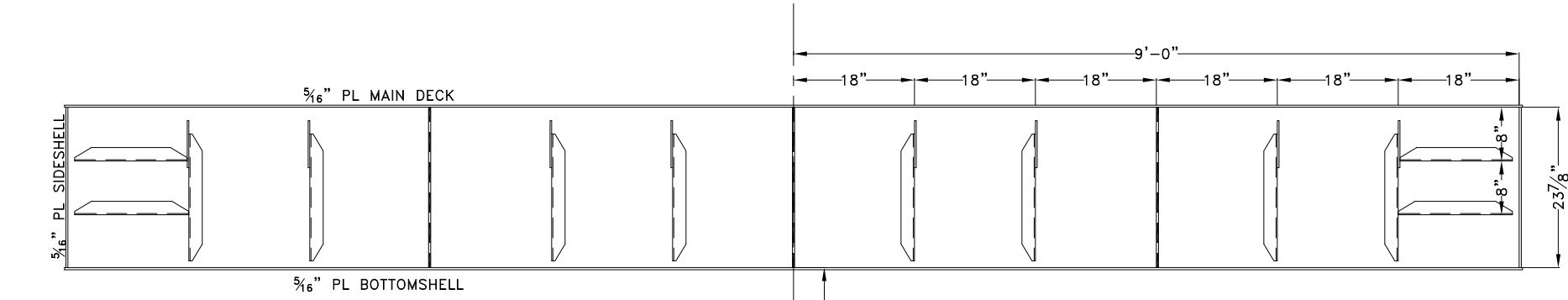

BOW/TRANSOM PLATE
5/16" PL W/3x2x3/16" L STIFFENERS
ON 18" CNTRS UNLESS OTHERWISE NOTED
BOW @ FR O SHOWN LKG FWD
TRANSOM SIM. OPP. HAND

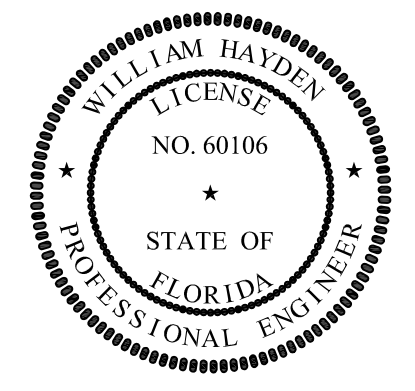

PROFESSIONAL ENGINEER

This document discloses neither in which DeJong & Lebel, Incorporated has proprietary rights, neither conveys any possession thereof, neither confers any right to reproduce, disclose or use in any manner this document in whole or in part or any information contained herein, except by written permission, or written agreement with DeJong & Lebel, Incorporated.

In the event of a purchase of this document the purchaser is authorized to control no more than one device to record herein, unless otherwise agreed to in writing by DeJong & Lebel, Incorporated.

© 2018 by DeJong & Lebel, Inc.

DeJong & Lebel, Inc.
Naval Architects
Marine Engineers
Consultants
Surveyors

1724 Emerson Street
Jacksonville, Florida 32207
www.dejongandlebel.com

Phone: (904) 399-3473
Fax: (904) 399-1522
info@dejongandlebel.com

Title: 40'x18'x6.0' NCDOT DECK BARGE

STRUCTURAL DETAILS

Dwg. No. 1393C-110 Alt. No. 0
Sh. 2 of 2

Drawn By: JACOB CONNALLY Date: JANUARY 2, 2019
Checked By: _____ Date: _____
App'd By: _____ Scale: 1/2" = 1'-0"
ABS App'l: _____ USCG App'l: _____