



STATE OF NORTH CAROLINA  
DEPARTMENT OF TRANSPORTATION

ROY COOPER  
GOVERNOR

JAMES H. TROGDON, III  
SECRETARY

DATE: September 14, 2017

TO: Karen E. Collette, P.E.  
Division Engineer

FROM: Christopher Kreider, P.E.  
Eastern Regional Geotechnical Manager 9/15/2017

STATE PROJECT: 40238.1.4 (U-4902D)  
F.A. NUMBER.: NHS-0017(76)  
COUNTY: New Hanover

DESCRIPTION: US 17 Business (Market Street) from Lendire Road to Marsh Oaks Drive

SUBJECT: Geotechnical Report Addendum – Rock Plating Recommendations

DocuSigned by:  
*Chris Kreider*  
0263EDEBEADC45D...

Per Division’s request, the Geotechnical Engineering Unit has reviewed the roadway plans and cross-sections for the proposed rock plated slopes listed below and provides the following recommendations.

<u>Line</u>	<u>Station(±)</u>	<u>Location</u>
-L-	270+75 ± to 278+75 ±	RT

Use the Standard Rock Plating detail No. 1 of the Standard Drawing No. 1802.01 as shown on the Roadway plans. The estimated quantity for rock plating is 1600 square yards. Rock Plating is outlined in the Section 275 of the 2012 Standard Specifications. The following note should be added to the Roadway Plans:

“USE ROCK PLATING DETAIL NO. 1 AT -L- STA 270+75± TO -L- STA 278+75±, RIGHT. EXTEND ROCK PLATING LIMITS TO 2.75:1 (H:V) SLOPES. SEE STANDARD ROCK PLATING DETAIL.”

Mailing Address:  
NC DEPARTMENT OF TRANSPORTATION  
GEOTECHNICAL ENGINEERING UNIT  
EASTERN REGION  
1570 MAIL SERVICE CENTER,  
RALEIGH, NC 27699-1570

Telephone: (919) 662-4710  
Customer Service: 1-877-368-4968  
Website: www.ncdot.gov

Location:  
GEOTECHNICAL ENGINEERING UNIT  
EASTERN REGIONAL OFFICE  
3301 JONES SAUSAGE ROAD, SUITE 100,  
GARNER, NC 27529

Summary of Rock Plating Table

Line	Beginning Slope	Approx. Station	Ending Slope	Approx. Station	Location LT/RT	Rock Plating Detail No. 1/2/3/4	Riprap Class 1/2/B	SY
-L-	2.75:1	270+75 ±	2.75:1	278+75 ±	RT	1	*	1600

\* Use Riprap Class B, 1 or 2.

If you have any questions concerning this memorandum, please contact Majid Khazaei, P.E. or Chris Kreider, P.E. at 919-662-4710.

Prepared by,



9/15/2017

Majid Khazaei, P.E.

Geotechnical Design Engineer

DocuSigned by:

*Majid Khazaei*

3A9AD1BA06124A3...

CAK/MK

REFERENCE: U-4902D

PROJECT: 40238

SEE SHEET 3 FOR PLAN SHEET LAYOUT AT TIME OF INVESTIGATION

STATE OF NORTH CAROLINA DEPARTMENT OF TRANSPORTATION DIVISION OF HIGHWAYS GEOTECHNICAL ENGINEERING UNIT

ROADWAY SUBSURFACE INVESTIGATION

COUNTY NEW HANOVER PROJECT DESCRIPTION US 17 BUSINESS (MARKET ST.) FROM LENDIRE ROAD TO MARSH OAKS DRIVE

INVENTORY

CONTENTS

Table with 4 columns: LINE, STATION, PLAN, PROFILE. Rows include L, Y28A, Y29, Y30, Y31, Y32, Y33 with corresponding station ranges, plan numbers, and profile numbers.

Table with 4 columns: STATE (N.C.), STATE PROJECT REFERENCE NO. (U-4902D), SHEET NO. (1), TOTAL SHEETS (18)

CAUTION NOTICE

THE SUBSURFACE INFORMATION AND THE SUBSURFACE INVESTIGATION ON WHICH IT IS BASED WERE MADE FOR THE PURPOSE OF STUDY, PLANNING AND DESIGN, AND NOT FOR CONSTRUCTION OR PAY PURPOSES...

GENERAL SOIL AND ROCK STRATA DESCRIPTIONS AND INDICATED BOUNDARIES ARE BASED ON A GEOTECHNICAL INTERPRETATION OF ALL AVAILABLE SUBSURFACE DATA AND MAY NOT NECESSARILY REFLECT THE ACTUAL SUBSURFACE CONDITIONS...

THE BIDDER OR CONTRACTOR IS CAUTIONED THAT DETAILS SHOWN ON THE SUBSURFACE PLANS ARE PRELIMINARY ONLY AND IN MANY CASES THE FINAL DESIGN DETAILS ARE DIFFERENT...

- NOTES: 1. THE INFORMATION CONTAINED HEREIN IS NOT IMPLIED OR GUARANTEED BY THE N. C. DEPARTMENT OF TRANSPORTATION... 2. BY HAVING REQUESTED THIS INFORMATION, THE CONTRACTOR SPECIFICALLY WAIVES ANY CLAIMS...

PERSONNEL

LINDSAY PUGH

COREY FUTRAL

T. TRIANTIS

W.J. MILLER, CWC

MICHAEL D. MASON

INVESTIGATED BY CATLIN

DRAWN BY DAVID MCPHERSON

CHECKED BY STEVEN V. HUDSON

SUBMITTED BY STEVEN V. HUDSON

DATE MAY 2016

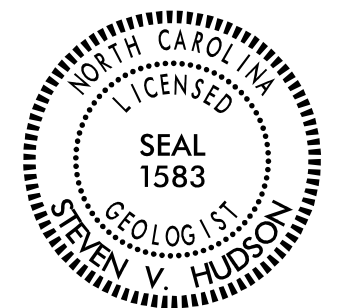

DocuSigned by: Steve Hudson 5/31/2016

DOCUMENT NOT CONSIDERED FINAL UNLESS ALL SIGNATURES COMPLETED

**NORTH CAROLINA DEPARTMENT OF TRANSPORTATION**  
**DIVISION OF HIGHWAYS**  
**GEOTECHNICAL ENGINEERING UNIT**  
**SUBSURFACE INVESTIGATION**  
**SOIL AND ROCK LEGEND, TERMS, SYMBOLS, AND ABBREVIATIONS**

SOIL DESCRIPTION										GRADATION										ROCK DESCRIPTION										TERMS AND DEFINITIONS																																																																																																																																																																										
<p>SOIL IS CONSIDERED UNCONSOLIDATED, SEMI-CONSOLIDATED, OR WEATHERED EARTH MATERIALS THAT CAN BE PENETRATED WITH A CONTINUOUS FLIGHT POWER AUGER AND YIELD LESS THAN 100 BLOWS PER FOOT ACCORDING TO THE STANDARD PENETRATION TEST (AASHTO T 208, ASTM D1586). SOIL CLASSIFICATION IS BASED ON THE AASHTO SYSTEM. BASIC DESCRIPTIONS GENERALLY INCLUDE THE FOLLOWING: CONSISTENCY, COLOR, TEXTURE, MOISTURE, AASHTO CLASSIFICATION, AND OTHER PERTINENT FACTORS SUCH AS MINERALOGICAL COMPOSITION, ANGULARITY, STRUCTURE, PLASTICITY, ETC. FOR EXAMPLE, <i>VERY STIFF, GRAY, SILTY CLAY, MOIST WITH INTERBEDDED FINE SAND LAYERS, HIGHLY PLASTIC, A-7-6</i></p>										<p><b>WELL GRADED</b> - INDICATES A GOOD REPRESENTATION OF PARTICLE SIZES FROM FINE TO COARSE.  <b>UNIFORMLY GRADED</b> - INDICATES THAT SOIL PARTICLES ARE ALL APPROXIMATELY THE SAME SIZE.  <b>GAP-GRADED</b> - INDICATES A MIXTURE OF UNIFORM PARTICLE SIZES OF TWO OR MORE SIZES.</p>										<p>HARD ROCK IS NON-COASTAL PLAIN MATERIAL THAT WOULD YIELD SPT REFUSAL IF TESTED, AN INFERRED ROCK LINE INDICATES THE LEVEL AT WHICH NON-COASTAL PLAIN MATERIAL WOULD YIELD SPT REFUSAL. SPT REFUSAL IS PENETRATION BY A SPLIT SPOON SAMPLER EQUAL TO OR LESS THAN 0.1 FOOT PER 60 BLOWS IN NON-COASTAL PLAIN MATERIAL. THE TRANSITION BETWEEN SOIL AND ROCK IS OFTEN REPRESENTED BY A ZONE OF WEATHERED ROCK. ROCK MATERIALS ARE TYPICALLY DIVIDED AS FOLLOWS:</p>										<p><b>ALLUVIUM (ALLUV.)</b> - SOILS THAT HAVE BEEN TRANSPORTED BY WATER.  <b>AQUIFER</b> - A WATER BEARING FORMATION OR STRATA.  <b>ARENACEOUS</b> - APPLIED TO ROCKS THAT HAVE BEEN DERIVED FROM SAND OR THAT CONTAIN SAND.  <b>ARGILLACEOUS</b> - APPLIED TO ALL ROCKS OR SUBSTANCES COMPOSED OF CLAY MINERALS, OR HAVING A NOTABLE PROPORTION OF CLAY IN THEIR COMPOSITION, SUCH AS SHALE, SLATE, ETC.  <b>ARTESIAN</b> - GROUND WATER THAT IS UNDER SUFFICIENT PRESSURE TO RISE ABOVE THE LEVEL AT WHICH IT IS ENCOUNTERED, BUT WHICH DOES NOT NECESSARILY RISE TO OR ABOVE THE GROUND SURFACE.  <b>CALCAREOUS (CALC.)</b> - SOILS THAT CONTAIN APPRECIABLE AMOUNTS OF CALCIUM CARBONATE.  <b>COLLUVIUM</b> - ROCK FRAGMENTS MIXED WITH SOIL DEPOSITED BY GRAVITY ON SLOPE OR AT BOTTOM OF SLOPE.  <b>CORE RECOVERY (REC.)</b> - TOTAL LENGTH OF ALL MATERIAL RECOVERED IN THE CORE BARREL DIVIDED BY TOTAL LENGTH OF CORE RUN AND EXPRESSED AS A PERCENTAGE.  <b>DIKE</b> - A TABULAR BODY OF IGNEOUS ROCK THAT CUTS ACROSS THE STRUCTURE OF ADJACENT ROCKS OR CUTS MASSIVE ROCK.  <b>DIP</b> - THE ANGLE AT WHICH A STRATUM OR ANY PLANAR FEATURE IS INCLINED FROM THE HORIZONTAL.  <b>DIP DIRECTION (DIP AZIMUTH)</b> - THE DIRECTION OR BEARING OF THE HORIZONTAL TRACE OF THE LINE OF DIP, MEASURED CLOCKWISE FROM NORTH.  <b>FAULT</b> - A FRACTURE OR FRACTURE ZONE ALONG WHICH THERE HAS BEEN DISPLACEMENT OF THE SIDES RELATIVE TO ONE ANOTHER PARALLEL TO THE FRACTURE.  <b>FISSILE</b> - A PROPERTY OF SPLITTING ALONG CLOSELY SPACED PARALLEL PLANES.  <b>FLOAT</b> - ROCK FRAGMENTS ON SURFACE NEAR THEIR ORIGINAL POSITION AND DISLOGGED FROM PARENT MATERIAL.  <b>FLOOD PLAIN (FP)</b> - LAND BORDERING A STREAM, BUILT OF SEDIMENTS DEPOSITED BY THE STREAM.  <b>FORMATION (FM)</b> - A MAPPABLE GEOLOGIC UNIT THAT CAN BE RECOGNIZED AND TRACED IN THE FIELD.  <b>JOINT</b> - FRACTURE IN ROCK ALONG WHICH NO APPRECIABLE MOVEMENT HAS OCCURRED.  <b>LEDGE</b> - A SHELF-LIKE RIDGE OR PROJECTION OF ROCK WHOSE THICKNESS IS SMALL COMPARED TO ITS LATERAL EXTENT.  <b>LENS</b> - A BODY OF SOIL OR ROCK THAT THINS OUT IN ONE OR MORE DIRECTIONS.  <b>MOTTLED (MOT.)</b> - IRREGULARLY MARKED WITH SPOTS OF DIFFERENT COLORS, MOTTLING IN SOILS USUALLY INDICATES POOR AERATION AND LACK OF GOOD DRAINAGE.  <b>PERCHED WATER</b> - WATER MAINTAINED ABOVE THE NORMAL GROUND WATER LEVEL BY THE PRESENCE OF AN INTERVENING IMPERVIOUS STRATUM.  <b>RESIDUAL (RES.) SOIL</b> - SOIL FORMED IN PLACE BY THE WEATHERING OF ROCK.  <b>ROCK QUALITY DESIGNATION (ROD)</b> - A MEASURE OF ROCK QUALITY DESCRIBED BY TOTAL LENGTH OF ROCK SEGMENTS EQUAL TO OR GREATER THAN 4 INCHES DIVIDED BY THE TOTAL LENGTH OF CORE RUN AND EXPRESSED AS A PERCENTAGE.  <b>SAPROLITE (SAP.)</b> - RESIDUAL SOIL THAT RETAINS THE RELIC STRUCTURE OR FABRIC OF THE PARENT ROCK.  <b>SILL</b> - AN INTRUSIVE BODY OF IGNEOUS ROCK OF APPROXIMATELY UNIFORM THICKNESS AND RELATIVELY THIN COMPARED WITH ITS LATERAL EXTENT, THAT HAS BEEN EMPLACED PARALLEL TO THE BEDDING OR SCHISTOSITY OF THE INTRUDED ROCKS.  <b>SLICKENSIDE</b> - POLISHED AND STRIATED SURFACE THAT RESULTS FROM FRICTION ALONG A FAULT OR SLIP PLANE.  <b>STANDARD PENETRATION TEST (PENETRATION RESISTANCE) (SPT)</b> - NUMBER OF BLOWS (IN OR BPF) OF A 140 LB. HAMMER FALLING 30 INCHES REQUIRED TO PRODUCE A PENETRATION OF 1 FOOT INTO SOIL WITH A 2 INCH OUTSIDE DIAMETER SPLIT SPOON SAMPLER. SPT REFUSAL IS PENETRATION EQUAL TO OR LESS THAN 0.1 FOOT PER 60 BLOWS.  <b>STRATA CORE RECOVERY (SREC.)</b> - TOTAL LENGTH OF STRATA MATERIAL RECOVERED DIVIDED BY TOTAL LENGTH OF STRATUM AND EXPRESSED AS A PERCENTAGE.  <b>STRATA ROCK QUALITY DESIGNATION (SROD)</b> - A MEASURE OF ROCK QUALITY DESCRIBED BY TOTAL LENGTH OF ROCK SEGMENTS WITHIN A STRATUM EQUAL TO OR GREATER THAN 4 INCHES DIVIDED BY THE TOTAL LENGTH OF STRATA AND EXPRESSED AS A PERCENTAGE.  <b>TOPSOIL (TS.)</b> - SURFACE SOILS USUALLY CONTAINING ORGANIC MATTER.</p>																																																																																																																																																																										
<p style="text-align: center;"><b>SOIL LEGEND AND AASHTO CLASSIFICATION</b></p> <table border="1" style="width: 100%; border-collapse: collapse;"> <tr> <th rowspan="2">GENERAL CLASS.</th> <th colspan="5">GRANULAR MATERIALS (≤ 35% PASSING #200)</th> <th colspan="5">SILT-CLAY MATERIALS (&gt; 35% PASSING #200)</th> <th colspan="5">ORGANIC MATERIALS</th> </tr> <tr> <th>A-1</th> <th>A-3</th> <th>A-2</th> <th>A-4</th> <th>A-5</th> <th>A-6</th> <th>A-7</th> <th>A-1, A-2</th> <th>A-3</th> <th>A-4, A-5</th> <th>A-6, A-7</th> <th></th> <th></th> <th></th> <th></th> </tr> <tr> <td>GROUP CLASS.</td> <td>A-1-a</td> <td>A-1-b</td> <td>A-2-4</td> <td>A-2-5</td> <td>A-2-6</td> <td>A-2-7</td> <td>A-7-5</td> <td>A-7-6</td> <td></td> <td></td> <td></td> <td></td> <td></td> <td></td> <td></td> </tr> <tr> <td>SYMBOL</td> <td></td> <td></td> <td></td> <td></td> <td></td> <td></td> <td></td> <td></td> <td></td> <td></td> <td></td> <td></td> <td></td> <td></td> <td></td> </tr> <tr> <td>% PASSING #10 #40 #200</td> <td>50 MX 30 MX 15 MX</td> <td>50 MX 25 MX</td> <td>51 MN 35 MX 35 MX</td> <td>40 MX 41 MN 10 MX 11 MN</td> <td>40 MX 41 MN 11 MN 11 MN</td> <td>40 MX 41 MN 11 MN 11 MN</td> <td>40 MX 41 MN 11 MN 11 MN</td> <td>40 MX 41 MN 11 MN 11 MN</td> <td>40 MX 41 MN 11 MN 11 MN</td> <td>40 MX 41 MN 11 MN 11 MN</td> <td>40 MX 41 MN 11 MN 11 MN</td> <td>40 MX 41 MN 11 MN 11 MN</td> <td>40 MX 41 MN 11 MN 11 MN</td> <td>40 MX 41 MN 11 MN 11 MN</td> <td>40 MX 41 MN 11 MN 11 MN</td> </tr> <tr> <td>MATERIAL PASSING #40 LL PI</td> <td>-</td> <td>-</td> <td>NP</td> <td>40 MX 10 MX</td> <td>41 MN 10 MX</td> <td>41 MN 11 MN</td> <td>41 MN 11 MN</td> <td>41 MN 11 MN</td> <td>41 MN 11 MN</td> <td>41 MN 11 MN</td> <td>41 MN 11 MN</td> <td>41 MN 11 MN</td> <td>41 MN 11 MN</td> <td>41 MN 11 MN</td> <td>41 MN 11 MN</td> </tr> <tr> <td>GROUP INDEX</td> <td>0</td> <td>0</td> <td>0</td> <td>4 MX</td> <td>8 MX</td> <td>12 MX</td> <td>16 MX</td> <td>NO MX</td> <td></td> <td></td> <td></td> <td></td> <td></td> <td></td> <td></td> </tr> <tr> <td>USUAL TYPES OF MAJOR MATERIALS</td> <td>STONE FRAGS. GRAVEL, AND SAND</td> <td>FINE SAND</td> <td>SILTY OR CLAYEY GRAVEL AND SAND</td> <td>SILTY SOILS</td> <td>CLAYEY SOILS</td> <td></td> <td></td> <td></td> <td></td> <td></td> <td></td> <td></td> <td></td> <td></td> <td></td> </tr> <tr> <td>GEN. RATING AS SUBGRADE</td> <td colspan="5">EXCELLENT TO GOOD</td> <td colspan="5">FAIR TO POOR</td> <td>FAIR TO POOR</td> <td>POOR</td> <td>UNSATURABLE</td> </tr> <tr> <td colspan="10">PI OF A-7-5 SUBGROUP IS ≤ LL - 30 ; PI OF A-7-6 SUBGROUP IS &gt; LL - 30</td> <td colspan="5"></td> <td colspan="5"></td> </tr> </table>										GENERAL CLASS.	GRANULAR MATERIALS (≤ 35% PASSING #200)					SILT-CLAY MATERIALS (> 35% PASSING #200)					ORGANIC MATERIALS					A-1	A-3	A-2	A-4	A-5	A-6	A-7	A-1, A-2	A-3	A-4, A-5	A-6, A-7					GROUP CLASS.	A-1-a	A-1-b	A-2-4	A-2-5	A-2-6	A-2-7	A-7-5	A-7-6								SYMBOL																% PASSING #10 #40 #200	50 MX 30 MX 15 MX	50 MX 25 MX	51 MN 35 MX 35 MX	40 MX 41 MN 10 MX 11 MN	40 MX 41 MN 11 MN 11 MN	40 MX 41 MN 11 MN 11 MN	40 MX 41 MN 11 MN 11 MN	40 MX 41 MN 11 MN 11 MN	40 MX 41 MN 11 MN 11 MN	40 MX 41 MN 11 MN 11 MN	40 MX 41 MN 11 MN 11 MN	40 MX 41 MN 11 MN 11 MN	40 MX 41 MN 11 MN 11 MN	40 MX 41 MN 11 MN 11 MN	40 MX 41 MN 11 MN 11 MN	MATERIAL PASSING #40 LL PI	-	-	NP	40 MX 10 MX	41 MN 10 MX	41 MN 11 MN	41 MN 11 MN	41 MN 11 MN	41 MN 11 MN	41 MN 11 MN	41 MN 11 MN	41 MN 11 MN	41 MN 11 MN	41 MN 11 MN	41 MN 11 MN	GROUP INDEX	0	0	0	4 MX	8 MX	12 MX	16 MX	NO MX								USUAL TYPES OF MAJOR MATERIALS	STONE FRAGS. GRAVEL, AND SAND	FINE SAND	SILTY OR CLAYEY GRAVEL AND SAND	SILTY SOILS	CLAYEY SOILS											GEN. RATING AS SUBGRADE	EXCELLENT TO GOOD					FAIR TO POOR					FAIR TO POOR	POOR	UNSATURABLE	PI OF A-7-5 SUBGROUP IS ≤ LL - 30 ; PI OF A-7-6 SUBGROUP IS > LL - 30																				<p style="text-align: center;"><b>MINERALOGICAL COMPOSITION</b></p> <p>MINERAL NAMES SUCH AS QUARTZ, FELDSPAR, MICA, TALC, KAOLIN, ETC. ARE USED IN DESCRIPTIONS WHEN THEY ARE CONSIDERED OF SIGNIFICANCE.</p>										<p style="text-align: center;"><b>WEATHERING</b></p> <p>FRESH: ROCK FRESH, CRYSTALS BRIGHT, FEW JOINTS MAY SHOW SLIGHT STAINING. ROCK RINGS UNDER HAMMER IF CRYSTALLINE.</p> <p>VERY SLIGHT (IV SLI.): ROCK GENERALLY FRESH, JOINTS STAINED, SOME JOINTS MAY SHOW THIN CLAY COATINGS IF OPEN. CRYSTALS ON A BROKEN SPECIMEN FACE SHINE BRIGHTLY. ROCK RINGS UNDER HAMMER BLOWS IF OF A CRYSTALLINE NATURE.</p> <p>SLIGHT (SLI.): ROCK GENERALLY FRESH, JOINTS STAINED AND DISCOLORATION EXTENDS INTO ROCK UP TO 1 INCH. OPEN JOINTS MAY CONTAIN CLAY. IN GRANITOID ROCKS SOME OCCASIONAL FELDSPAR CRYSTALS ARE DULL AND DISCOLORED. CRYSTALLINE ROCKS RING UNDER HAMMER BLOWS.</p> <p>MODERATE (MOD.): SIGNIFICANT PORTIONS OF ROCK SHOW DISCOLORATION AND WEATHERING EFFECTS. IN GRANITOID ROCKS, MOST FELDSPARS ARE DULL AND DISCOLORED, SOME SHOW CLAY. ROCK HAS DULL SOUND UNDER HAMMER BLOWS AND SHOWS SIGNIFICANT LOSS OF STRENGTH AS COMPARED WITH FRESH ROCK.</p> <p>MODERATELY SEVERE (MOD. SEV.): ALL ROCK EXCEPT QUARTZ DISCOLORED OR STAINED. IN GRANITOID ROCKS, ALL FELDSPARS DULL AND DISCOLORED AND A MAJORITY SHOW KAOLINIZATION. ROCK SHOWS SEVERE LOSS OF STRENGTH AND CAN BE EXCAVATED WITH A GEOLOGIST'S PICK. ROCK GIVES "CLUNK" SOUND WHEN STRUCK. <i>IF TESTED, WOULD YIELD SPT REFUSAL</i></p> <p>SEVERE (SEV.): ALL ROCK EXCEPT QUARTZ DISCOLORED OR STAINED. ROCK FABRIC CLEAR AND EVIDENT BUT REDUCED IN STRENGTH TO STRONG SOIL. IN GRANITOID ROCKS ALL FELDSPARS ARE KAOLINIZED TO SOME EXTENT. SOME FRAGMENTS OF STRONG ROCK USUALLY REMAIN. <i>IF TESTED, WOULD YIELD SPT N VALUES &gt; 100 BPF</i></p> <p>VERY SEVERE (IV SEV.): ALL ROCK EXCEPT QUARTZ DISCOLORED OR STAINED. ROCK FABRIC ELEMENTS ARE DISCERNIBLE BUT MASS IS EFFECTIVELY REDUCED TO SOIL STATUS, WITH ONLY FRAGMENTS OF STRONG ROCK REMAINING. SAPROLITE IS AN EXAMPLE OF ROCK WEATHERED TO A DEGREE THAT ONLY MINOR VESTIGES OF ORIGINAL ROCK FABRIC REMAIN. <i>IF TESTED, WOULD YIELD SPT N VALUES &lt; 100 BPF</i></p> <p>COMPLETE: ROCK REDUCED TO SOIL. ROCK FABRIC NOT DISCERNIBLE, OR DISCERNIBLE ONLY IN SMALL AND SCATTERED CONCENTRATIONS. QUARTZ MAY BE PRESENT AS DIKES OR STRINGERS. SAPROLITE IS ALSO AN EXAMPLE.</p>										<p style="text-align: center;"><b>GROUND WATER</b></p> <p> WATER LEVEL IN BORE HOLE IMMEDIATELY AFTER DRILLING</p> <p> STATIC WATER LEVEL AFTER 24 HOURS</p> <p> PERCHED WATER, SATURATED ZONE, OR WATER BEARING STRATA</p> <p> SPRING OR SEEP</p>									
GENERAL CLASS.	GRANULAR MATERIALS (≤ 35% PASSING #200)					SILT-CLAY MATERIALS (> 35% PASSING #200)					ORGANIC MATERIALS																																																																																																																																																																																													
	A-1	A-3	A-2	A-4	A-5	A-6	A-7	A-1, A-2	A-3	A-4, A-5	A-6, A-7																																																																																																																																																																																													
GROUP CLASS.	A-1-a	A-1-b	A-2-4	A-2-5	A-2-6	A-2-7	A-7-5	A-7-6																																																																																																																																																																																																
SYMBOL																																																																																																																																																																																																								
% PASSING #10 #40 #200	50 MX 30 MX 15 MX	50 MX 25 MX	51 MN 35 MX 35 MX	40 MX 41 MN 10 MX 11 MN	40 MX 41 MN 11 MN 11 MN	40 MX 41 MN 11 MN 11 MN	40 MX 41 MN 11 MN 11 MN	40 MX 41 MN 11 MN 11 MN	40 MX 41 MN 11 MN 11 MN	40 MX 41 MN 11 MN 11 MN	40 MX 41 MN 11 MN 11 MN	40 MX 41 MN 11 MN 11 MN	40 MX 41 MN 11 MN 11 MN	40 MX 41 MN 11 MN 11 MN	40 MX 41 MN 11 MN 11 MN																																																																																																																																																																																									
MATERIAL PASSING #40 LL PI	-	-	NP	40 MX 10 MX	41 MN 10 MX	41 MN 11 MN	41 MN 11 MN	41 MN 11 MN	41 MN 11 MN	41 MN 11 MN	41 MN 11 MN	41 MN 11 MN	41 MN 11 MN	41 MN 11 MN	41 MN 11 MN																																																																																																																																																																																									
GROUP INDEX	0	0	0	4 MX	8 MX	12 MX	16 MX	NO MX																																																																																																																																																																																																
USUAL TYPES OF MAJOR MATERIALS	STONE FRAGS. GRAVEL, AND SAND	FINE SAND	SILTY OR CLAYEY GRAVEL AND SAND	SILTY SOILS	CLAYEY SOILS																																																																																																																																																																																																			
GEN. RATING AS SUBGRADE	EXCELLENT TO GOOD					FAIR TO POOR					FAIR TO POOR	POOR	UNSATURABLE																																																																																																																																																																																											
PI OF A-7-5 SUBGROUP IS ≤ LL - 30 ; PI OF A-7-6 SUBGROUP IS > LL - 30																																																																																																																																																																																																								
<p style="text-align: center;"><b>CONSISTENCY OR DENSENESS</b></p> <table border="1" style="width: 100%; border-collapse: collapse;"> <tr> <th>PRIMARY SOIL TYPE</th> <th>COMPACTNESS OR CONSISTENCY</th> <th>RANGE OF STANDARD PENETRATION RESISTANCE (N-VALUE)</th> <th>RANGE OF UNCONFINED COMPRESSIVE STRENGTH (TONS/FT<sup>2</sup>)</th> </tr> <tr> <td>GENERALLY GRANULAR MATERIAL (NON-COHESSIVE)</td> <td>VERY LOOSE LOOSE MEDIUM DENSE DENSE VERY DENSE</td> <td>&lt; 4 4 TO 10 10 TO 30 30 TO 50 &gt; 50</td> <td>N/A</td> </tr> <tr> <td>GENERALLY SILT-CLAY MATERIAL (COHESIVE)</td> <td>VERY SOFT SOFT MEDIUM STIFF STIFF VERY STIFF HARD</td> <td>&lt; 2 2 TO 4 4 TO 8 8 TO 15 15 TO 30 &gt; 30</td> <td>&lt; 0.25 0.25 TO 0.5 0.5 TO 1.0 1 TO 2 2 TO 4 &gt; 4</td> </tr> </table>										PRIMARY SOIL TYPE	COMPACTNESS OR CONSISTENCY	RANGE OF STANDARD PENETRATION RESISTANCE (N-VALUE)	RANGE OF UNCONFINED COMPRESSIVE STRENGTH (TONS/FT <sup>2</sup> )	GENERALLY GRANULAR MATERIAL (NON-COHESSIVE)	VERY LOOSE LOOSE MEDIUM DENSE DENSE VERY DENSE	< 4 4 TO 10 10 TO 30 30 TO 50 > 50	N/A	GENERALLY SILT-CLAY MATERIAL (COHESIVE)	VERY SOFT SOFT MEDIUM STIFF STIFF VERY STIFF HARD	< 2 2 TO 4 4 TO 8 8 TO 15 15 TO 30 > 30	< 0.25 0.25 TO 0.5 0.5 TO 1.0 1 TO 2 2 TO 4 > 4	<p style="text-align: center;"><b>MISCELLANEOUS SYMBOLS</b></p> <p> ROADWAY EMBANKMENT (RE) WITH SOIL DESCRIPTION</p> <p> SOIL SYMBOL</p> <p> ARTIFICIAL FILL (AF) OTHER THAN ROADWAY EMBANKMENT</p> <p> INFERRED SOIL BOUNDARY</p> <p> INFERRED ROCK LINE</p> <p> ALLUVIAL SOIL BOUNDARY</p> <p> DIP &amp; DIP DIRECTION OF ROCK STRUCTURES</p> <p> SPT TEST BORING</p> <p> AUGER BORING</p> <p> CORE BORING</p> <p> MONITORING WELL</p> <p> PIEZOMETER INSTALLATION</p> <p> SLOPE INDICATOR INSTALLATION</p> <p> CONE PENETROMETER TEST</p> <p> SOUNDING ROD</p> <p> TEST BORING WITH CORE</p> <p> SPT N-VALUE</p>																																																																																																																																																																																		
PRIMARY SOIL TYPE	COMPACTNESS OR CONSISTENCY	RANGE OF STANDARD PENETRATION RESISTANCE (N-VALUE)	RANGE OF UNCONFINED COMPRESSIVE STRENGTH (TONS/FT <sup>2</sup> )																																																																																																																																																																																																					
GENERALLY GRANULAR MATERIAL (NON-COHESSIVE)	VERY LOOSE LOOSE MEDIUM DENSE DENSE VERY DENSE	< 4 4 TO 10 10 TO 30 30 TO 50 > 50	N/A																																																																																																																																																																																																					
GENERALLY SILT-CLAY MATERIAL (COHESIVE)	VERY SOFT SOFT MEDIUM STIFF STIFF VERY STIFF HARD	< 2 2 TO 4 4 TO 8 8 TO 15 15 TO 30 > 30	< 0.25 0.25 TO 0.5 0.5 TO 1.0 1 TO 2 2 TO 4 > 4																																																																																																																																																																																																					
<p style="text-align: center;"><b>TEXTURE OR GRAIN SIZE</b></p> <table border="1" style="width: 100%; border-collapse: collapse;"> <tr> <th>U.S. STD. SIEVE SIZE OPENING (MM)</th> <td>4</td> <td>10</td> <td>40</td> <td>60</td> <td>200</td> <td>270</td> </tr> <tr> <td></td> <td>4.75</td> <td>2.00</td> <td>0.42</td> <td>0.25</td> <td>0.075</td> <td>0.053</td> </tr> <tr> <th>BOULDER (BLDR.)</th> <th>COBBLE (COB.)</th> <th>GRAVEL (GR.)</th> <th>COARSE SAND (CSE. SD.)</th> <th>FINE SAND (F SD.)</th> <th>SILT (SL.)</th> <th>CLAY (CL.)</th> </tr> <tr> <td>GRAIN SIZE</td> <td>MM 305</td> <td>75</td> <td>2.0</td> <td>0.25</td> <td>0.05</td> <td>0.005</td> </tr> <tr> <td></td> <td>IN. 12</td> <td>3</td> <td></td> <td></td> <td></td> <td></td> </tr> </table>										U.S. STD. SIEVE SIZE OPENING (MM)	4	10	40	60	200	270		4.75	2.00	0.42	0.25	0.075	0.053	BOULDER (BLDR.)	COBBLE (COB.)	GRAVEL (GR.)	COARSE SAND (CSE. SD.)	FINE SAND (F SD.)	SILT (SL.)	CLAY (CL.)	GRAIN SIZE	MM 305	75	2.0	0.25	0.05	0.005		IN. 12	3					<p style="text-align: center;"><b>RECOMMENDATION SYMBOLS</b></p> <p> UNDERCUT</p> <p> SHALLOW UNDERCUT</p> <p> UNCLASSIFIED EXCAVATION - UNSUITABLE WASTE</p> <p> UNCLASSIFIED EXCAVATION - ACCEPTABLE DEGRADABLE ROCK</p> <p> UNCLASSIFIED EXCAVATION - ACCEPTABLE, BUT NOT TO BE USED IN THE TOP 3 FEET OF EMBANKMENT OR BACKFILL</p>										<p style="text-align: center;"><b>ROCK HARDNESS</b></p> <p>VERY HARD: CANNOT BE SCRATCHED BY KNIFE OR SHARP PICK. BREAKING OF HAND SPECIMENS REQUIRES SEVERAL HARD BLOWS OF THE GEOLOGIST'S PICK.</p> <p>HARD: CAN BE SCRATCHED BY KNIFE OR PICK ONLY WITH DIFFICULTY. HARD HAMMER BLOWS REQUIRED TO DETACH HAND SPECIMEN.</p> <p>MODERATELY HARD: CAN BE SCRATCHED BY KNIFE OR PICK. GOUGES OR GROOVES TO 0.25 INCHES DEEP CAN BE EXCAVATED BY HARD BLOW OF A GEOLOGIST'S PICK. HAND SPECIMENS CAN BE DETACHED BY MODERATE BLOWS.</p> <p>MEDIUM HARD: CAN BE GROOVED OR GOUGED 0.05 INCHES DEEP BY FIRM PRESSURE OF KNIFE OR PICK POINT. CAN BE EXCAVATED IN SMALL CHIPS TO PIECES 1 INCH MAXIMUM SIZE BY HARD BLOWS OF THE POINT OF A GEOLOGIST'S PICK.</p> <p>SOFT: CAN BE GROOVED OR GOUGED READILY BY KNIFE OR PICK. CAN BE EXCAVATED IN FRAGMENTS FROM CHIPS TO SEVERAL INCHES IN SIZE BY MODERATE BLOWS OF A PICK POINT. SMALL, THIN PIECES CAN BE BROKEN BY FINGER PRESSURE.</p> <p>VERY SOFT: CAN BE CARVED WITH KNIFE. CAN BE EXCAVATED READILY WITH POINT OF PICK. PIECES 1 INCH OR MORE IN THICKNESS CAN BE BROKEN BY FINGER PRESSURE. CAN BE SCRATCHED READILY BY FINGER NAIL.</p>																																																																																																																																																	
U.S. STD. SIEVE SIZE OPENING (MM)	4	10	40	60	200	270																																																																																																																																																																																																		
	4.75	2.00	0.42	0.25	0.075	0.053																																																																																																																																																																																																		
BOULDER (BLDR.)	COBBLE (COB.)	GRAVEL (GR.)	COARSE SAND (CSE. SD.)	FINE SAND (F SD.)	SILT (SL.)	CLAY (CL.)																																																																																																																																																																																																		
GRAIN SIZE	MM 305	75	2.0	0.25	0.05	0.005																																																																																																																																																																																																		
	IN. 12	3																																																																																																																																																																																																						
<p style="text-align: center;"><b>SOIL MOISTURE - CORRELATION OF TERMS</b></p> <table border="1" style="width: 100%; border-collapse: collapse;"> <tr> <th>SOIL MOISTURE SCALE (ATTERBERG LIMITS)</th> <th>FIELD MOISTURE DESCRIPTION</th> <th>GUIDE FOR FIELD MOISTURE DESCRIPTION</th> </tr> <tr> <td>LL - LIQUID LIMIT</td> <td>- SATURATED - (SAT.)</td> <td>USUALLY LIQUID; VERY WET, USUALLY FROM BELOW THE GROUND WATER TABLE</td> </tr> <tr> <td>PLASTIC RANGE (PI)</td> <td>- WET - (W)</td> <td>SEMISOLID; REQUIRES DRYING TO ATTAIN OPTIMUM MOISTURE</td> </tr> <tr> <td>OM - OPTIMUM MOISTURE SHRINKAGE LIMIT</td> <td>- MOIST - (M)</td> <td>SOLID; AT OR NEAR OPTIMUM MOISTURE</td> </tr> <tr> <td>SL - SHRINKAGE LIMIT</td> <td>- DRY - (D)</td> <td>REQUIRES ADDITIONAL WATER TO ATTAIN OPTIMUM MOISTURE</td> </tr> </table>										SOIL MOISTURE SCALE (ATTERBERG LIMITS)	FIELD MOISTURE DESCRIPTION	GUIDE FOR FIELD MOISTURE DESCRIPTION	LL - LIQUID LIMIT	- SATURATED - (SAT.)	USUALLY LIQUID; VERY WET, USUALLY FROM BELOW THE GROUND WATER TABLE	PLASTIC RANGE (PI)	- WET - (W)	SEMISOLID; REQUIRES DRYING TO ATTAIN OPTIMUM MOISTURE	OM - OPTIMUM MOISTURE SHRINKAGE LIMIT	- MOIST - (M)	SOLID; AT OR NEAR OPTIMUM MOISTURE	SL - SHRINKAGE LIMIT	- DRY - (D)	REQUIRES ADDITIONAL WATER TO ATTAIN OPTIMUM MOISTURE	<p style="text-align: center;"><b>ABBREVIATIONS</b></p> <p>AR - AUGER REFUSAL  BT - BORING TERMINATED  CL - CLAY  CPT - CONE PENETRATION TEST  CSE - COARSE  DMT - DILATOMETER TEST  DPT - DYNAMIC PENETRATION TEST  e - VOID RATIO  F - FINE  FOSS. - FOSSILIFEROUS  FRAC. - FRACTURED, FRACTURES  FRAGS. - FRAGMENTS  HI. - HIGHLY</p> <p>MED. - MEDIUM  MICA - MICACEOUS  MOD. - MODERATELY  NP - NON PLASTIC  ORG. - ORGANIC  PMT - PRESSUREMETER TEST  SAP. - SAPROLITIC  SD. - SAND, SANDY  SL. - SILT, SILTY  SLI. - SLIGHTLY  TCR - TRICONE REFUSAL  w - MOISTURE CONTENT  V - VERY</p> <p>VST - VANE SHEAR TEST  WEA. - WEATHERED  W - UNIT WEIGHT  W<sub>d</sub> - DRY UNIT WEIGHT</p> <p><b>SAMPLE ABBREVIATIONS</b></p> <p>S - BULK  SS - SPLIT SPOON  ST - SHELBY TUBE  RS - ROCK  RT - RECOMPACTED TRIAXIAL  CBR - CALIFORNIA BEARING RATIO</p>																																																																																																																																																																															
SOIL MOISTURE SCALE (ATTERBERG LIMITS)	FIELD MOISTURE DESCRIPTION	GUIDE FOR FIELD MOISTURE DESCRIPTION																																																																																																																																																																																																						
LL - LIQUID LIMIT	- SATURATED - (SAT.)	USUALLY LIQUID; VERY WET, USUALLY FROM BELOW THE GROUND WATER TABLE																																																																																																																																																																																																						
PLASTIC RANGE (PI)	- WET - (W)	SEMISOLID; REQUIRES DRYING TO ATTAIN OPTIMUM MOISTURE																																																																																																																																																																																																						
OM - OPTIMUM MOISTURE SHRINKAGE LIMIT	- MOIST - (M)	SOLID; AT OR NEAR OPTIMUM MOISTURE																																																																																																																																																																																																						
SL - SHRINKAGE LIMIT	- DRY - (D)	REQUIRES ADDITIONAL WATER TO ATTAIN OPTIMUM MOISTURE																																																																																																																																																																																																						
<p style="text-align: center;"><b>PLASTICITY</b></p> <table border="1" style="width: 100%; border-collapse: collapse;"> <tr> <th>NON PLASTIC</th> <th>SLIGHTLY PLASTIC</th> <th>MODERATELY PLASTIC</th> <th>HIGHLY PLASTIC</th> </tr> <tr> <td>PLASTICITY INDEX (PI)</td> <td>0-5</td> <td>6-15</td> <td>16-25</td> </tr> <tr> <td></td> <td>26 OR MORE</td> <td></td> <td></td> </tr> <tr> <td></td> <td></td> <td>DRY STRENGTH</td> <td></td> </tr> <tr> <td></td> <td></td> <td>VERY LOW</td> <td>SLIGHT</td> </tr> <tr> <td></td> <td></td> <td>MEDIUM</td> <td>HIGH</td> </tr> </table>										NON PLASTIC	SLIGHTLY PLASTIC	MODERATELY PLASTIC	HIGHLY PLASTIC	PLASTICITY INDEX (PI)	0-5	6-15	16-25		26 OR MORE					DRY STRENGTH				VERY LOW	SLIGHT			MEDIUM	HIGH	<p style="text-align: center;"><b>EQUIPMENT USED ON SUBJECT PROJECT</b></p> <p>DRILL UNITS:</p> <p><input checked="" type="checkbox"/> CME-45B</p> <p><input checked="" type="checkbox"/> DIEDRICH D-50</p> <p><input type="checkbox"/> CME-550</p> <p><input type="checkbox"/> VANE SHEAR TEST</p> <p><input type="checkbox"/> PORTABLE HOIST</p> <p><input type="checkbox"/></p> <p><input type="checkbox"/></p> <p>ADVANCING TOOLS:</p> <p><input type="checkbox"/> CLAY BITS</p> <p><input type="checkbox"/> 6" CONTINUOUS FLIGHT AUGER</p> <p><input checked="" type="checkbox"/> 8" HOLLOW AUGERS</p> <p><input checked="" type="checkbox"/> HARD FACED FINGER BITS</p> <p><input type="checkbox"/> TUNG-CARBIDE INSERTS</p> <p><input type="checkbox"/> CASING <input type="checkbox"/> W/ ADVANCER</p> <p><input type="checkbox"/> TRICONE <input type="checkbox"/> STEEL TEETH</p> <p><input type="checkbox"/> TRICONE <input type="checkbox"/> TUNG-CARB.</p> <p><input type="checkbox"/> CORE BIT</p> <p><input type="checkbox"/></p> <p>HAMMER TYPE:</p> <p><input type="checkbox"/> AUTOMATIC <input type="checkbox"/> MANUAL</p> <p>CORE SIZE:</p> <p><input type="checkbox"/> -B <input type="checkbox"/> -H <input type="checkbox"/> -N</p> <p>HAND TOOLS:</p> <p><input type="checkbox"/> POST HOLE DIGGER</p> <p><input checked="" type="checkbox"/> HAND AUGER</p> <p><input type="checkbox"/> SOUNDING ROD</p> <p><input type="checkbox"/> VANE SHEAR TEST</p>																																																																																																																																																																						
NON PLASTIC	SLIGHTLY PLASTIC	MODERATELY PLASTIC	HIGHLY PLASTIC																																																																																																																																																																																																					
PLASTICITY INDEX (PI)	0-5	6-15	16-25																																																																																																																																																																																																					
	26 OR MORE																																																																																																																																																																																																							
		DRY STRENGTH																																																																																																																																																																																																						
		VERY LOW	SLIGHT																																																																																																																																																																																																					
		MEDIUM	HIGH																																																																																																																																																																																																					
<p style="text-align: center;"><b>FRACATURE SPACING</b></p> <table border="1" style="width: 100%; border-collapse: collapse;"> <tr> <th>TERM</th> <th>SPACING</th> </tr> <tr> <td>VERY WIDE</td> <td>MORE THAN 10 FEET</td> </tr> <tr> <td>WIDE</td> <td>3 TO 10 FEET</td> </tr> <tr> <td>MODERATELY CLOSE</td> <td>1 TO 3 FEET</td> </tr> <tr> <td>CLOSE</td> <td>0.16 TO 1 FOOT</td> </tr> <tr> <td>VERY CLOSE</td> <td>LESS THAN 0.16 FEET</td> </tr> </table>										TERM	SPACING	VERY WIDE	MORE THAN 10 FEET	WIDE	3 TO 10 FEET	MODERATELY CLOSE	1 TO 3 FEET	CLOSE	0.16 TO 1 FOOT	VERY CLOSE	LESS THAN 0.16 FEET	<p style="text-align: center;"><b>BEDDING</b></p> <table border="1" style="width: 100%; border-collapse: collapse;"> <tr> <th>TERM</th> <th>THICKNESS</th> </tr> <tr> <td>VERY THICKLY BEDDED</td> <td>4 FEET</td> </tr> <tr> <td>THICKLY BEDDED</td> <td>1.5 - 4 FEET</td> </tr> <tr> <td>THINLY BEDDED</td> <td>0.16 - 1.5 FEET</td> </tr> <tr> <td>VERY THINLY BEDDED</td> <td>0.03 - 0.16 FEET</td> </tr> <tr> <td>THICKLY LAMINATED</td> <td>0.008 - 0.03 FEET</td> </tr> <tr> <td>THINLY LAMINATED</td> <td>&lt; 0.008 FEET</td> </tr> </table>										TERM	THICKNESS	VERY THICKLY BEDDED	4 FEET	THICKLY BEDDED	1.5 - 4 FEET	THINLY BEDDED	0.16 - 1.5 FEET	VERY THINLY BEDDED	0.03 - 0.16 FEET	THICKLY LAMINATED	0.008 - 0.03 FEET	THINLY LAMINATED	< 0.008 FEET																																																																																																																																																											
TERM	SPACING																																																																																																																																																																																																							
VERY WIDE	MORE THAN 10 FEET																																																																																																																																																																																																							
WIDE	3 TO 10 FEET																																																																																																																																																																																																							
MODERATELY CLOSE	1 TO 3 FEET																																																																																																																																																																																																							
CLOSE	0.16 TO 1 FOOT																																																																																																																																																																																																							
VERY CLOSE	LESS THAN 0.16 FEET																																																																																																																																																																																																							
TERM	THICKNESS																																																																																																																																																																																																							
VERY THICKLY BEDDED	4 FEET																																																																																																																																																																																																							
THICKLY BEDDED	1.5 - 4 FEET																																																																																																																																																																																																							
THINLY BEDDED	0.16 - 1.5 FEET																																																																																																																																																																																																							
VERY THINLY BEDDED	0.03 - 0.16 FEET																																																																																																																																																																																																							
THICKLY LAMINATED	0.008 - 0.03 FEET																																																																																																																																																																																																							
THINLY LAMINATED	< 0.008 FEET																																																																																																																																																																																																							
<p style="text-align: center;"><b>INDURATION</b></p> <p>FOR SEDIMENTARY ROCKS, INDURATION IS THE HARDENING OF MATERIAL BY CEMENTING, HEAT, PRESSURE, ETC.</p> <p>FRIABLE: RUBBING WITH FINGER FREES NUMEROUS GRAINS; GENTLE BLOW BY HAMMER DISINTEGRATES SAMPLE.</p> <p>MODERATELY INDURATED: GRAINS CAN BE SEPARATED FROM SAMPLE WITH STEEL PROBE; BREAKS EASILY WHEN HIT WITH HAMMER.</p> <p>INDURATED: GRAINS ARE DIFFICULT TO SEPARATE WITH STEEL PROBE; DIFFICULT TO BREAK WITH HAMMER.</p> <p>EXTREMELY INDURATED: SHARP HAMMER BLOWS REQUIRED TO BREAK SAMPLE; SAMPLE BREAKS ACROSS GRAINS.</p>										<p style="text-align: center;"><b>BENCH MARK:</b></p> <p style="text-align: right;">ELEVATION: FEET</p>																																																																																																																																																																																														
<p style="text-align: center;"><b>COLOR</b></p> <p>DESCRIPTIONS MAY INCLUDE COLOR OR COLOR COMBINATIONS (TAN, RED, YELLOW-BROWN, BLUE-BROWN). MODIFIERS SUCH AS LIGHT, DARK, STREAKED, ETC. ARE USED TO DESCRIBE APPEARANCE.</p>										<p style="text-align: center;"><b>NOTES:</b></p> <p>U.C.P. = UNDIFFERENTIATED COASTAL PLAIN</p> <p>W/ = WITH</p> <p> = APPROXIMATE HORIZONTAL LIMIT OF ORGANIC SOIL</p>																																																																																																																																																																																														

STATE OF NORTH CAROLINA  
DIVISION OF HIGHWAYS

**NEW HANOVER COUNTY**

**LOCATION: MARKET STREET FROM JUST WEST OF US 74  
(MLK PARKWAY) TO WEST OF STATION ROAD  
AND WEST OF WENDOVER LN TO MARSH OAKS DR  
TYPE OF WORK: GRADING, PAVING, AND DRAINAGE**

STATE	STATE PROJECT REFERENCE NO.	SHEET NO.	TOTAL SHEETS
N.C.	U-4902D	3	18
STATE PROJ. NO.	F.A. PROJ. NO.	DESCRIPTION	
40238.1.1			

**TIP PROJECT: U-4902D**

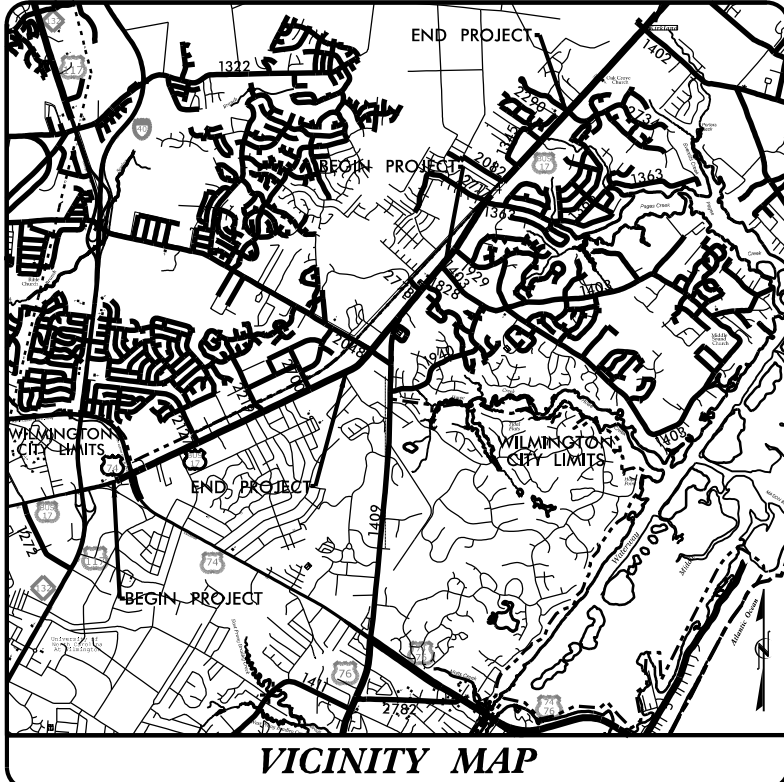

65% PLAN SUBMITTAL

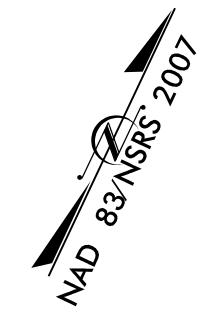
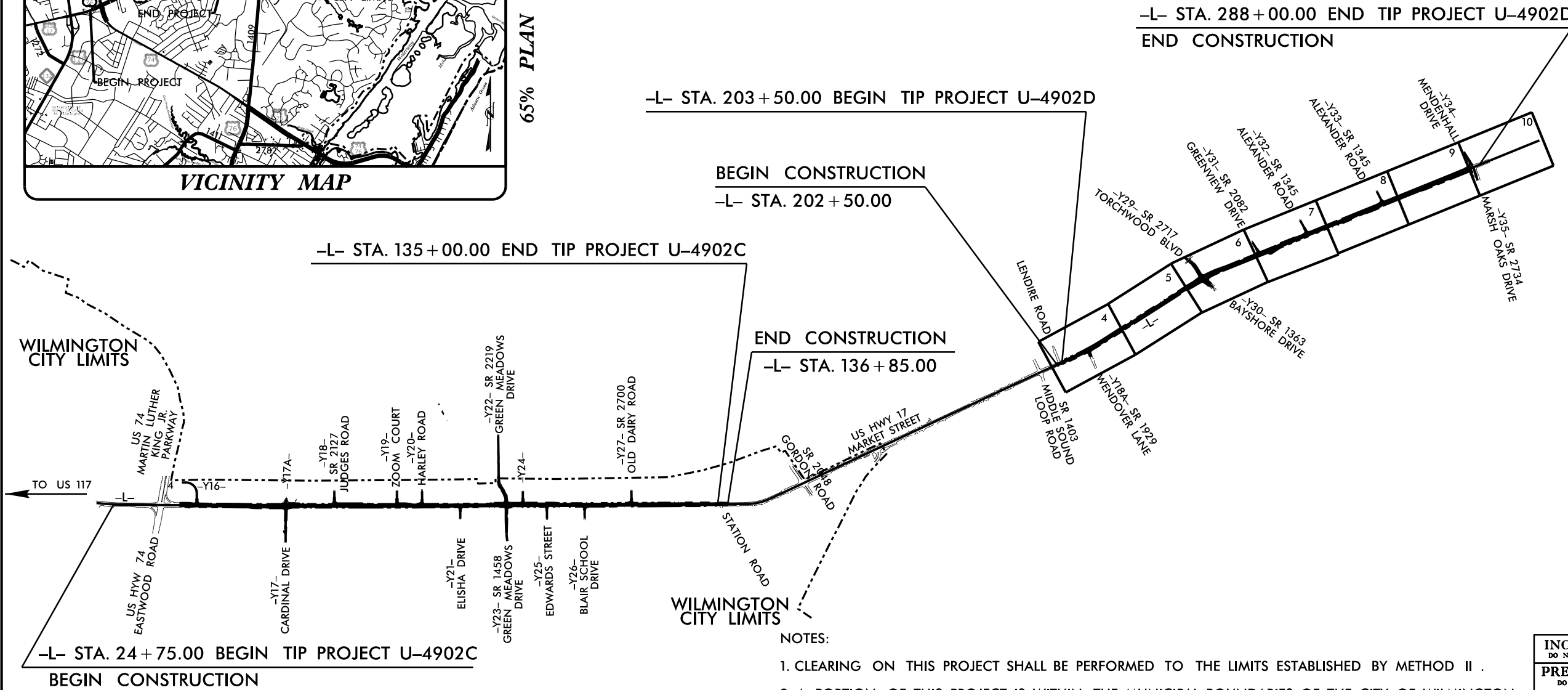

- NOTES:
- CLEARING ON THIS PROJECT SHALL BE PERFORMED TO THE LIMITS ESTABLISHED BY METHOD II .
  - A PORTION OF THIS PROJECT IS WITHIN THE MUNICIPAL BOUNDARIES OF THE CITY OF WILMINGTON.

**INCOMPLETE PLANS**  
DO NOT USE FOR R/W ACQUISITION

**PRELIMINARY PLANS**  
DO NOT USE FOR CONSTRUCTION

**CONTRACT:**

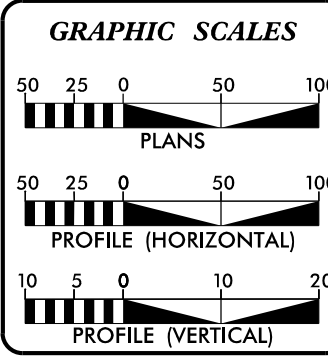

**DESIGN DATA**

ADT 2008 =	52,900
ADT 2035 =	66,000
K =	11 %
D =	55 %
T =	6 % *
V =	50 MPH
* TTST = 2% DUAL 4%	
FUNC CLASS = PRINCIPAL ARTERIAL	
REGIONAL TIER	

**PROJECT LENGTH**

LENGTH OF ROADWAY T.I.P. PROJECT U-4902CD =	3.688 MILES
TOTAL LENGTH OF T.I.P. PROJECT U-4902CD =	3.688 MILES
ALL LENGTH BASED ON -L- CENTERLINE	

Prepared In the Office of:  
**HNTB NORTH CAROLINA, P.C.**  
343 E. Six Forks Road, Raleigh NC, 27609

2012 STANDARD SPECIFICATIONS

**RIGHT OF WAY DATE:**  
SEPTEMBER 10, 2015

**LETTING DATE:**  
AUGUST 16, 2016

<b>DAVID BASS, PE</b> PROJECT ENGINEER
<b>TRACE HOWELL, EI</b> PROJECT DESIGN ENGINEER
<b>DAVID LEONARD, PE</b> NCDOT CONTACT

**HYDRAULICS ENGINEER**

SIGNATURE: \_\_\_\_\_ P.E.

**ROADWAY DESIGN ENGINEER**

SIGNATURE: \_\_\_\_\_ P.E.

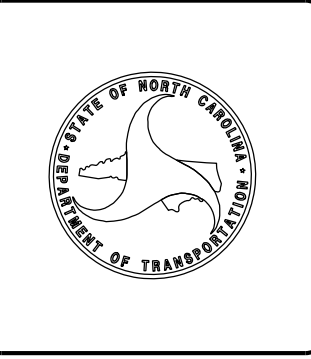

STATE PROJECT: 40238.1.4 (U-4902D)  
 F.A. PROJECT: NHS-0017(76)  
 COUNTY: NEW HANOVER  
 DESCRIPTION: US 17 Business (Market Street) from Lendire Road to Marsh Oaks Drive  
 SUBJECT: Geotechnical Inventory Report

1988 (NGVD88). All measurements were recorded and reported in United States Survey Feet (US Ft).

The following alignments were investigated. Plan sheets, subsurface profiles, and selected cross sections of the alignment are included in this report.

**PROJECT DESCRIPTION**

The proposed project is located in New Hanover County just north of the city of Wilmington. The proposed roadway will consist of widening existing US 17 Business (Market Street).

A geotechnical field investigation was conducted by CATLIN Engineers and Scientists (CATLIN) personnel in March through May 2016. Standard penetration test borings were advanced using hollow-stem augers under the direct supervision of a North Carolina Licensed Well Contractor with a Central Mine Equipment (CME) CME 45B drilling rig and a Diedrich D-50 drilling rig equipped with an automatic hammer. Standard penetration testing was conducted in general accordance with American Society for Testing and Materials (ASTM) D-1586-84, "Penetration Test and Split Barrel Sampling of Soils" or American Association of State Highway and Transportation Officials (AASHTO) Standard Method T206-81. Hand auger borings were advanced across the entire project site to augment the SPT data. A total of 50 borings totaling roughly 355 vertical feet were advanced during this investigation.

Representative soil samples were collected for visual classification in the field and selected samples were submitted for laboratory analysis by CATLIN Geotechnical Laboratory in Wilmington, North Carolina. Samples were prepared and analyzed in accordance with one or more of the following AASHTO Standards as modified by NCDOT:

- T 87-86 (Dry Preparation of Disturbed Soil)
- T 88-93 (Particle Size Analysis)
- T 89-94 (Liquid Limit)
- T 90-94 (Plastic Limit)
- T 265-93 (Soil Moisture Content)
- T 267 (Organic Content)

CATLIN personnel used Global Positioning System (GPS) technology to locate all borings. All horizontal locations were recorded to the nearest foot and are presented in the North Carolina State Plane (NCSP), North American Datum 1983 (NAD 83). Vertical control was measured to the nearest 0.1 foot and referenced to the National Geodetic Vertical Datum

<u>Line</u>	<u>Station (±)</u>
-L-	202+50 to 288+00
-Y28A-	10+00 to 11+25
-Y29-	13+00 to 17+10
-Y30-	10+00 to 11+75
-Y31-	11+25 to 12+50
-Y32-	11+50 to 13+02
-Y33-	11+65 to 12+50

The project reportedly will consist of 1.734 miles of roadway widening.

**AREAS OF SPECIAL GEOTECHNICAL INTEREST**

- 1) GROUNDWATER: Groundwater within six (6) feet of natural ground was noted at the following sections:

<u>Line</u>	<u>Station (±)</u>
-L-	202+50 to 224+00
-L-	226+00 to 254+00
-L-	272+00 to 288+00
-Y28A-	10+00 to 11+25
-Y29-	13+00 to 17+10
-Y30-	10+00 to 11+75
-Y31-	11+25 to 12+50
-Y32-	11+50 to 13+02

- 2) COHESIVE SOILS: Clay or cohesive soils which may have the potential to cause embankment/subgrade and or slope stability problems during construction was encountered at the following sections of the project:

<u>Line</u>	<u>Station ±</u>
-L-	220+14 to 221+40

- 3) **ORGANIC SOILS:** Organic material that may cause construction related issues was identified at the following sections on the project:

<u>Line</u>	<u>Station ±</u>
-L-	202+50 to 204+03
-L-	208+00 to 209+50
-L-	221+29 to 222+40
-L-	242+00 to 244+60
-L-	271+00 to 275+00
-L-	280+40 to 281+70
-Y28A-	10+00 to 11+25

- 4) **WATER WELLS:** No water wells were identified within the proposed construction limits. Water supply wells may be present along the project corridors that were not detected.

### **PHYSIOGRAPHY AND GEOLOGY**

The project is located within the eastern most portion of the North Carolina Coastal Plain physiographic province. Geology in the vicinity of Wilmington is dominated by Undifferentiated Coastal Plain (U.C.P.) materials which are noted as Quaternary Surficial Deposits on the Geologic Map of North Carolina. Coastal Plain materials are described as sand, clay, gravel, and peat deposits which were deposited in marine, fluvial, eolian, and lacustrine environments. Sediments of the Castle Hayne and Peedee Formations are reported to underlay the U.C.P. deposits in the vicinity of Wilmington.

Land use in the area is primarily commercial and residential. The land surface in the project vicinity is dominated by flat terrain typical of coastal environments with land surface elevations ranging from approximately 25 to 47 feet. Numerous underground and overhead utilities exist in the vicinity of the proposed project. The project is primarily drained by surficial runoff to stormwater systems and drainage ditches.

### **GROUNDWATER**

Groundwater data was collected from open boreholes, where possible, during the field investigation conducted between March and May 2016

Measured groundwater elevations (24 hour measurements) ranged from elevation 22.5 feet to 42.5 feet with an average elevation of 34.8 feet. Twenty-four hour depth to groundwater measurements ranged from 1.5 feet to 6.4 feet below existing land surface (BLS), with an average depth to water of 3.7 feet. Formational material in which groundwater was typically observed was found to be predominantly silty sand material with an assumed moderate permeability.

### **SOIL PROPERTIES**

Soils encountered at the project site include roadway embankment and undifferentiated coastal plain sediments.

Roadway embankment soils were identified beneath and adjacent to existing roadways and consist of loose to medium dense, sand and silty sand (A-3 and A-2-4).

The dominant U.C.P. material encountered consisted of very loose to medium dense sand to silty sand (A-3 and A-2-4). The sand was encountered from land surface, or below the roadway embankment to a depth of at least 12 feet BLS (depth of deepest borings). A small amount of highly plastic clay, silt, and organic sands were encountered at the previously described locations.

Material within the identified organic soil area was described as very loose, dark brown to black, highly organic (15.2% to 18.9%) sand to silty fine sand with little (3.1% to 6.8%) organics.

Prepared by,  
Steven V. Hudson, L.G.  
Project Geologist



5/31/2016

PROJECT REFERENCE NO.	SHEET NO.
U-4902D	4
RW SHEET NO.	
ROADWAY DESIGN ENGINEER	HYDRAULICS ENGINEER
<b>INCOMPLETE PLANS</b> DO NOT USE FOR A/W ACQUISITION	
DOCUMENT NOT CONSIDERED FINAL UNLESS ALL SIGNATURES COMPLETED	

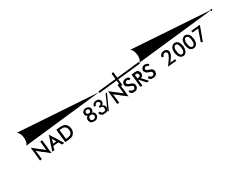

**BEGIN TIP PROJECT U-4902D**  
**-L- POT STA. 203 + 50.00**  
**END TIP PROJECT U-4751**  
**-YI- POT STA 83 + 14.00**

215

210

-L- POC Sta. 208+75.01=  
 -Y28A- POT Sta. 10+00.00

-L- PC Sta. 205+64.96

-L- PT Sta. 211+98.60

MATCH LINE -L- STA 216 + 00.00  
 SEE SHEET 5

**BEGIN CONSTRUCTION**  
**-L- STA. 202 + 50.00**

**END CONSTRUCTION**  
 -Y28A- POT Sta. 11+25.00  
 -Y28A- POT Sta. 11+30.00

-L-  
 PI Sta 208+82.33  
 $\Delta = 8^{\circ} 15' 04''$  (LT)  
 D = 118' 07.8"  
 L = 633.64'  
 T = 317.37'  
 R = 4,400.00'

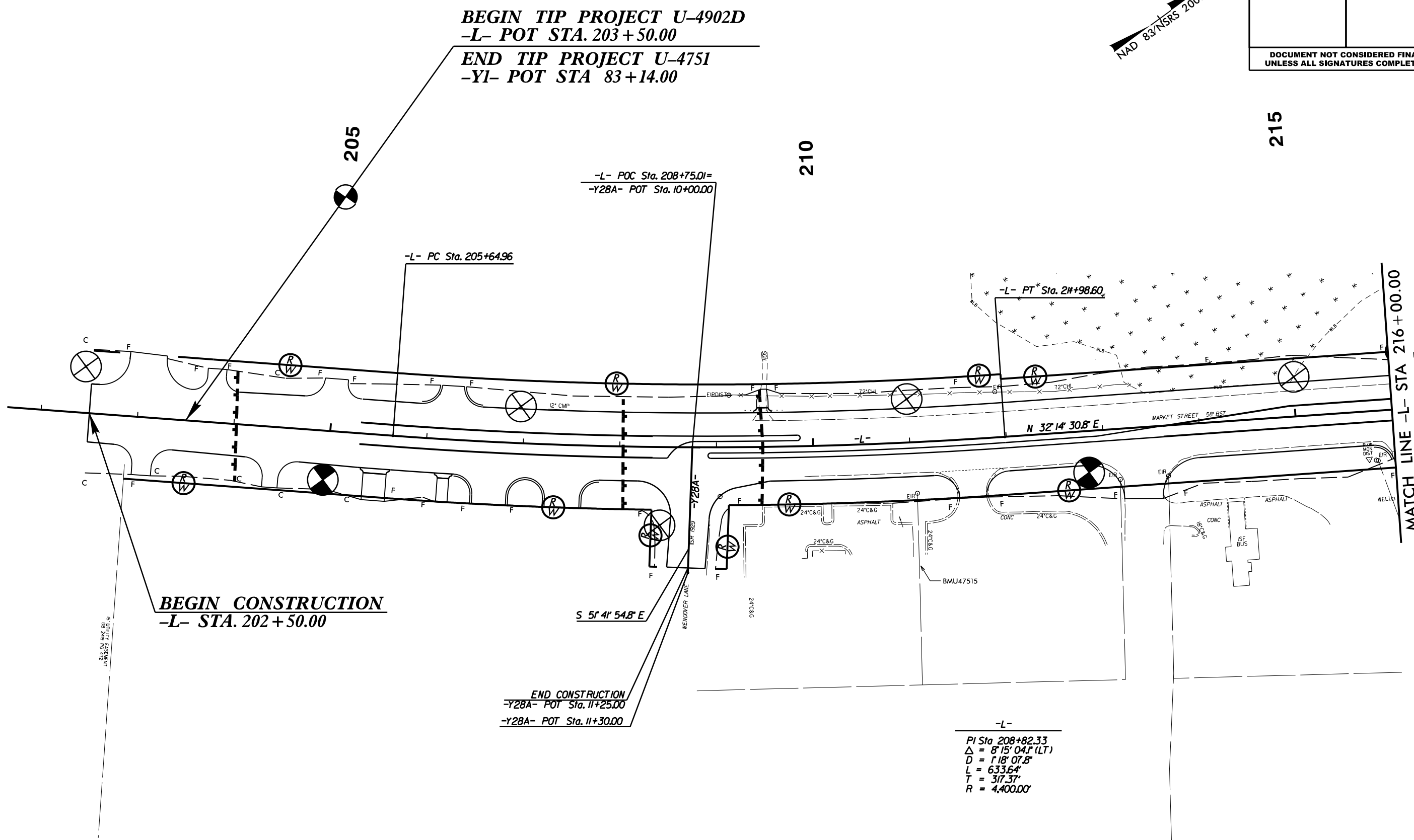

25-MAY-2016\_08:33  
 S:\wpmk\fig\PROJECT\2016\216032 NCDOT MARKET STREET U4902D.GEO\_PDWY\CADD\_GEO\TECH\Site&Sub\U4902D\_GEO\_psh\_04.dgn  
 8/17/99  
 REVISIONS





PROJECT REFERENCE NO.	SHEET NO.
U-4902D	6
RW SHEET NO.	
ROADWAY DESIGN ENGINEER	HYDRAULICS ENGINEER
<b>INCOMPLETE PLANS</b> DO NOT USE FOR A/W ACQUISITION	
<b>DOCUMENT NOT CONSIDERED FINAL</b> UNLESS ALL SIGNATURES COMPLETED	

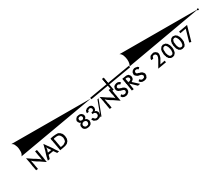

**-Y29-**  
 PI Sta 13+97.39  
 $\Delta = 25^{\circ} 33' 01.3" (RT)$   
 $D = 10^{\circ} 56' 03.5"$   
 $L = 233.67'$   
 $T = 118.81'$   
 $R = 524.00'$

**BEGIN CONSTRUCTION**  
 -Y29- POC STA 13+00.00

-L- POT STA 233+34.80 =  
 -Y29- POT STA 17+10.51

-Y29- PT Sta. 15+12.25

MATCH LINE -L- 230+00.00  
SEE SHEET 5

-L- PC Sta. 230+13.66

-L- POT STA 233+36.89 =  
 -Y30- POT STA 10+00.00

**END CONSTRUCTION**  
 -L- -Y30- POT STA 11+75.00

PI Sta 233+80.37  
 $\Delta = 10^{\circ} 20' 51.1" (RT)$   
 $D = 1^{\circ} 24' 53.0"$   
 $L = 731.42'$   
 $T = 366.71'$   
 $R = 4050.00'$

-Y30- POT Sta. 12+54.62

-L- PT Sta. 237+45.09

MATCH LINE -L- STA 244+00.00  
SEE SHEET 7

8/17/99  
 REVISIONS  
 25-MAY-2016\_08:33  
 S:\wpmk\g\PROJECTS\2016\216932 NCDOT MARKET STREET U4902D.Lendire Rd. to Marsh Oaks\U4902D.GEO\RDWY\CADD\GEO\TECH\Site\Sub\U4902D\_GEO\_psh\_06.dgn  
 216932 NCDOT MARKET STREET U4902D.GEO\RDWY\CADD\GEO\TECH\Site\Sub\U4902D\_GEO\_psh\_06.dgn  
 216932 NCDOT MARKET STREET U4902D.GEO\RDWY\CADD\GEO\TECH\Site\Sub\U4902D\_GEO\_psh\_06.dgn

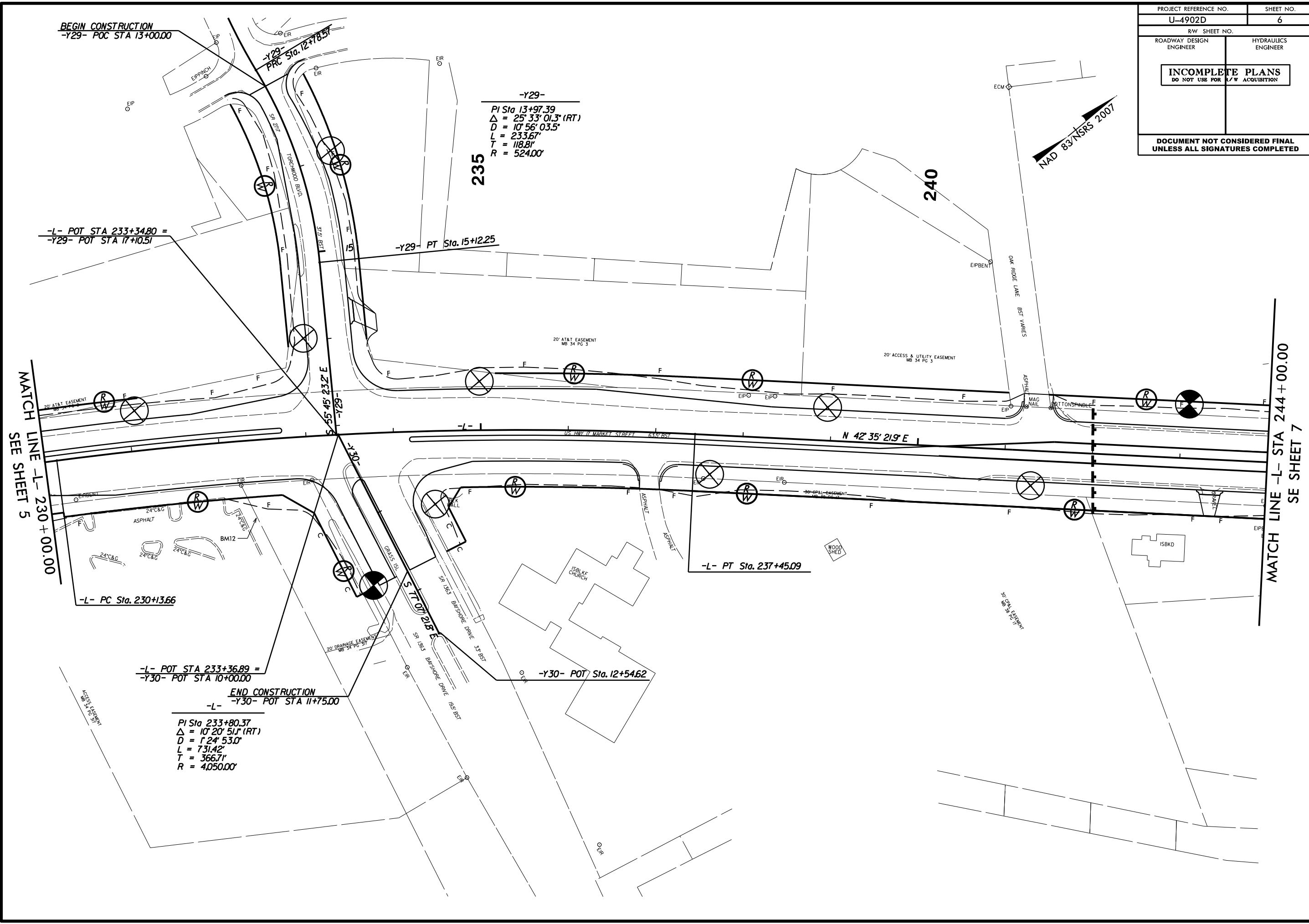



PROJECT REFERENCE NO. U-4902D	SHEET NO. 8
RW SHEET NO.	
ROADWAY DESIGN ENGINEER	HYDRAULICS ENGINEER
<b>INCOMPLETE PLANS</b> DO NOT USE FOR R/W ACQUISITION	
<b>DOCUMENT NOT CONSIDERED FINAL</b> UNLESS ALL SIGNATURES COMPLETED	

MATCH LINE -L- STA 258 + 00.00  
SEE SHEET 7

MATCH LINE -L- STA 272 + 00.00  
SEE SHEET 9

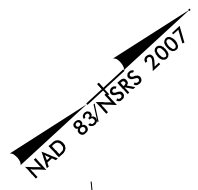
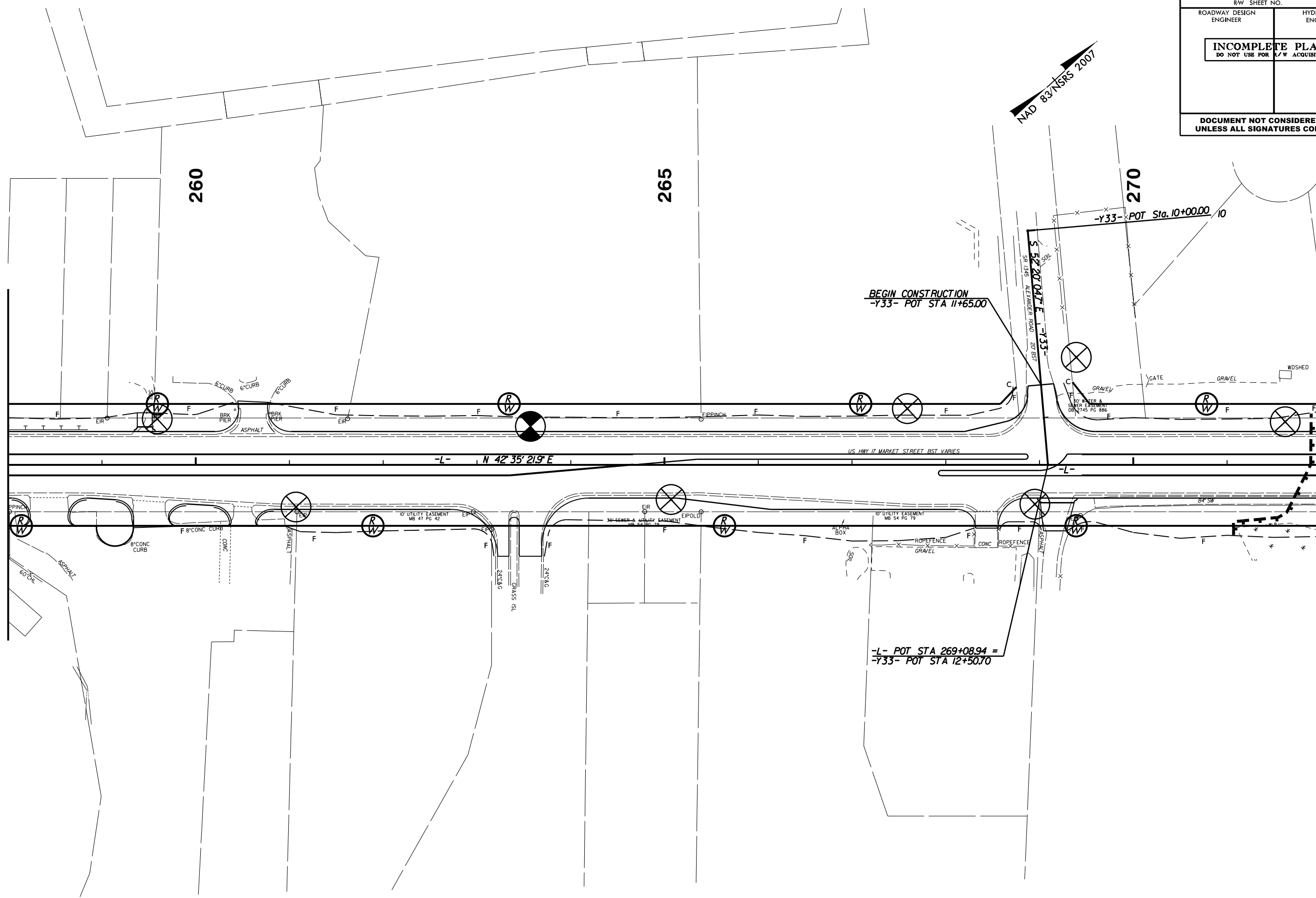

BEGIN CONSTRUCTION  
-Y33- POT STA 11+65.00

-L- POT STA 269+08.94 =  
-Y33- POT STA 12+50.70

-Y33- POT Sta. 10+00.00 / 10

-L- N 42° 35' 21.9\"/>

US HWY 17 MARKET STREET BST VARIES

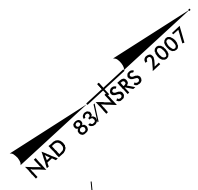
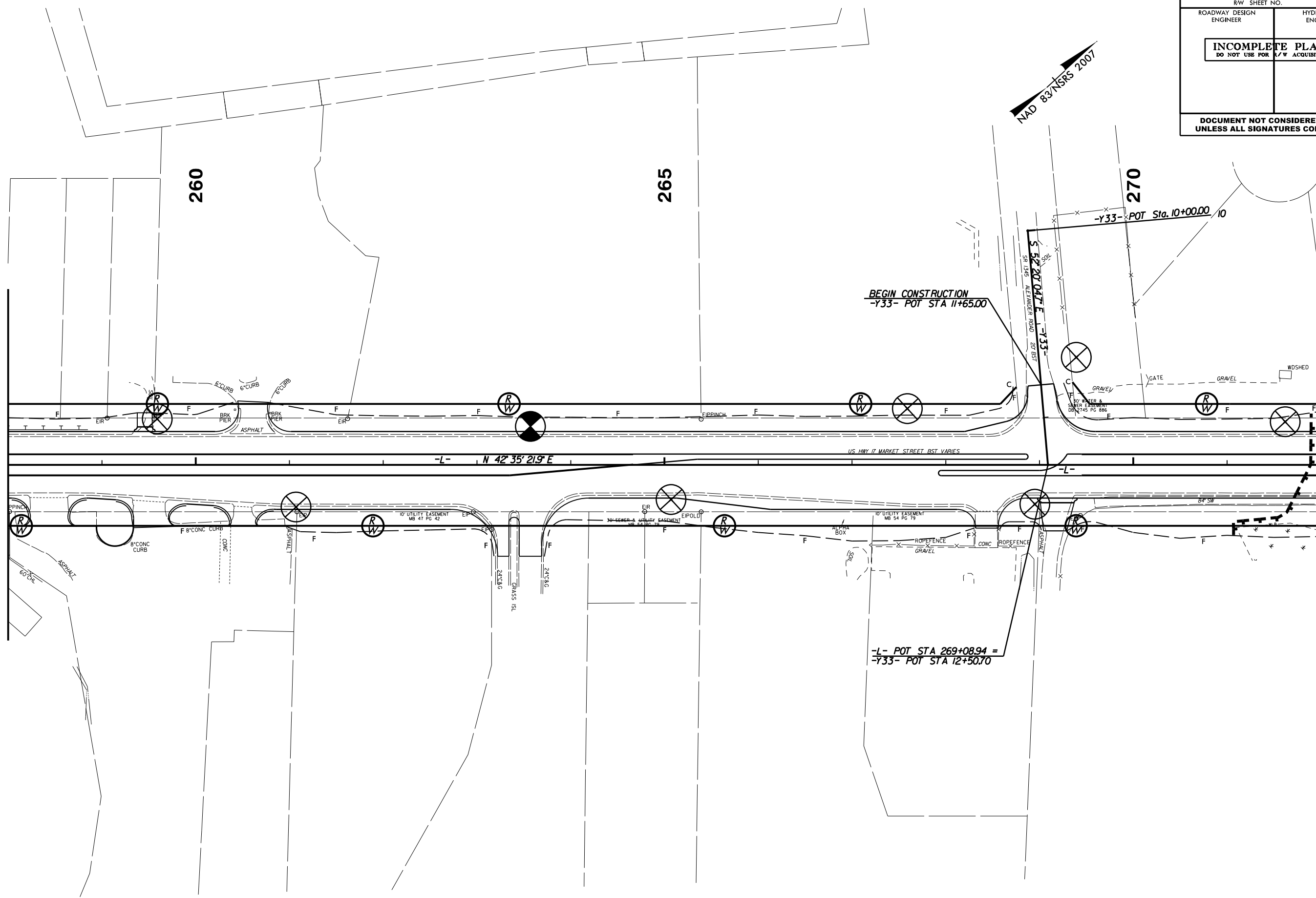

BEGIN CONSTRUCTION  
-Y33- POT STA 11+65.00

-L- POT STA 269+08.94 =  
-Y33- POT STA 12+50.70

-Y33- POT Sta. 10+00.00 / 10

-L- N 42° 35' 21.9\"/>

US HWY 17 MARKET STREET BST VARIES

25-MAY-2016 08:33  
 S:\pml\g\PROJECTS\2016\216032 NCDOT MARKET STREET U4902D.Lendire Rd. to Marsh Oaks\U4902D.GEO\RDWY\CADD\GEO\TECH\Site&Sub\U4902D\_GEO\_psh\_09.dgn  
 8/17/99

REVISIONS

MATCH LINE -L- STA 272 + 00.00  
 SEE SHEET 8

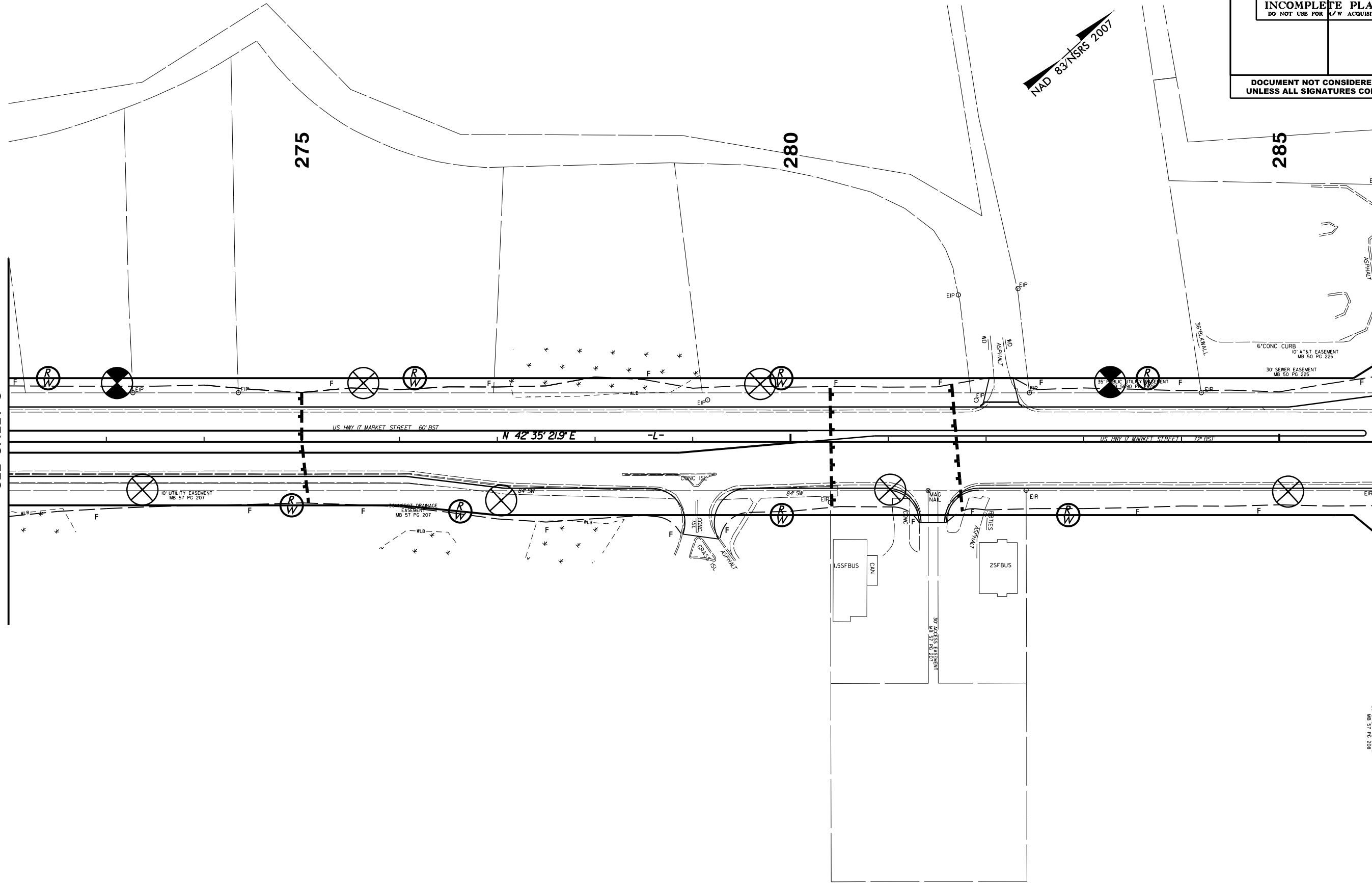

20' UTILITY EASEMENT  
 MB 57 PG 208

MATCH LINE -L- STA 286 + 00.00  
 SEE SHEET 10

PROJECT REFERENCE NO. U-4902D	SHEET NO. 9
RW SHEET NO.	
ROADWAY DESIGN ENGINEER	HYDRAULICS ENGINEER
<b>INCOMPLETE PLANS</b> DO NOT USE FOR R/W ACQUISITION	
<b>DOCUMENT NOT CONSIDERED FINAL</b> UNLESS ALL SIGNATURES COMPLETED	



PROJECT REFERENCE NO.	SHEET NO.
U-4902D	10
RW SHEET NO.	
ROADWAY DESIGN ENGINEER	HYDRAULICS ENGINEER
<b>INCOMPLETE PLANS</b> DO NOT USE FOR A/W ACQUISITION	
<b>DOCUMENT NOT CONSIDERED FINAL UNLESS ALL SIGNATURES COMPLETED</b>	



25-MAY-2016\_08:33  
 S:\wpmk\g\PROJECT\2016\216032 NCDOT MARKET STREET U4902D.Lendire Rd. to Marsh Oaks\U4902D.GEO.RDW\ACADD.GEOTECH\Site&Sub\U4902D.GEO\_psh\_10.dgn  
 8/17/99

REVISIONS

MATCH LINE -L- STA 286 + 00.00  
 SEE SHEET 9

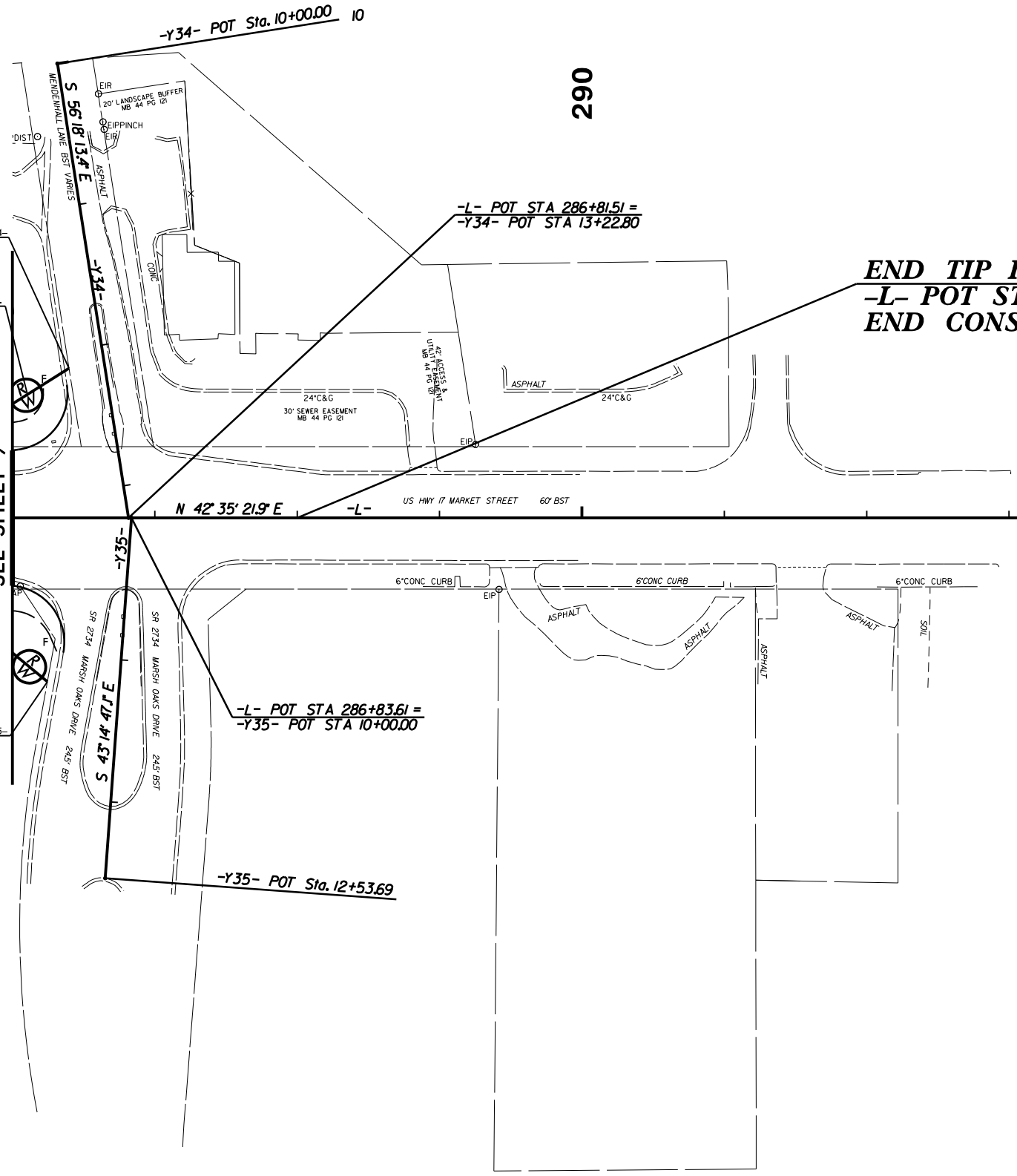

**END TIP PROJECT U-4902D**  
**-L- POT STA. 288 + 00.00**  
**END CONSTRUCTION**

290

295

SAMPLE NUMBER	OFFSET	STATION	DEPTH INTERVAL	AASHTO CLASS.	L.L.	P. I.	% BY WEIGHT				% PASSING SIEVES			% MOISTURE	% ORGANIC
							C. SAND	F. SAND	SILT	CLAY	10	40	200		
S-34	48 ft LT	202+43	3.0 - 5.0	A-3(0)	18	NP	37.7	53.6	2.5	6.2	98.8	91	9	-	4.1
SS-66	51 ft RT	204+96	3.5 - 5.0	A-2-4(0)	10	NP	33.6	50.3	7.7	8.4	99.9	93	16	-	2.8
S-35	38 ft LT	206+96	3.0 - 3.5	A-2-4(0)	13	NP	40.0	45.9	3.9	10.2	99.8	93	14	-	1.9
S-36	38 ft LT	206+96	3.5 - 4.0	A-3(0)	16	NP	40.6	51.1	2.1	6.1	99.0	88	9	-	0.5
S-37	45 ft LT	210+99	1.5 - 4.0	A-3(0)	20	NP	33.7	59.1	0.9	6.3	95.9	92	8	-	1.8
S-38	45 ft LT	210+99	4.0 - 7.0	A-3(0)	19	NP	40.5	53.8	0.5	5.2	94.9	90	6	-	1.8
S-41	81 ft RT	208+42	2.0 - 3.0	A-2-4(0)	14	NP	29.8	55.4	4.3	10.5	99.7	95	15	-	2.1
S-42	81 ft RT	208+42	3.8 - 4.9	A-2-4(0)	27	NP	20.6	69.0	3.8	6.6	99.9	97	11	-	4.0

5/14/99  
 25-MAY-2016 08:33  
 S:\pml\g\PROJECTS\2016\2169032 NCDOT MARKET STREET U4902D.Lendire Rd. to Marsh Oaks\U4902D-GEO.RDW\Y\CADD\_GEO\TECH\PlanProf\U4902C-GEO.plt.L.dgn  
 AT SITE PERMITS ONLY

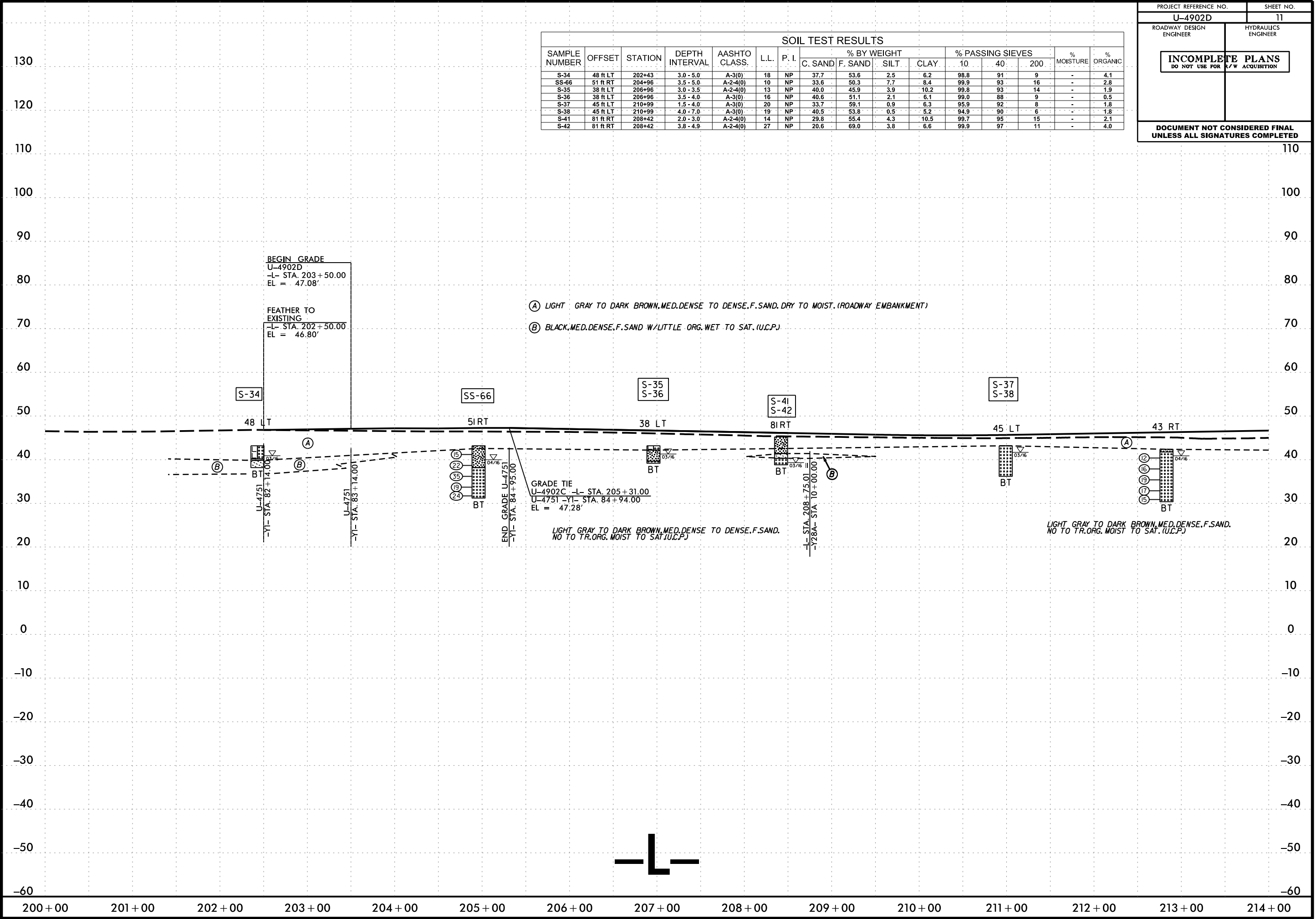

SAMPLE NUMBER	OFFSET	STATION	DEPTH INTERVAL	AASHTO CLASS.	L.L.	P. I.	% BY WEIGHT				% PASSING SIEVES			% MOISTURE	% ORGANIC
							C. SAND	F. SAND	SILT	CLAY	10	40	200		
							S-39	41 ft LT	215+01	0.0 - 3.0	A-3(0)	16	NP		
S-40	41 ft LT	215+01	3.0 - 5.5	A-3(0)	14	NP	37.5	58.9	0.6	3.0	98.6	92	4	-	1.2
S-43	37 ft LT	219+44	0.0 - 2.0	A-3(0)	19	NP	35.3	57.9	1.6	5.1	93.4	91	8	-	1.3
S-44	37 ft LT	219+44	2.0 - 6.0	A-3(0)	13	NP	48.9	46.5	0.5	4.2	99.5	88	5	-	-
S-45	29 ft RT	220+98	2.0 - 4.0	A-3(0)	15	NP	38.5	54.6	1.9	5.0	99.8	94	7	-	2.2
S-46	29 ft RT	220+98	4.0 - 5.5	A-4(0)	20	7	2.1	63.7	17.0	17.2	100	100	39	-	-
S-47	29 ft RT	220+98	5.5 - 6.5	A-7-6(17)	44	26	3.2	30.9	16.9	48.9	100	99	70	-	2.2
S-48	33 ft RT	224+98	0.0 - 6.0	A-3(0)	10	NP	26.0	69.1	0.7	4.2	99.8	97	5	-	-
S-74	48 ft RT	221+90	4.5 - 5.0	A-2-5(0)	72	NP	31.2	42.9	19.5	6.4	98.8	93	26	-	15.2

- (A) LIGHT GRAY TO DARK BROWN, MED. DENSE TO DENSE, F. SAND, DRY TO MOIST. (ROADWAY EMBANKMENT)
- (C) LIGHT GRAY, SOFT, SANDY SILT W/CLAY, SAT.
- (D) BLACK TO DARK BROWN, V. LOOSE TO LOOSE, HIGHLY ORGANIC SILTY, F. SAND, SAT. (MUCK)

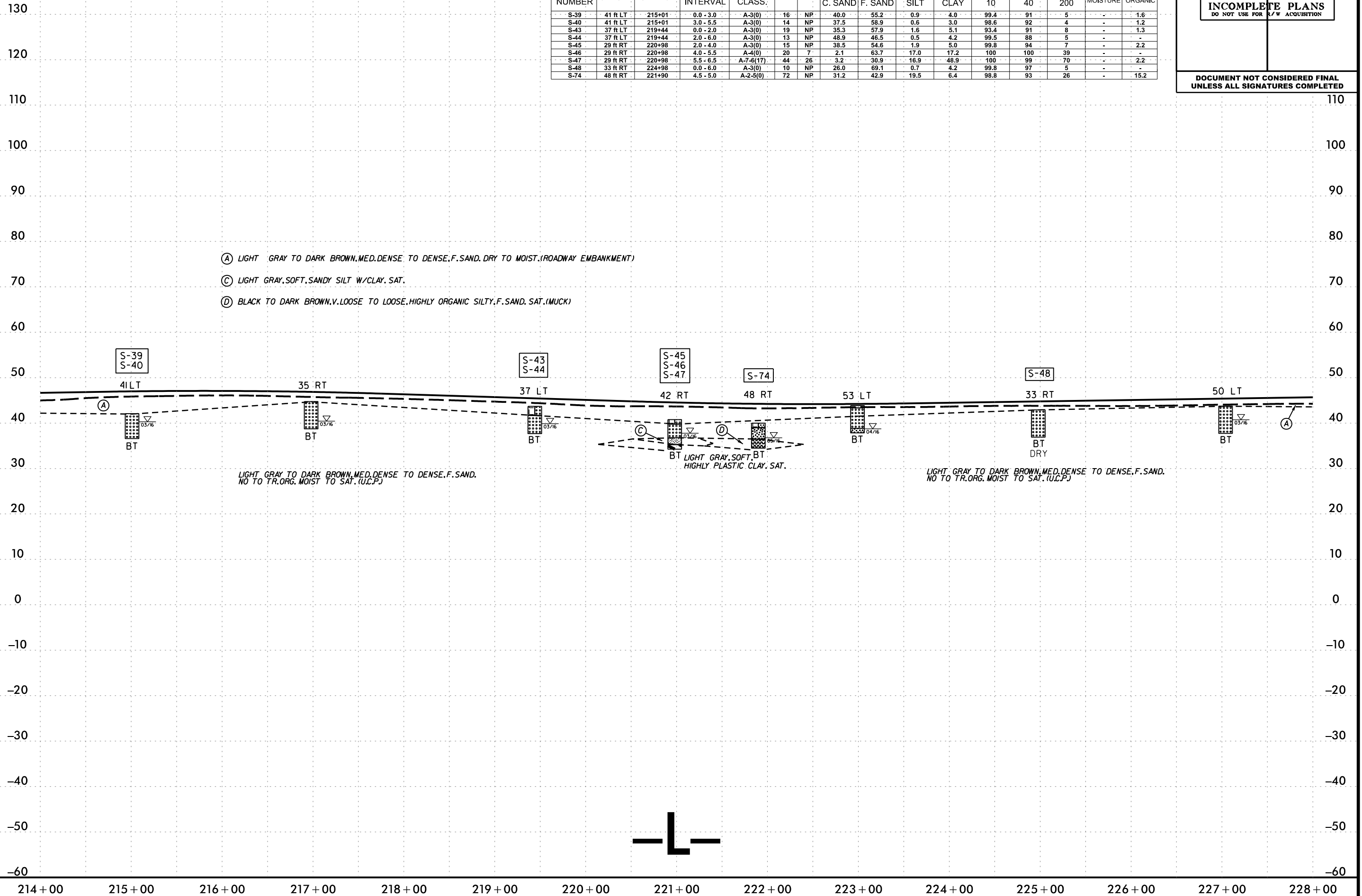

5/14/99  
 25-MAY-2016 08:33  
 S:\pmpk\g\PROJECT\2016\216032 NCDOT MARKET STREET U4902D.Lendire Rd. to Marsh Oaks\U4902D\_GEO\_RDWY\CADD\_GEO\TECH\PlanProf\PF\U4902C\_GEO.pfl.L.dgn  
 AT SITE PERMITS ONLY



SAMPLE NUMBER	OFFSET	STATION	DEPTH INTERVAL	AASHTO CLASS.	L.L.	P. I.	% BY WEIGHT				% PASSING SIEVES			% MOISTURE	% ORGANIC
							C. SAND	F. SAND	SILT	CLAY	10	40	200		
S-54	35 ft RT	228+68	2.5 - 3.3	A-3(0)	14	NP	26.6	67.7	0.7	5.0	100	97	6	-	1.2
S-55	35 ft RT	228+68	3.3 - 6.0	A-3(0)	13	NP	32.4	65.3	0.6	1.7	99.9	97	2	-	0.5
S-50	38 ft LT	238+95	0.0 - 6.0	A-3(0)	11	NP	17.8	78.1	0.1	4.0	99.3	97	4	-	1.4

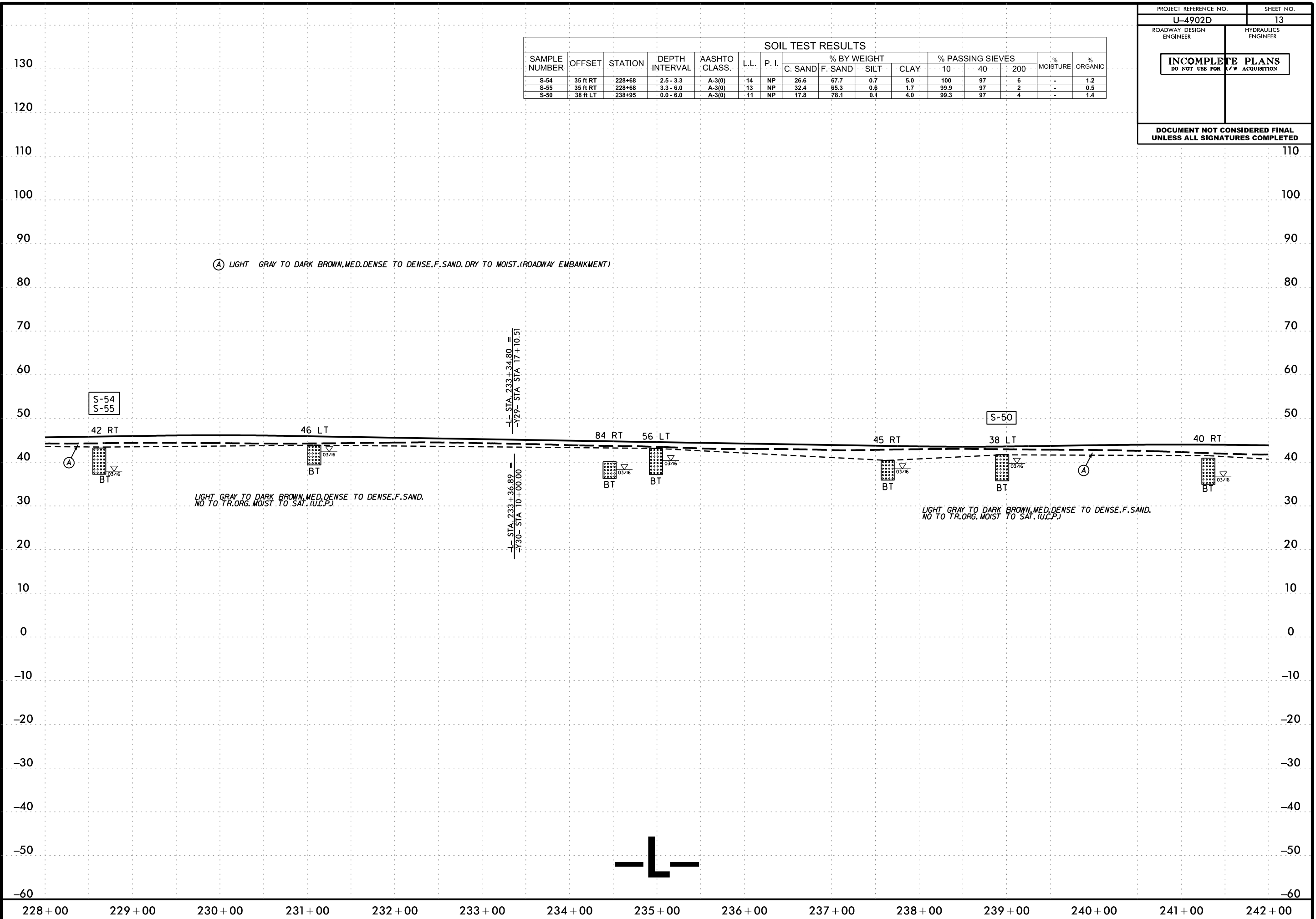

5/14/99  
 25-MAY-2016 08:33  
 S:\pmpk\g\PROJECT\2016\216032 NCDOT MARKET STREET U4902D.Lendire Rd. to Marsh Oaks\U4902D-GEO\_RDWY\CADD\_GEO\TECH\PlanProf\PF\U4902C-GEO\_pf1.L.dgn  
 AT: STEPHENSON



5/14/99  
 25-MAY-2016 08:33  
 S:\p\mk\g\PROJECT\2016\216032 NCDOT MARKET STREET U4902D.Lendire Rd. to Marsh Oaks\U4902D\_GEO\_RDWY\CADD\_GEO\TECH\PlanProf\PF\U4902C\_GEO\_pf1.L.dgn  
 AT SITE PERMITS ONLY

PROJECT REFERENCE NO.	SHEET NO.
U-4902D	15
ROADWAY DESIGN ENGINEER	HYDRAULICS ENGINEER
<b>INCOMPLETE PLANS</b> DO NOT USE FOR R/W ACQUISITION	
<b>DOCUMENT NOT CONSIDERED FINAL</b> <b>UNLESS ALL SIGNATURES COMPLETED</b>	

SAMPLE NUMBER	OFFSET	STATION	DEPTH INTERVAL	AASHTO CLASS.	L.L.	P. I.	% BY WEIGHT				% PASSING SIEVES			% MOISTURE	% ORGANIC
							C. SAND	F. SAND	SILT	CLAY	10	40	200		
S-53	39 ft RT	257+09	4.0 - 6.0	A-3(0)	12	NP	52.5	43.8	0.7	3.0	97.9	78	4	-	2.3
S-56	26 ft RT	265+07	0.0 - 1.0	A-2-4(0)	21	NP	4.5	83.0	4.9	7.7	98.9	99	24	-	-
S-57	26 ft RT	265+07	1.0 - 6.0	A-3(0)	11	NP	38.2	58.6	0.5	2.7	99.4	93	3	-	-

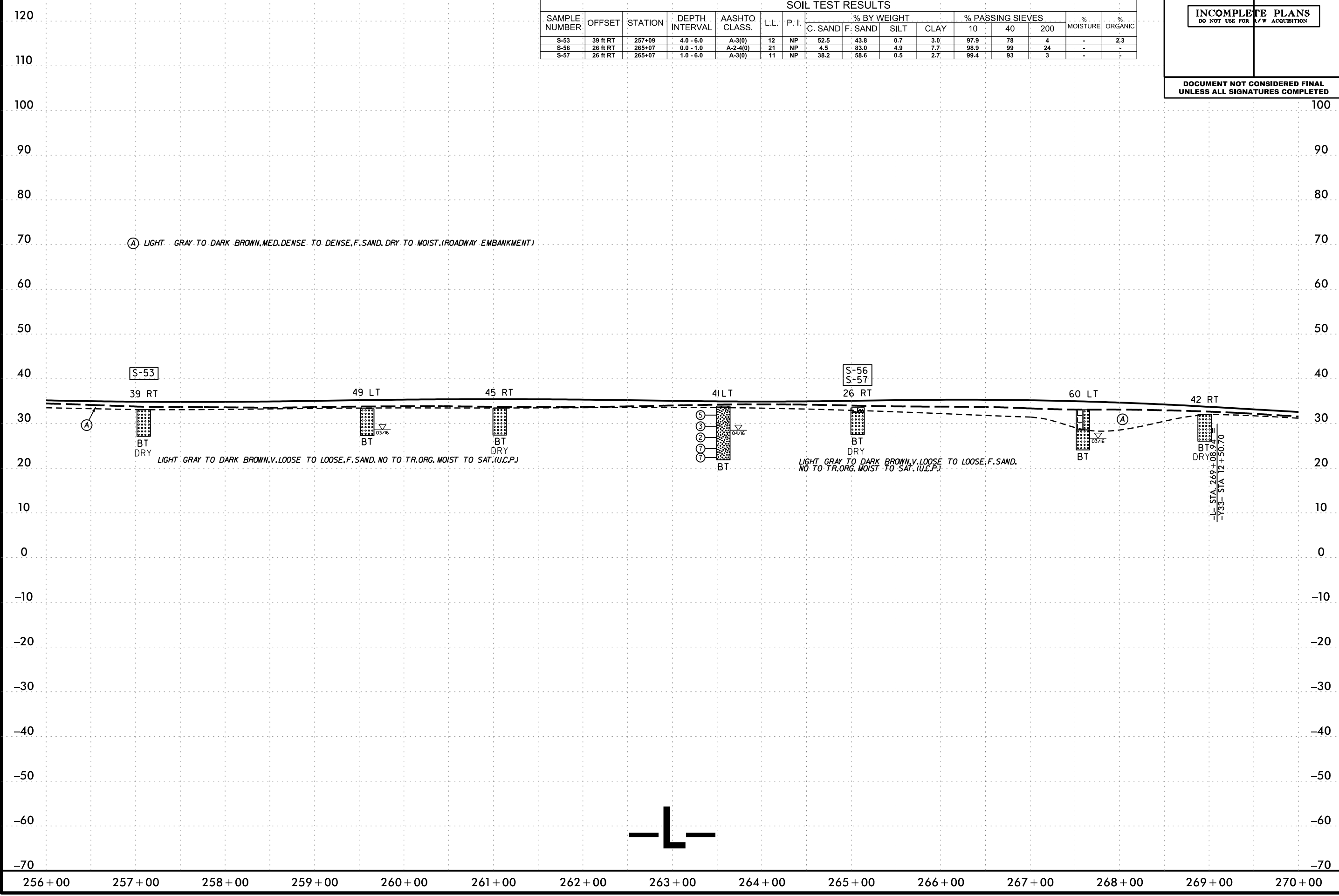

SAMPLE NUMBER	OFFSET	STATION	DEPTH INTERVAL	AASHTO CLASS.	L.L.	P. I.	% BY WEIGHT				% PASSING SIEVES			% MOISTURE	% ORGANIC
							C. SAND	F. SAND	SILT	CLAY	10	40	200		
SS-70	60 R LT	273+11	6.0 - 12.0	A-3(0)	12	NP	27.6	65.7	2.2	4.4	99.5	96	7	-	1.9
SS-71	60 R LT	273+11	13.5 - 15.0	A-3(0)	14	NP	26.4	65.0	4.2	4.4	99.8	96	9	-	3.1
S-58	60 R RT	277+04	4.0 - 4.5	A-3(0)	12	NP	27.9	66.3	0.8	5.0	99.9	96	6	-	1.3
S-59	60 R RT	277+04	4.5 - 7.0	A-3(0)	13	NP	24.6	70.9	1.8	2.7	100	98	5	-	0.6
S-60	49 R RT	281+02	4.0 - 5.5	A-2-4(0)	20	NP	38.2	48.7	5.4	7.7	99.5	91	14	-	5.5
S-61	49 R RT	281+02	5.5 - 7.0	A-3(0)	17	NP	53.7	39.4	0.6	6.3	94.1	84	7	-	1.6
SS-68	61 R LT	283+27	3.5 - 5.0	A-3(0)	9	NP	25.2	73.1	0.4	1.3	100	97	2	-	0.4

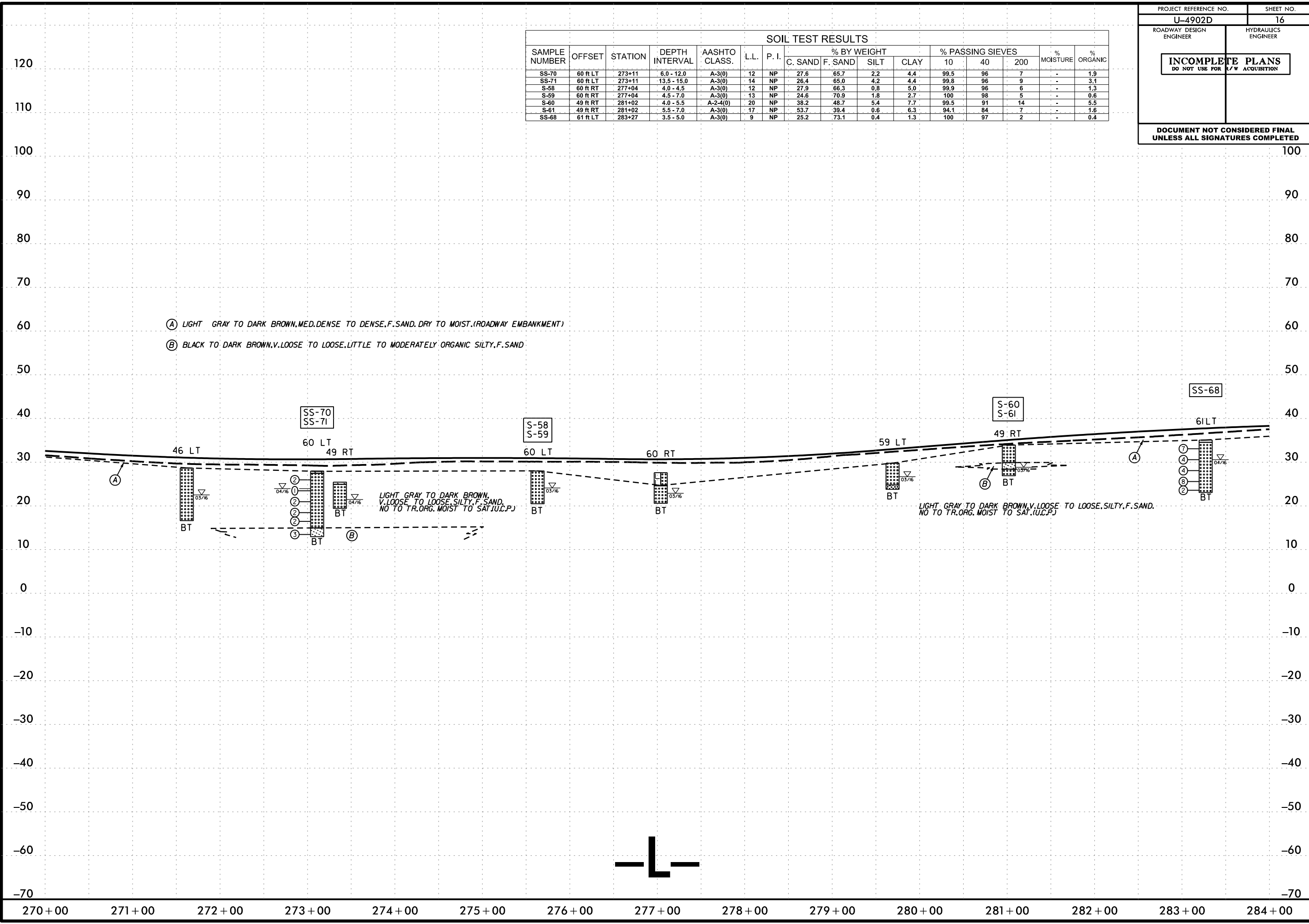

25-MAY-2016 08:33  
 S:\p\mk\g\PROJECT\2016\216032 NCDOT MARKET STREET U4902D.Lendire Rd. to Marsh Oaks\U4902D\_GEO\_RDWY\CADD\_GEO\TECH\Plan\Prof\U4902C\_GEO.pfl.LL.dgn  
 5/14/99

5/14/99  
 25-MAY-2016 08:33  
 S:\pmpk\g\PROJECT\_2016\216032 NCDDOT MARKET STREET U4902D.Lendire Rd. to Marsh Oaks\U4902D-GEO.FD\W\CADD\_GEO\TECH\Plan\Prof\U4902C-GEO.pf1.L.dgn  
 AT SITE VISITATION

PROJECT REFERENCE NO.	SHEET NO.
U-4902D	17
ROADWAY DESIGN ENGINEER	HYDRAULICS ENGINEER
<b>INCOMPLETE PLANS</b> DO NOT USE FOR R/W ACQUISITION	
<b>DOCUMENT NOT CONSIDERED FINAL</b> UNLESS ALL SIGNATURES COMPLETED	

SAMPLE NUMBER	OFFSET	STATION	DEPTH INTERVAL	AASHTO CLASS.	L.L.	P. I.	% BY WEIGHT				% PASSING SIEVES			% MOISTURE	% ORGANIC
							C. SAND	F. SAND	SILT	CLAY	10	40	200		
S-62	51 ft RT	285+09	0.0 - 1.0	A-3(0)	15	NP	25.7	71.6	0.7	2.0	99.9	97	3	-	-
S-63	51 ft RT	285+09	1.0 - 6.0	A-3(0)	10	NP	33.2	63.0	1.4	2.4	99.8	94	4	-	-

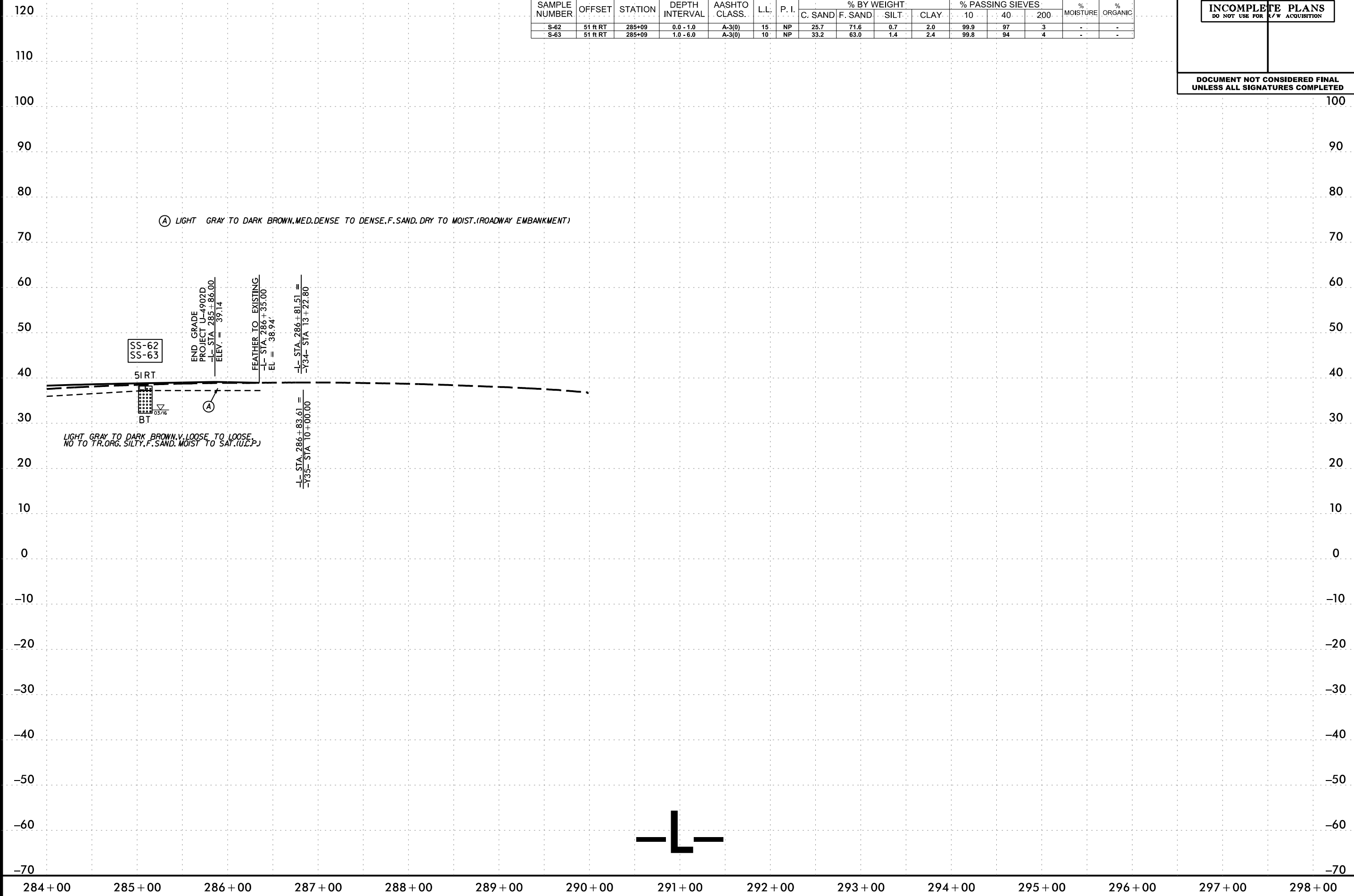

5/14/99  
 25-MAY-2016 08:33  
 S:\p\mk\g\PROJECT\2016\216932 NCDOT MARKET STREET U4902D.Lendire Rd. to Marsh Oaks\U4902D\_GEO\_RDWY\CADD\_GEOTECH\PlanProf\PF\U4902C\_GEO.pf.1\_Y29-Y34.dgn  
 AT SITE VISITATION

SAMPLE NUMBER	OFFSET	STATION	DEPTH INTERVAL	AASHTO CLASS.	L.L.	P. I.	% BY WEIGHT				% PASSING SIEVES			% MOISTURE	% ORGANIC
							C. SAND	F. SAND	SILT	CLAY	10	40	200		
S-67	42 ft RT	11+72	3.5 - 5.0	A-2-4(0)	31	NP	20.0	60.5	12.8	6.7	97.1	96	20	-	6.8
SS-69	20 ft LT	11+65	6.0 - 7.5	A-3(0)	10	NP	39.5	55.9	2.3	2.3	98.8	85	5	-	1.0
S-41	31 ft RT	10+82	2.0 - 3.0	A-2-4(0)	14	NP	29.8	55.4	4.3	10.5	99.7	95	15	-	2.1
S-42	31 ft RT	10+82	3.8 - 4.9	A-2-4(0)	27	NP	20.6	69.0	3.8	6.6	99.9	97	11	-	4.0

PROJECT REFERENCE NO. <b>U-4902D</b>	SHEET NO. <b>18</b>
ROADWAY DESIGN ENGINEER	HYDRAULICS ENGINEER
<b>INCOMPLETE PLANS</b> DO NOT USE FOR R/W ACQUISITION	
<b>DOCUMENT NOT CONSIDERED FINAL</b> UNLESS ALL SIGNATURES COMPLETED	

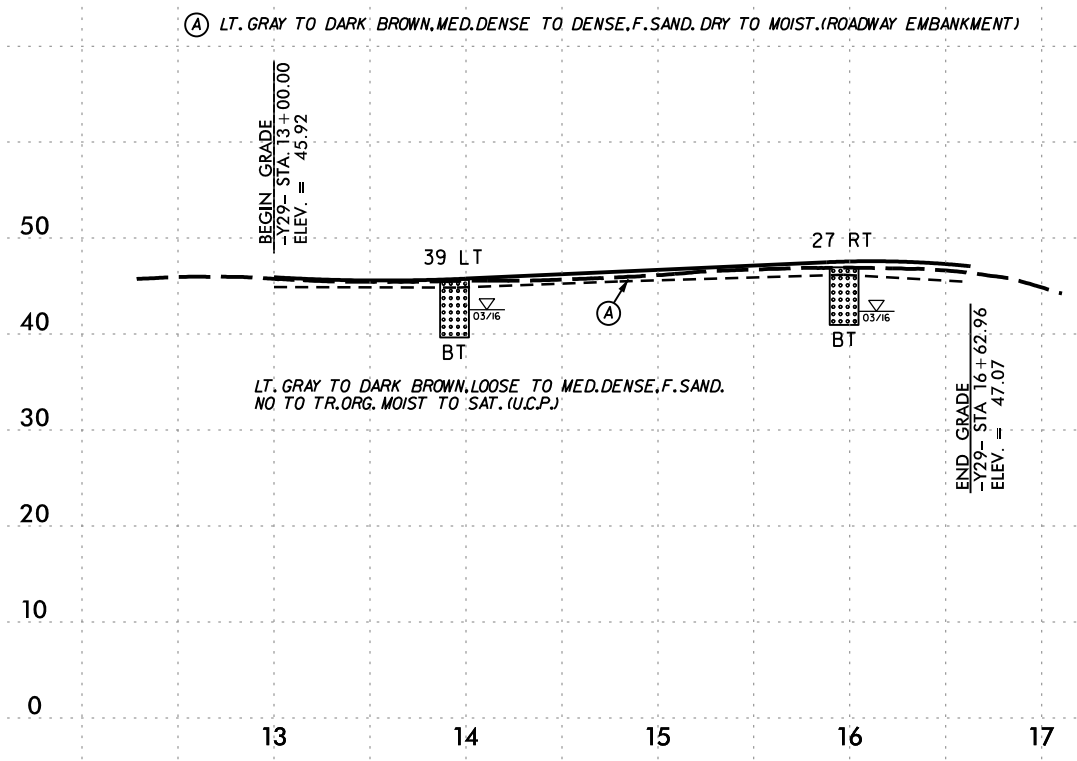

-Y29-

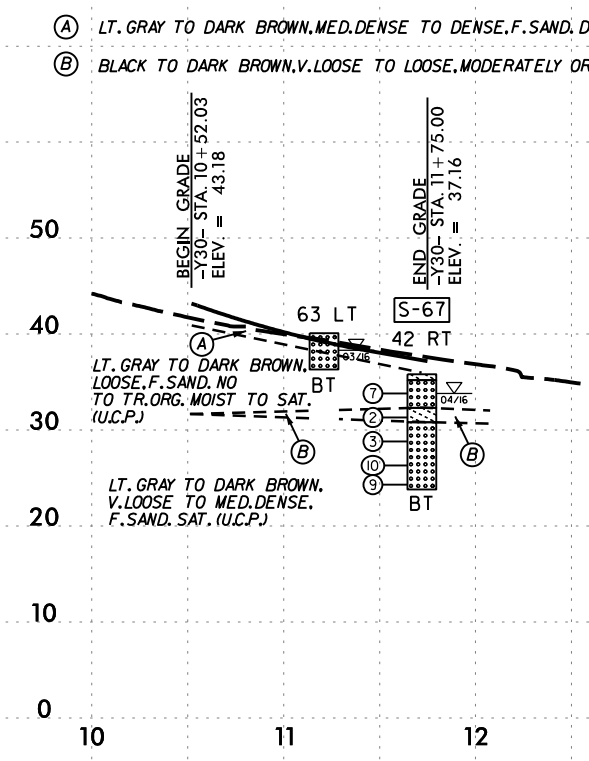

-Y30-

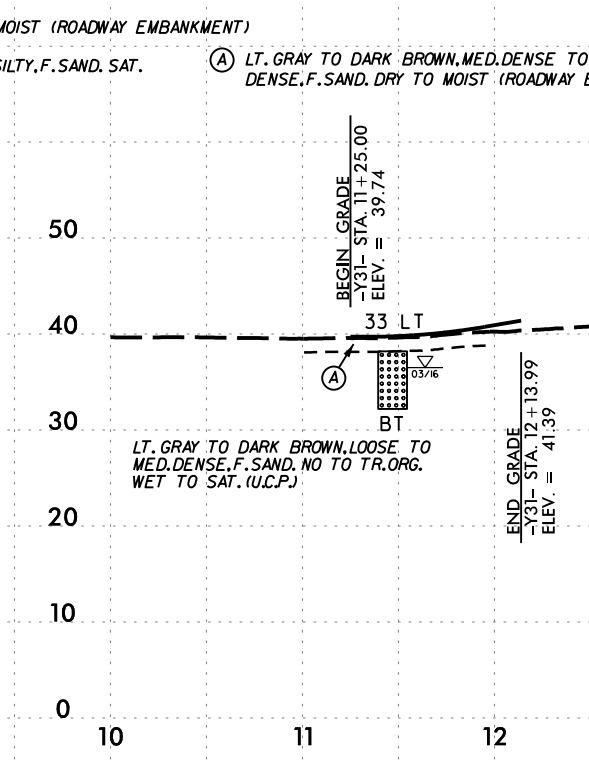

-Y31-

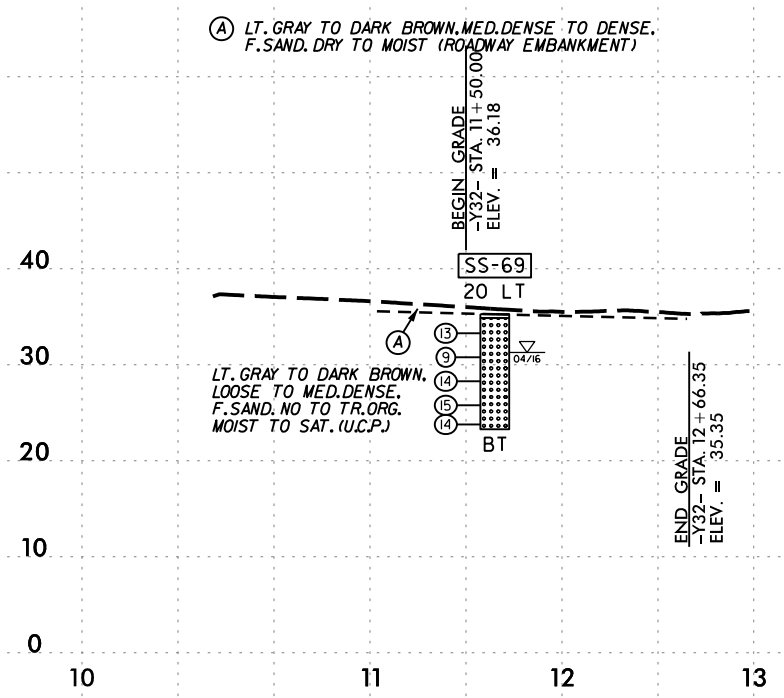

-Y32-

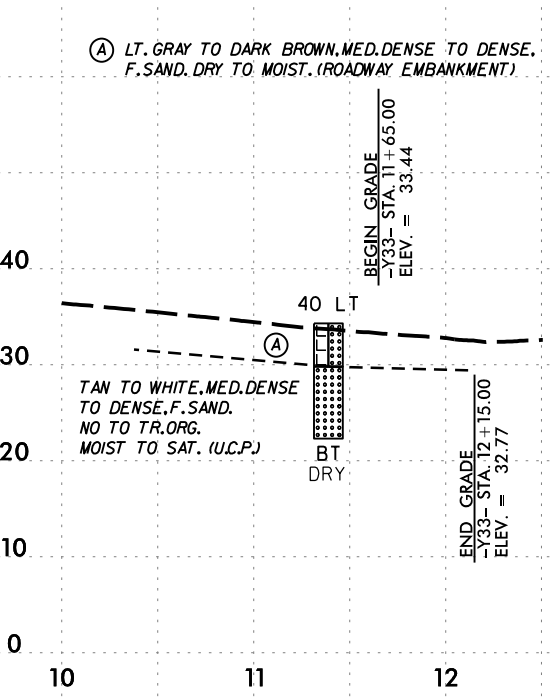

-Y33-

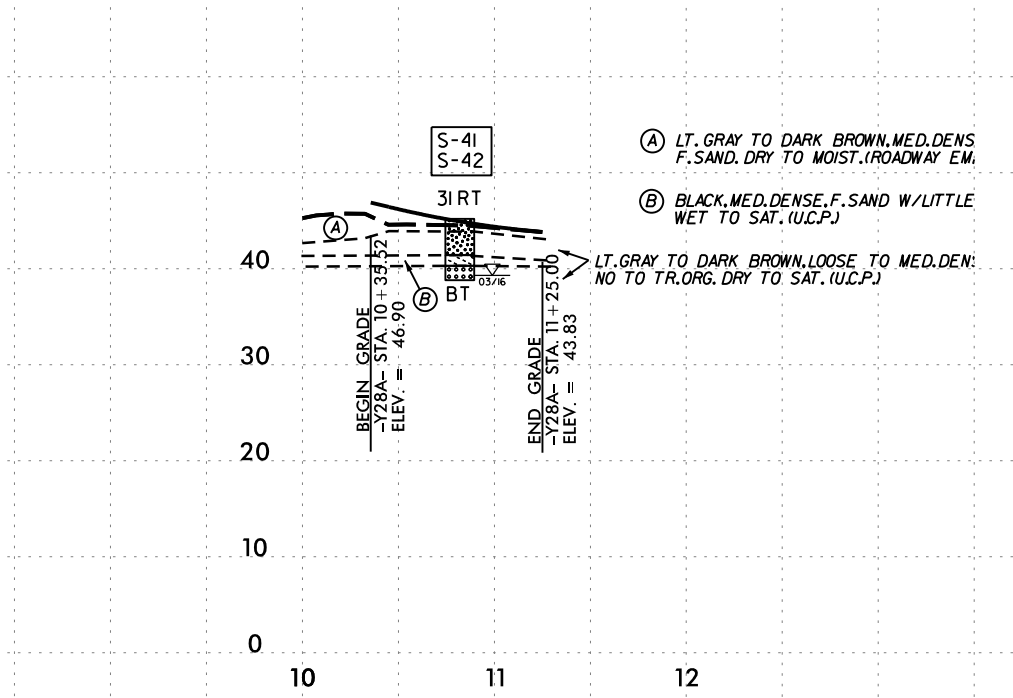

-Y28A-



Post Office Box 10279  
Wilmington, North Carolina 28404-0279

Telephone: (910) 452-5861  
Fax: (910) 452-7563

[www.catlinusa.com](http://www.catlinusa.com)

May 15, 2017

MEMORANDUM TO: John L. Pilipchuk, LG, PE  
State Geotechnical Engineer

FROM: Ben D. Lackey Jr, PE  
CATLIN Senior Geotechnical Engineer

STATE PROJECT: 40238.1.4 (U-4902D)  
F.A. NUMBER: NHS-0017(76)  
COUNTY: NEW HANOVER

DESCRIPTION: US 17 Business (Market Street) from Lendire Road to Marsh Oaks Drive

SUBJECT: Geotechnical Report Addendum – Ground Improvement

CATLIN Engineers and Scientists (CATLIN) have completed a subsurface investigation and recommendations addendum to address the long term settlement and slope stability in the area listed below.

<u>Line</u>	<u>Station +/-</u>
-L-	277+47 to 279+77

CATLIN recommends the use of lightweight aggregate embankment with high strength fabric for embankment stabilization for the proposed roadway embankment and as a replacement for the existing roadway embankment in this area.

1. Fabric for Embankment Stabilization

The fabric for the embankment stabilization shall be installed in the following area, as shown on the detail plan, prior to placement of the lightweight aggregate embankment fill. Fabric for embankment construction shall meet the requirements of the attached “Fabric for Embankment Stabilization” special provision. Recommend a quantity of 3,650 square yards of Fabric for Embankment Stabilization in the contract.

<u>Line</u>	<u>Station +/-</u>
-L-	277+47 to 279+77

2. Removal of the existing Roadway Embankment

The existing roadway embankment shall be removed from the following area.

<u>Line</u>	<u>Station +/-</u>
-L-	277+47 to 279+77

Recommend 3,100 cubic yards of suitable unclassified excavation be included in the contract. Use of suitable unclassified excavation material shall meet the requirements of the attached “Special Handling of Unclassified Excavation” special provision.

3. Lightweight Aggregate

Lightweight aggregate shall be used to construct the proposed embankment to subgrade from -L- Station 277+47 ± to 279+77 ±. Lightweight aggregate for construction shall meet the requirements of the attached “Lightweight Aggregate” special provision. Include a quantity of 3,000 tons of Lightweight Aggregate in the contract.

4. Shoulder and Slope Material

The fill slope material should be placed to a height of 1 foot on the roadway side slopes which are formed with lightweight aggregate. Material for fill slope shall meet the requirements of the attached “Shoulder and Fill Slope Material” project special provision. Recommend 275 cubic yards of borrow excavation should be included in the contract.

5. Fabric for Soil Stabilization

The fabric for soil stabilization shall be installed between the lightweight aggregate embankment. Include 7,300 square yards of Fabric for Soil Stabilization in the contract to be used in the following sections, as shown on the detail plan.

<u>Line</u>	<u>Station +/-</u>
-L-	277+47 to 279+77



5. Attachments

- Quantity Summary
- Special Provisions
  
- 1. Fabric for Embankment Stabilization
- 2. Lightweight Aggregate
- 3. Shoulder and Fill Slope Material
- 4. Special Handling of Unclassified Excavation
  
- Plan Sheet
  
- 1. Lightweight Aggregate Embankment Detail Plan (1 sheet)

Prepared By:



Lee Stone, P.G.  
CATLIN Senior Geologist



Ben D. Lackey Jr. P.E.  
CATLIN Geotechnical Engineer

**Quantity Summary**

<b><u>Item Number</u></b>	<b><u>Description</u></b>	<b><u>Quantity</u></b>	<b><u>Comment</u></b>
	Fabric for Embankment Stabilization (SP)	3,650 SY	See Section 1
	Special Handling of Unclassified Excavation (SP)	3,100 CY	See Section 2
	Lightweight Aggregate (SP)	3,000 TON	See Section 3
0106000000-E	Borrow Excavation for Shoulder and Fill Slope Material	275 CY	See Section 4
0196000000-E	Fabric for Soil Stabilization	7,300 SY	See Section 5

**FABRIC FOR EMBANKMENT STABILIZATION****DESCRIPTION:**

This work consists of furnishing and installing synthetic fabric for stabilizing embankment in accordance with this provision or as directed by the Engineer. The work shall include maintaining the fabric in the required configuration until completion and acceptance of overlying work items. The fabric shall be placed at the locations shown in the plans or as directed by the Engineer.

**MATERIAL:**

The fabric material for embankment stabilization shall be made of high-tenacity polyester in the machine direction with a plain straight weave pattern and polyester or polypropylene in the cross direction or approved equal. The fabric shall be composed of strong rot-proof synthetic fibers formed into a fabric of the woven type. The fabric shall be free of any treatment or coating which might significantly alter its physical properties after insulation.

The fabric shall contain stabilizers and/or inhibitors to make the filaments resistant to deterioration resulting from ultraviolet or heat exposure. The fabric shall be a pervious sheet of synthetic fibers oriented into a stable network so that the fibers retain their relative positions with respect to each other. The edges of the fabric shall be furnished to prevent the outer yarn from pulling away from the fabric. The fabric shall be free of defects or flaws which significantly affect its physical and/or filtering properties. Sheets of fabric shall be sewn together with a seam that furnishes the required minimum strengths. The seam thread shall be made of synthetic fibers which are resistant to deterioration, as are the fabric fibers. Lamination of fabric sheets to produce the physical requirements of a fabric layer will not be accepted.

During all periods of shipment and storage, the fabric shall be wrapped in a heavy duty protective covering to protect the fabric from direct sunlight ultraviolet rays, mud, dust, dirt, and debris. The fabric shall not be exposed to temperatures greater than 140°F. After the protective wrapping has been removed, the fabric shall not be left uncovered under any circumstances for longer than one (1) week.

The fabric shall meet the following requirements:

All values represent minimum average roll values (any roll in a lot should meet or exceed the minimum values in this table).

<u>Fabric Property</u>	<u>Test Method</u>	<u>Requirements</u>
Min. Puncture Strength	ASTM D-4833	135 lbs
Min. Bursting Strength	ASTM D-3786	600 psi
Trapezoid Tear	ASTM D-4533	135 lbs
AOS, US STD Sieve	ASTM D-4751	20-70
Seams, Strength Cross Machine Direction Only	ASTM D-4884	500 lbs/ft
Ultraviolet (UV) % Strength Retained	ASTM D-4355	30%
Permeability	ASTM D-4491	.002 in/sec
Tensile Strength at 5% Strain	ASTM D-4595 (Wide Strip Test)	Machine Direction 8000 lbs/ft
Ultimate Tensile Strength	ASTM D-4595 (Wide Strip Test)	Machine Direction 20000 lbs/ft

The Contractor shall furnish certified reports by an approved independent testing laboratory with each shipment of material attesting that the fabric meets the requirements of this provision; however, the material shall be subject to inspection, test, or rejection by the Engineer at any time. The Contractor shall furnish the Engineer certified test reports by an approved independent testing laboratory attesting that the sewn seam provides the required strength.

The Contractor shall furnish and place over the embankment stabilization fabric as shown in the plan or as directed by the Engineer.

CONSTRUCTION METHODS:

The fabric for embankment stabilization shall be placed at locations shown in the plans or as directed by the Engineer. The locations should be cleared and free of obstructions, debris, and pockets. Stumps shall be cut smooth at the ground elevation with the root system left intact. At the time of installation, the fabric shall be rejected if it had defects, rips, holes, flaws, deterioration, or damage incurred during manufacture, transportation, or storage.

The fabric for embankment stabilization shall be placed with the machine direction as shown on the plans or as directed by the Engineer. Fabric shall be laid smooth and free from tension, stress folds, wrinkles, or creases. All joints parallel to the machine direction shall be sewn by an approved method to develop the required seam strength. All sewn seams shall be placed facing upwards to allow for inspection. No seams will be allowed perpendicular to the machine direction. The lightweight aggregate should be placed and compacted using low ground pressure equipment as directed by the Engineer. All fabric which is damaged as a result of installation will be required to be replaced or repaired at the direction of the Engineer with no additional cost to the Department. Compaction equipment shall be such that it will not harm the fabric.

A lightweight aggregate layer at a depth shown in the plan or as directed by the Engineer shall be placed over the geosynthetic layer. End dumping fill directly on the fabric is not permitted. Spreading and compaction of lightweight aggregate with low ground pressure (<4 psi) equipment is required until 2 feet of lightweight fill has been placed.

Any fabric which is damaged as a result of installation or which is left uncovered for longer than one week after placement shall be replaced at no additional cost to the Department.

METHOD OF MEASUREMENT

The quantity of fabric to be paid for will be the number of square yards of "Fabric for Embankment Stabilization" measured along the surface of the ground which has been acceptably placed. No separate measurement will be made of overlapping fabric.

BASIS OF PAYMENT:

The quantity of fabric, measured as provided above, will be paid for at the contract unit price per square yard for "Fabric for Embankment Stabilization". Such price and payment will be full compensation for furnishing, hauling, placing, compaction, and all incidentals necessary to complete the work.

Pay Item:      Fabric for Embankment Stabilization.....Square Yard

**LIGHTWEIGHT AGGREGATE****(SPECIAL)****GENERAL:**

Furnish and place lightweight aggregate as shown on the plans, according to this provision, and as directed by the Engineer. Use ESCS (Expanded Shale Clay Slate) produced by the rotary kiln method conforming to ASTM C-330 (latest edition).

**MATERIAL PROPERTIES:**

Lightweight aggregate must have a proven record of durability, and be non-corrosive, with the following properties:

- Contains a maximum organic content of 0.1%
- Soundness Loss (AASHTO T104): Have a maximum soundness loss of less than 30% when subjected to four cycles of Magnesium Sulfate.
- Abrasion Resistance (ASTM C131): Have a maximum percentage of abrasion loss of less than 40%.
- Chloride Content (AASHTO T291): Have a chloride content of less than 100 ppm.
- Gradation (ASTM 136): use an aggregate gradation from ¾" to #4. Other gradations may be acceptable with approval of the Engineer.
- Aggregate loose unit weight (ASTM C29): Have a loose unit weight less than 55 lbs/ft<sup>3</sup>.
- In-place unit weight (ASTM D4253, D4254): Have an in-place compacted dry unit weight between 55 and 60 lbs/ft<sup>3</sup>. Material must be compacted to a minimum 65% relative density as determined by ASTM D4253 and D4254. Use a vibratory table when determining the maximum index density and unit weight in accordance with ASTM D4253. Determine the minimum index density and unit weight in accordance with ASTM D4254.
- Angle of Internal Friction (ASTM D3080): Minimum angle of internal friction of 40 degrees. Test a saturated representative sample (with particles larger than 0.75 inch removed) in a round or square shear box that is a minimum of 12 inches across.
- Resistivity (ASTM D1125): Have a resistivity greater than 3000 ohm-cm.
- pH (ASTM D1293): Have a pH greater than five but less than 10.



**SHOULDER AND FILL SLOPE MATERIAL:****(SPECIAL)**

DESCRIPTION: Perform the required shoulder and slope construction for this project in accordance with the applicable requirements of Section 560 and Section 235 of the 2006 *Standard Specifications* except as follows:

Construct the top 12 inches of shoulder and fill slopes with soils capable of supporting vegetation.

Provide soil with a P. I. greater than 6 and less than 25 and with a pH ranging from 5.5 to 6.8. Remove stones and other foreign material 2 inches or larger in diameter. All soil in subject to test and acceptance or rejection by the Engineer.

Obtain material from within the project limits or approved borrow source.

COMPENSATION: When the Contractor elects to obtain material from an area located beneath a proposed fill sections which does not require excavation for any reason other than to generate acceptable shoulder and fill material, the work of performing the excavation will be considered incidental to the item of *Borrow Excavation* or *Shoulder Borrow*. If there is no pay item for Borrow or Shoulder Excavation in the contract, this work will be considered incidental to *Unclassified Excavation*. Stockpile the excavated material in a manner to facilitate measurement by the Engineer. Fill the void created by the excavation of the shoulder and fill slope material with suitable material. Payment for material used from the stockpile will be made at the contract unit price for *Borrow Excavation* or *Shoulder Borrow*. If there is no pay item for *Borrow Excavation* or *Shoulder Borrow*, then the material will be paid for at the contract unit price for *Unclassified Excavation*. The material used to fill the void created by the excavation of the shoulder and fill slope material will be made at the contract unit price for *Unclassified Excavation*, *Borrow Excavation*, or *Shoulder Borrow*, depending on the source of the material.

Material generated from undercut excavation, unclassified excavation, or clearing and grubbing operations that is placed directly on the shoulders or slope areas, will not be measured separately for payment, as payment for work requiring the excavation will be considered adequate compensation for depositing and grading the material on the shoulder slopes.

When undercut excavation is performed at the direction of the Engineer and the material excavated is found to be suitable for use as shoulder and fill slope material, and there is no area on the project currently prepared to receive the material generated by the undercut operation, the Contractor may construct a stockpile for use as borrow at a later date. Payment for the material used from the stockpile will be made at the contract unit price for *Borrow Excavation* or *Shoulder Borrow*.



When shoulder material is obtained from the borrow sources or from stockpiled material, payment for the work of shoulder construction will be made at the contract unit price per cubic yard for *Borrow Excavation* or *Shoulder Borrow* in accordance with the applicable provisions of Section 230 or Section 560 of the 2006 *Standard Specifications*.

**SPECIAL HANDLING OF UNCLASSIFIED EXCAVATION****(SPECIAL)****GENERAL**

Use any suitable unclassified excavation material removed from the excavation from the stations listed below in accordance with NCDOT Standard Specification 225, except the material shall not be used in the top 3 feet of the proposed embankment or backfill. These soils may be utilized in areas outside the pavement section or in lower portions of high fills at the discretion of the Engineer.

<u>Line</u>	<u>Station +/-</u>
-L-	277+47 to 279+77

GEOTECHNICAL ENGINEER

ENGINEER

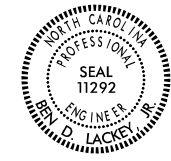

SIGNATURE DATE

SIGNATURE DATE

DOCUMENT NOT CONSIDERED FINAL UNLESS ALL SIGNATURES COMPLETED

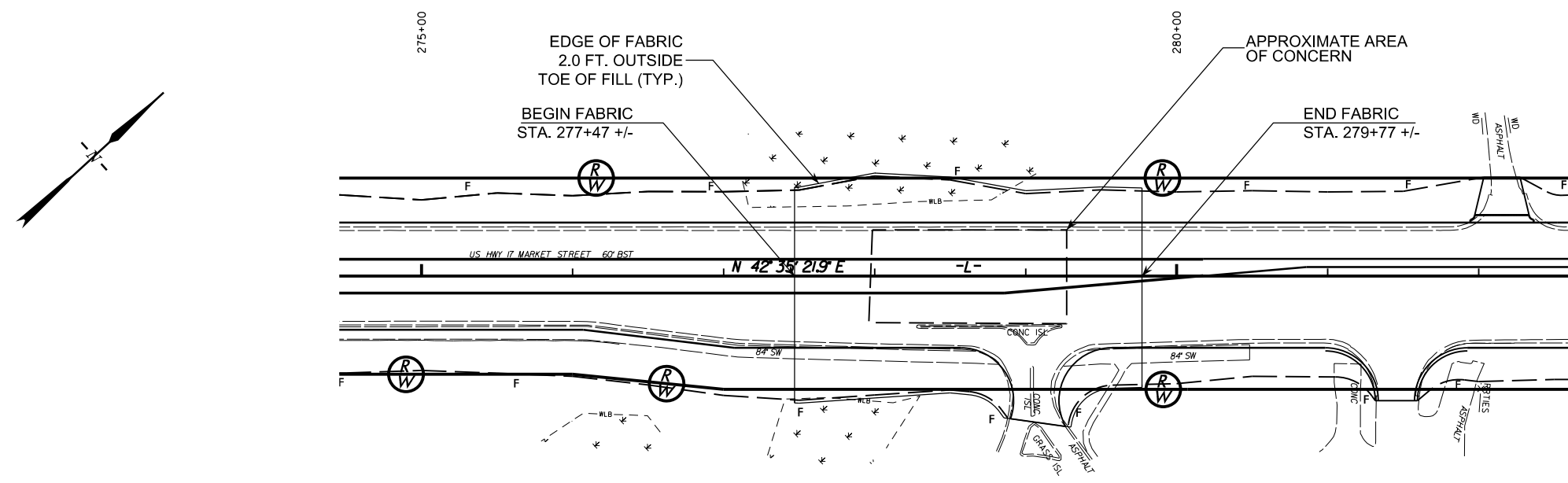

FABRIC FOR EMBANKMENT STABILIZATION LAYOUT  
NOT TO SCALE

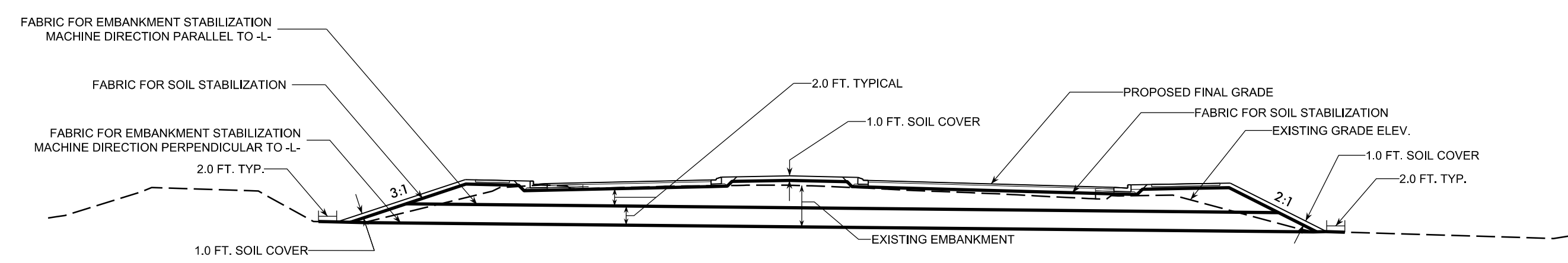

TYPICAL SECTION  
NOT TO SCALE

PREPARED BY: Steve Hudson, P.G.	DATE: 3/30/17
REVIEWED BY: Ben Lackey, P.E.	DATE: 5/16/17

Prepared in the Office of:

**CATLIN**  
Engineers and Scientists  
Wilmington, North Carolina

NORTH CAROLINA  
DEPARTMENT OF TRANSPORTATION  
DIVISION OF HIGHWAYS  
**GEOTECHNICAL ENGINEERING UNIT**

LIGHTWEIGHT AGGREGATE FILL EMBANKMENT

REVISIONS					
NO.	BY	DATE	NO.	BY	DATE
1			3		
2			4		



PAT McCRORY  
Governor

NICHOLAS J. TENNYSON  
Secretary

June 13, 2016

MEMORANDUM TO: David Leonard, P.E.  
DDC Engineer – Division 3

FROM: Kyung Kim, P.E. *K.J. Kim*  
Eastern Regional Geotechnical Manager

STATE PROJECT: 40238.1.4 (U-4902D)  
FEDERAL PROJECT: NHS-0017(76)  
COUNTY: New Hanover

DESCRIPTION: US 17 Business (Market Street) from Lendire Road SR 2734  
(Marsh Oaks Drive)

SUBJECT: Roadway Subsurface Inventory Report and Roadway Design  
Recommendations Report

The Geotechnical Engineering Unit has reviewed and presents the following report prepared by Catlin Engineers & Scientists for the above referenced project.

Roadway Subsurface Inventory Report: 20 pages  
Roadway Design Recommendations Report: 5 pages

Please call Dean N Argenbright, L.G. at (252) 355-9054 or Majid Khazaei, P.E. at (919) 662-4710 if there are any questions concerning this memorandum.

Attachment KJK/DNA/MK

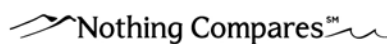



Post Office Box 10279  
Wilmington, North Carolina 28404-0279

Telephone: (910) 452-5861  
Fax: (910) 452-7563

[www.catlinusa.com](http://www.catlinusa.com)

June 13, 2016

MEMORANDUM TO: John L. Pilipchuk, LG, PE  
State Geotechnical Engineer

FROM: Steven V. Hudson, LG  
CATLIN Geotechnical Geologist

STATE PROJECT: 40238.1.4 (U-4902D)  
F.A. NUMBER: NHS-0017(76)  
COUNTY: NEW HANOVER

DESCRIPTION: US 17 Business (Market Street) from Lendire Road to Marsh  
Oaks Drive

SUBJECT: Geotechnical Report – Design and Construction  
Recommendations

CATLIN Engineers and Scientists (CATLIN) has completed a subsurface investigation for this project and presents the following recommendations:

**I. SLOPE/EMBANKMENT STABILITY**

A. Slope Design

Recommend roadway side slopes be constructed no steeper than 3:1 (H:V) in order to assist in erosion control and establish vegetation.

B. Undercut (Soft Foundation Soils)

Include 200 cubic yards in the contract as a contingency item to be used at the discretion of the Engineer.

C. Geotextile for Soil Stabilization

Include 200 square yards of fabric for soil stabilization in the contract as a contingency item to be used at the discretion of the Engineer.

## II. SUBGRADE STABILITY

### A. Subsurface Drainage – Subsurface Drains

Recommend including 200 linear feet of subdrain pipe (Roadway Standard Drawing 815.02) in the contract as a contingency item to be used at the discretion of the Engineer.

### B. Undercut for Subgrade Stability

Include 200 cubic yards in the contract as a contingency item to be used at the discretion of the Engineer.

### C. Aggregate Subgrade

Include 100 cubic yards of shallow undercut for aggregate subgrade in the contract as a contingency item to be used at the discretion of the Engineer.

### D. Geotextile for Soil Stabilization

Recommend contingency of 200 square yards of soil stabilization fabric to be used for subgrade stability as outlined in Section II.B.

Recommend 300 square yards be included in the contract for soil stabilization as a contingency item for use with aggregate subgrade as outlined in Section II.C.

Recommend an additional 200 square yards for soil stabilization be included in the contract as a contingency item to be used at the discretion of the Engineer.

## III. BORROW SPECIFICATIONS

### A. Borrow Criteria

Common borrow for embankment construction to subgrade shall meet Coastal Plain specifications outlined in the Standard Specifications, Article 1018-2, Section II.

### B. Select Granular Material

Recommend 400 cubic yards of Select Granular Material be included as a contingency in the contract for backfill as detailed in Sections I.B and II.B.

Recommend 200 cubic yards of Select Granular Material, Class II and/or III to be included in the contract as a contingency item. Select granular material for embankment/backfill for geotextile for soil stabilization if required, or backfill in

water shall meet the criteria outlined in the Standard Specifications, Article 1016-3, Class II and/or III.

C. Shrinkage Factor

A shrinkage factor of 25 percent is recommended for calculation of earthwork in the contract.

D. Borrow Reconnaissance and Availability

Sandy soils with good to excellent engineering properties are available in nearby areas.

E. Class IV Subgrade Stabilization Material

A quantity of 190 tons of Class IV subgrade stabilization material should be included in the project contract as backfill for the Aggregate Subgrade referenced in Section II.C. The material should meet the requirement of Standard Specifications, Article 10-16-3 Class IV.

**IV. MISCELLANEOUS**

A. Reduction of Unclassified Excavation – Loss Due to Clearing and Grubbing

No significant loss of unclassified excavation is anticipated due to clearing and grubbing.

B. Reduction of Unclassified Excavation – Unsuitable Waste

Unclassified excavation will be predominantly derived from ditch and subgrade excavation and is comprised primarily of granular material which is estimated to be 100 percent suitable for embankment construction.

C. Water Wells

No water wells were identified with the proposed right of way limits on this project. However, if any water wells are identified during construction activities, the well/s should be sealed by a North Carolina Certified Well Contractor in accordance with the North Carolina Department of Transportation Standard Specification, Section 205, "Sealing Abandoned Wells".

Prepared By:



DocuSigned by:  
*Steve Hudson* 6/22/2016  
62EFD88181F446F  
Steven V. Hudson, L.G.  
CATLIN Project Geologist

Prepared By:



DocuSigned by:  
*Jacob Wessell* 6/26/2016  
7D9CE6DE1D8462  
Jacob C. Wessell, P.E.  
CATLIN Geotechnical Engineer





**NORTH CAROLINA DEPARTMENT OF TRANSPORTATION**  
**GEOTECHNICAL ENGINEERING UNIT**

Summary of Quantities

WBS Number: 40238.1.4  
 TIP Number: U-4902D  
 Description: US 17 Business (Market Street) from Lendire Road to Marsh Oaks Drive

County: New Hanover  
 Field Office: GFO

DS  
*gcn*

DS  
*SH*

Project Engineer: JCW (CATLIN)  
 Project Geologist: SVH (CATLIN)

Pay Item No.	Pay Item/ Quantity Adjustment	Spec Book Section No. or Special Provision (SP) Reference	Report Section	Alignment	Begin Station	End Station	Quantity	Units / %
0036000000-E	Undercut Excavation	225 - Roadway Excavation	I. B	Contingency	N/A	N/A	200	CY
0036000000-E	Undercut Excavation	225 - Roadway Excavation	II. B	Contingency	N/A	N/A	200	CY
<b>Total Quantity of Undercut Excavation =</b>							<b>400</b>	<b>CY</b>
0195000000-E	Select Granular Material	265 - Select Granular Material	III. B	Contingency	N/A	N/A	600	CY
<b>Total Quantity of Select Granular Material =</b>							<b>600</b>	<b>CY</b>
0196000000-E	Geotextile for Soil Stabilization	270 - Geotextile for Soil Stabilization	I. C	Contingency	N/A	N/A	200	SY
0196000000-E	Geotextile for Soil Stabilization	270 - Geotextile for Soil Stabilization	II. D	Contingency	N/A	N/A	700	SY
<b>Total Quantity of Geotextile for Soil Stabilization =</b>							<b>900</b>	<b>SY</b>
1099500000-E	Shallow Undercut	505 - Aggregate Subgrade	II. C	Contingency	N/A	N/A	100	CY
<b>Total Quantity of Shallow Undercut =</b>							<b>100</b>	<b>CY</b>
1099700000-E	Class IV Subgrade Stabilization	505 - Aggregate Subgrade	III. E	Contingency	N/A	N/A	190	TON
<b>Total Quantity of Class IV Subgrade Stabilization =</b>							<b>190</b>	<b>TON</b>
2044000000-E	6" Perforated Subdrain Pipe	815 - Subsurface Drainage	II. A	Contingency	N/A	N/A	200	LF
<b>Total Quantity of 6" Perforated Subdrain Pipe =</b>							<b>200</b>	<b>LF</b>

<b>These Items Only Impact Earthwork Totals</b>								
N/A	Shrinkage Factor	235 - Embankments	III. C	N/A	N/A	N/A	25	%