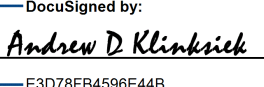
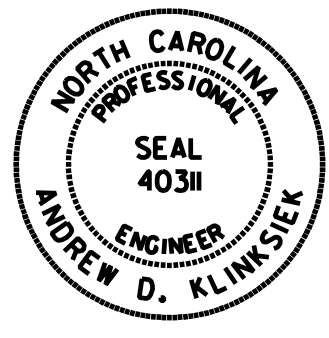

TIP NO.	SHEET NO.
U-4902D	PMP-1
APPROVED:  Andrew D. Klinick	
DATE: 7/27/2018	
SEAL	
	
DOCUMENT NOT CONSIDERED FINAL UNLESS ALL SIGNATURES COMPLETED	

**STATE OF NORTH CAROLINA  
DEPARTMENT OF TRANSPORTATION**

**PAVEMENT MARKING PLAN  
NEW HANOVER COUNTY**

**LOCATION: US 17 (MARKET STREET) FROM SR 1403 (MIDDLE SOUND LOOP RD)/LENDIRE  
EXTENSION TO SR 2290 (MENDENHALL DR)/SR 2734 (MARSH OAKS DR)**

**ROADWAY STANDARD DRAWING**

THE FOLLOWING ROADWAY STANDARDS AS APPEAR IN "ROADWAY STANDARD DRAWINGS" - PROJECT SERVICES UNIT - N.C. DEPARTMENT OF TRANSPORTATION - RALEIGH, N.C., DATED JANUARY 2018 ARE APPLICABLE TO THIS PROJECT AND BY REFERENCE HEREBY ARE CONSIDERED A PART OF THESE PLANS:

STD. NO.	TITLE
1205.01	PAVEMENT MARKINGS - LINE TYPES AND OFFSETS
1205.02	PAVEMENT MARKINGS - TWO-LANE AND MULTILANE ROADWAYS
1205.04	PAVEMENT MARKINGS - INTERSECTIONS
1205.05	PAVEMENT MARKINGS - TURN LANES
1205.07	PAVEMENT MARKINGS - PEDESTRIAN CROSSWALKS
1205.08	PAVEMENT MARKINGS - SYMBOLS AND WORD MESSAGES
1205.09	PAVEMENT MARKINGS - PAINTED ISLANDS
1205.15	PAVEMENT MARKINGS - SUPERSTREETS
1250.01	RAISED PAVEMENT MARKERS - INSTALLATION SPACING
1253.01	RAISED PAVEMENT MARKERS - SNOWFLOWABLE
1261.01	GUARDRAIL AND BARRIER DELINEATORS - INSTALLATION SPACING
1261.02	GUARDRAIL AND BARRIER DELINEATORS - TYPES AND MOUNTING
1262.01	GUARDRAIL END DELINEATION

**INDEX**

SHEET NO.	DESCRIPTION
PMP-1-1A	PAVEMENT MARKING PLAN TITLE AND SCHEDULE
PMP-2-2B	PAVEMENT MARKING CROSSWALK GUIDANCE AND CURB RAMP DETAILS
PMP-3-11	PAVEMENT MARKING DETAILS

**GENERAL NOTES**

THE FOLLOWING GENERAL NOTES APPLY AT ALL TIMES FOR THE DURATION OF THE CONSTRUCTION PROJECT, EXCEPT WHEN OTHERWISE NOTED IN THE PLAN, OR DIRECTED BY THE ENGINEER.

- A) INSTALL PAVEMENT MARKINGS AND PAVEMENT MARKERS ON THE FINAL SURFACE AS FOLLOWS:
 

ROAD NAME	MARKING	MARKER
ALL ROADS	THERMOPLASTIC	SNOWFLOWABLE
- B) TIE PROPOSED PAVEMENT MARKING LINES TO EXISTING PAVEMENT MARKING LINES.
- C) REMOVE/REPLACE ANY CONFLICTING/DAMAGED PAVEMENT MARKINGS AND MARKERS.
- D) STOP BAR LOCATION AT NON-SIGNALIZED INTERSECTIONS MAY BE ADJUSTED AS DIRECTED BY THE ENGINEER.
- E) UNLESS OTHERWISE SPECIFIED, HEATED-IN-PLACE THERMOPLASTIC MAY BE USED IN LIEU OF EXTRUDED THERMOPLASTIC FOR STOP BARS, SYMBOLS, CHARACTERS AND DIAGONALS. IF HEATED-IN-PLACE IS USED, IT SHALL BE PAID FOR USING THE EXTRUDED THERMOPLASTIC PAY ITEM.
- F) SEE ROADWAY PLANS FOR ALTERNATE CURB RAMP DESIGNS WHEN INDICATED ON PAVEMENT MARKING DETAIL SHEETS.

PLANS SUBMITTED TO NCDOT DIVISION 03:

Jessi Leonard, PE DIVISION TRAFFIC ENGINEER  
R. Coke Gray III, PE REGIONAL TRAFFIC ENGINEER

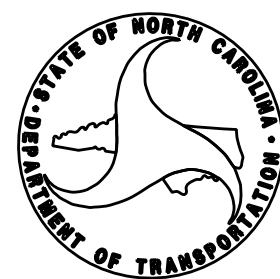

PLAN PREPARED BY: HNTB NORTH CAROLINA, P.C.

A.D. Klinick, PE, PTOE PROJECT ENGINEER  
J.T. Thibault, EI DESIGN ENGINEER

**HNTB** HNTB NORTH CAROLINA, P.C.  
343 E. Six Forks Road, Suite 200  
Raleigh, North Carolina 27609  
NC License No: C-1554  
(919) 546-8997

**CONTRACT: C202280 T.I.P.: U-4902D**

\$\$\$\$\$SYTIME\$\$\$\$\$  
\$\$\$\$\$DCGN\$\$\$\$\$  
\$\$\$\$\$USERNAME\$\$\$\$\$

TIP NO.	SHEET NO.
U - 4902D	PMP - 1A
APPROVED: <i>Andrew D. Klinck</i> <small>DocuSigned by:          Andrew D. Klinck          E3078F84596E48</small>	
DATE: 7/27/2018	
SEAL	
	
<b>DOCUMENT NOT CONSIDERED FINAL          UNLESS ALL SIGNATURES COMPLETED</b>	

# FINAL PAVEMENT MARKING SCHEDULE

MATERIAL	SYMBOL	DESCRIPTION
<b>PAVEMENT MARKING</b>		
<u>THERMOPLASTIC (4", 90 MILS)</u>		
	TA	WHITE EDGELINE
	TB	YELLOW EDGELINE
<u>THERMOPLASTIC (4", 120 MILS)</u>		
	T8	2 FT. -6 FT. /SP WHITE MINISKIP
	T9	2 FT. -6 FT. /SP YELLOW MINISKIP
	TC	10 FT. WHITE SKIP
	TD	3 FT. -9 FT. /SP WHITE MINISKIP
	TE	WHITE SOLID LANE LINE
	TI	YELLOW DOUBLE CENTER
<u>THERMOPLASTIC (8", 90 MILS)</u>		
	TN	WHITE GORELINE
<u>THERMOPLASTIC (12", 90 MILS)</u>		
	TU	WHITE DIAGONAL
	TV	YELLOW DIAGONAL
<u>THERMOPLASTIC (12", 120 MILS)</u>		
	TT	WHITE SOLID LANE LINE
<u>THERMOPLASTIC (24", 120 MILS)</u>		
	T2	WHITE STOPBAR
	T3	WHITE CROSSWALK LINE
<u>THERMOPLASTIC PAVEMENT MARKING SYMBOLS(90 MILS)</u>		
	UA	LEFT TURN ARROW
	UB	RIGHT TURN ARROW
	UC	STRAIGHT ARROW
	UD	COMBO STRAIGHT/LEFT
	UE	COMBO STRAIGHT/RIGHT
	UT	U TURN ARROW
<u>SNOWPLOWABLE PAVEMENT MARKERS (NOT SHOWN)</u>		
	ME	YELLOW & YELLOW
	MF	CRYSTAL & RED

**PAVEMENT MARKING SYMBOLS**

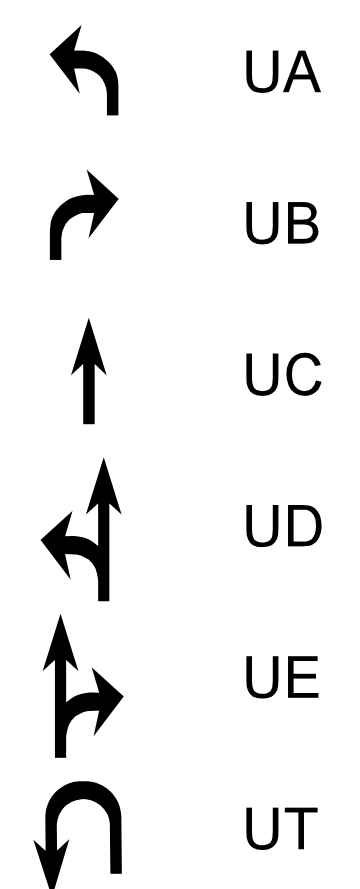

## LEGEND

**GENERAL**

← DIRECTION OF TRAFFIC FLOW

↑ NORTH ARROW

— PROPOSED PVMT. - - - - - EXIST. PVMT.

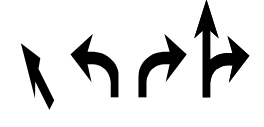

**PAVEMENT MARKINGS**

 PAVEMENT MARKING SYMBOLS

ONLY PAVEMENT MARKING CHARACTERS

\$\$\$SYSTEM\$\$\$  
 \$\$\$DCON\$\$\$  
 \$\$\$USERNAME\$\$\$

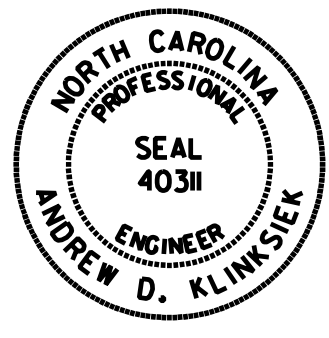
TIP NO.	SHEET NO.
U-4902D	PMP-2
APPROVED: <i>Andrew D. Klinck</i> E-1078784596E48	
DATE: 7/27/2018	
SEAL 	
DOCUMENT NOT CONSIDERED FINAL UNLESS ALL SIGNATURES COMPLETED	

ALL SIGNALIZED PEDESTRIAN CROSSWALKS SHALL BE SPECIAL EMPHASIS CROSSWALKS AS SPECIFIED IN NCDOT DIVISION 3 HIGH-VISIBILITY CROSSWALK POLICY.

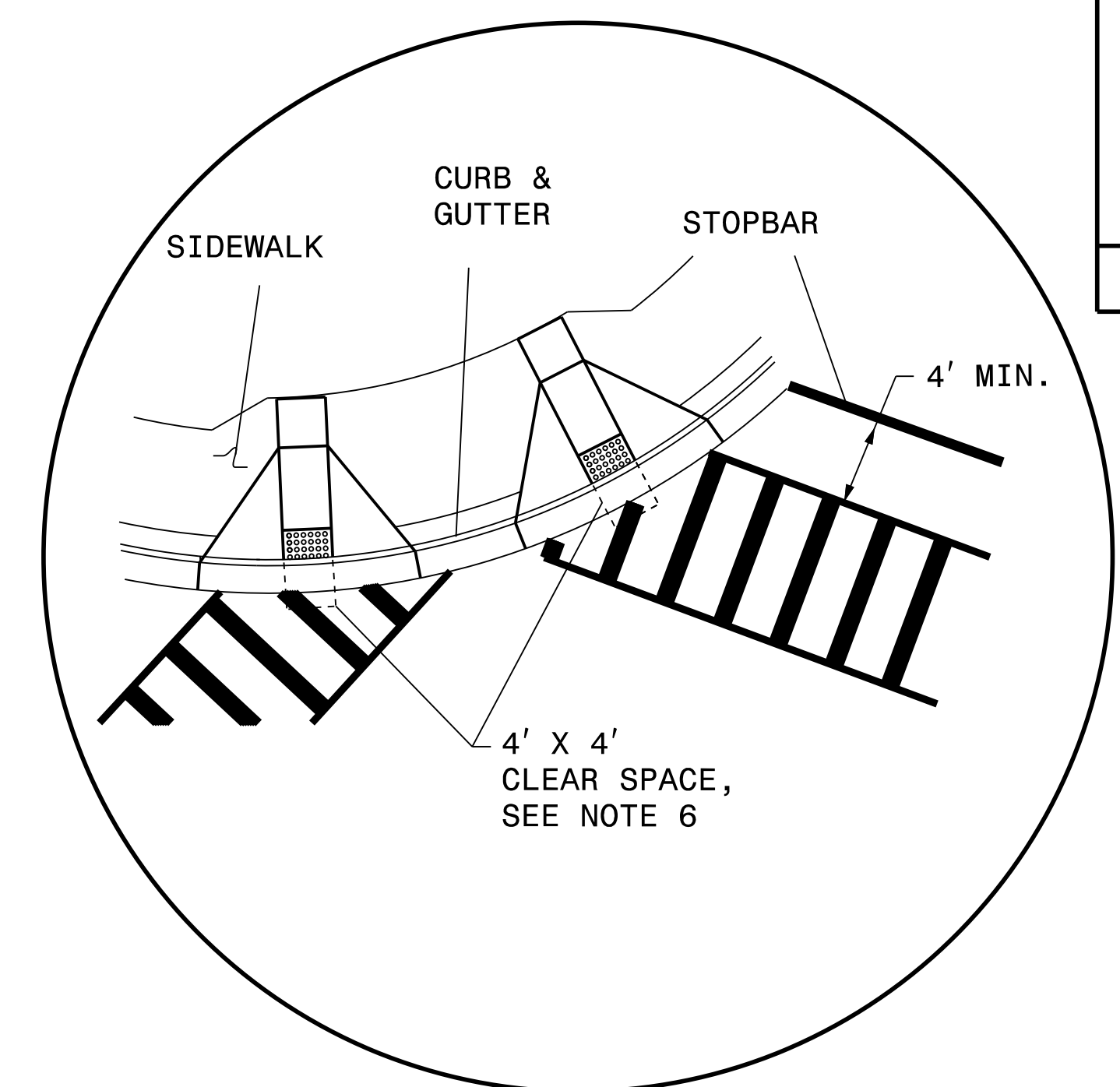
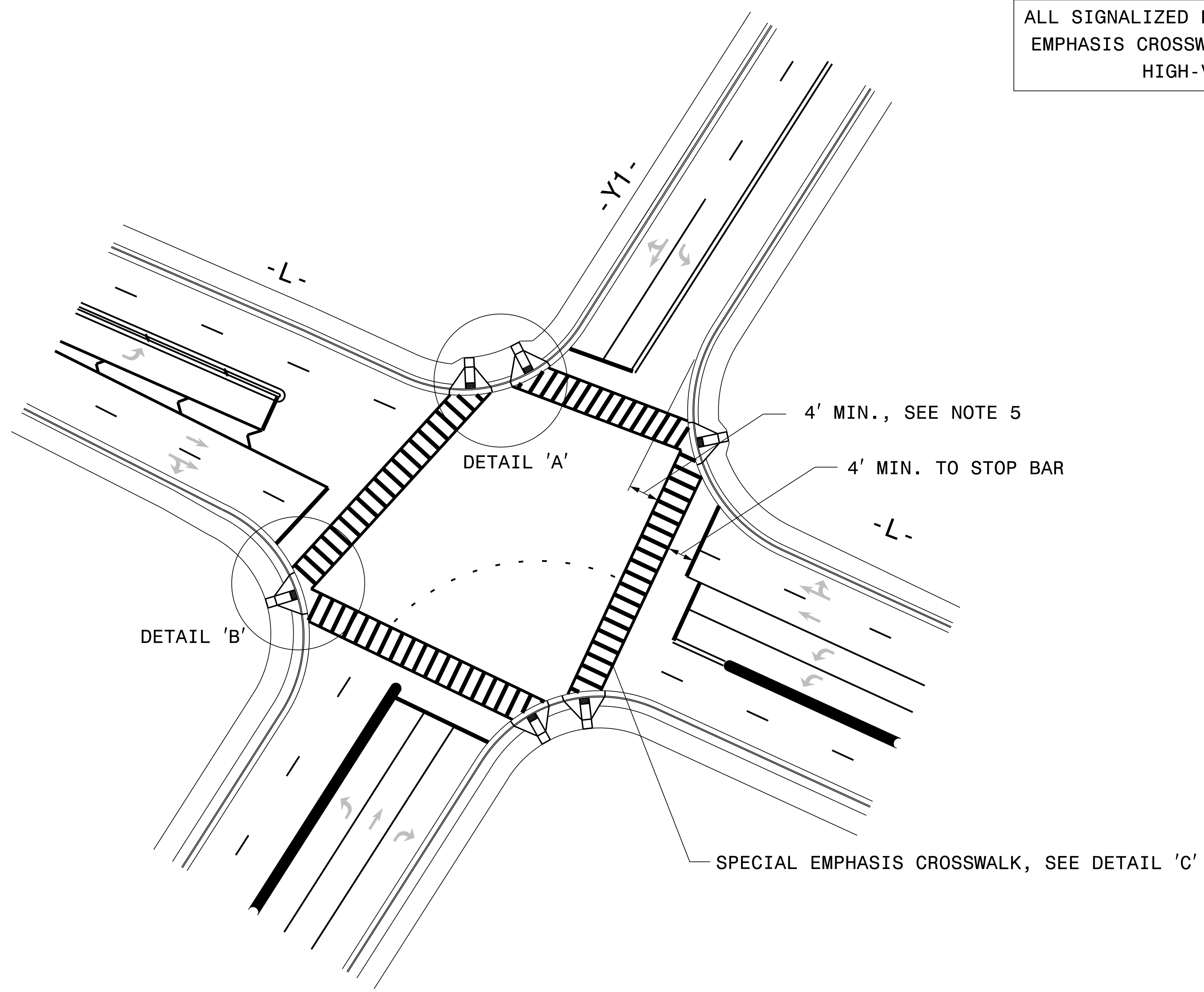

DETAIL 'A'- DUAL CURB RAMPS

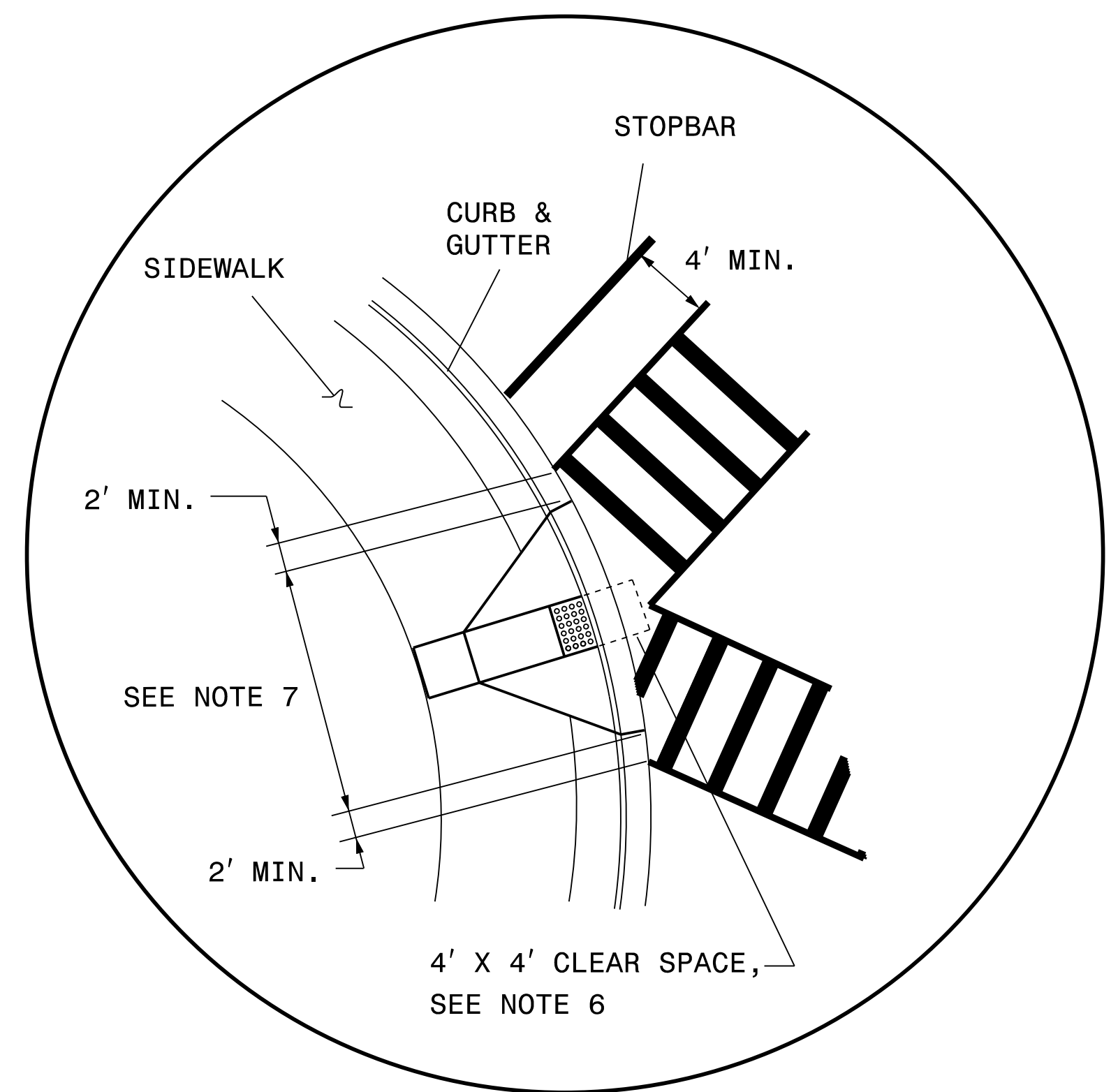

DETAIL 'B'- SINGLE DIAGONAL CURB RAMP

NOTES:

1. USE THE DETAILS ABOVE AND THE FOLLOWING NOTES FOR GUIDANCE IN PLACING CROSSWALK MARKINGS. REFER TO NCDOT ROADWAY STANDARD DRAWINGS, MUTCD AND ADA STANDARDS FOR ADDITIONAL GUIDANCE.
2. THE LOCATION AND TYPE OF CROSSWALK MARKINGS SHOWN ON THE ABOVE DETAILS ARE FOR REFERENCE ONLY. LOCATE CROSSWALK MARKINGS AS SHOWN ON THE PROJECT DETAIL SHEETS OR AS DIRECTED BY THE ENGINEER. THE CROSSWALK MARKING TYPE, SPECIAL EMPHASIS, SHALL BE INSTALLED AS SPECIFIED ON THE PROJECT DETAIL SHEETS OR AS DIRECTED BY THE ENGINEER.
3. THE SPECIAL EMPHASIS CROSSWALK IS TWO WHITE 12" TRANSVERSE LINES WITH A 10' GAP BETWEEN THE LINES AND WHITE 24" WIDE LONGITUDINAL LINES WITH 60" MAXIMUM GAPS BETWEEN LINES, SEE DETAIL PMP-2A.
4. STOP BARS SHOULD BE PLACED A MINIMUM OF 4' IN ADVANCE OF NEAREST CROSSWALK LINE.
5. SET BACK DISTANCE FROM INSIDE CROSSWALK MARKING TO NEAREST EDGE OF TRAVEL IS 4' MIN.
6. BEYOND THE BOTTOM GRADE BREAK, A CLEAR SPACE OF 4' X 4' MINIMUM SHALL BE PROVIDED WITHIN THE MARKINGS.
7. SINGLE DIAGONAL CURB RAMPS WITH FLARED SIDES SHALL HAVE A SEGMENT OF CURB 2 FEET LONG MINIMUM LOCATED ON EACH SIDE OF THE CURB RAMP AND WITHIN THE MARKED CROSSING, SEE DETAIL 'B'.
8. CURB RAMPS SHALL BE CONSTRUCTED IN ACCORDANCE TO THE LATEST NCDOT ROADWAY STANDARD DRAWINGS.

\$\$\$\$\$SYTIME\$\$\$\$\$  
\$\$\$\$\$DGN\$\$\$\$\$  
\$\$\$\$\$USERNAME\$\$\$\$\$

**HNTB**  
HNTB NORTH CAROLINA, P.C.  
343 E. SIX FORKS ROAD, SUITE 200  
RALEIGH, NORTH CAROLINA 27609  
NC LICENSE NO: C-1554  
(919) 546-8997

**CROSSWALK PAVEMENT MARKING  
GUIDANCE DETAIL**

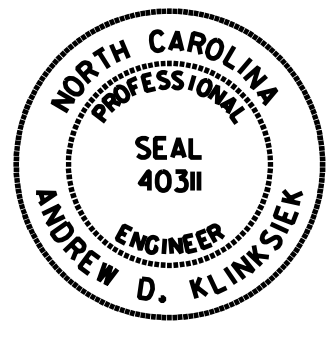
TIP NO. U-4902D	SHEET NO. PMP-2A
APPROVED: <i>Andrew D. Klinck</i> E-1078784596E4AB	
DATE: 7/27/2018	
SEAL 	
DOCUMENT NOT CONSIDERED FINAL UNLESS ALL SIGNATURES COMPLETED	

# PAVEMENT MARKING DETAIL

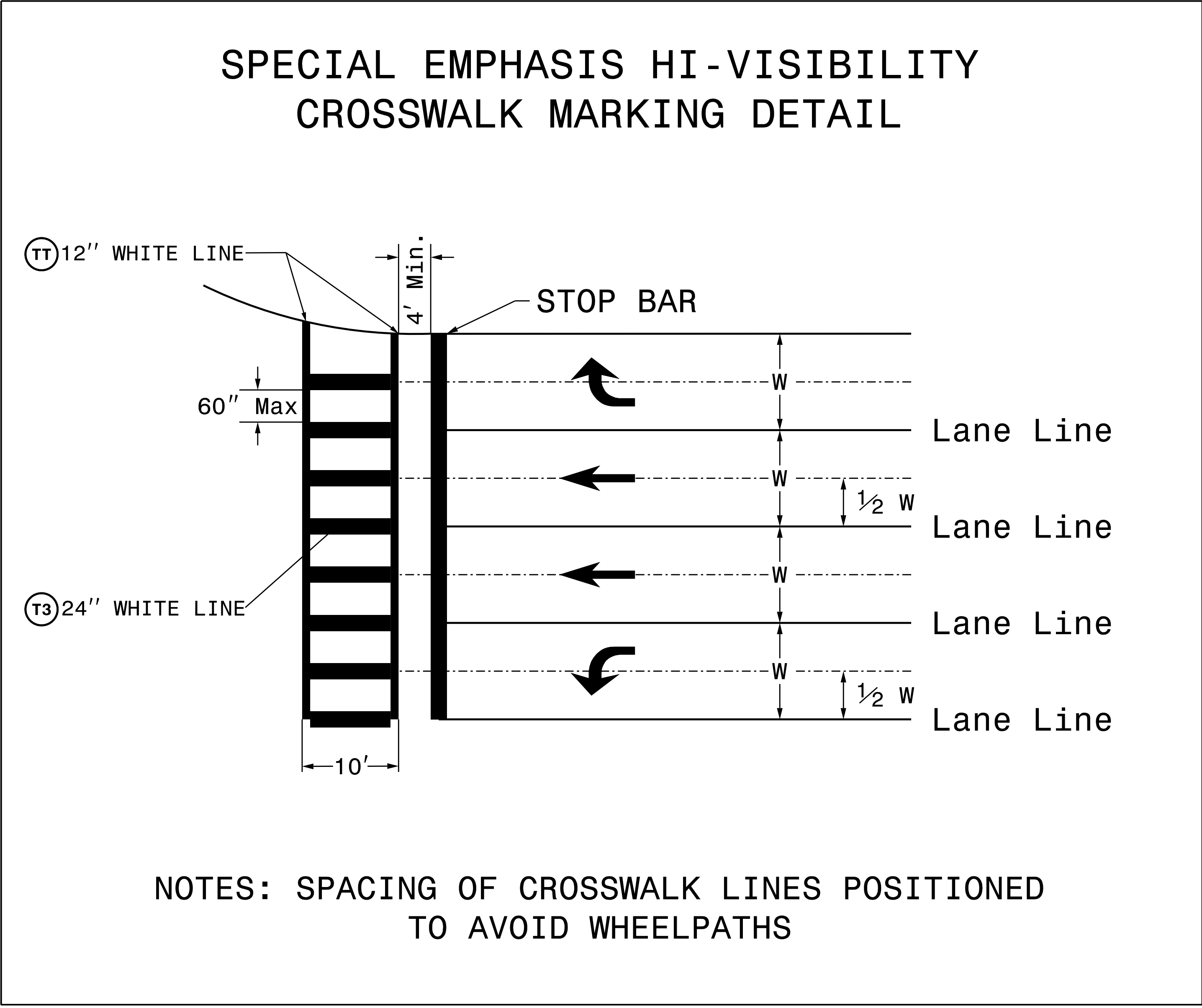

\$\$\$\$\$SYSTEM\$\$\$\$\$  
\$\$\$\$\$DGN\$\$\$\$\$  
\$\$\$\$\$USERNAM\$\$\$\$\$

**HNTB** HNTB NORTH CAROLINA, P.C.  
343 E. SIX FORKS ROAD, SUITE 200  
RALEIGH, NORTH CAROLINA 27609  
NC LICENSE NO: C-1554  
(919) 546-8997

**SPECIAL EMPHASIS HI-VISIBILITY  
CROSSWALK MARKING DETAIL**

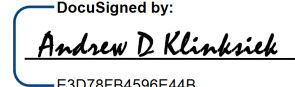
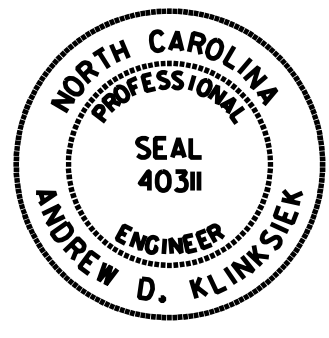
TIP NO.	SHEET NO.
U-4902D	PMP-2B
APPROVED:  Andrew D. Klinck	
DATE: 7/27/2018	
SEAL	
	
DOCUMENT NOT CONSIDERED FINAL UNLESS ALL SIGNATURES COMPLETED	

## CURB RAMP LOCATIONS & TYPES

NUMBER	DESCRIPTION	NUMBER	DESCRIPTION
1	-L- STA 201+40+/- (46.0' RT) (TYPE 1)	47	-L- STA 249+49+/- (43.3' RT) (TYPE 1)
2	-L- STA 202+02+/- (46.0' RT) (TYPE 1)	48	-L- STA 250+06+/- (43.3' RT) (TYPE 1)
3	-L- STA 202+92+/- (46.0' RT) (TYPE 1)	49	-L- STA 251+13+/- (43.3' RT) (TYPE 1)
4	-L- STA 203+44+/- (46.0' RT) (TYPE 1)	50	-L- STA 251+55+/- (43.3' RT) (TYPE 1)
5	-L- STA 204+14+/- (46.0' RT) (TYPE 1)	51	-L- STA 248+82+/- (52.7' LT) (TYPE 1)
6	-L- STA 204+66+/- (45.1' RT) (TYPE 1)	52	-L- STA 248+41+/- (52.7' LT) (TYPE 1)
7	-L- STA 206+45+/- (40.7' LT) (TYPE 1)	53	-Y31- STA 12+04+/- (38.5' LT) (TYPE 1)
8	-L- STA 206+04+/- (40.7' LT) (TYPE 1)	54	-Y31- STA 11+88+/- (45.7' RT) (TYPE 1)
9	-L- STA 203+38+/- (43.5' LT) (TYPE 1)	55	-L- STA 241+61+/- (40.7' LT) (TYPE 1)
10	-L- STA 202+76+/- (43.5' LT) (TYPE 1)	56	-L- STA 241+10+/- (40.7' LT) (TYPE 1)
11	-L- STA 207+18+/- (43.2' RT) (TYPE 1)	57	-L- STA 252+75+/- (43.3' RT) (TYPE 1)
12	-L- STA 207+66+/- (43.2' RT) (TYPE 1)	58	-L- STA 253+15+/- (43.3' RT) (TYPE 1)
13	-Y28A- STA 10+44+/- (17.0' RT) (TYPE 1)	59	-L- STA 254+42+/- (43.3' RT) (TYPE 1)
14	-Y28A- STA 10+41+/- (17.0' LT) (TYPE 1)	60	-L- STA 254+85+/- (43.3' RT) (TYPE 1)
15	-L- STA 211+40+/- (43.3' RT) (TYPE 1)	61	-L- STA 255+13+/- (43.3' RT) (TYPE 1)
16	-L- STA 211+85+/- (43.3' RT) (TYPE 1)	62	-L- STA 255+53+/- (43.3' RT) (TYPE 1)
17	-L- STA 213+03+/- (43.2' RT) (TYPE 1)	63	-L- STA 256+52+/- (43.3' RT) (TYPE 1)
18	-L- STA 213+77+/- (43.2' RT) (TYPE 1)	64	-L- STA 256+99+/- (43.3' RT) (TYPE 1)
19	-L- STA 215+92+/- (43.2' RT) (TYPE 1)	65	-L- STA 258+18+/- (43.3' RT) (TYPE 1)
20	-L- STA 216+23+/- (43.2' RT) (TYPE 1)	66	-L- STA 258+70+/- (43.3' RT) (TYPE 1)
21	-L- STA 217+79+/- (43.2' RT) (TYPE 1)	67	-L- STA 259+28+/- (45.8' RT) (TYPE 1)
22	-L- STA 218+20+/- (43.2' RT) (TYPE 1)	68	-L- STA 259+75+/- (48.6' RT) (TYPE 1)
23	-L- STA 218+80+/- (40.8' LT) (TYPE 1)	69	-L- STA 260+33+/- (52.1' RT) (TYPE 1)
24	-L- STA 218+13+/- (40.8' LT) (TYPE 1)	70	-L- STA 260+69+/- (54.3' RT) (TYPE 1)
25	-L- STA 217+71+/- (40.8' LT) (TYPE 1)	71	-L- STA 263+02+/- (55.25' RT) (TYPE 1)
26	-L- STA 217+29+/- (40.8' LT) (TYPE 1)	72	-L- STA 263+81+/- (55.25' RT) (TYPE 1)
27	-L- STA 228+78+/- (43.3' RT) (TYPE 1)	73	-L- STA 262+71+/- (52.9' LT) (TYPE 1)
28	-L- STA 229+53+/- (43.3' RT) (TYPE 1)	74	-L- STA 262+33+/- (52.9' LT) (TYPE 1)
29	-L- STA 228+13+/- (40.7' LT) (TYPE 1)	75	-L- STA 260+88+/- (40.7' LT) (TYPE 1)
30	-L- STA 227+59+/- (40.7' LT) (TYPE 1)	76	-L- STA 260+33+/- (40.7' LT) (TYPE 1)
31	-L- STA 226+19+/- (40.7' LT) (TYPE 1)	77	-Y32- STA 12+04+/- (17.0' LT) (TYPE 1)
32	-L- STA 225+80+/- (40.7' LT) (TYPE 1)	78	-Y32- STA 12+04+/- (17.0' RT) (TYPE 1)
33	-L- STA 225+33+/- (40.7' LT) (TYPE 1)	79	-L- STA 268+26+/- (17.0' RT) (TYPE 1)
34	-L- STA 224+82+/- (40.7' LT) (TYPE 1)	80	-L- STA 268+60+/- (17.0' RT) (TYPE 1)
35	-L- STA 224+44+/- (40.7' LT) (TYPE 1)	81	-Y33- STA 12+00+/- (17.0' LT) (TYPE 1)
36	-L- STA 223+96+/- (40.7' LT) (TYPE 1)	82	-Y33- STA 11+96+/- (17.0' RT) (TYPE 1)
37	-L- STA 223+73+/- (47.4' LT) (TYPE 1)	83	-L- STA 278+76+/- (17.0' RT) (TYPE 1)
38	-L- STA 223+25+/- (53.9' LT) (TYPE 1)	84	-L- STA 279+35+/- (17.0' RT) (TYPE 1)
39	-L- STA 221+02+/- (40.7' LT) (TYPE 1)	85	-L- STA 281+18+/- (17.0' RT) (TYPE 1)
40	-L- STA 220+58+/- (40.8' LT) (TYPE 1)	86	-L- STA 281+73+/- (17.0' RT) (TYPE 1)
41	-Y30- STA 10+42+/- (17.0' RT) (TYPE 1)	87	-L- STA 286+19+/- (17.0' RT) (STANDARD)
42	-Y30- STA 10+91+/- (17.0' RT) (TYPE 4A)	88	-L- STA 286+22+/- (17.0' LT) (STANDARD)
43	-L- STA 236+77+/- (43.3' RT) (TYPE 1)	89	-L- STA 208+54+/- (40.7' LT) (TYPE 1)
44	-L- STA 237+12+/- (43.3' RT) (TYPE 1)	90	-L- STA 208+93+/- (40.7' LT) (TYPE 1)
45	-Y29- STA 16+59+/- (17.0' LT) (TYPE 4A)	91	-L- STA 282+55+/- (55.3' RT) (TYPE 1)
46	-Y29- STA 16+56+/- (17.0' RT) (TYPE 1)	92	-L- STA 282+81+/- (55.3' RT) (TYPE 1)

\$\$\$\$\$SYSTEM\$\$\$\$\$  
 \$\$\$DDGDCN\$\$\$\$\$  
 \$\$\$USERNAM\$\$\$\$\$

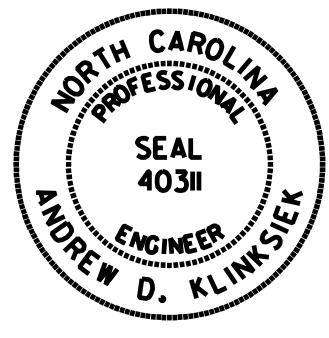

## CURB RAMP DETAILS

TIP NO. U-4902D	SHEET NO. PMP-3
APPROVED: <i>Andrew D. Klinck</i> E-1078784596E4B	
DATE: 7/27/2018	
SEAL 	
DOCUMENT NOT CONSIDERED FINAL UNLESS ALL SIGNATURES COMPLETED	

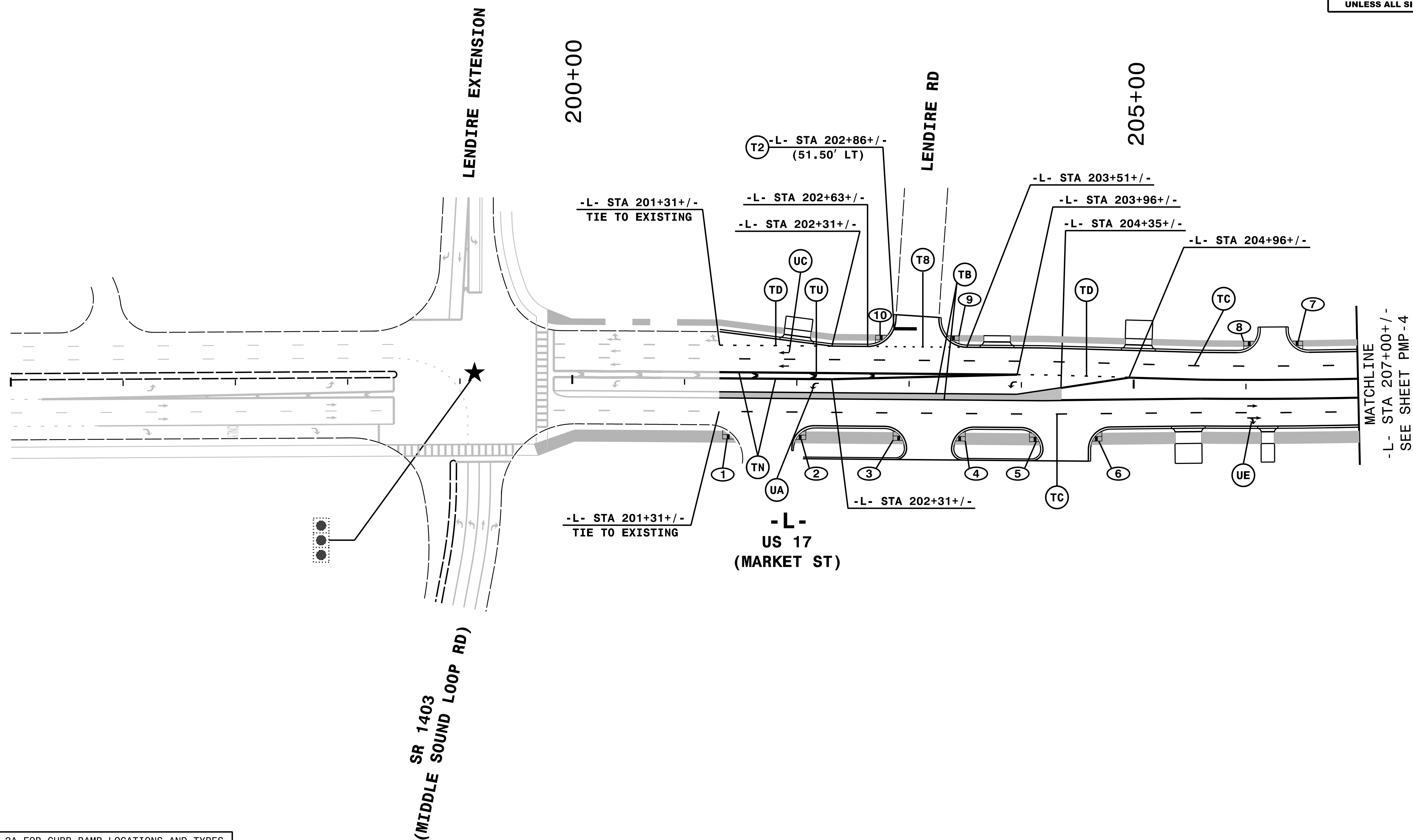

SEE SHEET PMP-2A FOR CURB RAMP LOCATIONS AND TYPES

NOTE: ALL LANE WIDTHS ARE 12' UNLESS OTHERWISE SHOWN.

ENGINEER TO APPROVE LOCATION OF ALL UNSIGNALIZED STOPBARS.

**HNTB** HNTB NORTH CAROLINA, P.C.  
343 E. SIX FORKS ROAD, SUITE 200  
RALEIGH, NORTH CAROLINA 27609  
NC LICENSE NO: C-1554  
(919) 546-8997

**PAVEMENT MARKING DETAIL**

\$\$\$\$\$SYTIME\$\$\$\$\$  
\$\$\$\$\$DGN\$\$\$\$\$  
\$\$\$\$\$USERNAME\$\$\$\$\$

TIP NO. U - 4902D	SHEET NO. PMP - 4
APPROVED: <i>Andrew D. Klinck</i> E-10784596E4B	
DATE: 7/27/2018	
SEAL 	
DOCUMENT NOT CONSIDERED FINAL UNLESS ALL SIGNATURES COMPLETED	

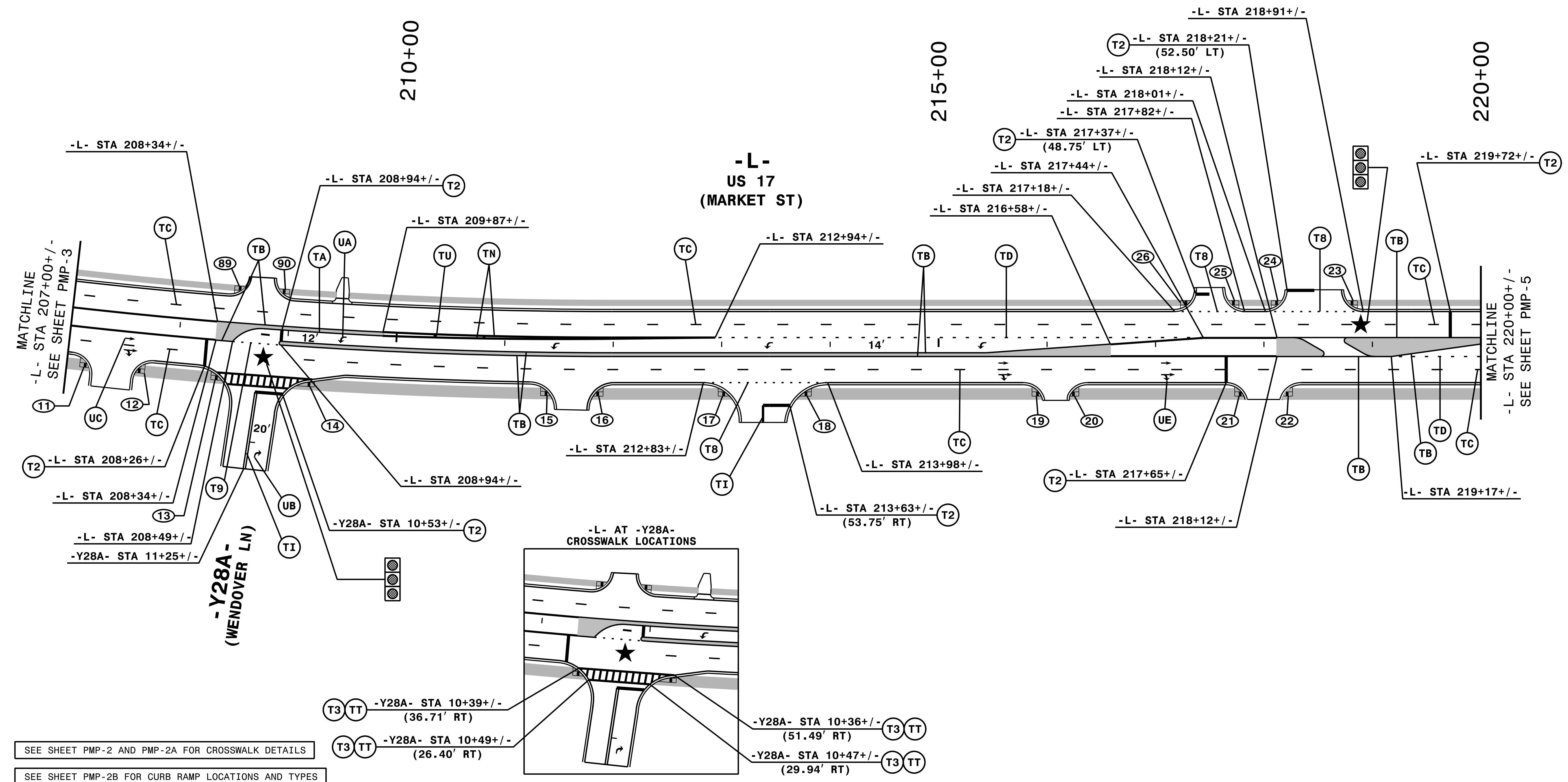

SEE SHEET PMP-2 AND PMP-2A FOR CROSSWALK DETAILS

SEE SHEET PMP-2B FOR CURB RAMP LOCATIONS AND TYPES

NOTE: ALL LANE WIDTHS ARE 12' UNLESS OTHERWISE SHOWN.

ENGINEER TO APPROVE LOCATION OF ALL UNSIGNALIZED STOPBARS.

- T3 TT -Y28A- STA 10+39+/- (36.71' RT)
- T3 TT -Y28A- STA 10+49+/- (26.40' RT)
- Y28A- STA 10+36+/- (51.49' RT) T3 TT
- Y28A- STA 10+47+/- (29.94' RT) T3 TT

\$\$\$\$\$SYTIME\$\$\$\$\$  
\$\$\$\$\$DGN\$\$\$\$\$  
\$\$\$\$\$USERNAME\$\$\$\$\$

**HNTB** HNTB NORTH CAROLINA, P.C.  
343 E. Six Forks Road, Suite 200  
Raleigh, North Carolina 27609  
NC License No: C-1554  
(919) 546-8997

**PAVEMENT MARKING DETAIL**

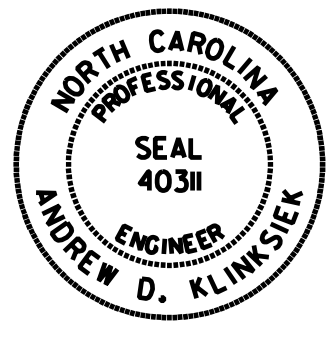
TIP NO. U - 4902D	SHEET NO. PMP - 5
APPROVED: <i>Andrew D. Klinck</i> E-10784596E4B	
DATE: 7/27/2018	
SEAL 	
DOCUMENT NOT CONSIDERED FINAL UNLESS ALL SIGNATURES COMPLETED	

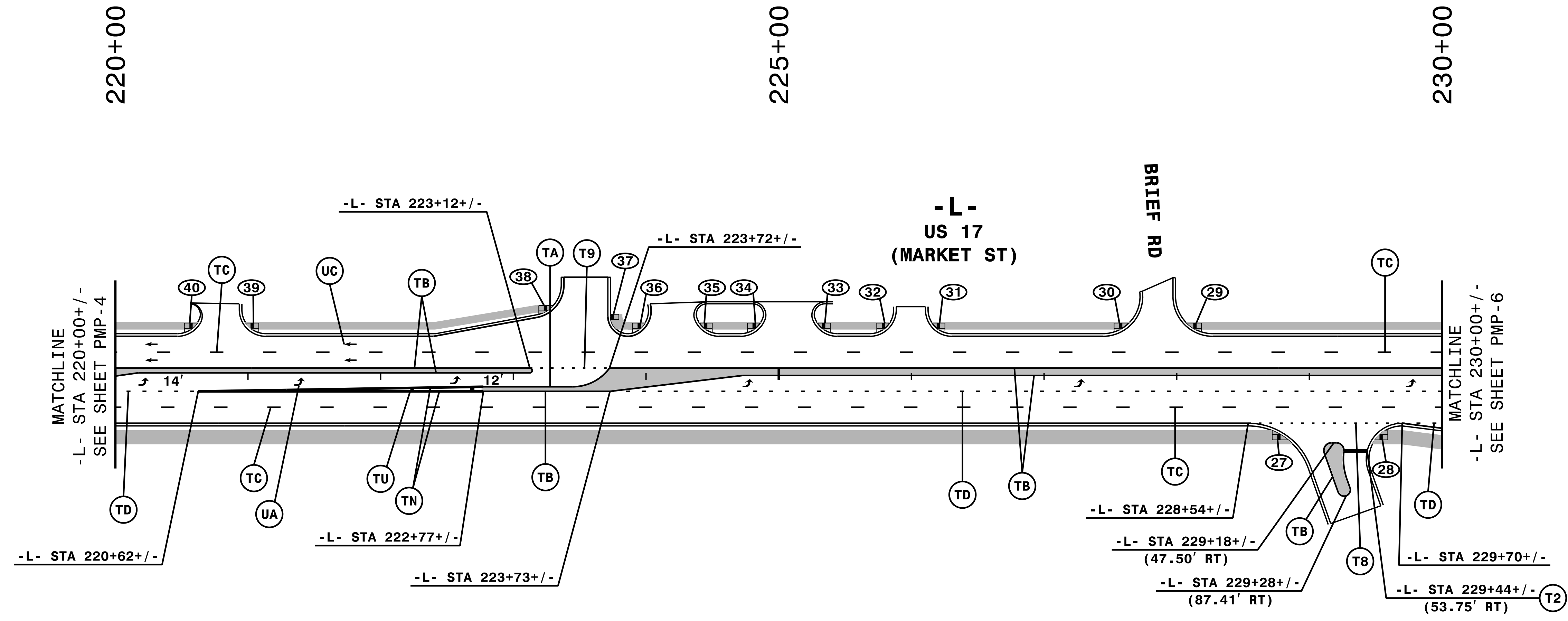

SEE SHEET PMP-2B FOR CURB RAMP LOCATIONS AND TYPES

NOTE: ALL LANE WIDTHS ARE 12' UNLESS OTHERWISE SHOWN.

ENGINEER TO APPROVE LOCATION OF ALL UNSIGNALIZED STOPBARS.

**HNTB**  
 HNTB NORTH CAROLINA, P.C.  
 343 E. SIX FORKS ROAD, SUITE 200  
 RALEIGH, NORTH CAROLINA 27609  
 NC LICENSE NO: C-1554  
 (919) 546-8997

**PAVEMENT MARKING DETAIL**

\$\$\$\$\$SYTIME\$\$\$\$\$  
 \$\$\$DDDCN\$\$\$\$\$  
 \$\$\$USERNAM\$\$\$\$\$

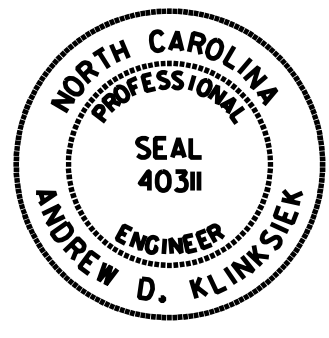

TIP NO.	SHEET NO.
U-4902D	PMP-6
APPROVED: <i>Andrew D. Klinck</i>	
DATE: 7/27/2018	
SEAL	
	
DOCUMENT NOT CONSIDERED FINAL UNLESS ALL SIGNATURES COMPLETED	

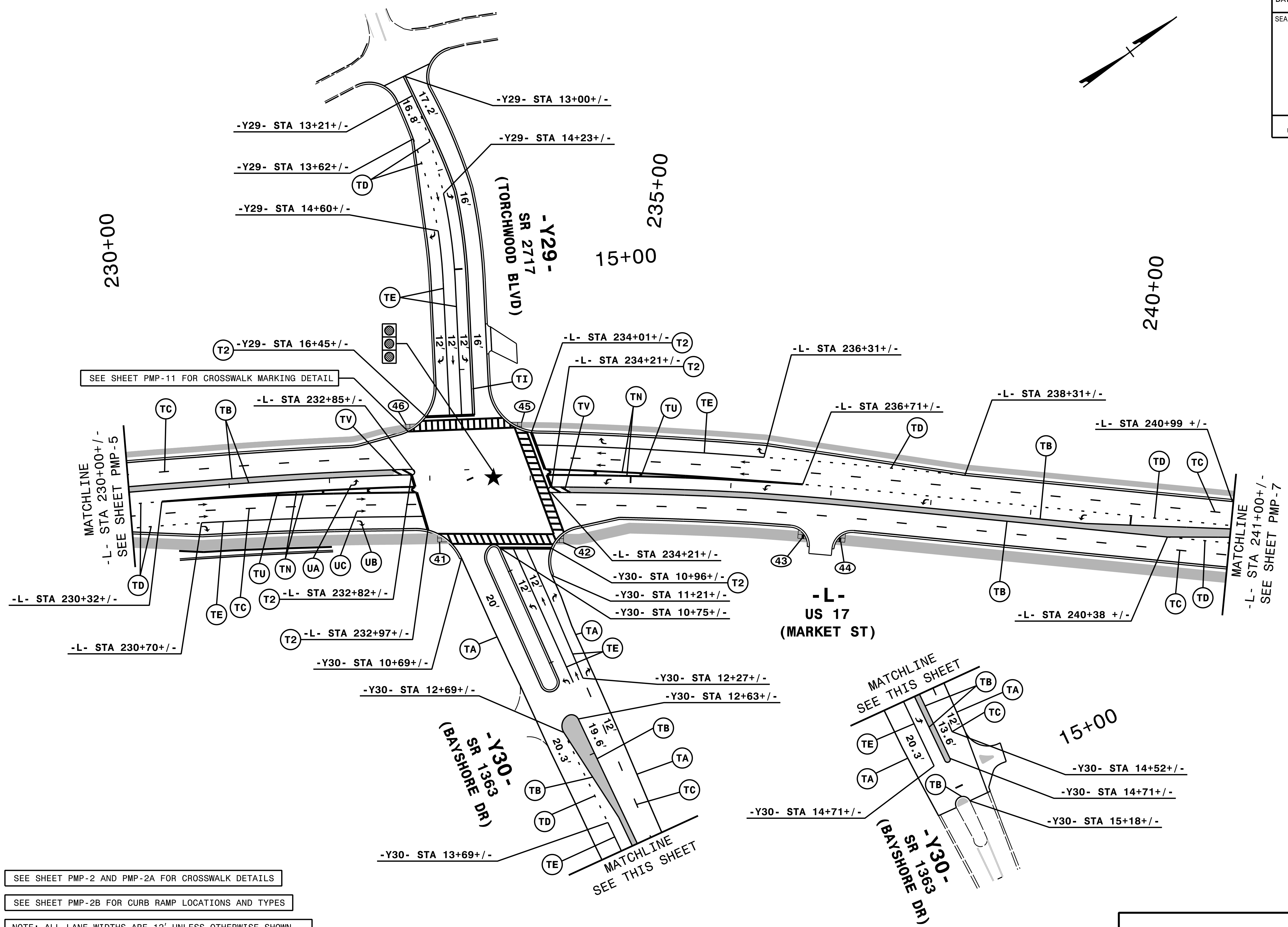

SEE SHEET PMP-2 AND PMP-2A FOR CROSSWALK DETAILS

SEE SHEET PMP-2B FOR CURB RAMP LOCATIONS AND TYPES

NOTE: ALL LANE WIDTHS ARE 12' UNLESS OTHERWISE SHOWN.

**HNTB**

HNTB NORTH CAROLINA, P.C.  
343 E. SIX FORKS ROAD, SUITE 200  
RALEIGH, NORTH CAROLINA 27609  
NC LICENSE NO: C-1554  
(919) 546-8997

**PAVEMENT MARKING DETAIL**

\$\$\$\$\$SYTIME\$\$\$\$\$  
\$\$\$\$\$DGN\$\$\$\$\$  
\$\$\$\$\$USERNAME\$\$\$\$\$

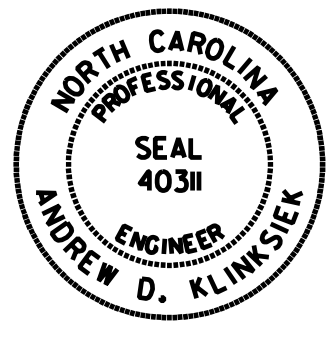

TIP NO. U-4902D	SHEET NO. PMP-8
APPROVED: <i>Andrew D. Klinck</i> DATE: 7/27/2018	
	
DOCUMENT NOT CONSIDERED FINAL UNLESS ALL SIGNATURES COMPLETED	

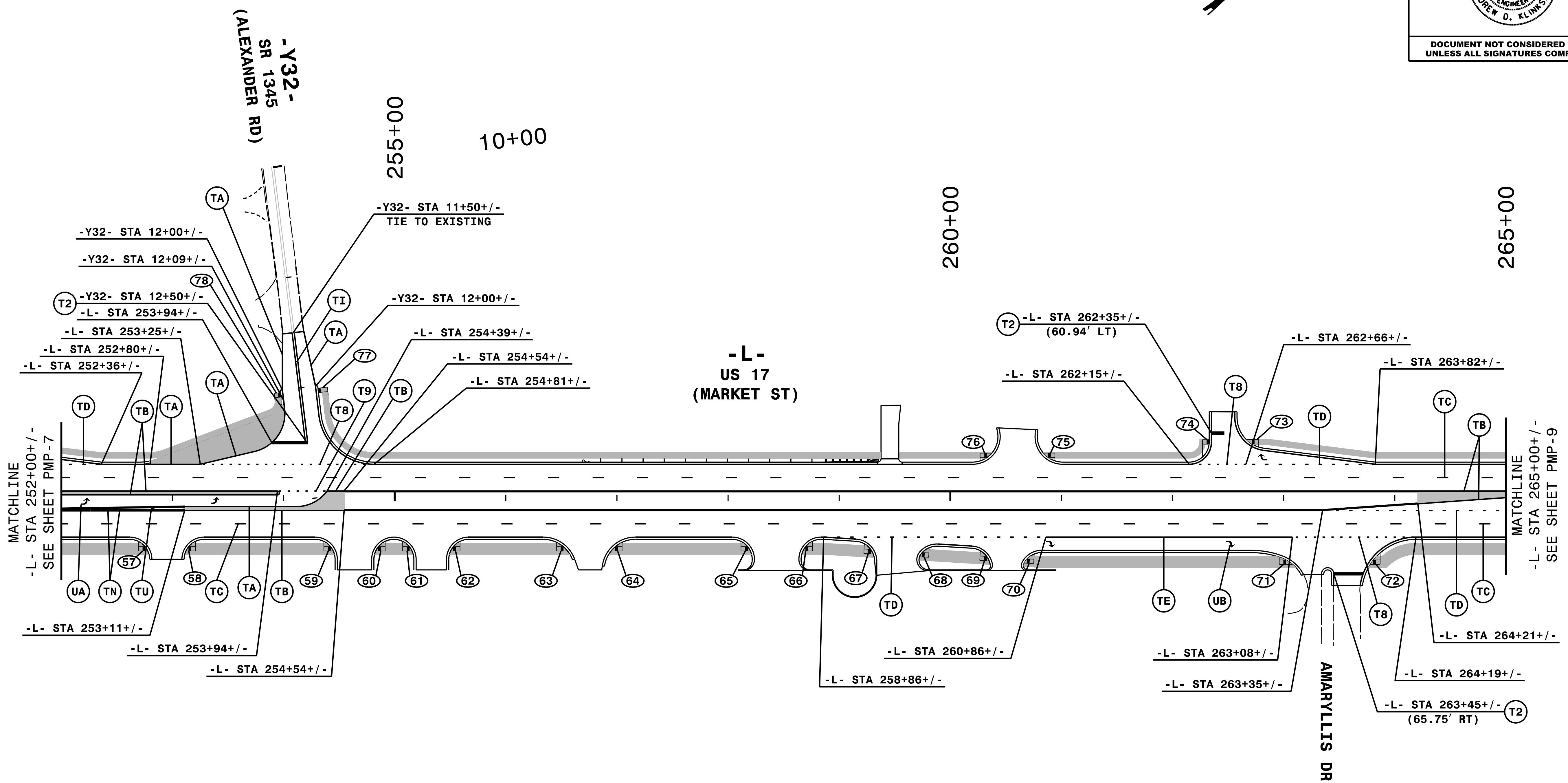

SEE SHEET PMP-2 AND PMP-2A FOR CROSSWALK DETAILS

SEE SHEET PMP-2B FOR CURB RAMP LOCATIONS AND TYPES

NOTE: ALL LANE WIDTHS ARE 12' UNLESS OTHERWISE SHOWN.

ENGINEER TO APPROVE LOCATION OF ALL UNSIGNALIZED STOPBARS.

**HNTB** HNTB NORTH CAROLINA, P.C.  
343 E. SIX FORKS ROAD, SUITE 200  
RALEIGH, NORTH CAROLINA 27609  
NC LICENSE NO: C-1554  
(919) 546-8997

**PAVEMENT MARKING DETAIL**

\$\$\$\$\$SYTIME\$\$\$\$\$  
\$\$\$\$\$DCGN\$\$\$\$\$  
\$\$\$\$\$USERNAME\$\$\$\$\$

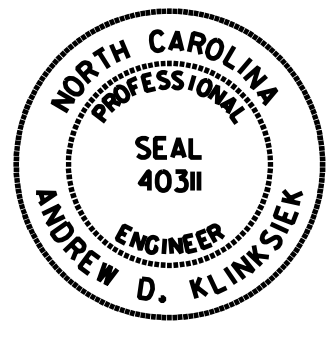
TIP NO. U-4902D	SHEET NO. PMP-9
APPROVED: <i>Andrew D. Klinck</i> E-10784596E4B	
DATE: 7/27/2018	
SEAL 	
DOCUMENT NOT CONSIDERED FINAL UNLESS ALL SIGNATURES COMPLETED	

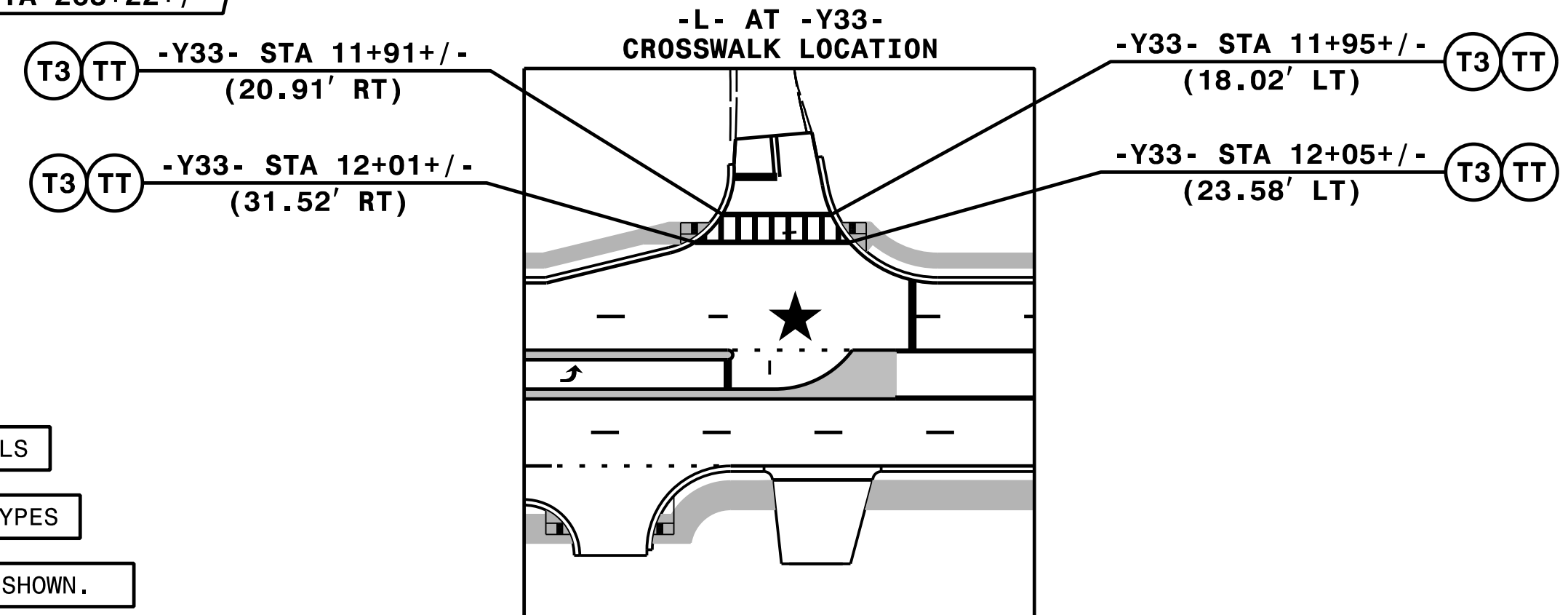
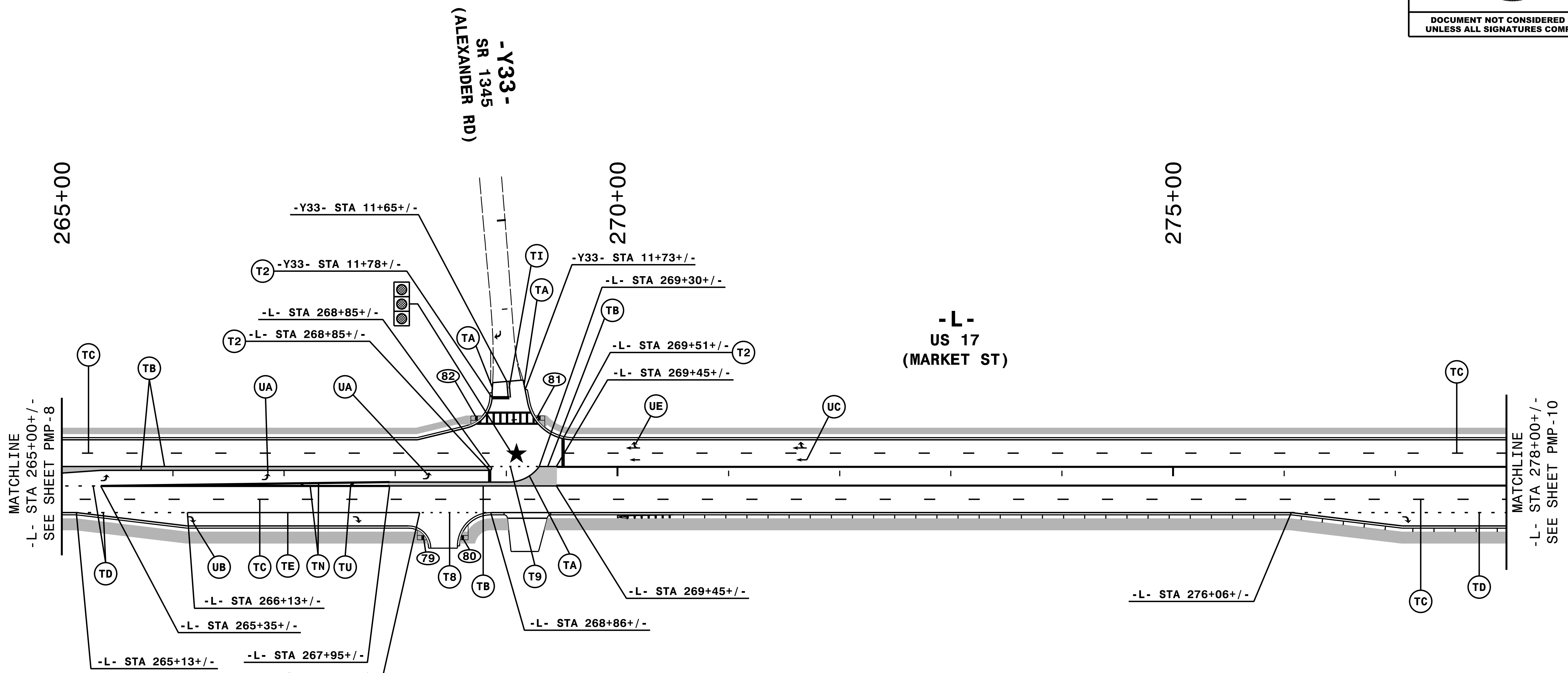
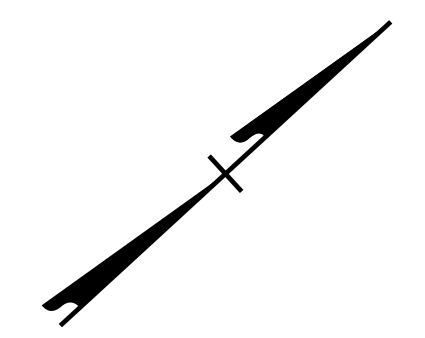

SEE SHEET PMP-2 AND PMP-2A FOR CROSSWALK DETAILS

SEE SHEET PMP-2B FOR CURB RAMP LOCATIONS AND TYPES

NOTE: ALL LANE WIDTHS ARE 12' UNLESS OTHERWISE SHOWN.

\$\$\$\$\$SYTIME\$\$\$\$\$  
\$\$\$\$\$DDCN\$\$\$\$\$  
\$\$\$\$\$USERNAME\$\$\$\$\$

**HNTB**  
HNTB NORTH CAROLINA, P.C.  
343 E. SIX FORKS ROAD, SUITE 200  
RALEIGH, NORTH CAROLINA 27609  
NC LICENSE NO: C-1554  
(919) 546-8997

**PAVEMENT MARKING DETAIL**

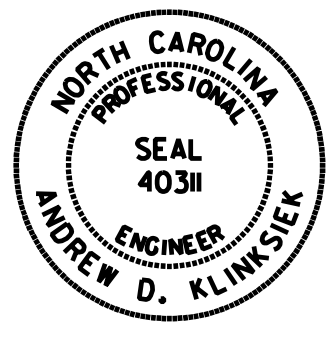
TIP NO.	SHEET NO.
U-4902D	PMP-10
APPROVED: <i>Andrew D. Klinck</i>	
DATE: 7/27/2018	
SEAL	
	
DOCUMENT NOT CONSIDERED FINAL UNLESS ALL SIGNATURES COMPLETED	

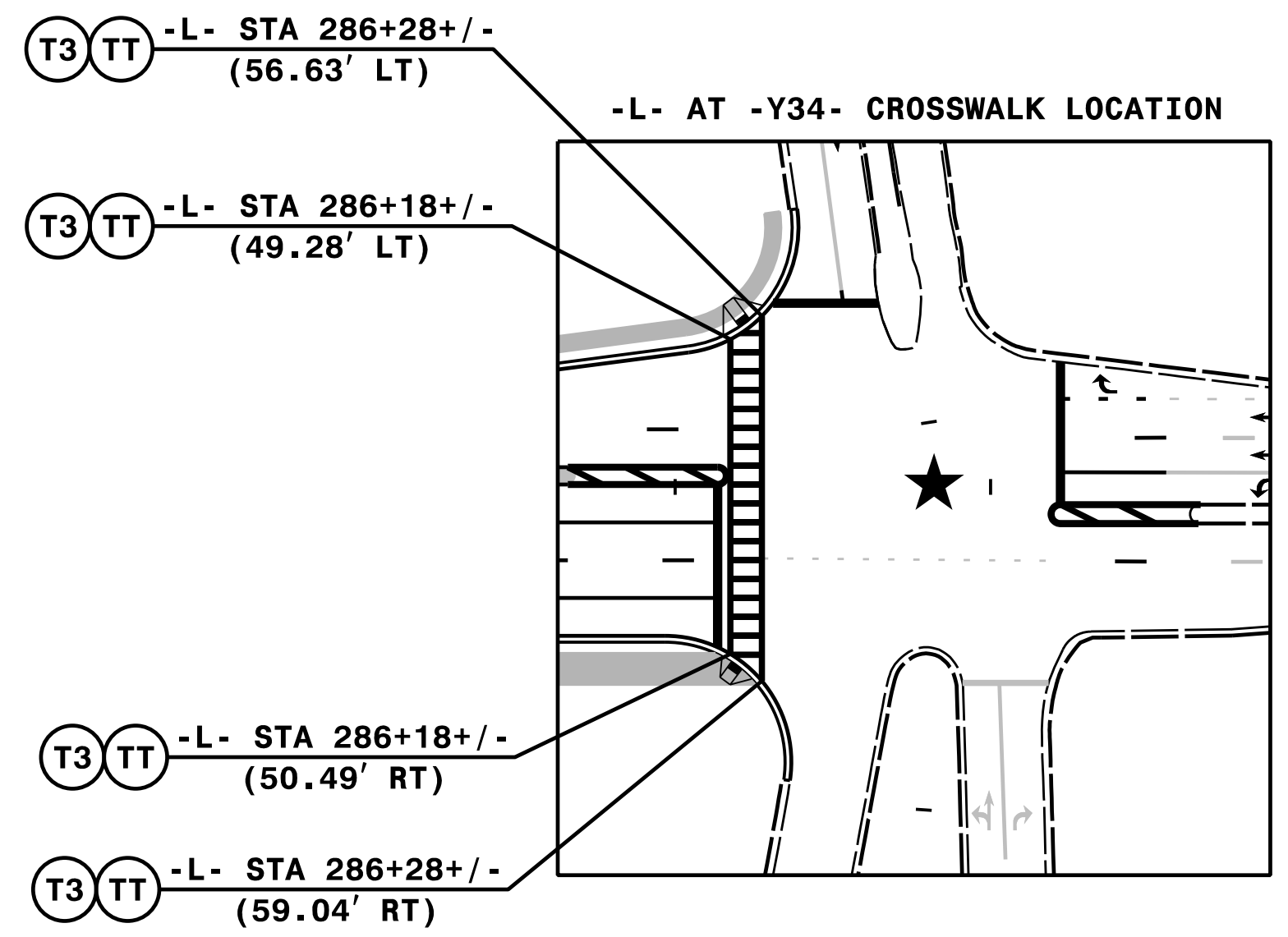
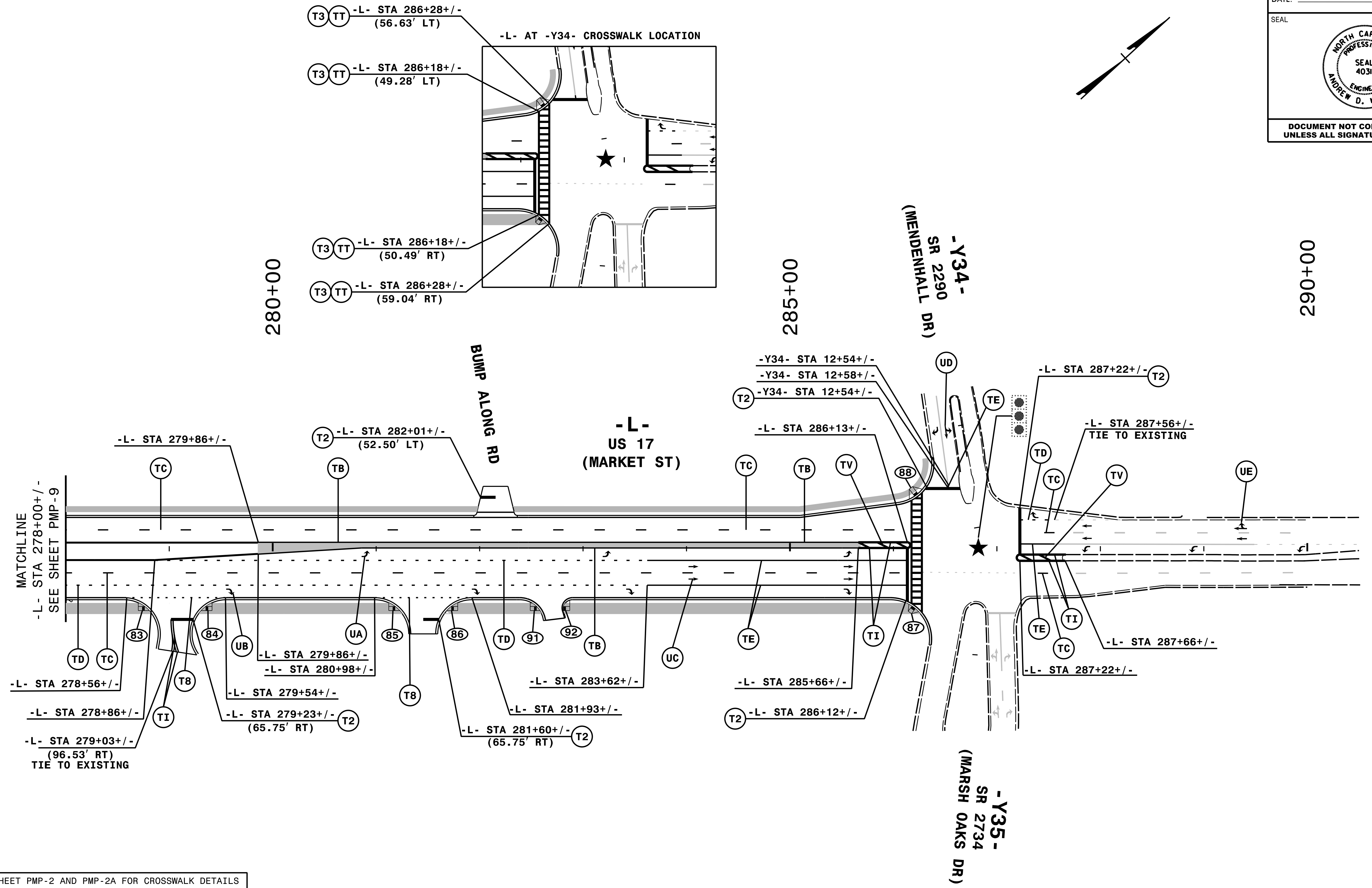

SEE SHEET PMP-2 AND PMP-2A FOR CROSSWALK DETAILS

SEE SHEET PMP-2B FOR CURB RAMP LOCATIONS AND TYPES

NOTE: ALL LANE WIDTHS ARE 12' UNLESS OTHERWISE SHOWN.

ENGINEER TO APPROVE LOCATION OF ALL UNSIGNALIZED STOPBARS.

**HNTB** HNTB NORTH CAROLINA, P.C.  
 343 E. Six Forks Road, Suite 200  
 Raleigh, North Carolina 27609  
 NC License No: C-1554  
 (919) 546-8997

**PAVEMENT MARKING DETAIL**

\$\$\$\$\$SYTIME\$\$\$\$\$  
 \$\$\$DDDCN\$\$\$\$\$  
 \$\$\$USERNAM\$\$\$\$\$

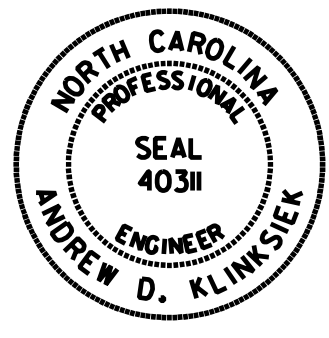
TIP NO.	SHEET NO.
U-4902D	PMP-11
APPROVED: <i>Andrew D. Klinck</i> E-1078F84596E4AB	
DATE: 7/27/2018	
SEAL	
	
DOCUMENT NOT CONSIDERED FINAL UNLESS ALL SIGNATURES COMPLETED	

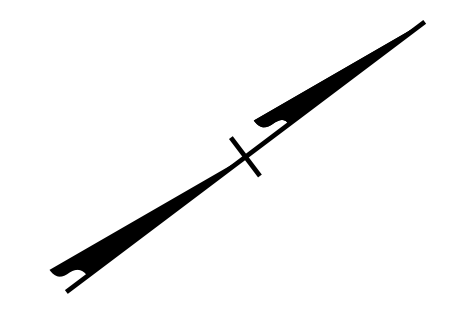

**-L- (US 17) / -Y29- (TORCHWOOD BLVD) /  
-Y30- (BAYSHORE DR)**

SEE SHEET PMP-2 AND PMP-2A FOR CROSSWALK DETAILS

SEE SHEET PMP-6 FOR ADDITIONAL STATIONING

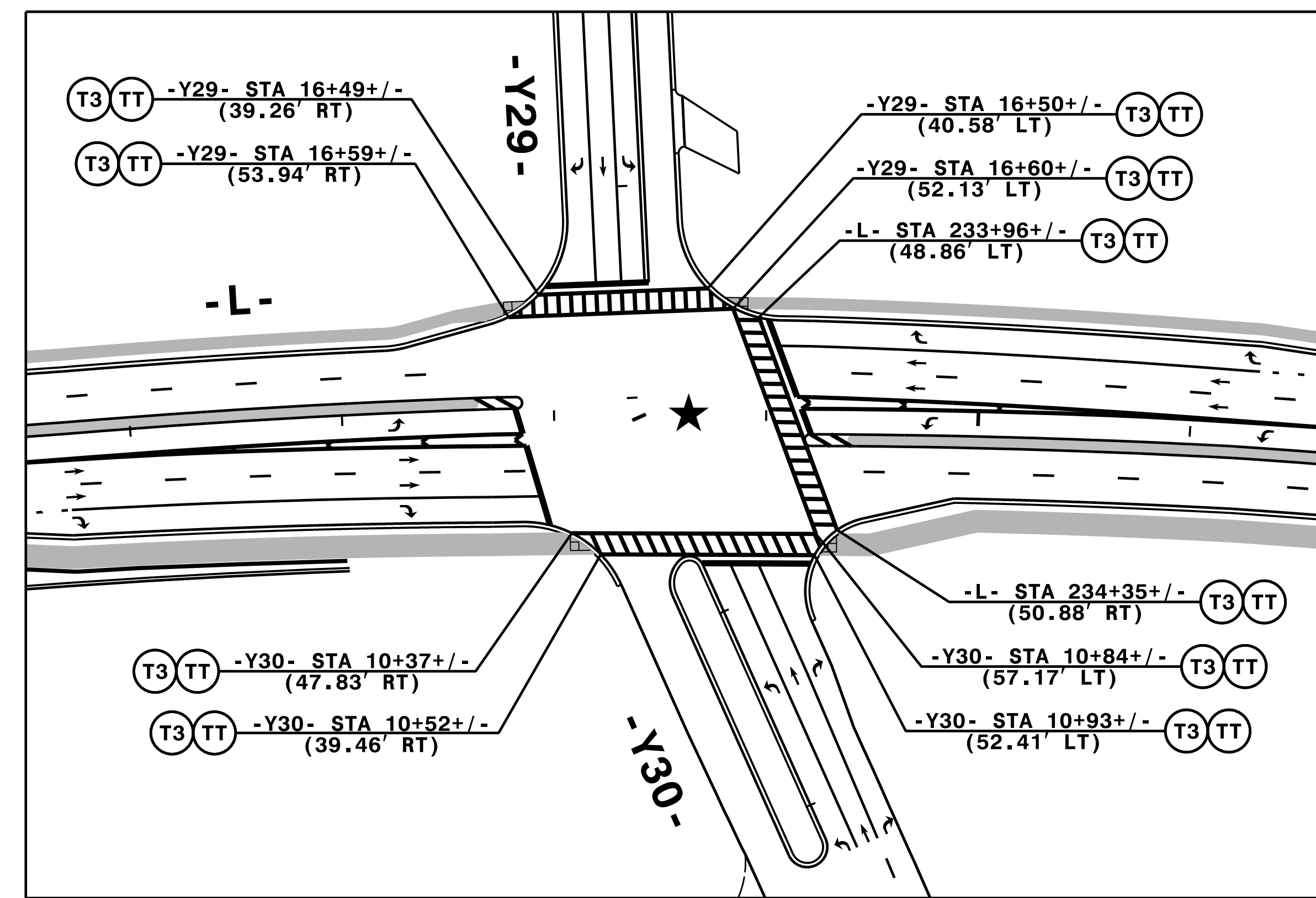

\$\$\$\$\$SYTIME\$\$\$\$\$  
\$\$\$\$\$DGN\$\$\$\$\$  
\$\$\$\$\$USERNAME\$\$\$\$\$

**HNTB** HNTB NORTH CAROLINA, P.C.  
343 E. Six Forks Road, Suite 200  
Raleigh, North Carolina 27609  
NC License No: C-1554  
(919) 546-8997

**PAVEMENT MARKING DETAIL  
CROSSWALK LOCATIONS**