

CONFIDENTIAL AND PROPRIETARY PROPERTY OF
EBDG - NC, PLLC
 MAY NOT BE USED FOR CONSTRUCTION OR PROVIDED TO
 ANY THIRD PARTIES WITHOUT PRIOR WRITTEN CONSENT.
 © 2018 ELLIOTT BAY DESIGN GROUP.

EQUIPMENT LIST

NO.	QTY	DESCRIPTION	COMMENT
1	1	RESCUE BOAT	
2	5	50 PERSON LIFERAFTS	
3	2	RESCUE LADDER	
4	2	LIFE RINGS	
5	2	LIFE RINGS	WITH LINE
6	4	LIFE RINGS	WITH LIGHT
7	300	LIFE JACKETS	ADULT
8	30	LIFE JACKETS	CHILD
9	7	LIFE JACKETS	CREW
10	23	PORTABLE FIRE EXTINGUISHER	TYPE VARIES
11	2	FIRE STATION	
12	1	EYE WASH STATION	

REVISION HISTORY

REV	ZONE	DESCRIPTION	DWN	DATE	APVD
A	SHT 1 SHT 2	1. REVISED LIFE BOAT AND RESCUE LADDER LOCATIONS	KAJ	08/03/18	KAJ

GENERAL NOTES

- VESSEL TO BE CONSTRUCTED IN ACCORDANCE WITH 46 CFR SUBCHAPTER H REGULATIONS.
- FRAME SPACING IS 24" UNLESS NOTED OTHERWISE.

VESSEL PARTICULARS

LENGTH OVERALL:	183'-7"
LENGTH DESIGN LOAD WATERLINE:	178'-3/8"
BEAM, MOLDED:	46'-0"
BEAM OVER GUARDS:	46'-10"
DEPTH AT SIDE:	10'-6"
DRAFT AT DLWL:	4'-6"
FREEBOARD AT SIDE:	6'-0"
TOTAL PASSENGER CAPACITY:	300 MAX.
VEHICLE CAPACITY:	40 SV

REFERENCES

- 18026-200-832-1 TECHNICAL SPECIFICATION
- 18026-200-101-1 PROFILES AND DECK ARRANGEMENTS
- 46 CFR SUBCHAPTER H



Elliott Bay Design Group
 North Carolina, PLLC

CLIENT: NORTH CAROLINA D.O.T.
 RALEIGH, NORTH CAROLINA
 PROJECT: DOUBLE-ENDED AZIMUTH DRIVE FERRY

TITLE: LIFE SAVING EQUIPMENT ARRANGEMENT

SIZE	DWG NO.	REV
D	18026-200-101-3	A
SCALE	FILE NAME	SHEET
1/8"=1'-0"	18026-200-101-3-	1 OF 4
DWN	MOD	CKD
MWR	NJB	NJB
APVD	APVD DATE	
KAJ	7/25/18	

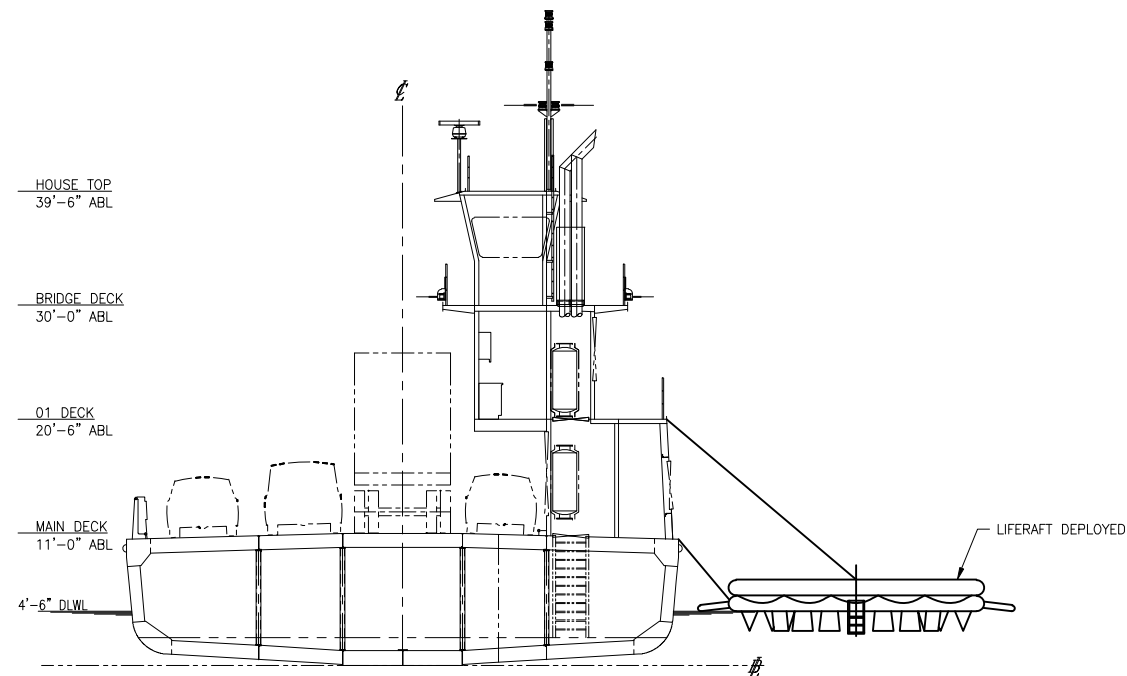

MIDSHIP SECTION
 LIFERAFT DEPLOYED

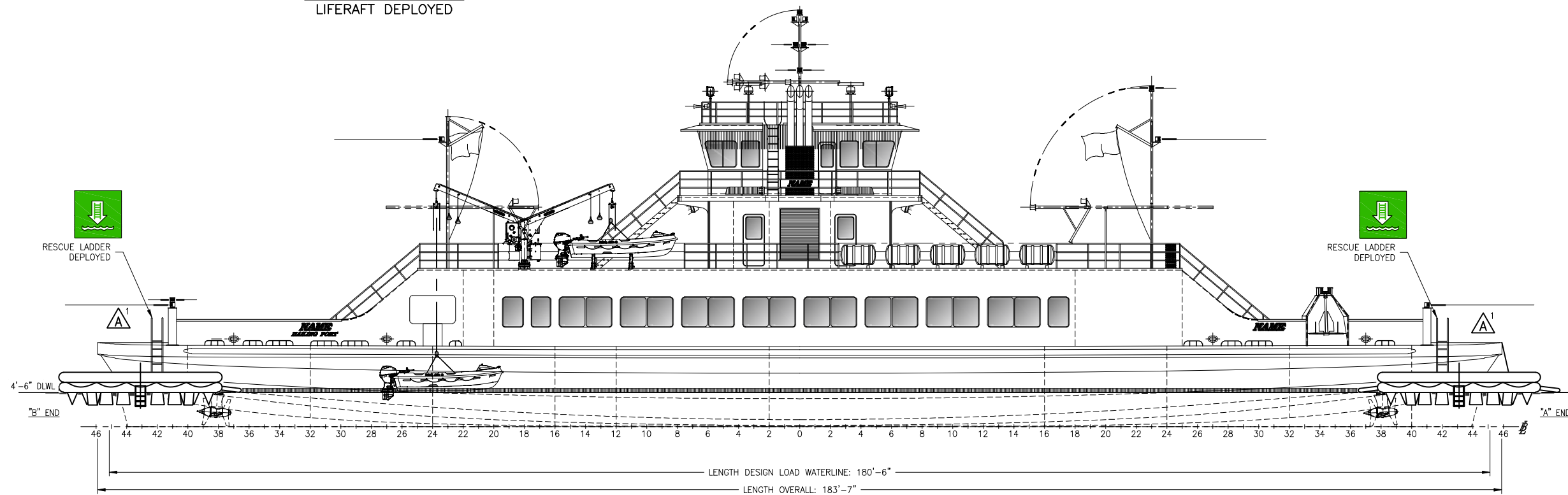

OUTBOARD PROFILE

8/3/2018 3:10:03 PM

CONFIDENTIAL AND PROPRIETARY PROPERTY OF
EBDG - NC, PLLC
 MAY NOT BE USED FOR CONSTRUCTION OR PROVIDED TO
 ANY THIRD PARTIES WITHOUT PRIOR WRITTEN CONSENT.
 © 2018 ELLIOTT BAY DESIGN GROUP.

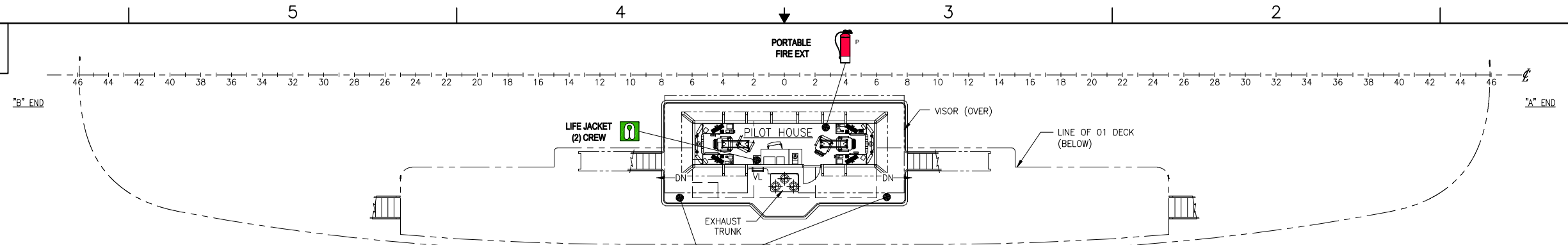

BRIDGE DECK PLAN

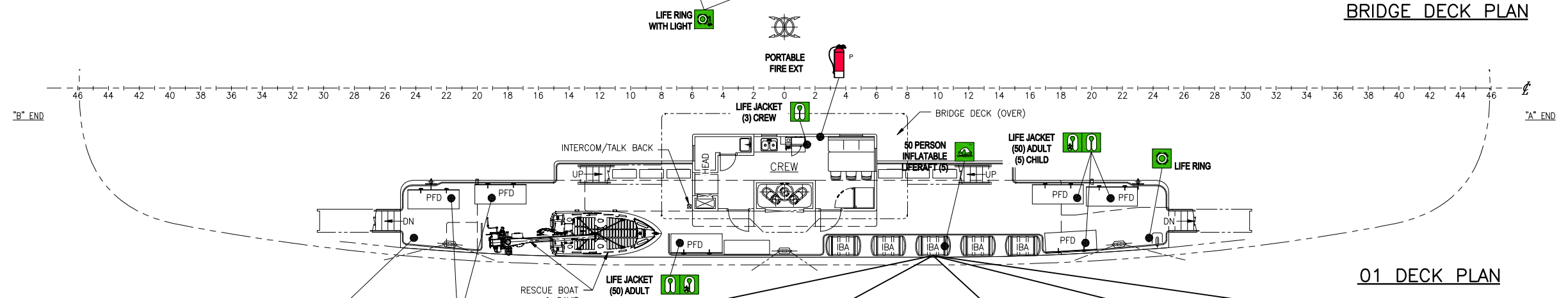

01 DECK PLAN

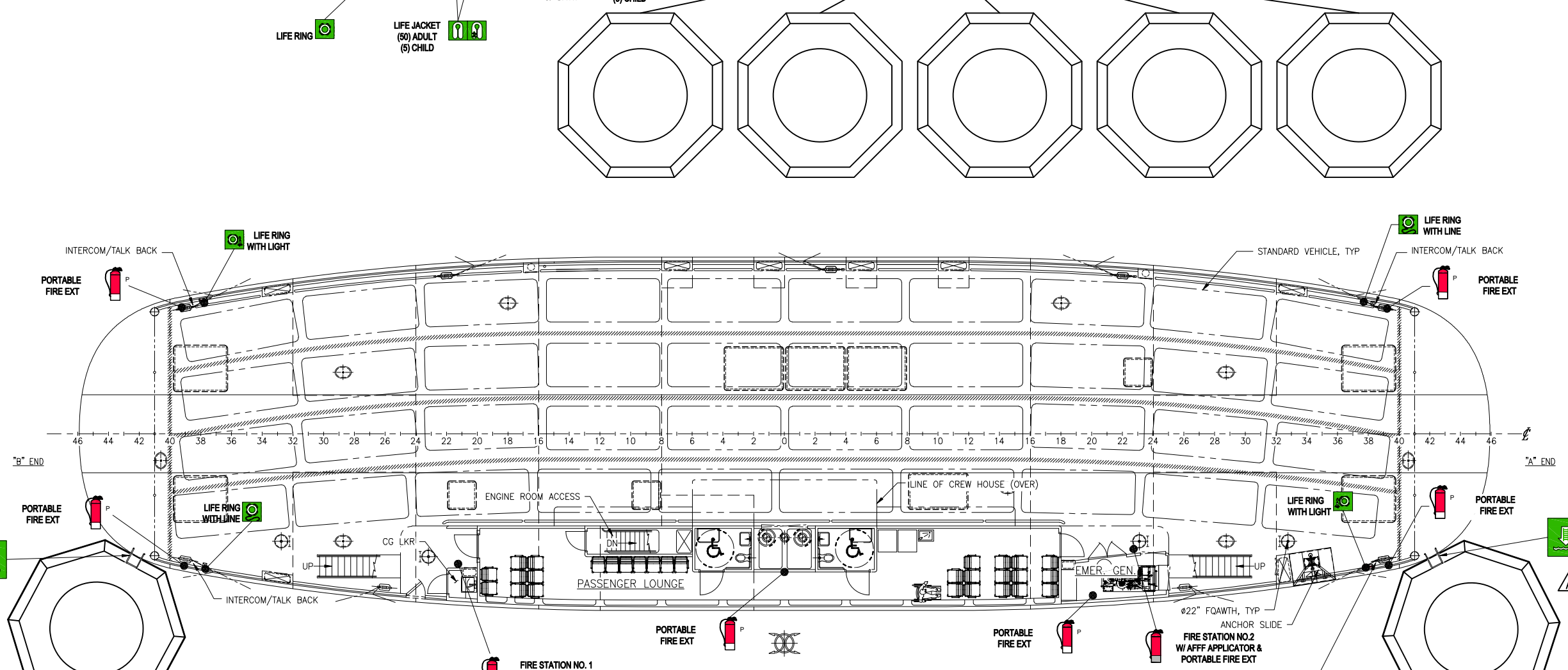

MAIN DECK PLAN



SIZE	D	DWG NO.	18026-200-101-3	REV	A
SCALE	1/8"=1'-0"		FILE NAME	18026-200-101-3-	SHEET 2 OF 4

8/3/2018 3:10:15 PM

CONFIDENTIAL AND PROPRIETARY PROPERTY OF
EBDG - NC, PLLC
 MAY NOT BE USED FOR CONSTRUCTION OR PROVIDED TO
 ANY THIRD PARTIES WITHOUT PRIOR WRITTEN CONSENT.
 ©2018 ELLIOTT BAY DESIGN GROUP.

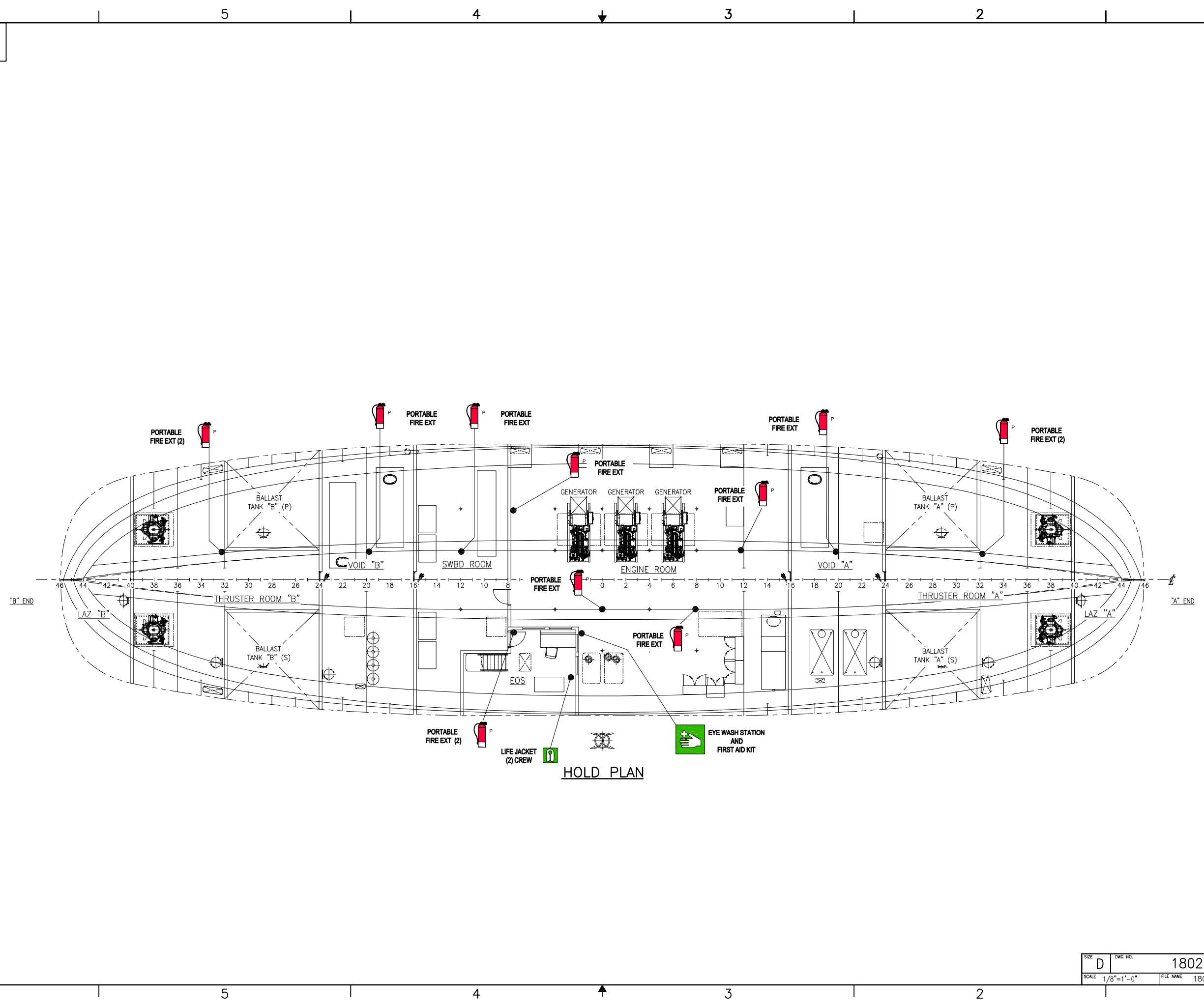

HOLD PLAN



SIZE	D	DWG NO.	18026-200-101-3	REV	A
SCALE	1/8"=1'-0"	FILE NAME	18026-200-101-3-	SHEET	3 OF 4

8/3/2018 3:10:34 PM

CONFIDENTIAL AND PROPRIETARY PROPERTY OF
EBDG - NC, PLLC
 MAY NOT BE USED FOR CONSTRUCTION OR PROVIDED TO
 ANY THIRD PARTIES WITHOUT PRIOR WRITTEN CONSENT.
 © 2018 ELLIOTT BAY DESIGN GROUP.

6 | 5 | 4 | 3 | 2 | 1

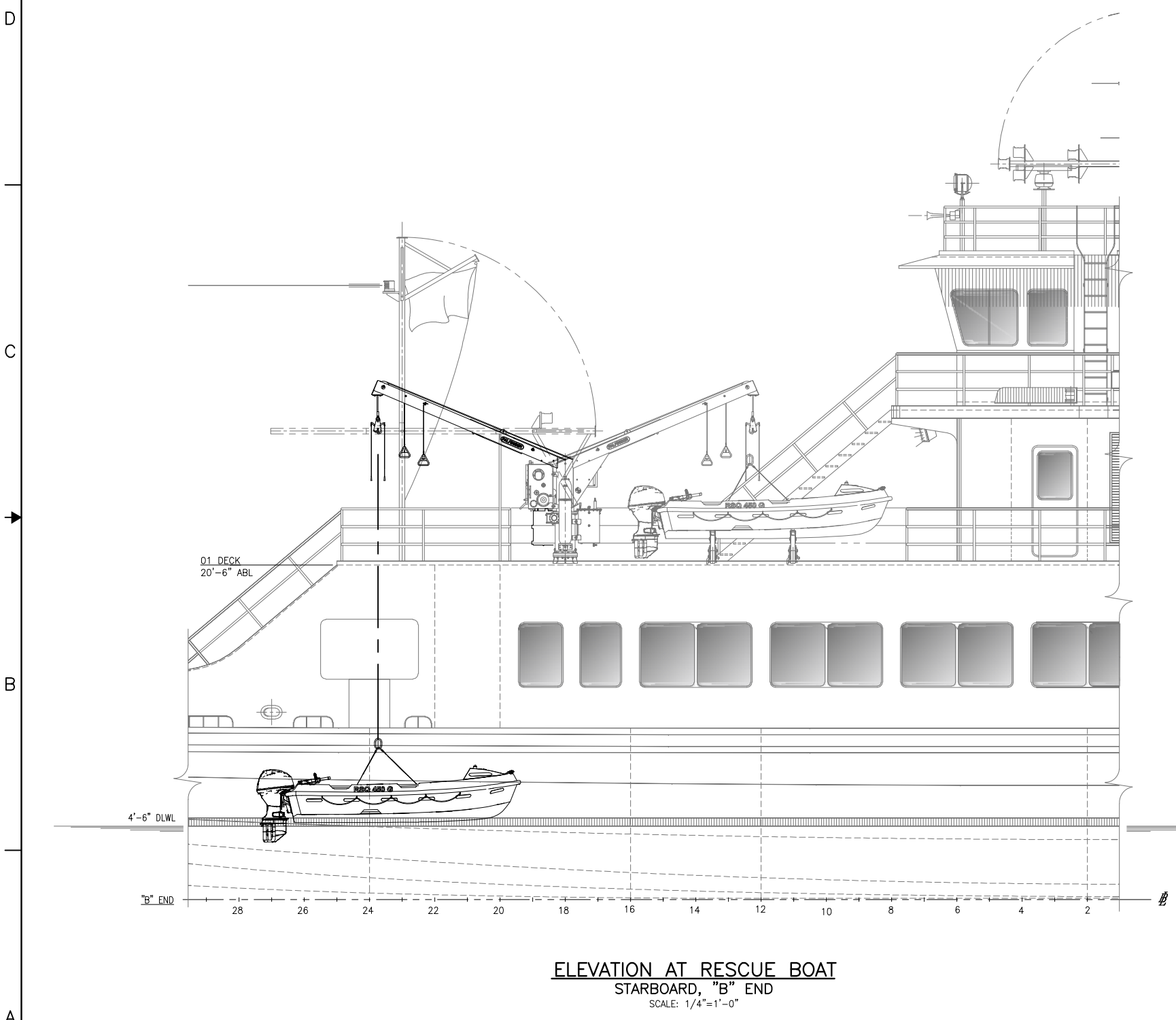

ELEVATION AT RESCUE BOAT
 STARBOARD, "B" END
 SCALE: 1/4"=1'-0"

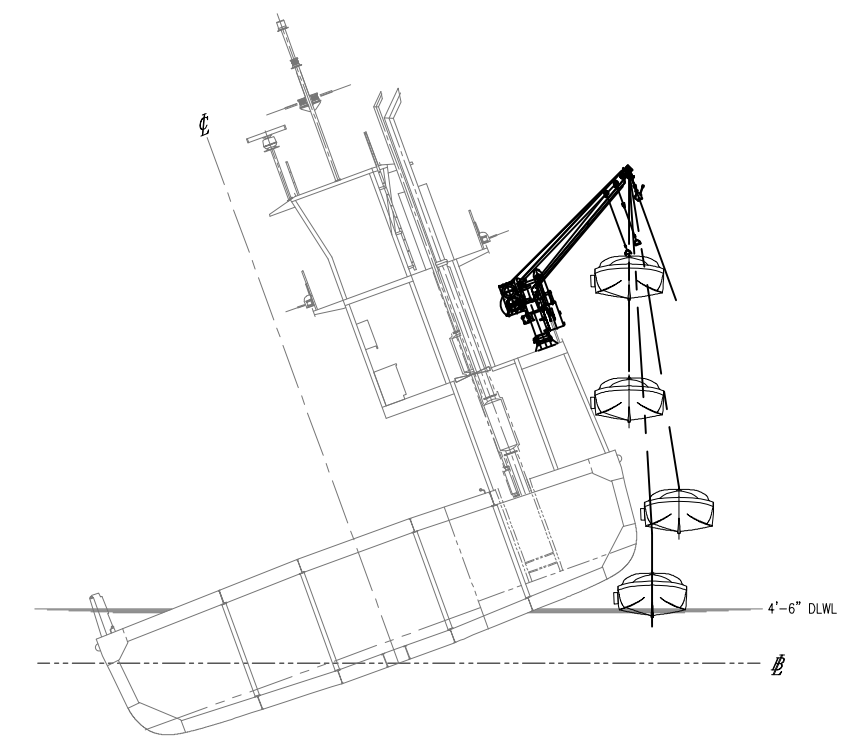

SECTION OF VESSEL AT 20° HEEL
 LOOKING FWD
 SCALE: 1/8"=1'-0"

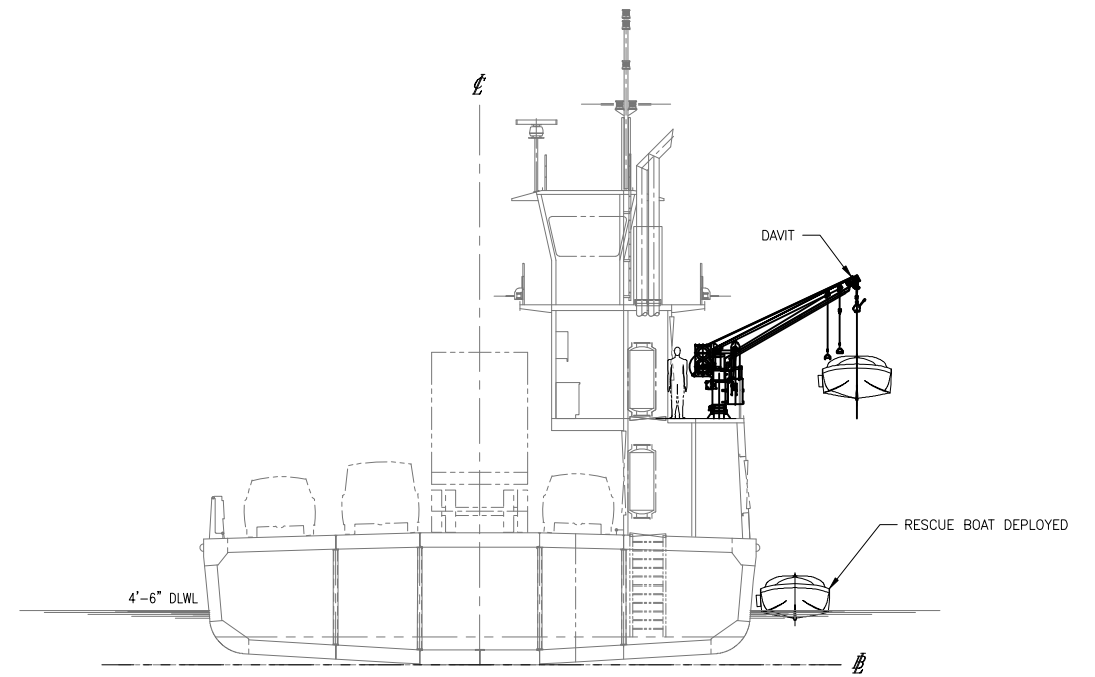

SECTION OF VESSEL AT EVEN KEEL
 LOOKING FWD
 SCALE: 1/8"=1'-0"



SIZE	D	OWG NO.	18026-200-101-3	REV	A
SCALE	AS NOTED	FILE NAME	18026-200-101-3-	SHEET	4 OF 4

6 | 5 | 4 | 3 | 2 | 1

8/3/2018 3:10:45 PM