

STATE OF NORTH CAROLINA
DEPARTMENT OF TRANSPORTATION
RALEIGH, N.C.

PROPOSAL

INCLUDES ADDENDUM No. 1 DATED 06-05-2018

DATE AND TIME OF BID OPENING: **JUNE 19, 2018 AT 2:00 PM**

CONTRACT ID C204122

WBS 50454.3.1

FEDERAL-AID NO. NHPIM-0040(9)214

COUNTY GUILFORD

T.I.P. NO. I-5811

MILES 4.720

ROUTE NO. I 40

LOCATION I-40 FROM WEST OF I-73 TO EAST OF HOLDEN RD OVERPASS IN GREENSBORO.

TYPE OF WORK PAVEMENT REHABILITATION.

NOTICE:

ALL BIDDERS SHALL COMPLY WITH ALL APPLICABLE LAWS REGULATING THE PRACTICE OF GENERAL CONTRACTING AS CONTAINED IN CHAPTER 87 OF THE GENERAL STATUTES OF NORTH CAROLINA WHICH REQUIRES THE BIDDER TO BE LICENSED BY THE N.C. LICENSING BOARD FOR CONTRACTORS WHEN BIDDING ON ANY NON-FEDERAL AID PROJECT WHERE THE BID IS \$30,000 OR MORE, EXCEPT FOR CERTAIN SPECIALTY WORK AS DETERMINED BY THE LICENSING BOARD. BIDDERS SHALL ALSO COMPLY WITH ALL OTHER APPLICABLE LAWS REGULATING THE PRACTICES OF ELECTRICAL, PLUMBING, HEATING AND AIR CONDITIONING AND REFRIGERATION CONTRACTING AS CONTAINED IN CHAPTER 87 OF THE GENERAL STATUTES OF NORTH CAROLINA. NOTWITHSTANDING THESE LIMITATIONS ON BIDDING, THE BIDDER WHO IS AWARDED ANY FEDERAL - AID FUNDED PROJECT SHALL COMPLY WITH CHAPTER 87 OF THE GENERAL STATUTES OF NORTH CAROLINA FOR LICENSING REQUIREMENTS WITHIN 60 CALENDAR DAYS OF BID OPENING.

BIDS WILL BE RECEIVED AS SHOWN BELOW:

THIS IS A ROADWAY PROPOSAL

5% BID BOND OR BID DEPOSIT REQUIRED

**PROPOSAL FOR THE CONSTRUCTION OF
CONTRACT No. C204122 IN GUILFORD COUNTY, NORTH CAROLINA**

Date _____ 20 _____

**DEPARTMENT OF TRANSPORTATION,
RALEIGH, NORTH CAROLINA**

The Bidder has carefully examined the location of the proposed work to be known as Contract No. C204122 has carefully examined the plans and specifications, which are acknowledged to be part of the proposal, the special provisions, the proposal, the form of contract, and the forms of contract payment bond and contract performance bond; and thoroughly understands the stipulations, requirements and provisions. The undersigned bidder agrees to bound upon his execution of the bid and subsequent award to him by the Board of Transportation in accordance with this proposal to provide the necessary contract payment bond and contract performance bond within fourteen days after the written notice of award is received by him. The undersigned Bidder further agrees to provide all necessary machinery, tools, labor, and other means of construction; and to do all the work and to furnish all materials, except as otherwise noted, necessary to perform and complete the said contract in accordance with *the 2018 Standard Specifications for Roads and Structures* by the dates(s) specified in the Project Special Provisions and in accordance with the requirements of the Engineer, and at the unit or lump sum prices, as the case may be, for the various items given on the sheets contained herein.

The Bidder shall provide and furnish all the materials, machinery, implements, appliances and tools, and perform the work and required labor to construct and complete State Highway Contract No. C204122 in Guilford County, for the unit or lump sum prices, as the case may be, bid by the Bidder in his bid and according to the proposal, plans, and specifications prepared by said Department, which proposal, plans, and specifications show the details covering this project, and hereby become a part of this contract.

The published volume entitled *North Carolina Department of Transportation, Raleigh, Standard Specifications for Roads and Structures, January 2018* with all amendments and supplements thereto, is by reference incorporated into and made a part of this contract; that, except as herein modified, all the construction and work included in this contract is to be done in accordance with the specifications contained in said volume, and amendments and supplements thereto, under the direction of the Engineer.

If the proposal is accepted and the award is made, the contract is valid only when signed either by the Contract Officer or such other person as may be designated by the Secretary to sign for the Department of Transportation. The conditions and provisions herein cannot be changed except over the signature of the said Contract Officer.

The quantities shown in the itemized proposal for the project are considered to be approximate only and are given as the basis for comparison of bids. The Department of Transportation may increase or decrease the quantity of any item or portion of the work as may be deemed necessary or expedient.

An increase or decrease in the quantity of an item will not be regarded as sufficient ground for an increase or decrease in the unit prices, nor in the time allowed for the completion of the work, except as provided for the contract.

Accompanying this bid is a bid bond secured by a corporate surety, or certified check payable to the order of the Department of Transportation, for five percent of the total bid price, which deposit is to be forfeited as liquidated damages in case this bid is accepted and the Bidder shall fail to provide the required payment and performance bonds with the Department of Transportation, under the condition of this proposal, within 14 calendar days after the written notice of award is received by him, as provided in the *Standard Specifications*; otherwise said deposit will be returned to the Bidder.



State Contract Officer

DocuSigned by:
Ronald E. Davenport, Jr.
F81B6038A47A442...

6/5/2018

TABLE OF CONTENTS

**COVER SHEET
PROPOSAL SHEET**

PROJECT SPECIAL PROVISIONS

CONTRACT TIME AND LIQUIDATED DAMAGES: G-1
INTERMEDIATE CONTRACT TIME NUMBER 1 AND LIQUIDATED DAMAGES: G-1
INTERMEDIATE CONTRACT TIME NUMBER 2 AND LIQUIDATED DAMAGES: G-2
INTERMEDIATE CONTRACT TIME NUMBER 3 AND LIQUIDATED DAMAGES: G-2
INTERMEDIATE CONTRACT TIME NUMBER 4 AND LIQUIDATED DAMAGES: G-4
INTERMEDIATE CONTRACT TIME NUMBER 5 AND LIQUIDATED DAMAGES: G-4
MAJOR CONTRACT ITEMS: G-4
SPECIALTY ITEMS: G-5
FUEL PRICE ADJUSTMENT: G-5
SCHEDULE OF ESTIMATED COMPLETION PROGRESS: G-6
DISADVANTAGED BUSINESS ENTERPRISE: G-6
CERTIFICATION FOR FEDERAL-AID CONTRACTS: G-19
CONTRACTOR'S LICENSE REQUIREMENTS: G-19
U.S. DEPARTMENT OF TRANSPORTATION HOTLINE: G-19
CARGO PREFERENCE ACT: G-20
MAINTENANCE OF THE PROJECT: G-20
COOPERATION BETWEEN CONTRACTORS: G-21
EROSION AND SEDIMENT CONTROL/STORMWATER CERTIFICATION: G-21

ROADWAY R-1

STANDARD SPECIAL PROVISIONS

AVAILABILITY FUNDS – TERMINATION OF CONTRACTS SSP-1
NCDOT GENERAL SEED SPECIFICATION FOR SEED QUALITY SSP-2
ERRATA SSP-5
PLANT AND PEST QUARANTINES SSP-6
TITLE VI AND NONDISCRIMINATION SSP-7
MINORITY AND FEMALE EMPLOYMENT REQUIREMENTS SSP-16
REQUIRED CONTRACT PROVISIONS FEDERAL-AID CONST. CONTRACTS SSP-19
ON-THE-JOB TRAINING SSP-28
MINIMUM WAGES SSP-31

UNIT PROJECT SPECIAL PROVISIONS

PAVEMENT MARKINGS PM-1
TRAFFIC CONTROL TC-1
EROSION CONTROL EC-1

PROPOSAL ITEM SHEET

ITEM SHEET(S) (TAN SHEETS)

SKETCH MAPS (INSERT)

PROJECT SPECIAL PROVISIONS**GENERAL****CONTRACT TIME AND LIQUIDATED DAMAGES:**

(7-1-95) (Rev. 12-18-07)

108

SP1 G10 A

The date of availability for this contract is **July 30, 2018**.

The completion date for this contract is **October 15, 2019**.

Except where otherwise provided by the contract, observation periods required by the contract will not be a part of the work to be completed by the completion date and/or intermediate contract times stated in the contract. The acceptable completion of the observation periods that extend beyond the final completion date shall be a part of the work covered by the performance and payment bonds.

The liquidated damages for this contract are **One Thousand Five Hundred Dollars (\$ 1,500.00)** per calendar day.

INTERMEDIATE CONTRACT TIME NUMBER 1 AND LIQUIDATED DAMAGES:

(2-20-07)

108

SP1 G14 C

The Contractor shall complete the required work of installing, maintaining and removing the traffic control devices for lane closures and restoring traffic to the existing traffic pattern. The Contractor shall not close or narrow **a lane** of traffic on **I-40 and multi-lane Ramps / Loops** during the following time restrictions:

DAY AND TIME RESTRICTIONS**Monday thru Sunday, 6:00 a.m. to 8:00 p.m.**

The time of availability for this intermediate contract time will be the time the Contractor begins to install traffic control devices required for the lane closures according to the time restrictions stated herein.

The completion time for this intermediate contract time will be the time the Contractor is required to complete the removal of traffic control devices required for the lane closures according to the time restrictions stated herein and restore traffic to the existing traffic pattern.

The liquidated damages are **One Thousand Two Hundred Fifty Dollars (\$ 1,250.00)** per fifteen **(15)** minute time period.

INTERMEDIATE CONTRACT TIME NUMBER 2 AND LIQUIDATED DAMAGES:

(2-20-07)

108

SP1 G14 C

The Contractor shall complete the required work of installing, maintaining and removing the traffic control devices for lane closures and restoring traffic to the existing traffic pattern. The Contractor shall not close or narrow **two (2) lanes** of traffic on **I-40** during the following time restrictions:

DAY AND TIME RESTRICTIONS

Monday thru Sunday, 6:00 a.m. to 10:00 p.m.

The time of availability for this intermediate contract time will be the time the Contractor begins to install traffic control devices required for the lane closures according to the time restrictions stated herein.

The completion time for this intermediate contract time will be the time the Contractor is required to complete the removal of traffic control devices required for the lane closures according to the time restrictions stated herein and restore traffic to the existing traffic pattern.

The liquidated damages are **One Thousand Eight Hundred Seventy Five Dollars (\$ 1,875.00)** per fifteen **(15)** minute time period.

INTERMEDIATE CONTRACT TIME NUMBER 3 AND LIQUIDATED DAMAGES:

(2-20-07)

108

SP1 G14 A

The Contractor shall complete the required work of installing, maintaining and removing the traffic control devices for lane closures and restoring traffic to the existing traffic pattern. The Contractor shall not close or narrow **three (3) lanes** of traffic on **I-40** during the following time restrictions:

DAY AND TIME RESTRICTIONS

Monday thru Sunday, 6:00 a.m. to 11:00 p.m.

In addition, the Contractor shall not close or narrow **a lane** of traffic on **I-40**, detain and/or alter the traffic flow on or during holidays, holiday weekends, special events, or any other time when traffic is unusually heavy, including the following schedules:

HOLIDAY AND HOLIDAY WEEKEND LANE CLOSURE RESTRICTIONS

1. For **unexpected occurrence** that creates unusually high traffic volumes, as directed by the Engineer.
2. For **New Year's**, between the hours of **6:00 a.m.** December 31st and **8:00 p.m.** January 2nd. If New Year's Day is on a Friday, Saturday, Sunday or Monday, then until **8:00 p.m.** the following Tuesday.
3. For **Easter**, between the hours of **6:00 a.m.** Thursday and **8:00 p.m.** Monday.
4. For **Memorial Day**, between the hours of **6:00 a.m.** Friday and **8:00 p.m.** Tuesday.

5. For **Independence Day**, between the hours of **6:00 a.m.** the day before Independence Day and **8:00 p.m.** the day after Independence Day.

If **Independence Day** is on a Friday, Saturday, Sunday or Monday, then between the hours of **6:00 a.m.** the Thursday before Independence Day and **8:00 p.m.** the Tuesday after Independence Day.

6. For **Labor Day**, between the hours of **6:00 a.m.** Friday and **8:00 p.m.** Tuesday.
7. For **Thanksgiving**, between the hours of **6:00 a.m.** Tuesday and **8:00 p.m.** Monday.
8. For **Christmas**, between the hours of **6:00 a.m.** the Friday before the week of Christmas Day and **8:00 p.m.** the following Tuesday after the week of Christmas Day.
9. For the **City of High Point Furniture Market**, between the hours of **6:00 a.m.** the **Monday** before the Market begins and **8:00 p.m.** the **Friday** after the Market ends.
10. For the **Wyndham Golf Tournament**, between the hours of **6:00 a.m.** the Friday before the week of the Tournament and **8:00 p.m.** the following **Monday** after the week of the Tournament.
11. For the **North Carolina A&T State University Homecoming**, between the hours **6:00 a.m.** the **Friday** before Homecoming and **8:00 p.m.** the **Monday** after Homecoming.
12. For **Major Events** and **local College Graduations** held at **Greensboro Coliseum**, between the hours of **6:00 a.m.** the day before the event and **8:00 p.m.** the day after the event.

Holidays and holiday weekends shall include New Year's, Easter, Memorial Day, Independence Day, Labor Day, Thanksgiving, and Christmas. The Contractor shall schedule his work so that lane closures are not required during these periods, unless otherwise directed by the Engineer.

When Holiday and Holiday Weekend Lane Closure Restrictions are no longer in effect, then the Day and Time Restrictions shall be in effect.

The time of availability for this intermediate contract time will be the time the Contractor begins to install traffic control devices required for the lane closures according to the time restrictions stated herein.

The completion time for this intermediate contract time will be the time the Contractor is required to complete the removal of traffic control devices required for the lane closures according to the time restrictions stated herein and restore traffic to the existing traffic pattern.

The liquidated damages are **Two Thousand Five Hundred Dollars (\$ 2,500.00)** per fifteen (15) minute time period.

INTERMEDIATE CONTRACT TIME NUMBER 4 AND LIQUIDATED DAMAGES:

(2-20-07)

108

SP1 G14 D

The Contractor shall complete the required work of installing, maintaining and removing the traffic control devices for road closures and restoring traffic to the existing traffic pattern. The Contractor shall not close any **I-40 Single-Lane Ramps and/or Loops** during the following time restrictions:

DAY AND TIME RESTRICTIONS

Monday thru Sunday, 6:00 a.m. to 11:00 p.m.

The time of availability for this intermediate contract time will be the time the Contractor begins to install traffic control devices required for road closures according to the time restrictions stated herein.

The completion time for this intermediate contract time will be the time the Contractor is required to complete the removal of traffic control devices required for the road closures according to the time restrictions stated herein and restore traffic to the existing traffic pattern.

The liquidated damages are **One Thousand Dollars (\$ 1,000.00)** per fifteen (15) minute time period.

INTERMEDIATE CONTRACT TIME NUMBER 5 AND LIQUIDATED DAMAGES:

(5-21-13)

108

SP1 G14 I

The Contractor shall complete the work required of installing each new **deep cut** inductive loop prior to the removal of each existing loop by the milling, patching or resurfacing operations and shall place and maintain traffic on same.

The time of availability for this intermediate contract time is the **day at 12:00 a.m. (Midnight)** that the Contractor elects to begin the work.

The completion time for this intermediate contract time is the **following 6:00 a.m.** after the time of availability.

The liquidated damages are **Five Hundred Dollars (\$ 500.00)** per hour.

MAJOR CONTRACT ITEMS:

(2-19-02)

104

SP1 G28

The following listed items are the major contract items for this contract (see Article 104-5 of the *2018 Standard Specifications*):

Line #	Description
7 —	Asphalt Concrete Surface Course, Type S9.5 D
10 —	Open-Graded Asphalt Friction Course, Type FC-1 Modified

SPECIALTY ITEMS:

(7-1-95)(Rev. 1-17-12)

108-6

SP1 G37

Items listed below will be the specialty items for this contract (see Article 108-6 of the 2018 Standard Specifications).

Line #	Description
28-35,42-43,45-46	Long-Life Pavement Markings
47	Permanent Pavement Markers
50	Erosion Control
51	Signals/ITS System

FUEL PRICE ADJUSTMENT:

(11-15-05) (Rev. 2-18-14)

109-8

SP1 G43

Revise the 2018 Standard Specifications as follows:

Page 1-83, Article 109-8, Fuel Price Adjustments, add the following:

The base index price for DIESEL #2 FUEL is \$ **2.2154** per gallon. Where any of the following are included as pay items in the contract, they will be eligible for fuel price adjustment.

The pay items and the fuel factor used in calculating adjustments to be made will be as follows:

Description	Units	Fuel Usage Factor Diesel
Unclassified Excavation	Gal/CY	0.29
Borrow Excavation	Gal/CY	0.29
Class IV Subgrade Stabilization	Gal/Ton	0.55
Aggregate Base Course	Gal/Ton	0.55
Sub-Ballast	Gal/Ton	0.55
Asphalt Concrete Base Course, Type ____	Gal/Ton	2.90
Asphalt Concrete Intermediate Course, Type ____	Gal/Ton	2.90
Asphalt Concrete Surface Course, Type ____	Gal/Ton	2.90
Open-Graded Asphalt Friction Course	Gal/Ton	2.90
Permeable Asphalt Drainage Course, Type ____	Gal/Ton	2.90
Sand Asphalt Surface Course, Type ____	Gal/Ton	2.90
Aggregate for Cement Treated Base Course	Gal/Ton	0.55
Portland Cement for Cement Treated Base Course	Gal/Ton	0.55
__" Portland Cement Concrete Pavement	Gal/SY	0.245
Concrete Shoulders Adjacent to __" Pavement	Gal/SY	0.245

SCHEDULE OF ESTIMATED COMPLETION PROGRESS:

(7-15-08) (Rev. 6-19-18)

108-2

SP1 G58

The Contractor's attention is directed to the Standard Special Provision entitled *Availability of Funds Termination of Contracts* included elsewhere in this proposal. The Department of Transportation's schedule of estimated completion progress for this project as required by that Standard Special Provision is as follows:

	<u>Fiscal Year</u>	<u>Progress (% of Dollar Value)</u>
2019	(7/01/18 - 6/30/19)	87 % of Total Amount Bid
2020	(7/01/19 – 6/30/20)	13 % of Total Amount Bid

The Contractor shall also furnish his own progress schedule in accordance with Article 108-2 of the *2018 Standard Specifications*. Any acceleration of the progress as shown by the Contractor's progress schedule over the progress as shown above shall be subject to the approval of the Engineer.

DISADVANTAGED BUSINESS ENTERPRISE:

(10-16-07)(Rev. 1-17-17)

102-15(J)

SP1 G61

Description

The purpose of this Special Provision is to carry out the U.S. Department of Transportation's policy of ensuring nondiscrimination in the award and administration of contracts financed in whole or in part with Federal funds. This provision is guided by 49 CFR Part 26.

Definitions

Additional DBE Subcontractors - Any DBE submitted at the time of bid that will not be used to meet the DBE goal. No submittal of a Letter of Intent is required.

Committed DBE Subcontractor - Any DBE submitted at the time of bid that is being used to meet the DBE goal by submission of a Letter of Intent. Or any DBE used as a replacement for a previously committed DBE firm.

Contract Goal Requirement - The approved DBE participation at time of award, but not greater than the advertised contract goal.

DBE Goal - A portion of the total contract, expressed as a percentage that is to be performed by committed DBE subcontractor.

Disadvantaged Business Enterprise (DBE) - A firm certified as a Disadvantaged Business Enterprise through the North Carolina Unified Certification Program.

Goal Confirmation Letter - Written documentation from the Department to the bidder confirming the Contractor's approved, committed DBE participation along with a listing of the committed DBE firms.

Manufacturer - A firm that operates or maintains a factory or establishment that produces on the premises, the materials or supplies obtained by the Contractor.

Regular Dealer - A firm that owns, operates, or maintains a store, warehouse, or other establishment in which the materials or supplies required for the performance of the contract are bought, kept in stock, and regularly sold to the public in the usual course of business. A regular dealer engages in, as its principal business and in its own name, the purchase and sale or lease of the products in question. A regular dealer in such bulk items as steel, cement, gravel, stone, and petroleum products need not keep such products in stock, if it owns and operates distribution equipment for the products. Brokers and packagers are not regarded as manufacturers or regular dealers within the meaning of this section.

North Carolina Unified Certification Program (NCUCP) - A program that provides comprehensive services and information to applicants for DBE certification, such that an applicant is required to apply only once for a DBE certification that will be honored by all recipients of USDOT funds in the state and not limited to the Department of Transportation only. The Certification Program is in accordance with 49 CFR Part 26.

United States Department of Transportation (USDOT) - Federal agency responsible for issuing regulations (49 CFR Part 26) and official guidance for the DBE program.

Forms and Websites Referenced in this Provision

DBE Payment Tracking System - On-line system in which the Contractor enters the payments made to DBE subcontractors who have performed work on the project.
<https://apps.dot.state.nc.us/Vendor/PaymentTracking/>

DBE-IS Subcontractor Payment Information - Form for reporting the payments made to all DBE firms working on the project. This form is for paper bid projects only.
<https://connect.ncdot.gov/business/Turnpike/Documents/Form%20DBE-IS%20Subcontractor%20Payment%20Information.pdf>

RF-1 DBE Replacement Request Form - Form for replacing a committed DBE.
<http://connect.ncdot.gov/projects/construction/Construction%20Forms/DBE%20MBE%20WBE%20Replacement%20Request%20Form.pdf>

SAF Subcontract Approval Form - Form required for approval to sublet the contract.
<http://connect.ncdot.gov/projects/construction/Construction%20Forms/Subcontract%20Approval%20Form%20Rev.%202012.zip>

JC-1 Joint Check Notification Form - Form and procedures for joint check notification. The form acts as a written joint check agreement among the parties providing full and prompt disclosure of the expected use of joint checks.
<http://connect.ncdot.gov/projects/construction/Construction%20Forms/Joint%20Check%20Notification%20Form.pdf>

Letter of Intent - Form signed by the Contractor and the DBE subcontractor, manufacturer or regular dealer that affirms that a portion of said contract is going to be performed by the signed DBE for the amount listed at the time of bid.

<http://connect.ncdot.gov/letting/LetCentral/Letter%20of%20Intent%20to%20Perform%20as%20a%20Subcontractor.pdf>

Listing of DBE Subcontractors Form - Form for entering DBE subcontractors on a project that will meet this DBE goal. This form is for paper bids only.

[http://connect.ncdot.gov/municipalities/Bid%20Proposals%20for%20LGA%20Content/08%20DBE%20Subcontractors%20\(Federal\).docx](http://connect.ncdot.gov/municipalities/Bid%20Proposals%20for%20LGA%20Content/08%20DBE%20Subcontractors%20(Federal).docx)

Subcontractor Quote Comparison Sheet - Spreadsheet for showing all subcontractor quotes in the work areas where DBEs quoted on the project. This sheet is submitted with good faith effort packages.

<http://connect.ncdot.gov/business/SmallBusiness/Documents/DBE%20Subcontractor%20Quote%20Comparison%20Example.xls>

DBE Goal

The following DBE goal for participation by Disadvantaged Business Enterprises is established for this contract:

Disadvantaged Business Enterprises **8.0** %

- (A) *If the DBE goal is more than zero*, the Contractor shall exercise all necessary and reasonable steps to ensure that DBEs participate in at least the percent of the contract as set forth above as the DBE goal.
- (B) *If the DBE goal is zero*, the Contractor shall make an effort to recruit and use DBEs during the performance of the contract. Any DBE participation obtained shall be reported to the Department.

Directory of Transportation Firms (Directory)

Real-time information is available about firms doing business with the Department and firms that are certified through NCUCP in the Directory of Transportation Firms. Only firms identified in the Directory as DBE certified shall be used to meet the DBE goal. The Directory can be found at the following link. [https:// www.ebs.nc.gov/VendorDirectory/default.html](https://www.ebs.nc.gov/VendorDirectory/default.html)

The listing of an individual firm in the directory shall not be construed as an endorsement of the firm's capability to perform certain work.

Listing of DBE Subcontractors

At the time of bid, bidders shall submit all DBE participation that they anticipate to use during the life of the contract. Only those identified to meet the DBE goal will be considered committed, even though the listing shall include both committed DBE subcontractors and additional DBE subcontractors. Additional DBE subcontractor participation submitted at the time of bid will be used toward the Department's overall race-neutral goal. Only those firms with current DBE certification at the time of bid opening will be acceptable for listing in the bidder's submittal of DBE participation. The Contractor shall indicate the following required information:

(A) Electronic Bids

Bidders shall submit a listing of DBE participation in the appropriate section of Expedite, the bidding software of Bid Express®.

- (1) Submit the names and addresses of DBE firms identified to participate in the contract. If the bidder uses the updated listing of DBE firms shown in Expedite, the bidder may use the dropdown menu to access the name and address of the DBE firm.
- (2) Submit the contract line numbers of work to be performed by each DBE firm. When no figures or firms are entered, the bidder will be considered to have no DBE participation.
- (3) The bidder shall be responsible for ensuring that the DBE is certified at the time of bid by checking the Directory of Transportation Firms. If the firm is not certified at the time of the bid-letting, that DBE's participation will not count towards achieving the DBE goal.

(B) Paper Bids

- (1) *If the DBE goal is more than zero,*
 - (a) Bidders, at the time the bid proposal is submitted, shall submit a listing of DBE participation, including the names and addresses on *Listing of DBE Subcontractors* contained elsewhere in the contract documents in order for the bid to be considered responsive. Bidders shall indicate the total dollar value of the DBE participation for the contract.
 - (b) If bidders have no DBE participation, they shall indicate this on the *Listing of DBE Subcontractors* by entering the word "None" or the number "0." This form shall be completed in its entirety. **Blank forms will not be deemed to represent zero participation.** Bids submitted that do not have DBE participation indicated on the appropriate form will not be read publicly during the opening of bids. The Department will not consider these bids for award and the proposal will be rejected.
 - (c) The bidder shall be responsible for ensuring that the DBE is certified at the time of bid by checking the Directory of Transportation Firms. If the firm is not certified at the time of the bid-letting, that DBE's participation will not count towards achieving the corresponding goal.
- (2) *If the DBE goal is zero,* entries on the *Listing of DBE Subcontractors* are not required for the zero goal, however any DBE participation that is achieved during the project shall be reported in accordance with requirements contained elsewhere in the special provision.

DBE Prime Contractor

When a certified DBE firm bids on a contract that contains a DBE goal, the DBE firm is responsible for meeting the goal or making good faith efforts to meet the goal, just like any other bidder. In most cases, a DBE bidder on a contract will meet the DBE goal by virtue of the work it performs on the contract with its own forces. However, all the work that is performed by the DBE bidder and any other DBE subcontractors will count toward the DBE goal. The DBE bidder shall list itself along with any DBE subcontractors, if any, in order to receive credit toward the DBE goal.

For example, if the DBE goal is 45% and the DBE bidder will only perform 40% of the contract work, the prime will list itself at 40%, and the additional 5% shall be obtained through additional DBE participation with DBE subcontractors or documented through a good faith effort.

DBE prime contractors shall also follow Sections A and B listed under *Listing of DBE Subcontractor* just as a non-DBE bidder would.

Written Documentation – Letter of Intent

The bidder shall submit written documentation for each DBE that will be used to meet the DBE goal of the contract, indicating the bidder's commitment to use the DBE in the contract. This documentation shall be submitted on the Department's form titled *Letter of Intent*.

The documentation shall be received in the office of the State Contractor Utilization Engineer or at DBE@ncdot.gov no later than 10:00 a.m. of the sixth calendar day following opening of bids, unless the sixth day falls on an official state holiday. In that situation, it is due in the office of the State Contractor Utilization Engineer no later than 10:00 a.m. on the next official state business day.

If the bidder fails to submit the Letter of Intent from each committed DBE to be used toward the DBE goal, or if the form is incomplete (i.e. both signatures are not present), the DBE participation will not count toward meeting the DBE goal. If the lack of this participation drops the commitment below the DBE goal, the Contractor shall submit evidence of good faith efforts, completed in its entirety, to the State Contractor Utilization Engineer or DBE@ncdot.gov no later than 10:00 a.m. on the eighth calendar day following opening of bids, unless the eighth day falls on an official state holiday. In that situation, it is due in the office of the State Contractor Utilization Engineer no later than 10:00 a.m. on the next official state business day.

Submission of Good Faith Effort

If the bidder fails to meet or exceed the DBE goal, the apparent lowest responsive bidder shall submit to the Department documentation of adequate good faith efforts made to reach the DBE goal.

A hard copy and an electronic copy of this information shall be received in the office of the State Contractor Utilization Engineer or at DBE@ncdot.gov no later than 10:00 a.m. on the sixth calendar day following opening of bids unless the sixth day falls on an official state holiday. In that situation, it is due in the office of the State Contractor Utilization Engineer no later than 10:00 a.m.

on the next official state business day. If the contractor cannot send the information electronically, then one complete set and 5 copies of this information shall be received under the same time constraints above.

Note: Where the information submitted includes repetitious solicitation letters, it will be acceptable to submit a representative letter along with a distribution list of the firms that were solicited. Documentation of DBE quotations shall be a part of the good faith effort submittal. This documentation may include written subcontractor quotations, telephone log notations of verbal quotations, or other types of quotation documentation.

Consideration of Good Faith Effort for Projects with DBE Goals More Than Zero

Adequate good faith efforts mean that the bidder took all necessary and reasonable steps to achieve the goal which, by their scope, intensity, and appropriateness, could reasonably be expected to obtain sufficient DBE participation. Adequate good faith efforts also mean that the bidder actively and aggressively sought DBE participation. Mere *pro forma* efforts are not considered good faith efforts.

The Department will consider the quality, quantity, and intensity of the different kinds of efforts a bidder has made. Listed below are examples of the types of actions a bidder will take in making a good faith effort to meet the goal and are not intended to be exclusive or exhaustive, nor is it intended to be a mandatory checklist.

- (A) Soliciting through all reasonable and available means (e.g. attendance at pre-bid meetings, advertising, written notices, use of verifiable electronic means through the use of the NCDOT Directory of Transportation Firms) the interest of all certified DBEs who have the capability to perform the work of the contract. The bidder must solicit this interest within at least 10 days prior to bid opening to allow the DBEs to respond to the solicitation. Solicitation shall provide the opportunity to DBEs within the Division and surrounding Divisions where the project is located. The bidder must determine with certainty if the DBEs are interested by taking appropriate steps to follow up initial solicitations.
- (B) Selecting portions of the work to be performed by DBEs in order to increase the likelihood that the DBE goals will be achieved.
 - (1) Where appropriate, break out contract work items into economically feasible units to facilitate DBE participation, even when the prime contractor might otherwise prefer to perform these work items with its own forces.
 - (2) Negotiate with subcontractors to assume part of the responsibility to meet the contract DBE goal when the work to be sublet includes potential for DBE participation (2nd and 3rd tier subcontractors).
- (C) Providing interested DBEs with adequate information about the plans, specifications, and requirements of the contract in a timely manner to assist them in responding to a solicitation.
- (D) (1) Negotiating in good faith with interested DBEs. It is the bidder's responsibility to

make a portion of the work available to DBE subcontractors and suppliers and to select those portions of the work or material needs consistent with the available DBE subcontractors and suppliers, so as to facilitate DBE participation. Evidence of such negotiation includes the names, addresses, and telephone numbers of DBEs that were considered; a description of the information provided regarding the plans and specifications for the work selected for subcontracting; and evidence as to why additional agreements could not be reached for DBEs to perform the work.

- (2) A bidder using good business judgment would consider a number of factors in negotiating with subcontractors, including DBE subcontractors, and would take a firm's price and capabilities as well as contract goals into consideration. However, the fact that there may be some additional costs involved in finding and using DBEs is not in itself sufficient reason for a bidder's failure to meet the contract DBE goal, as long as such costs are reasonable. Also, the ability or desire of a prime contractor to perform the work of a contract with its own organization does not relieve the bidder of the responsibility to make good faith efforts. Bidding contractors are not, however, required to accept higher quotes from DBEs if the price difference is excessive or unreasonable.
- (E) Not rejecting DBEs as being unqualified without sound reasons based on a thorough investigation of their capabilities. The bidder's standing within its industry, membership in specific groups, organizations, or associates and political or social affiliations (for example, union vs. non-union employee status) are not legitimate causes for the rejection or non-solicitation of bids in the bidder's efforts to meet the project goal.
- (F) Making efforts to assist interested DBEs in obtaining bonding, lines of credit, or insurance as required by the recipient or bidder.
- (G) Making efforts to assist interested DBEs in obtaining necessary equipment, supplies, materials, or related assistance or services.
- (H) Effectively using the services of available minority/women community organizations; minority/women contractors' groups; Federal, State, and local minority/women business assistance offices; and other organizations as allowed on a case-by-case basis to provide assistance in the recruitment and placement of DBEs. Contact within 7 days from the bid opening the Business Opportunity and Work Force Development Unit at BOWD@ncdot.gov to give notification of the bidder's inability to get DBE quotes.
- (I) Any other evidence that the bidder submits which shows that the bidder has made reasonable good faith efforts to meet the DBE goal.

In addition, the Department may take into account the following:

- (1) Whether the bidder's documentation reflects a clear and realistic plan for achieving the DBE goal.
- (2) The bidders' past performance in meeting the DBE goals.

- (3) The performance of other bidders in meeting the DBE goal. For example, when the apparent successful bidder fails to meet the DBE goal, but others meet it, you may reasonably raise the question of whether, with additional reasonable efforts the apparent successful bidder could have met the goal. If the apparent successful bidder fails to meet the DBE goal, but meets or exceeds the average DBE participation obtained by other bidders, the Department may view this, in conjunction with other factors, as evidence of the apparent successful bidder having made a good faith effort.

If the Department does not award the contract to the apparent lowest responsive bidder, the Department reserves the right to award the contract to the next lowest responsive bidder that can satisfy to the Department that the DBE goal can be met or that an adequate good faith effort has been made to meet the DBE goal.

Non-Good Faith Appeal

The State Contractual Services Engineer will notify the contractor verbally and in writing of non-good faith. A contractor may appeal a determination of non-good faith made by the Goal Compliance Committee. If a contractor wishes to appeal the determination made by the Committee, they shall provide written notification to the State Contractual Services Engineer or at DBE@ncdot.gov. The appeal shall be made within 2 business days of notification of the determination of non-good faith.

Counting DBE Participation Toward Meeting DBE Goal

(A) Participation

The total dollar value of the participation by a committed DBE will be counted toward the contract goal requirement. The total dollar value of participation by a committed DBE will be based upon the value of work actually performed by the DBE and the actual payments to DBE firms by the Contractor.

(B) Joint Checks

Prior notification of joint check use shall be required when counting DBE participation for services or purchases that involves the use of a joint check. Notification shall be through submission of Form JC-1 (*Joint Check Notification Form*) and the use of joint checks shall be in accordance with the Department's Joint Check Procedures.

(C) Subcontracts (Non-Trucking)

A DBE may enter into subcontracts. Work that a DBE subcontracts to another DBE firm may be counted toward the contract goal requirement. Work that a DBE subcontracts to a non-DBE firm does not count toward the contract goal requirement. If a DBE contractor or subcontractor subcontracts a significantly greater portion of the work of the contract than would be expected on the basis of standard industry practices, it shall be presumed that the DBE is not performing a commercially useful function. The DBE may present evidence to rebut this presumption to the Department. The Department's decision on the

rebuttal of this presumption is subject to review by the Federal Highway Administration but is not administratively appealable to USDOT.

(D) Joint Venture

When a DBE performs as a participant in a joint venture, the Contractor may count toward its contract goal requirement a portion of the total value of participation with the DBE in the joint venture, that portion of the total dollar value being a distinct clearly defined portion of work that the DBE performs with its forces.

(E) Suppliers

A contractor may count toward its DBE requirement 60 percent of its expenditures for materials and supplies required to complete the contract and obtained from a DBE regular dealer and 100 percent of such expenditures from a DBE manufacturer.

(F) Manufacturers and Regular Dealers

A contractor may count toward its DBE requirement the following expenditures to DBE firms that are not manufacturers or regular dealers:

- (1) The fees or commissions charged by a DBE firm for providing a *bona fide* service, such as professional, technical, consultant, or managerial services, or for providing bonds or insurance specifically required for the performance of a DOT-assisted contract, provided the fees or commissions are determined to be reasonable and not excessive as compared with fees and commissions customarily allowed for similar services.
- (2) With respect to materials or supplies purchased from a DBE, which is neither a manufacturer nor a regular dealer, count the entire amount of fees or commissions charged for assistance in the procurement of the materials and supplies, or fees or transportation charges for the delivery of materials or supplies required on a job site (but not the cost of the materials and supplies themselves), provided the fees are determined to be reasonable and not excessive as compared with fees customarily allowed for similar services.

Commercially Useful Function

(A) DBE Utilization

The Contractor may count toward its contract goal requirement only expenditures to DBEs that perform a commercially useful function in the work of a contract. A DBE performs a commercially useful function when it is responsible for execution of the work of the contract and is carrying out its responsibilities by actually performing, managing, and supervising the work involved. To perform a commercially useful function, the DBE shall also be responsible with respect to materials and supplies used on the contract, for negotiating price, determining quality and quantity, ordering the material and installing (where applicable) and paying for the material itself. To determine whether a DBE is

performing a commercially useful function, the Department will evaluate the amount of work subcontracted, industry practices, whether the amount the firm is to be paid under the contract is commensurate with the work it is actually performing and the DBE credit claimed for its performance of the work, and any other relevant factors.

(B) DBE Utilization in Trucking

The following factors will be used to determine if a DBE trucking firm is performing a commercially useful function:

- (1) The DBE shall be responsible for the management and supervision of the entire trucking operation for which it is responsible on a particular contract, and there shall not be a contrived arrangement for the purpose of meeting DBE goals.
- (2) The DBE shall itself own and operate at least one fully licensed, insured, and operational truck used on the contract.
- (3) The DBE receives credit for the total value of the transportation services it provides on the contract using trucks it owns, insures, and operates using drivers it employs.
- (4) The DBE may subcontract the work to another DBE firm, including an owner-operator who is certified as a DBE. The DBE who subcontracts work to another DBE receives credit for the total value of the transportation services the subcontracted DBE provides on the contract.
- (5) The DBE may also subcontract the work to a non-DBE firm, including from an owner-operator. The DBE who subcontracts the work to a non-DBE is entitled to credit for the total value of transportation services provided by the non-DBE subcontractor not to exceed the value of transportation services provided by DBE-owned trucks on the contract. Additional participation by non-DBE subcontractors receives credit only for the fee or commission it receives as a result of the subcontract arrangement. The value of services performed under subcontract agreements between the DBE and the Contractor will not count towards the DBE contract requirement.
- (6) A DBE may lease truck(s) from an established equipment leasing business open to the general public. The lease must indicate that the DBE has exclusive use of and control over the truck. This requirement does not preclude the leased truck from working for others during the term of the lease with the consent of the DBE, so long as the lease gives the DBE absolute priority for use of the leased truck. This type of lease may count toward the DBE's credit as long as the driver is under the DBE's payroll.
- (7) Subcontracted/leased trucks shall display clearly on the dashboard the name of the DBE that they are subcontracted/leased to and their own company name if it is not identified on the truck itself. Magnetic door signs are not permitted.

DBE Replacement

When a Contractor has relied on a commitment to a DBE firm (or an approved substitute DBE firm) to meet all or part of a contract goal requirement, the contractor shall not terminate the DBE for convenience. This includes, but is not limited to, instances in which the Contractor seeks to perform the work of the terminated subcontractor with another DBE subcontractor, a non-DBE subcontractor, or with the Contractor's own forces or those of an affiliate. A DBE may only be terminated after receiving the Engineer's written approval based upon a finding of good cause for the termination. The prime contractor must give the DBE firm 5 days to respond to the prime contractor's notice of termination and advise the prime contractor and the Department of the reasons, if any, why the firm objects to the proposed termination of its subcontract and why the Department should not approve the action.

All requests for replacement of a committed DBE firm shall be submitted to the Engineer for approval on Form RF-1 (*DBE Replacement Request*). If the Contractor fails to follow this procedure, the Contractor may be disqualified from further bidding for a period of up to 6 months.

The Contractor shall comply with the following for replacement of a committed DBE:

(A) Performance Related Replacement

When a committed DBE is terminated for good cause as stated above, an additional DBE that was submitted at the time of bid may be used to fulfill the DBE commitment. A good faith effort will only be required for removing a committed DBE if there were no additional DBEs submitted at the time of bid to cover the same amount of work as the DBE that was terminated.

If a replacement DBE is not found that can perform at least the same amount of work as the terminated DBE, the Contractor shall submit a good faith effort documenting the steps taken. Such documentation shall include, but not be limited to, the following:

- (1) Copies of written notification to DBEs that their interest is solicited in contracting the work defaulted by the previous DBE or in subcontracting other items of work in the contract.
- (2) Efforts to negotiate with DBEs for specific subbids including, at a minimum:
 - (a) The names, addresses, and telephone numbers of DBEs who were contacted.
 - (b) A description of the information provided to DBEs regarding the plans and specifications for portions of the work to be performed.
- (3) A list of reasons why DBE quotes were not accepted.
- (4) Efforts made to assist the DBEs contacted, if needed, in obtaining bonding or insurance required by the Contractor.

(B) Decertification Replacement

- (1) When a committed DBE is decertified by the Department after the SAF (*Subcontract Approval Form*) has been received by the Department, the Department will not require the Contractor to solicit replacement DBE participation equal to the remaining work to be performed by the decertified firm. The participation equal to the remaining work performed by the decertified firm will count toward the contract goal requirement.
- (2) When a committed DBE is decertified prior to the Department receiving the SAF (*Subcontract Approval Form*) for the named DBE firm, the Contractor shall take all necessary and reasonable steps to replace the DBE subcontractor with another DBE subcontractor to perform at least the same amount of work to meet the DBE goal requirement. If a DBE firm is not found to do the same amount of work, a good faith effort must be submitted to NCDOT (see A herein for required documentation).

Changes in the Work

When the Engineer makes changes that result in the reduction or elimination of work to be performed by a committed DBE, the Contractor will not be required to seek additional participation. When the Engineer makes changes that result in additional work to be performed by a DBE based upon the Contractor's commitment, the DBE shall participate in additional work to the same extent as the DBE participated in the original contract work.

When the Engineer makes changes that result in extra work, which has more than a minimal impact on the contract amount, the Contractor shall seek additional participation by DBEs unless otherwise approved by the Engineer.

When the Engineer makes changes that result in an alteration of plans or details of construction, and a portion or all of the work had been expected to be performed by a committed DBE, the Contractor shall seek participation by DBEs unless otherwise approved by the Engineer.

When the Contractor requests changes in the work that result in the reduction or elimination of work that the Contractor committed to be performed by a DBE, the Contractor shall seek additional participation by DBEs equal to the reduced DBE participation caused by the changes.

Reports and Documentation

A SAF (*Subcontract Approval Form*) shall be submitted for all work which is to be performed by a DBE subcontractor. The Department reserves the right to require copies of actual subcontract agreements involving DBE subcontractors.

When using transportation services to meet the contract commitment, the Contractor shall submit a proposed trucking plan in addition to the SAF. The plan shall be submitted prior to beginning construction on the project. The plan shall include the names of all trucking firms proposed for use, their certification type(s), the number of trucks owned by the firm, as well as the individual truck identification numbers, and the line item(s) being performed.

Within 30 calendar days of entering into an agreement with a DBE for materials, supplies or services, not otherwise documented by the SAF as specified above, the Contractor shall furnish the Engineer a copy of the agreement. The documentation shall also indicate the percentage (60% or 100%) of expenditures claimed for DBE credit.

Reporting Disadvantaged Business Enterprise Participation

The Contractor shall provide the Engineer with an accounting of payments made to all DBE firms, including material suppliers and contractors at all levels (prime, subcontractor, or second tier subcontractor). This accounting shall be furnished to the Engineer for any given month by the end of the following month. Failure to submit this information accordingly may result in the following action:

- (A) Withholding of money due in the next partial pay estimate; or
- (B) Removal of an approved contractor from the prequalified bidders' list or the removal of other entities from the approved subcontractors list.

While each contractor (prime, subcontractor, 2nd tier subcontractor) is responsible for accurate accounting of payments to DBEs, it shall be the prime contractor's responsibility to report all monthly and final payment information in the correct reporting manner.

Failure on the part of the Contractor to submit the required information in the time frame specified may result in the disqualification of that contractor and any affiliate companies from further bidding until the required information is submitted.

Failure on the part of any subcontractor to submit the required information in the time frame specified may result in the disqualification of that contractor and any affiliate companies from being approved for work on future DOT projects until the required information is submitted.

Contractors reporting transportation services provided by non-DBE lessees shall evaluate the value of services provided during the month of the reporting period only.

At any time, the Engineer can request written verification of subcontractor payments.

The Contractor shall report the accounting of payments through the Department's DBE Payment Tracking System.

Failure to Meet Contract Requirements

Failure to meet contract requirements in accordance with Subarticle 102-15(J) of the *2018 Standard Specifications* may be cause to disqualify the Contractor.

CERTIFICATION FOR FEDERAL-AID CONTRACTS:

(3-21-90)

SP1 G85

The prospective participant certifies, by signing and submitting this bid or proposal, to the best of his or her knowledge and belief, that:

- (A) No Federal appropriated funds have been paid or will be paid, by or on behalf of the undersigned, to any person for influencing or attempting to influence an officer or employee of any Federal agency, a Member of Congress, an officer or employee of Congress, or an employee of a Member of Congress in connection with the awarding of any Federal contract, the making of any Federal grant, the making of any Federal loan, the entering into of any cooperative agreement, and the extension, continuation, renewal, amendment, or modification of any Federal contract, grant, loan, or cooperative agreement.
- (B) If any funds other than Federal appropriated funds have been paid or will be paid to any person for influencing or attempting to influence an officer or employee of any Federal agency, a Member of Congress, an officer or employee of Congress, or an employee of a Member of Congress in connection with this Federal contract, grant, loan, or cooperative agreement, the undersigned shall complete and submit Standard Form-LLL, *Disclosure Form to Report Lobbying*, in accordance with its instructions.

This certification is a material representation of fact upon which reliance was placed when this transaction was made or entered into. Submission of this certification is a prerequisite for making or entering into this transaction imposed by *Section 1352, Title 31, U.S. Code*. Any person who fails to file the required certification shall be subject to a civil penalty of not less than \$10,000 and not more than \$100,000 for each such failure.

The prospective participant also agrees by submitting his or her bid or proposal that he or she shall require that the language of this certification be included in all lower tier subcontracts, which exceed \$100,000 and that all such subrecipients shall certify and disclose accordingly.

CONTRACTOR'S LICENSE REQUIREMENTS:

(7-1-95)

102-14

SP1 G88

If the successful bidder does not hold the proper license to perform any plumbing, heating, air conditioning, or electrical work in this contract, he will be required to sublet such work to a contractor properly licensed in accordance with *Article 2 of Chapter 87 of the General Statutes* (licensing of heating, plumbing, and air conditioning contractors) and *Article 4 of Chapter 87 of the General Statutes* (licensing of electrical contractors).

U.S. DEPARTMENT OF TRANSPORTATION HOTLINE:

(11-22-94)

108-5

SP1 G100

To report bid rigging activities call: **1-800-424-9071**

The U.S. Department of Transportation (DOT) operates the above toll-free hotline Monday through Friday, 8:00 a.m. to 5:00 p.m. eastern time. Anyone with knowledge of possible bid rigging, bidder collusion, or other fraudulent activities should use the hotline to report such activities.

The hotline is part of the DOT's continuing effort to identify and investigate highway construction contract fraud and abuse is operated under the direction of the DOT Inspector General. All information will be treated confidentially and caller anonymity will be respected.

CARGO PREFERENCE ACT:

(2-16-16)

Privately owned United States-flag commercial vessels transporting cargoes are subject to the Cargo Preference Act (CPA) of 1954 requirements and regulations found in 46 CFR 381.7. Contractors are directed to clause (b) of 46 CFR 381.7 as follows:

(b) Contractor and Subcontractor Clauses. "Use of United States-flag vessels: The contractor agrees-

" (1) To utilize privately owned United States-flag commercial vessels to ship at least 50 percent of the gross tonnage (computed separately for dry bulk carriers, dry cargo liners, and tankers) involved, whenever shipping any equipment, material, or commodities pursuant to this contract, to the extent such vessels are available at fair and reasonable rates for United States-flag commercial vessels.

(2) To furnish within 20 days following the date of loading for shipments originating within the United States or within 30 working days following the date of loading for shipments originating outside the United States a legible copy of a rated, 'on-board' commercial ocean bill-of-lading in English for each shipment of cargo described in paragraph (b) (1) of this section to both the Contracting Officer (through the prime contractor in the case of subcontractor bills-of-lading) and to the Division of National Cargo, Office of Market Development, Maritime Administration, Washington, DC 20590.

(3) To insert the substance of the provisions of this clause in all subcontracts issued pursuant to this contract."

MAINTENANCE OF THE PROJECT:

(11-20-07) (Rev. 1-17-12)

104-10

SP1 G125

Revise the *2018 Standard Specifications* as follows:

Page 1-39, Article 104-10 Maintenance of the Project, line 25, add the following after the first sentence of the first paragraph:

All guardrail/guiderail within the project limits shall be included in this maintenance.

Page 1-39, Article 104-10 Maintenance of the Project, line 30, add the following as the last sentence of the first paragraph:

The Contractor shall perform weekly inspections of guardrail and guiderail and shall report damages to the Engineer on the same day of the weekly inspection. *Where damaged guardrail or guiderail is repaired or replaced as a result of maintaining the project in accordance with this article, such repair or replacement shall be performed within 7 consecutive calendar days of such inspection report.*

Page 1-39, Article 104-10 Maintenance of the Project, lines 42-44, replace the last sentence of the last paragraph with the following:

The Contractor will not be directly compensated for any maintenance operations necessary, except for maintenance of guardrail/guiderail, as this work will be considered incidental to the work covered by the various contract items. The provisions of Article 104-7, Extra Work, and Article 104-8, Compensation and Record Keeping will apply to authorized maintenance of guardrail/guiderail. Performance of weekly inspections of guardrail/guiderail, and the damage reports required as described above, will be considered to be an incidental part of the work being paid for by the various contract items.

COOPERATION BETWEEN CONTRACTORS:

(7-1-95)

105-7

SP1 G133

The Contractor's attention is directed to Article 105-7 of the *2018 Standard Specifications*.

I-5734 / I-5762 (C203901) is currently under construction and located in the vicinity of this project. I-5734 / I-5762 will not be completed prior to the letting of this project.

I-5852A (Guilford County) is located in this vicinity of this project and is anticipated for an October 16, 2018 Letting.

I-5852B (C204045) is currently under construction and located in the vicinity of this project. I-5852B will not be completed prior to the letting of this project.

The Contractor on this project shall cooperate with the Contractor working within or adjacent to the limits of this project to the extent that the work can be carried out to the best advantage of all concerned.

EROSION AND SEDIMENT CONTROL/STORMWATER CERTIFICATION:

(1-16-07) (Rev 11-22-16)

105-16, 225-2, 16

SP1 G180

General

Schedule and conduct construction activities in a manner that will minimize soil erosion and the resulting sedimentation and turbidity of surface waters. Comply with the requirements herein regardless of whether or not a National Pollution discharge Elimination System (NPDES) permit for the work is required.

Establish a chain of responsibility for operations and subcontractors' operations to ensure that the *Erosion and Sediment Control/Stormwater Pollution Prevention Plan* is implemented and maintained over the life of the contract.

- (A) *Certified Supervisor* - Provide a certified Erosion and Sediment Control/Stormwater Supervisor to manage the Contractor and subcontractor operations, insure compliance with Federal, State and Local ordinances and regulations, and manage the Quality Control Program.

- (B) *Certified Foreman* - Provide a certified, trained foreman for each construction operation that increases the potential for soil erosion or the possible sedimentation and turbidity of surface waters.
- (C) *Certified Installer* - Provide a certified installer to install or direct the installation for erosion or sediment/stormwater control practices.
- (D) *Certified Designer* - Provide a certified designer for the design of the erosion and sediment control/stormwater component of reclamation plans and, if applicable, for the design of the project erosion and sediment control/stormwater plan.

Roles and Responsibilities

- (A) *Certified Erosion and Sediment Control/Stormwater Supervisor* - The Certified Supervisor shall be Level II and responsible for ensuring the erosion and sediment control/stormwater plan is adequately implemented and maintained on the project and for conducting the quality control program. The Certified Supervisor shall be on the project within 24 hours notice from initial exposure of an erodible surface to the project's final acceptance. Perform the following duties:
 - (1) **Manage Operations** - Coordinate and schedule the work of subcontractors so that erosion and sediment control/stormwater measures are fully executed for each operation and in a timely manner over the duration of the contract.
 - (a) Oversee the work of subcontractors so that appropriate erosion and sediment control/stormwater preventive measures are conformed to at each stage of the work.
 - (b) Prepare the required National Pollutant Discharge Elimination System (NPDES) Inspection Record and submit to the Engineer.
 - (c) Attend all weekly or monthly construction meetings to discuss the findings of the NPDES inspection and other related issues.
 - (d) Implement the erosion and sediment control/stormwater site plans requested.
 - (e) Provide any needed erosion and sediment control/stormwater practices for the Contractor's temporary work not shown on the plans, such as, but not limited to work platforms, temporary construction, pumping operations, plant and storage yards, and cofferdams.
 - (f) Acquire applicable permits and comply with requirements for borrow pits, dewatering, and any temporary work conducted by the Contractor in jurisdictional areas.
 - (g) Conduct all erosion and sediment control/stormwater work in a timely and workmanlike manner.
 - (h) Fully perform and install erosion and sediment control/stormwater work prior to any suspension of the work.
 - (i) Coordinate with Department, Federal, State and Local Regulatory agencies on resolution of erosion and sediment control/stormwater issues due to the Contractor's operations.

- (j) Ensure that proper cleanup occurs from vehicle tracking on paved surfaces or any location where sediment leaves the Right-of-Way.
 - (k) Have available a set of erosion and sediment control/stormwater plans that are initialed and include the installation date of Best Management Practices. These practices shall include temporary and permanent groundcover and be properly updated to reflect necessary plan and field changes for use and review by Department personnel as well as regulatory agencies.
- (2) Requirements set forth under the NPDES Permit - The Department's NPDES Stormwater permit (NCS000250) outlines certain objectives and management measures pertaining to construction activities. The permit references *NCG010000, General Permit to Discharge Stormwater* under the NPDES, and states that the Department shall incorporate the applicable requirements into its delegated Erosion and Sediment Control Program for construction activities disturbing one or more acres of land. The Department further incorporates these requirements on all contracted bridge and culvert work at jurisdictional waters, regardless of size. Some of the requirements are, but are not limited to:
- (a) Control project site waste to prevent contamination of surface or ground waters of the state, i.e. from equipment operation/maintenance, construction materials, concrete washout, chemicals, litter, fuels, lubricants, coolants, hydraulic fluids, any other petroleum products, and sanitary waste.
 - (b) Inspect erosion and sediment control/stormwater devices and stormwater discharge outfalls at least once every 7 calendar days and within 24 hours after a rainfall event of 0.5 inch that occurs within a 24 hour period. Additional monitoring may be required at the discretion of Division of Water Resources personnel if the receiving stream is 303(d) listed for turbidity and the project has had documented problems managing turbidity.
 - (c) Maintain an onsite rain gauge or use the Department's Multi-Sensor Precipitation Estimate website to maintain a daily record of rainfall amounts and dates.
 - (d) Maintain erosion and sediment control/stormwater inspection records for review by Department and Regulatory personnel upon request.
 - (e) Implement approved reclamation plans on all borrow pits, waste sites and staging areas.
 - (f) Maintain a log of turbidity test results as outlined in the Department's Procedure for Monitoring Borrow Pit Discharge.
 - (g) Provide secondary containment for bulk storage of liquid materials.
 - (h) Provide training for employees concerning general erosion and sediment control/stormwater awareness, the Department's NPDES Stormwater Permit NCS000250 requirements, and the applicable requirements of the *General Permit, NCG010000*.
 - (i) Report violations of the NPDES permit to the Engineer immediately who will notify the Division of Water Quality Regional Office within 24 hours of becoming aware of the violation.

- (3) Quality Control Program - Maintain a quality control program to control erosion, prevent sedimentation and follow provisions/conditions of permits. The quality control program shall:
- (a) Follow permit requirements related to the Contractor and subcontractors' construction activities.
 - (b) Ensure that all operators and subcontractors on site have the proper erosion and sediment control/stormwater certification.
 - (c) Notify the Engineer when the required certified erosion and sediment control/stormwater personnel are not available on the job site when needed.
 - (d) Conduct the inspections required by the NPDES permit.
 - (e) Take corrective actions in the proper timeframe as required by the NPDES permit for problem areas identified during the NPDES inspections.
 - (f) Incorporate erosion control into the work in a timely manner and stabilize disturbed areas with mulch/seed or vegetative cover on a section-by-section basis.
 - (g) Use flocculants approved by state regulatory authorities where appropriate and where required for turbidity and sedimentation reduction.
 - (h) Ensure proper installation and maintenance of temporary erosion and sediment control devices.
 - (i) Remove temporary erosion or sediment control devices when they are no longer necessary as agreed upon by the Engineer.
 - (j) The Contractor's quality control and inspection procedures shall be subject to review by the Engineer. Maintain NPDES inspection records and make records available at all times for verification by the Engineer.
- (B) *Certified Foreman* - At least one Certified Foreman shall be onsite for each type of work listed herein during the respective construction activities to control erosion, prevent sedimentation and follow permit provisions:
- (1) Foreman in charge of grading activities
 - (2) Foreman in charge of bridge or culvert construction over jurisdictional areas
 - (3) Foreman in charge of utility activities
- The Contractor may request to use the same person as the Level II Supervisor and Level II Foreman. This person shall be onsite whenever construction activities as described above are taking place. This request shall be approved by the Engineer prior to work beginning.
- The Contractor may request to name a single Level II Foreman to oversee multiple construction activities on small bridge or culvert replacement projects. This request shall be approved by the Engineer prior to work beginning.
- (C) *Certified Installers* - Provide at least one onsite, Level I Certified Installer for each of the following erosion and sediment control/stormwater crew:
- (1) Seeding and Mulching
 - (2) Temporary Seeding
 - (3) Temporary Mulching

- (4) Sodding
- (5) Silt fence or other perimeter erosion/sediment control device installations
- (6) Erosion control blanket installation
- (7) Hydraulic tackifier installation
- (8) Turbidity curtain installation
- (9) Rock ditch check/sediment dam installation
- (10) Ditch liner/matting installation
- (11) Inlet protection
- (12) Riprap placement
- (13) Stormwater BMP installations (such as but not limited to level spreaders, retention/detention devices)
- (14) Pipe installations within jurisdictional areas

If a Level I *Certified Installer* is not onsite, the Contractor may substitute a Level II Foreman for a Level I Installer, provided the Level II Foreman is not tasked to another crew requiring Level II Foreman oversight.

- (D) *Certified Designer* - Include the certification number of the Level III-B Certified Designer on the erosion and sediment control/stormwater component of all reclamation plans and if applicable, the certification number of the Level III-A Certified Designer on the design of the project erosion and sediment control/stormwater plan.

Preconstruction Meeting

Furnish the names of the *Certified Erosion and Sediment Control/Stormwater Supervisor*, *Certified Foremen*, *Certified Installers* and *Certified Designer* and notify the Engineer of changes in certified personnel over the life of the contract within 2 days of change.

Ethical Responsibility

Any company performing work for the North Carolina Department of Transportation has the ethical responsibility to fully disclose any reprimand or dismissal of an employee resulting from improper testing or falsification of records.

Revocation or Suspension of Certification

Upon recommendation of the Chief Engineer to the certification entity, certification for *Supervisor*, *Certified Foremen*, *Certified Installers* and *Certified Designer* may be revoked or suspended with the issuance of an *Immediate Corrective Action (ICA)*, *Notice of Violation (NOV)*, or *Cease and Desist Order* for erosion and sediment control/stormwater related issues.

The Chief Engineer may recommend suspension or permanent revocation of certification due to the following:

- (A) Failure to adequately perform the duties as defined within this certification provision.
- (B) Issuance of an ICA, NOV, or Cease and Desist Order.
- (C) Failure to fully perform environmental commitments as detailed within the permit conditions and specifications.

- (D) Demonstration of erroneous documentation or reporting techniques.
- (E) Cheating or copying another candidate's work on an examination.
- (F) Intentional falsification of records.
- (G) Directing a subordinate under direct or indirect supervision to perform any of the above actions.
- (H) Dismissal from a company for any of the above reasons.
- (I) Suspension or revocation of one's certification by another entity.

Suspension or revocation of a certification will be sent by certified mail to the certificant and the Corporate Head of the company that employs the certificant.

A certificant has the right to appeal any adverse action which results in suspension or permanent revocation of certification by responding, in writing, to the Chief Engineer within 10 calendar days after receiving notice of the proposed adverse action.

Chief Engineer
1536 Mail Service Center
Raleigh, NC 27699-1536

Failure to appeal within 10 calendar days will result in the proposed adverse action becoming effective on the date specified on the certified notice. Failure to appeal within the time specified will result in a waiver of all future appeal rights regarding the adverse action taken. The certificant will not be allowed to perform duties associated with the certification during the appeal process.

The Chief Engineer will hear the appeal and make a decision within 7 days of hearing the appeal. Decision of the Chief Engineer will be final and will be made in writing to the certificant.

If a certification is temporarily suspended, the certificant shall pass any applicable written examination and any proficiency examination, at the conclusion of the specified suspension period, prior to having the certification reinstated.

Measurement and Payment

Certified Erosion and Sediment Control/Stormwater Supervisor, Certified Foremen, Certified Installers and Certified Designer will be incidental to the project for which no direct compensation will be made.

PROJECT SPECIAL PROVISIONS**ROADWAY****FLOWABLE FILL:**

(9-17-02) (Rev 1-17-12)

300, 340, 1000, 1530, 1540, 1550

SP3 R30

Description

This work consists of all work necessary to place flowable fill in accordance with these provisions, the plans, and as directed.

Materials

Refer to Division 10 of the *2018 Standard Specifications*.

Item

Flowable Fill

Section

1000-6

Construction Methods

Discharge flowable fill material directly from the truck into the space to be filled, or by other approved methods. The mix may be placed full depth or in lifts as site conditions dictate. The Contractor shall provide a method to plug the ends of the existing pipe in order to contain the flowable fill.

Measurement and Payment

At locations where flowable fill is called for on the plans and a pay item for flowable fill is included in the contract, *Flowable Fill* will be measured in cubic yards and paid as the actual number of cubic yards that have been satisfactorily placed and accepted. Such price and payment will be full compensation for all work covered by this provision including, but not limited to, the mix design, furnishing, hauling, placing and containing the flowable fill.

Payment will be made under:

Pay Item

Flowable Fill

Pay Unit

Cubic Yard

INCIDENTAL STONE BASE:

(7-1-95) (Rev.8-21-12)

545

SP5 R28R

Description

Place incidental stone base on driveways, mailboxes, etc. immediately after paving and do not have the paving operations exceed stone base placement by more than one week without written permission of the Engineer.

Materials and Construction

Provide and place incidental stone base in accordance with Section 545 of the *2018 Standard Specifications*.

Measurement and Payment

Incidental Stone Base will be measured and paid in accordance with Article 545-6 of the *2018 Standard Specifications*.

SHOULDER WEDGE:

(9-20-11) (Rev. 8-21-12)

610

SP6 R03R

Revise the *2018 Standard Specifications* as follows:

Page 6-21, Article 610-8, SPREADING AND FINISHING, add the following after line 39:

Attach a device, mounted on screed of paving equipment, capable of constructing a shoulder wedge with an angle of 30 degrees plus or minus 4 degrees along the outside edge of the roadway, measured from the horizontal plane in place after final compaction on the final surface course. Use an approved mechanical device which will form the asphalt mixture to produce a wedge with uniform texture, shape and density while automatically adjusting to varying heights.

Payment for use of this device will be incidental to the other pay items in the contract.

PRICE ADJUSTMENT - ASPHALT BINDER FOR PLANT MIX:

(11-21-00)

620

SP6 R25

Price adjustments for asphalt binder for plant mix will be made in accordance with Section 620 of the *2018 Standard Specifications*.

The base price index for asphalt binder for plant mix is **\$ 455.56** per ton.

This base price index represents an average of F.O.B. selling prices of asphalt binder at supplier's terminals on **May 1, 2018**.

FINAL SURFACE TESTING NOT REQUIRED:

(5-18-04) (Rev. 2-16-16)

610

SP6 R45

Final surface testing is not required on this project in accordance with Section 610-13, *Final Surface Testing and Acceptance*.

RESURFACING EXISTING BRIDGES:

(7-1-95) (Rev. 8-21-12)

SP6 R61AR

The Contractor's attention is directed to the fact that he will be required to resurface the bridges on this project if directed by the Engineer.

Place the surface so as to follow a grade line set by the Engineer with the minimum thickness as shown on the sketch herein or as directed by the Engineer. State Forces will make all necessary repairs to the bridge floors prior to the time that the Contractor places the proposed surfacing. Give

the Engineer at least 15 days' notice prior to the expected time to begin operations so that State Forces will have sufficient time to complete their work.

At all bridges that are not to be resurfaced, taper out the proposed resurfacing layer adjacent to the bridges to insure a proper tie-in with the bridge surface.

OPEN GRADED ASPHALT FRICTION COURSE, PERMEABLE ASPHALT DRAINAGE COURSE, AND ULTRA-THIN BONDED WEARING COURSE:

(4-17-12)(Rev. 12-15-15)

609, 610

SP6 R62

When producing and constructing open graded asphalt friction course, permeable asphalt drainage course, and ultra-thin bonded wearing course revise the *2018 Standard Specifications* as follows:

Page 6-9, Subarticle 609-6(B) Required Sampling and Testing Frequencies, delete the third paragraph and replace with the following:

Sample and test the completed mixture from each mix design per plant per year at the following minimum frequency during mix production:

<u>Accumulative Production Increment</u>	<u>Number of Samples per Increment</u>
500 tons	1

Page 6-9, Subarticle 609-6(C) Control Charts, delete the second paragraph and replace with the following:

Record the following data on the standardized control charts and in accordance with the requirements of Section 7.4 of the *Asphalt QMS Manual*:

- (a) Aggregate Gradation Test Results:
 1. 12.5 mm (Types P57 & FC-2 Mod. Only)
 2. 9.5 mm (Excluding Type P57)
 3. 4.75 mm
 4. 2.36 mm
 5. 0.075 mm Sieves
- (b) Binder Content, %, P_b

Page 6-10, Subarticle 609-6(D) Control Limits, Table 609-1 CONTROL LIMITS, replace with the following:

Mix Control Criteria	Target Source	Moving Average Limit	Individual Limit
12.5 mm Sieve (Types P57 & FC-2 Mod)	JMF	± 4.0	± 8.0
9.5 mm Sieve (Excluding Type P57)	JMF	± 4.0	± 8.0
4.75 mm Sieve	JMF	± 4.0	± 8.0
2.36 mm Sieve	JMF	± 4.0	± 8.0
0.075 mm Sieve	JMF	± 1.5	± 2.5
Binder Content	JMF	± 0.3	± 0.7
TSR (Ultra-thin Only)	Min. Spec. Limit	-	- 15%

Page 6-12, Subarticle 609-6(F) Allowable Retesting for Mix Deficiencies, Table 609-2 RETEST LIMITS FOR MIX DEFICIENCIES, replace with the following:

TABLE 609-2 RETEST LIMITS FOR MIX DEFICIENCIES	
Property	Limit
% Binder Content	by more than ± 1.0%
12.5 mm Sieve (Types P 57 & FC-2 Mod)	by more than ± 9.0%
9.5 mm Sieve (Excluding Type P 57)	by more than ± 9.0%
4.75 mm sieve	by more than ± 9.0%
2.36 mm sieve	by more than ± 9.0%
0.075 mm sieve	by more than ± 3.0%
TSR (Ultra-thin only)	by more than -15% from Specification limit

Page 6-14, Article 609-9 QUALITY ASSURANCE, Table 609-3 LIMITS OF PRECISION FOR TEST RESULTS, replace with the following:

TABLE 609-3 LIMITS OF PRECISION FOR TEST RESULTS	
Mix Property	Limits of Precision
12.5 mm Sieve (Types P 57 & FC-2 Mod. Only)	± 6.0%
9.5 mm Sieve (Excluding Type P 57)	± 5.0%
4.75 mm Sieve	± 5.0%
2.36 mm Sieve	± 5.0%
0.075 mm Sieve	± 2.0%
Asphalt Binder Content	± 0.5%
TSR (Ultra-thin HMA Only)	± 15.0%

Page 6-16, Article 610-3, COMPOSITION OF MIXTURES (MIX DESIGN AND JOB MIX FORMULA), line 30, add the following at the end of the sixth paragraph:

For OGAFC, the maximum percent of binder contributed from RAS or a combination of RAS and RAP is 18%.

ASPHALT CONCRETE PLANT MIX PAVEMENTS:

(2-20-18)

610, 1012

SP6 R65

Revise the *2018 Standard Specifications* as follows:

Page 6-17, Table 610-1, MIXING TEMPERATURE AT THE ASPHALT PLANT, replace with the following:

Binder Grade	JMF Temperature
PG 58-28; PG 64-22	250 - 290°F
PG 76-22	300 - 325°F

Page 6-17, Subarticle 610-3(C), Job Mix Formula (JMF), lines 38-39, delete the fourth paragraph.

Page 6-18, Subarticle 610-3(C), Job Mix Formula (JMF), line 12, replace “SF9.5A” with “S9.5B”.

Page 6-18, Table 610-3, MIX DESIGN CRITERIA, replace with the following:

Mix Type	Design ESALs millions ^A	Binder PG Grade ^B	Compaction Levels		Max. Rut Depth (mm)	Volumetric Properties			
			Gmm @			VMA	VTM	VFA	%Gmm @ Nini
			Nini	Ndes		% Min.	%	Min.-Max.	
S4.75A	< 1	64 - 22	6	50	11.5	16.0	4.0 - 6.0	65 - 80	≤ 91.5
S9.5B	0 - 3	64 - 22	6	50	9.5	16.0	3.0 - 5.0	70 - 80	≤ 91.5
S9.5C	3 - 30	64 - 22	7	65	6.5	15.5	3.0 - 5.0	65 - 78	≤ 90.5
S9.5D	> 30	76 - 22	8	100	4.5	15.5	3.0 - 5.0	65 - 78	≤ 90.0
I19.0C	ALL	64 - 22	7	65	-	13.5	3.0 - 5.0	65 - 78	≤ 90.5
B25.0C	ALL	64 - 22	7	65	-	12.5	3.0 - 5.0	65 - 78	≤ 90.5
Design Parameter						Design Criteria			
All Mix Types	Dust to Binder Ratio (P _{0.075} / P _{be})					0.6 - 1.4 ^C			
	Tensile Strength Ratio (TSR) ^D					85% Min. ^E			

A. Based on 20 year design traffic.

B. Volumetric Properties based on specimens compacted to N_{des} as modified by the Department.

C. Dust to Binder Ratio (P_{0.075} / P_{be}) for Type S4.75A is 1.0 - 2.0.

D. NCDOT-T-283 (No Freeze-Thaw cycle required).

E. TSR for Type S4.75A & B25.0C mixes is 80% minimum.

Page 6-19, Table 610-5, BINDER GRADE REQUIREMENTS (BASED ON RBR%), replace with the following:

Mix Type	%RBR ≤ 20%	21% ≤ %RBR ≤ 30%	%RBR > 30%
S4.75A, S9.5B, S9.5C, I19.0C, B25.0C	PG 64-22	PG 64-22 ^A	PG 58-28
S9.5D, OGFC	PG 76-22 ^B	n/a	n/a

Page 6-20, Table 610-6, PLACEMENT TEMPERATURES FOR ASPHALT, replace with the following:

TABLE 610-6 PLACEMENT TEMPERATURES FOR ASPHALT	
Asphalt Concrete Mix Type	Minimum Surface and Air Temperature
B25.0C	35°F
I19.0C	35°F
S4.75A, S9.5B, S9.5C	40°F ^A
S9.5D	50°F

A. If the mix contains any amount of RAS, The virgin binder shall be PG 58-28.

Page 6-23, Table 610-7, DENSITY REQUIREMENTS, replace with the following:

TABLE 610-7 DENSITY REQUIREMENTS	
Mix Type	Minimum % G _{mm} (Maximum Specific Gravity)
S4.75A	85.0 ^A
S9.5B	90.0
S9.5C, S9.5D, I19.0C, B25.0C	92.0

A. Compaction to the above specified density will be required when the S4.75A mix is applied at a rate of 100 lbs/sy or higher.

Page 6-32, Article 610-16 MEASUREMENT AND PAYMENT, replace with the following:

Pay Item	Pay Unit
Asphalt Concrete Base Course, Type B25.0C	Ton
Asphalt Concrete Intermediate Course, Type I19.0C	Ton
Asphalt Concrete Surface Course, Type S4.75A	Ton
Asphalt Concrete Surface Course, Type S9.5B	Ton
Asphalt Concrete Surface Course, Type S9.5C	Ton
Asphalt Concrete Surface Course, Type S9.5D	Ton

Page 10-30, Table 1012-1, AGGREGATE CONSENSUS PROPERTIES, replace with the following:

Mix Type	Coarse Aggregate Angularity ^B	Fine Aggregate Angularity % Minimum	Sand Equivalent % Minimum	Flat and Elongated 5 : 1 Ratio % Maximum
<i>Test Method</i>	<i>ASTM D5821</i>	<i>AASHTO T 304</i>	<i>AASHTO T 176</i>	<i>ASTM D4791</i>
S4.75A; S9.5B	75 / -	40	40	-
S9.5C; I19.0C; B25.0C	95 / 90	45	45	10
S9.5D	100 / 100	45	50	10
OGFC	100 / 100	45	45	10
UBWC	100 / 85	45	45	10

A. Requirements apply to the design aggregate blend.

B. 95 / 90 denotes that 95% of the coarse aggregate has one fractured face and 90% has 2 or more fractured faces.

PATCHING EXISTING PAVEMENT:

(1-15-02) (Rev.12-18-12) (Rev. Div. 7 12-11-15)

610

SP6 R88R(Rev)

Description

The Contractor's attention is directed to the fact that there are areas of existing pavement on this project that will require repair prior to resurfacing. The areas to be patched will be delineated by the Engineer prior to the Contractor performing repairs. The contractor should note that a milling machine **SHALL be required for this operation and that the patches are to be in accordance with the plans and as designated by the engineer.**

Materials

The patching consists of Asphalt Concrete Intermediate Course.

Construction Methods

Remove existing pavement at locations directed by the Engineer in accordance with Section 607 of the *2018 Standard Specifications* and the following additions. **The Contractor shall mill the material to be removed with a milling machine. No other method of removal shall be acceptable.**

Place Asphalt Concrete Intermediate Course in lifts in accordance with the plans. Utilize compaction equipment suitable for compacting patches as small as 3.5 feet by 6 feet on each lift. Use an approved compaction pattern to achieve proper compaction. If patched pavement is to be open to traffic for more than 48 hours prior to overlay, use Asphalt Surface Course in the top 1.5 inches of the patch.

Schedule operations so that all areas where pavement has been removed will be repaired on the same day of the pavement removal and all lanes of traffic restored.

Measurement and Payment

Patching Existing Pavement will be measured and paid as the actual number of tons of asphalt plant mix complete in place that has been used to make completed and accepted repairs. The asphalt plant mixed material will be measured by being weighed in trucks on certified platform scales or other certified weighing devices. The above price and payment will be full compensation for all work covered by this provision, including but not limited to milling, removal and disposal of all types of pavement; furnishing and applying tack coat; furnishing, placing, and compacting of asphalt plant mix; furnishing of asphalt binder for the asphalt plant mix; and furnishing scales.

Any provisions included in the contract that provides for adjustments in compensation due to variations in the price of asphalt binder will not be applicable to payment for the work covered by this provision.

Payment will be made under:

Pay Item

Patching Existing Pavement

Pay Unit

Ton

REMOVE AND REPLACE CONCRETE APRON:

(12-2-2015)

Div. 7

Description

This work shall consist of removing and replacing existing concrete aprons at existing drainage structures.

Materials and Construction Methods

Remove existing concrete aprons as directed by the Engineer. Construct concrete aprons in accordance with Section 840 of the *Standard Specifications*, the details shown in the *Roadway Standard Drawings* No. 840.18 and 840.27, and as directed by the Engineer.

Measurement and Payment

Remove And Replace Concrete Apron at existing drainage structures will be measured and paid per each concrete apron that has been completed and accepted. Work shall include but not be limited to removal of existing damaged apron, remove and reinstall existing frame and grate construction of and placement of the new concrete apron, backfilling and compacting backfill material, joint material and sealant and seeding and mulching all grass or soil areas disturbed by the Contractor's operations.

Payment will be made under:

Pay Item

Remove And Replace Concrete Apron

Pay Unit

Each

REPLACE EXISTING BARRIER DELINEATOR:

(04-25-07) (4-27-2017)

SP

Barrier Delineators installed shall comply with the requirements of Article 1088-2 of the 2018 *Standard Specifications for Roads and Structures*.

Page 11-17, Article 1170-4 Measurement and Payment, add the following as the fourth paragraph:

Replace Existing Barrier Delineator will be measured and paid for in units of each that have been completed and accepted.

Add the following pay item:

Pay Item

Replace Existing Barrier Delineator

Pay Unit

Each

EROSION AND STORMWATER CONTROL FOR SHOULDER CONSTRUCTION AND RECONSTRUCTION:

(11-16-10) (Rev. 8-21-12)

105-16, 225-2, Division 16

SP16 R03R

Land disturbing operations associated with shoulder construction/reconstruction may require erosion and sediment control/stormwater measure installation. National Pollutant Discharge Elimination System (NPDES) inspection and reporting may be required.

Erosion control measures shall be installed per the erosion control detail in any area where the vegetated buffer between the disturbed area and surface waters (streams, wetlands, or open waters) or drainage inlet is less than 10 feet. The Engineer may reduce the vegetated buffer threshold for this requirement to a value between 5 and 10 feet. Erosion control measures shall be spot checked every 14 days until permanent vegetative establishment.

In areas where shoulder construction/reconstruction includes disturbance or grading on the front slope or to the toe of fill, relocating ditch line or backslope, or removing vegetation from the ditch line or swale, NPDES inspection and monitoring are required every 14 days or within 24 hours of a rainfall event of 0.5 inch or greater. Maintain daily rainfall records. Install erosion control measures per detail.

In areas where the vegetated buffer is less than 10 feet between the disturbed area and waters of the State classified as High Quality Water (HQW), Outstanding Resource Water (ORW), Critical Areas, or Unique Wetlands, NPDES inspection and monitoring are required every 14 days or within 24 hours of a rainfall event of 0.5" or greater. The Engineer may reduce the vegetated buffer threshold for this requirement to a value between 5 and 10 feet. The plans or provisions will indicate the presence of these water classifications. Maintain daily rainfall records. Install erosion control measures per detail.

Land disturbances hardened with aggregate materials receiving sheet flow are considered non-erodible.

Sites that require lengthy sections of silt fence may substitute with rapid permanent seeding and mulching as directed by the Engineer.

NPDES documentation shall be performed by a Level II Erosion and Sediment Control/Stormwater certificate holder.

Materials used for erosion control will be measured and paid as stated in the contract.

STANDARD SPECIAL PROVISION
AVAILABILITY OF FUNDS – TERMINATION OF CONTRACTS

(5-20-08)

Z-2

General Statute 143C-6-11. (h) Highway Appropriation is hereby incorporated verbatim in this contract as follows:

(h) Amounts Encumbered. – Transportation project appropriations may be encumbered in the amount of allotments made to the Department of Transportation by the Director for the estimated payments for transportation project contract work to be performed in the appropriation fiscal year. The allotments shall be multiyear allotments and shall be based on estimated revenues and shall be subject to the maximum contract authority contained in *General Statute 143C-6-11(c)*. Payment for transportation project work performed pursuant to contract in any fiscal year other than the current fiscal year is subject to appropriations by the General Assembly. Transportation project contracts shall contain a schedule of estimated completion progress, and any acceleration of this progress shall be subject to the approval of the Department of Transportation provided funds are available. The State reserves the right to terminate or suspend any transportation project contract, and any transportation project contract shall be so terminated or suspended if funds will not be available for payment of the work to be performed during that fiscal year pursuant to the contract. In the event of termination of any contract, the contractor shall be given a written notice of termination at least 60 days before completion of scheduled work for which funds are available. In the event of termination, the contractor shall be paid for the work already performed in accordance with the contract specifications.

Payment will be made on any contract terminated pursuant to the special provision in accordance with Subarticle 108-13(D) of the *2018 Standard Specifications*.

STANDARD SPECIAL PROVISION
NCDOT GENERAL SEED SPECIFICATION FOR SEED QUALITY

(5-17-11)

Z-3

Seed shall be sampled and tested by the North Carolina Department of Agriculture and Consumer Services, Seed Testing Laboratory. When said samples are collected, the vendor shall supply an independent laboratory report for each lot to be tested. Results from seed so sampled shall be final. Seed not meeting the specifications shall be rejected by the Department of Transportation and shall not be delivered to North Carolina Department of Transportation warehouses. If seed has been delivered it shall be available for pickup and replacement at the supplier's expense.

Any re-labeling required by the North Carolina Department of Agriculture and Consumer Services, Seed Testing Laboratory, that would cause the label to reflect as otherwise specified herein shall be rejected by the North Carolina Department of Transportation.

Seed shall be free from seeds of the noxious weeds Johnsongrass, Balloonvine, Jimsonweed, Witchweed, Itchgrass, Serrated Tussock, Showy Crotalaria, Smooth Crotalaria, Sicklepod, Sandbur, Wild Onion, and Wild Garlic. Seed shall not be labeled with the above weed species on the seed analysis label. Tolerances as applied by the Association of Official Seed Analysts will NOT be allowed for the above noxious weeds except for Wild Onion and Wild Garlic.

Tolerances established by the Association of Official Seed Analysts will generally be recognized. However, for the purpose of figuring pure live seed, the found pure seed and found germination percentages as reported by the North Carolina Department of Agriculture and Consumer Services, Seed Testing Laboratory will be used. Allowances, as established by the NCDOT, will be recognized for minimum pure live seed as listed on the following pages.

The specifications for restricted noxious weed seed refers to the number per pound as follows:

<u>Restricted Noxious Weed</u>	<u>Limitations per Lb. Of Seed</u>	<u>Restricted Noxious Weed</u>	<u>Limitations per Lb. of Seed</u>
Blessed Thistle	4 seeds	Cornflower (Ragged Robin)	27 seeds
Cocklebur	4 seeds	Texas Panicum	27 seeds
Spurred Anoda	4 seeds	Bracted Plantain	54 seeds
Velvetleaf	4 seeds	Buckhorn Plantain	54 seeds
Morning-glory	8 seeds	Broadleaf Dock	54 seeds
Corn Cockle	10 seeds	Curly Dock	54 seeds
Wild Radish	12 seeds	Dodder	54 seeds
Purple Nutsedge	27 seeds	Giant Foxtail	54 seeds
Yellow Nutsedge	27 seeds	Horsenettle	54 seeds
Canada Thistle	27 seeds	Quackgrass	54 seeds
Field Bindweed	27 seeds	Wild Mustard	54 seeds
Hedge Bindweed	27 seeds		

Seed of Pensacola Bahiagrass shall not contain more than 7% inert matter, Kentucky Bluegrass, Centipede and Fine or Hard Fescue shall not contain more than 5% inert matter whereas a maximum of 2% inert matter will be allowed on all other kinds of seed. In addition, all seed shall

not contain more than 2% other crop seed nor more than 1% total weed seed. The germination rate as tested by the North Carolina Department of Agriculture shall not fall below 70%, which includes both dormant and hard seed. Seed shall be labeled with not more than 7%, 5% or 2% inert matter (according to above specifications), 2% other crop seed and 1% total weed seed.

Exceptions may be made for minimum pure live seed allowances when cases of seed variety shortages are verified. Pure live seed percentages will be applied in a verified shortage situation. Those purchase orders of deficient seed lots will be credited with the percentage that the seed is deficient.

FURTHER SPECIFICATIONS FOR EACH SEED GROUP ARE GIVEN BELOW:

Minimum 85% pure live seed; maximum 1% total weed seed; maximum 2% total other crop seed; maximum 144 restricted noxious weed seed per pound. Seed less than 83% pure live seed will not be approved.

Sericea Lespedeza
Oats (seeds)

Minimum 80% pure live seed; maximum 1% total weed seed; maximum 2% total other crop; maximum 144 restricted noxious weed seed per pound. Seed less than 78% pure live seed will not be approved.

Tall Fescue (all approved varieties)	Bermudagrass
Kobe Lespedeza	Browntop Millet
Korean Lespedeza	German Millet – Strain R
Weeping Lovegrass	Clover – Red/White/Crimson
Carpetgrass	

Minimum 78% pure live seed; maximum 1% total weed seed; maximum 2% total other crop seed; maximum 144 restricted noxious weed seed per pound. Seed less than 76% pure live seed will not be approved.

Common or Sweet Sundangrass

Minimum 76% pure live seed; maximum 1% total weed seed; maximum 2% total other crop seed; maximum 144 restricted noxious weed seed per pound. Seed less than 74% pure live seed will not be approved.

Rye (grain; all varieties)
Kentucky Bluegrass (all approved varieties)
Hard Fescue (all approved varieties)
Shrub (bicolor) Lespedeza

Minimum 70% pure live seed; maximum 1% total weed seed; maximum 2% total other crop seed; maximum 144 noxious weed seed per pound. Seed less than 70% pure live seed will not be approved.

Centipedegrass	Japanese Millet
Crownvetch	Reed Canary Grass
Pensacola Bahiagrass	Zoysia
Creeping Red Fescue	

Minimum 70% pure live seed; maximum 1% total weed seed; maximum 2% total other crop seed; maximum 5% inert matter; maximum 144 restricted noxious weed seed per pound.

Barnyard Grass
Big Bluestem
Little Bluestem
Bristly Locust
Birdsfoot Trefoil
Indiangrass
Orchardgrass
Switchgrass
Yellow Blossom Sweet Clover

STANDARD SPECIAL PROVISION

ERRATA

(2-12-18)

Z-4

Revise the *2018 Standard Specifications* as follows:

Division 7

Page 7-27, line 4, Article 725-1 MEASUREMENT AND PAYMENT, replace article number “725-1” with “724-4”.

Page 7-28, line 10, Article 725-1 MEASUREMENT AND PAYMENT, replace article number “725-1” with “725-3”.

Division 8

Page 8-23, lines 3, 6, 11 and 13, Section 836, SLUICE GATE, replace article number “8366” with “836”.

Division 10

Page 10-69, Table 1046-1 WIRE DIAMETER, rename RECYCLED PLASTIC AND COMPOSITE OFFSET BLOCK PROPERTIES

Page 10-162, line 1, Article 1080-50 PAINT FOR VERTICAL MARKERS, replace article number “1080-50” with “1080-10”.

Page 10-162, line 5, Article 1080-61 EPOXY RESIN FOR REINFORCING STEEL, replace article number “1080-61” with “1080-11”.

Page 10-162, line 22, Article 1080-72 ABRASIVE MATERIALS FOR BLAST CLEANING STEEL, replace article number “1080-72” with “1080-12”.

Page 10-163, line 25, Article 1080-83 FIELD PERFORMANCE AND SERVICES, replace article number “1080-83” with “1080-13”.

STANDARD SPECIAL PROVISION**PLANT AND PEST QUARANTINES****(Imported Fire Ant, Gypsy Moth, Witchweed, Emerald Ash Borer, And Other Noxious Weeds)**

(3-18-03) (Rev. 12-20-16)

Z-04a

Within Quarantined Area

This project may be within a county regulated for plant and/or pests. If the project or any part of the Contractor's operations is located within a quarantined area, thoroughly clean all equipment prior to moving out of the quarantined area. Comply with federal/state regulations by obtaining a certificate or limited permit for any regulated article moving from the quarantined area.

Originating in a Quarantined County

Obtain a certificate or limited permit issued by the N.C. Department of Agriculture/United States Department of Agriculture. Have the certificate or limited permit accompany the article when it arrives at the project site.

Contact

Contact the N.C. Department of Agriculture/United States Department of Agriculture at 1-800-206-9333, 919-707-3730, or <http://www.ncagr.gov/plantindustry/> to determine those specific project sites located in the quarantined area or for any regulated article used on this project originating in a quarantined county.

Regulated Articles Include

1. Soil, sand, gravel, compost, peat, humus, muck, and decomposed manure, separately or with other articles. This includes movement of articles listed above that may be associated with cut/waste, ditch pulling, and shoulder cutting.
2. Plants with roots including grass sod.
3. Plant crowns and roots.
4. Bulbs, corms, rhizomes, and tubers of ornamental plants.
5. Hay, straw, fodder, and plant litter of any kind.
6. Clearing and grubbing debris.
7. Used agricultural cultivating and harvesting equipment.
8. Used earth-moving equipment.
9. Any other products, articles, or means of conveyance, of any character, if determined by an inspector to present a hazard of spreading imported fire ant, gypsy moth, witchweed, emerald ash borer, or other noxious weeds.

STANDARD SPECIAL PROVISION**TITLE VI AND NONDISCRIMINATION:**

(6-28-77)(Rev 6/19/2018)

Z-6

Revise the *2018 Standard Specifications* as follows:

Replace Article 103-4(B) with the following:

The North Carolina Department of Transportation is committed to carrying out the U.S. Department of Transportation's policy of ensuring nondiscrimination in the award and administration of contracts.

The provisions of this section related to United States Department of Transportation (US DOT) Order 1050.2A, Title 49 Code of Federal Regulations (CFR) part 21, 23 United States Code (U.S.C.) 140 and 23 CFR part 200 (or 49 CFR 303, 49 U.S.C. 5332 or 49 U.S.C. 47123) are applicable to all North Carolina Department of Transportation (NCDOT) contracts and to all related subcontracts, material supply, engineering, architectural and other service contracts, regardless of dollar amount. Any Federal provision that is specifically required not specifically set forth is hereby incorporated by reference.

(1) Title VI Assurances (USDOT Order 1050.2A, Appendix A)

During the performance of this contract, the contractor, for itself, its assignees, and successors in interest (hereinafter referred to as the "contractor") agrees as follows:

(a) Compliance with Regulations

The contractor (hereinafter includes consultants) shall comply with the Acts and the Regulations relative to Nondiscrimination in Federally-assisted programs of the U.S. Department of Transportation, Federal Highway Administration (FHWA), as they may be amended from time to time, which are herein incorporated by reference and made a part of this contract.

(b) Nondiscrimination

The contractor, with regard to the work performed by it during the contract, shall not discriminate on the grounds of race, color, or national origin in the selection and retention of subcontractors, including procurements of materials and leases of equipment. The contractor shall not participate directly or indirectly in the discrimination prohibited by the Acts and the Regulations, including employment practices when the contract covers any activity, project, or program set forth in Appendix B of 49 CFR Part 21.

(c) Solicitations for Subcontractors, Including Procurements of Materials and Equipment

In all solicitations, either by competitive bidding, or negotiation made by the contractor for work to be performed under a subcontract, including procurements of materials, or leases of equipment, each potential subcontractor or supplier shall be notified by the contractor of the contractor's obligations under this contract and the Acts and the Regulations relative to Nondiscrimination on the grounds of race, color, or national origin.

(d) Information and Reports

The contractor shall provide all information and reports required by the Acts, the Regulations, and directives issued pursuant thereto and shall permit access to its books, records, accounts, other sources of information, and its facilities as may be determined by the Recipient or the FHWA to be pertinent to ascertain compliance with such Acts, Regulations, and instructions. Where any information required of a contractor is in the exclusive possession of another who fails or refuses to furnish the information, the contractor shall so certify to the Recipient or the FHWA, as appropriate, and shall set forth what efforts it has made to obtain the information.

(e) Sanctions for Noncompliance:

In the event of a contractor's noncompliance with the Non-discrimination provisions of this contract, the Recipient will impose such contract sanctions as it and/or the FHWA may determine to be appropriate, including, but not limited to:

- (i) Withholding payments to the contractor under the contract until the contractor complies; and/or
- (ii) Cancelling, terminating, or suspending a contract, in whole or in part.

(f) Incorporation of Provisions

The contractor shall include the provisions of paragraphs one through six in every subcontract, including procurements of materials and leases of equipment, unless exempt by the Acts, the Regulations and directives issued pursuant thereto. The contractor shall take action with respect to any subcontract or procurement as the Recipient or the FHWA may direct as a means of enforcing such provisions including sanctions for noncompliance. Provided, that if the contractor becomes involved in, or is threatened with litigation by a subcontractor, or supplier because of such direction, the contractor may request the Recipient to enter into any litigation to protect the interests of the Recipient. In addition, the contractor may request the United States to enter into the litigation to protect the interests of the United States.

(2) Title VI Nondiscrimination Program (23 CFR 200.5(p))

The North Carolina Department of Transportation (NCDOT) has assured the USDOT that, as a condition to receiving federal financial assistance, NCDOT will comply with Title VI of the Civil Rights Act of 1964 and all requirements imposed by Title 49 CFR part 21 and related nondiscrimination authorities to ensure that no person shall, on the ground of race, color, national origin, limited English proficiency, sex, age, or disability (including religion/creed or income-level, where applicable), be excluded from participation in, be denied the benefits of, or be subjected to discrimination under any programs, activities, or services conducted or funded by NCDOT. Contractors and other organizations under contract or agreement with NCDOT must also comply with Title VI and related authorities, therefore:

- (a) During the performance of this contract or agreement, contractors (e.g., subcontractors, consultants, vendors, prime contractors) are responsible for complying with NCDOT's Title VI Program. Contractors are not required to prepare or submit Title VI Programs. To comply with this section, the prime contractor shall:
 - 1. Post NCDOT's Notice of Nondiscrimination and the Contractor's own Equal Employment Opportunity (EEO) Policy in conspicuous locations accessible to all employees, applicants and subcontractors on the jobsite.

2. Physically incorporate the required Title VI clauses into all subcontracts on federally-assisted and state-funded NCDOT projects, and ensure inclusion by subcontractors into all lower-tier subcontracts.
 3. Required Solicitation Language. The Contractor shall include the following notification in all solicitations for bids and requests for work or material, regardless of funding source:

“The North Carolina Department of Transportation, in accordance with the provisions of Title VI of the Civil Rights Act of 1964 (78 Stat. 252, 42 U.S.C. §§ 2000d to 2000d-4) and the Regulations, hereby notifies all bidders that it will affirmatively ensure that any contract entered into pursuant to this advertisement, disadvantaged business enterprises will be afforded full and fair opportunity to submit bids in response to this invitation and will not be discriminated against on the grounds of race, color, or national origin in consideration for an award. In accordance with other related nondiscrimination authorities, bidders and contractors will also not be discriminated against on the grounds of sex, age, disability, low-income level, creed/religion, or limited English proficiency in consideration for an award.”
 4. Physically incorporate the FHWA-1273, in its entirety, into all subcontracts and subsequent lower tier subcontracts on Federal-aid highway construction contracts only.
 5. Provide language assistance services (i.e., written translation and oral interpretation), free of charge, to LEP employees and applicants. Contact NCDOT OCR for further assistance, if needed.
 6. For assistance with these Title VI requirements, contact the NCDOT Title VI Nondiscrimination Program at 1-800-522-0453.
- (b) Subrecipients (e.g. cities, counties, LGAs, planning organizations) may be required to prepare and submit a Title VI Plan to NCDOT, including Title VI Assurances and/or agreements. Subrecipients must also ensure compliance by their contractors and subrecipients with Title VI. (23 CFR 200.9(b)(7))
- (c) If reviewed or investigated by NCDOT, the contractor or subrecipient agrees to take affirmative action to correct any deficiencies found within a reasonable time period, not to exceed 90 calendar days, unless additional time is granted by NCDOT. (23 CFR 200.9(b)(15))
- (d) The Contractor is responsible for notifying subcontractors of NCDOT’s External Discrimination Complaints Process.
1. Applicability

Title VI and related laws protect participants and beneficiaries (e.g., members of the public and contractors) from discrimination by NCDOT employees, subrecipients and contractors, regardless of funding source.

2. Eligibility

Any person—or class of persons—who believes he/she has been subjected to discrimination based on race, color, national origin, Limited English Proficiency (LEP), sex, age, or disability (and religion in the context of employment, aviation, or transit) may file a written complaint. The law also prohibits intimidation or retaliation of any sort.

3. Time Limits and Filing Options

Complaints may be filed by the affected individual(s) or a representative and must be filed no later than 180 calendar days after the following:

- (i) The date of the alleged act of discrimination; or
- (ii) The date when the person(s) became aware of the alleged discrimination; or
- (iii) Where there has been a continuing course of conduct, the date on which that conduct was discontinued or the latest instance of the conduct.

Title VI and related discrimination complaints may be submitted to the following entities:

- North Carolina Department of Transportation, Office of Civil Rights, Title VI Program, 1511 Mail Service Center, Raleigh, NC 27699-1511; toll free 1-800-522-0453
- Federal Highway Administration, North Carolina Division Office, 310 New Bern Avenue, Suite 410, Raleigh, NC 27601, 919-747-7010
- US Department of Transportation, Departmental Office of Civil Rights, External Civil Rights Programs Division, 1200 New Jersey Avenue, SE, Washington, DC 20590; 202-366-4070

4. Format for Complaints

Complaints must be in writing and signed by the complainant(s) or a representative, and include the complainant's name, address, and telephone number. Complaints received by fax or e-mail will be acknowledged and processed. Allegations received by telephone will be reduced to writing and provided to the complainant for confirmation or revision before processing. Complaints will be accepted in other languages, including Braille.

5. Discrimination Complaint Form

Contact NCDOT Civil Rights to receive a full copy of the Discrimination Complaint Form and procedures.

6. Complaint Basis

Allegations must be based on issues involving race, color, national origin (LEP), sex, age, disability, or religion (in the context of employment, aviation or transit). "Basis" refers to the complainant's membership in a protected group category.

**TABLE 103-1
COMPLAINT BASIS**

Protected Categories	Definition	Examples	Applicable Nondiscrimination Authorities
Race and Ethnicity	An individual belonging to one of the accepted racial groups; or the perception, based usually on physical characteristics that a person is a member of a racial group	Black/African American, Hispanic/Latino, Asian, American Indian/Alaska Native, Native Hawaiian/Pacific Islander, White	Title VI of the Civil Rights Act of 1964; 49 CFR Part 21; 23 CFR 200; 49 U.S.C. 5332(b); 49 U.S.C. 47123. (<i>Executive Order 13166</i>)
Color	Color of skin, including shade of skin within a racial group	Black, White, brown, yellow, etc.	
National Origin (<i>Limited English Proficiency</i>)	Place of birth. Citizenship is not a factor. (<i>Discrimination based on language or a person's accent is also covered</i>)	Mexican, Cuban, Japanese, Vietnamese, Chinese	
Sex	Gender. The sex of an individual. <i>Note: Sex under this program does not include sexual orientation.</i>	Women and Men	1973 Federal-Aid Highway Act; 49 U.S.C. 5332(b); 49 U.S.C. 47123.
Age	Persons of any age	21-year-old person	Age Discrimination Act of 1975 49 U.S.C. 5332(b); 49 U.S.C. 47123.
Disability	Physical or mental impairment, permanent or temporary, or perceived.	Blind, alcoholic, para-amputee, epileptic, diabetic, arthritic	Section 504 of the Rehabilitation Act of 1973; Americans with Disabilities Act of 1990
Religion (in the context of employment) (<i>Religion/ Creed in all aspects of any aviation or transit-related construction</i>)	An individual belonging to a religious group; or the perception, based on distinguishable characteristics that a person is a member of a religious group. In practice, actions taken as a result of the moral and ethical beliefs as to what is right and wrong, which are sincerely held with the strength of traditional religious views. <i>Note: Does not have to be associated with a recognized religious group or church; if an individual sincerely holds to the belief, it is a protected religious practice.</i>	Muslim, Christian, Sikh, Hindu, etc.	Title VII of the Civil Rights Act of 1964; 23 CFR 230; FHWA-1273 Required Contract Provisions. (<i>49 U.S.C. 5332(b); 49 U.S.C. 47123</i>)

(3) Pertinent Nondiscrimination Authorities

During the performance of this contract, the contractor, for itself, its assignees, and successors in interest agrees to comply with the following non-discrimination statutes and authorities, including, but not limited to:

- (a) Title VI of the Civil Rights Act of 1964 (42 U.S.C. § 2000d et seq., 78 stat. 252), (prohibits discrimination on the basis of race, color, national origin); and 49 CFR Part 21.

- (b) The Uniform Relocation Assistance and Real Property Acquisition Policies Act of 1970, (42 U.S.C. § 4601), (prohibits unfair treatment of persons displaced or whose property has been acquired because of Federal or Federal-aid programs and projects);
- (c) Federal-Aid Highway Act of 1973, (23 U.S.C. § 324 et seq.), (prohibits discrimination on the basis of sex);
- (d) Section 504 of the Rehabilitation Act of 1973, (29 U.S.C. § 794 et seq.), as amended, (prohibits discrimination on the basis of disability) and 49 CFR Part 27;
- (e) The Age Discrimination Act of 1975, as amended, (42 U.S.C. § 6101 et seq.), (prohibits discrimination on the basis of age);
- (f) Airport and Airway Improvement Act of 1982, (49 USC § 471, Section 47123), as amended, (prohibits discrimination based on race, creed, color, national origin, or sex);
- (g) The Civil Rights Restoration Act of 1987, (PL 100-209), (Broadened the scope, coverage and applicability of Title VI of the Civil Rights Act of 1964, The Age Discrimination Act of 1975 and Section 504 of the Rehabilitation Act of 1973, by expanding the definition of the terms "programs or activities" to include all of the programs or activities of the Federal-aid recipients, sub-recipients and contractors, whether such programs or activities are Federally funded or not);
- (h) Titles II and III of the Americans with Disabilities Act, which prohibit discrimination on the basis of disability in the operation of public entities, public and private transportation systems, places of public accommodation, and certain testing entities (42 U.S.C. §§ 12131-12189) as implemented by Department of Transportation regulations at 49 C.F.R. parts 37 and 38;
- (i) The Federal Aviation Administration's Nondiscrimination statute (49 U.S.C. § 47123) (prohibits discrimination on the basis of race, color, national origin, and sex);
- (j) Executive Order 12898, Federal Actions to Address Environmental Justice in Minority Populations and Low-Income Populations, which ensures Nondiscrimination against minority populations by discouraging programs, policies, and activities with disproportionately high and adverse human health or environmental effects on minority and low-income populations;
- (k) Executive Order 13166, Improving Access to Services for Persons with Limited English Proficiency, and resulting agency guidance, national origin discrimination includes discrimination because of Limited English proficiency (LEP). To ensure compliance with Title VI, you must take reasonable steps to ensure that LEP persons have meaningful access to your programs (70 Fed. Reg. at 74087 to 74100);
- (l) Title IX of the Education Amendments of 1972, as amended, which prohibits you from discriminating because of sex in education programs or activities (20 U.S.C. 1681 et seq).
- (m) Title VII of the Civil Rights Act of 1964 (42 U.S.C. § 2000e et seq., Pub. L. 88-352), (prohibits employment discrimination on the basis of race, color, religion, sex, or national origin).

(4) Additional Title VI Assurances

***The following Title VI Assurances (Appendices B, C and D) shall apply, as applicable*

- (a) Clauses for Deeds Transferring United States Property (1050.2A, Appendix B)

The following clauses will be included in deeds effecting or recording the transfer of real property, structures, or improvements thereon, or granting interest therein from the United States pursuant to the provisions of Assurance 4.

NOW, THEREFORE, the U.S. Department of Transportation as authorized by law and upon the condition that the North Carolina Department of Transportation (NCDOT) will accept title to the lands and maintain the project constructed thereon in accordance with the North Carolina General Assembly, the Regulations for the Administration of the Federal-Aid Highway Program, and the policies and procedures prescribed by the Federal Highway Administration of the U.S. Department of Transportation in accordance and in compliance with all requirements imposed by Title 49, Code of Federal Regulations, U.S. Department of Transportation, Subtitle A, Office of the Secretary, Part 21, Nondiscrimination in Federally-assisted programs of the U.S. Department of Transportation pertaining to and effectuating the provisions of Title VI of the Civil Rights Act of 1964 (78 Stat. 252; 42 U.S.C. § 2000d to 2000d-4), does hereby remise, release, quitclaim and convey unto the NCDOT all the right, title and interest of the U.S. Department of Transportation in and to said lands described in Exhibit A attached hereto and made a part hereof.

(HABENDUM CLAUSE)

TO HAVE AND TO HOLD said lands and interests therein unto the North Carolina Department of Transportation (NCDOT) and its successors forever, subject, however, to the covenants, conditions, restrictions and reservations herein contained as follows, which will remain in effect for the period during which the real property or structures are used for a purpose for which Federal financial assistance is extended or for another purpose involving the provision of similar services or benefits and will be binding on the NCDOT, its successors and assigns.

The NCDOT, in consideration of the conveyance of said lands and interests in lands, does hereby covenant and agree as a covenant running with the land for itself, its successors and assigns, that (1) no person will on the grounds of race, color, or national origin, be excluded from participation in, be denied the benefits of, or be otherwise subjected to discrimination with regard to any facility located wholly or in part on, over, or under such lands hereby conveyed [,] [and]* (2) that the NCDOT will use the lands and interests in lands and interests in lands so conveyed, in compliance with all requirements imposed by or pursuant to Title 49, Code of Federal Regulations, U.S. Department of Transportation, Subtitle A, Office of the Secretary, Part 21, Nondiscrimination in Federally-assisted programs of the U.S. Department of Transportation, Effectuation of Title VI of the Civil Rights Act of 1964, and as said Regulations and Acts may be amended [, and (3) that in the event of breach of any of the above-mentioned nondiscrimination conditions, the Department will have a right to enter or re-enter said lands and facilities on said land, and that above described land and facilities will thereon revert to and vest in and become the absolute property of the U.S. Department of Transportation and its assigns as such interest existed prior to this instruction].*

(*Reverter clause and related language to be used only when it is determined that such a clause is necessary in order to make clear the purpose of Title VI.)

(b) Clauses for Transfer of Real Property Acquired or Improved Under the Activity, Facility, or Program (1050.2A, Appendix C)

The following clauses will be included in deeds, licenses, leases, permits, or similar instruments entered into by the North Carolina Department of Transportation (NCDOT) pursuant to the provisions of Assurance 7(a):

1. The (grantee, lessee, permittee, etc. as appropriate) for himself/herself, his/her heirs, personal representatives, successors in interest, and assigns, as a part of the consideration hereof, does hereby covenant and agree [in the case of deeds and leases add "as a covenant running with the land"] that:
 - (i.) In the event facilities are constructed, maintained, or otherwise operated on the property described in this (deed, license, lease, permit, etc.) for a purpose for which a U.S. Department of Transportation activity, facility, or program is extended or for another purpose involving the provision of similar services or benefits, the (grantee, licensee, lessee, permittee, etc.) will maintain and operate such facilities and services in compliance with all requirements imposed by the Acts and Regulations (as may be amended) such that no person on the grounds of race, color, or national origin, will be excluded from participation in, denied the benefits of, or be otherwise subjected to discrimination in the use of said facilities.
2. With respect to licenses, leases, permits, etc., in the event of breach of any of the above Nondiscrimination covenants, the NCDOT will have the right to terminate the (lease, license, permit, etc.) and to enter, re-enter, and repossess said lands and facilities thereon, and hold the same as if the (lease, license, permit, etc.) had never been made or issued. *
3. With respect to a deed, in the event of breach of any of the above Nondiscrimination covenants, the NCDOT will have the right to enter or re-enter the lands and facilities thereon, and the above described lands and facilities will there upon revert to and vest in and become the absolute property of the NCDOT and its assigns. *

(*Reverter clause and related language to be used only when it is determined that such a clause is necessary to make clear the purpose of Title VI.)

(c) Clauses for Construction/Use/Access to Real Property Acquired Under the Activity, Facility or Program (1050.2A, Appendix D)

The following clauses will be included in deeds, licenses, permits, or similar instruments/ agreements entered into by the North Carolina Department of Transportation (NCDOT) pursuant to the provisions of Assurance 7(b):

1. The (grantee, licensee, permittee, etc., as appropriate) for himself/herself, his/her heirs, personal representatives, successors in interest, and assigns, as a part of the consideration hereof, does hereby covenant and agree (in the case of deeds and leases add, "as a covenant running with the land") that (1) no person on the ground of race, color, or national origin, will be excluded from participation in, denied the benefits of, or be otherwise subjected to discrimination in the use of said facilities, (2) that in the construction of any improvements on, over, or under such land, and the furnishing of services thereon, no person on the ground of race, color, or national origin, will be excluded from participation in, denied the benefits of, or otherwise be subjected to discrimination, (3) that the (grantee, licensee, lessee, permittee, etc.) will use the premises in compliance with all other requirements imposed by or pursuant to the Acts and Regulations, as amended, set forth in this Assurance.
2. With respect to (licenses, leases, permits, etc.), in the event of breach of any of the above Non-discrimination covenants, the NCDOT will have the right to terminate the (license, permit, etc., as appropriate) and to enter or re-enter and repossess said land and the facilities thereon, and hold the same as if said (license, permit, etc., as appropriate) had never been made or issued. *
3. With respect to deeds, in the event of breach of any of the above Nondiscrimination covenants, the NCDOT will there upon revert to and vest in and become the absolute property of the NCDOT and its assigns. *

(*Reverter clause and related language to be used only when it is determined that such a clause is necessary to make clear the purpose of Title VI.)

STANDARD SPECIAL PROVISION**MINORITY AND FEMALE EMPLOYMENT REQUIREMENTS**

Z-7

NOTICE OF REQUIREMENTS FOR AFFIRMATIVE ACTION TO ENSURE EQUAL EMPLOYMENT OPPORTUNITY (*EXECUTIVE NUMBER 11246*)

1. The goals and timetables for minority and female participation, expressed in percentage terms for the Contractor's aggregate workforce in each trade on all construction work in the covered area, see as shown on the attached sheet entitled "Employment Goals for Minority and Female participation".

These goals are applicable to all the Contractor's construction work (whether or not it is Federal or federally assisted) performed in the covered area. If the Contractor performs construction work in a geographical area located outside of the covered area, it shall apply the goals established for such geographical area where the work is actually performed. With regard to this second area, the Contractor also is subject to the goals for both its federally involved and nonfederally involved construction.

The Contractor's compliance with the Executive Order and the regulations in *41 CFR Part 60-4* shall be based on its implementation of the Equal Opportunity Clause, specific affirmative action obligations required by the specifications set forth in *41 CFR 60-4.3(a)*, and its effort to meet the goals. The hours of minority and female employment and training must be substantially uniform throughout the length of the contract, and in each trade and the Contractor shall make a good faith effort to employ minorities and women evenly on each of its projects. The transfer of minority or female employees or trainees from Contractor to Contractor or from project to project for the sole purpose of meeting the Contractor's goals shall be a violation of the contract, the executive Order and the regulations in *41 CFR Part 60-4*. Compliance with the goals will be measured against the total work hours performed.

2. As used in this Notice and in the contract resulting from this solicitation, the "covered area" is the county or counties shown on the cover sheet of the proposal form and contract.

**EMPLOYMENT GOALS FOR MINORITY
AND FEMALE PARTICIPATION**

Economic Areas

Area 023 29.7%

Bertie County
Camden County
Chowan County
Gates County
Hertford County
Pasquotank County
Perquimans County

Area 024 31.7%

Beaufort County
Carteret County
Craven County
Dare County
Edgecombe County
Green County
Halifax County
Hyde County
Jones County
Lenoir County
Martin County
Nash County
Northampton County
Pamlico County
Pitt County
Tyrrell County
Washington County
Wayne County
Wilson County

Area 025 23.5%

Columbus County
Duplin County
Onslow County
Pender County

Area 026 33.5%

Bladen County
Hoke County
Richmond County
Robeson County
Sampson County
Scotland County

Area 027 24.7%

Chatham County
Franklin County
Granville County
Harnett County
Johnston County
Lee County
Person County
Vance County
Warren County

Area 028 15.5%

Alleghany County
Ashe County
Caswell County
Davie County
Montgomery County
Moore County
Rockingham County
Surry County
Watauga County
Wilkes County

Area 029 15.7%

Alexander County
Anson County
Burke County
Cabarrus County
Caldwell County
Catawba County
Cleveland County
Iredell County
Lincoln County
Polk County
Rowan County
Rutherford County
Stanly County

Area 0480 8.5%

Buncombe County
Madison County

Area 030 6.3%

Avery County
Cherokee County
Clay County
Graham County
Haywood County
Henderson County
Jackson County
McDowell County
Macon County
Mitchell County
Swain County
Transylvania County
Yancey County

SMSA Areas

Area 5720 26.6%

Currituck County

Area 9200 20.7%

Brunswick County

New Hanover County

Area 2560 24.2%

Cumberland County

Area 6640 22.8%

Durham County

Orange County

Wake County

Area 1300 16.2%

Alamance County

Area 3120 16.4%

Davidson County

Forsyth County

Guilford County

Randolph County

Stokes County

Yadkin County

Area 1520 18.3%

Gaston County

Mecklenburg County

Union County

Goals for Female

Participation in Each Trade

(Statewide) 6.9%

STANDARD SPECIAL PROVISION**REQUIRED CONTRACT PROVISIONS FEDERAL - AID CONSTRUCTION CONTRACTS**

FHWA - 1273 Electronic Version - May 1, 2012

Z-8

- I. General
- II. Nondiscrimination
- III. Nonsegregated Facilities
- IV. Davis-Bacon and Related Act Provisions
- V. Contract Work Hours and Safety Standards Act Provisions
- VI. Subletting or Assigning the Contract
- VII. Safety: Accident Prevention
- VIII. False Statements Concerning Highway Projects
- IX. Implementation of Clean Air Act and Federal Water Pollution Control Act
- X. Compliance with Governmentwide Suspension and Debarment Requirements
- XI. Certification Regarding Use of Contract Funds for Lobbying

ATTACHMENTS

- A. Employment and Materials Preference for Appalachian Development Highway System or Appalachian Local Access Road Contracts (included in Appalachian contracts only)

I. GENERAL

1. Form FHWA-1273 must be physically incorporated in each construction contract funded under Title 23 (excluding emergency contracts solely intended for debris removal). The contractor (or subcontractor) must insert this form in each subcontract and further require its inclusion in all lower tier subcontracts (excluding purchase orders, rental agreements and other agreements for supplies or services).
The applicable requirements of Form FHWA-1273 are incorporated by reference for work done under any purchase order, rental agreement or agreement for other services. The prime contractor shall be responsible for compliance by any subcontractor, lower-tier subcontractor or service provider.
Form FHWA-1273 must be included in all Federal-aid design-build contracts, in all subcontracts and in lower tier subcontracts (excluding subcontracts for design services, purchase orders, rental agreements and other agreements for supplies or services). The design-builder shall be responsible for compliance by any subcontractor, lower-tier subcontractor or service provider.
Contracting agencies may reference Form FHWA-1273 in bid proposal or request for proposal documents, however, the Form FHWA-1273 must be physically incorporated (not referenced) in all contracts, subcontracts and lower-tier subcontracts (excluding purchase orders, rental agreements and other agreements for supplies or services related to a construction contract).
2. Subject to the applicability criteria noted in the following sections, these contract provisions shall apply to all work performed on the contract by the contractor's own organization and with the assistance of workers under the contractor's immediate superintendence and to all work performed on the contract by piecework, station work, or by subcontract.
3. A breach of any of the stipulations contained in these Required Contract Provisions may be sufficient grounds for withholding of progress payments, withholding of final payment, termination of the contract, suspension / debarment or any other action determined to be appropriate by the contracting agency and FHWA.
4. Selection of Labor: During the performance of this contract, the contractor shall not use convict labor for any purpose within the limits of a construction project on a Federal-aid highway unless it is labor performed by convicts who are on parole, supervised release, or probation. The term Federal-aid highway does not include roadways functionally classified as local roads or rural minor collectors.

II. NONDISCRIMINATION

The provisions of this section related to 23 CFR Part 230 are applicable to all Federal-aid construction contracts and to all related construction subcontracts of \$10,000 or more. The provisions of 23 CFR Part 230 are not applicable to material supply, engineering, or architectural service contracts.

In addition, the contractor and all subcontractors must comply with the following policies: Executive Order 11246, 41 CFR 60, 29 CFR 1625-1627, Title 23 USC Section 140, the Rehabilitation Act of 1973, as amended (29 USC 794), Title VI of the Civil Rights Act of 1964, as amended, and related regulations including 49 CFR Parts 21, 26 and 27; and 23 CFR Parts 200, 230, and 633.

The contractor and all subcontractors must comply with: the requirements of the Equal Opportunity Clause in 41 CFR 60-1.4(b) and, for all construction contracts exceeding \$10,000, the Standard Federal Equal Employment Opportunity Construction Contract Specifications in 41 CFR 60-4.3.

Note: The U.S. Department of Labor has exclusive authority to determine compliance with Executive Order 11246 and the policies of the Secretary of Labor including 41 CFR 60, and 29 CFR 1625-1627. The contracting agency and the FHWA have the authority and the responsibility to ensure compliance with Title 23 USC Section 140, the Rehabilitation Act of 1973, as amended (29 USC 794), and Title VI of the Civil Rights Act of 1964, as amended, and related regulations including 49 CFR Parts 21, 26 and 27; and 23 CFR Parts 200, 230, and 633.

The following provision is adopted from 23 CFR 230, Appendix A, with appropriate revisions to conform to the U.S. Department of Labor (US DOL) and FHWA requirements.

1. **Equal Employment Opportunity:** Equal employment opportunity (EEO) requirements not to discriminate and to take affirmative action to assure equal opportunity as set forth under laws, executive orders, rules, regulations (28 CFR 35, 29 CFR 1630, 29 CFR 1625-1627, 41 CFR 60 and 49 CFR 27) and orders of the Secretary of Labor as modified by the provisions prescribed herein, and imposed pursuant to 23 U.S.C. 140 shall constitute the EEO and specific affirmative action standards for the contractor's project activities under this contract. The provisions of the Americans with Disabilities Act of 1990 (42 U.S.C. 12101 et seq.) set forth under 28 CFR 35 and 29 CFR 1630 are incorporated by reference in this contract. In the execution of this contract, the contractor agrees to comply with the following minimum specific requirement activities of EEO:
 - a. The contractor will work with the contracting agency and the Federal Government to ensure that it has made every good faith effort to provide equal opportunity with respect to all of its terms and conditions of employment and in their review of activities under the contract.
 - b. The contractor will accept as its operating policy the following statement:

"It is the policy of this Company to assure that applicants are employed, and that employees are treated during employment, without regard to their race, religion, sex, color, national origin, age or disability. Such action shall include: employment, upgrading, demotion, or transfer; recruitment or recruitment advertising; layoff or termination; rates of pay or other forms of compensation; and selection for training, including apprenticeship, pre-apprenticeship, and/or on-the-job training."

2. **EEO Officer:** The contractor will designate and make known to the contracting officers an EEO Officer who will have the responsibility for and must be capable of effectively administering and promoting an active EEO program and who must be assigned adequate authority and responsibility to do so.
3. **Dissemination of Policy:** All members of the contractor's staff who are authorized to hire, supervise, promote, and discharge employees, or who recommend such action, or who are substantially involved in such action, will be made fully cognizant of, and will implement, the contractor's EEO policy and contractual responsibilities to provide EEO in each grade and classification of employment. To ensure that the above agreement will be met, the following actions will be taken as a minimum:
 - a. Periodic meetings of supervisory and personnel office employees will be conducted before the start of work and then not less often than once every six months, at which time the contractor's EEO policy and its implementation will be reviewed and explained. The meetings will be conducted by the EEO Officer.
 - b. All new supervisory or personnel office employees will be given a thorough indoctrination by the EEO Officer, covering all major aspects of the contractor's EEO obligations within thirty days following their reporting for duty with the contractor.
 - c. All personnel who are engaged in direct recruitment for the project will be instructed by the EEO Officer in the contractor's procedures for locating and hiring minorities and women.
 - d. Notices and posters setting forth the contractor's EEO policy will be placed in areas readily accessible to employees, applicants for employment and potential employees.
 - e. The contractor's EEO policy and the procedures to implement such policy will be brought to the attention of employees by means of meetings, employee handbooks, or other appropriate means.
4. **Recruitment:** When advertising for employees, the contractor will include in all advertisements for employees the notation: "An Equal Opportunity Employer." All such advertisements will be placed in publications having a large circulation among minorities and women in the area from which the project work force would normally be derived.
 - a. The contractor will, unless precluded by a valid bargaining agreement, conduct systematic and direct recruitment through public and private employee referral sources likely to yield qualified minorities and women. To meet this requirement, the contractor will identify sources of potential minority group employees, and establish with such identified sources procedures whereby minority and women applicants may be referred to the contractor for employment consideration.
 - b. In the event the contractor has a valid bargaining agreement providing for exclusive hiring hall referrals, the contractor is expected to observe the provisions of that agreement to the extent that the system meets the contractor's compliance with EEO contract provisions. Where implementation of such an agreement has the effect of discriminating against minorities or women, or obligates the contractor to do the same, such implementation violates Federal nondiscrimination provisions.
 - c. The contractor will encourage its present employees to refer minorities and women as applicants for employment. Information and procedures with regard to referring such applicants will be discussed with employees.
5. **Personnel Actions:** Wages, working conditions, and employee benefits shall be established and administered, and personnel actions of every type, including hiring, upgrading, promotion, transfer, demotion, layoff, and termination, shall be taken without regard to race, color, religion, sex, national origin, age or disability. The following procedures shall be followed:
 - a. The contractor will conduct periodic inspections of project sites to insure that working conditions and employee facilities do not indicate discriminatory treatment of project site personnel.
 - b. The contractor will periodically evaluate the spread of wages paid within each classification to determine any evidence of discriminatory wage practices.
 - c. The contractor will periodically review selected personnel actions in depth to determine whether there is evidence of discrimination. Where evidence is found, the contractor will promptly take corrective action. If the review indicates that the discrimination may extend beyond the actions reviewed, such corrective action shall include all affected persons.
 - d. The contractor will promptly investigate all complaints of alleged discrimination made to the contractor in connection with its obligations under this contract, will attempt to resolve such complaints, and will take appropriate corrective action within a reasonable time. If the investigation indicates that the discrimination may affect persons other than the complainant, such corrective action shall include such other persons. Upon completion of each investigation, the contractor will inform every complainant of all of their avenues of appeal.
6. **Training and Promotion:**
 - a. The contractor will assist in locating, qualifying, and increasing the skills of minorities and women who are applicants for employment or current employees. Such efforts should be aimed at developing full journey level status employees in the type of trade or job classification involved.
 - b. Consistent with the contractor's work force requirements and as permissible under Federal and State regulations, the contractor shall make full use of training programs, i.e., apprenticeship, and on-the-job training programs for the geographical area of contract performance. In the event a special provision for training is provided under this contract, this subparagraph will be superseded as indicated in the special provision. The contracting agency may reserve training positions for persons who receive welfare assistance in accordance with 23 U.S.C. 140(a).
 - c. The contractor will advise employees and applicants for employment of available training programs and entrance requirements for each.
 - d. The contractor will periodically review the training and promotion potential of employees who are minorities and women and will encourage eligible employees to apply for such training and promotion.
7. **Unions:** If the contractor relies in whole or in part upon unions as a source of employees, the contractor will use good faith efforts to obtain the cooperation of such unions to increase opportunities for minorities and women. Actions by the contractor, either directly or through a contractor's association acting as agent, will include the procedures set forth below:
 - a. The contractor will use good faith efforts to develop, in cooperation with the unions, joint training programs aimed toward qualifying more minorities and women for membership in the unions and increasing the skills of minorities and women so that they may qualify for higher paying employment.
 - b. The contractor will use good faith efforts to incorporate an EEO clause into each union agreement to the end that such union will be contractually bound to refer applicants without regard to their race, color, religion, sex, national origin, age or disability.
 - c. The contractor is to obtain information as to the referral practices and policies of the labor union except that to the extent such information is within the exclusive possession of the labor union and such labor union refuses to furnish such information to the contractor, the contractor shall so certify to the contracting agency and shall set forth what efforts have been made to obtain such information.

- d. In the event the union is unable to provide the contractor with a reasonable flow of referrals within the time limit set forth in the collective bargaining agreement, the contractor will, through independent recruitment efforts, fill the employment vacancies without regard to race, color, religion, sex, national origin, age or disability; making full efforts to obtain qualified and/or qualifiable minorities and women. The failure of a union to provide sufficient referrals (even though it is obligated to provide exclusive referrals under the terms of a collective bargaining agreement) does not relieve the contractor from the requirements of this paragraph. In the event the union referral practice prevents the contractor from meeting the obligations pursuant to Executive Order 11246, as amended, and these special provisions, such contractor shall immediately notify the contracting agency.
8. **Reasonable Accommodation for Applicants / Employees with Disabilities:** The contractor must be familiar with the requirements for and comply with the Americans with Disabilities Act and all rules and regulations established there under. Employers must provide reasonable accommodation in all employment activities unless to do so would cause an undue hardship.
9. **Selection of Subcontractors, Procurement of Materials and Leasing of Equipment:** The contractor shall not discriminate on the grounds of race, color, religion, sex, national origin, age or disability in the selection and retention of subcontractors, including procurement of materials and leases of equipment. The contractor shall take all necessary and reasonable steps to ensure nondiscrimination in the administration of this contract.
- The contractor shall notify all potential subcontractors and suppliers and lessors of their EEO obligations under this contract.
 - The contractor will use good faith efforts to ensure subcontractor compliance with their EEO obligations.
10. **Assurance Required by 49 CFR 26.13(b):**
- The requirements of 49 CFR Part 26 and the State DOT's U.S. DOT-approved DBE program are incorporated by reference.
 - The contractor or subcontractor shall not discriminate on the basis of race, color, national origin, or sex in the performance of this contract. The contractor shall carry out applicable requirements of 49 CFR Part 26 in the award and administration of DOT-assisted contracts. Failure by the contractor to carry out these requirements is a material breach of this contract, which may result in the termination of this contract or such other remedy as the contracting agency deems appropriate.
11. **Records and Reports:** The contractor shall keep such records as necessary to document compliance with the EEO requirements. Such records shall be retained for a period of three years following the date of the final payment to the contractor for all contract work and shall be available at reasonable times and places for inspection by authorized representatives of the contracting agency and the FHWA.
- The records kept by the contractor shall document the following:
 - The number and work hours of minority and non-minority group members and women employed in each work classification on the project;
 - The progress and efforts being made in cooperation with unions, when applicable, to increase employment opportunities for minorities and women; and
 - The progress and efforts being made in locating, hiring, training, qualifying, and upgrading minorities and women;
 - The contractors and subcontractors will submit an annual report to the contracting agency each July for the duration of the project, indicating the number of minority, women, and non-minority group employees currently engaged in each work classification required by the contract work. This information is to be reported on Form FHWA-1391. The staffing data should represent the project work force on board in all or any part of the last payroll period preceding the end of July. If on-the-job training is being required by special provision, the contractor will be required to collect and report training data. The employment data should reflect the work force on board during all or any part of the last payroll period preceding the end of July.

III. NONSEGREGATED FACILITIES

This provision is applicable to all Federal-aid construction contracts and to all related construction subcontracts of \$10,000 or more.

The contractor must ensure that facilities provided for employees are provided in such a manner that segregation on the basis of race, color, religion, sex, or national origin cannot result. The contractor may neither require such segregated use by written or oral policies nor tolerate such use by employee custom. The contractor's obligation extends further to ensure that its employees are not assigned to perform their services at any location, under the contractor's control, where the facilities are segregated. The term "facilities" includes waiting rooms, work areas, restaurants and other eating areas, time clocks, restrooms, washrooms, locker rooms, and other storage or dressing areas, parking lots, drinking fountains, recreation or entertainment areas, transportation, and housing provided for employees. The contractor shall provide separate or single-user restrooms and necessary dressing or sleeping areas to assure privacy between sexes.

IV. DAVIS-BACON AND RELATED ACT PROVISIONS

This section is applicable to all Federal-aid construction projects exceeding \$2,000 and to all related subcontracts and lower-tier subcontracts (regardless of subcontract size). The requirements apply to all projects located within the right-of-way of a roadway that is functionally classified as Federal-aid highway. This excludes roadways functionally classified as local roads or rural minor collectors, which are exempt. Contracting agencies may elect to apply these requirements to other projects.

The following provisions are from the U.S. Department of Labor regulations in 29 CFR 5.5 "Contract provisions and related matters" with minor revisions to conform to the FHWA-1273 format and FHWA program requirements.

1. Minimum wages

- All laborers and mechanics employed or working upon the site of the work, will be paid unconditionally and not less often than once a week, and without subsequent deduction or rebate on any account (except such payroll deductions as are permitted by regulations issued by the Secretary of Labor under the Copeland Act (29 CFR part 3)), the full amount of wages and bona fide fringe benefits (or cash equivalents thereof) due at time of payment computed at rates not less than those contained in the wage determination of the Secretary of Labor which is attached hereto and made a part hereof, regardless of any contractual relationship which may be alleged to exist between the contractor and such laborers and mechanics.

Contributions made or costs reasonably anticipated for bona fide fringe benefits under section 1(b)(2) of the Davis-Bacon Act on behalf of laborers or mechanics are considered wages paid to such laborers or mechanics, subject to the provisions of paragraph 1.d. of this section; also, regular contributions made or costs incurred for more than a weekly period (but not less often than quarterly) under plans, funds, or programs which cover the particular weekly period, are deemed to be constructively made or incurred during such weekly period. Such laborers and mechanics shall be paid the appropriate wage rate and fringe benefits on the wage determination for the classification of work actually performed, without regard to skill, except as provided in 29 CFR 5.5(a)(4). Laborers or mechanics performing work in more than one classification may be compensated at the rate specified for each classification for the time actually worked therein: Provided, That the employer's payroll records accurately set forth the time spent in each classification in which work is performed. The wage determination (including any additional classification and wage rates conformed under paragraph 1.b. of this section) and the Davis-Bacon poster (WH-1321) shall be posted at all times by the contractor and its subcontractors at the site of the work in a prominent and accessible place where it can be easily seen by the workers.

- b. (1) The contracting officer shall require that any class of laborers or mechanics, including helpers, which is not listed in the wage determination and which is to be employed under the contract shall be classified in conformance with the wage determination. The contracting officer shall approve an additional classification and wage rate and fringe benefits therefore only when the following criteria have been met:
 - (i) The work to be performed by the classification requested is not performed by a classification in the wage determination; and
 - (ii) The classification is utilized in the area by the construction industry; and
 - (iii) The proposed wage rate, including any bona fide fringe benefits, bears a reasonable relationship to the wage rates contained in the wage determination.
 - (2) If the contractor and the laborers and mechanics to be employed in the classification (if known), or their representatives, and the contracting officer agree on the classification and wage rate (including the amount designated for fringe benefits where appropriate), a report of the action taken shall be sent by the contracting officer to the Administrator of the Wage and Hour Division, Employment Standards Administration, U.S. Department of Labor, Washington, DC 20210. The Administrator, or an authorized representative, will approve, modify, or disapprove every additional classification action within 30 days of receipt and so advise the contracting officer or will notify the contracting officer within the 30-day period that additional time is necessary.
 - (3) In the event the contractor, the laborers or mechanics to be employed in the classification or their representatives, and the contracting officer do not agree on the proposed classification and wage rate (including the amount designated for fringe benefits, where appropriate), the contracting officer shall refer the questions, including the views of all interested parties and the recommendation of the contracting officer, to the Wage and Hour Administrator for determination. The Wage and Hour Administrator, or an authorized representative, will issue a determination within 30 days of receipt and so advise the contracting officer or will notify the contracting officer within the 30-day period that additional time is necessary.
 - (4) The wage rate (including fringe benefits where appropriate) determined pursuant to paragraphs 1.b.(2) or 1.b.(3) of this section, shall be paid to all workers performing work in the classification under this contract from the first day on which work is performed in the classification.
- c. Whenever the minimum wage rate prescribed in the contract for a class of laborers or mechanics includes a fringe benefit which is not expressed as an hourly rate, the contractor shall either pay the benefit as stated in the wage determination or shall pay another bona fide fringe benefit or an hourly cash equivalent thereof.
 - d. If the contractor does not make payments to a trustee or other third person, the contractor may consider as part of the wages of any laborer or mechanic the amount of any costs reasonably anticipated in providing bona fide fringe benefits under a plan or program. Provided, That the Secretary of Labor has found, upon the written request of the contractor, that the applicable standards of the Davis-Bacon Act have been met. The Secretary of Labor may require the contractor to set aside in a separate account assets for the meeting of obligations under the plan or program.
2. **Withholding.** The contracting agency shall upon its own action or upon written request of an authorized representative of the Department of Labor, withhold or cause to be withheld from the contractor under this contract, or any other Federal contract with the same prime contractor, or any other federally-assisted contract subject to Davis-Bacon prevailing wage requirements, which is held by the same prime contractor, so much of the accrued payments or advances as may be considered necessary to pay laborers and mechanics, including apprentices, trainees, and helpers, employed by the contractor or any subcontractor the full amount of wages required by the contract. In the event of failure to pay any laborer or mechanic, including any apprentice, trainee, or helper, employed or working on the site of the work, all or part of the wages required by the contract, the contracting agency may, after written notice to the contractor, take such action as may be necessary to cause the suspension of any further payment, advance, or guarantee of funds until such violations have ceased.
 3. **Payrolls and basic records**
 - a. Payrolls and basic records relating thereto shall be maintained by the contractor during the course of the work and preserved for a period of three years thereafter for all laborers and mechanics working at the site of the work. Such records shall contain the name, address, and social security number of each such worker, his or her correct classification, hourly rates of wages paid (including rates of contributions or costs anticipated for bona fide fringe benefits or cash equivalents thereof of the types described in section 1(b)(2)(B) of the Davis-Bacon Act), daily and weekly number of hours worked, deductions made and actual wages paid. Whenever the Secretary of Labor has found under 29 CFR 5.5(a)(1)(iv) that the wages of any laborer or mechanic include the amount of any costs reasonably anticipated in providing benefits under a plan or program described in section 1(b)(2)(B) of the Davis-Bacon Act, the contractor shall maintain records which show that the commitment to provide such benefits is enforceable, that the plan or program is financially responsible, and that the plan or program has been communicated in writing to the laborers or mechanics affected, and records which show the costs anticipated or the actual cost incurred in providing such benefits. Contractors employing apprentices or trainees under approved programs shall maintain written evidence of the registration of apprenticeship programs and certification of trainee programs, the registration of the apprentices and trainees, and the ratios and wage rates prescribed in the applicable programs.
 - b. (1) The contractor shall submit weekly for each week in which any contract work is performed a copy of all payrolls to the contracting agency. The payrolls submitted shall set out accurately and completely all of the information required to be maintained under 29 CFR 5.5(a)(3)(i), except that full social security numbers and home addresses shall not be included on weekly transmittals. Instead the payrolls shall only need to include an individually identifying number for each employee (e.g. , the last four digits of the employee's social security number). The required weekly payroll information may be submitted in any form desired. Optional Form WH-347 is available for this purpose from the Wage and Hour Division Web site at <http://www.dol.gov/esa/whd/forms/wh347instr.htm> or its successor site. The prime contractor is responsible for the submission of copies of payrolls by all subcontractors. Contractors and subcontractors shall maintain the full social security number and current address of each covered worker, and shall provide them upon request to the contracting agency for transmission to the State DOT, the FHWA or the Wage and Hour Division of the Department of Labor for purposes of an investigation or audit of compliance with prevailing wage requirements. It is not a violation of this section for a prime contractor to require a subcontractor to provide addresses and social security numbers to the prime contractor for its own records, without weekly submission to the contracting agency.
 - (2) Each payroll submitted shall be accompanied by a "Statement of Compliance," signed by the contractor or subcontractor or his or her agent who pays or supervises the payment of the persons employed under the contract and shall certify the following:
 - (i) That the payroll for the payroll period contains the information required to be provided under §5.5 (a)(3)(ii) of Regulations, 29 CFR part 5, the appropriate information is being maintained under §5.5 (a)(3)(i) of Regulations, 29 CFR part 5, and that such information is correct and complete;
 - (ii) That each laborer or mechanic (including each helper, apprentice, and trainee) employed on the contract during the payroll period has been paid the full weekly wages earned, without rebate, either directly or indirectly, and that no deductions have been made either directly or indirectly from the full wages earned, other than permissible deductions as set forth in Regulations, 29 CFR part 3;
 - (iii) That each laborer or mechanic has been paid not less than the applicable wage rates and fringe benefits or cash equivalents for the classification of work performed, as specified in the applicable wage determination incorporated into the contract.

- (3) The weekly submission of a properly executed certification set forth on the reverse side of Optional Form WH-347 shall satisfy the requirement for submission of the "Statement of Compliance" required by paragraph 3.b.(2) of this section.
- (4) The falsification of any of the above certifications may subject the contractor or subcontractor to civil or criminal prosecution under section 1001 of title 18 and section 231 of title 31 of the United States Code.
- c. The contractor or subcontractor shall make the records required under paragraph 3.a. of this section available for inspection, copying, or transcription by authorized representatives of the contracting agency, the State DOT, the FHWA, or the Department of Labor, and shall permit such representatives to interview employees during working hours on the job. If the contractor or subcontractor fails to submit the required records or to make them available, the FHWA may, after written notice to the contractor, the contracting agency or the State DOT, take such action as may be necessary to cause the suspension of any further payment, advance, or guarantee of funds. Furthermore, failure to submit the required records upon request or to make such records available may be grounds for debarment action pursuant to 29 CFR 5.12.
4. **Apprentices and trainees**
- a. Apprentices (programs of the USDOL). Apprentices will be permitted to work at less than the predetermined rate for the work they performed when they are employed pursuant to and individually registered in a bona fide apprenticeship program registered with the U.S. Department of Labor, Employment and Training Administration, Office of Apprenticeship Training, Employer and Labor Services, or with a State Apprenticeship Agency recognized by the Office, or if a person is employed in his or her first 90 days of probationary employment as an apprentice in such an apprenticeship program, who is not individually registered in the program, but who has been certified by the Office of Apprenticeship Training, Employer and Labor Services or a State Apprenticeship Agency (where appropriate) to be eligible for probationary employment as an apprentice.
- The allowable ratio of apprentices to journeymen on the job site in any craft classification shall not be greater than the ratio permitted to the contractor as to the entire work force under the registered program. Any worker listed on a payroll at an apprentice wage rate, who is not registered or otherwise employed as stated above, shall be paid not less than the applicable wage rate on the wage determination for the classification of work actually performed. In addition, any apprentice performing work on the job site in excess of the ratio permitted under the registered program shall be paid not less than the applicable wage rate on the wage determination for the work actually performed. Where a contractor is performing construction on a project in a locality other than that in which its program is registered, the ratios and wage rates (expressed in percentages of the journeyman's hourly rate) specified in the contractor's or subcontractor's registered program shall be observed.
- Every apprentice must be paid at not less than the rate specified in the registered program for the apprentice's level of progress, expressed as a percentage of the journeymen hourly rate specified in the applicable wage determination. Apprentices shall be paid fringe benefits in accordance with the provisions of the apprenticeship program. If the apprenticeship program does not specify fringe benefits, apprentices must be paid the full amount of fringe benefits listed on the wage determination for the applicable classification. If the Administrator determines that a different practice prevails for the applicable apprentice classification, fringes shall be paid in accordance with that determination.
- In the event the Office of Apprenticeship Training, Employer and Labor Services, or a State Apprenticeship Agency recognized by the Office, withdraws approval of an apprenticeship program, the contractor will no longer be permitted to utilize apprentices at less than the applicable predetermined rate for the work performed until an acceptable program is approved.
- b. Trainees (programs of the USDOL). Except as provided in 29 CFR 5.16, trainees will not be permitted to work at less than the predetermined rate for the work performed unless they are employed pursuant to and individually registered in a program which has received prior approval, evidenced by formal certification by the U.S. Department of Labor, Employment and Training Administration.
- The ratio of trainees to journeymen on the job site shall not be greater than permitted under the plan approved by the Employment and Training Administration.
- Every trainee must be paid at not less than the rate specified in the approved program for the trainee's level of progress, expressed as a percentage of the journeyman hourly rate specified in the applicable wage determination. Trainees shall be paid fringe benefits in accordance with the provisions of the trainee program. If the trainee program does not mention fringe benefits, trainees shall be paid the full amount of fringe benefits listed on the wage determination unless the Administrator of the Wage and Hour Division determines that there is an apprenticeship program associated with the corresponding journeyman wage rate on the wage determination which provides for less than full fringe benefits for apprentices. Any employee listed on the payroll at a trainee rate who is not registered and participating in a training plan approved by the Employment and Training Administration shall be paid not less than the applicable wage rate on the wage determination for the classification of work actually performed. In addition, any trainee performing work on the job site in excess of the ratio permitted under the registered program shall be paid not less than the applicable wage rate on the wage determination for the work actually performed.
- In the event the Employment and Training Administration withdraws approval of a training program, the contractor will no longer be permitted to utilize trainees at less than the applicable predetermined rate for the work performed until an acceptable program is approved.
- c. Equal employment opportunity. The utilization of apprentices, trainees and journeymen under this part shall be in conformity with the equal employment opportunity requirements of Executive Order 11246, as amended, and 29 CFR part 30.
- d. Apprentices and Trainees (programs of the U.S. DOT). Apprentices and trainees working under apprenticeship and skill training programs which have been certified by the Secretary of Transportation as promoting EEO in connection with Federal-aid highway construction programs are not subject to the requirements of paragraph 4 of this Section IV. The straight time hourly wage rates for apprentices and trainees under such programs will be established by the particular programs. The ratio of apprentices and trainees to journeymen shall not be greater than permitted by the terms of the particular program.
5. **Compliance with Copeland Act requirements.** The contractor shall comply with the requirements of 29 CFR part 3, which are incorporated by reference in this contract.
6. **Subcontracts.** The contractor or subcontractor shall insert Form FHWA-1273 in any subcontracts and also require the subcontractors to include Form FHWA-1273 in any lower tier subcontracts. The prime contractor shall be responsible for the compliance by any subcontractor or lower tier subcontractor with all the contract clauses in 29 CFR 5.5.
7. **Contract termination:** debarment. A breach of the contract clauses in 29 CFR 5.5 may be grounds for termination of the contract, and for debarment as a contractor and a subcontractor as provided in 29 CFR 5.12.
8. **Compliance with Davis-Bacon and Related Act requirements.** All rulings and interpretations of the Davis-Bacon and Related Acts contained in 29 CFR parts 1, 3, and 5 are herein incorporated by reference in this contract.
9. **Disputes concerning labor standards.** Disputes arising out of the labor standards provisions of this contract shall not be subject to the general disputes clause of this contract. Such disputes shall be resolved in accordance with the procedures of the Department of Labor set forth in 29 CFR parts 5, 6, and 7. Disputes within the meaning of this clause include disputes between the contractor (or any of its subcontractors) and the contracting agency, the U.S. Department of Labor, or the employees or their representatives.
10. **Certification of eligibility.**
- a. By entering into this contract, the contractor certifies that neither it (nor he or she) nor any person or firm who has an interest in the contractor's firm is a person or firm ineligible to be awarded Government contracts by virtue of section 3(a) of the Davis-Bacon Act or 29 CFR 5.12(a)(1).

- b. No part of this contract shall be subcontracted to any person or firm ineligible for award of a Government contract by virtue of section 3(a) of the Davis-Bacon Act or 29 CFR 5.12(a)(1).
- c. The penalty for making false statements is prescribed in the U.S. Criminal Code, 18 U.S.C. 1001.

V. CONTRACT WORK HOURS AND SAFETY STANDARDS ACT

The following clauses apply to any Federal-aid construction contract in an amount in excess of \$100,000 and subject to the overtime provisions of the Contract Work Hours and Safety Standards Act. These clauses shall be inserted in addition to the clauses required by 29 CFR 5.5(a) or 29 CFR 4.6. As used in this paragraph, the terms laborers and mechanics include watchmen and guards.

1. **Overtime requirements.** No contractor or subcontractor contracting for any part of the contract work which may require or involve the employment of laborers or mechanics shall require or permit any such laborer or mechanic in any workweek in which he or she is employed on such work to work in excess of forty hours in such workweek unless such laborer or mechanic receives compensation at a rate not less than one and one-half times the basic rate of pay for all hours worked in excess of forty hours in such workweek.
2. **Violation; liability for unpaid wages; liquidated damages.** In the event of any violation of the clause set forth in paragraph (1.) of this section, the contractor and any subcontractor responsible therefor shall be liable for the unpaid wages. In addition, such contractor and subcontractor shall be liable to the United States (in the case of work done under contract for the District of Columbia or a territory, to such District or to such territory), for liquidated damages. Such liquidated damages shall be computed with respect to each individual laborer or mechanic, including watchmen and guards, employed in violation of the clause set forth in paragraph (1.) of this section, in the sum of \$10 for each calendar day on which such individual was required or permitted to work in excess of the standard workweek of forty hours without payment of the overtime wages required by the clause set forth in paragraph (1.) of this section.
3. **Withholding for unpaid wages and liquidated damages.** The FHWA or the contacting agency shall upon its own action or upon written request of an authorized representative of the Department of Labor withhold or cause to be withheld, from any moneys payable on account of work performed by the contractor or subcontractor under any such contract or any other Federal contract with the same prime contractor, or any other federally-assisted contract subject to the Contract Work Hours and Safety Standards Act, which is held by the same prime contractor, such sums as may be determined to be necessary to satisfy any liabilities of such contractor or subcontractor for unpaid wages and liquidated damages as provided in the clause set forth in paragraph (2.) of this section.
4. **Subcontracts.** The contractor or subcontractor shall insert in any subcontracts the clauses set forth in paragraph (1.) through (4.) of this section and also a clause requiring the subcontractors to include these clauses in any lower tier subcontracts. The prime contractor shall be responsible for compliance by any subcontractor or lower tier subcontractor with the clauses set forth in paragraphs (1.) through (4.) of this section.

VI. SUBLETTING OR ASSIGNING THE CONTRACT

This provision is applicable to all Federal-aid construction contracts on the National Highway System.

1. The contractor shall perform with its own organization contract work amounting to not less than 30 percent (or a greater percentage if specified elsewhere in the contract) of the total original contract price, excluding any specialty items designated by the contracting agency. Specialty items may be performed by subcontract and the amount of any such specialty items performed may be deducted from the total original contract price before computing the amount of work required to be performed by the contractor's own organization (23 CFR 635.116).
 - a. The term "perform work with its own organization" refers to workers employed or leased by the prime contractor, and equipment owned or rented by the prime contractor, with or without operators. Such term does not include employees or equipment of a subcontractor or lower tier subcontractor, agents of the prime contractor, or any other assignees. The term may include payments for the costs of hiring leased employees

from an employee leasing firm meeting all relevant Federal and State regulatory requirements. Leased employees may only be included in this term if the prime contractor meets all of the following conditions:

- (1) the prime contractor maintains control over the supervision of the day-to-day activities of the leased employees;
 - (2) the prime contractor remains responsible for the quality of the work of the leased employees;
 - (3) the prime contractor retains all power to accept or exclude individual employees from work on the project; and
 - (4) the prime contractor remains ultimately responsible for the payment of predetermined minimum wages, the submission of payrolls, statements of compliance and all other Federal regulatory requirements.
- b. "Specialty Items" shall be construed to be limited to work that requires highly specialized knowledge, abilities, or equipment not ordinarily available in the type of contracting organizations qualified and expected to bid or propose on the contract as a whole and in general are to be limited to minor components of the overall contract.
2. The contract amount upon which the requirements set forth in paragraph (1) of Section VI is computed includes the cost of material and manufactured products which are to be purchased or produced by the contractor under the contract provisions.
 3. The contractor shall furnish (a) a competent superintendent or supervisor who is employed by the firm, has full authority to direct performance of the work in accordance with the contract requirements, and is in charge of all construction operations (regardless of who performs the work) and (b) such other of its own organizational resources (supervision, management, and engineering services) as the contracting officer determines is necessary to assure the performance of the contract.
 4. No portion of the contract shall be sublet, assigned or otherwise disposed of except with the written consent of the contracting officer, or authorized representative, and such consent when given shall not be construed to relieve the contractor of any responsibility for the fulfillment of the contract. Written consent will be given only after the contracting officer has assured that each subcontract is evidenced in writing and that it contains all pertinent provisions and requirements of the prime contract.
 5. The 30% self-performance requirement of paragraph (1) is not applicable to design-build contracts; however, contracting agencies may establish their own self-performance requirements.

VII. SAFETY: ACCIDENT PREVENTION

This provision is applicable to all Federal-aid construction contracts and to all related subcontracts.

1. In the performance of this contract the contractor shall comply with all applicable Federal, State, and local laws governing safety, health, and sanitation (23 CFR 635). The contractor shall provide all safeguards, safety devices and protective equipment and take any other needed actions as it determines, or as the contracting officer may determine, to be reasonably necessary to protect the life and health of employees on the job and the safety of the public and to protect property in connection with the performance of the work covered by the contract.
2. It is a condition of this contract, and shall be made a condition of each subcontract, which the contractor enters into pursuant to this contract, that the contractor and any subcontractor shall not permit any employee, in performance of the contract, to work in surroundings or under conditions which are unsanitary, hazardous or dangerous to his/her health or safety, as determined under construction safety and health standards (29 CFR 1926) promulgated by the Secretary of Labor, in accordance with Section 107 of the Contract Work Hours and Safety Standards Act (40 U.S.C. 3704).
3. Pursuant to 29 CFR 1926.3, it is a condition of this contract that the Secretary of Labor or authorized representative thereof, shall have right of entry to any site of contract performance to inspect or investigate the matter of compliance with the construction safety and health standards and to carry out the duties of the Secretary under Section 107 of the Contract Work Hours and Safety Standards Act (40 U.S.C.3704).

VIII. FALSE STATEMENTS CONCERNING HIGHWAY PROJECTS

This provision is applicable to all Federal-aid construction contracts and to all related subcontracts.

In order to assure high quality and durable construction in conformity with approved plans and specifications and a high degree of reliability on statements and representations made by engineers, contractors, suppliers, and workers on Federal-aid highway projects, it is essential that all persons concerned with the project perform their functions as carefully, thoroughly, and honestly as possible. Willful falsification, distortion, or misrepresentation with respect to any facts related to the project is a violation of Federal law. To prevent any misunderstanding regarding the seriousness of these and similar acts, Form FHWA-1022 shall be posted on each Federal-aid highway project (23 CFR 635) in one or more places where it is readily available to all persons concerned with the project:

18 U.S.C. 1020 reads as follows:

"Whoever, being an officer, agent, or employee of the United States, or of any State or Territory, or whoever, whether a person, association, firm, or corporation, knowingly makes any false statement, false representation, or false report as to the character, quality, quantity, or cost of the material used or to be used, or the quantity or quality of the work performed or to be performed, or the cost thereof in connection with the submission of plans, maps, specifications, contracts, or costs of construction on any highway or related project submitted for approval to the Secretary of Transportation; or Whoever knowingly makes any false statement, false representation, false report or false claim with respect to the character, quality, quantity, or cost of any work performed or to be performed, or materials furnished or to be furnished, in connection with the construction of any highway or related project approved by the Secretary of Transportation; or

Whoever knowingly makes any false statement or false representation as to material fact in any statement, certificate, or report submitted pursuant to provisions of the Federal-aid Roads Act approved July 1, 1916, (39 Stat. 355), as amended and supplemented;

Shall be fined under this title or imprisoned not more than 5 years or both."

IX. IMPLEMENTATION OF CLEAN AIR ACT AND FEDERAL WATER POLLUTION CONTROL ACT

This provision is applicable to all Federal-aid construction contracts and to all related subcontracts.

By submission of this bid/proposal or the execution of this contract, or subcontract, as appropriate, the bidder, proposer, Federal-aid construction contractor, or subcontractor, as appropriate, will be deemed to have stipulated as follows:

1. That any person who is or will be utilized in the performance of this contract is not prohibited from receiving an award due to a violation of Section 508 of the Clean Water Act or Section 306 of the Clean Air Act.
2. That the contractor agrees to include or cause to be included the requirements of paragraph (1) of this Section X in every subcontract, and further agrees to take such action as the contracting agency may direct as a means of enforcing such requirements.

X. CERTIFICATION REGARDING DEBARMENT, SUSPENSION, INELIGIBILITY AND VOLUNTARY EXCLUSION

This provision is applicable to all Federal-aid construction contracts, design-build contracts, subcontracts, lower-tier subcontracts, purchase orders, lease agreements, consultant contracts or any other covered transaction requiring FHWA approval or that is estimated to cost \$25,000 or more – as defined in 2 CFR Parts 180 and 1200.

1. Instructions for Certification – First Tier Participants:

- a. By signing and submitting this proposal, the prospective first tier participant is providing the certification set out below.
- b. The inability of a person to provide the certification set out below will not necessarily result in denial of participation in this covered transaction. The prospective first tier participant shall submit an explanation of why it cannot provide the certification set out below. The certification or explanation will be considered in connection with the department or agency's determination whether to enter into this transaction. However, failure of the prospective first tier participant to furnish a certification or an explanation shall disqualify such a person from participation in this transaction.
- c. The certification in this clause is a material representation of fact upon which reliance was placed when the contracting agency determined to enter into this transaction. If it is later determined that the prospective participant knowingly rendered an erroneous certification, in addition to other remedies available to the Federal Government, the contracting agency may terminate this transaction for cause of default.
- d. The prospective first tier participant shall provide immediate written notice to the contracting agency to whom this proposal is submitted if any time the prospective first tier participant learns that its certification was erroneous when submitted or has become erroneous by reason of changed circumstances.
- e. The terms "covered transaction," "debarred," "suspended," "ineligible," "participant," "person," "principal," and "voluntarily excluded," as used in this clause, are defined in 2 CFR Parts 180 and 1200. "First Tier Covered Transactions" refers to any covered transaction between a grantee or subgrantee of Federal funds and a participant (such as the prime or general contract). "Lower Tier Covered Transactions" refers to any covered transaction under a First Tier Covered Transaction (such as subcontracts). "First Tier Participant" refers to the participant who has entered into a covered transaction with a grantee or subgrantee of Federal funds (such as the prime or general contractor). "Lower Tier Participant" refers any participant who has entered into a covered transaction with a First Tier Participant or other Lower Tier Participants (such as subcontractors and suppliers).
- f. The prospective first tier participant agrees by submitting this proposal that, should the proposed covered transaction be entered into, it shall not knowingly enter into any lower tier covered transaction with a person who is debarred, suspended, declared ineligible, or voluntarily excluded from participation in this covered transaction, unless authorized by the department or agency entering into this transaction.
- g. The prospective first tier participant further agrees by submitting this proposal that it will include the clause titled "Certification Regarding Debarment, Suspension, Ineligibility and Voluntary Exclusion-Lower Tier Covered Transactions," provided by the department or contracting agency, entering into this covered transaction, without modification, in all lower tier covered transactions and in all solicitations for lower tier covered transactions exceeding the \$25,000 threshold.
- h. A participant in a covered transaction may rely upon a certification of a prospective participant in a lower tier covered transaction that is not debarred, suspended, ineligible, or voluntarily excluded from the covered transaction, unless it knows that the certification is erroneous. A participant is responsible for ensuring that its principals are not suspended, debarred, or otherwise ineligible to participate in covered transactions. To verify the eligibility of its principals, as well as the eligibility of any lower tier prospective participants, each participant may, but is not required to, check the Excluded Parties List System website (<https://www.epls.gov/>), which is compiled by the General Services Administration.
- i. Nothing contained in the foregoing shall be construed to require the establishment of a system of records in order to render in good faith the certification required by this clause. The knowledge and information of the prospective participant is not required to exceed that which is normally possessed by a prudent person in the ordinary course of business dealings.
- j. Except for transactions authorized under paragraph (f) of these instructions, if a participant in a covered transaction knowingly enters into a lower tier covered transaction with a person who is suspended, debarred, ineligible, or voluntarily excluded from participation in this transaction, in addition to other remedies available to the Federal Government, the department or agency may terminate this transaction for cause or default.

* * * * *

2. Certification Regarding Debarment, Suspension, Ineligibility and Voluntary Exclusion – First Tier Participants:

- a. The prospective first tier participant certifies to the best of its knowledge and belief, that it and its principals:
 - (1) Are not presently debarred, suspended, proposed for debarment, declared ineligible, or voluntarily excluded from participating in covered transactions by any Federal department or agency;
 - (2) Have not within a three-year period preceding this proposal been convicted of or had a civil judgment rendered against them for commission of fraud or a criminal offense in connection with obtaining, attempting to obtain, or performing a public (Federal, State or local) transaction or contract under a public transaction; violation of Federal or State antitrust statutes or commission of embezzlement, theft, forgery, bribery, falsification or destruction of records, making false statements, or receiving stolen property;
 - (3) Are not presently indicted for or otherwise criminally or civilly charged by a governmental entity (Federal, State or local) with commission of any of the offenses enumerated in paragraph (a)(2) of this certification; and
 - (4) Have not within a three-year period preceding this application/proposal had one or more public transactions (Federal, State or local) terminated for cause or default.
- b. Where the prospective participant is unable to certify to any of the statements in this certification, such prospective participant shall attach an explanation to this proposal.

2. Instructions for Certification - Lower Tier Participants:

(Applicable to all subcontracts, purchase orders and other lower tier transactions requiring prior FHWA approval or estimated to cost \$25,000 or more - 2 CFR Parts 180 and 1200)

- a. By signing and submitting this proposal, the prospective lower tier is providing the certification set out below.
- b. The certification in this clause is a material representation of fact upon which reliance was placed when this transaction was entered into. If it is later determined that the prospective lower tier participant knowingly rendered an erroneous certification, in addition to other remedies available to the Federal Government, the department, or agency with which this transaction originated may pursue available remedies, including suspension and/or debarment.
- c. The prospective lower tier participant shall provide immediate written notice to the person to which this proposal is submitted if at any time the prospective lower tier participant learns that its certification was erroneous by reason of changed circumstances.
- d. The terms "covered transaction," "debarred," "suspended," "ineligible," "participant," "person," "principal," and "voluntarily excluded," as used in this clause, are defined in 2 CFR Parts 180 and 1200. You may contact the person to which this proposal is submitted for assistance in obtaining a copy of those regulations. "First Tier Covered Transactions" refers to any covered transaction between a grantee or subgrantee of

Federal funds and a participant (such as the prime or general contract). "Lower Tier Covered Transactions" refers to any covered transaction under a First Tier Covered Transaction (such as subcontracts). "First Tier Participant" refers to the participant who has entered into a covered transaction with a grantee or subgrantee of Federal funds (such as the prime or general contractor). "Lower Tier Participant" refers to any participant who has entered into a covered transaction with a First Tier Participant or other Lower Tier Participants (such as subcontractors and suppliers).

- e. The prospective lower tier participant agrees by submitting this proposal that, should the proposed covered transaction be entered into, it shall not knowingly enter into any lower tier covered transaction with a person who is debarred, suspended, declared ineligible, or voluntarily excluded from participation in this covered transaction, unless authorized by the department or agency with which this transaction originated.
- f. The prospective lower tier participant further agrees by submitting this proposal that it will include this clause titled "Certification Regarding Debarment, Suspension, Ineligibility and Voluntary Exclusion--Lower Tier Covered Transaction," without modification, in all lower tier covered transactions and in all solicitations for lower tier covered transactions exceeding the \$25,000 threshold.
- g. A participant in a covered transaction may rely upon a certification of a prospective participant in a lower tier covered transaction that is not debarred, suspended, ineligible, or voluntarily excluded from the covered transaction, unless it knows that the certification is erroneous. A participant is responsible for ensuring that its principals are not suspended, debarred, or otherwise ineligible to participate in covered transactions. To verify the eligibility of its principals, as well as the eligibility of any lower tier prospective participants, each participant may, but is not required to, check the Excluded Parties List System website (<https://www.epls.gov/>), which is compiled by the General Services Administration.
- h. Nothing contained in the foregoing shall be construed to require establishment of a system of records in order to render in good faith the certification required by this clause. The knowledge and information of participant is not required to exceed that which is normally possessed by a prudent person in the ordinary course of business dealings.
- i. Except for transactions authorized under paragraph e of these instructions, if a participant in a covered transaction knowingly enters into a lower tier covered transaction with a person who is suspended, debarred, ineligible, or voluntarily excluded from participation in this transaction, in addition to other remedies available to the Federal Government, the department or agency with which this transaction originated may pursue available remedies, including suspension and/or debarment.

* * * * *

Certification Regarding Debarment, Suspension, Ineligibility and Voluntary Exclusion--Lower Tier Participants:

1. The prospective lower tier participant certifies, by submission of this proposal, that neither it nor its principals is presently debarred, suspended, proposed for debarment, declared ineligible, or voluntarily excluded from participating in covered transactions by any Federal department or agency.
2. Where the prospective lower tier participant is unable to certify to any of the statements in this certification, such prospective participant shall attach an explanation to this proposal.

* * * * *

XI. CERTIFICATION REGARDING USE OF CONTRACT FUNDS FOR LOBBYING

This provision is applicable to all Federal-aid construction contracts and to all related subcontracts which exceed \$100,000 (49 CFR 20).

1. The prospective participant certifies, by signing and submitting this bid or proposal, to the best of his or her knowledge and belief, that:
 - a. No Federal appropriated funds have been paid or will be paid, by or on behalf of the undersigned, to any person for influencing or attempting to influence an officer or employee of any Federal agency, a Member of Congress, an officer or employee of Congress, or an employee of a Member of Congress in connection with the awarding of any Federal contract, the making of any Federal grant, the making of any Federal loan, the entering into of any cooperative agreement, and the extension, continuation, renewal, amendment, or modification of any Federal contract, grant, loan, or cooperative agreement.
 - b. If any funds other than Federal appropriated funds have been paid or will be paid to any person for influencing or attempting to influence an officer or employee of any Federal agency, a Member of Congress, an officer or employee of Congress, or an employee of a Member of Congress in connection with this Federal contract, grant, loan, or cooperative agreement, the undersigned shall complete and submit Standard Form-LLL, "Disclosure Form to Report Lobbying," in accordance with its instructions.
2. This certification is a material representation of fact upon which reliance was placed when this transaction was made or entered into. Submission of this certification is a prerequisite for making or entering into this transaction imposed by 31 U.S.C. 1352. Any person who fails to file the required certification shall be subject to a civil penalty of not less than \$10,000 and not more than \$100,000 for each such failure.
3. The prospective participant also agrees by submitting its bid or proposal that the participant shall require that the language of this certification be included in all lower tier subcontracts, which exceed \$100,000 and that all such recipients shall certify and disclose accordingly.

STANDARD SPECIAL PROVISION**ON-THE-JOB TRAINING**

(10-16-07) (Rev. 4-21-15)

Z-10

Description

The North Carolina Department of Transportation will administer a custom version of the Federal On-the-Job Training (OJT) Program, commonly referred to as the Alternate OJT Program. All contractors (existing and newcomers) will be automatically placed in the Alternate Program. Standard OJT requirements typically associated with individual projects will no longer be applied at the project level. Instead, these requirements will be applicable on an annual basis for each contractor administered by the OJT Program Manager.

On the Job Training shall meet the requirements of 23 CFR 230.107 (b), 23 USC – Section 140, this provision and the On-the-Job Training Program Manual.

The Alternate OJT Program will allow a contractor to train employees on Federal, State and privately funded projects located in North Carolina. However, priority shall be given to training employees on NCDOT Federal-Aid funded projects.

Minorities and Women

Developing, training and upgrading of minorities and women toward journeyman level status is a primary objective of this special training provision. Accordingly, the Contractor shall make every effort to enroll minority and women as trainees to the extent that such persons are available within a reasonable area of recruitment. This training commitment is not intended, and shall not be used, to discriminate against any applicant for training, whether a member of a minority group or not.

Assigning Training Goals

The Department, through the OJT Program Manager, will assign training goals for a calendar year based on the contractors' past three years' activity and the contractors' anticipated upcoming year's activity with the Department. At the beginning of each year, all contractors eligible will be contacted by the Department to determine the number of trainees that will be assigned for the upcoming calendar year. At that time the Contractor shall enter into an agreement with the Department to provide a self-imposed on-the-job training program for the calendar year. This agreement will include a specific number of annual training goals agreed to by both parties. The number of training assignments may range from 1 to 15 per contractor per calendar year. The Contractor shall sign an agreement to fulfill their annual goal for the year.\

Training Classifications

The Contractor shall provide on-the-job training aimed at developing full journeyman level workers in the construction craft/operator positions. Preference shall be given to providing training in the following skilled work classifications:

Equipment Operators	Office Engineers
Truck Drivers	Estimators
Carpenters	Iron / Reinforcing Steel Workers
Concrete Finishers	Mechanics
Pipe Layers	Welders

The Department has established common training classifications and their respective training requirements that may be used by the contractors. However, the classifications established are not all-inclusive. Where the training is oriented toward construction applications, training will be allowed in lower-level management positions such as office engineers and estimators. Contractors shall submit new classifications for specific job functions that their employees are performing. The Department will review and recommend for acceptance to FHWA the new classifications proposed by contractors, if applicable. New classifications shall meet the following requirements:

Proposed training classifications are reasonable and realistic based on the job skill classification needs, and

The number of training hours specified in the training classification is consistent with common practices and provides enough time for the trainee to obtain journeyman level status.

The Contractor may allow trainees to be trained by a subcontractor provided that the Contractor retains primary responsibility for meeting the training and this provision is made applicable to the subcontract. However, only the Contractor will receive credit towards the annual goal for the trainee.

Where feasible, 25 percent of apprentices or trainees in each occupation shall be in their first year of apprenticeship or training. The number of trainees shall be distributed among the work classifications on the basis of the contractor's needs and the availability of journeymen in the various classifications within a reasonable area of recruitment.

No employee shall be employed as a trainee in any classification in which they have successfully completed a training course leading to journeyman level status or in which they have been employed as a journeyman.

Records and Reports

The Contractor shall maintain enrollment, monthly and completion reports documenting company compliance under these contract documents. These documents and any other information as requested shall be submitted to the OJT Program Manager.

Upon completion and graduation of the program, the Contractor shall provide each trainee with a certification Certificate showing the type and length of training satisfactorily completed.

Trainee Interviews

All trainees enrolled in the program will receive an initial and Trainee/Post graduate interview conducted by the OJT program staff.

Trainee Wages

Contractors shall compensate trainees on a graduating pay scale based upon a percentage of the prevailing minimum journeyman wages (Davis-Bacon Act). Minimum pay shall be as follows:

60 percent	of the journeyman wage for the first half of the training period
75 percent	of the journeyman wage for the third quarter of the training period
90 percent	of the journeyman wage for the last quarter of the training period

In no instance shall a trainee be paid less than the local minimum wage. The Contractor shall adhere to the minimum hourly wage rate that will satisfy both the NC Department of Labor (NCDOL) and the Department.

Achieving or Failing to Meet Training Goals

The Contractor will be credited for each trainee employed by him on the contract work who is currently enrolled or becomes enrolled in an approved program and who receives training for at least 50 percent of the specific program requirement. Trainees will be allowed to be transferred between projects if required by the Contractor's scheduled workload to meet training goals.

If a contractor fails to attain their training assignments for the calendar year, they may be taken off the NCDOT's Bidders List.

Measurement and Payment

No compensation will be made for providing required training in accordance with these contract documents.

STANDARD SPECIAL PROVISION
MINIMUM WAGES
GENERAL DECISION NC180101 01/05/2018 NC101

Z-101

Date: January 5, 2018

General Decision Number: NC180101 01/05/2018 NC101

Superseded General Decision Numbers: NC20170101

State: North Carolina

Construction Type: HIGHWAY

COUNTIES:

Alamance	Forsyth	Randolph
Anson	Gaston	Rockingham
Cabarrus	Guilford	Stokes
Chatham	Mecklenburg	Union
Davie	Orange	Yadkin
Durham	Person	

HIGHWAY CONSTRUCTION PROJECTS (excluding tunnels, building structures in rest area projects & railroad construction; bascule, suspension & spandrel arch bridges designed for commercial navigation, bridges involving marine construction; and other major bridges).

Note: Under Executive Order (EO) 13658, an hourly minimum wage of \$10.35 for calendar year 2018 applies to all contracts subject to the Davis-Bacon Act for which the contract is awarded (and any solicitation was issued) on or after January 1, 2015. If this contract is covered by the EO, the contractor must pay all workers in any classification listed on this wage determination at least \$10.35 per hour (or the applicable wage rate listed on this wage determination, if it is higher) for all hours spent performing on the contract for calendar year 2018. The EO minimum wage rate will be adjusted annually. Please note that this EO applies to the above-mentioned types of contracts entered into by the federal government that are subject to the Davis-Bacon Act itself, but it does not apply to contracts subject only to the Davis-Bacon Related Acts, including those set forth at 29 CFR 5.1(a)(2) – (60). Additional information on contractor requirements and worker protections under the EO is available at www.dol.gov/whd/govcontracts.

Modification Number
0

Publication Date
01/05/2018

SUNC2014-003 11/14/2014

	Rates	Fringes
BLASTER	18.64	
CARPENTER	13.68	.05
CEMENT MASON/CONCRETE FINISHER	13.93	
ELECTRICIAN		
Electrician	18.79	2.72
Telecommunications Technician	15.19	1.25
IRONWORKER	13.30	
LABORER		
Asphalt Raker and Spreader	12.78	

	Rates	Fringes
Asphalt Screed/Jackman	14.50	
Carpenter Tender	12.51	.27
Cement Mason/Concrete Finisher Tender	11.04	
Common or General	10.40	.01
Guardrail/Fence Installer	13.22	
Pipelayer	12.43	
Traffic Signal/Lighting Installer	15.65	.24
PAINTER		
Bridge	23.77	
POWER EQUIPMENT OPERATORS		
Asphalt Broom Tractor	10.00	
Bulldozer Fine	16.13	
Bulldozer Rough	14.36	
Concrete Grinder/Groover	17.92	
Crane Boom Trucks	18.19	
Crane Other	19.83	
Crane Rough/All-Terrain	19.10	
Drill Operator Rock	14.28	
Drill Operator Structure	20.89	
Excavator Fine	16.95	
Excavator Rough	13.63	
Grader/Blade Fine	19.84	
Grader/Blade Rough	15.47	
Loader 2 Cubic Yards or Less	13.31	
Loader Greater Than 2 Cubic Yards	16.19	
Material Transfer Vehicle (Shuttle Buggy)	15.44	
Mechanic	17.51	
Milling Machine	15.22	
Off-Road Hauler/Water Tanker	11.83	
Oiler/Greaser	14.16	
Pavement Marking Equipment	12.05	
Paver Asphalt	15.97	
Paver Concrete	18.20	
Roller Asphalt Breakdown	12.79	
Roller Asphalt Finish	13.76	
Roller Other	12.08	
Scraper Finish	12.65	
Scraper Rough	11.50	
Slip Form Machine	19.60	
Tack Truck/Distributor Operator	14.82	
TRUCK DRIVER		
GVWR of 26,000 Lbs or Less	11.45	
GVWR of 26,000 Lbs or Greater	13.57	.03

Welders – Receive rate prescribed for craft performing operation to which welding is incidental.

Note: Executive Order (EO) 13706, Establishing Paid Sick Leave for Federal Contractors applies to all contracts subject to the Davis-Bacon Act for which the contract is awarded (and any solicitation was issued) on or after January 1, 2017. If this contract is covered by the EO, the contractor must provide employees with 1 hour of paid sick leave for every 30 hours they work, up to 56 hours of paid sick leave each year. Employees must be permitted to use paid sick leave for their own illness, injury or other health-related needs, including preventive care; to assist a

family member (or person who is like family to the employee) who is ill, injured, or has other health-related needs, including preventive care; or for reasons resulting from, or to assist a family member (or person who is like family to the employee) who is a victim of, domestic violence, sexual assault, or stalking. Additional information on contractor requirements and worker protections under the EO is available at www.dol.gov/whd/govcontracts.

Unlisted classifications needed for work not included within the scope of the classifications listed may be added after award only as provided in the labor standards contract clauses (29 CFR 5.5(a)(1)(ii)).

The body of each wage determination lists the classification and wage rates that have been found to be prevailing for the cited type(s) of construction in the area covered by the wage determination. The classifications are listed in alphabetical order of "identifiers" that indicate whether the particular rate is a union rate (current union negotiated rate for local), a survey rate (weighted average rate) or a union average rate (weighted union average rate).

Union Rate Identifiers

A four letter classification abbreviation identifier enclosed in dotted lines beginning with characters other than "SU" or "UAVG" denotes that the union classification and rate were prevailing for that classification in the survey. Example: PLUM0198-005 07/01/2014. PLUM is an abbreviation identifier of the union which prevailed in the survey for this classification, which in this example would be Plumbers. 0198 indicates the local union number or district council number where applicable, i.e., Plumbers Local 0198. The next number, 005 in the example, is an internal number used in processing the wage determination. 07/01/2014 is the effective date of the most current negotiated rate, which in this example is July 1, 2014.

Union prevailing wage rates are updated to reflect all rate changes in the collective bargaining agreement (CBA) governing this classification and rate.

Survey Rate Identifiers

Classifications listed under the "SU" identifier indicate that no one rate prevailed for this classification in the survey and the published rate is derived by computing a weighted average rate based on all the rates reported in the survey for that classification. As this weighted average rate includes all rates reported in the survey, it may include both union and non-union rates. Example: SULA2012-007 5/13/2014. SU indicates the rates are survey rates based on a weighted average calculation of rates and are not majority rates. LA indicates the State of Louisiana. 2012 is the year of survey on which these classifications and rates are based. The next number, 007 in the example, is an internal number used in producing the wage determination. 5/13/2014 indicates the survey completion date for the classifications and rates under that identifier.

Survey wage rates are not updated and remain in effect until a new survey is conducted.

Union Average Rate Identifiers

Classification(s) listed under the UAVG identifier indicate that no single majority rate prevailed for those classifications; however, 100% of the data reported for the classifications was union data. EXAMPLE: UAVG-OH-0010 08/29/2014. UAVG indicates that the rate is a weighted union average rate. OH indicates the state. The next number, 0010 in the example, is an internal number

used in producing the wage determination. 08/29/2014 indicates the survey completion date for the classifications and rates under that identifier.

A UAVG rate will be updated once a year, usually in January of each year, to reflect a weighted average of the current negotiated/CBA rate of the union locals from which the rate is based.

WAGE DETERMINATION APPEALS PROCESS

1.) Has there been an initial decision in the matter? This can be:

- * an existing published wage determination
- * a survey underlying a wage determination
- * a Wage and Hour Division letter setting forth a position on a wage determination matter
- * a conformance (additional classification and rate) ruling

On survey related matters, initial contact, including requests for summaries of surveys, should be with the Wage and Hour Regional Office for the area in which the survey was conducted because those Regional Offices have responsibility for the Davis-Bacon survey program. If the response from this initial contact is not satisfactory, then the process described in 2.) and 3.) should be followed.

With regard to any other matter not yet ripe for the formal process described here, initial contact should be with the Branch of Construction Wage Determinations. Write to:

Branch of Construction Wage Determinations
Wage and Hour Division
U. S. Department of Labor
200 Constitution Avenue, N.W.
Washington, D.C. 20210

2.) If the answer to the question in 1.) is yes, then an interested party (those affected by the action) can request review and reconsideration from the Wage and Hour Administrator (See 29 CFR Part 1.8 and 29 CFR Part 7). Write to:

Wage and Hour Administrator
U.S. Department of Labor
200 Constitution Avenue, N.W.
Washington, D.C. 20210

The request should be accompanied by a full statement of the interested party's position and by any information (wage payment data, project description, area practice material, etc.) that the requestor considers relevant to the issue.

3.) If the decision of the Administrator is not favorable, an interested party may appeal directly to the Administrative Review Board (formerly the Wage Appeals Board). Write to:

Administrative Review Board
U.S. Department of Labor
200 Constitution Avenue, N.W.
Washington, D.C. 20210

4.) All decisions by the Administrative Review Board are final.

PM-1



DocuSigned by:
Renee Roach
B3C6C6F7CF4640D...

4/25/2017

HOT SPRAY THERMOPLASTIC PAVEMENT MARKING LINES

Description

This work consists of machine applied hot spray thermoplastic pavement marking material with drop-on glass beads. All work shall be in accordance with the applicable requirements of Section 1205 of the *Standard Specifications* and this provision.

Construction

Use application equipment that provides multiple width settings ranging from 4" to 12" and multiple thickness settings to achieve a minimum 50 mil thickness in one pass.

Hand-liners will not be allowed.

All thermoplastic markings shall be of the hot, machine applied type. Application shall be accomplished by spraying methods only.

Produce a cross-sectional thickness of hot spray thermoplastic markings for long line markings only with a minimum thickness of 50 mils without glass beads and/or a minimum thickness of 55 mils with glass beads.

Material

Furnish the following pavement marking material certifications in accordance with Article 106-3 of the *Standard Specifications*:

Hot Spray Thermoplastic Type 3 Material Certification

Extruded type thermoplastic shall not be sprayed.

Measurement and Payment

Pay Item

Hot Spray Thermoplastic Pavement Marking Lines (" ,__mils)

Pay Unit

LF

TC-1

I-5811

Guilford County

WORK ZONE TRAFFIC CONTROL Project Special Provisions Table of Contents

Special Provision	Page
Work Zone Traffic Control for Interstate/Freeway Resurfacing Projects	TC-2
Work Zone Digital Speed Limit Signs	TC-14
Work Zone Presence Lighting	TC-18
Sequential Flashing Warning Lights	TC-22

WORK ZONE TRAFFIC CONTROL FOR INTERSTATE/FREEWAY RESURFACING PROJECTS

GENERAL REQUIREMENTS

This Provision is intended for Interstate/Freeway Resurfacing projects that are performed at night. In the event, the Day and time Restrictions allow for daytime work activities the Work zone Presence Lighting and Sequential Flashing Lights are to be omitted. However, the Digital Speed Limit Signs will be required as described below.

Maintain traffic in accordance with Divisions 10, 11 and 12 of the 2018 Standard Specifications and the following provisions:

Install Work Zone Advance Warning Signs in accordance with the attached drawing prior to beginning any other work.

When personnel and/or equipment are working on the shoulder adjacent to a divided facility and within 10 feet of an open travel lane, close the nearest open travel lane using Standard Drawing No. 1101.02 of the 2018 Roadway Standard Drawings.

When personnel and/or equipment are working within a lane of travel of a divided facility, close the lane using Standard Drawing No. 1101.02 of the 2018 Roadway Standard Drawings or as directed by the Engineer. Conduct the work so that all personnel and/or equipment remain within the closed travel lane. Perform work only when weather and visibility conditions allow safe operations as directed by the Engineer.

1. Time Restrictions for Lane Closure and Road Closure Activities

All lane closure and road closure activities shall be performed in compliance with the Day and Time restrictions listed and defined in this Contract.

Any activities performed outside of these requirements will be subject to the Liquidated Damages unless approved by the Engineer prior to beginning the activity.

The Contractor may place/pre-stage all required signs and traffic control devices necessary for lane closures prior to the closure time as approved by the Engineer. However, flashing arrow boards and changeable message signs shall not indicate lane closure information until 30 minutes or less prior to the installation of the lane closure. Typical pre-staging times are 1 hour for a single lane closure and 2 hours for double and triple lane closures. The travel lane(s) are to be closed at the prescribed times defined in this Contract.

TC-3

I-5811

Guilford County

For removal, the lane(s) must be reopened in compliance with the times defined in this Contract. It is acceptable to remove the signs and traffic control devices from the shoulder/staging area after the lane(s) are reopened to traffic.

2. Work Zone Speed Limits and Digital Speed Limit Signs (DSLS)

All speed limits are to be ordained by the State Traffic Engineer in order to have a lawfully enforceable speed limit; therefore, no speed limit messages/signs shall be installed prior to receiving a signed ordinance. NCDOT has sole authority of the speed limits displayed within the work zone.

The Regional Traffic Engineering Office and the Division Construction Engineer in coordination with the Work Zone Traffic Control Section will provide all Work Zone Speed Limit recommendations based on activities and conditions.

When lane closures are in effect and if ordained by the State Traffic Engineer, implement a Work Zone “Variable” Speed Limit Reduction as stated in the ordinance and in accordance with the attached Provision and drawing.

Use Digital Speed Limit Signs (DSLS) to display the work zone speed limit as shown in the attached drawing. The Speed Limit shall be continuously displayed on the digital speed limit signs. (See Attached Provision.)

The Contractor will be responsible for coordinating with the Engineer when the Work Zone Speed Limits are to be changed and will have to seek approval by the Engineer before the Speed Limit is changed.

When the variable speed limit reductions are in effect, cover any existing speed limit signs located within the active work area that conflict with the variable speed limit reduction.

The speed limit shall be returned to the existing speed limit when the lane closure is removed and traffic is returned to the existing pattern.

3. Work Zone Presence Lighting and Sequential Flashing Warning Lights

Provide the following for nighttime work activities in accordance with attached drawing and special provisions:

- A. Furnish and install Work Zone Presence Lighting to supplement the Contractor’s portable construction and equipment lighting for the purpose of alerting motorist to the existence of an active work zone and to encourage compliance with the reduced work zone speed limit. (See attached Provision.)

TC-4

I-5811

Guilford County

B. Furnish and install Sequential Flashing Warning Lights on drums used for merging tapers to assist motorist in determining which direction to merge and to decrease late lane merging. (See attached Provision.)

4. Law Enforcement

This contract **requires law enforcement** presence for all lane closures or as determined by the Engineer. The Contractor will not be responsible for the payment of law enforcement officers but shall notify the Engineer 14 days in advance of any planned lane closure.

The Resident Engineer assigned to this project will notify the law enforcement agency when their presence is needed on the project. The Contractor shall cooperate with the law enforcement officers during the life of this project.

TEMPORARY TRAFFIC CONTROL (TTC)

Refer to Standard Drawing No. 1101.02, 1101.11, 1110.01, 1110.02, 1115.01, 1130.01, 1135.01, 1165.01, and 1180.01 of the 2018 Roadway Standard Drawings when closing a lane of travel in a stationary work zone for items such as milling, paving, diamond grinding concrete pavements, minor bridge and approach slab rehabilitation.

Drums are recommended for all lane closure operations occurring at night. However, if skinny drums are used at night, they shall be placed every 20' in the tangent sections of lane closure operations. Skinny drums shall not be used for upstream tapers.

When covering work zone signs, use an opaque material that prevents reading of the sign at night by a driver using high beam headlights. Use material, which does not damage the sign sheeting.

Refer to Standard Drawing No. 1101.02, Sheets 9 and 10 of the 2018 Roadway Standard Drawings for diamond grinding, milling and/or paving of ramps unless otherwise approved to be closed by the Engineer. If approved, see attached drawing for typical placement of devices and signing for the detour route. All items shall be compensated for based on the unit bid price for the respective item.

Refer to Standard Drawing No. 1101.03, sheet 7 of the 2018 Roadway Standard Drawings for a closure of the interstate/freeway with traffic detoured via interchange ramps for items such as minor bridge and approach slab rehabilitation. Use Flaggers or Law Enforcement to direct traffic at ramp terminals as directed by the Engineer.

Refer to Standard Drawing No. 1101.02, sheet 12 or 13 of the 2018 Roadway Standard Drawings for utilizing a Moving Operation for such items as pavement marking and marker placement. A minimum speed of 3 mph shall be maintained at all times with no stops that narrow or close a lane of travel. If the moving operation is progressing slower than 3 mph at any time, install a lane

TC-5

I-5811

Guilford County

closure. All traffic control devices for this operation is considered incidental to the pay items for Pavement Marking and Markers.

TRAFFIC OPERATIONS

1. Project Requirements:

Failure to comply with the following requirements will result in a suspension of all other operations:

- A. Before working on ANY MAP, the Contractor shall submit a written construction sequence for traffic control and construction lighting for ALL MAPS to the Engineer at the first pre-construction meeting and the sequence must be approved before closing a lane of traffic. The Contractor and Engineer will coordinate with the State Work Zone Engineer at 919-814-4937 for additional traffic control guidance, as necessary.
- B. The maximum “Active Work Area” is a distance of 5 miles. It is defined as the maximum allowable distance for Resurfacing Operations taking place in a single work period. Therefore, the maximum length of lane closure is 5 miles. However, approval by the Engineer is required before closing more than 2 miles of Interstate to ensure the Contractor has the equipment and labor force to actively pursue the work.
- C. Notify the Engineer 15 consecutive calendar days before resurfacing a bridge or its approaches. Patch and make repairs to bridge surface and its approaches before resurfacing occurs. Coordinate all operations on the bridge and its approaches with the Engineer.
- D. Notify the Engineer 48 hours before resurfacing the areas of existing pavement that require patching. Patch these areas before resurfacing occurs. Allow full depth asphalt patching to cool to the point of supporting traffic without displacement or rutting before reopening closed lane. Coordinate the resurfacing operations of the patched areas with the Engineer.
- E. Notify the Engineer 48 hours before milling or resurfacing will interfere with the existing Signal Loops. Loops may need to be placed in milled surface before resurfacing occurs. Coordinate all signal loop operations with the Engineer.
- F. Obtain written approval of the Engineer before working in more than one location or setting up additional lane closures.
- G. The Contractor on this and any adjacent projects, or subcontractors working within this project shall coordinate lane closure location, type, and direction with the Engineer to best maintain lane continuity through the limits of this and adjacent projects.

TC-6

I-5811

Guilford County

- H. Operate equipment and conduct operations in the same direction as the flow of traffic. Maintain vehicular access in accordance with Article 1101-05 of the 2018 Standard Specifications.
- I. Provide appropriate construction lighting in accordance with Section 1413 of the 2018 Standard Specifications.
- J. Contractor shall diamond grind, mill and pave lanes in an order such that water shall not accumulate.

2. Paving Lift Requirements and Time Limitations:

Failure to comply with the following requirements will result in a suspension of all other operations until all lanes of traffic are brought to the same station and elevation:

Paving Overlays and Lifts up to 3"

- A. For surface course paving lifts of 2.0" or less, the Contractor shall conduct his paving operations such that the following conditions are met.

Once paving begins in any lane, the Contractor will be permitted to pave as far as the work operations allow (up to 5 miles) for the initial paving period. In the next days' paving operation, not to exceed 72 hours, bring the adjacent lane to the same station and elevation. At the end of the work day, any uneven lane conditions shall be signed with an "UNEVEN PAVEMENT/NEXT XX MILES" on the portable changeable message signs and portable "UNEVEN PAVEMENT" signs (dual mounted) 1,000' in advance of the uneven pavement and every ½ miles thereafter along the uneven portion of roadway. Once mitigated, all portable "UNEVEN PAVEMENT" signs shall be removed.

For Open Graded Surface Mixes, "UNEVEN PAVEMENT" signs are not required.

- B. For 3" surface course mixes, place in two paving lifts of 1 ½" each unless directed otherwise by the Engineer. Conditions for uneven travel lanes same as described above.

Paving Lifts Greater than 3"

For all other paving lifts greater than 3", bring all newly resurfaced lanes to the same station and elevation by the end of each work day unless the Contractor utilizes the notched wedge paving methods as described below:

- A. Any paving lift greater than 3" shall be mitigated by having an approved wedge apparatus on the paver that shapes the edge 1" vertically and the remaining at a maximum slope steepness of 2:1. The maximum paving lift allowed to use this method is 3".

TC-7

I-5811

Guilford County

- B. At the end of the work day, the Contractor shall place portable “UNEVEN PAVEMENT” signs in advance of the uneven pavement and spaced every ½ mile along the section of uneven pavement. Once mitigated, all portable “UNEVEN PAVEMENT” signs shall be removed.
- C. In the next day’s paving operation and not to exceed 72 hours, the Contractor shall bring up the adjacent lane to the same station and elevation before any further paving takes place on the project.

Milling Operations (Does Not Apply to Fine Milling)

Conduct milling operations so that any milled pavement is paved back by the end of each work day.

A milled/grooved surface shall not be re-opened to traffic except in cases where inclement weather or mechanical failure prevents the paving back of the lane by the end of the work day.

If milled areas are not paved back within the same work period due to inclement weather or mechanical failure, the Contractor is to furnish and install portable signs to warn drivers of the conditions. The signs include “Grooved Pavement” (W8-15) w/ Motorcycle Plaque mounted below, and “Uneven Lanes” (W8-11). These are to be dual indicated where lateral clearance can be obtained within the median areas. Install the “Grooved Pavement” (W8-15) w/ Motorcycle Plaque 1500’ in advance of the milled area. Install the “Uneven Lanes” (W8-11) 500’ in advance of the milled area. Alternate these signs every ½ mile. Once mitigated, all portable signs are to be removed.

Slope the pavement at the beginning and ending of the daily milling operation as directed by the Engineer. Sweep and remove all milled material from the roadway as soon as the daily milling operation is completed. Remove any existing pavement adjacent to the milled area that has been damaged and replace with patch material as directed by the Engineer.

Fine Milling / Microsurfacing Operations (Depths less than 1”)

For fine milling operations less than 1”, paving is not required in the same work period. The paving of the fine milled area is to be conducted within the next work period and not to exceed 72 hours. No advance warning signs are needed for the conditions. However, pavement markings are required by the end of each work day.

3. Temporary Pavement Markings:

Review and record the existing pavement markings and markers before obliteration. Re-establish the new pavement markings and markers using the record of existing markings in conjunction with the 2018 Roadway Standard Drawings unless otherwise directed by the Engineer. Submit the

TC-8

I-5811

Guilford County

record of the existing pavement markings seven calendar days before the obliteration of any pavement markings.

Obliterated pavement markings shall be replaced by the end of each workday's operation. Interim paint may be used to comply with time limitations if final pavement markings cannot be placed except for milled surfaces or diamond ground surfaces. Final markings shall be placed within 30 days in accordance with Section 1205-4 and Section 1205-5. For milled surfaces, temporary pavement markings shall be used in accordance with Section 1205-8(C). There will be no direct payment for interim paint. Temporary paint will be paid for at the contract unit price.

For concrete surfaces that have been diamond ground as a surface treatment, 4" temporary paint shall be used in accordance with Section 1205-8(C). Upon completion of all diamond grinding operations, 4" line removal shall be used to remove 100% of the 4" temporary paint on the final concrete surface by grinding method only. Use an acceptable method to grind ridges smooth only where pavement markings will be installed prior to placing final pavement marking material. This method shall also be used in the area of the black contrast for surface preparation. Payment for line removal will be made in accordance with Section 1205-10.

For project winterization, install temporary paint markings in accordance with Section 1205-8(C) of the 2018 Standard Specifications. Use 4" lane, edge, and center lines and 8" gore lines. Compensation for this work shall be made in accordance with Section 1205-10 except that no payment will be made if paving is completed more than 30 days before the written notification by the Department that winterization is required.

4. Work Zone Signing:

A. Description

Install advance/general warning work zone signs according to the attached drawings prior to beginning work.

For paving overlays of 3" or greater that create a drop-off adjacent to the median shoulder, install "LOW/SOFT SHOULDER" (SP 13107) signs on the median shoulder. Place initially at the construction limits, and then space 1 mile thereafter. No signing required for the outside shoulder.

Install and maintain signing in accordance with the Divisions 11 and 12 of the 2018 Standard Specifications.

B. Installation

TC-9

I-5811

Guilford County

All stationary Advance/General warning work zone signs require notification to existing Utility owners per Article 105-8 of the 2018 Standard Specifications and Special Provision SP1 G115 within 3 to 12 full working days prior to installation.

Install all Advance/General warning work zone signs before beginning work on a particular map. If signs are installed more than seven (7) calendar days prior to the beginning of work on a particular map, cover the signs until the work begins. Install each work zone Advance/General warning sign separately and not on the same post or stand with any other sign except where an advisory speed plate or directional arrow is used.

All sign locations to be verified by the Engineer prior to installation. Once the signs have been installed and accepted, any sign relocations requested by the Department will be compensated in accordance with Article 104-7. Any additional signs other than the ones required in this provision or attached drawings will be compensated in accordance with Article 104-7.

If there is a period of construction inactivity longer than 14 calendar days, remove or cover advance/general warning work zone signs. Uncover advance/general warning work zone signs no more than 7 calendar days before work resumes.

All other operations may be suspended upon failure to comply with the above requirements. Such suspended operations would not be resumed until the above requirements are fulfilled.

C. Sign Removal

Once Maps on the Project are substantially completed, it is acceptable to remove the Stationary Work Zone Signs on those Maps in lieu of waiting until all of the Maps are completed on the Project. A Map is substantially complete when the resurfacing operations are completed and the shoulders are brought up to the same elevation as the proposed pavement and when temporary pavement markings (paint) are installed along the centerline and edge lines as well as the ramps and loops. The final pavement markings (Thermoplastic or Polyurea) and/or markers do not have to be installed for the Map to be considered substantially complete. Final Pavement Markings/Markers are installed with portable signing and changeable message signs according to Roadway Standard Drawing 1101.02, sheet 13. Any remaining punch list items requiring traffic control are to be completed with portable work zone signing with compensation covered in the Contract Unit price for price for the required Traffic Control items.

Stationary Work Zone Sign removal is a condition of final project acceptance.

D. Lane Closure Work Zone Signs

TC-10

I-5811

Guilford County

Install any required lane closure signing needed during the life of the project in accordance with the Standard Drawing No. 1101.02, 1101.11 and 1110.02 of the 2018 Roadway Standard Drawings.

MEASUREMENT AND PAYMENT

Stationary Work Zone Signs will be measured and paid as the actual number of square feet satisfactorily installed at each location and accepted by the Engineer.

Refer to the respective Sections of Division 11 and 12 of the 2018 Standard Specifications or the attached Special Provisions for the satisfactory installation and removal of lane closures and temporary pavement markings and markers.

Measurement for Lane Closures is the actual number of stationary lane closures satisfactorily installed for paving and all other required operations as shown in Roadway Standard Drawing 1101.02, sheets 4, 5, 6, 8, 9 & 10. All labor, traffic control devices, and signing for lane closures as shown in these Roadway Standard Drawings are paid under this item.

Lane closures will be measured and paid at the Contractor's unit price for Lane Closure on a per each basis. In the event a dual or triple lane closure is required, they will be measured individually and paid on a per each basis. The ramp lane closures shown in Roadway Standard Drawing 1101.02, sheets 9 & 10, are considered part of the mainline lane closure and will not be measured or paid separately.

Measurement for Ramp/Loop Closures is the actual number of total ramp/loop closures and detours satisfactorily installed for ramp/loop paving and all other required operations as shown on the Short Term Closure and Detour of Interstate/Freeway Ramps detail drawing. All labor, traffic control devices and signing required for re-routing traffic as shown on the Short Term Closure and Detour of Interstate/Freeway Ramps detail drawing are paid under this item.

Ramp/Loop Closures will be measured and paid at the Contractor's unit price for Ramp/Loop Closures on a per each basis. In the event two separate ramps are closed at the same time, they will be measured individually and paid on a per each basis.

Measurement and payment for paint pavement marking lines, paint pavement marking symbols, removal of pavement marking lines will be according to Section 1250-10.

Digital Speed Limit Signs, Sequential Flashing Warning Lights, and Work Zone Presence Lighting are paid separately.

Payment will be made under:

TC-11

I-5811

Guilford County

Pay Item	Pay Unit
Work Zone Signs (Stationary)	SF
Lane Closure	EA
Ramp/Loop Closure	EA
Paint Pavement Marking Lines (__”)	LF
Paint Pavement Marking Symbols	EA
Removal of Pavement Marking Lines (__”)	LF

STATIONARY ADVANCE WARNING SIGNS FOR INTERSTATE / FREEWAY RESURFACING PROJECTS

DIVIDED MEDIANS WITH WIDTHS 46' OR GREATER

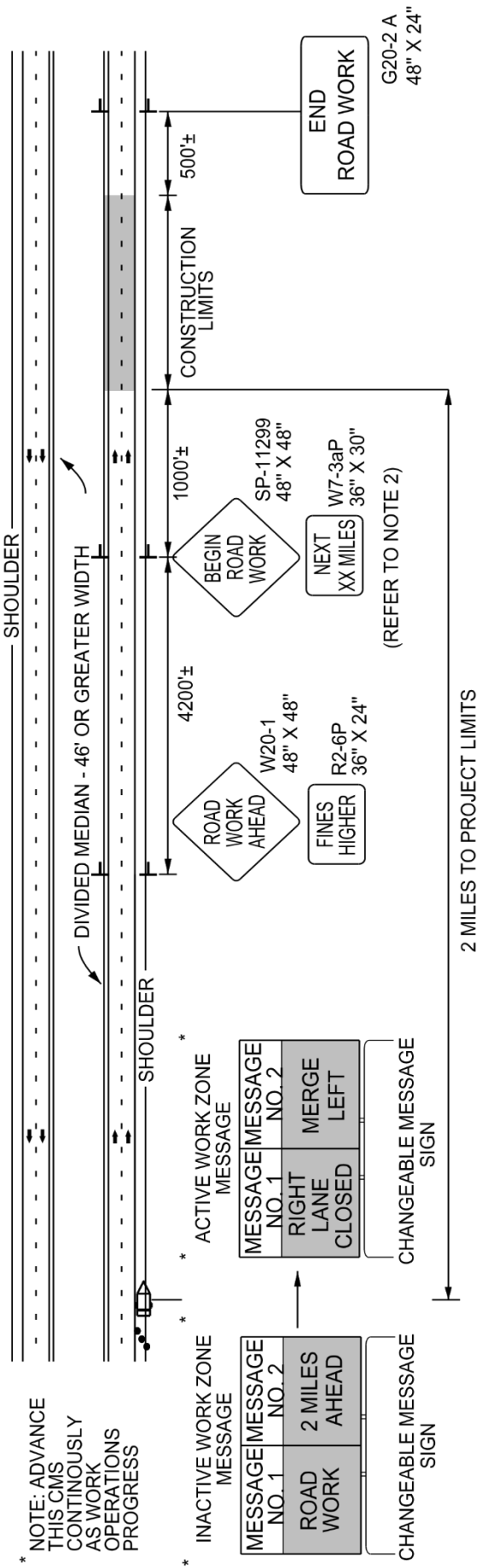

DIVIDED MEDIANS WITH WIDTHS LESS THAN 46' OR WITH PERMANENT MEDIAN BARRIER

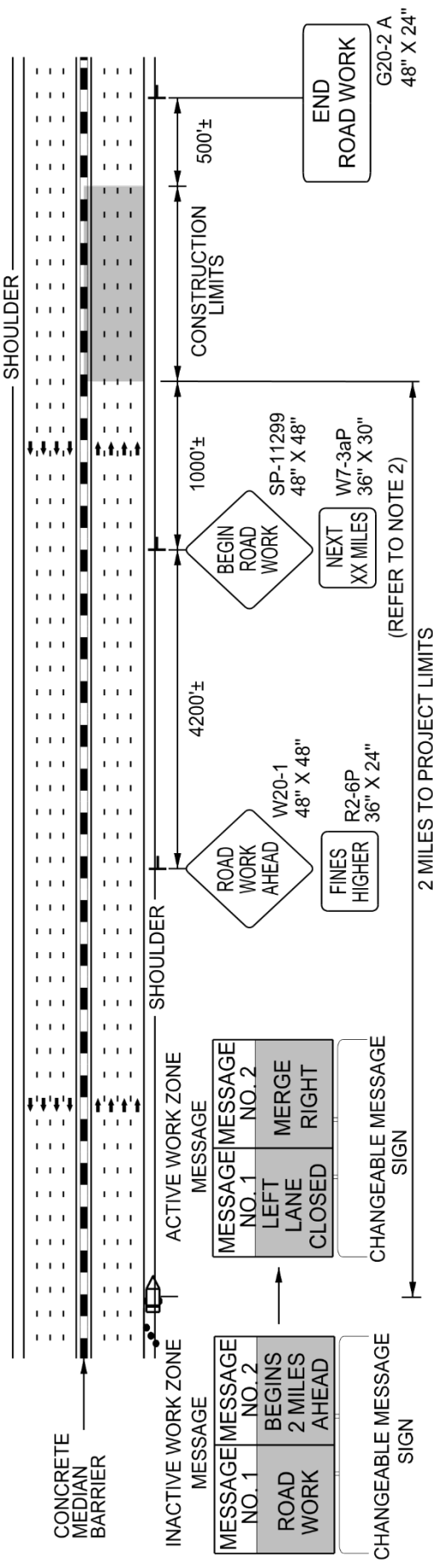

LEGEND

▲ DIRECTION OF TRAFFIC FLOW

● TRAFFIC DRUM

◁ CHANGEABLE MESSAGE SIGN (CMS)

⊥ STATIONARY SIGN

NOTES

1. THIS DRAWING IS TO BE USED IN CONJUNCTION WITH THE WORK ZONE VARIABLE SPEED LIMIT USING DIGITAL SPEED LIMIT SIGNS FOR INTERSTATE/FREEWAY RESURFACING PROJECTS DETAIL.
2. FOR SIGN W7-3aP, ROUND TO THE NEAREST MILE.
3. FOR ENTRANCE AND EXIT RAMP, REFER TO RSD 1101.01, SHEET 1, DETAIL B & C.
4. FOR ADDITIONAL NOTES, REFER TO RSD 1101.01, SHEET 1.

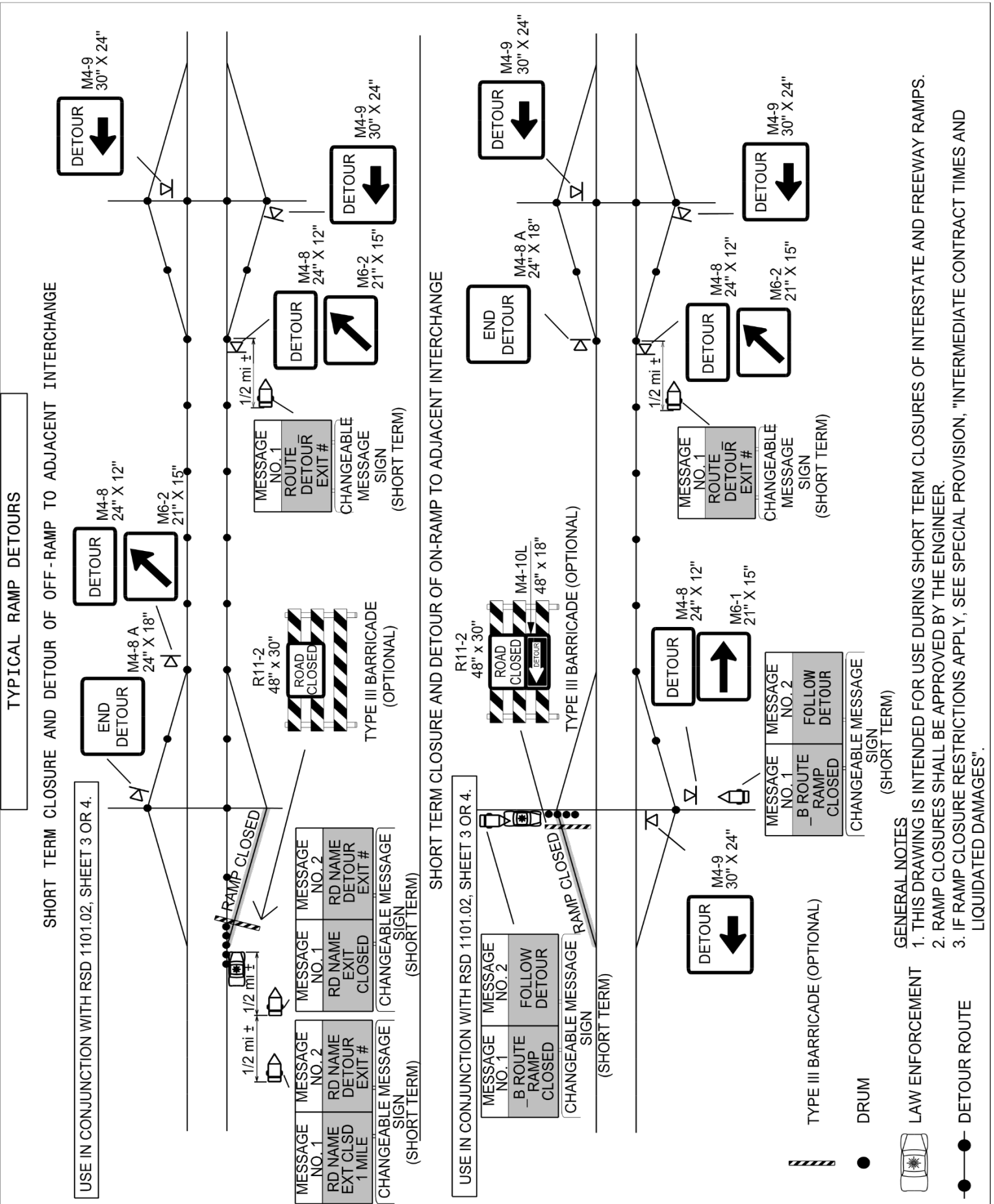

TC-14

I-5811

Guilford County

WORK ZONE DIGITAL SPEED LIMIT SIGNS:

(10/08/2016)

Description

Furnish and install Work Zone Digital Speed Limit Signs on interstates and freeways with speed limits greater than 55 MPH and or facilities that have significant traffic volumes and impacts. These signs are regulatory speed limit signs with LED displays for the speed limit numbers. The purpose of Digital Speed Limit signs is to easily change work zone speed limits between activities that necessitate the need for a lower speed limit and the ones that do not.

Materials

Digital Speed Limit Signs shall be a minimum 36" wide x 48" high. The speed limit sign (R2-1) shall be black on white with high intensity white prismatic sheeting.

The Digital Speed Limit sign shall be mounted such that the bottom of the sign is 7' above roadway.

The LED panel shall be a minimum of 18" wide x 28" high. The display on the LED panel shall be amber or white.

The LED numbers shall have a minimum 5 wide by 7 high pixel array with a minimum height of 18".

The LED panel shall have auto brightness/dimming capability.

The black on orange "WORK ZONE" sign shall be mounted above the Speed Limit sign. It shall be 36" wide x 24" high with high intensity prismatic orange sheeting.

The black on white "\$250 FINE" sign shall be mounted below the Speed Limit sign. It shall be 36" wide x 24" high with high intensity prismatic white sheeting.

All digital speed limit systems shall have operational software and wireless communications that allows for remote operation and data monitoring. It shall be configured to allow access by the Engineer or his designee to change each sign independently or change the speed limit on all signs at once from a PC, tablet or cellular phone application.

Digital Speed Limit Signs may be trailer mounted or stationary mounted. The unit shall be Solar powered and have the ability to operate continuously. It shall be supplemented with a battery backup system which includes a 110/120 VAC powered on-board charging system.

The batteries, when fully charged; shall be capable of powering the display for 20 continuous days with no solar power. The unit shall be capable of being powered by standard 110/120 VAC power source.

TC-15

I-5811

Guilford County

Store the battery bank and charging system in a lockable, weather and vandal resistant box.

Optional Equipment/Capabilities

Work Zone Digital Speed Limit systems may include speed data collection. If provided, this information is to be available in a spreadsheet format and accessed remotely from a secure cloud location.

The Work Zone Digital Speed Limit systems may have radar equipment to detect approaching speeds.

The Work Zone Digital Speed Limit systems may have flashing beacons. If used, the beacons are to be 12" diameter LED circular yellow. They may be mounted either above, beside or below the sign assemblies and are to be centered horizontally. If used, the beacons shall alternately flash at rates not less than 50 or more than 60 times per minute.

All Work Zone Digital Speed Limit equipment shall be on the NCDOT Work Zone Traffic Control Approved Products List.

Construction Methods

The Speed Limit shall be continuously displayed on the signs. The speed limits are the sole authority of the NCDOT. All speed limits are to be ordinated by the State Traffic Engineer in order to have a lawfully enforceable speed limit.

The Regional Traffic Engineering Office and the Division Construction Engineer in coordination with the Work Zone Traffic Control Section will provide all Work Zone Speed Limit recommendations based on activities and conditions.

The Contractor will be responsible for coordinating with the Engineer when the Work Zone Speed Limits are to be changed and will have to seek approval by the Engineer or his designee before the Speed Limit is changed.

If the system has radar equipment and flashing beacons, the Digital Speed Limit systems shall have beacons activated when the "55 MPH" speed limit is being displayed. At all other speed limit displays (60 MPH, 65 MPH, 70 MPH), the beacons are not to be automatically activated until approaching speeds are detected to be 7 MPH or higher above the posted speed limit.

Whenever possible, each trailer mounted unit shall be placed on the paved shoulder and shall have the capability of being leveled.

Measurement and Payment

The measurement for the Work Zone Digital Speed Limit Signs is made according to the number of Work Zone Digital Speed Limit signs required per the spacing requirements according to the attached drawing. Payment will be made for the maximum number of Work Zone Digital Speed

TC-16

I-5811

Guilford County

Limit signs satisfactorily installed and properly functioning at any one time during the life of the project.

This includes all materials and labor to install, maintain and remove all the Work Zone Digital Speed Limit Units.

Pay Item

Work Zone Digital Speed Limit Signs

Pay Unit

Each

WORK ZONE "VARIABLE" SPEED LIMIT USING DIGITAL SPEED LIMIT SIGNS FOR INTERSTATE / FREEWAY RESURFACING

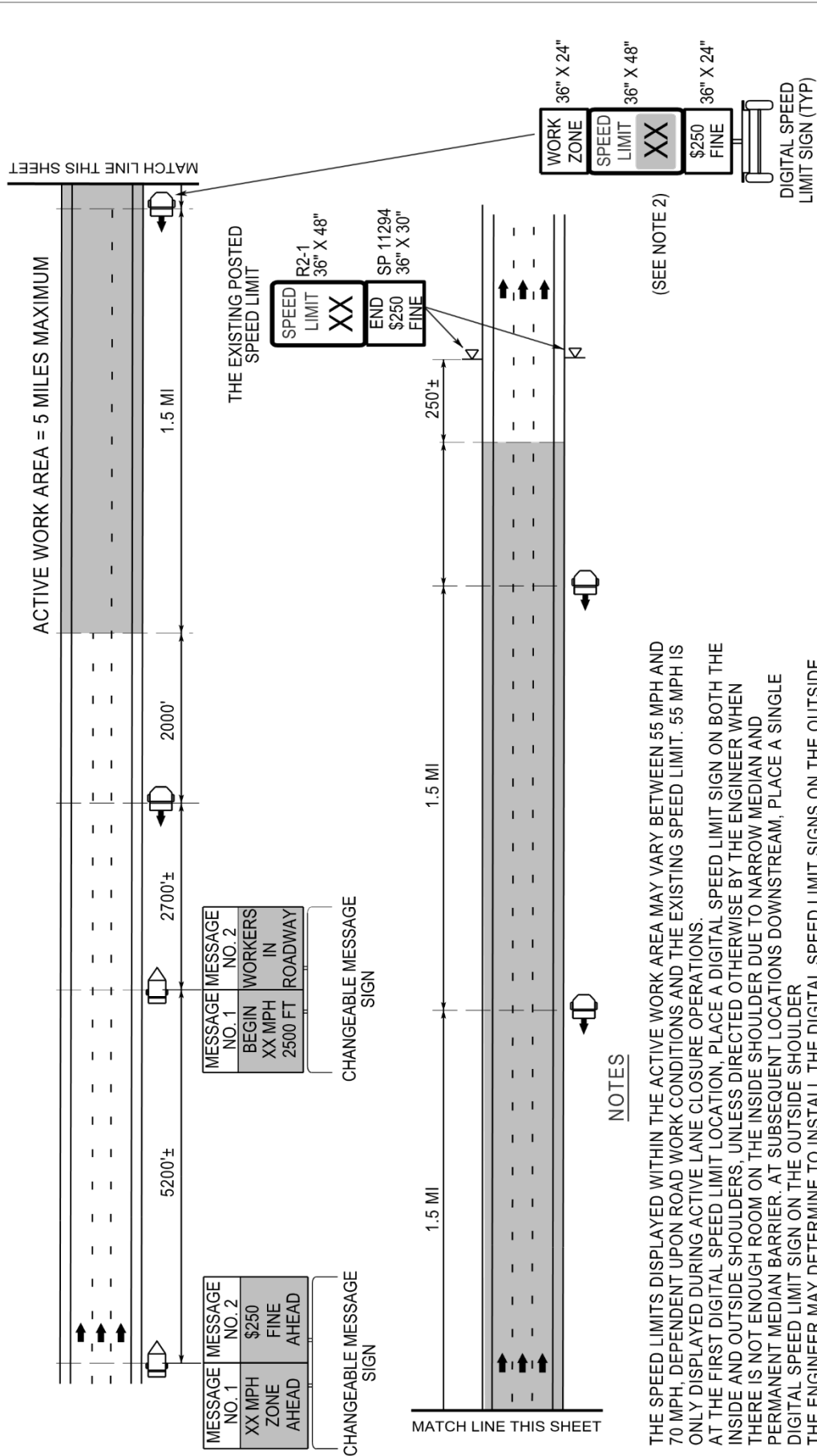

WHEN THERE IS NOT ACTIVE WORK IN THE TRAVEL LANE

SPEED LIMIT DISPLAY	CONDITIONS
	DROP-OFFS BETWEEN OPEN TRAVEL LANES
USE EXISTING SPEED LIMIT	PAVED SHOULDER DROP-OFFS
REDUCE SPEED LIMIT 5 MPH	

DROP-OFFS BETWEEN OPEN TRAVEL LANES SHOULD NOT EXCEED 2.0'

NOTES

1. THE SPEED LIMITS DISPLAYED WITHIN THE ACTIVE WORK AREA MAY VARY BETWEEN 55 MPH AND 70 MPH, DEPENDENT UPON ROAD WORK CONDITIONS AND THE EXISTING SPEED LIMIT. 55 MPH IS ONLY DISPLAYED DURING ACTIVE LANE CLOSURE OPERATIONS.
2. AT THE FIRST DIGITAL SPEED LIMIT LOCATION, PLACE A DIGITAL SPEED LIMIT SIGN ON BOTH THE INSIDE AND OUTSIDE SHOULDERS, UNLESS DIRECTED OTHERWISE BY THE ENGINEER WHEN THERE IS NOT ENOUGH ROOM ON THE INSIDE SHOULDER DUE TO NARROW MEDIAN AND PERMANENT MEDIAN BARRIER. AT SUBSEQUENT LOCATIONS DOWNSTREAM, PLACE A SINGLE DIGITAL SPEED LIMIT SIGN ON THE OUTSIDE SHOULDER
3. THE ENGINEER MAY DETERMINE TO INSTALL THE DIGITAL SPEED LIMIT SIGNS ON THE OUTSIDE SHOULDER OR ON THE MEDIAN SIDE IF THE SIGNS ARE NOT HIGHLY VISIBLE TO ALL MOTORISTS.
4. THIS APPLICATION IS FOR SHORT-TERM ACTIVITIES. THE MAXIMUM ACTIVE WORK AREA IS 5 MILES.
5. THE DIGITAL SPEED LIMIT SIGNS TAKE PRECEDENCE OVER EXISTING SPEED LIMIT SIGNS. ALL EXISTING SPEED LIMIT SIGNS SHALL BE COVERED OR REMOVED.
6. THE DIGITAL SPEED LIMIT SIGNS WILL BE INSTALLED (TRAILER MOUNTED OR STATIONARY MOUNTED) IN ADVANCE AND SPACED APPROXIMATELY 1.5 MILES THROUGHOUT THE ACTIVE WORK AREA, UNLESS DIRECTED OTHERWISE.
7. NCDOT HAS SOLE AUTHORITY OF THE SPEED LIMITS DISPLAYED ON THE DIGITAL SPEED LIMIT SIGNS.
8. THE WORK ZONE VARIABLE SPEED LIMIT AND THE \$250 SPEEDING PENALTY ARE SEPARATE ORDINANCES THAT MUST BE SIGNED BY THE STATE TRAFFIC ENGINEER TO BE VALID AND ENFORCEABLE. WITHOUT A SIGNED ORDINANCE, THE SPEED LIMIT ON A FACILITY SHALL REMAIN UNCHANGED.

WORK ZONE PRESENCE LIGHTING:

(10/08/16)

DESCRIPTION

Furnish and install Work Zone Presence Lighting to supplement the Contractor's construction/task (Portable Construction Lighting) and equipment lighting during nightly work activities on high speed (greater than 55 MPH) facilities and/or facilities that have significant traffic volumes and impacts. The purpose of Work Zone Presence Lighting is to alert the motorist to the existence of an active work zone, improve worker visibility, and to assist in compliance of the work zone speed limit by providing lighting throughout the length of the lane closure.

MATERIALS

Anti-glare lighting systems are required. Work Zone Presence Lighting is in addition to the Contractors' Portable Construction Lighting. Work Zone Presence Lighting shall be installed in accordance with the attached detail and Manufacturer's recommendations.

All Work Zone Presence Lighting shall be supplied with a power source to provide the light output as described in the chart below.

Each light unit shall be capable of providing a minimum of 14,000 lumens illuminating a minimum area of approximately 3,000 square feet. The light shall be capable of being elevated to a height of 14 feet above the pavement.

Each light unit support base or mounting stand shall have the capability of being leveled.

Provide Work Zone Presence Lighting listed on the NCDOT APL.

CONSTRUCTION METHODS

The purpose of Work Zone Presence Lighting is to illuminate areas of the lane closure where construction/task lights are not located. Typical use is during lane closures for resurfacing and milling operations in locations where the pavement is being prepped for paving or milling, as well as where these operations have passed through that involve remaining work items such as rolling, coring/inspecting, shoulder and striping activities.

Immediately replace any lighting unit that is not operational.

Installation Locations

1. Standard Lane Closure Lengths of 2 miles or less

Position #1: Initially, place the work zone presence lighting starting 1 mile downstream of the merge taper and continue until the end of the lane closure. See attached detail-Position #1.

TC-19

I-5811

Guilford County

Position #2: Once paving operations progress to the point where the construction/task lighting has to be relocated to finish paving for the night, the Work Zone Presence Lighting shall be relocated to the beginning of the lane closure. See Attached Drawing-Position #2.

2. Lane Closures exceeding 2 miles (Must be approved by the Engineer)

Single Work Operations: If the lane closure is longer than 2 miles within a single work operation, begin installing the work zone presence lighting at the halfway point of the lane closure length and continue placing the lights until the end of the lane closure. Same procedure for relocation shall be followed as described above.

3. Multiple Work Operations exceeding 2 miles (Must be approved by the Engineer)

If the lane closure is longer than 2 miles and 2 separate operations are working concurrently, treat as 2 separate locations. The Work Zone Presence Lights are installed at the halfway point in each operation. The lights in the 1st operation will end where the 2nd operation begins. The lights in the 2nd operation will terminate with the end of the lane closure. Same procedure for relocation shall be followed as described above.

Lighting Unit Installation Requirements

The lighting units shall be installed inside the lane closure as shown on the attached detail and spaced according to the chart below:

SPACING CHART

Light Output (Lumens)	Illuminated Fixture Area-Minimum (Square Feet)	Maximum Spacing (Feet)	Light Units (Per Mile)
14,000 to 35,000	4'	750'	7
35,001 to 60,000	5'	1,000'	5
Above 60,000	6' or greater	1,320	4

Whenever possible, each light unit shall be placed on the 10' paved shoulder according to the above spacing based on the amount of light output for each unit.

Each light unit shall be installed and moved as necessary to allow for efficient paving operations to take place as well as to not interfere with the Contractor's ability to light the work area. At no time shall Work Zone Presence Lighting be located in the same area as the Contractor's construction/task lighting or conflict with his work operations.

If the Contractor provides sufficient construction/task lighting to meet the luminance requirements of Section 1413-3 for the full length of the lane closure or if sufficient existing overhead lighting is present, Work Zone Presence Lighting may be eliminated as directed by the Engineer.

TC-20

I-5811

Guilford County

MEASUREMENT AND PAYMENT

Work Zone Presence Lighting will be measured and paid as the maximum number of lighting units satisfactorily placed, accepted by the Engineer, and in use at any one time during the life of the project.

Relocation, replacement, repair, removal, and maintenance of Work Zone Presence Lighting units will be incidental to the work of this section. No measurement or separate payment will be made for power generators, batteries, or other power supply devices.

Pay Item	Pay Unit
Work Zone Presence Lighting	Each

SEQUENTIAL FLASHING WARNING LIGHTS AND WORK ZONE PRESENCE LIGHTING

POSITION 1
1 MILE DOWNSTREAM FROM TAPER

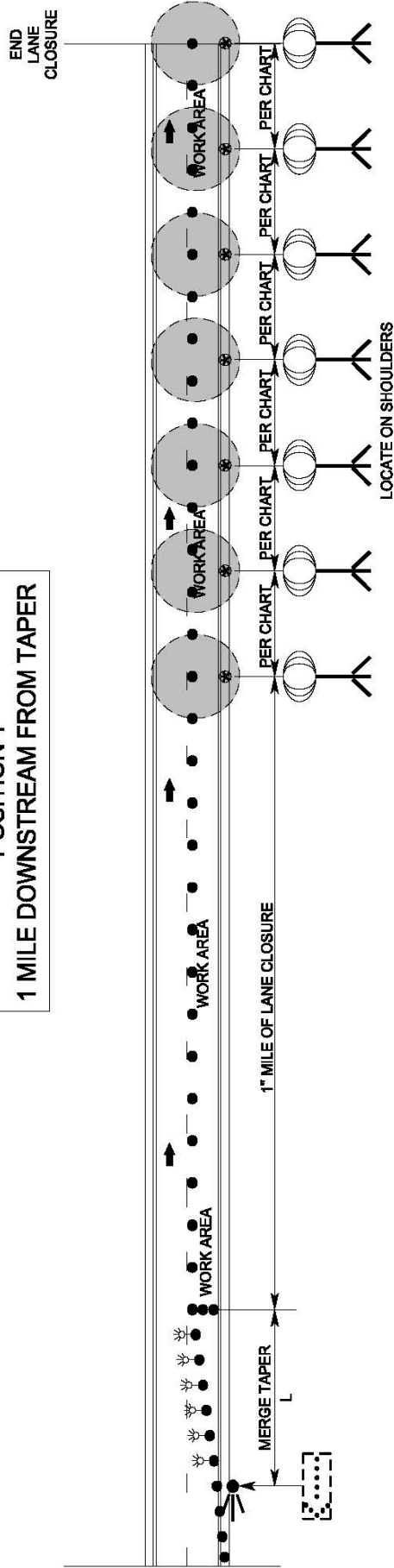

POSITION 2
BEGIN AT TAPER AND CONTINUE 1 MILE

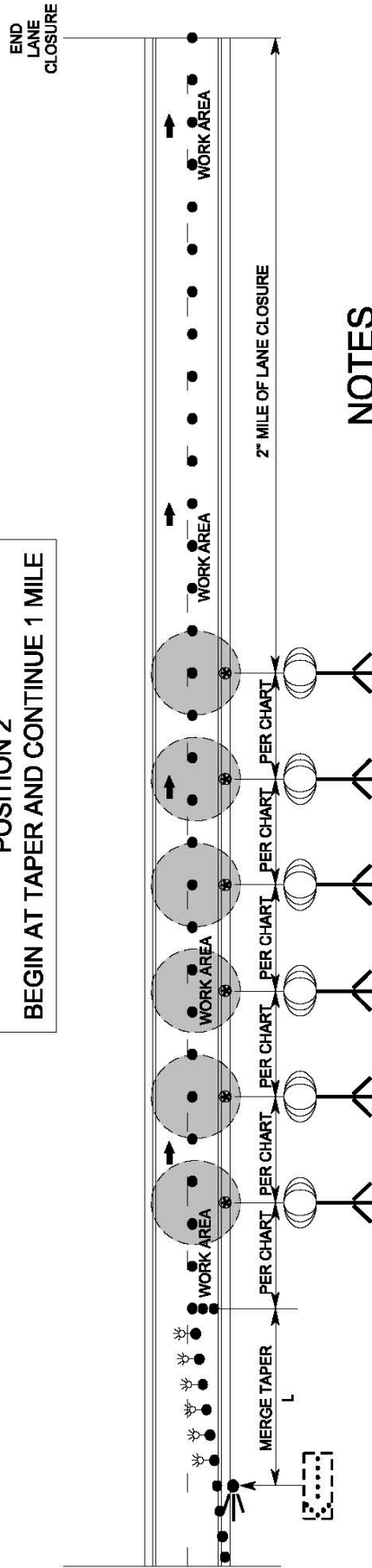

NOTES

- 1) WORK ZONE PRESENCE LIGHTING MAY BE OMITTED FOR THE ENTIRE LANE CLOSURE IF THE CONTRACTOR PROVIDES SUFFICIENT CONSTRUCTION/TASK LIGHTING TO MEET THE LUMINANCE REQUIREMENTS OF SECTION 1413-3 FOR THE FULL LENGTH OF THE LANE CLOSURE. IF EXISTING OVERHEAD ROADWAY LIGHTING IS FUNCTIONAL AND EXTENDS FOR THE FULL LENGTH OF THE LANE CLOSURE, OR AS DIRECTED BY THE ENGINEER.
- 2) PLACE ON PAVED OUTSIDE SHOULDER IF POSSIBLE.
- 3) IF THE LANE CLOSURE IS LONGER THAN 2 MILES USE ADDITIONAL PRESENCE LIGHTING AT THE RECOMMENDED SPACING. BEGIN INSTALLING WORK ZONE PRESENCE LIGHTING AT THE HALFWAY POINT OF THE LANE CLOSURE LENGTH FOR POSITION 1. POSITION 2 WILL BE THE FIRST HALF OF THE LANE CLOSURE LENGTH.

SPACING CHART

LIGHT OUTPUT (LUMENS)	MINIMUM LIGHTED FIXTURE AREA (SQUARE FEET)	MAXIMUM SPACING (FEET)	MAXIMUM LIGHT UNITS (PER MILE)
14,000 TO 35,000	4	750	7
35,001 TO 60,000	5	1,000	5
ABOVE 60,000	6 AND GREATER	1,320	4

SEQUENTIAL FLASHING WARNING LIGHTS:

(10/08/2016)

Description

Furnish and install Sequential Flashing Warning Lights on drums used for merging tapers during nightly work activities on interstates and freeways with speed limits greater than 55 MPH and or facilities that have significant traffic volumes.

The purpose of these lights is to assist the motorist in determining which direction to merge when approaching a lane closure. It's also designed to reduce the number of late merges resulting in devices being struck and having to be reset to maintain positive guidance at the merge point. The successive flashing of the lights shall occur from the upstream end of the merging taper to the downstream end of the merging taper in order to identify the desired vehicle path.

Materials

The Sequential Flashing Warning Lights shall meet all of the requirements for warning lights within the current edition of the Manual of Uniform Traffic Control Devices (MUTCD).

Each light unit shall be capable of operating fully and continuously for a minimum of 200 hours when equipped with a standard battery set.

Each light in the sequence shall be flashed at a rate of not less than 55 times per minute and not more than 75 times per minute. The flash rate and flash duration shall be consistent throughout the sequence.

Supply a Type 3 Certification (Independent Test Lab results) documenting all actual test results for the specified parameters contained in the Institute of Transportation Engineer's (ITE's) *Purchase Specification for Flashing and Steady Burn Warning Lights*. The laboratory shall also identify all manufacturer codes and part numbers for the incandescent lamp or LED clusters, lenses, battery, and circuitry, and the total width of the light with the battery in place. The complete assembly shall be certified as crashworthy when firmly affixed to the channelizing device.

All Sequential Flashing Warning Lights shall be on the NCDOT Work Zone Traffic Control Approved Products List.

Construction Methods

Sequential Flashing Warning Lights are to be used for night time lane closures.

These lights shall flash sequentially beginning with the first light and continuing until the final light.

The Sequential Flashing Warning Lights shall automatically flash in sequence when placed on the drums that form the merging taper.

TC-23

I-5811

Guilford County

The number of lights used in the drum taper shall equal the number of drums used in the taper.

Drums are the only channelizing device allowed to mount sequential flashing warning lights.

The Sequential Flashing Warning Lights shall be weather independent and visual obstructions shall not interfere with the operation of the lights.

The Sequential Flashing Warning Lights shall automatically sequence when placed in line in an open area with a distance between lights of 10 to 100 feet. A 10 foot stagger in the line of lights shall have no adverse effect on the operation of the lights.

If one light fails, the flashing sequence shall continue. If more than 1 light fails, all of the lights are to be automatically turned to the "off" mode. Non-sequential flashing is prohibited.

When lane closures are not in effect, the Sequential Flashing Warning Lights shall be deactivated.

Measurement and Payment

Sequential Flashing Warning Lights will be measured and paid as the maximum number of sequential flashing warning lights satisfactorily installed and properly functioning at any one time during the life of the project.

This includes all materials and labor to install, maintain and remove all the Sequential Flashing Warning Lights.

Pay Item

Sequential Flashing Warning Lights

Pay Unit

Each

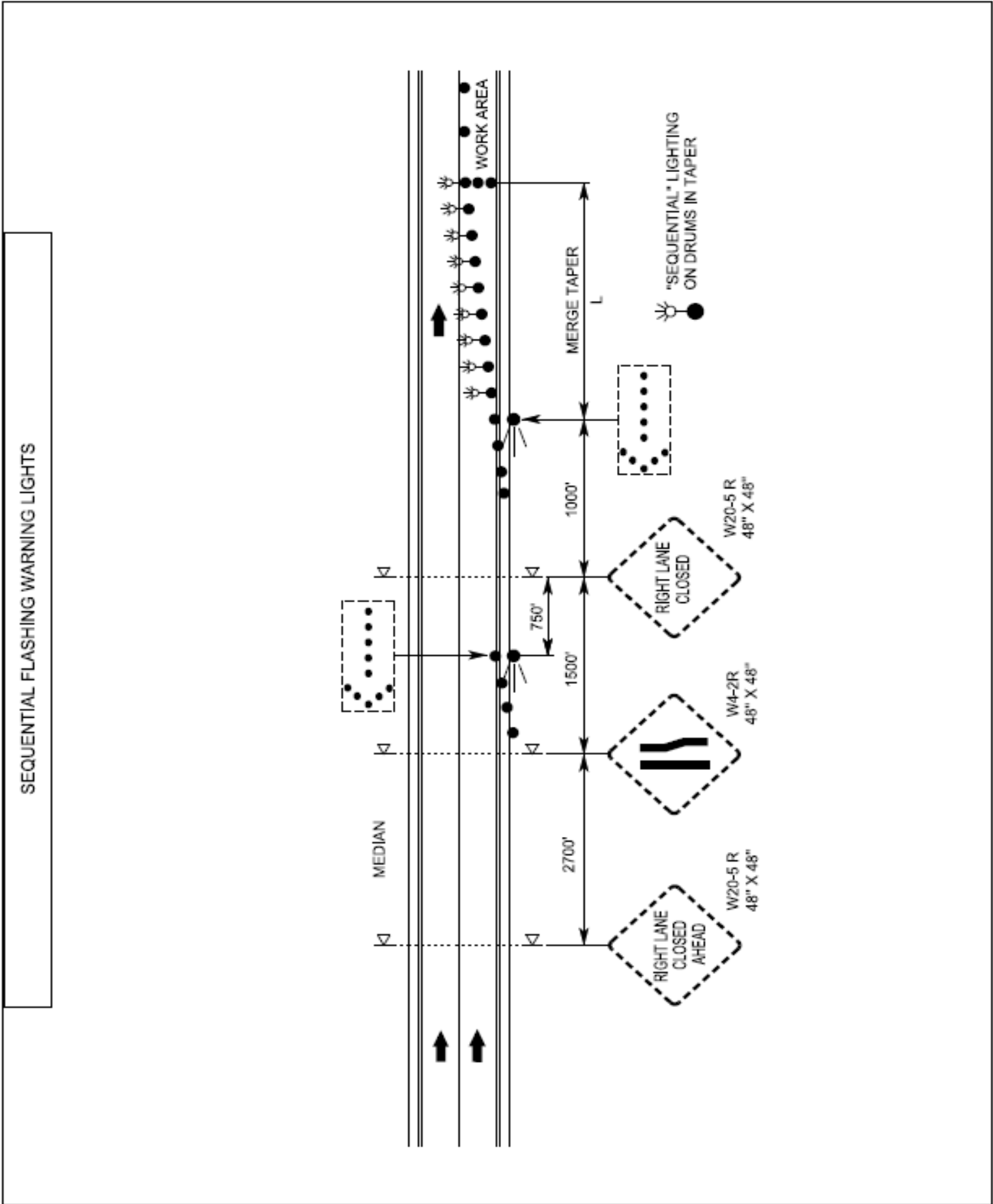

EC-1

STABILIZATION REQUIREMENTS:

(3-11-16)

S-1

Stabilization for this project shall comply with the time frame guidelines as specified by the NCG-010000 general construction permit effective August 3, 2011 issued by the North Carolina Department of Environment and Natural Resources Division of Water Quality. Temporary or permanent ground cover stabilization shall occur within 7 calendar days from the last land-disturbing activity, with the following exceptions in which temporary or permanent ground cover shall be provided in 14 calendar days from the last land-disturbing activity:

- Slopes between 2:1 and 3:1, with a slope length of 10 ft. or less
- Slopes 3:1 or flatter, with a slope of length of 50 ft. or less
- Slopes 4:1 or flatter

The stabilization timeframe for High Quality Water (HQW) Zones shall be 7 calendar days with no exceptions for slope grades or lengths. High Quality Water Zones (HQW) Zones are defined by North Carolina Administrative Code 15A NCAC 04A.0105 (25). Temporary and permanent ground cover stabilization shall be achieved in accordance with the provisions in this contract and as directed.

SEEDING AND MULCHING:

(East)

The kinds of seed and fertilizer, and the rates of application of seed, fertilizer, and limestone, shall be as stated below. During periods of overlapping dates, the kind of seed to be used shall be determined. All rates are in pounds per acre.

All Roadway Areas

March 1 - August 31		September 1 - February 28	
50#	Tall Fescue	50#	Tall Fescue
10#	Centipede	10#	Centipede
25#	Bermudagrass (hulled)	35#	Bermudagrass (unhulled)
500#	Fertilizer	500#	Fertilizer
4000#	Limestone	4000#	Limestone

Waste and Borrow Locations

March 1 - August 31		September 1 - February 28	
75#	Tall Fescue	75#	Tall Fescue
25#	Bermudagrass (hulled)	35#	Bermudagrass (unhulled)
500#	Fertilizer	500#	Fertilizer
4000#	Limestone	4000#	Limestone

Note: 50# of Bahiagrass may be substituted for either Centipede or Bermudagrass only upon Engineer's request.

EC-2

Approved Tall Fescue Cultivars

06 Dust	Escalade	Justice	Scorpion
2 nd Millennium	Essential	Kalahari	Serengeti
3 rd Millennium	Evergreen 2		Shelby
Apache III	Falcon IV	Kitty Hawk 2000	Sheridan
Avenger	Falcon NG	Legitimate	Signia
Barlexas	Falcon V	Lexington	Silver Hawk
Barlexas II	Faith	LSD	Sliverstar
Bar Fa	Fat Cat	Magellan	Shenandoah Elite
Barrera	Festnova	Matador	Sidewinder
Barrington	Fidelity	Millennium SRP	Skyline
Barrobusto	Finelawn Elite	Monet	Solara
Barvado	Finelawn Xpress	Mustang 4	Southern Choice II
Biltmore	Finesse II	Ninja 2	Speedway
Bingo	Firebird	Ol' Glory	Spyder LS
Bizem	Firecracker LS	Olympic Gold	Sunset Gold
Blackwatch	Firenza	Padre	Taccoa
Blade Runner II	Five Point	Patagonia	Tanzania
Bonsai	Focus	Pedigree	Trio
Braveheart	Forte	Picasso	Tahoe II
Bravo	Garrison	Piedmont	Talladega
Bullseye	Gazelle II	Plantation	Tarheel
Cannavaro	Gold Medallion	Proseeds 5301	Terrano
Catalyst	Grande 3	Prospect	Titan ltd
Cayenne	Greenbrooks	Pure Gold	Titanium LS
Cessane Rz	Greenkeeper	Quest	Tracer
Chipper	Gremlin	Raptor II	Traverse SRP
Cochise IV	Greystone	Rebel Exeda	Tulsa Time
Constitution	Guardian 21	Rebel Sentry	Turbo
Corgi	Guardian 41	Rebel IV	Turbo RZ
Corona	Hemi	Regiment II	Tuxedo RZ
Coyote	Honky Tonk	Regenerate	Ultimate
Darlington	Hot Rod	Rendition	Venture
Davinci	Hunter	Rhambler 2 SRP	Umbrella
Desire	Inferno	Rembrandt	Van Gogh
Dominion	Innovator	Reunion	Watchdog
Dynamic	Integrity	Riverside	Wolfpack II
Dynasty	Jaguar 3	RNP	Xtremegreen
Endeavor	Jamboree	Rocket	

EC-3

On cut and fill slopes 2:1 or steeper Centipede shall be applied at the rate of 5 pounds per acre and add 20# of Sericea Lespedeza from January 1 - December 31.

Fertilizer shall be 10-20-20 analysis. A different analysis of fertilizer may be used provided the 1-2-2 ratio is maintained and the rate of application adjusted to provide the same amount of plant food as a 10-20-20 analysis and as directed.

EC-4

WATTLE:

(10-19-10) (Rev. 1-17-12)

1060,1630,1631

T1

Description

Wattles are tubular products consisting of excelsior fibers encased in synthetic netting. Wattles are used on slopes or channels to intercept runoff and act as a velocity break. Wattles are to be placed at locations shown on the plans or as directed. Installation shall follow the detail provided in the plans and as directed. Work includes furnishing materials, installation of wattles, matting installation, and removing wattles.

Materials

Wattle shall meet the following specifications:

100% Curled Wood(Excelsior) Fibers	
Minimum Diameter	12 in.
Minimum Density	2.5 lb/ft ³ +/- 10%
Net Material	Synthetic
Net Openings	1 in. x 1 in.
Net Configuration	Totally Encased
Minimum Weight	20 lb. +/- 10% per 10 ft. length

Stakes shall be used as anchors.

Provide hardwood stakes a minimum of 2 feet long with a 2 inch x 2 inch nominal square cross section. One end of the stake must be sharpened or beveled to facilitate driving down into the underlying soil.

Matting shall meet the requirements of Article 1060-8 of the *2018 Standard Specifications*, or shall meet specifications provided elsewhere in this contract.

Provide staples made of 0.125 inch diameter new steel wire formed into a *u* shape not less than 12 inches in length with a throat of 1 inch in width.

Construction Methods

Wattles shall be secured to the soil by wire staples approximately every 1 linear foot and at the end of each section of wattle. A minimum of 4 stakes shall be installed on the downstream side of the wattle with a maximum spacing of 2 linear feet along the wattle, and according to the detail. Install a minimum of 2 stakes on the upstream side of the wattle according to the detail provided in the plans. Stakes shall be driven into the ground a minimum of 10 inches with no more than 2 inches projecting from the top of the wattle. Drive stakes at an angle according to the detail provided in the plans.

EC-5

Only install wattle(s) to a height in ditch so flow will not wash around wattle and scour ditch slopes and according to the detail provided in the plans and as directed. Overlap adjoining sections of wattles a minimum of 6 inches.

Installation of matting shall be in accordance with the detail provided in the plans, and in accordance with Article 1631-3 of the *2018 Standard Specifications*, or in accordance with specifications provided elsewhere in this contract.

The Contractor shall maintain the wattles until the project is accepted or until the wattles are removed, and shall remove and dispose of silt accumulations at the wattles when so directed in accordance with the requirements of Section 1630 of the *2018 Standard Specifications*.

Measurement and Payment

Wattle will be measured and paid for by the actual number of linear feet of wattles which are installed and accepted. Such price and payment will be full compensation for all work covered by this section, including, but not limited to, furnishing all materials, labor, equipment and incidentals necessary to install the *Wattle*.

Matting will be measured and paid for in accordance with Article 1631-4 of the *2018 Standard Specifications*, or in accordance with specifications provided elsewhere in this contract.

Payment will be made under:

Pay Item	Pay Unit
Wattle	Linear Foot

County : Guilford

Line #	Item Number	Sec #	Description	Quantity	Unit Cost	Amount
ROADWAY ITEMS						
0001	0000100000-N	800	MOBILIZATION	Lump Sum	L.S.	
0002	1220000000-E	545	INCIDENTAL STONE BASE	114 TON		
0003	1297000000-E	607	MILLING ASPHALT PAVEMENT, **** DEPTH (1½")	418,520 SY		
0004	1308000000-E	607	MILLING ASPHALT PAVEMENT, **** TO ***** (0" TO ¾")	125 SY		
0005	1330000000-E	607	INCIDENTAL MILLING	10,620 SY		
0006	1523000000-E	610	ASPHALT CONC SURFACE COURSE, TYPE S9.5C	3,895 TON		
0007	1524200000-E	610	ASPHALT CONC SURFACE COURSE, TYPE S9.5D	31,327 TON		
0008	1575000000-E	620	ASPHALT BINDER FOR PLANT MIX	234 TON		
0009	1577000000-E	620	POLYMER MODIFIED ASPHALT BIN- DER FOR PLANT MIX	2,413 TON		
0010	1662000000-E	650	OPEN-GRADED ASPHALT FRICTION COURSE, TYPE FC-1 MODIFIED	10,251 TON		
0011	1704000000-E	SP	PATCHING EXISTING PAVEMENT	115 TON		
0012	1840000000-E	665	MILLED RUMBLE STRIPS (ASPHALT CONCRETE)	97,374 LF		
0013	2275000000-E	SP	FLOWABLE FILL	3 CY		
0014	2473000000-N	SP	GENERIC DRAINAGE ITEM REMOVE AND REPLACE CONCRETE APRON	1 EA		
0015	2613000000-N	848	REMOVE AND REPLACE CURB RAMPS	4 EA		
0016	4400000000-E	1110	WORK ZONE SIGNS (STATIONARY)	700 SF		
0020	4420000000-N	1120	PORTABLE CHANGEABLE MESSAGE SIGN	2 EA		

County : Guilford

Line #	Item Number	Sec #	Description	Quantity	Unit Cost	Amount
0022	4423000000-N	SP	WORK ZONE DIGITAL SPEED LIMIT SIGNS	5 EA		
0023	4424000000-N	SP	WORK ZONE PRESENCE LIGHTING	15 EA		
0024	4430000000-N	1130	DRUMS	50 EA		
0025	4434000000-N	SP	SEQUENTIAL FLASHING WARNING LIGHTS	36 EA		
0028	4688000000-E	1205	THERMOPLASTIC PAVEMENT MARKING LINES (6", 90 MILS)	116,347 LF		
0029	4690000000-E	1205	THERMOPLASTIC PAVEMENT MARKING LINES (6", 120 MILS)	27,217 LF		
0030	4697000000-E	1205	THERMOPLASTIC PAVEMENT MARKING LINES (8", 120 MILS)	596 LF		
0031	4700000000-E	1205	THERMOPLASTIC PAVEMENT MARKING LINES (12", 90 MILS)	8,211 LF		
0032	4702000000-E	1205	THERMOPLASTIC PAVEMENT MARKING LINES (12", 120 MILS)	8,855 LF		
0033	4710000000-E	1205	THERMOPLASTIC PAVEMENT MARKING LINES (24", 120 MILS)	240 LF		
0034	4721000000-E	1205	THERMOPLASTIC PAVEMENT MARKING CHARACTER (120 MILS)	80 EA		
0035	4725000000-E	1205	THERMOPLASTIC PAVEMENT MARKING SYMBOL (90 MILS)	104 EA		
0036	4815000000-E	1205	PAINT PAVEMENT MARKING LINES (6")	265,552 LF		
0037	4820000000-E	1205	PAINT PAVEMENT MARKING LINES (8")	596 LF		
0038	4825000000-E	1205	PAINT PAVEMENT MARKING LINES (12")	32,995 LF		
0039	4835000000-E	1205	PAINT PAVEMENT MARKING LINES (24")	240 LF		

County : Guilford

Line #	Item Number	Sec #	Description	Quantity	Unit Cost	Amount
0040	4840000000-N	1205	PAINT PAVEMENT MARKING CHARACTER	144 EA		
0041	4845000000-N	1205	PAINT PAVEMENT MARKING SYMBOL	126 EA		
0042	4847030000-E	1205	POLYUREA PAVEMENT MARKING LINES (6", 20 MILS)	2,938 LF		
0043	4847070000-E	1205	POLYUREA PAVEMENT MARKING LINES (12", 20 MILS)	165 LF		
0044	4855000000-E	1205	REMOVAL OF PAVEMENT MARKING LINES (6")	3,103 LF		
0045	4890000000-E	SP	GENERIC PAVEMENT MARKING ITEM HOT SPRAY THERMOPLASTIC PAVEMENT MARKING LINES, 6" 50 MILS	121,987 LF		
0046	4890000000-E	SP	GENERIC PAVEMENT MARKING ITEM HOT SPRAY THERMOPLASTIC PAVEMENT MARKING LINES,12" 50 MILS	16,802 LF		
0047	4905000000-N	1253	SNOWPLOWABLE PAVEMENT MARKERS	2,962 EA		
0048	4960000000-N	SP	GENERIC TRAFFIC CONTROL ITEM REPLACE EXISTING BARRIER DELINEATOR	537 EA		
0049	5255000000-N	1413	PORTABLE LIGHTING	Lump Sum	L.S.	
0050	6071010000-E	SP	WATTLE	80 LF		
0051	7444000000-E	1725	INDUCTIVE LOOP SAWCUT	3,100 LF		
0052	4600000000-N	SP	GENERIC TRAFFIC CONTROL ITEM LANE CLOSURE	165 EA		
0053	4600000000-N	SP	GENERIC TRAFFIC CONTROL ITEM RAMP/LOOP CLOSURE	12 EA		