

**This electronic collection of documents is provided
for the convenience of the user
and is Not a Certified Document –**

**The documents contained herein were originally issued
and sealed by the individuals whose names and license
numbers appear on each page, on the dates appearing
with their signature on that page.**

**This file or an individual page
shall not be considered a certified document.**

STATE OF NORTH CAROLINA
DIVISION OF HIGHWAYS

PROJ. REFERENCE NO.	SHEET NO.
B-4932	X-1A

NOTE: EMBANKMENT COLUMN DOES NOT INCLUDE BACKFILL FOR UNDERCUT

CROSS-SECTION SUMMARY

Station	Uncl. Exc.	Embt	Station	Uncl. Exc.	Embt
L	(cu. yd.)	(cu. yd.)	Drw1	(cu. yd.)	(cu. yd.)
12+00.00	0	0	10+35.00	0	0
12+50.00	12	19	10+50.00	0	57
13+00.00	21	54	10+75.00	0	315
13+50.00	32	75	11+00.00	0	449
14+00.00	39	146	11+50.00	0	708
14+50.00	16	306	12+00.00	0	484
15+00.00	1	390	12+50.00	2	308
15+50.00	1	296	13+00.00	2	181
16+00.00	0	197	13+50.00	20	72
16+50.00	0	181	13+68.00	10	0
17+00.00	0	199			
17+50.00	0	232	Station	Uncl. Exc.	Embt
18+00.00	0	267			
18+50.00	0	510	Drw2	(cu. yd.)	(cu. yd.)
19+00.00	0	1327	10+12.08	0	0
19+50.00	0	2163	10+50.00	0	90
20+00.00	0	2469	10+80.00	3	51
20+50.00	0	2610			
21+00.00	316	2706			
21+50.00	792	2694			
21+95.00	653	2534			
22+00.00	25	148			

Station	Uncl. Exc.	Embt
L	(cu. yd.)	(cu. yd.)
27+50.00	0	0
28+00.00	757	0
28+05.00	113	100
28+50.00	331	1660
29+00.00	0	1231
29+50.00	0	1055
30+00.00	0	1344
30+50.00	0	1302
31+00.00	0	1290
31+50.00	0	1294
32+00.00	0	1194
32+50.00	0	1100
33+00.00	0	971
33+50.00	0	749
34+00.00	0	546
34+50.00	0	463
35+00.00	0	439
35+50.00	0	342
36+00.00	0	457
36+50.00	0	607
37+00.00	0	484
37+50.00	1	338
38+00.00	4	238
38+10.00	1	20

INDEX OF SHEETS			
LINE		STATIONS	SHEETS
-L-	NC 42	12+00.00 TO 38+10.00	X-1 THRU X-13
-DRW1-	DRIVEWAY TO BOAT RAMP	10+35.00 TO 13+68.00	X-14 THRU X-15
-DRW2-	DRIVEWAY	10+12.08 TO 10+80.00	X-16

8/23/99

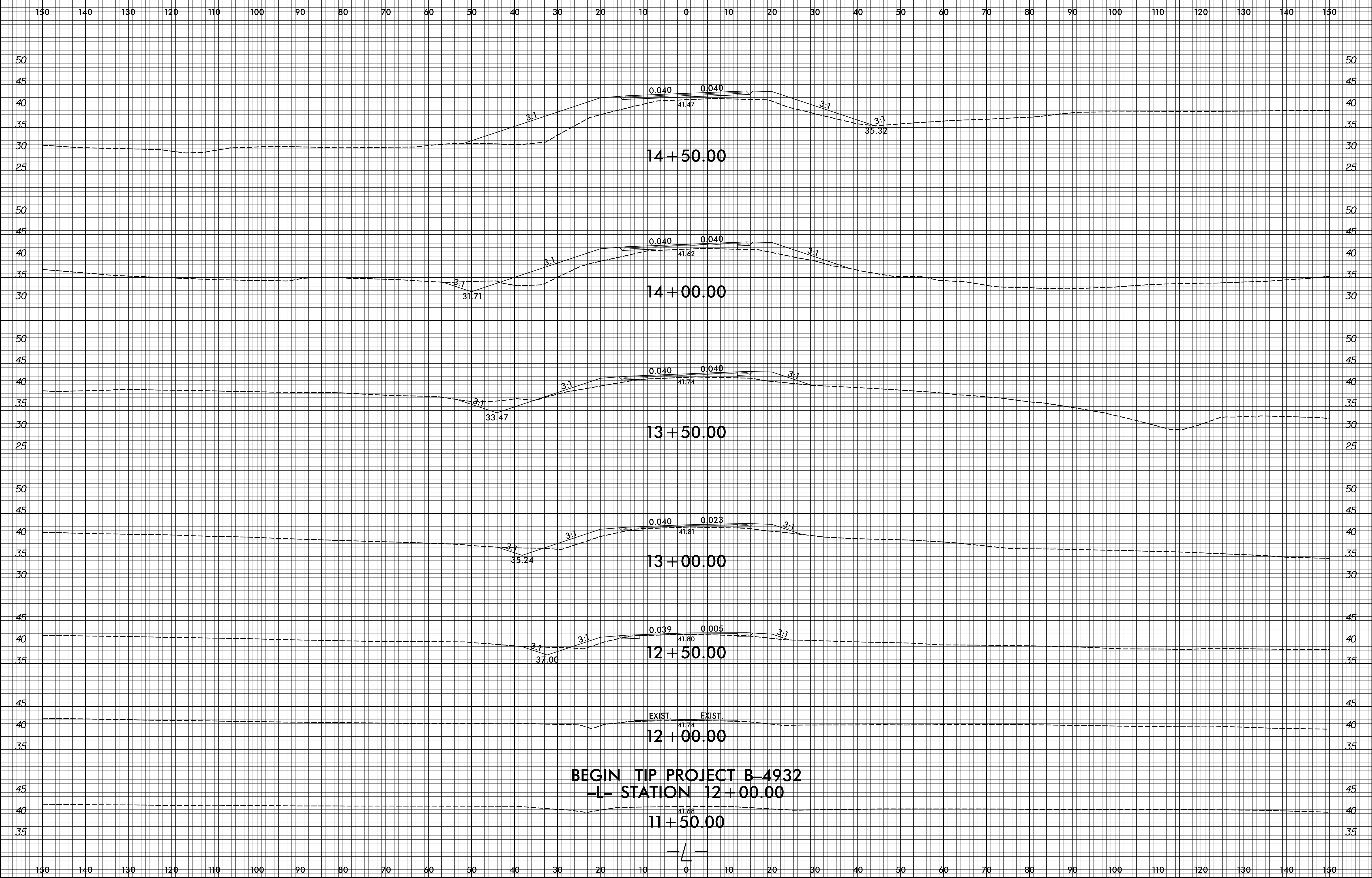

BEGIN TIP PROJECT B-4932
 -L- STATION 12 + 00.00

8/31/2017
B:\932\du_xp\l1.dgn
javeifarb

8/23/99

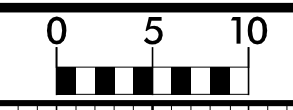

PROJ. REFERENCE NO.
B-4932

SHEET NO.
X-2

150 140 130 120 110 100 90 80 70 60 50 40 30 20 10 0 10 20 30 40 50 60 70 80 90 100 110 120 130 140 150

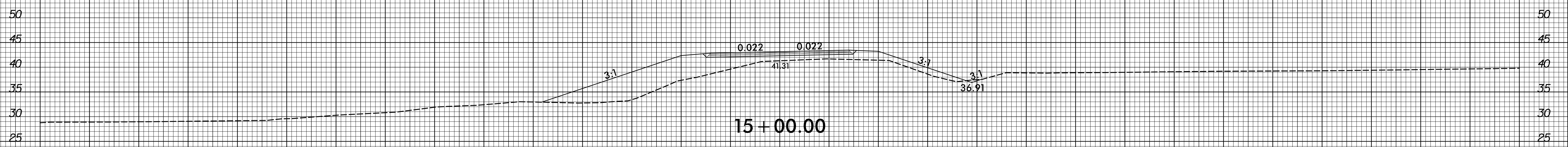
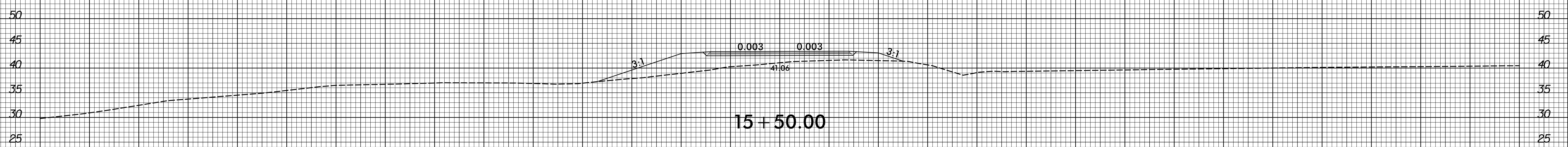
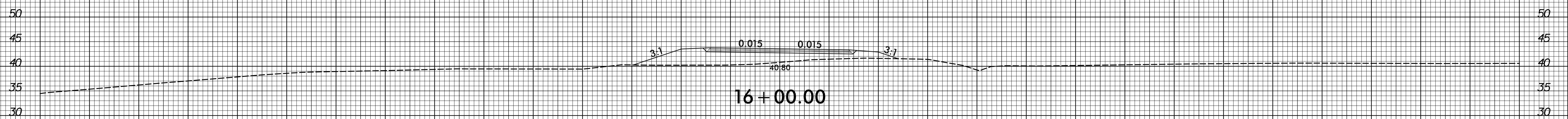
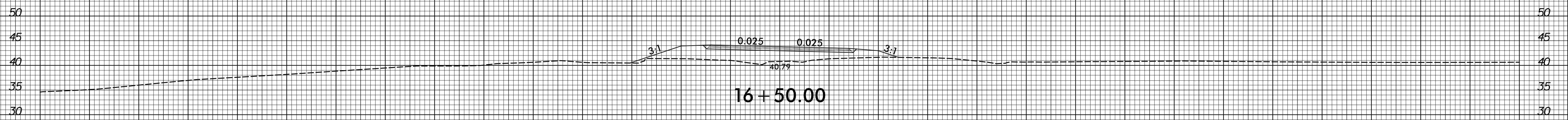
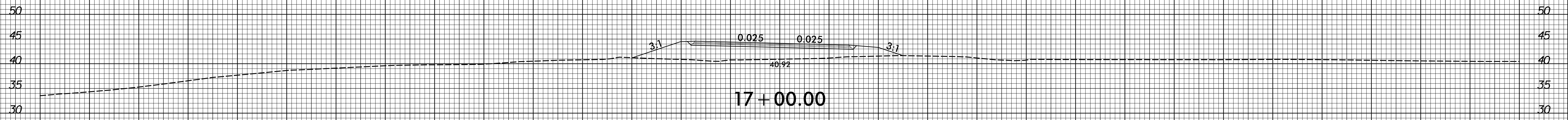
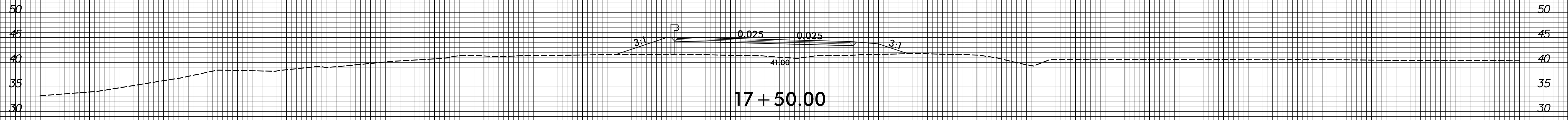

150 140 130 120 110 100 90 80 70 60 50 40 30 20 10 0 10 20 30 40 50 60 70 80 90 100 110 120 130 140 150

8/31/2017
B:\4932\dwg\xp1.dgn
jgavilana

8/23/99

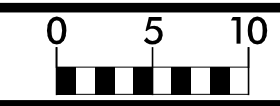

PROJ. REFERENCE NO.
B-4932

SHEET NO.
X-3

150 140 130 120 110 100 90 80 70 60 50 40 30 20 10 0 10 20 30 40 50 60 70 80 90 100 110 120 130 140 150

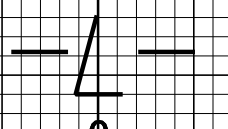
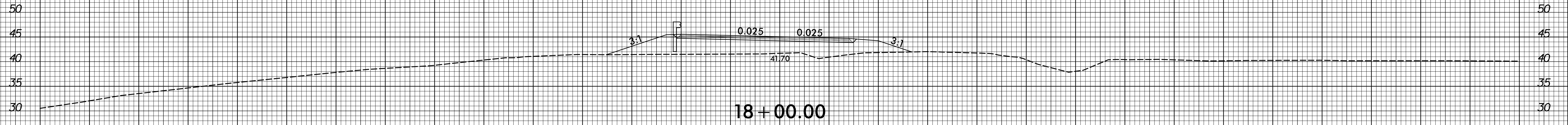
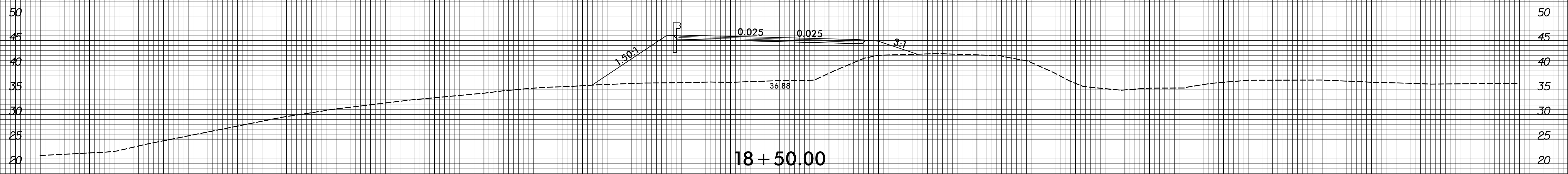
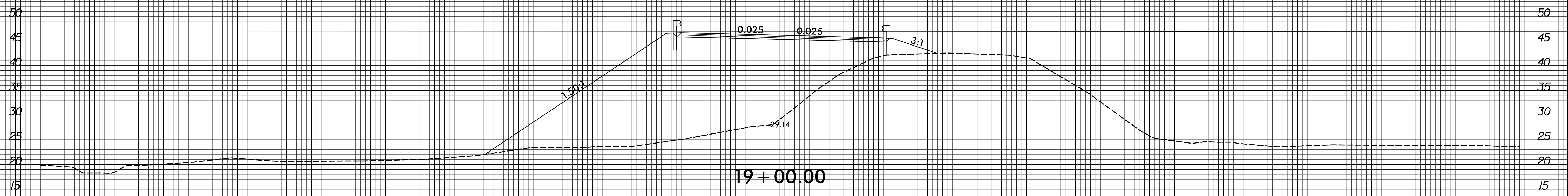
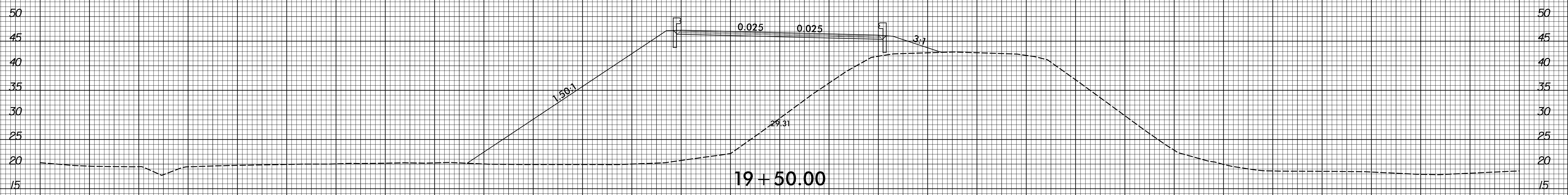

8/31/2017
B:\4932\du_xpl\1.dgn
jgavril@b

8/23/99

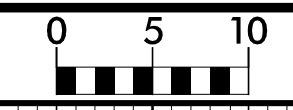

PROJ. REFERENCE NO.
B-4932

SHEET NO.
X-4

150 140 130 120 110 100 90 80 70 60 50 40 30 20 10 0 10 20 30 40 50 60 70 80 90 100 110 120 130 140 150

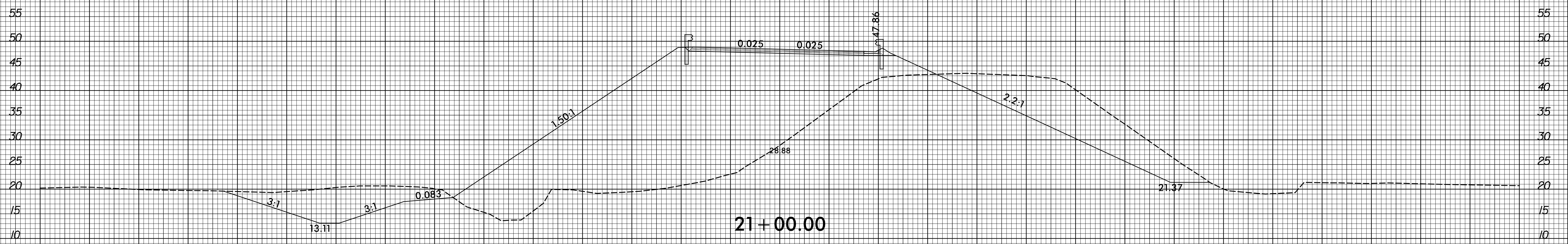

21+00.00

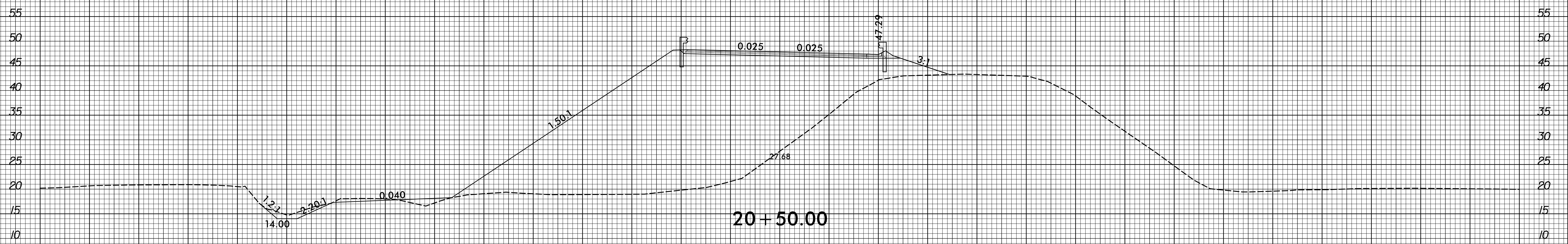

20+50.00

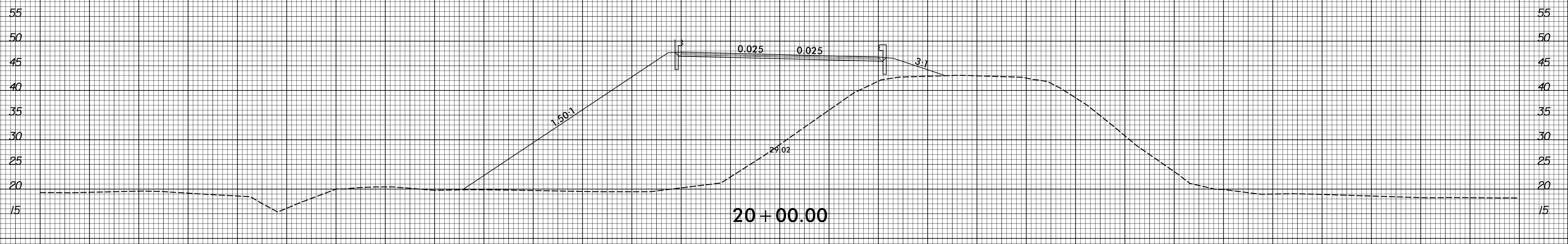

20+00.00

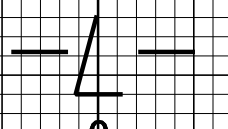

150 140 130 120 110 100 90 80 70 60 50 40 30 20 10 0 10 20 30 40 50 60 70 80 90 100 110 120 130 140 150

12/21/2017
B4932_rdy_xpl.dgn
BCEUSER

8/23/99

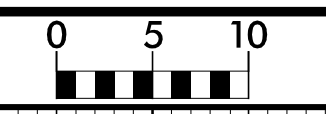

PROJ. REFERENCE NO. B-4932	SHEET NO. X-5
-------------------------------	------------------

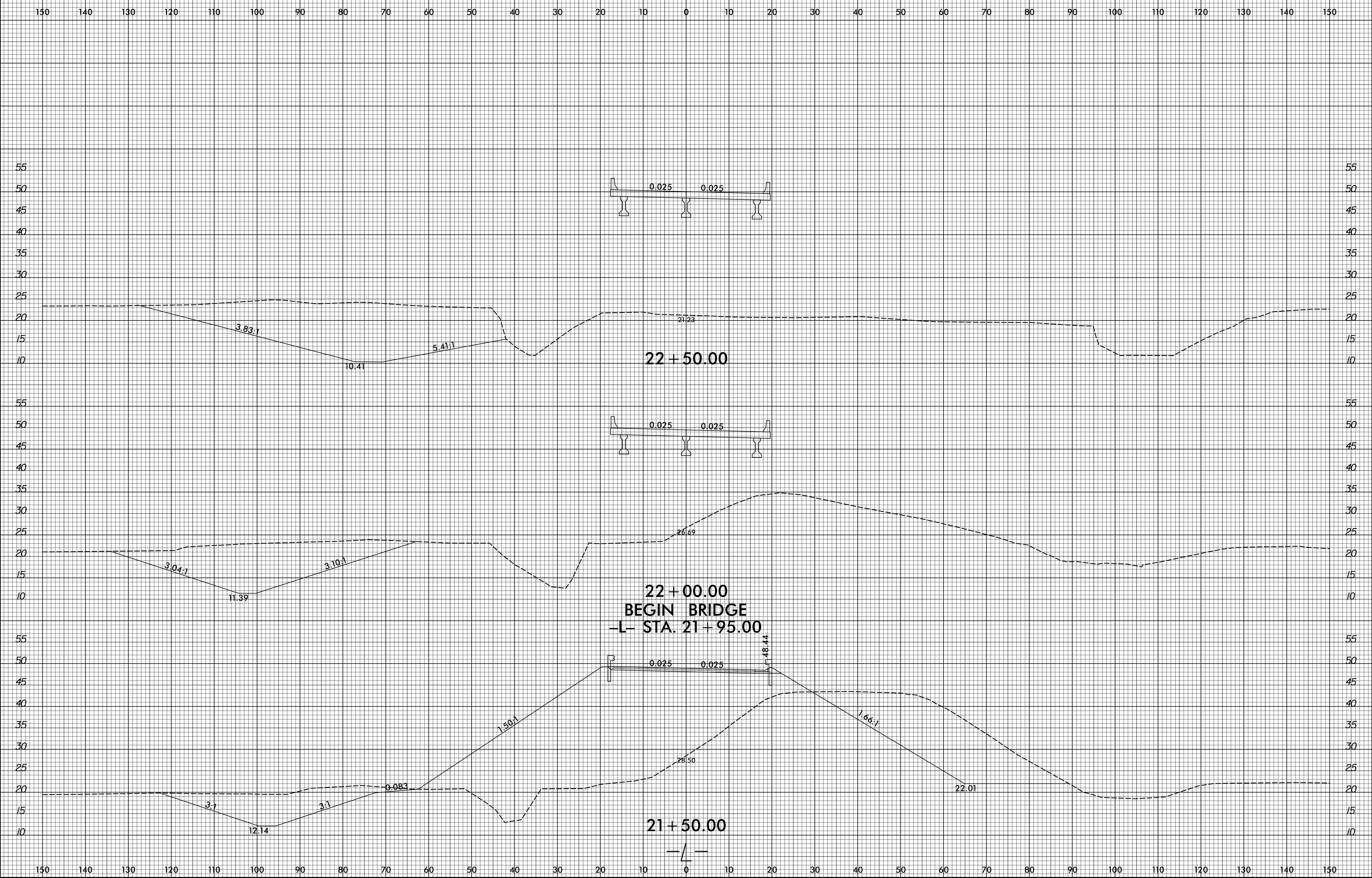

12/21/2017 3:49:32 PM rdy-xpl.lidgn

150 140 130 120 110 100 90 80 70 60 50 40 30 20 10 0 10 20 30 40 50 60 70 80 90 100 110 120 130 140 150

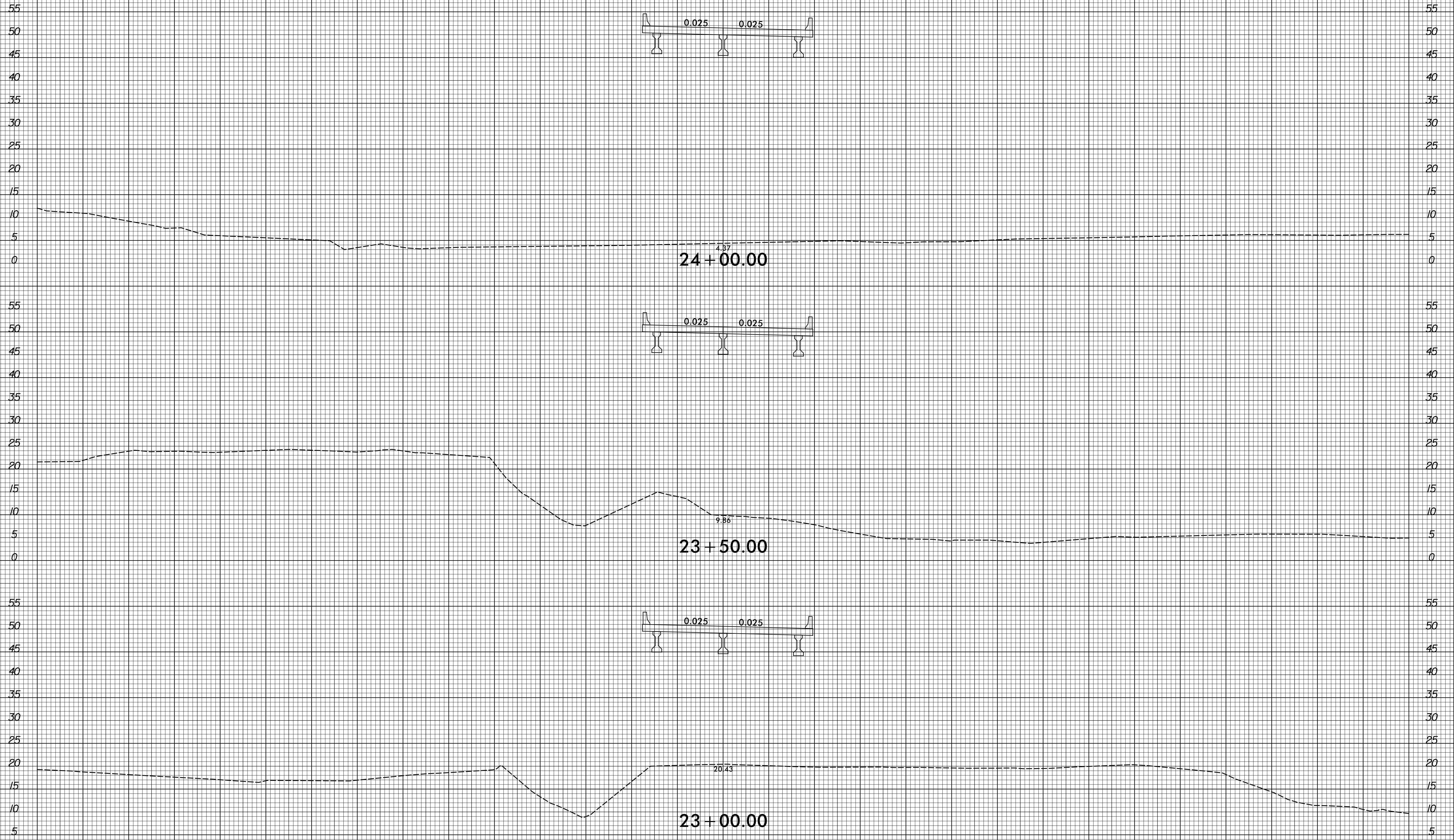

150 140 130 120 110 100 90 80 70 60 50 40 30 20 10 0 10 20 30 40 50 60 70 80 90 100 110 120 130 140 150

8/23/99

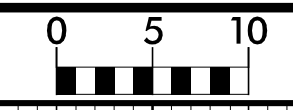

PROJ. REFERENCE NO.
B-4932

SHEET NO.
X-7

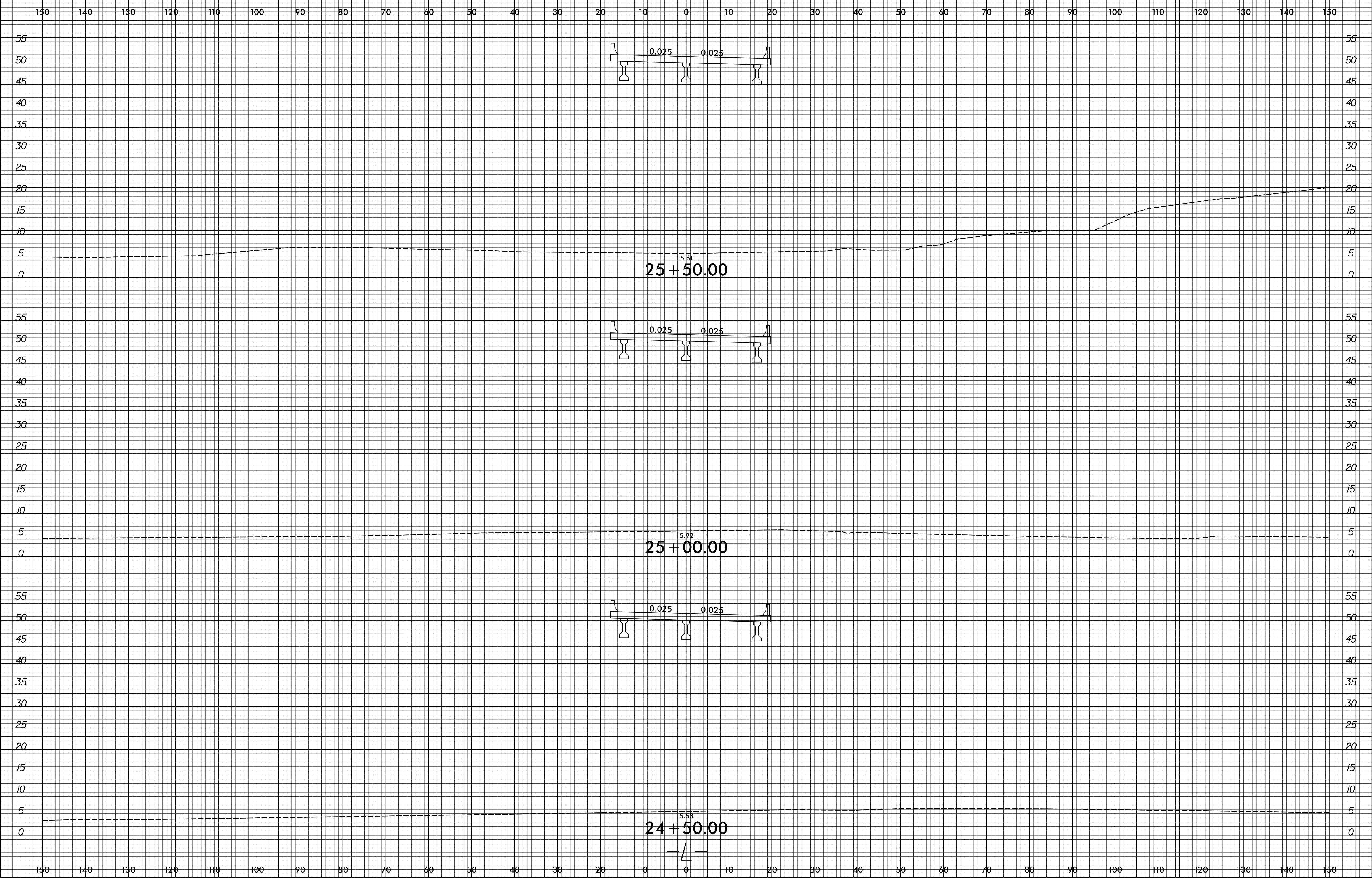

8/31/2017
B:\4932\dwg\pl1.dgn
jgavrilov

8/23/99

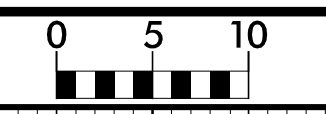

150 140 130 120 110 100 90 80 70 60 50 40 30 20 10 0 10 20 30 40 50 60 70 80 90 100 110 120 130 140 150

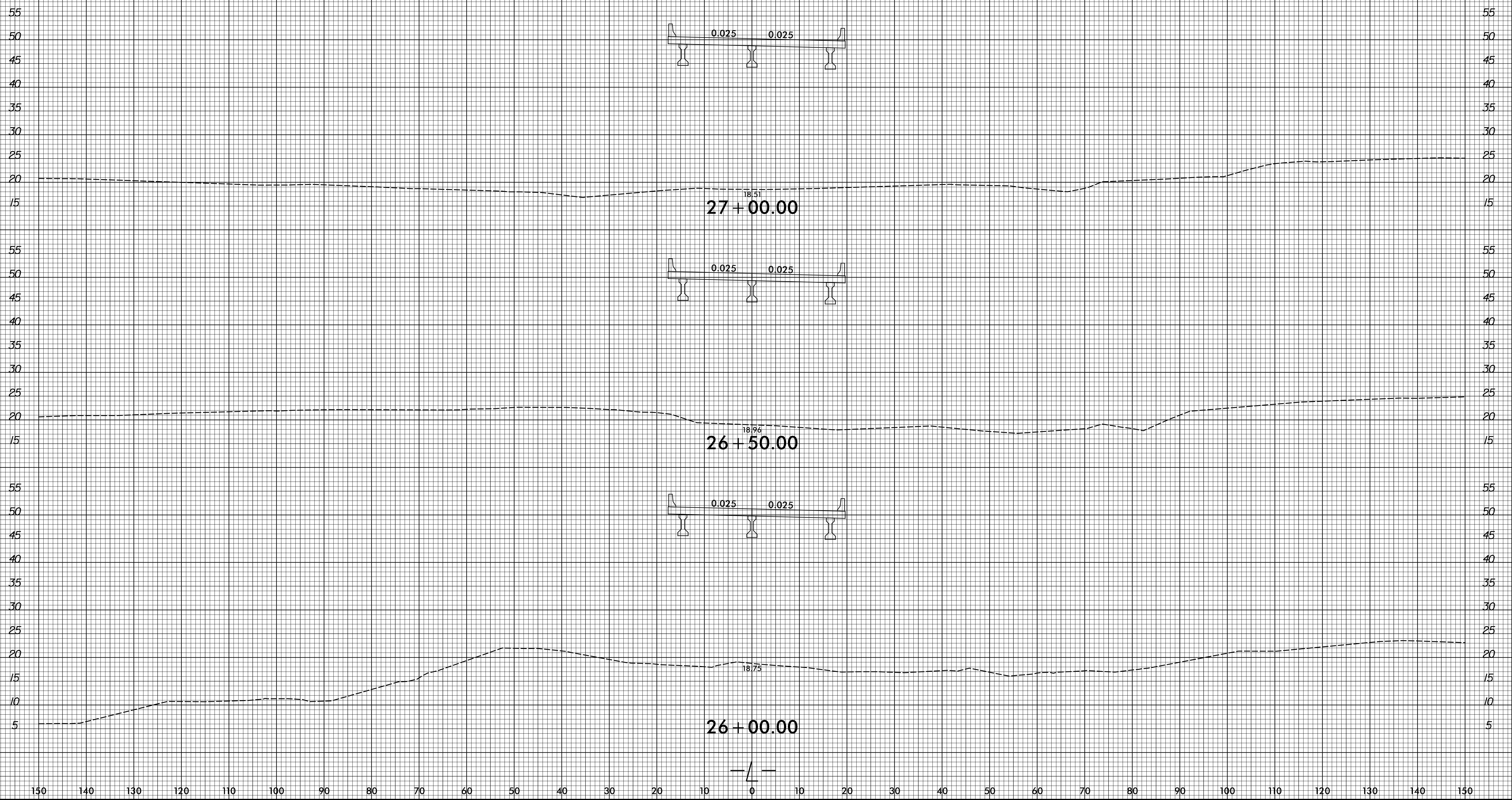

8/31/2017
B:\4932\dwg\xp1.i.dgn
Javali@ar

8/23/99

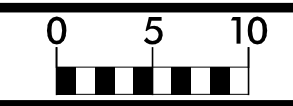

PROJ. REFERENCE NO.
B-4932

SHEET NO.
X-9

150 140 130 120 110 100 90 80 70 60 50 40 30 20 10 0 10 20 30 40 50 60 70 80 90 100 110 120 130 140 150

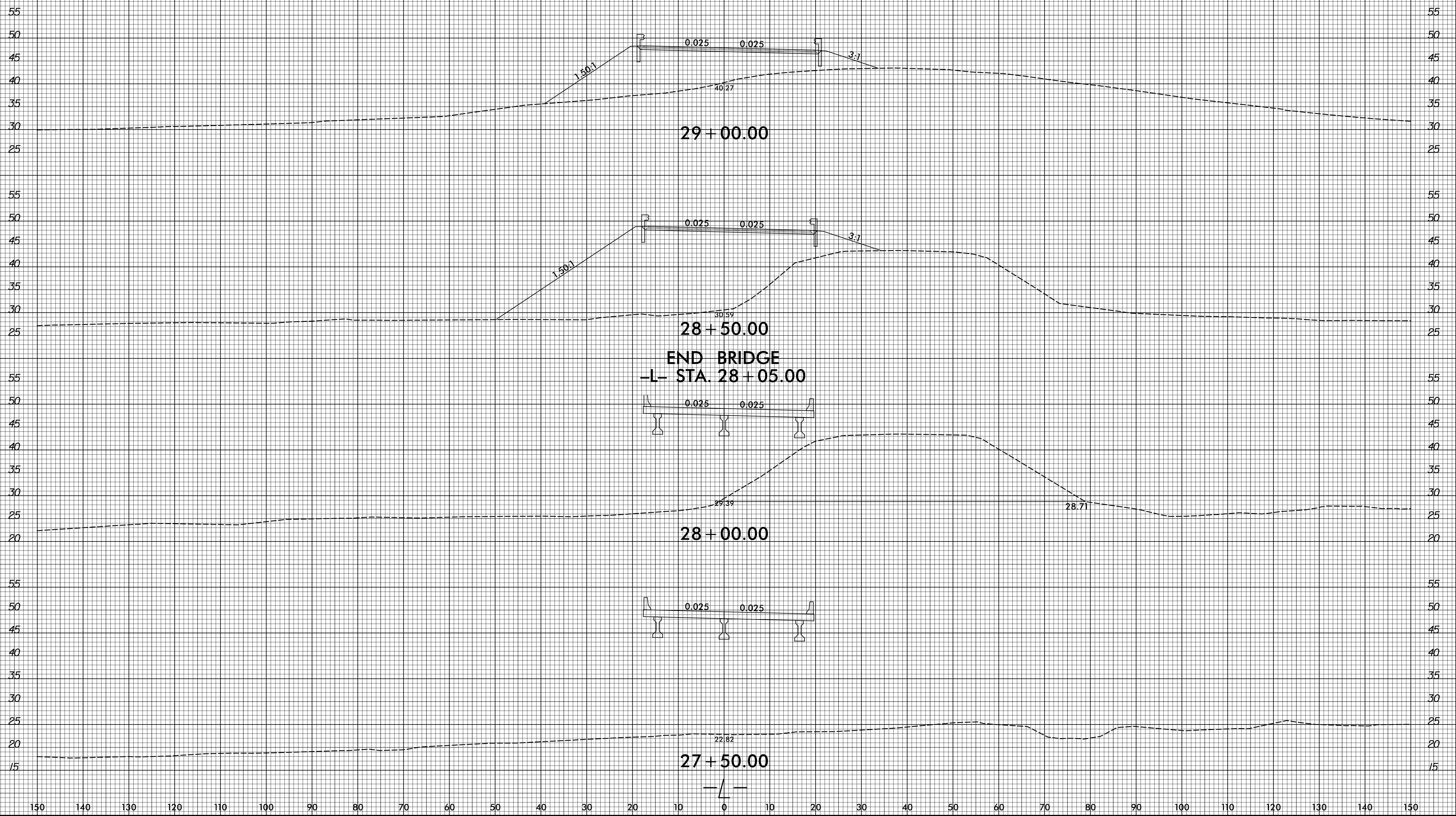

29 + 00.00

28 + 50.00

END BRIDGE
-L- STA. 28 + 05.00

28 + 00.00

27 + 50.00

8/31/2017
B:\9321\du_xp1.l.dgn
j.walsh

8/23/99

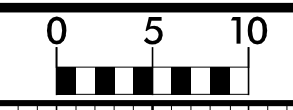

PROJ. REFERENCE NO.
B-4932

SHEET NO.
X-10

150 140 130 120 110 100 90 80 70 60 50 40 30 20 10 0 10 20 30 40 50 60 70 80 90 100 110 120 130 140 150

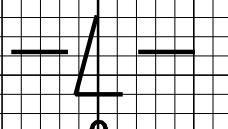
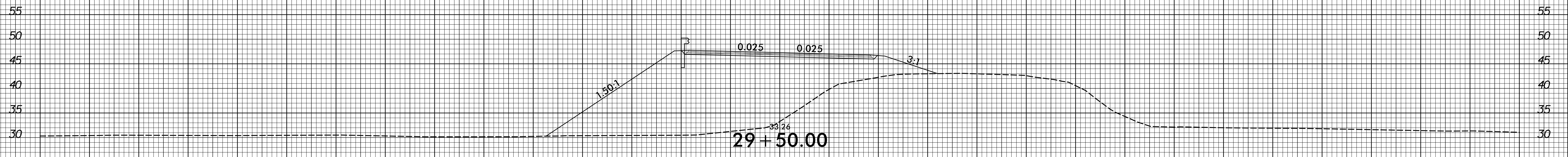
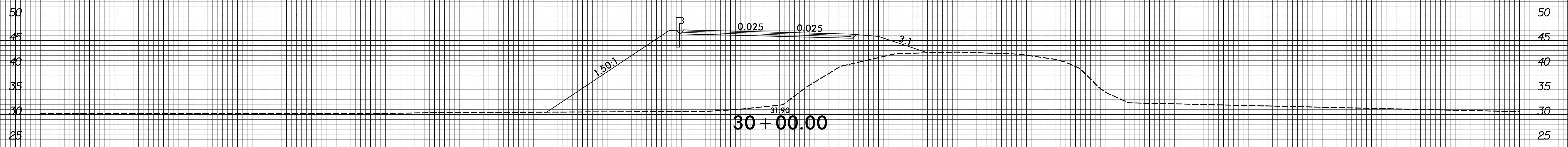
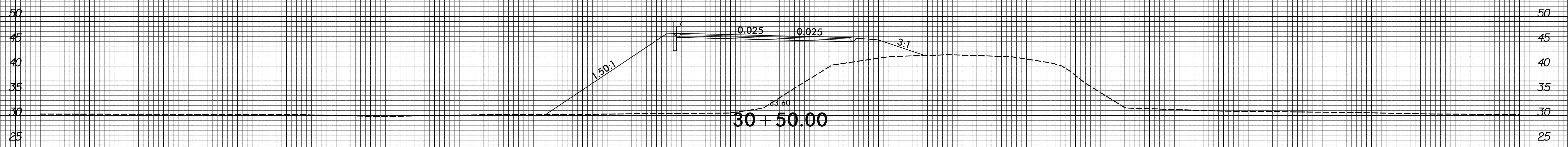
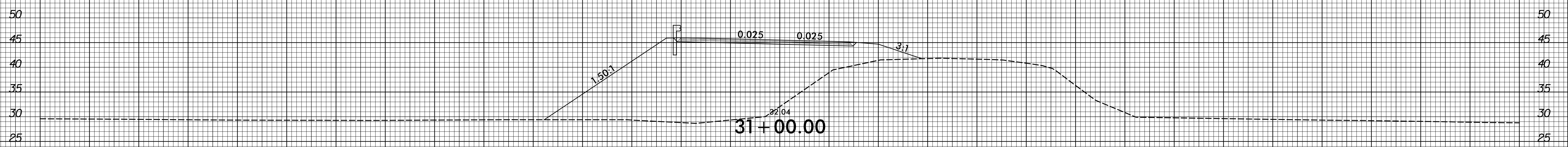
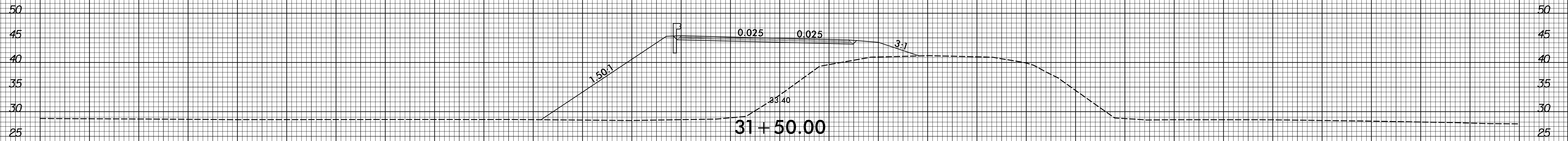

150 140 130 120 110 100 90 80 70 60 50 40 30 20 10 0 10 20 30 40 50 60 70 80 90 100 110 120 130 140 150

8/31/2017
B:\932\du_xp1.lidgn
J:\ave\jfab

8/23/99

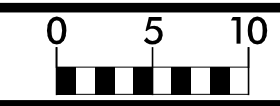

PROJ. REFERENCE NO.
B-4932

SHEET NO.
X-11

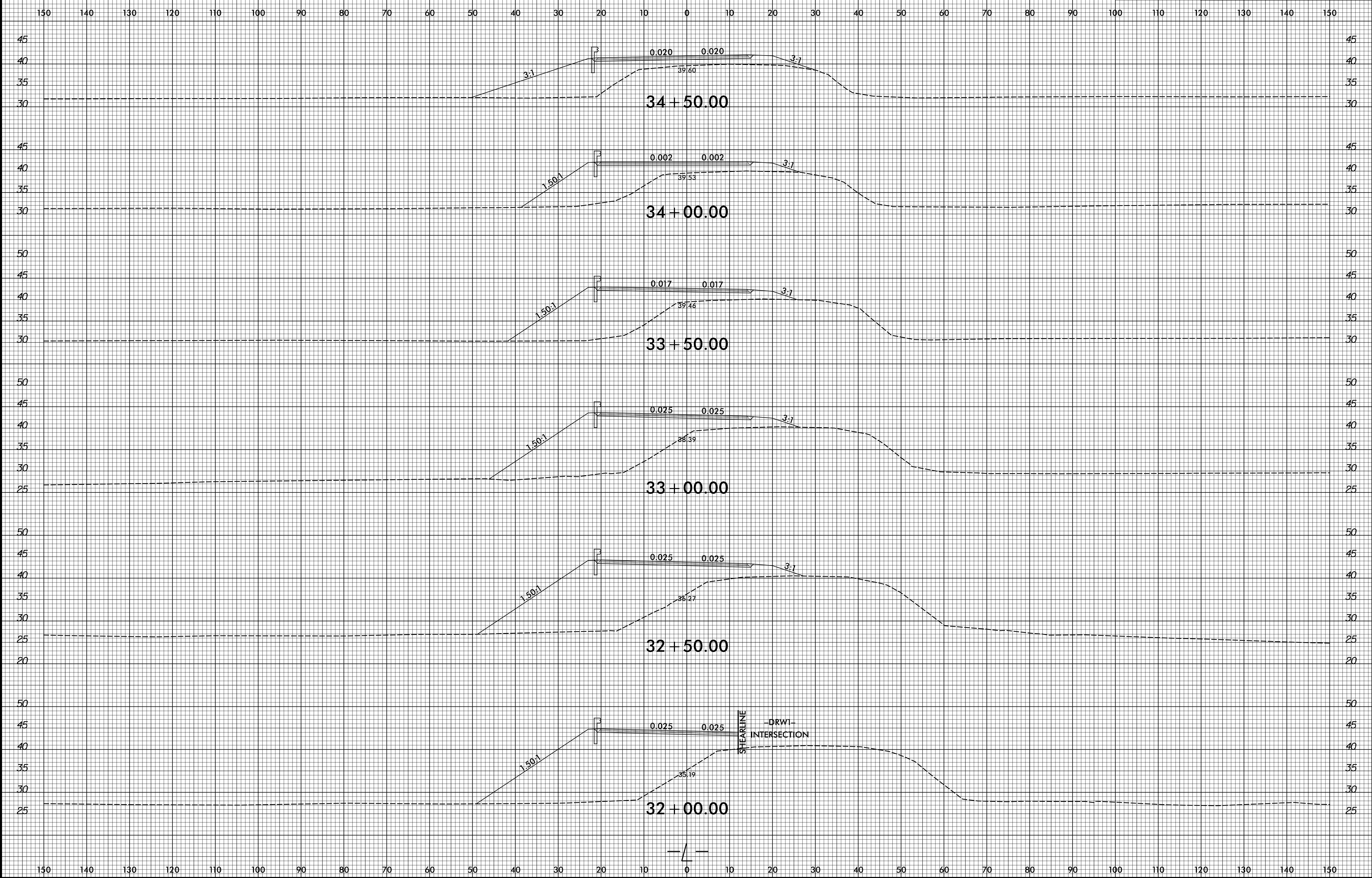

8/31/2017 8:49:22 du_xpl1.dgn

8/23/99

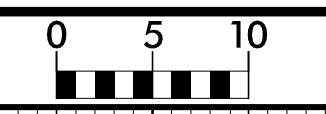

PROJ. REFERENCE NO. B-4932	SHEET NO. X-12
-------------------------------	-------------------

150 140 130 120 110 100 90 80 70 60 50 40 30 20 10 0 10 20 30 40 50 60 70 80 90 100 110 120 130 140 150

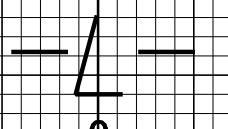
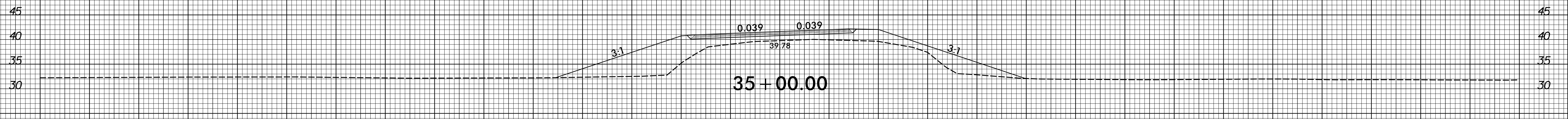
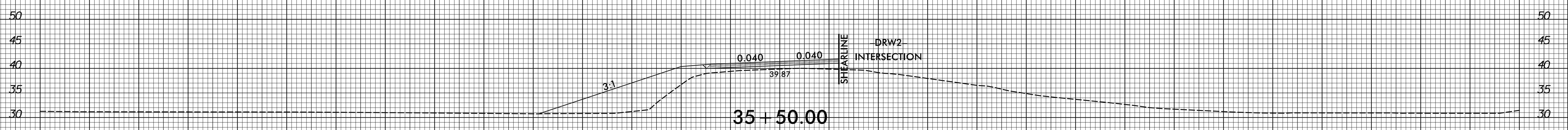
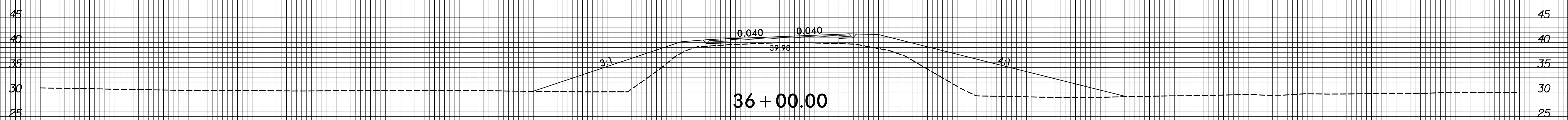
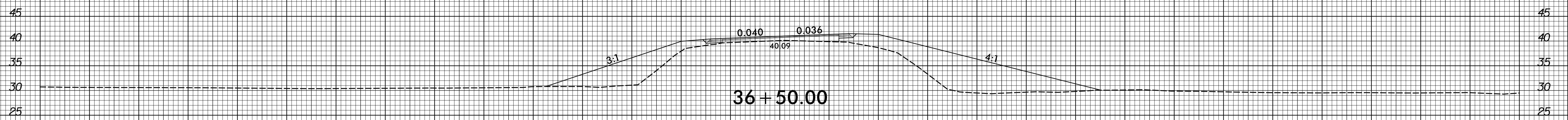
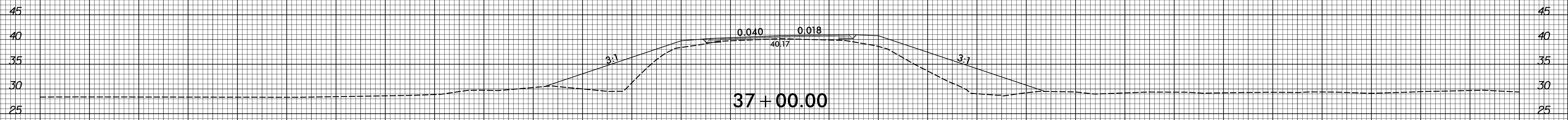
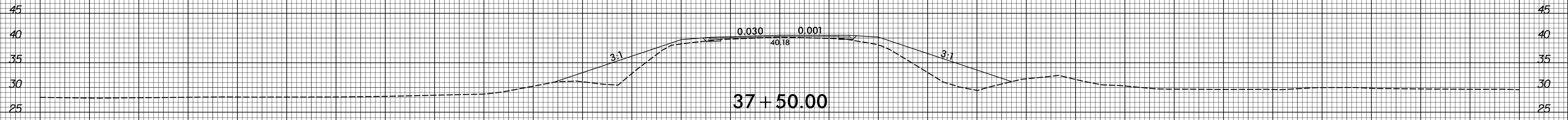

150 140 130 120 110 100 90 80 70 60 50 40 30 20 10 0 10 20 30 40 50 60 70 80 90 100 110 120 130 140 150

8/31/2017 8:49:21 am d:\xp1\1.dgn

8/23/99

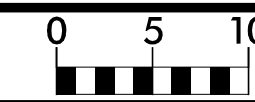

PROJ. REFERENCE NO.
B-4932

SHEET NO.
X-13

150 140 130 120 110 100 90 80 70 60 50 40 30 20 10 0 10 20 30 40 50 60 70 80 90 100 110 120 130 140 150

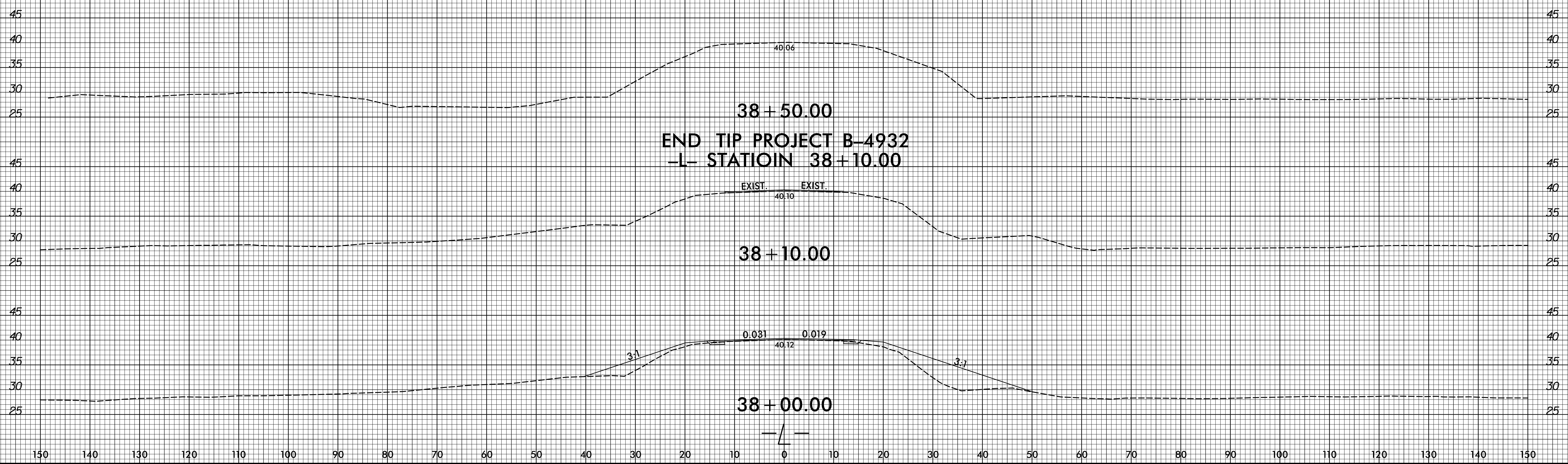

8/31/2017
B:\932\du_xpl\l.dgn
Javali

8/23/99

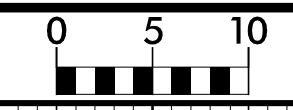

PROJ. REFERENCE NO.
B-4932

SHEET NO.
X-14

150 140 130 120 110 100 90 80 70 60 50 40 30 20 10 0 10 20 30 40 50 60 70 80 90 100 110 120 130 140 150

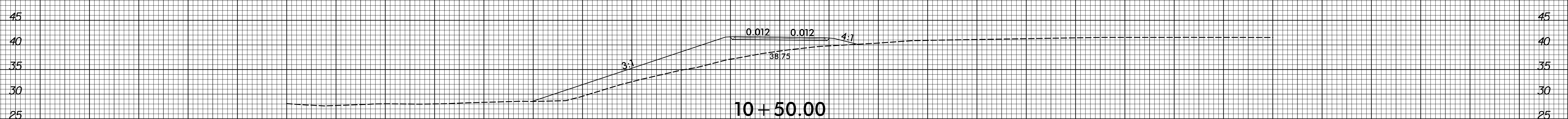
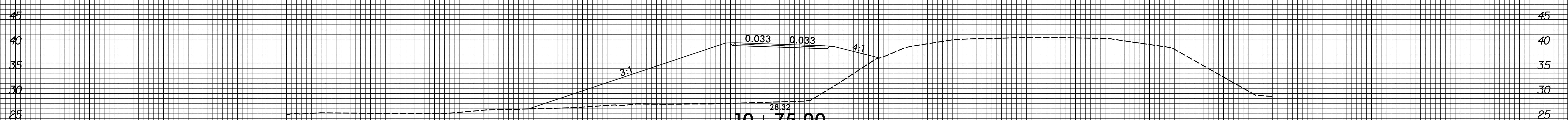
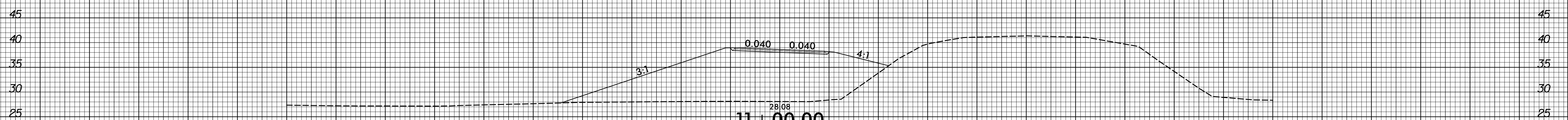
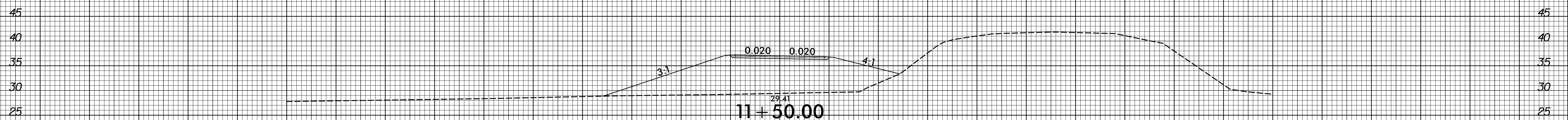
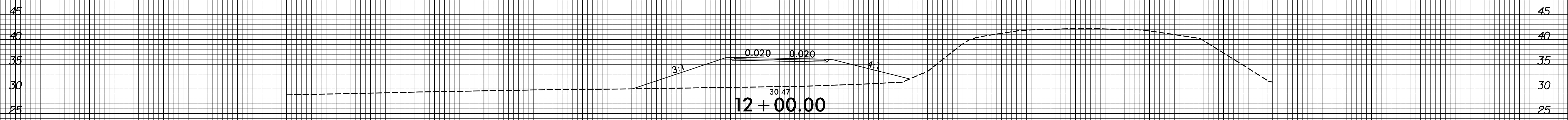
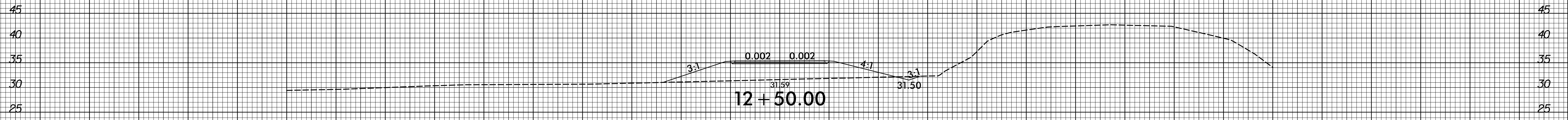

-DRWI-

150 140 130 120 110 100 90 80 70 60 50 40 30 20 10 0 10 20 30 40 50 60 70 80 90 100 110 120 130 140 150

8/31/2017
B:\4932\dl\xp1.dwg
J:\ave\jfb

8/23/99

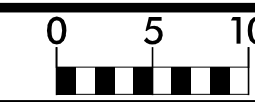

PROJ. REFERENCE NO.
B-4932

SHEET NO.
X-15

150 140 130 120 110 100 90 80 70 60 50 40 30 20 10 0 10 20 30 40 50 60 70 80 90 100 110 120 130 140 150

END CONSTRUCTION -DRWI-
STA. 13 + 68.00

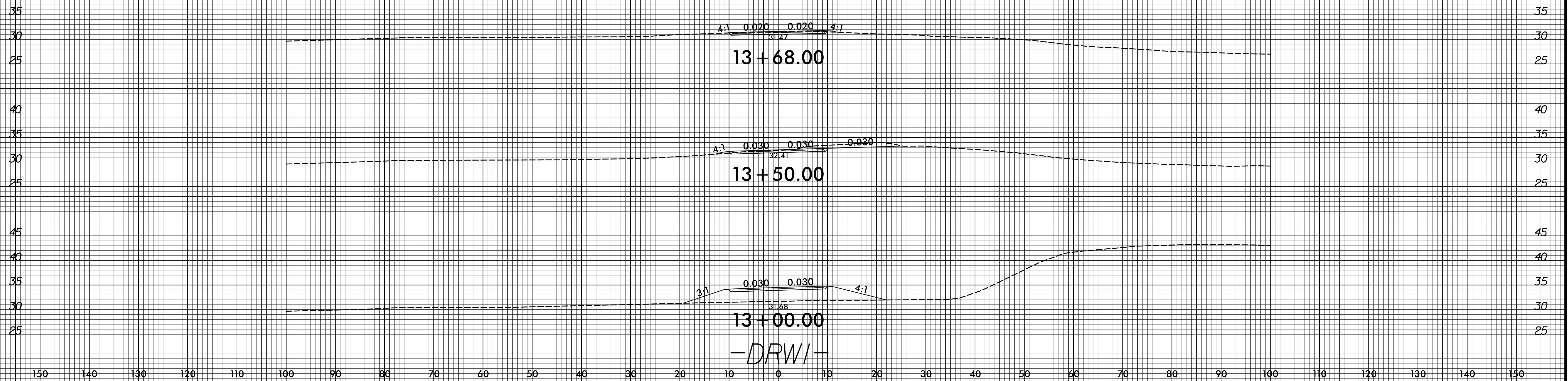

8/31/2017
B:\932\dl\xp1-dr-w1.dgn
jave11@b

8/23/99

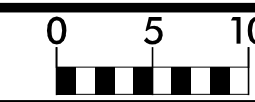

PROJ. REFERENCE NO.
B-4932

SHEET NO.
X-16

150 140 130 120 110 100 90 80 70 60 50 40 30 20 10 0 10 20 30 40 50 60 70 80 90 100 110 120 130 140 150

END CONSTRUCTION -DRW2-
STA. 11+10.00

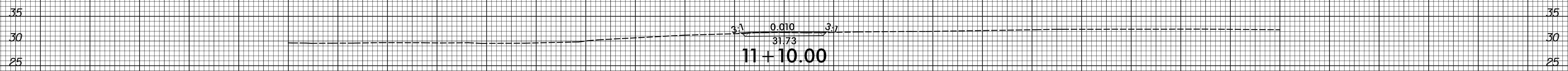

11+10.00

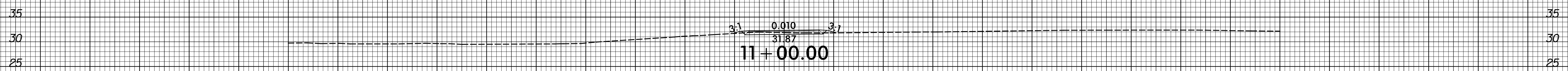

11+00.00

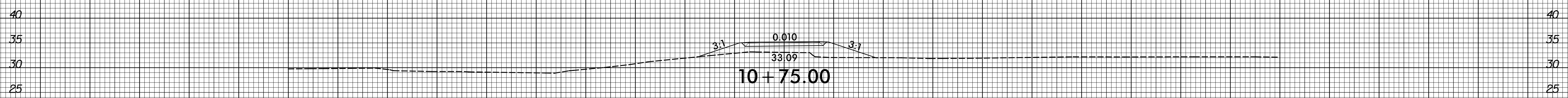

10+75.00

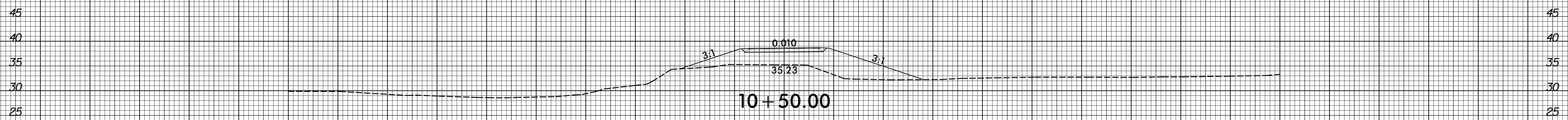

10+50.00

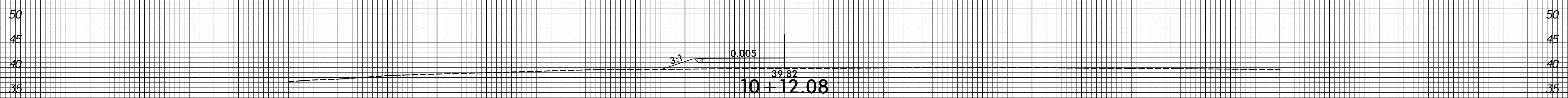

10+12.08

-DRW2-

150 140 130 120 110 100 90 80 70 60 50 40 30 20 10 0 10 20 30 40 50 60 70 80 90 100 110 120 130 140 150

8/31/2017
B:\4932\dwg\xp1-drw2.dgn
J:\ave\jfb