

High Speed Detection (≥40 mph)

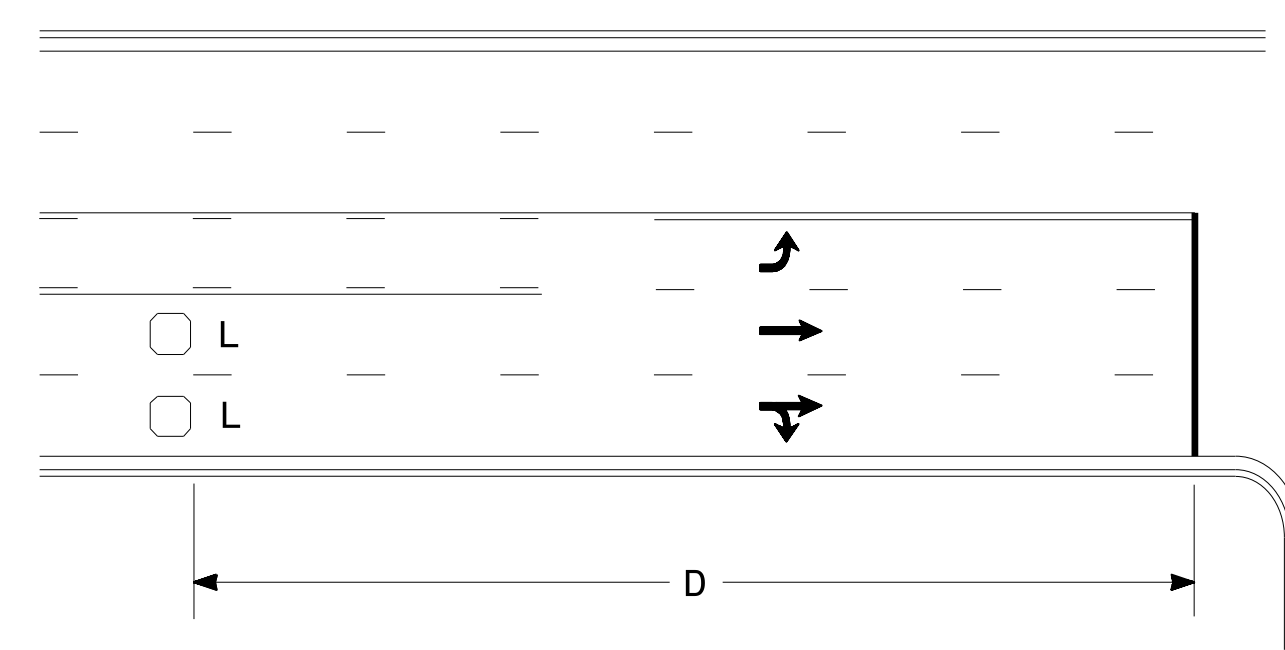

Speed Limit mph	D ft
40	250
45	300
50	355
55	420

L = 6ft X 6ft
Wired in series for TS1
Controllers
Wired separately for TS2,
170, and 2070L Controllers

Volume Density Operation

OR

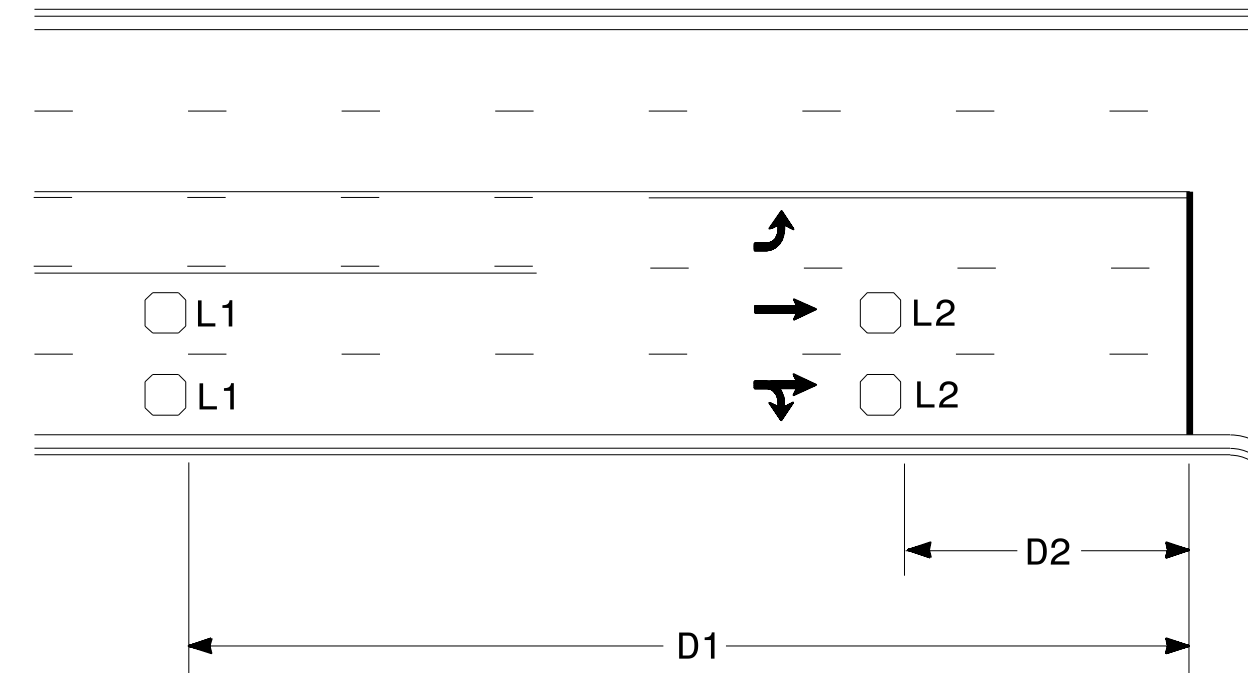

Speed Limit mph	D1 ft	D2 ft
40	250	80
45	300	90
50	355	100
55	420	110

L1 = 6ft X 6ft
Wired in series
L2 = 6ft X 6ft
Wired in series

"Stretch" Operation

Low Speed Detection (≤35 mph)

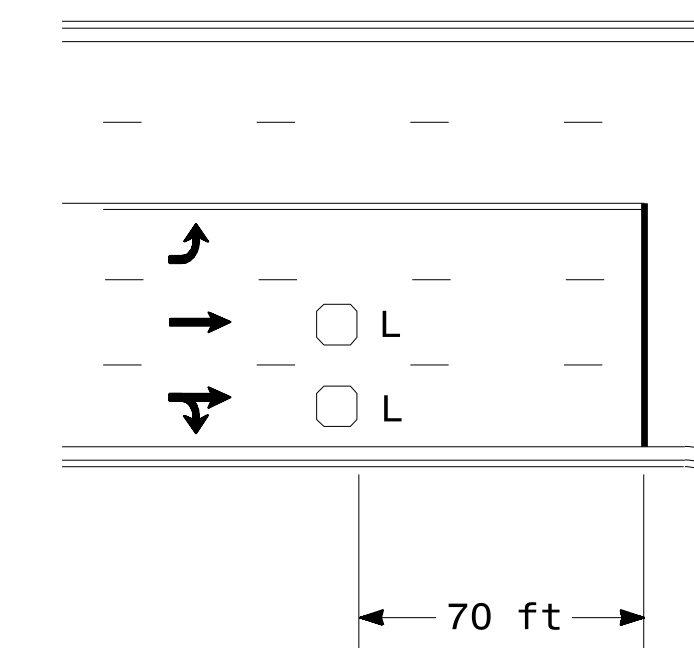

L = 6ft X 6ft
Wired in series

OR

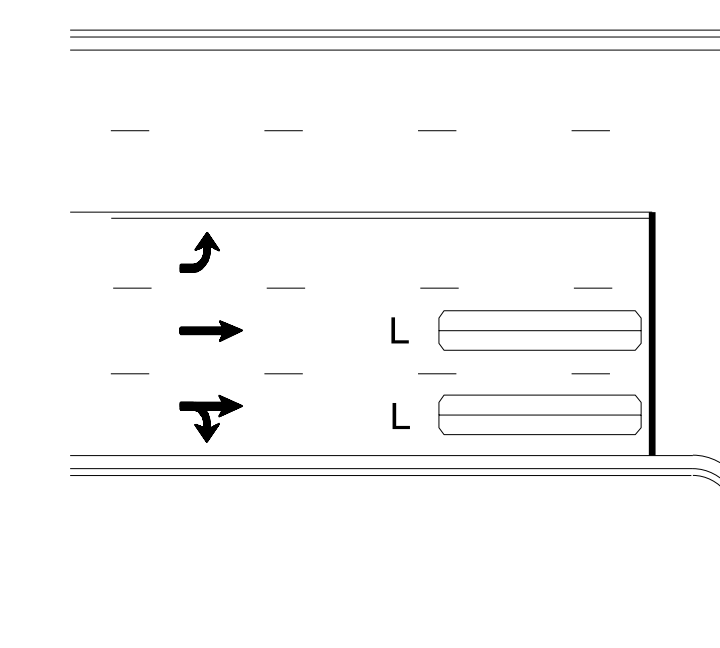

L = 6ft X 40ft
Quadrupole loop, wired separately

Left Turn Lane Detection

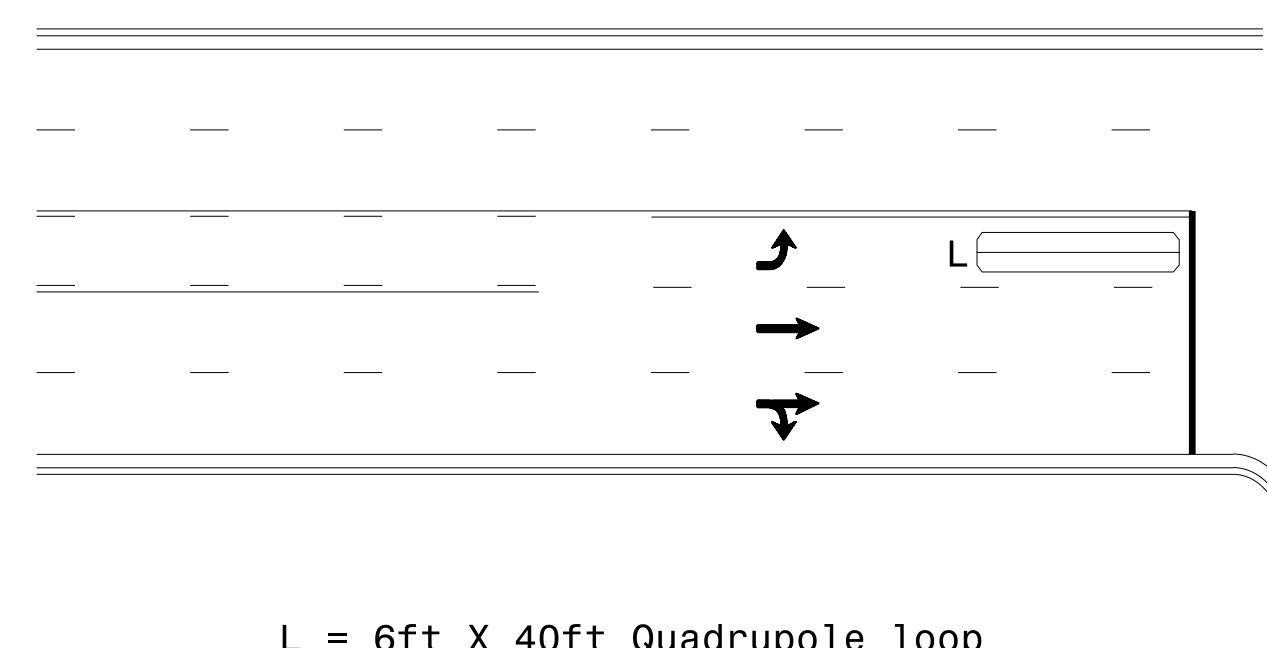

L = 6ft X 40ft Quadrupole loop

Presence Loop Detection

OR

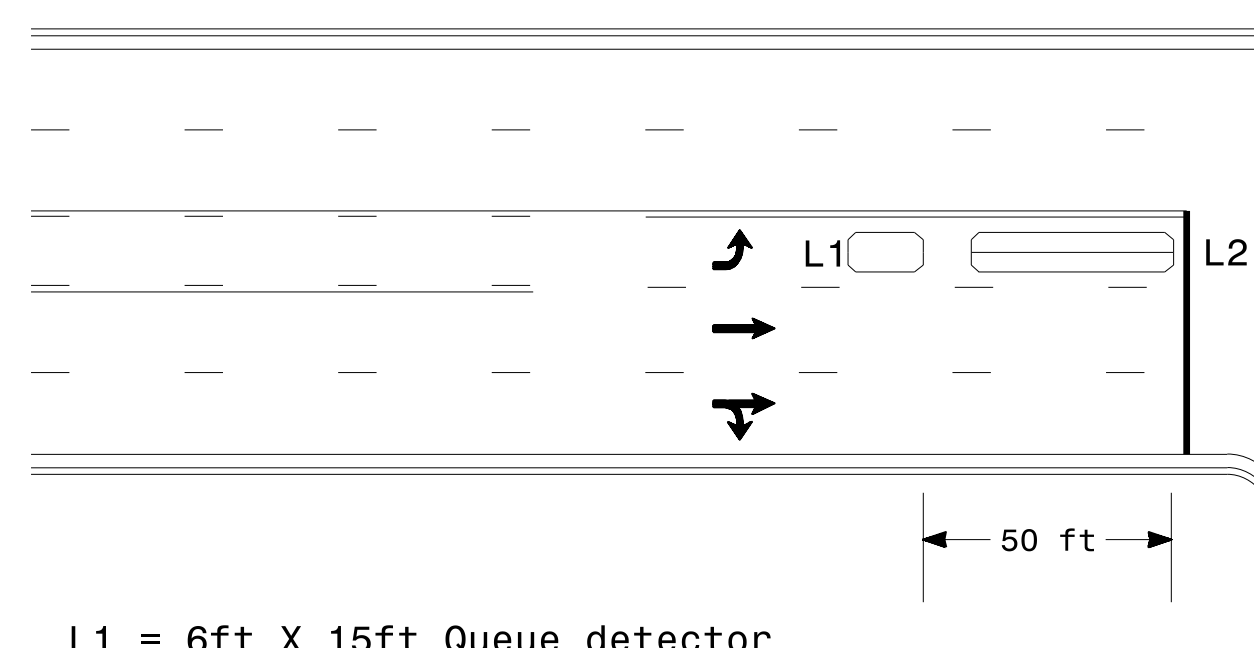

L1 = 6ft X 15ft Queue detector
L2 = 6ft X 40ft Quadrupole loop

Queue Loop Detection

Right Turn Lane Detection

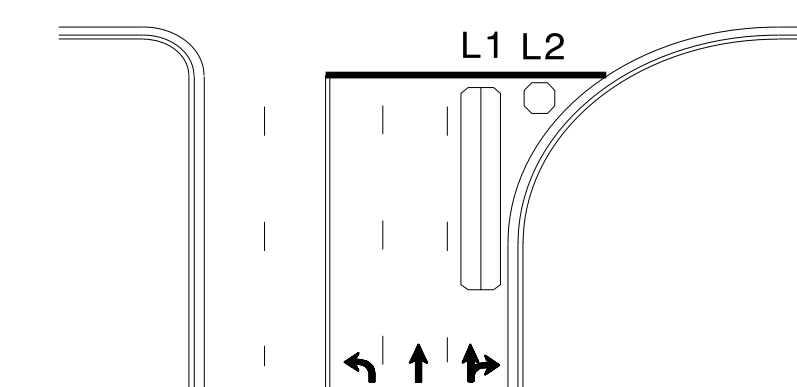

Shared Lane/
Wide Radius Turn

L1 = 6ft X 40ft Quadrupole loop
L2 = 6ft X 6ft [Minimum] Presence loop
Wired separately

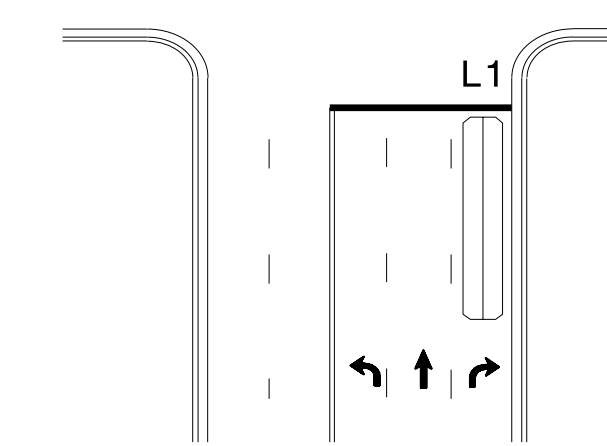

Standard Turn

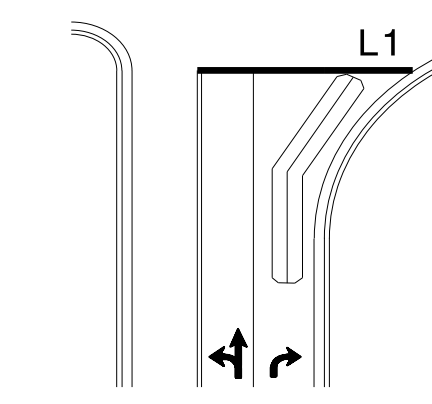

Wide Radius Turn

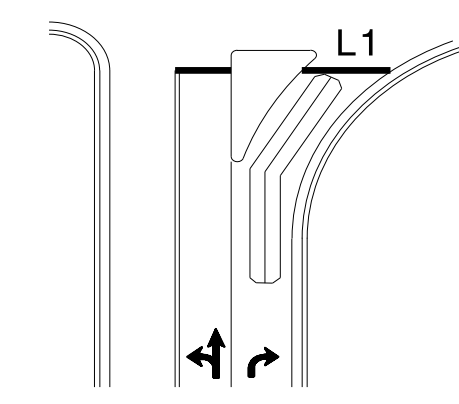

Channelized Turn

Side Street Detection

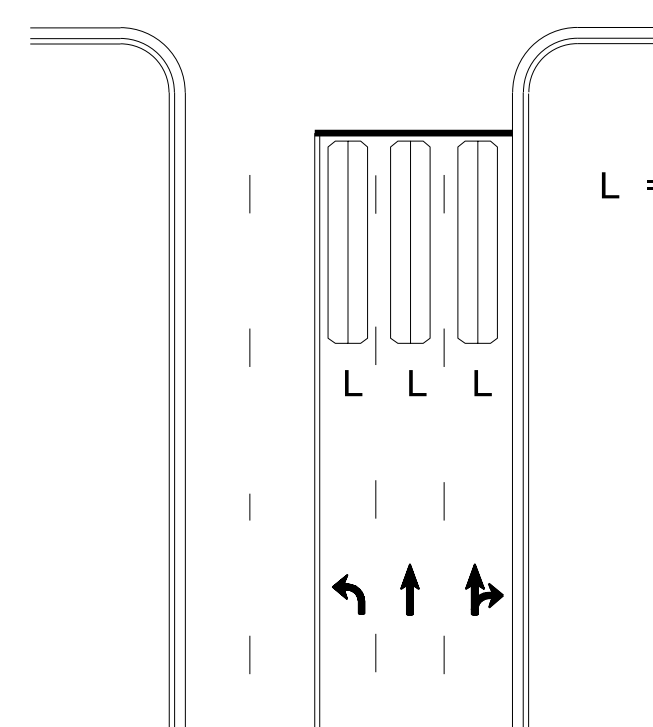

L = 6ft X 40ft
Quadrupole loop
Wired to separate
detectors/channels

Presence Loop Placement at Stop Lines

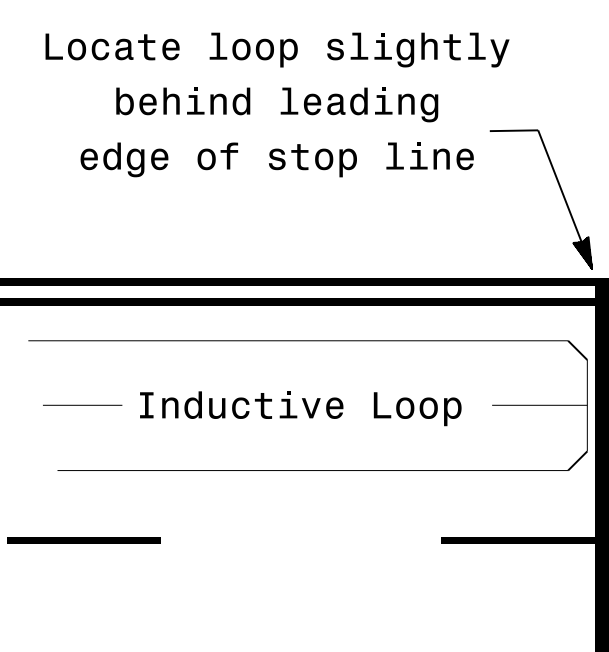

Locate loop slightly
behind leading
edge of stop line

Note:

- Loop may be located in advance of stop line under any of the following conditions:
- 1) stop line is greater than 15' from edge of intersecting roadway
 - 2) loop detects a permissive or protected/permissive left turn
 - 3) for an exclusive right turn lane

Recommended Number of Turns

Single 6' X 6' loop
(when wired separately):

Length of Lead-in ft	Number of Turns
< 250	3
250-375	4
375-525	5
> 525	6

Quadrupole loops: Use 2-4-2 turns

6' X 15' Loops:

- Lead-in < 150', use 2 turns
- Lead-in > 150', use 3 turns

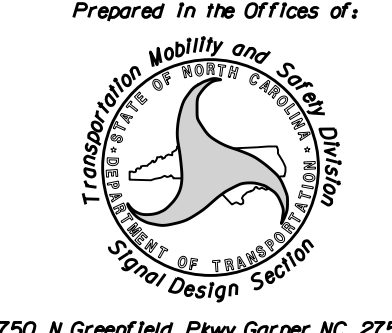
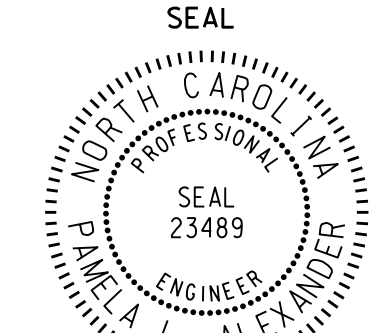
	<h3>Typical Signal Loop Locations</h3>		
	PLAN DATE: January 2015 PREPARED BY: PLA	REVIEWED BY: JPG REVIEWED BY:	
REVISIONS:		INIT. DATE:	DocuSigned by: P. Alexander 1/30/2015 DATE:
SIG. INVENTORY NO.			