

**This electronic collection of documents is provided
for the convenience of the user
and is Not a Certified Document –**

**The documents contained herein were originally issued
and sealed by the individuals whose names and license
numbers appear on each page, on the dates appearing
with their signature on that page.**

**This file or an individual page
shall not be considered a certified document.**

8/23/99

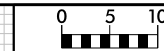

PROJ. REFERENCE NO.	SHEET NO.
U-4751	X-120

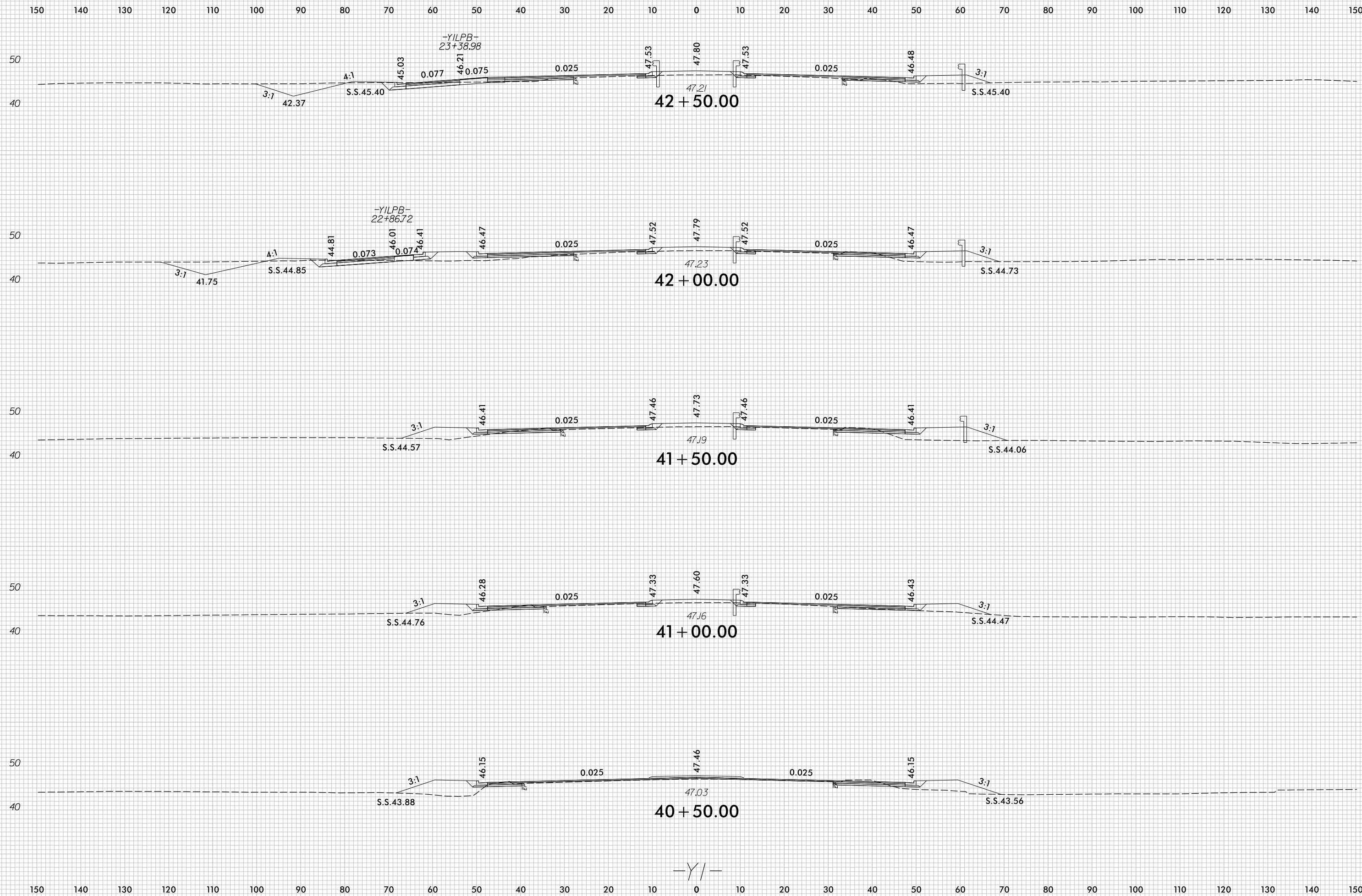

7/5/2017
r:\Roadway\XSC\U4751_Rdy_XPL_Y1.dgn
c:\proves

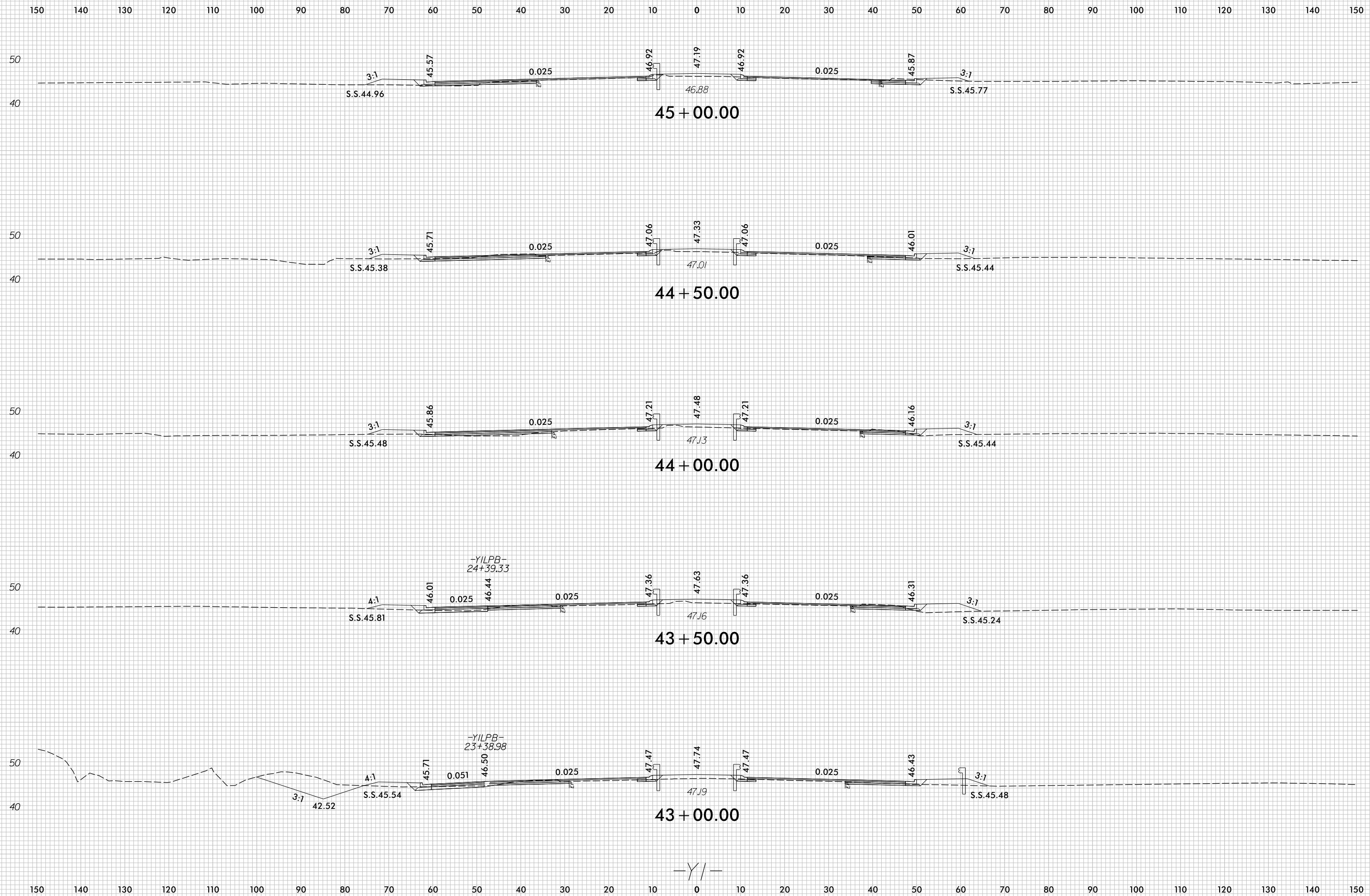

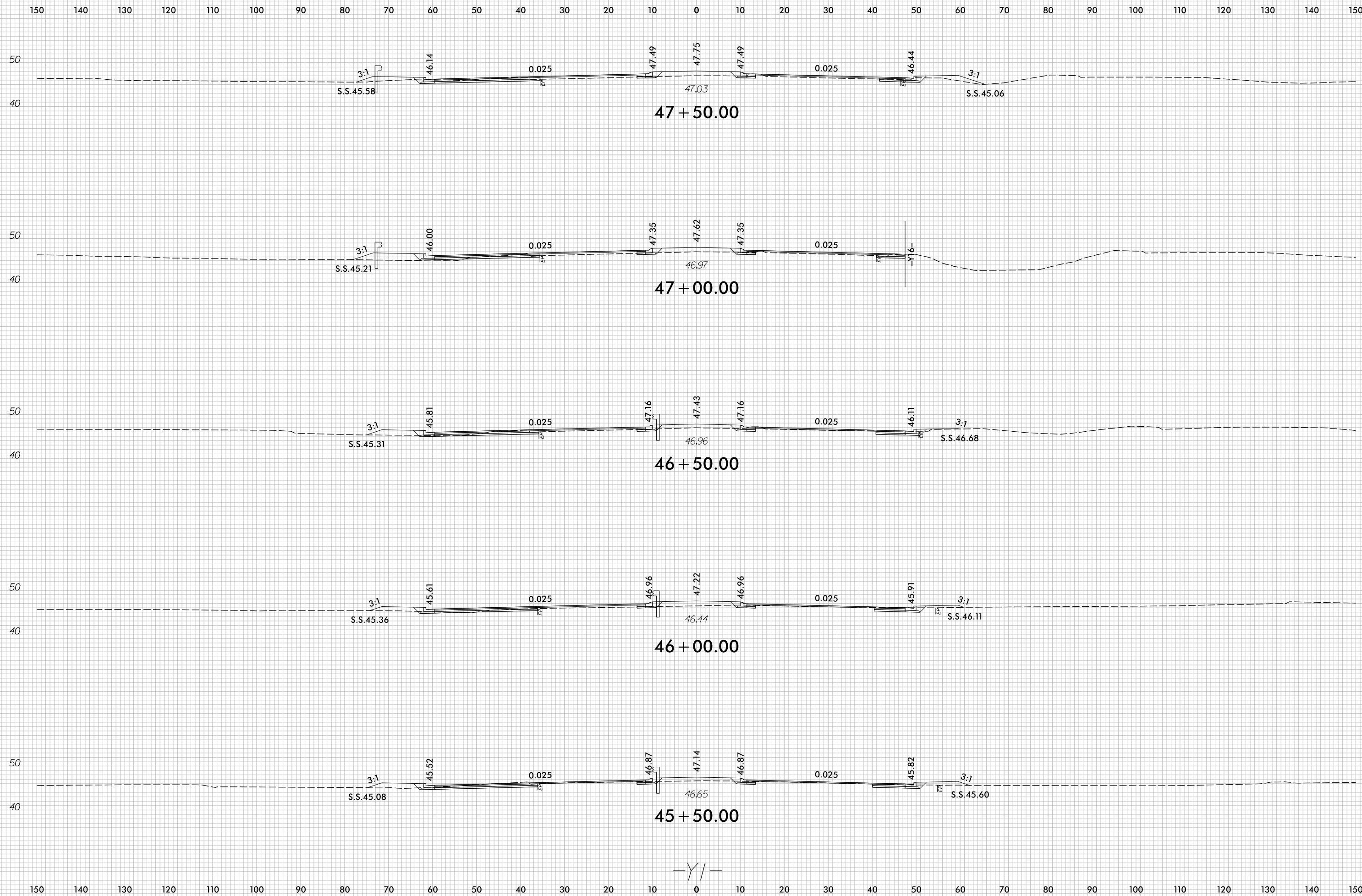
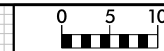

8/23/99

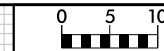

PROJ. REFERENCE NO.	SHEET NO.
U-4751	X-123

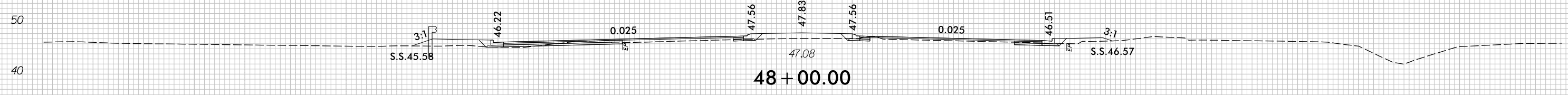
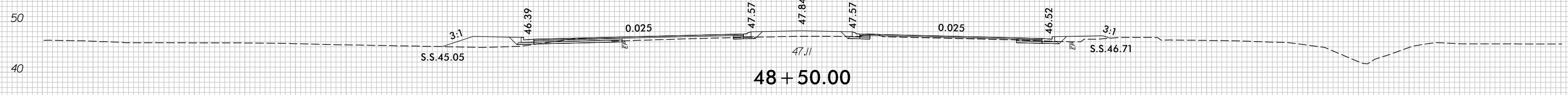
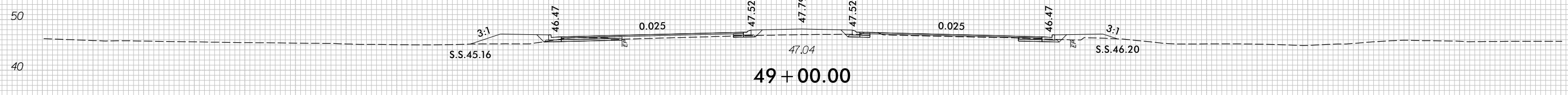
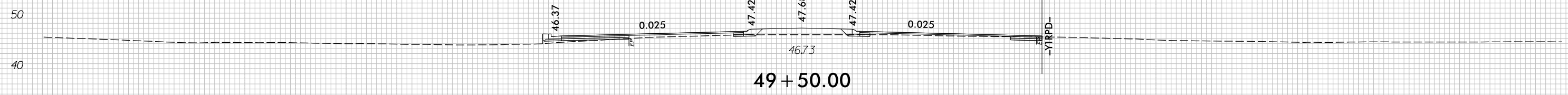
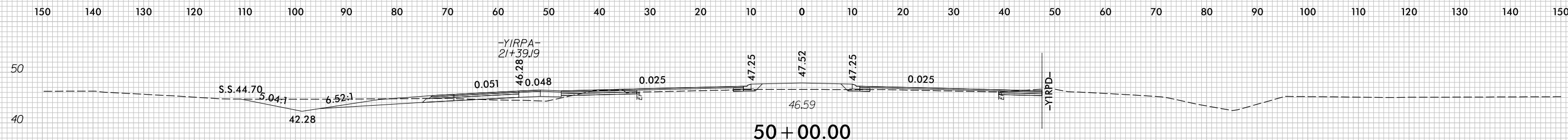

-Y/-

7/5/2017
r:\Roadway\XSC\U4751_Rdu_XPL_Y1.dgn
c:\proves

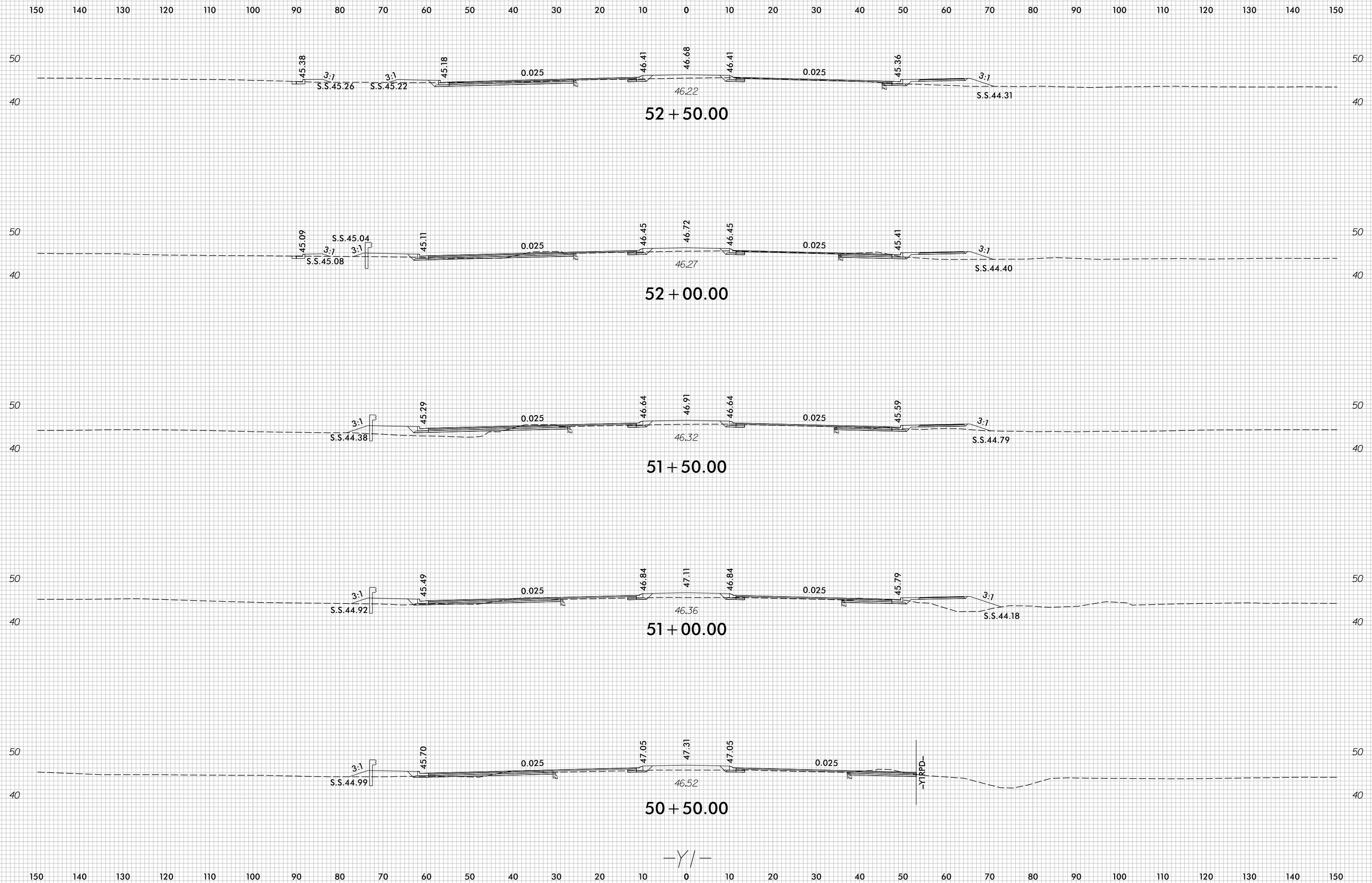

8/23/99

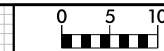

PROJ. REFERENCE NO.	SHEET NO.
U-4751	X-125

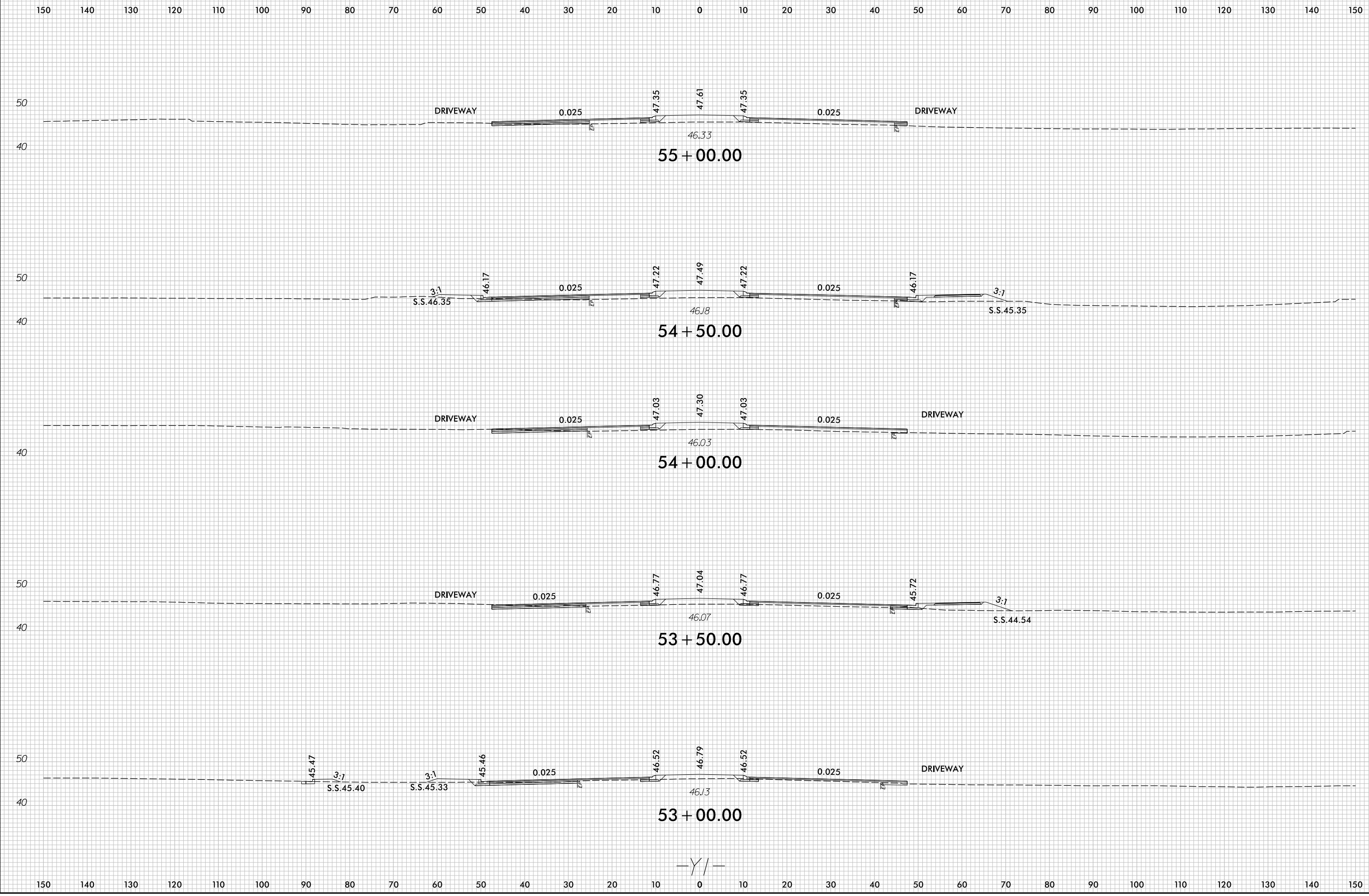

7/5/2017
r:\Roadway\XSC\U4751_Rdu_xPL_Y1.dgn
c:\proves

-Y/-

8/23/99

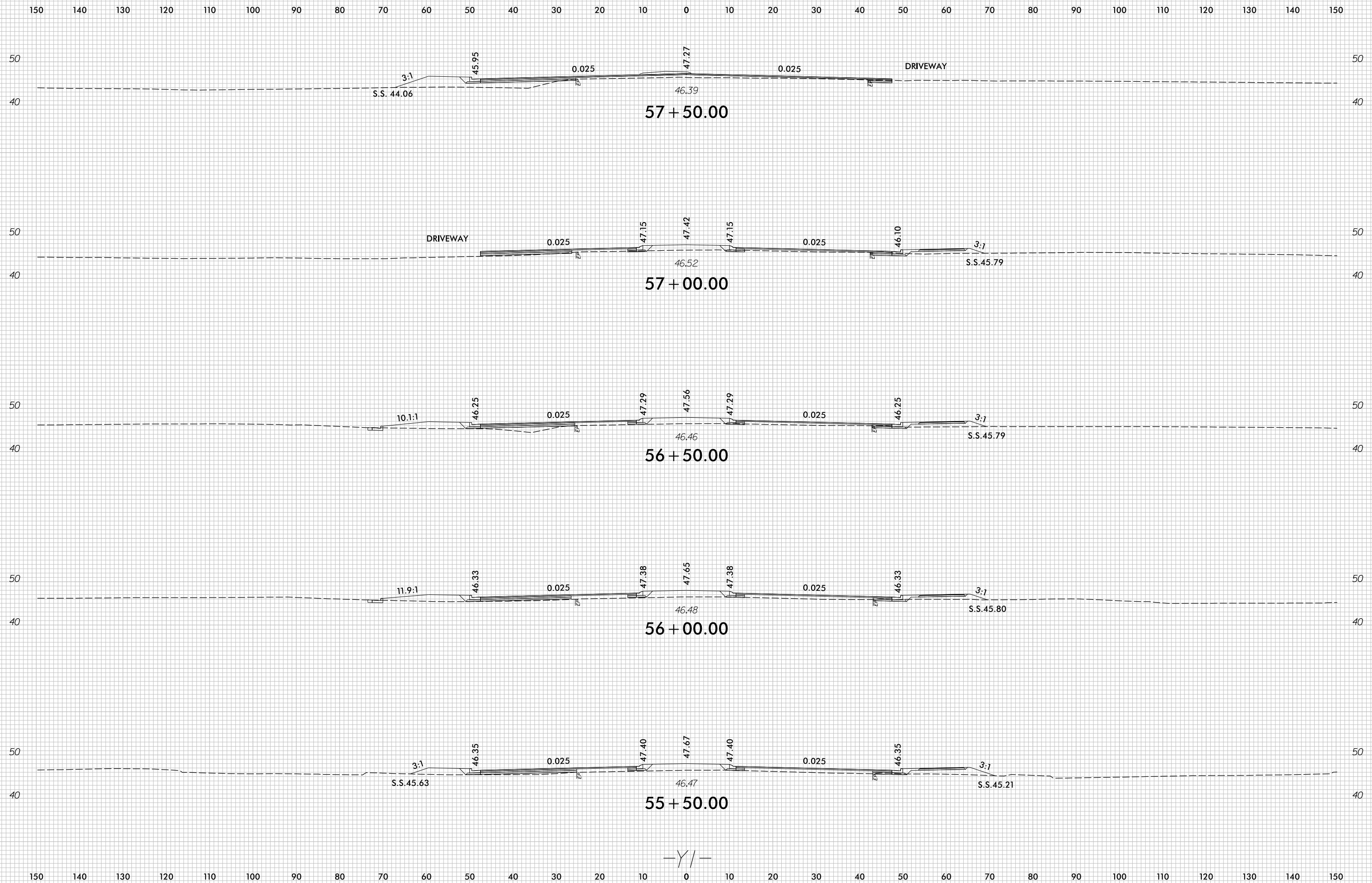

7/5/2017
r:\Roadway\XSC\U4751_Rdu_xPL_Y1.dgn
c:\proves

8/23/99



PROJ. REFERENCE NO.
U-4751

SHEET NO.
X-127

150 140 130 120 110 100 90 80 70 60 50 40 30 20 10 0 10 20 30 40 50 60 70 80 90 100 110 120 130 140 150

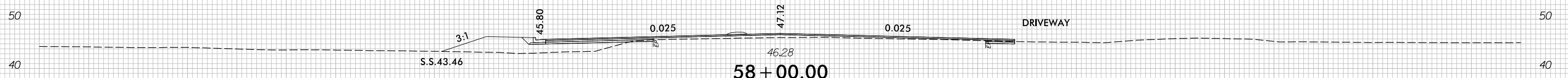
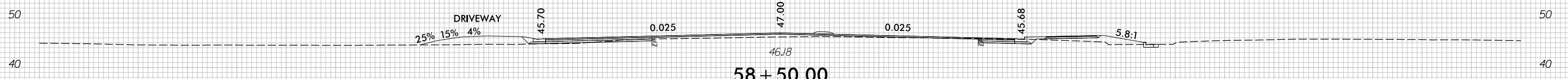
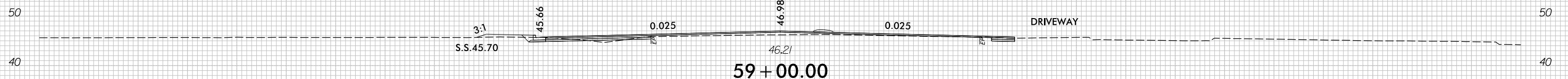
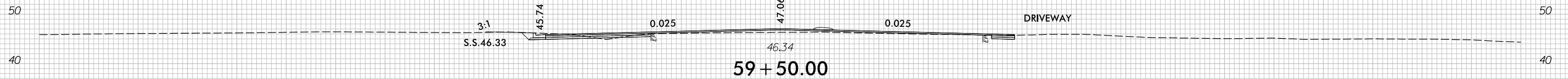
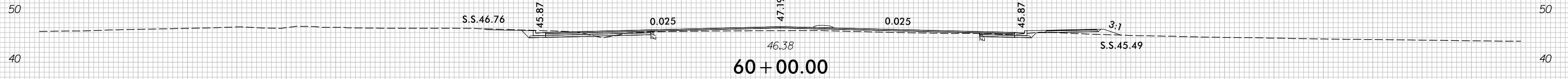

-Y/-

7/5/2017
r:\Roadway\XSC\U4751_Rdu_XPL_Y1.dgn
c:\proves

150 140 130 120 110 100 90 80 70 60 50 40 30 20 10 0 10 20 30 40 50 60 70 80 90 100 110 120 130 140 150

8/23/99

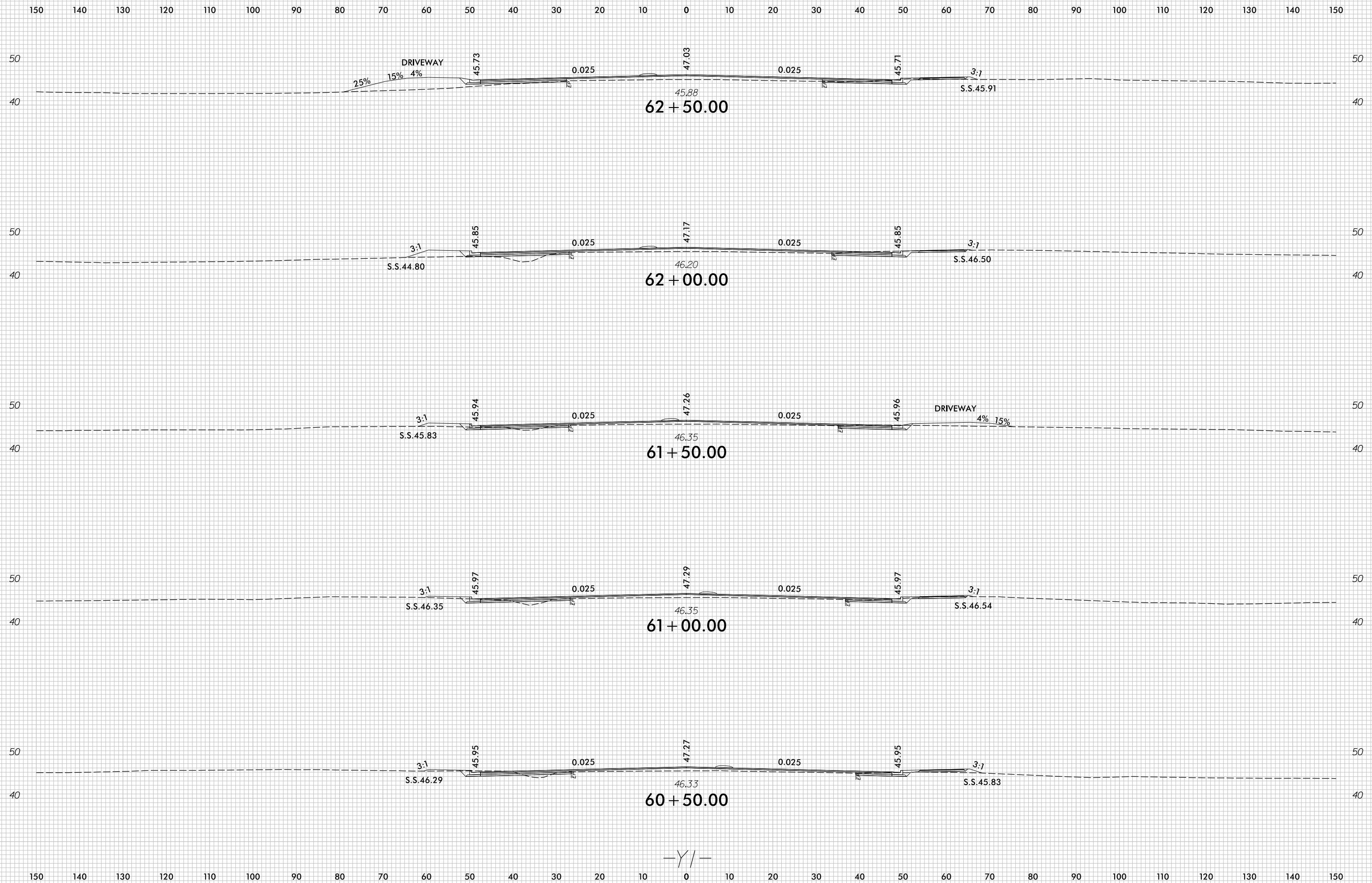

7/5/2017
r:\Roadway\XSC\U4751_Rdy_xPL_Y1.dgn
c:\proves

-Y/-

8/23/99

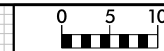

PROJ. REFERENCE NO.	SHEET NO.
U-4751	X-129

150 140 130 120 110 100 90 80 70 60 50 40 30 20 10 0 10 20 30 40 50 60 70 80 90 100 110 120 130 140 150

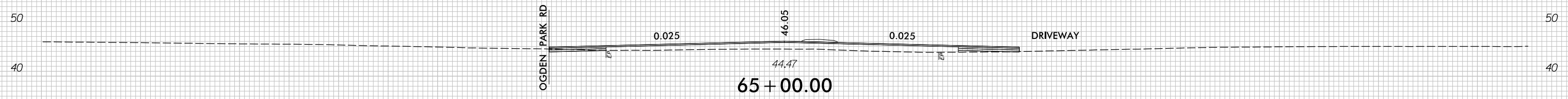

65 + 00.00

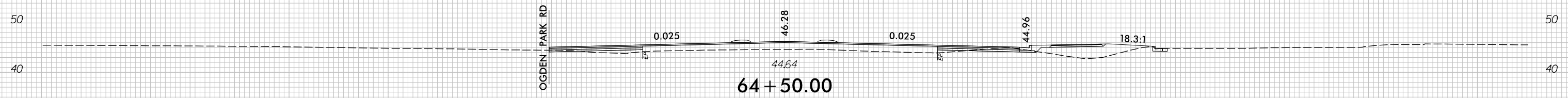

64 + 50.00

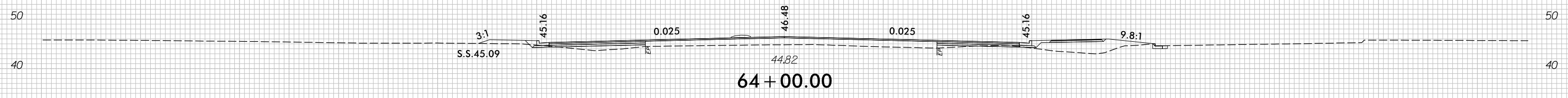

64 + 00.00

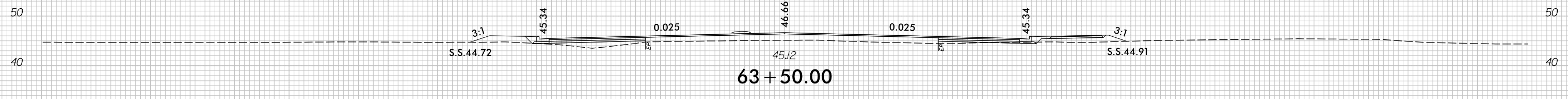

63 + 50.00

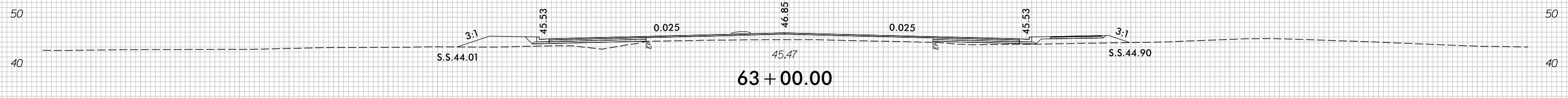

63 + 00.00

-Y/-

150 140 130 120 110 100 90 80 70 60 50 40 30 20 10 0 10 20 30 40 50 60 70 80 90 100 110 120 130 140 150

7/5/2017
r:\Roadway\XSC\U4751_Rdy_XPL_Y1.dgn
c:\proves

8/23/99



PROJ. REFERENCE NO.
U-4751

SHEET NO.
X-130

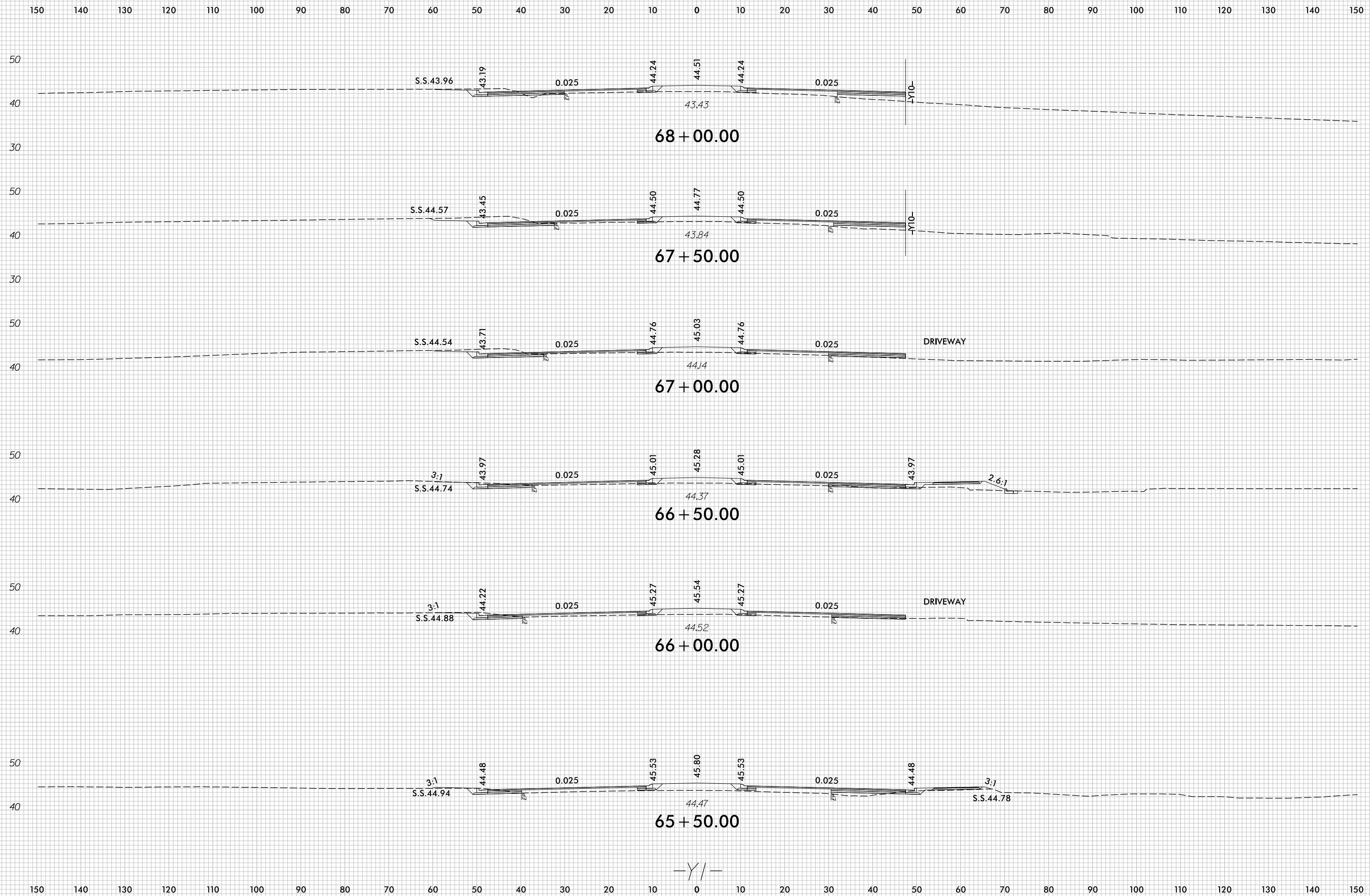

7/5/2017
r:\Roadway\XSC\U4751_Rdu_xPL_Y1.dgn
c:\proves

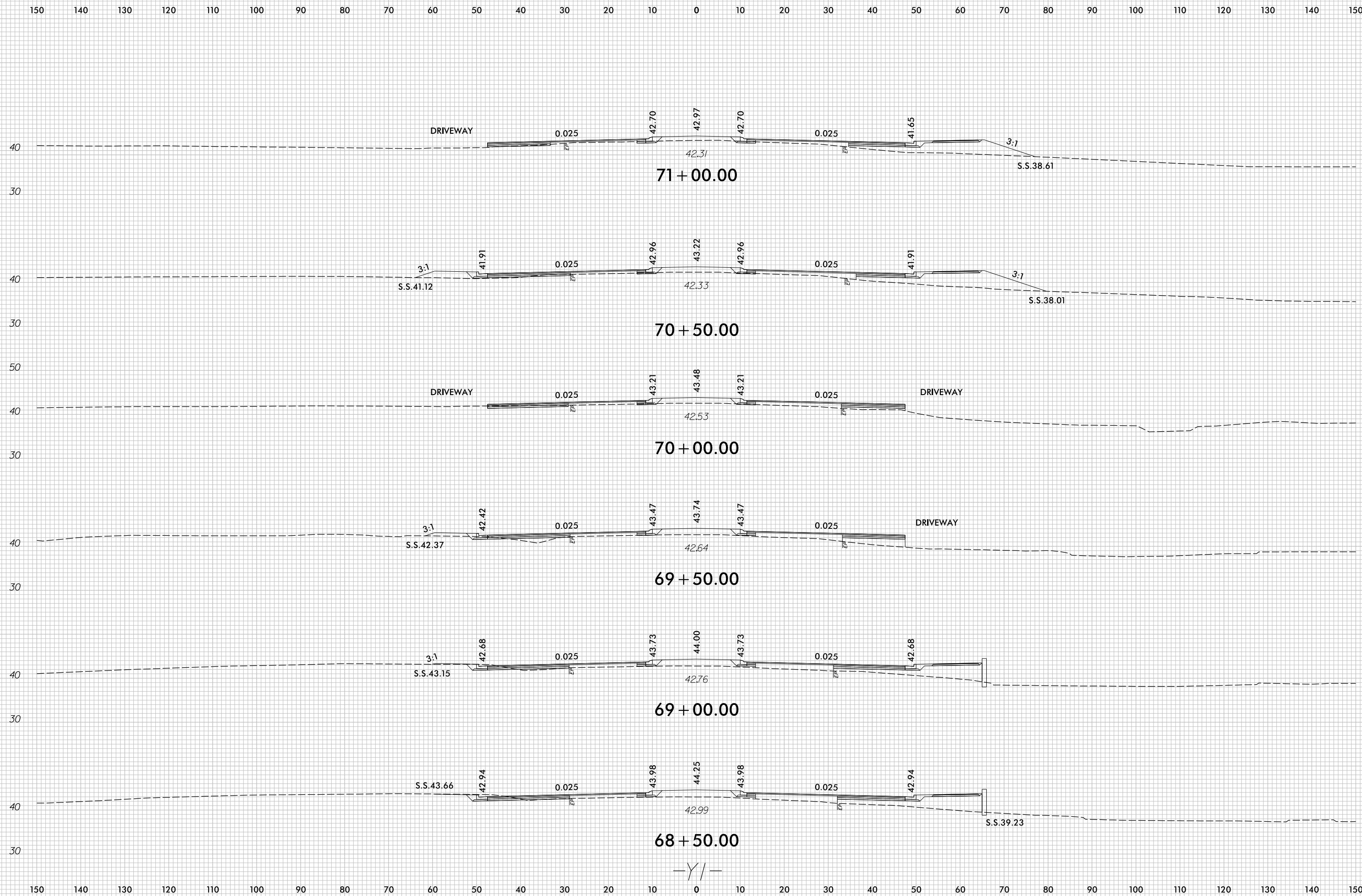
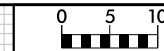

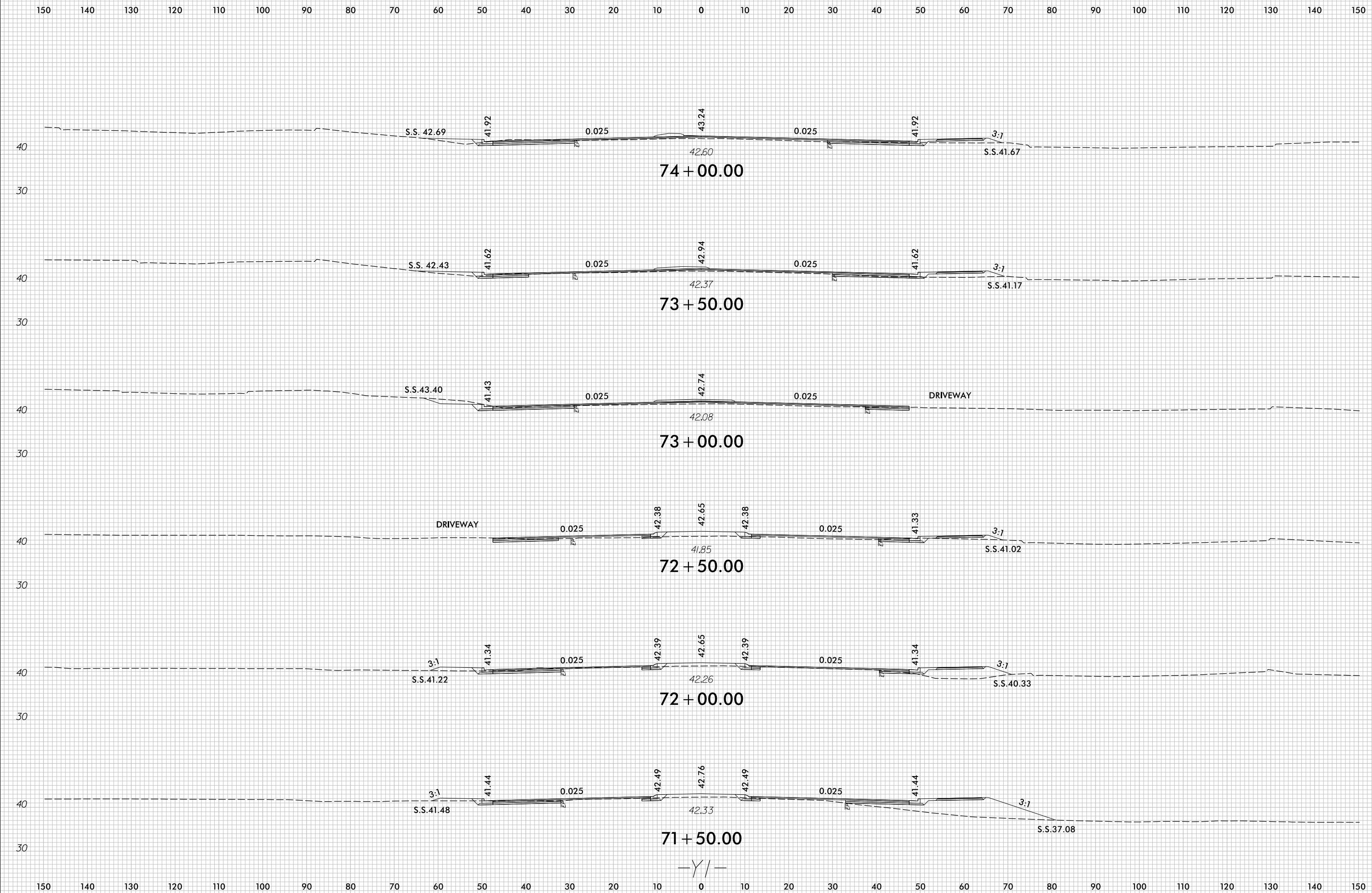
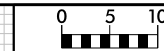

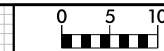

150 140 130 120 110 100 90 80 70 60 50 40 30 20 10 0 10 20 30 40 50 60 70 80 90 100 110 120 130 140 150

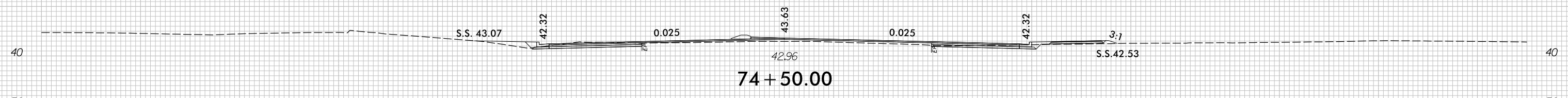
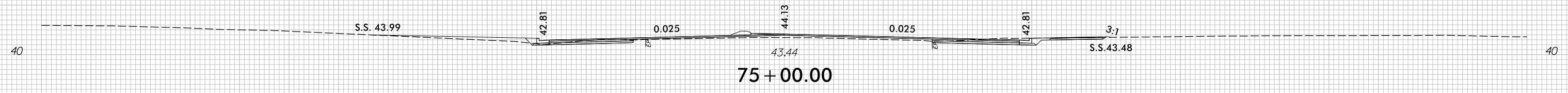
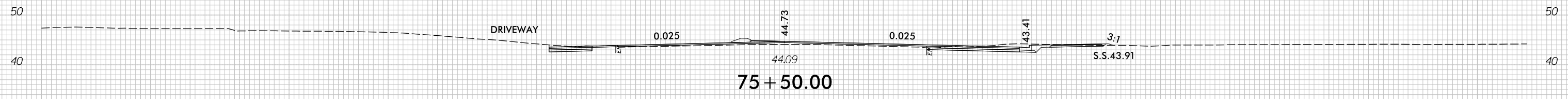
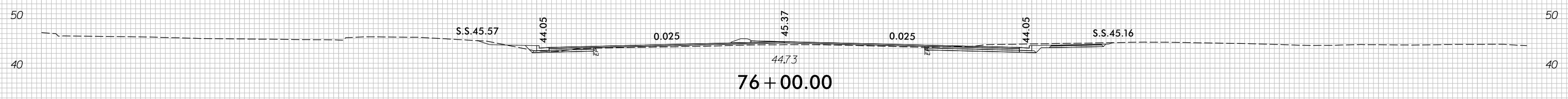
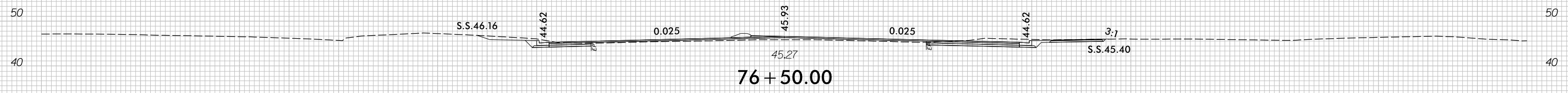

-Y/-

150 140 130 120 110 100 90 80 70 60 50 40 30 20 10 0 10 20 30 40 50 60 70 80 90 100 110 120 130 140 150

8/23/99

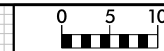

PROJ. REFERENCE NO.	SHEET NO.
U-4751	X-134

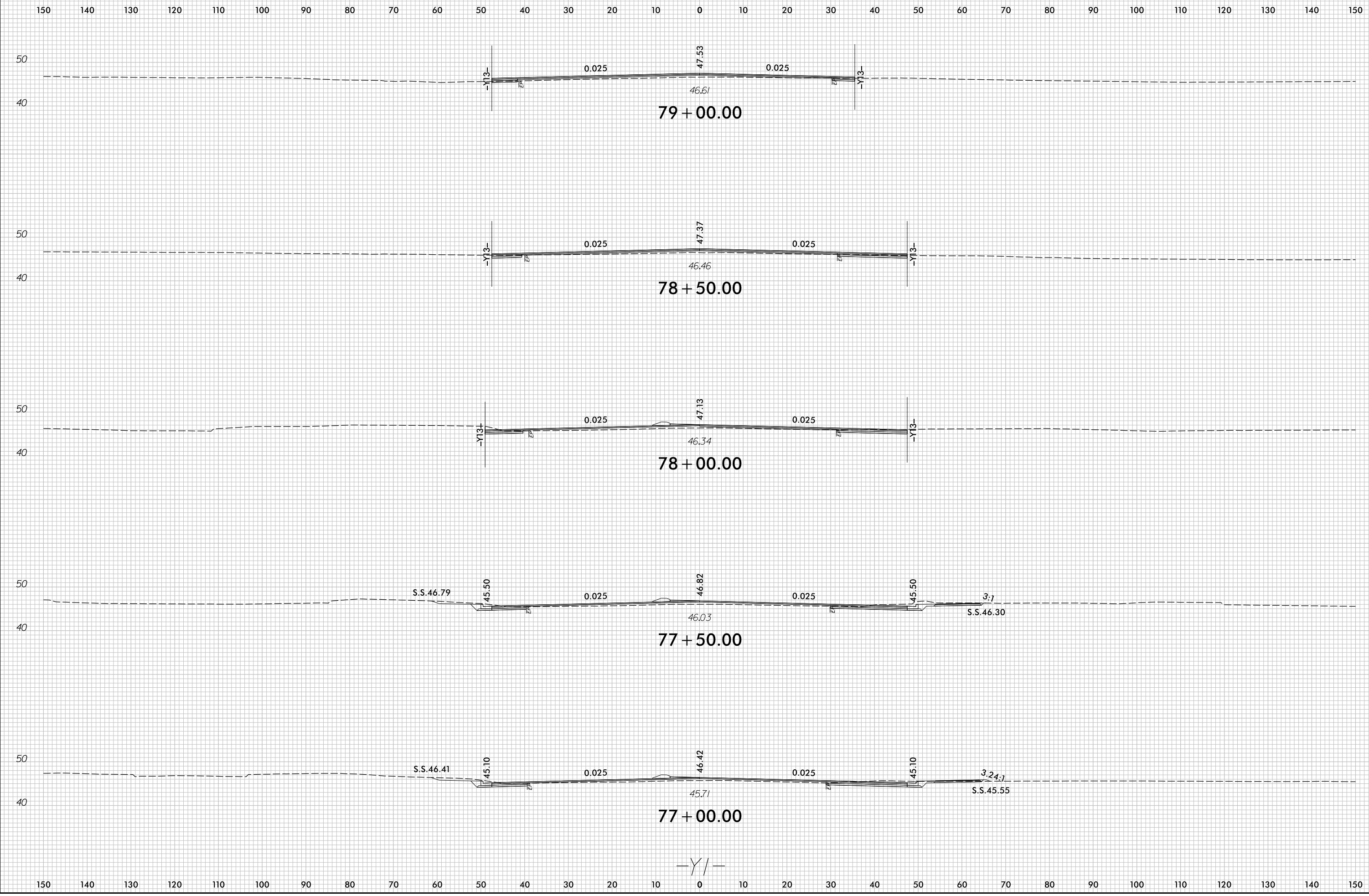

7/5/2017
r:\Roadway\XSC\U4751_Rdu_xPL_Y1.dgn
c:\proves

8/23/99

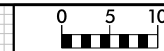

PROJ. REFERENCE NO.	SHEET NO.
U-4751	X-135

150 140 130 120 110 100 90 80 70 60 50 40 30 20 10 0 10 20 30 40 50 60 70 80 90 100 110 120 130 140 150

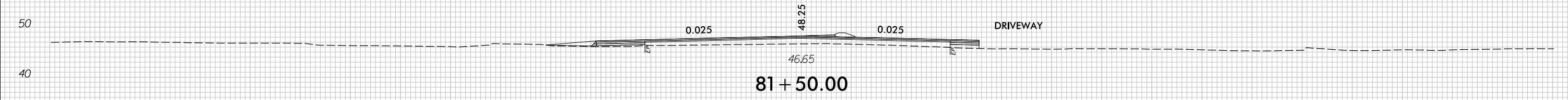

81 + 50.00

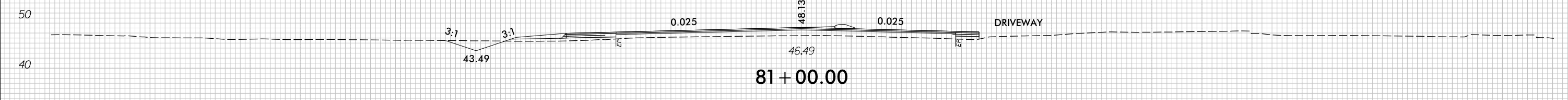

81 + 00.00

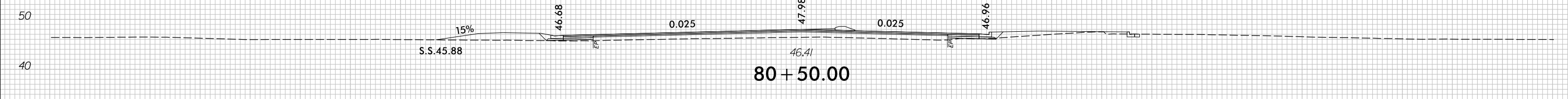

80 + 50.00

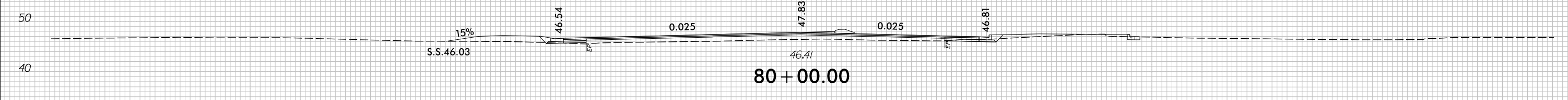

80 + 00.00

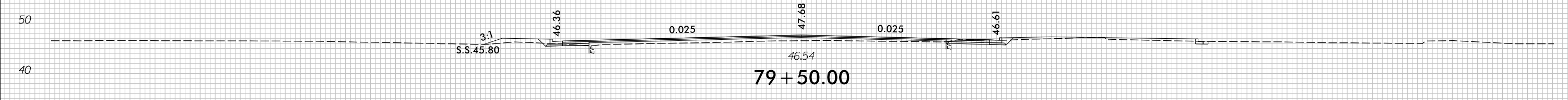

79 + 50.00

150 140 130 120 110 100 90 80 70 60 50 40 30 20 10 0 10 20 30 40 50 60 70 80 90 100 110 120 130 140 150

7/5/2017
r:\Roadway\XSC\U4751_Rdy_XPL_Y1.dgn
c:\proves

-Y/-

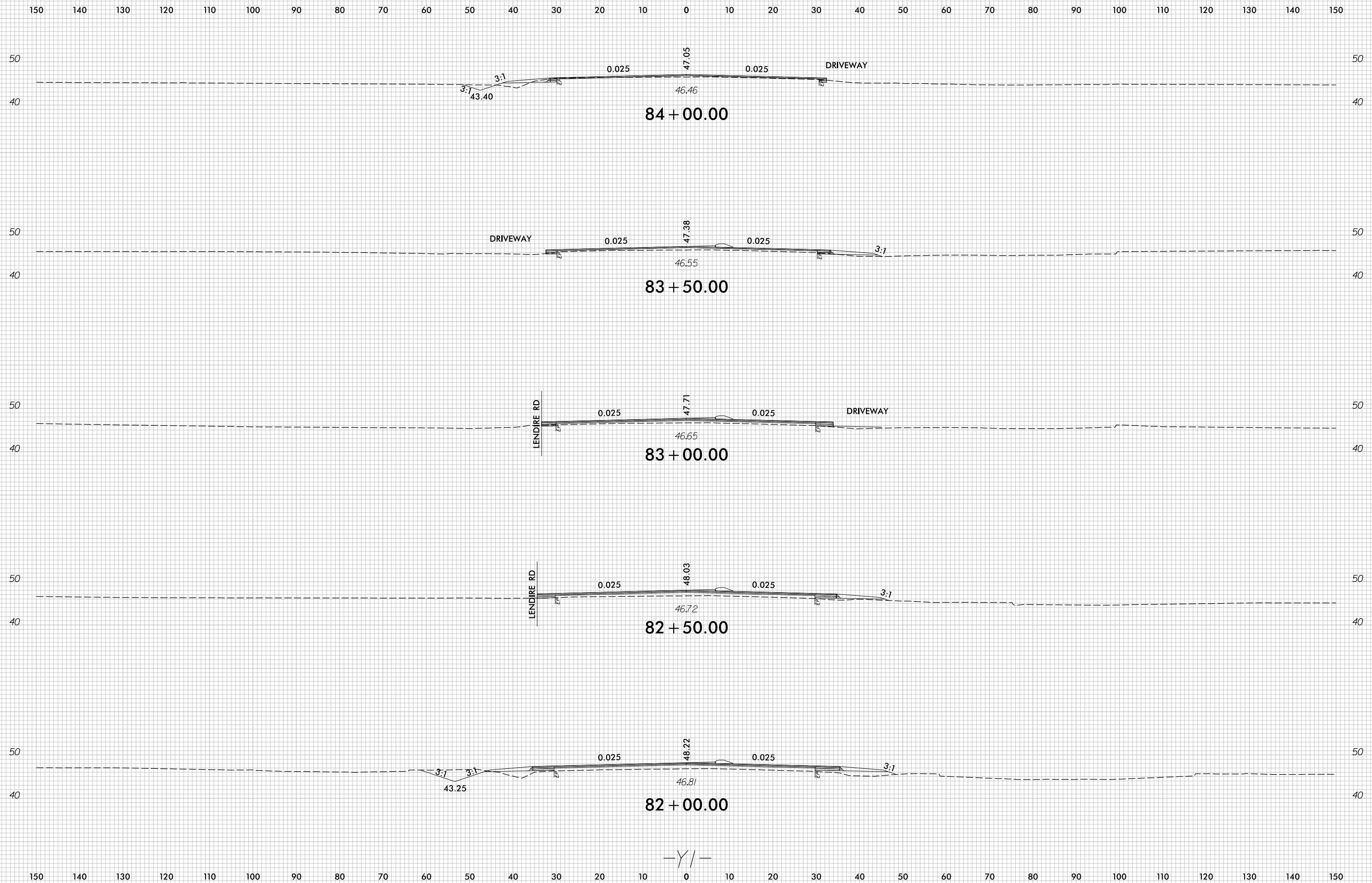



150 140 130 120 110 100 90 80 70 60 50 40 30 20 10 0 10 20 30 40 50 60 70 80 90 100 110 120 130 140 150

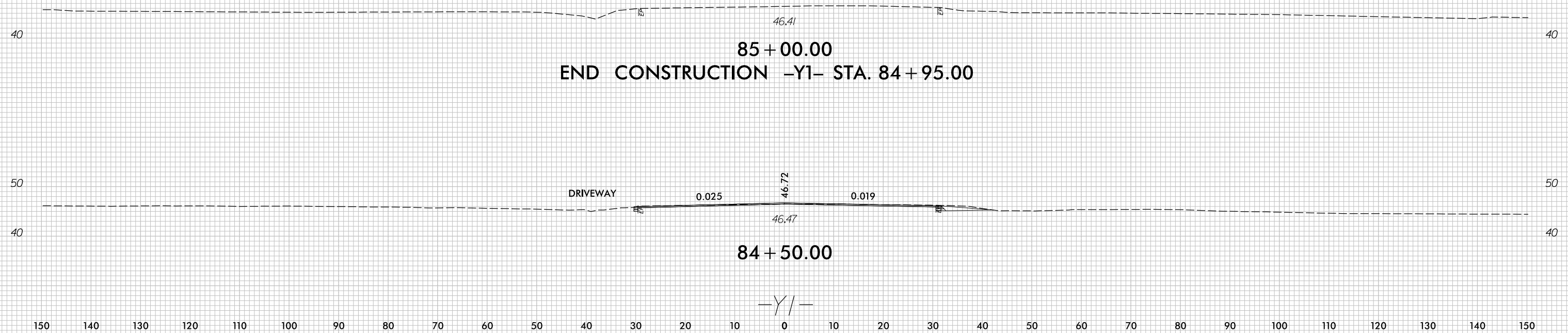

150 140 130 120 110 100 90 80 70 60 50 40 30 20 10 0 10 20 30 40 50 60 70 80 90 100 110 120 130 140 150

8/23/99

0 5 10	PROJ. REFERENCE NO.	SHEET NO.
	U-4751	X-138

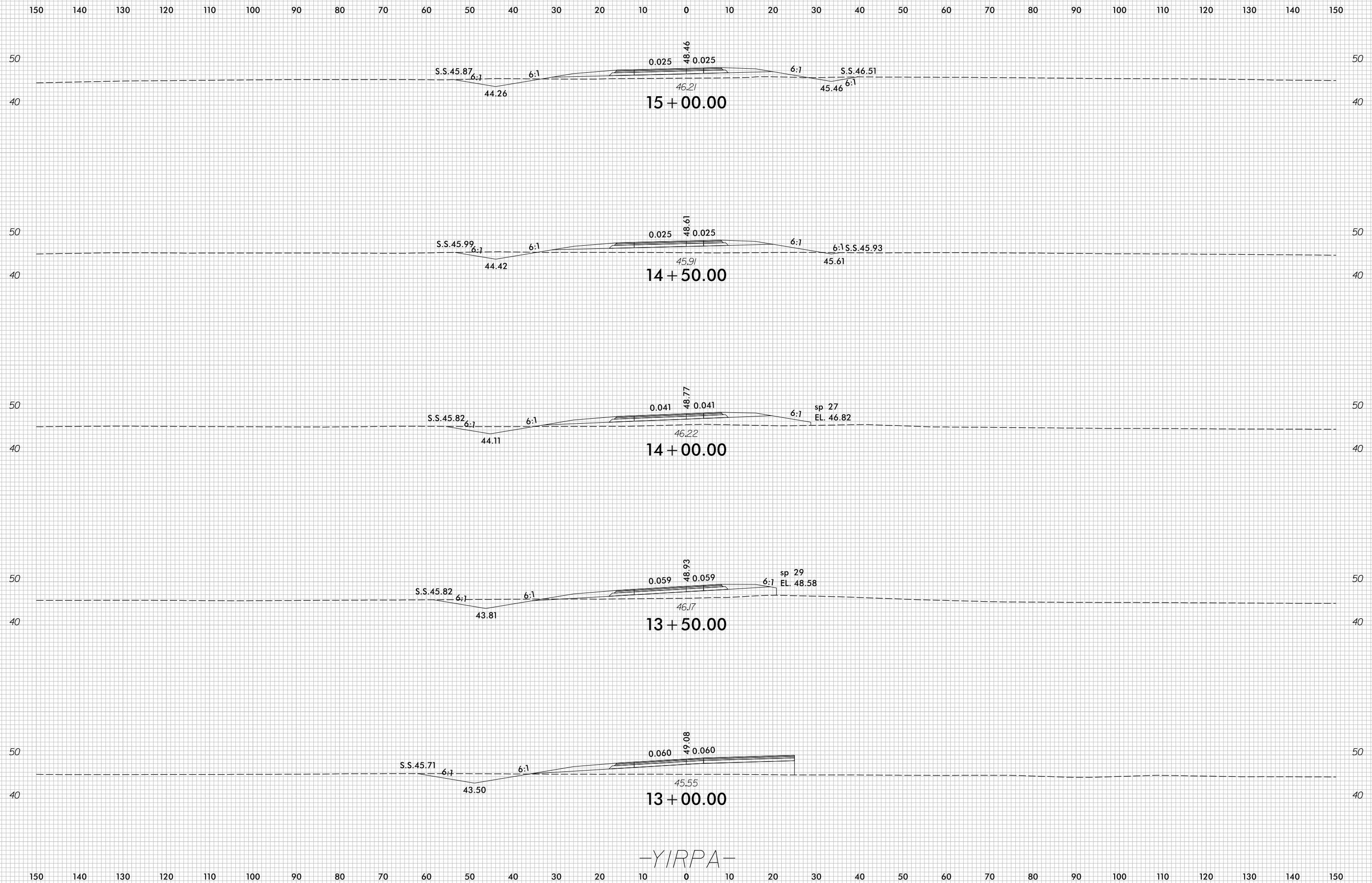

-YIRPA-

7/5/2017
r:\Roadway\XSC\U4751_Rdy_XPL_YIRPA.dgn
cpraves

8/23/99



PROJ. REFERENCE NO.	SHEET NO.
U-4751	X-139

PROJ. REFERENCE NO.	SHEET NO.
U-4751	X-139

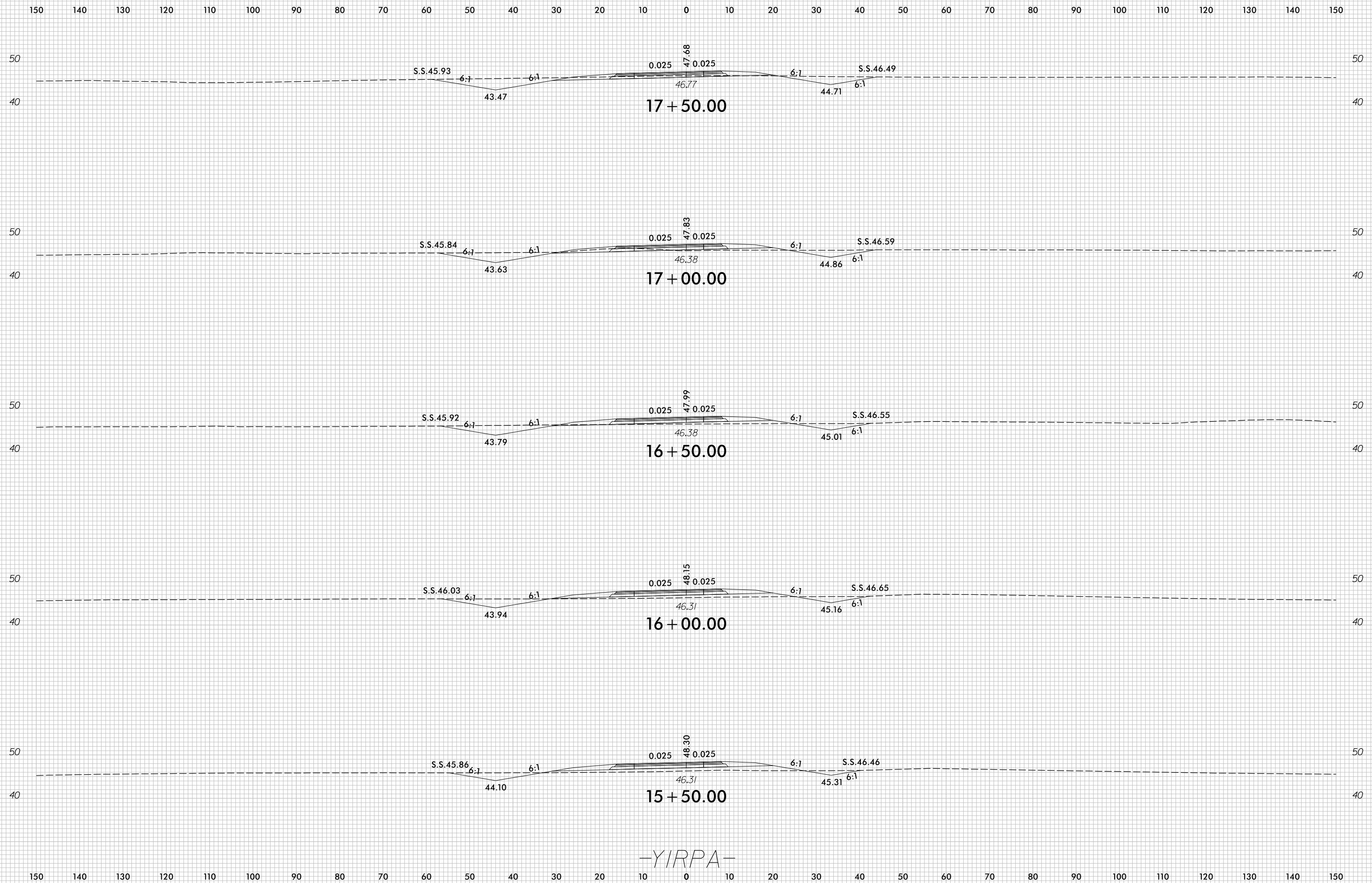

-YIRPA-

7/5/2017
 r:\Roadway\XSC\U4751_Rdy_XPL_YIRPA.dgn
 c:\proves

8/23/99



PROJ. REFERENCE NO.	SHEET NO.
U-4751	X-140

PROJ. REFERENCE NO.	SHEET NO.
U-4751	X-140

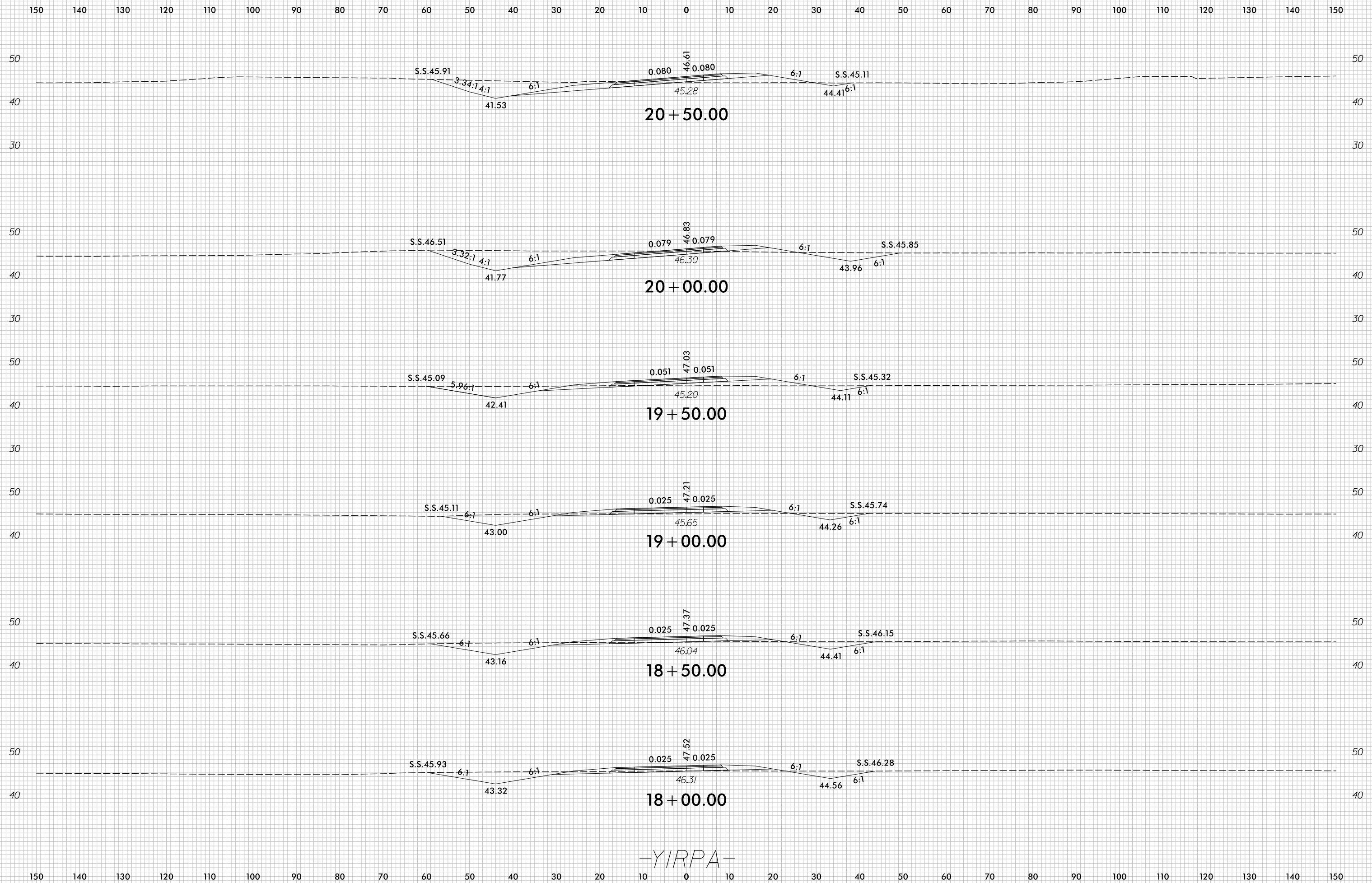

-YIRPA-

7/5/2017
r:\Roadway\XSC\U4751_Rdu_XPL_YIRPA.dgn
c:\proves

8/23/99

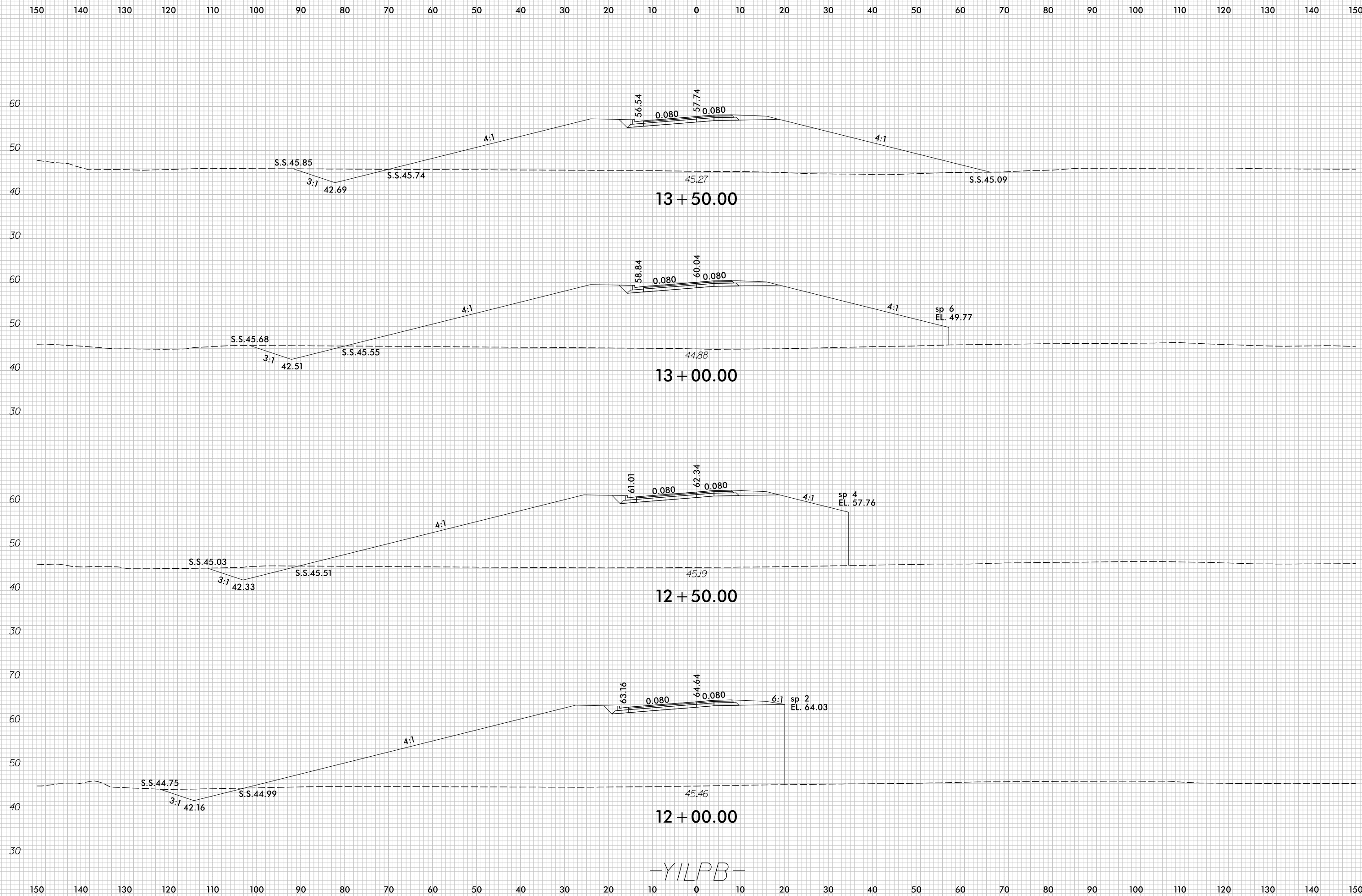

-YILPB-

7/5/2017
r:\Roadway\XSC\U4751_Rdu_xPL_YILPB.dgn
c:\proves

8/23/99

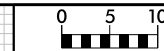

PROJ. REFERENCE NO.	SHEET NO.
U-4751	X-142

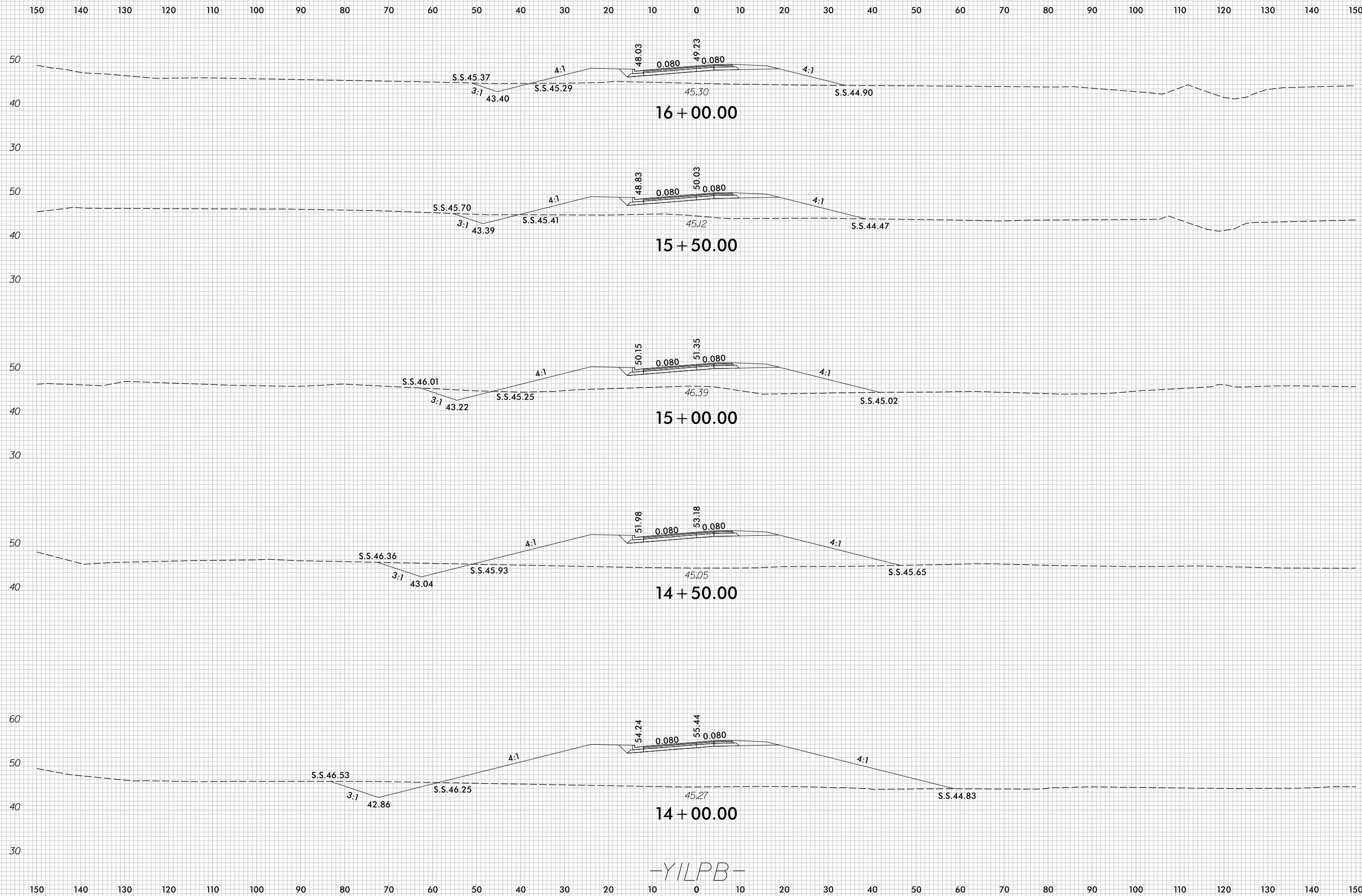

-YILPB-

7/5/2017
r:\Roadway\XSC\U4751_Rdu_XPL_YILPB.dgn
cproves

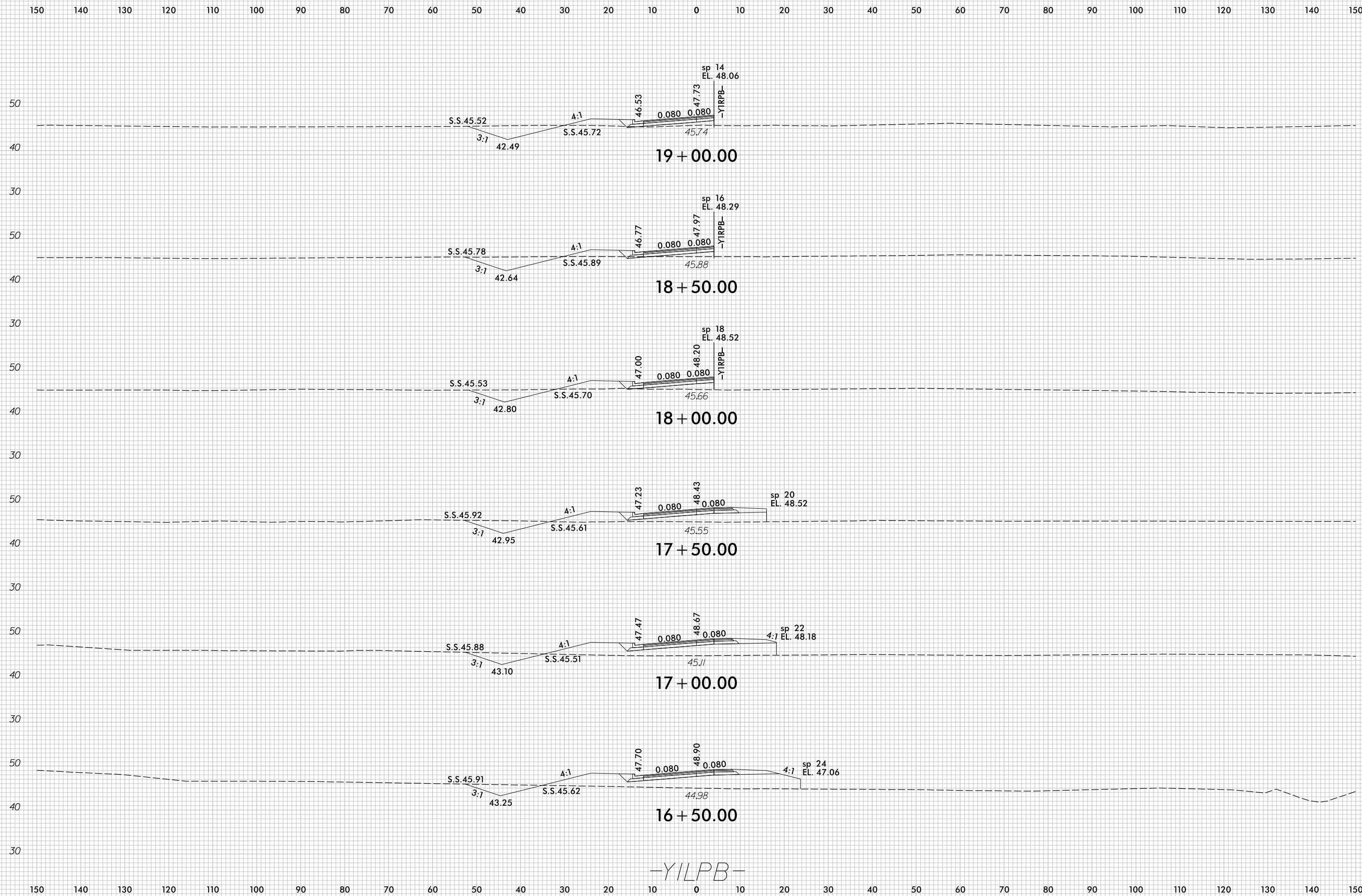

8/23/99

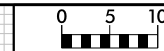

PROJ. REFERENCE NO.	SHEET NO.
U-4751	X-144

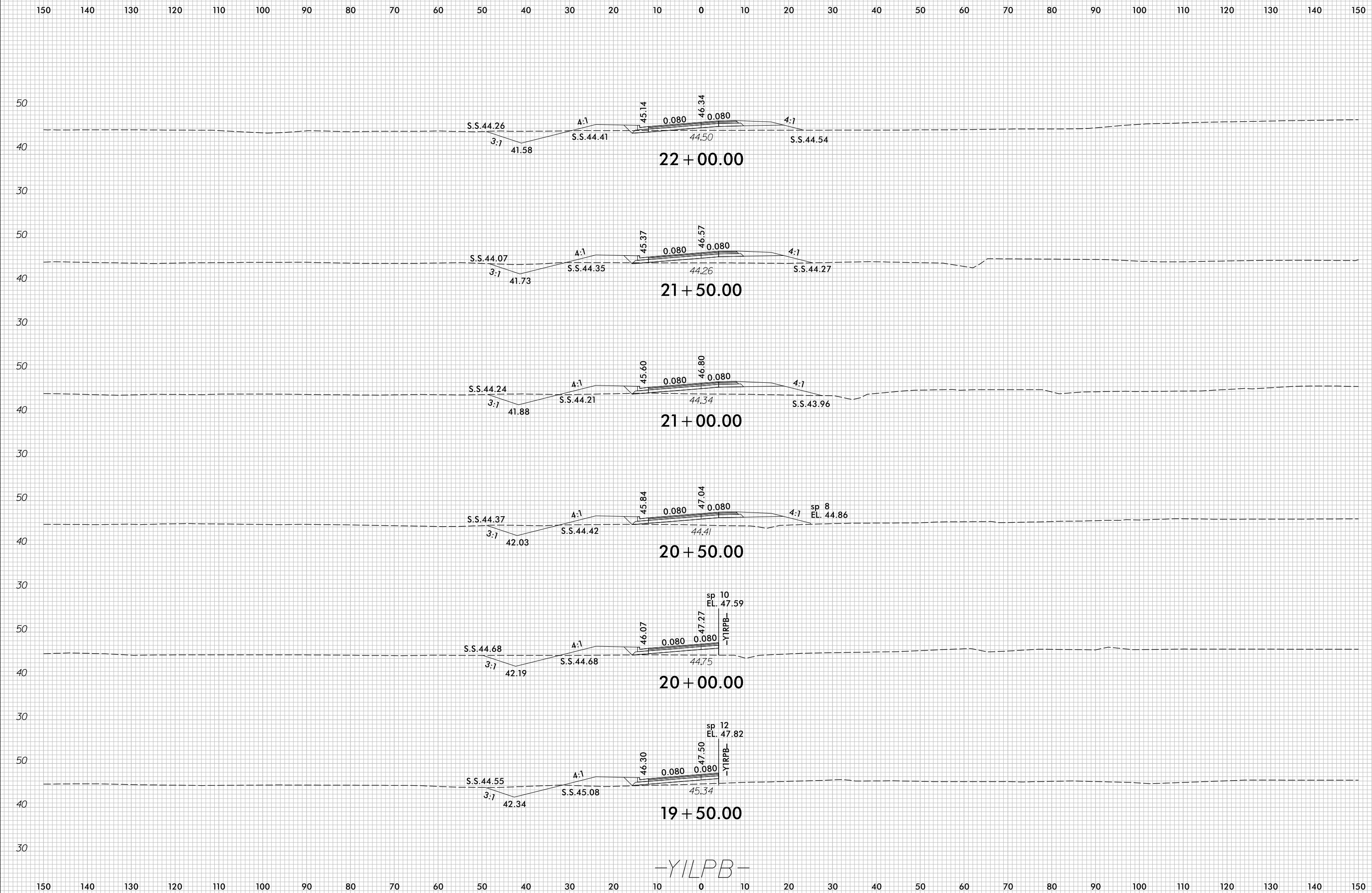

7/5/2017
r:\Roadway\XSC\U4751_Rdu_xPL_YILPB.dgn
c:\proves

-YILPB-

8/23/99



PROJ. REFERENCE NO.	SHEET NO.
U-4751	X-145

150 140 130 120 110 100 90 80 70 60 50 40 30 20 10 0 10 20 30 40 50 60 70 80 90 100 110 120 130 140 150

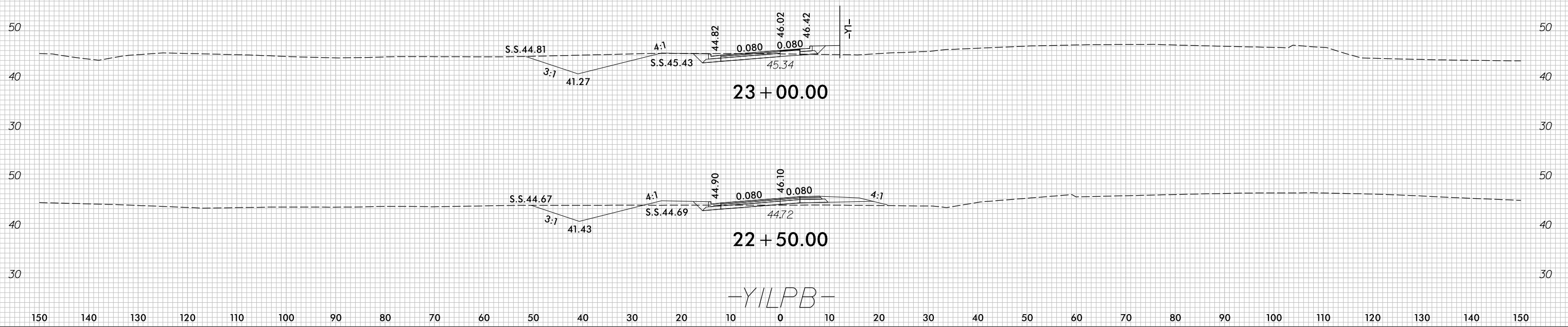

7/5/2017
 r:\Roadway\XSC\U4751_Rdu_xPL_YILPB.dgn
 c:\proves

8/23/99

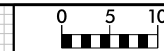

PROJ. REFERENCE NO.	SHEET NO.
U-4751	X-146

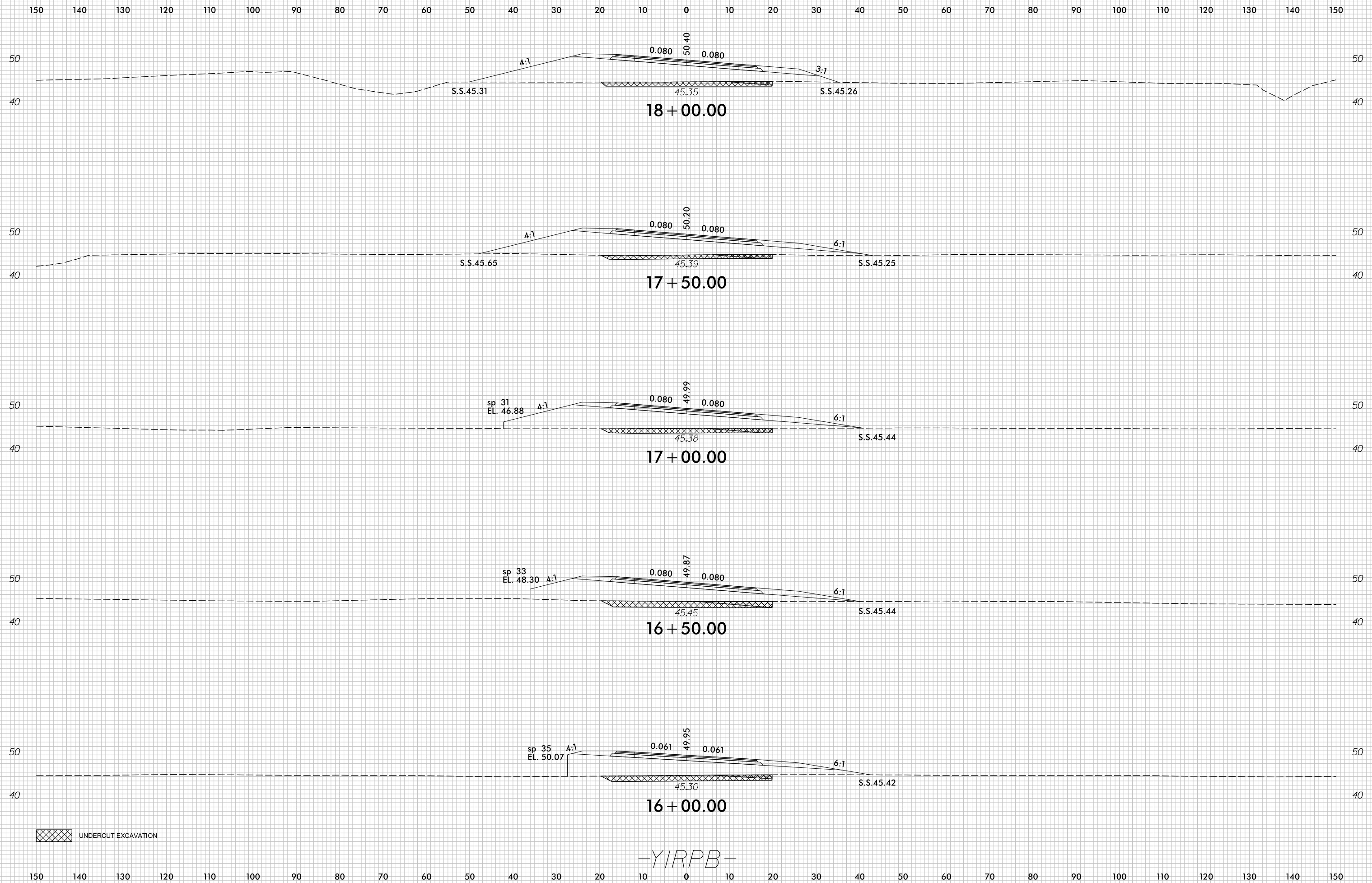

UNDERCUT EXCAVATION

-YIRPB-

7/5/2017
 r:\Roadway\XSC\U4751_Rdy_XPL_YIRPB.dgn
 c:\proves

8/23/99

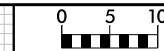

PROJ. REFERENCE NO.	SHEET NO.
U-4751	X-147

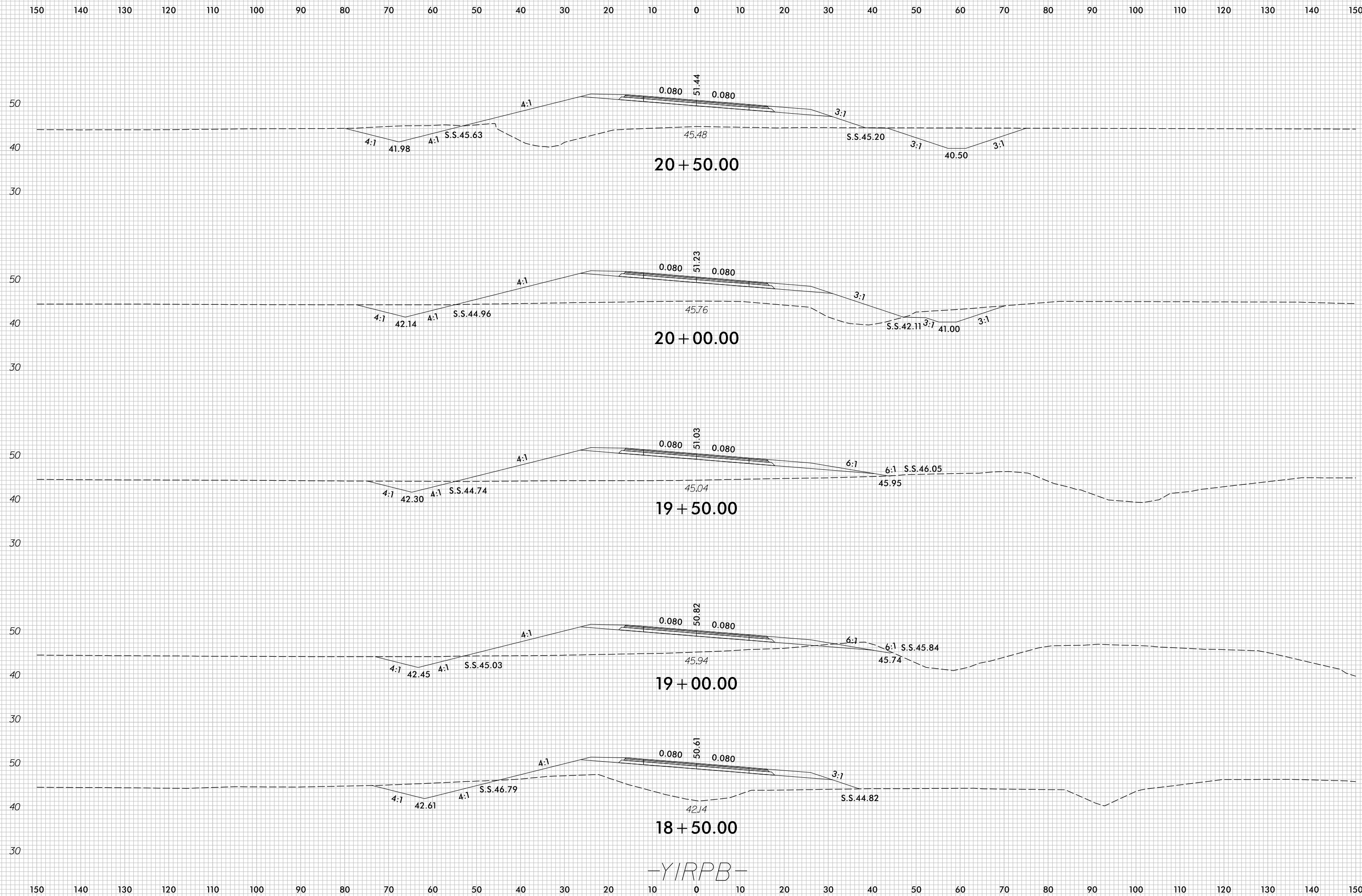

7/5/2017
r:\Roadway\XSC\U4751_Rdy_XPL_YIRPB.dgn
c:\proves

8/23/99

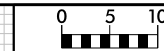

PROJ. REFERENCE NO.	SHEET NO.
U-4751	X-148

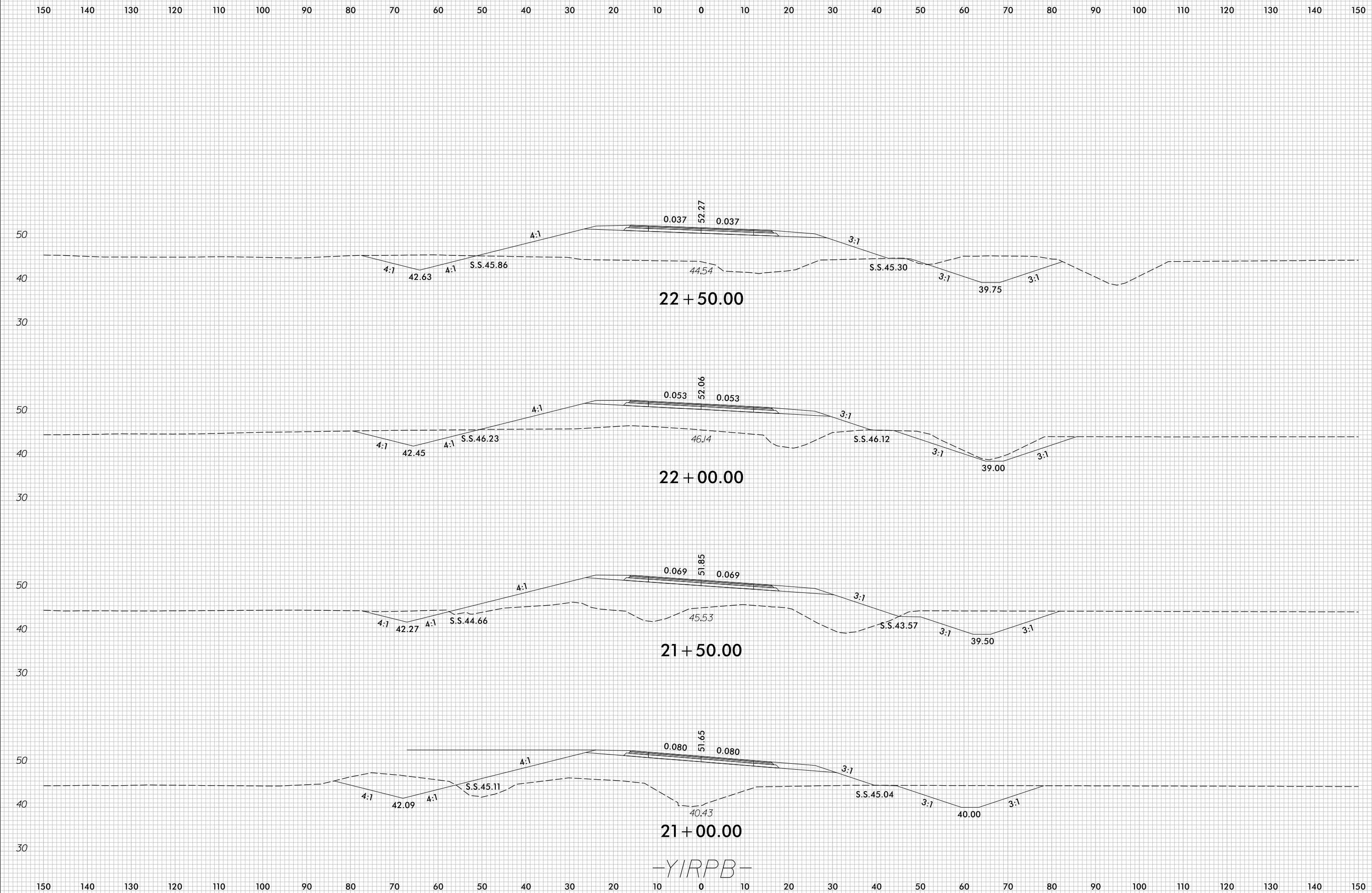

-YIRPB-

7/5/2017
r:\Roadway\XSC\U4751_Rdy_xPL_YIRPB.dgn
cproves

8/23/99

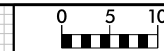

PROJ. REFERENCE NO.	SHEET NO.
U-4751	X-149

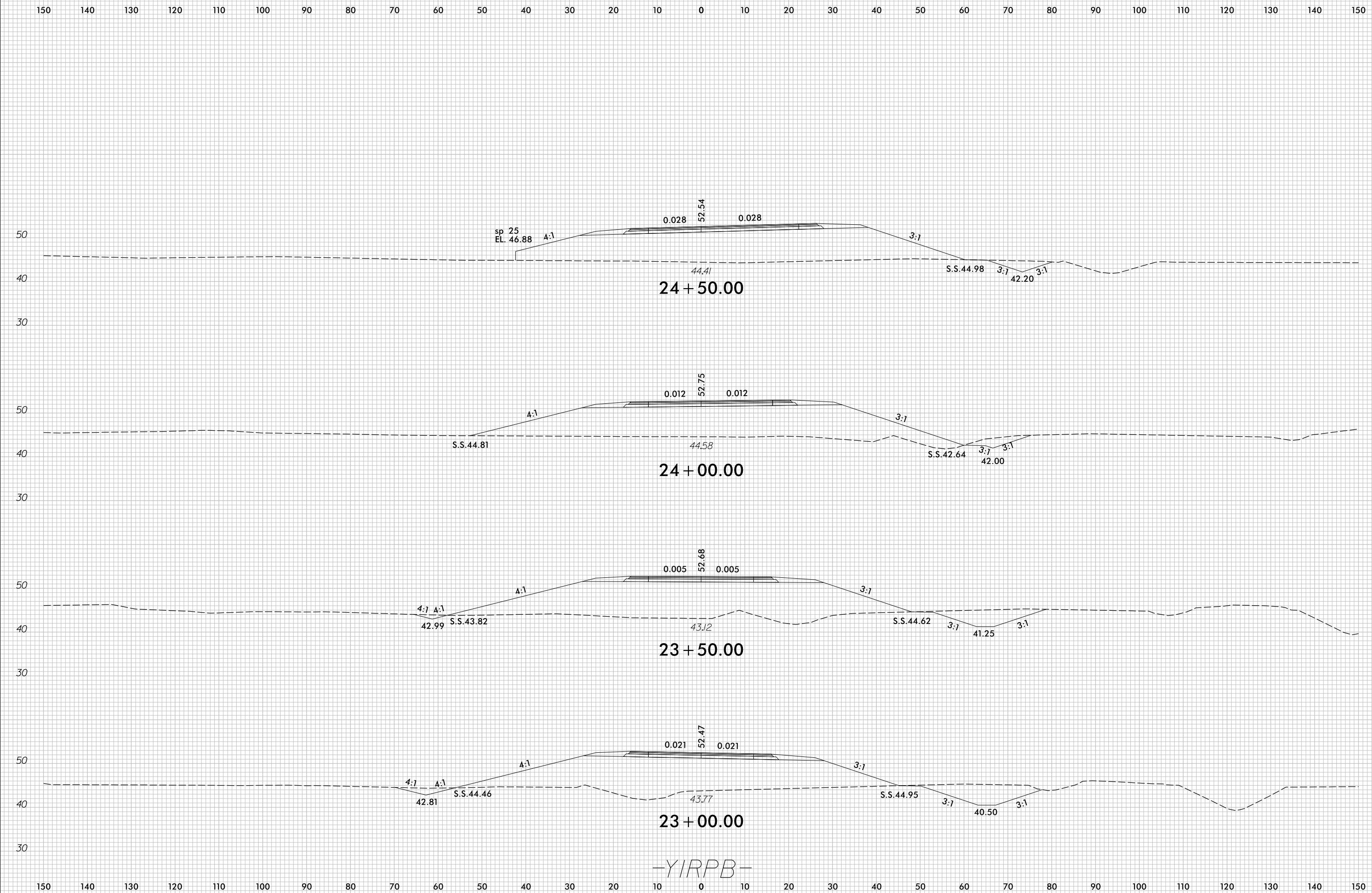

-YIRPB-

7/5/2017
r:\Roadway\XSC\U4751_Rdy_XPL_YIRPB.dgn
c:\proves

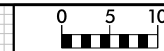

150 140 130 120 110 100 90 80 70 60 50 40 30 20 10 0 10 20 30 40 50 60 70 80 90 100 110 120 130 140 150

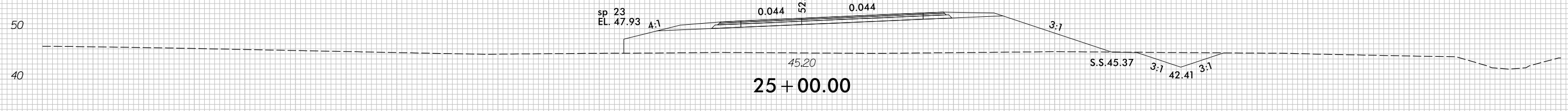
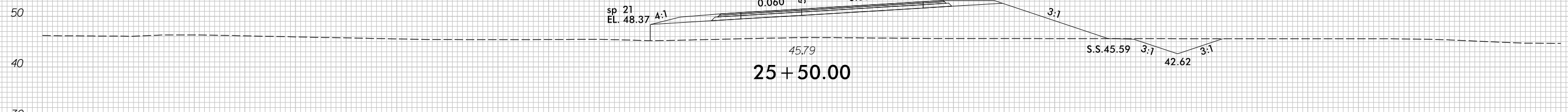
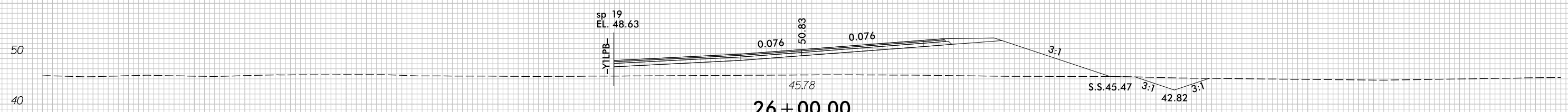
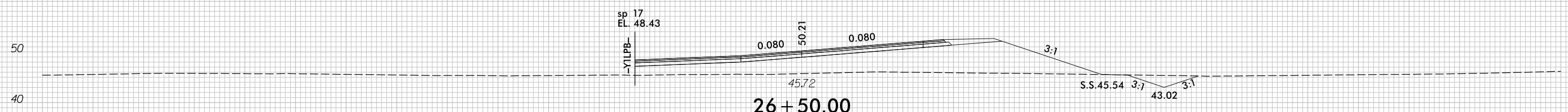
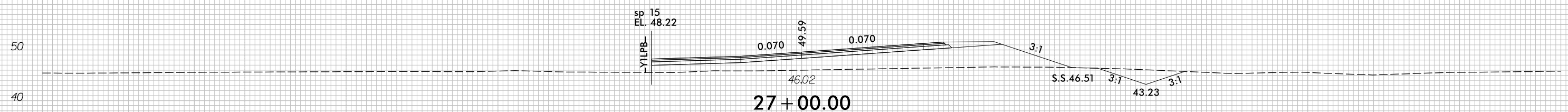

150 140 130 120 110 100 90 80 70 60 50 40 30 20 10 0 10 20 30 40 50 60 70 80 90 100 110 120 130 140 150

8/23/99

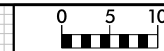

PROJ. REFERENCE NO.	SHEET NO.
U-4751	X-151

150 140 130 120 110 100 90 80 70 60 50 40 30 20 10 0 10 20 30 40 50 60 70 80 90 100 110 120 130 140 150

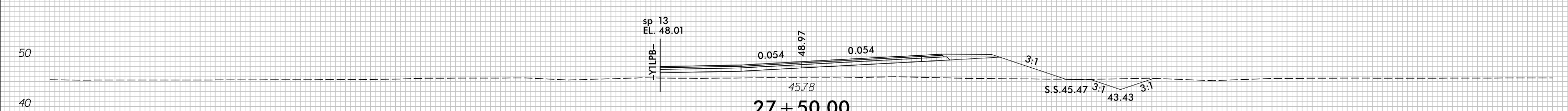
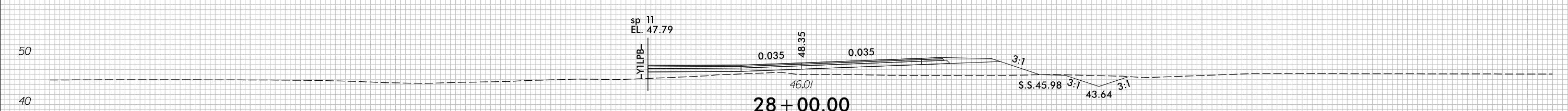
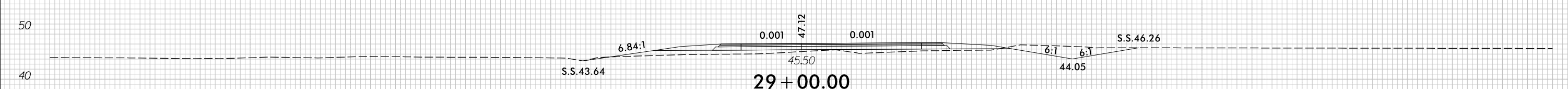
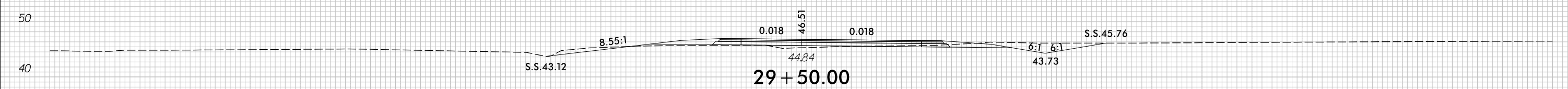

-YIRPB-

150 140 130 120 110 100 90 80 70 60 50 40 30 20 10 0 10 20 30 40 50 60 70 80 90 100 110 120 130 140 150

7/5/2017
r:\Roadway\XSC\U4751_Rdy_XPL_YIRPB.dgn
c:\proves

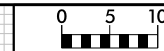

150 140 130 120 110 100 90 80 70 60 50 40 30 20 10 0 10 20 30 40 50 60 70 80 90 100 110 120 130 140 150

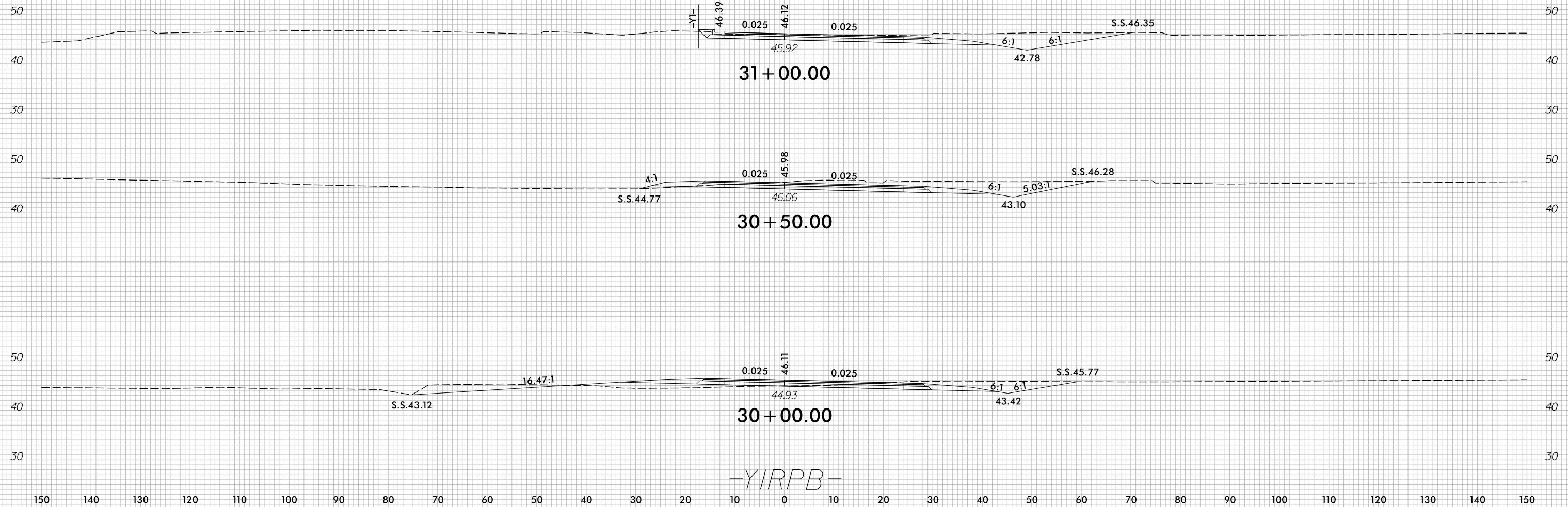

8/23/99

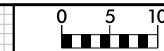

PROJ. REFERENCE NO.	SHEET NO.
U-4751	X-153

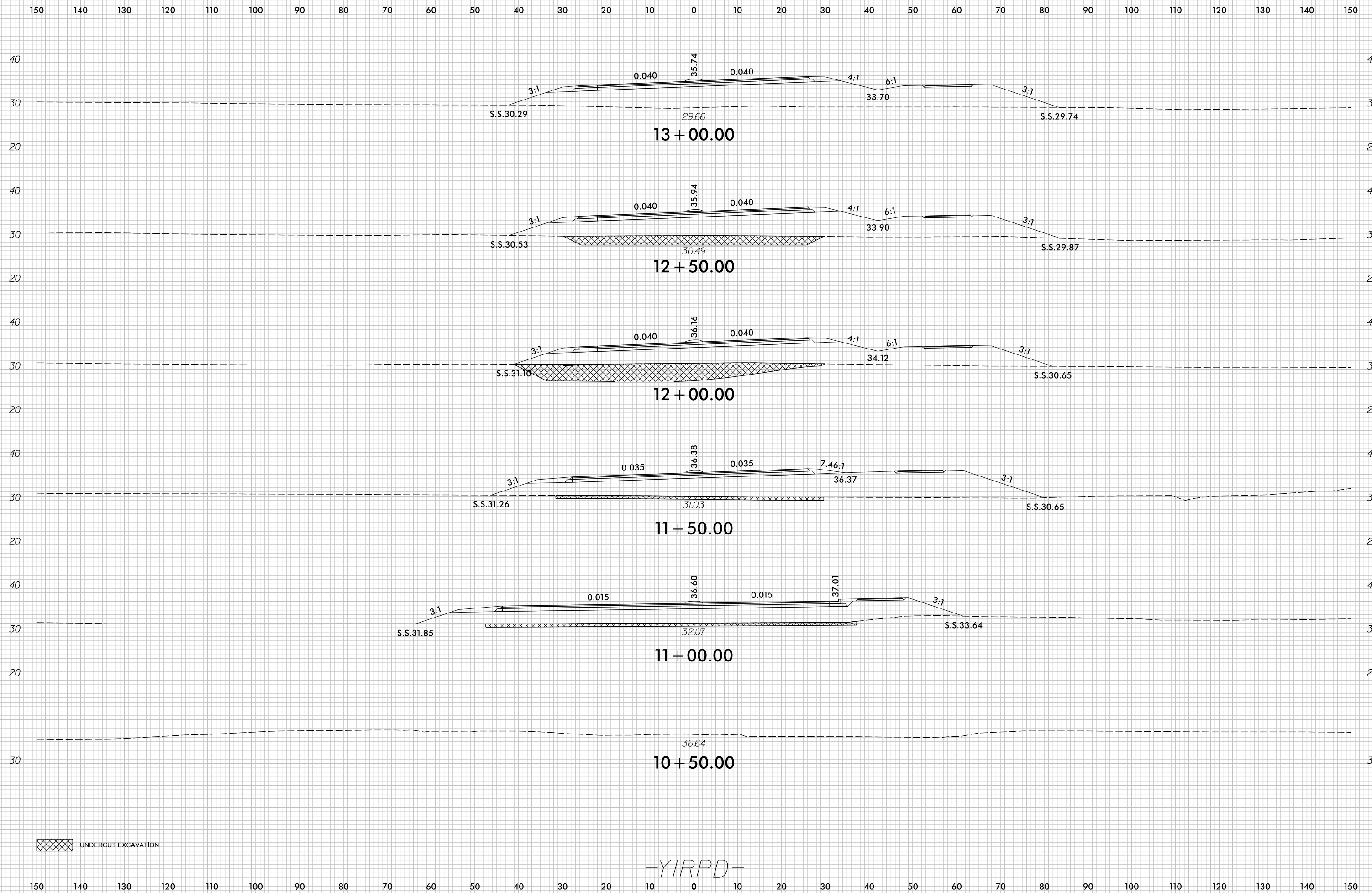

UNDERCUT EXCAVATION

-YIRPD-

7/5/2017
 r:\Roadway\XSC\U4751_Rdy_XPL_YIRPD.dgn
 c:\proves

150 140 130 120 110 100 90 80 70 60 50 40 30 20 10 0 10 20 30 40 50 60 70 80 90 100 110 120 130 140 150

8/23/99



PROJ. REFERENCE NO.
U-4751

SHEET NO.
X-154

150 140 130 120 110 100 90 80 70 60 50 40 30 20 10 0 10 20 30 40 50 60 70 80 90 100 110 120 130 140 150

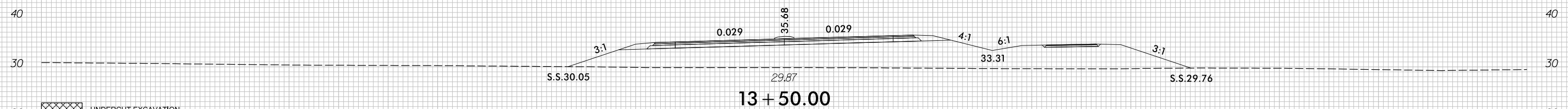
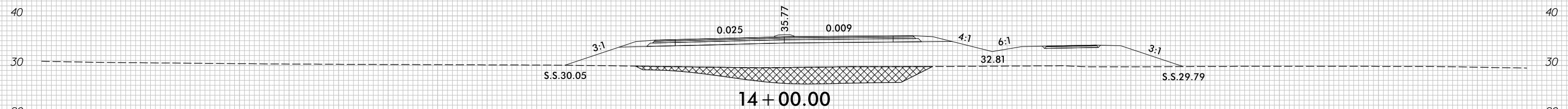
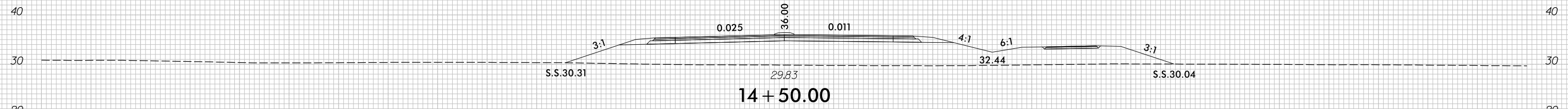
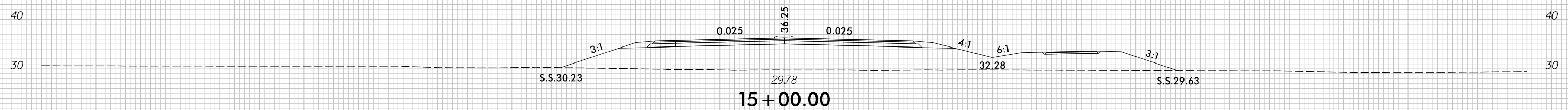
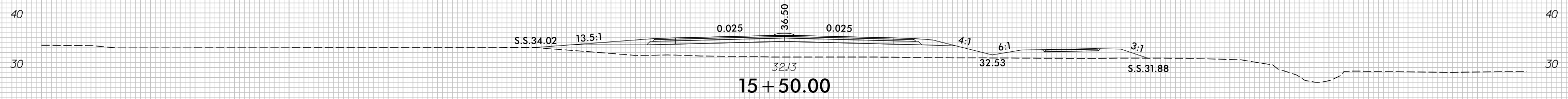
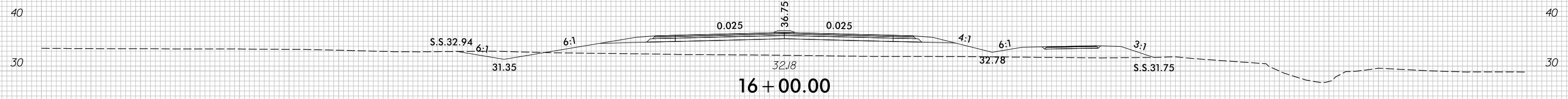

-YIRPD-

150 140 130 120 110 100 90 80 70 60 50 40 30 20 10 0 10 20 30 40 50 60 70 80 90 100 110 120 130 140 150

7/5/2017
r:\Roadway\XSC\U4751_Rdu_XPL_YIRPD.dgn
c:\proves

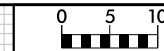

150 140 130 120 110 100 90 80 70 60 50 40 30 20 10 0 10 20 30 40 50 60 70 80 90 100 110 120 130 140 150

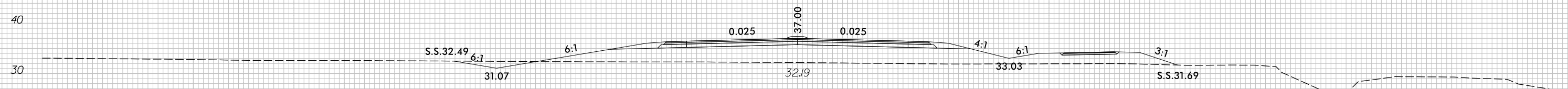
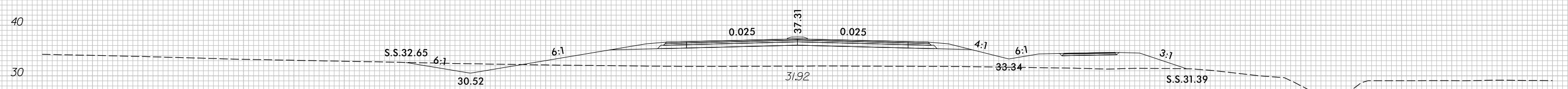
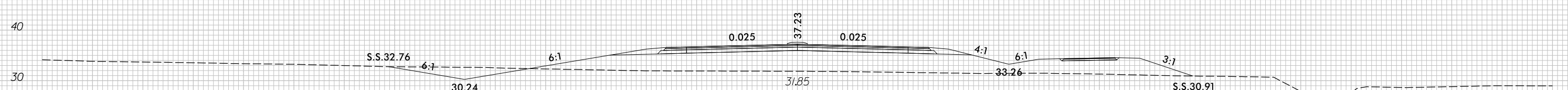
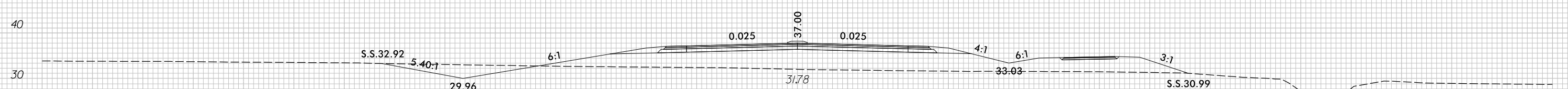

150 140 130 120 110 100 90 80 70 60 50 40 30 20 10 0 10 20 30 40 50 60 70 80 90 100 110 120 130 140 150

-YIRPD-

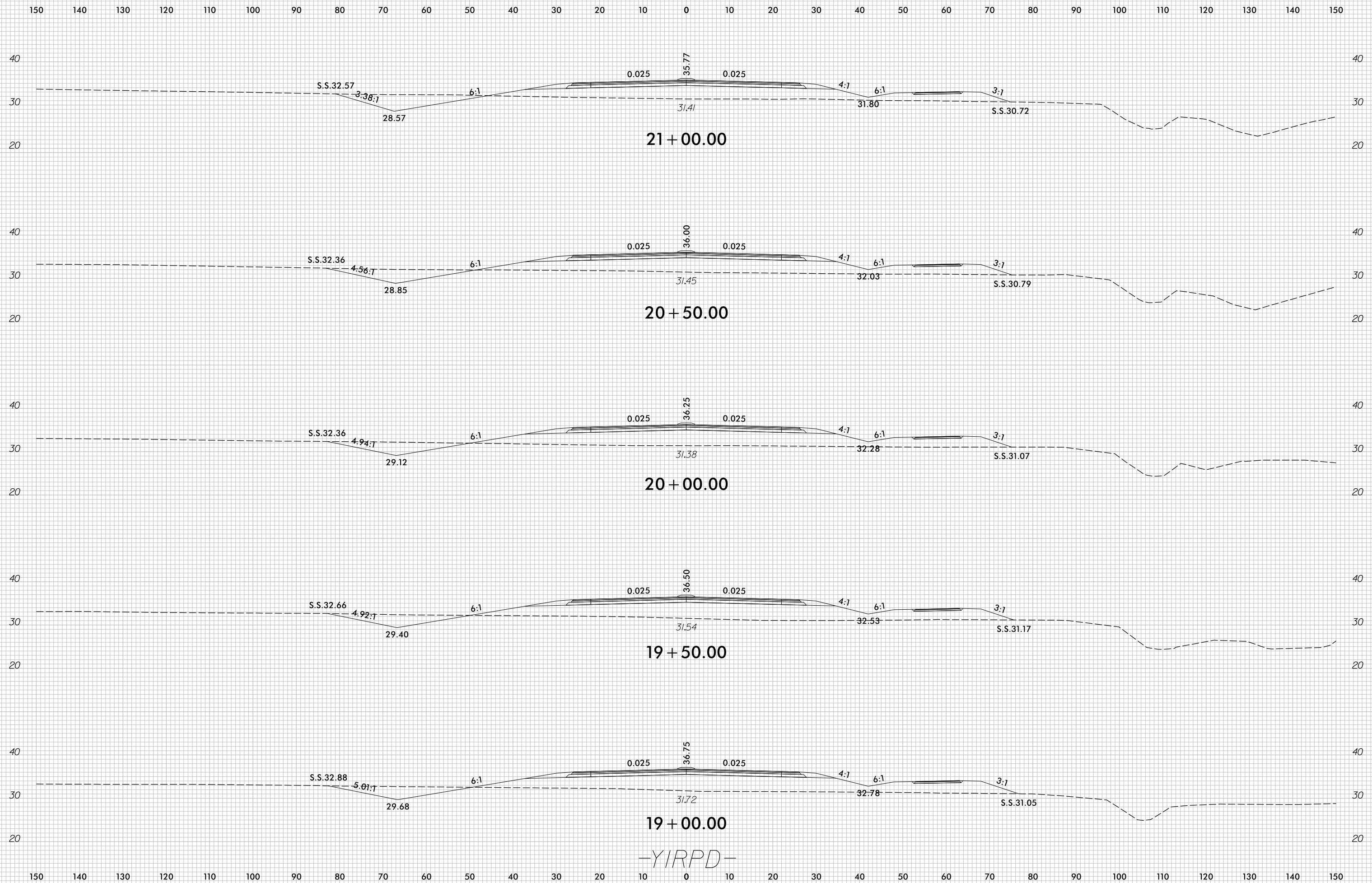

8/23/99

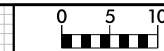

PROJ. REFERENCE NO.	SHEET NO.
U-4751	X-157

150 140 130 120 110 100 90 80 70 60 50 40 30 20 10 0 10 20 30 40 50 60 70 80 90 100 110 120 130 140 150

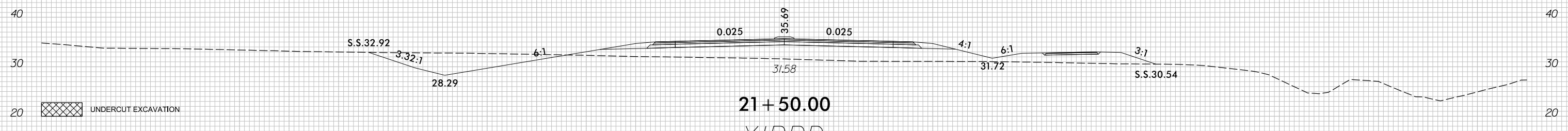
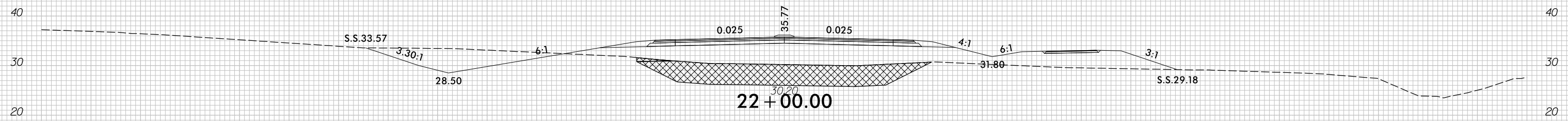
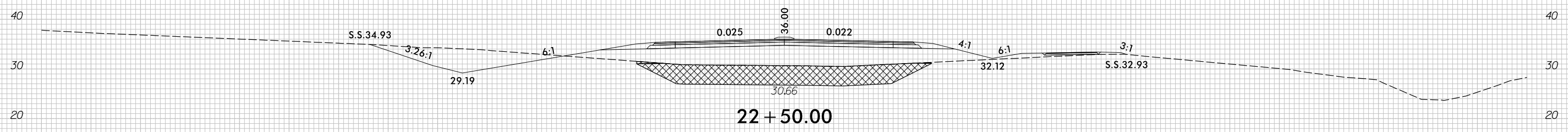
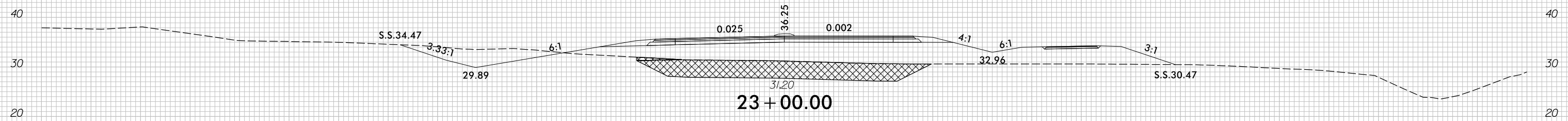

UNDERCUT EXCAVATION

-YIRPD-

150 140 130 120 110 100 90 80 70 60 50 40 30 20 10 0 10 20 30 40 50 60 70 80 90 100 110 120 130 140 150

7/5/2017
r:\Roadway\XSC\U4751_Rdy_XPL_YIRPD.dgn
cproves

8/23/99

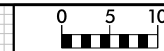

PROJ. REFERENCE NO.	SHEET NO.
U-4751	X-158

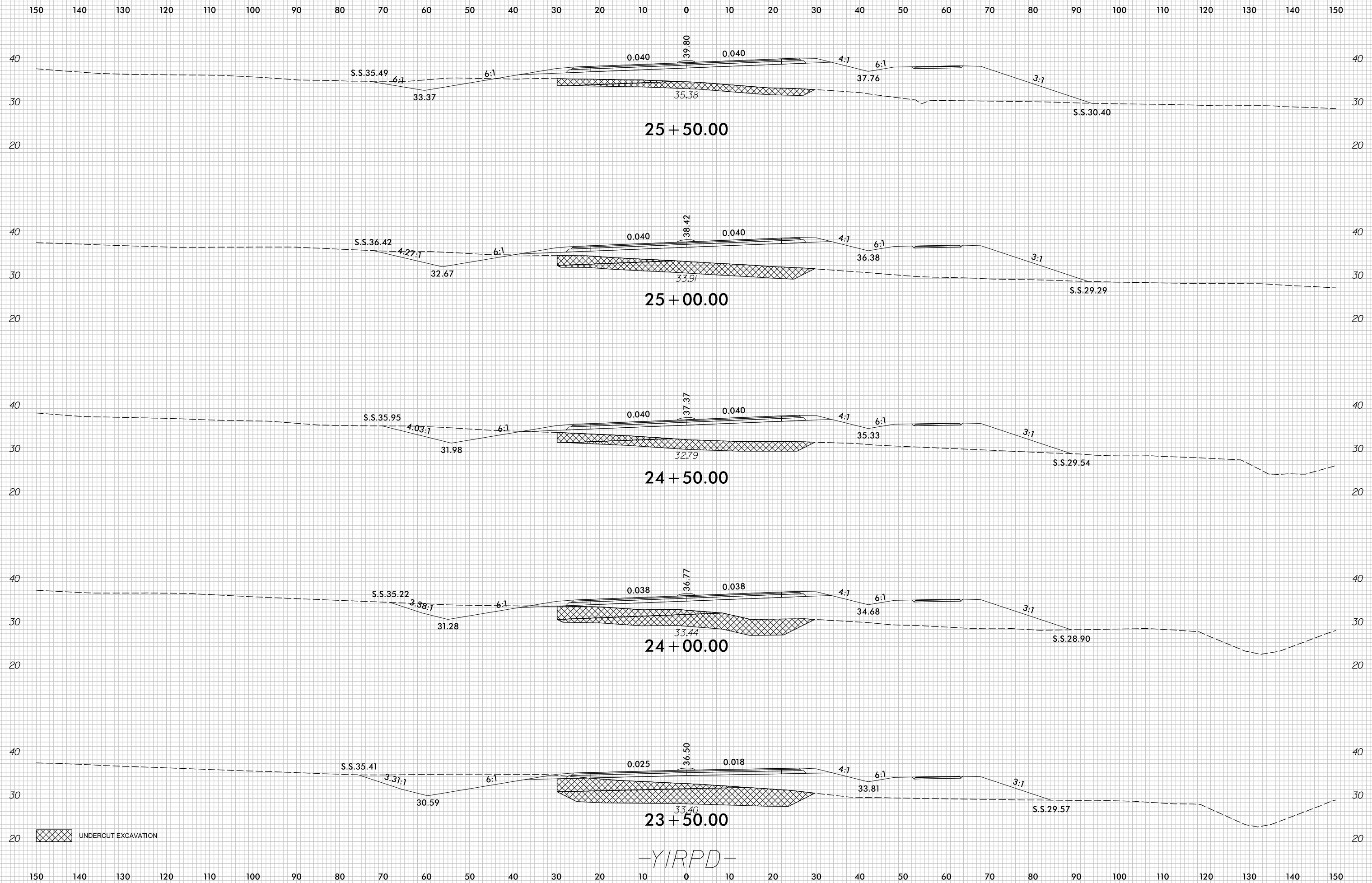

7/5/2017
r:\Roadway\XSC\U4751_Rdy_XPL_YIRPD.dgn
cpraves

8/23/99

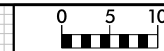

PROJ. REFERENCE NO.	SHEET NO.
U-4751	X-159

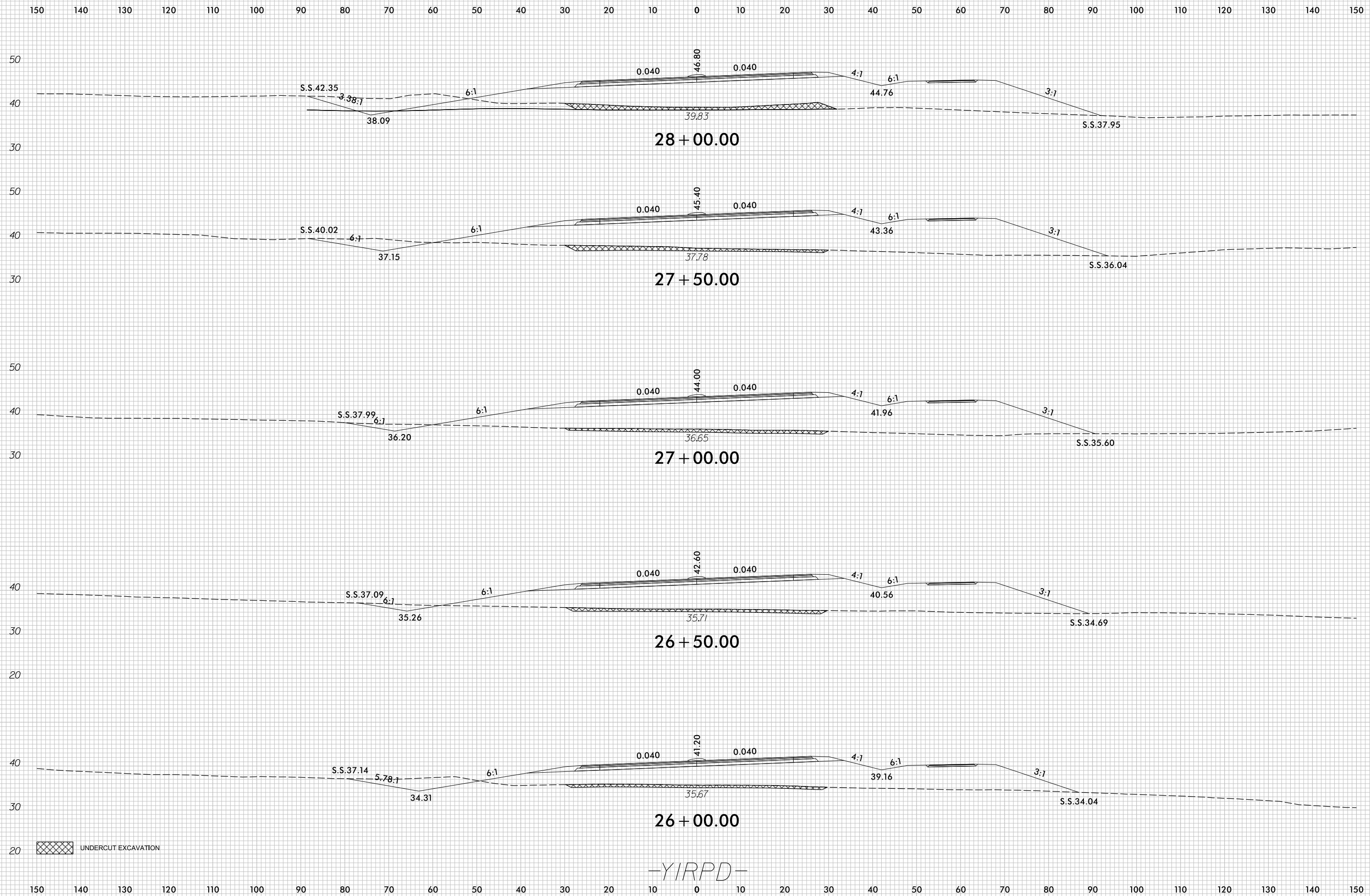

UNDERCUT EXCAVATION

-YIRPD-

7/5/2017
r:\Roadway\XSC\U4751_Rdy_XPL_YIRPD.dgn
c:\proves

8/23/99

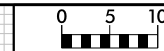

PROJ. REFERENCE NO.
U-4751

SHEET NO.
X-160

150 140 130 120 110 100 90 80 70 60 50 40 30 20 10 0 10 20 30 40 50 60 70 80 90 100 110 120 130 140 150

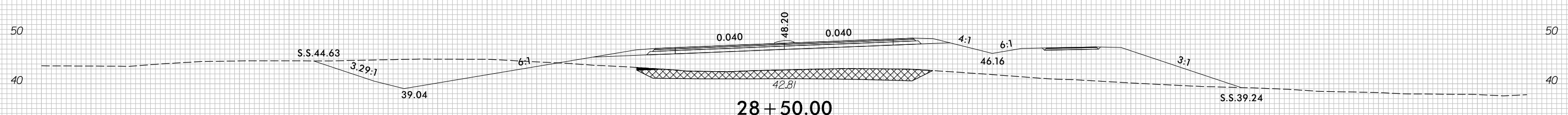
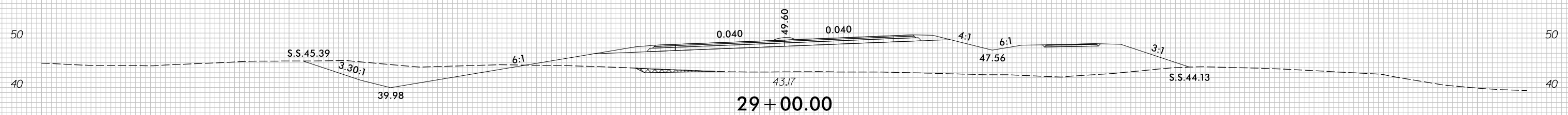
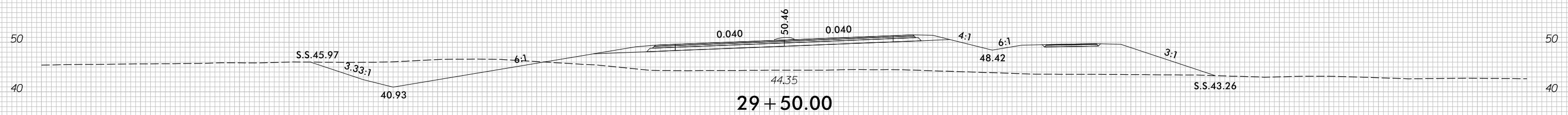
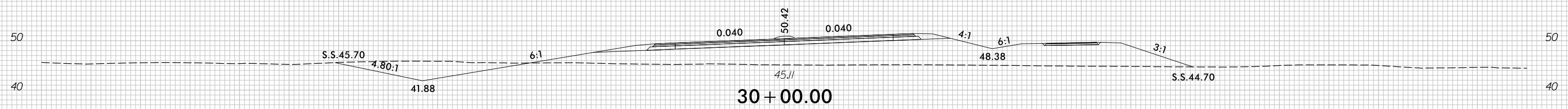
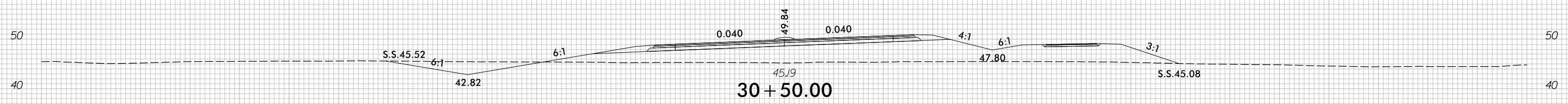

-YIRPD-

150 140 130 120 110 100 90 80 70 60 50 40 30 20 10 0 10 20 30 40 50 60 70 80 90 100 110 120 130 140 150

7/5/2017
r:\Roadway\XSC\U4751_Rdu_XPL_YIRPD.dgn
c:\proves

8/23/99

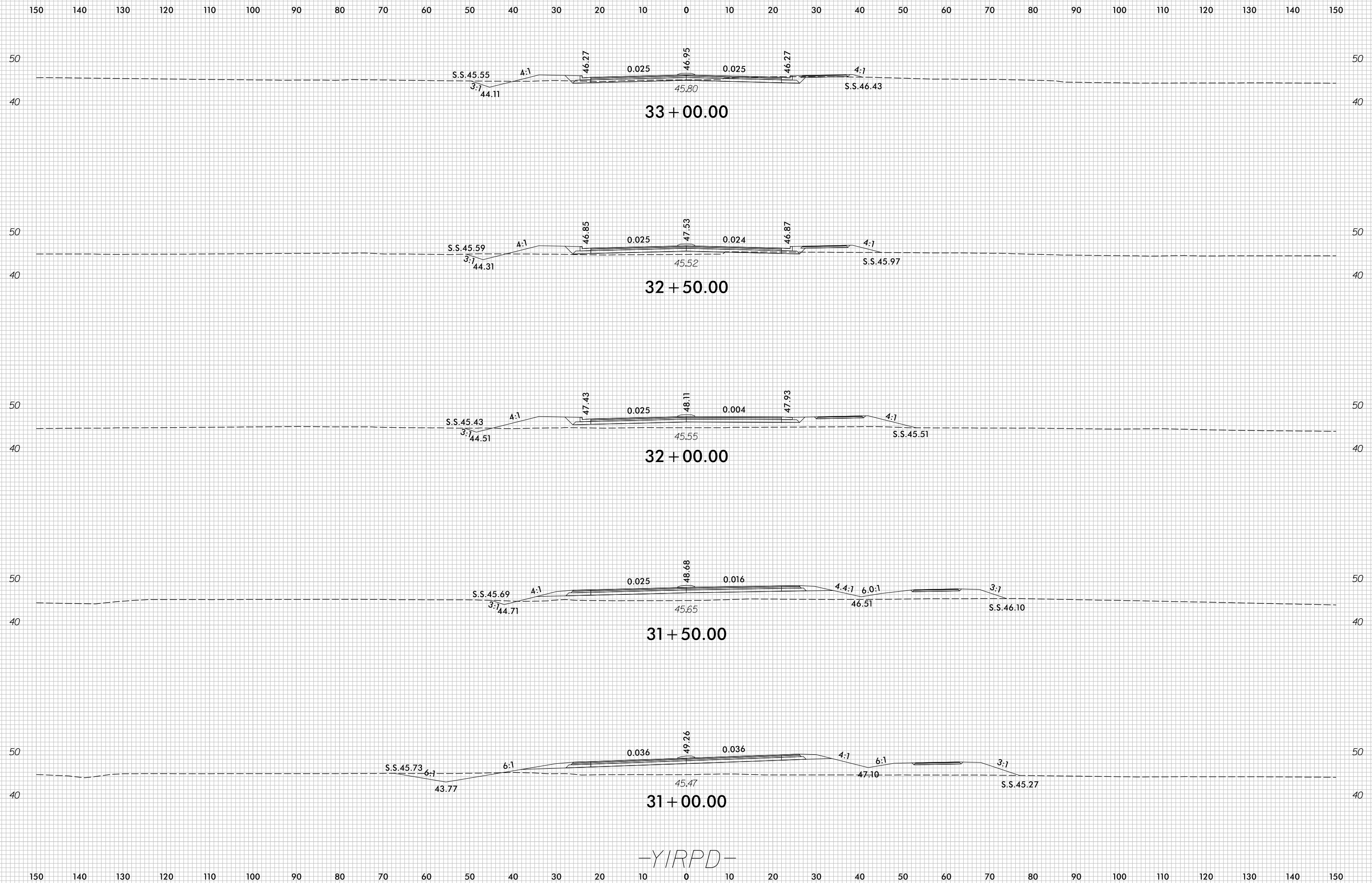

-YIRPD-

7/5/2017
r:\Roadway\XSC\U4751_Rdy_XPL_YIRPD.dgn
cproves

8/23/99

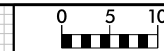

PROJ. REFERENCE NO.	SHEET NO.
U-4751	X-162

150 140 130 120 110 100 90 80 70 60 50 40 30 20 10 0 10 20 30 40 50 60 70 80 90 100 110 120 130 140 150

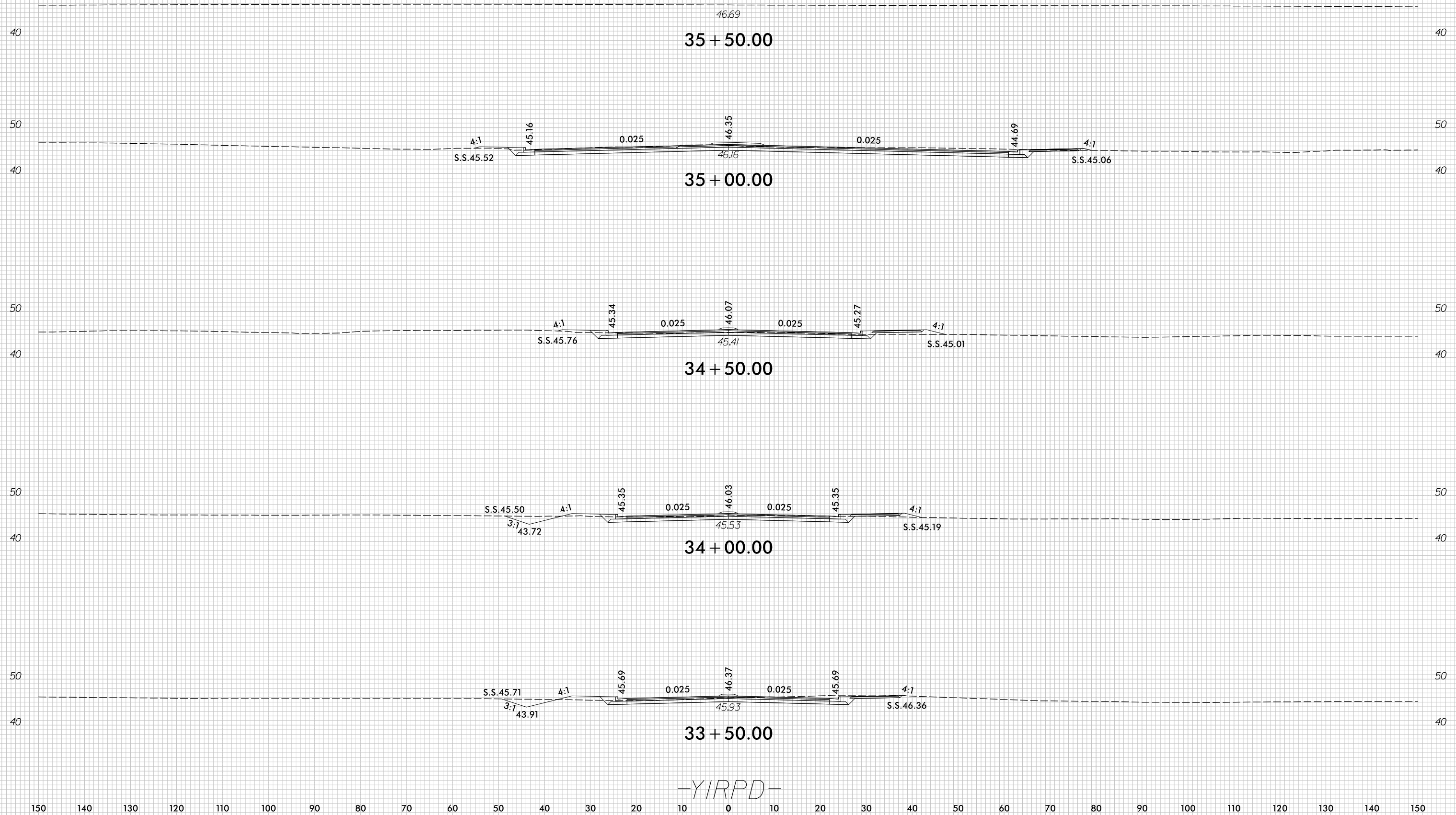

-YIRPD-

7/5/2017
r:\Roadway\XSC\U4751_Rdy_XPL_YIRPD.dgn
cproves

8/23/99

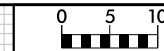

PROJ. REFERENCE NO.	SHEET NO.
U-4751	X-163

150 140 130 120 110 100 90 80 70 60 50 40 30 20 10 0 10 20 30 40 50 60 70 80 90 100 110 120 130 140 150

END CONSTRUCTION -Y2- STA. 15 + 90.00

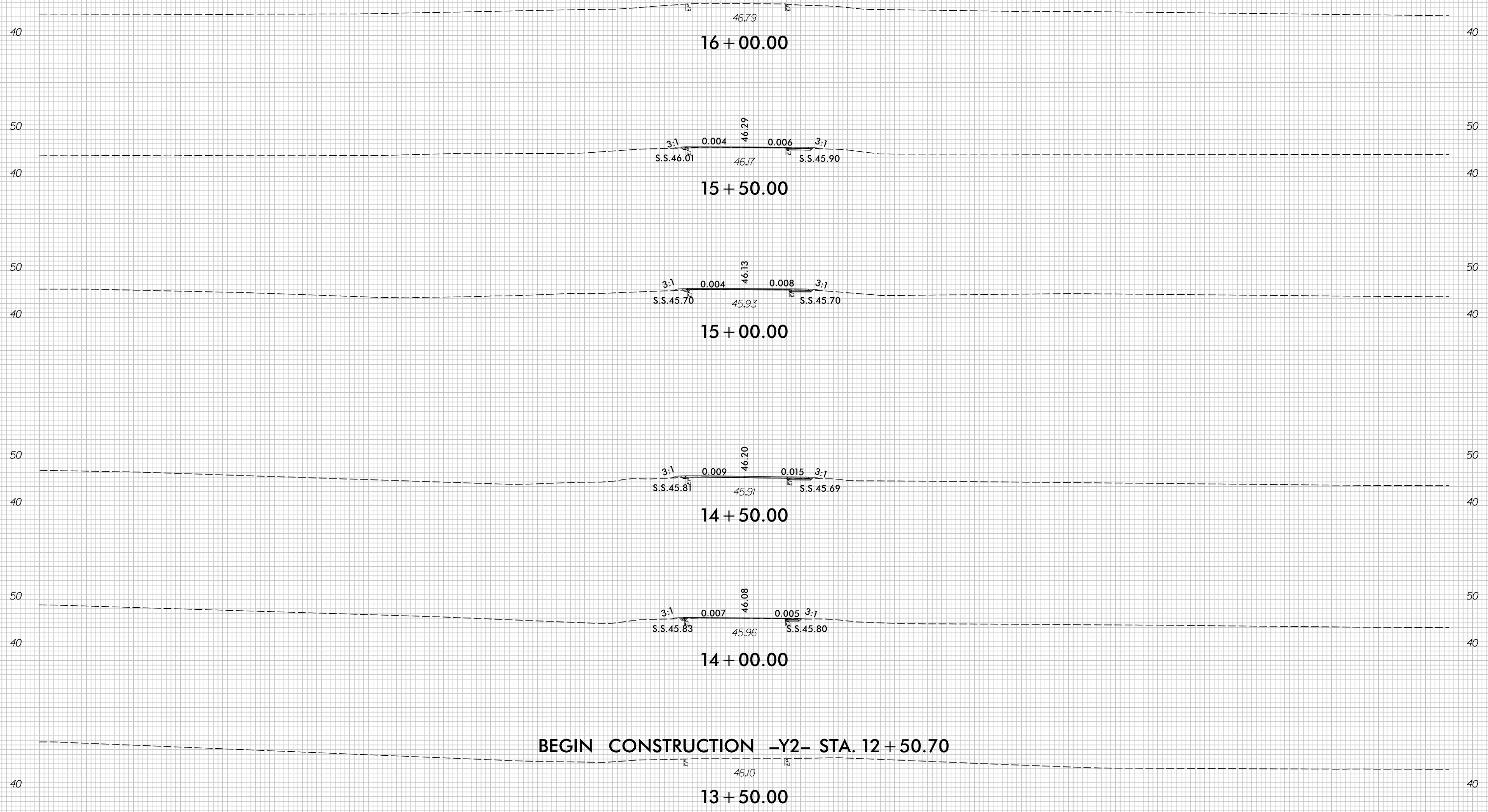

BEGIN CONSTRUCTION -Y2- STA. 12 + 50.70

-Y2-

150 140 130 120 110 100 90 80 70 60 50 40 30 20 10 0 10 20 30 40 50 60 70 80 90 100 110 120 130 140 150

7/5/2017
r:\Roadway\XSC\U4751_Rdu_XPL_Y2.dgn
c:\proves

8/23/99

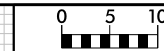

PROJ. REFERENCE NO.	SHEET NO.
U-4751	X-164

150 140 130 120 110 100 90 80 70 60 50 40 30 20 10 0 10 20 30 40 50 60 70 80 90 100 110 120 130 140 150

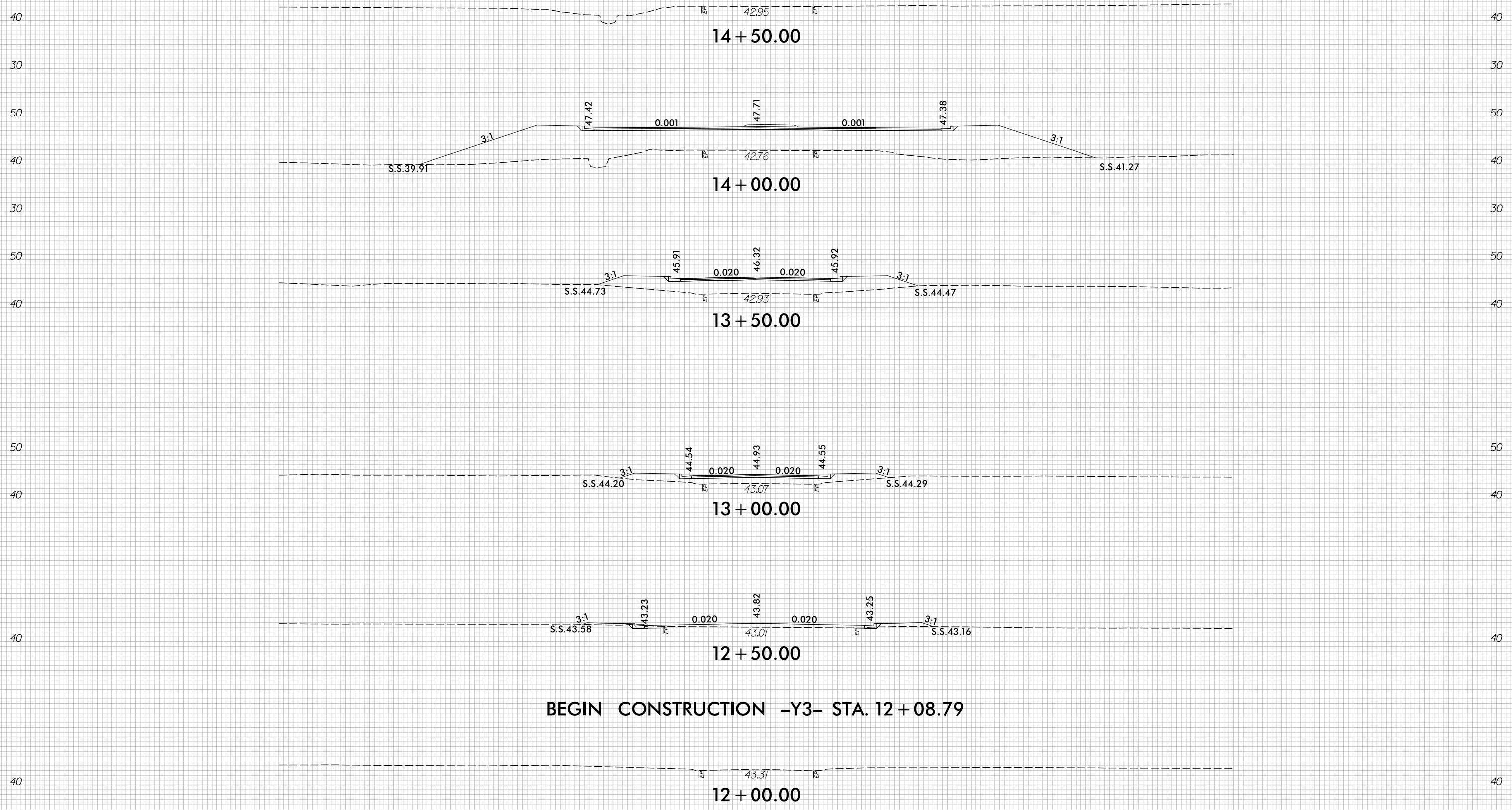

-Y3-

7/5/2017
r:\Roadway\XSC\U4751_Rdu_XPL_Y3.dgn
c:\proves

8/23/99

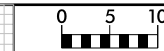

PROJ. REFERENCE NO.	SHEET NO.
U-4751	X-165

150 140 130 120 110 100 90 80 70 60 50 40 30 20 10 0 10 20 30 40 50 60 70 80 90 100 110 120 130 140 150

END CONSTRUCTION -Y3- STA. 16 + 50.90

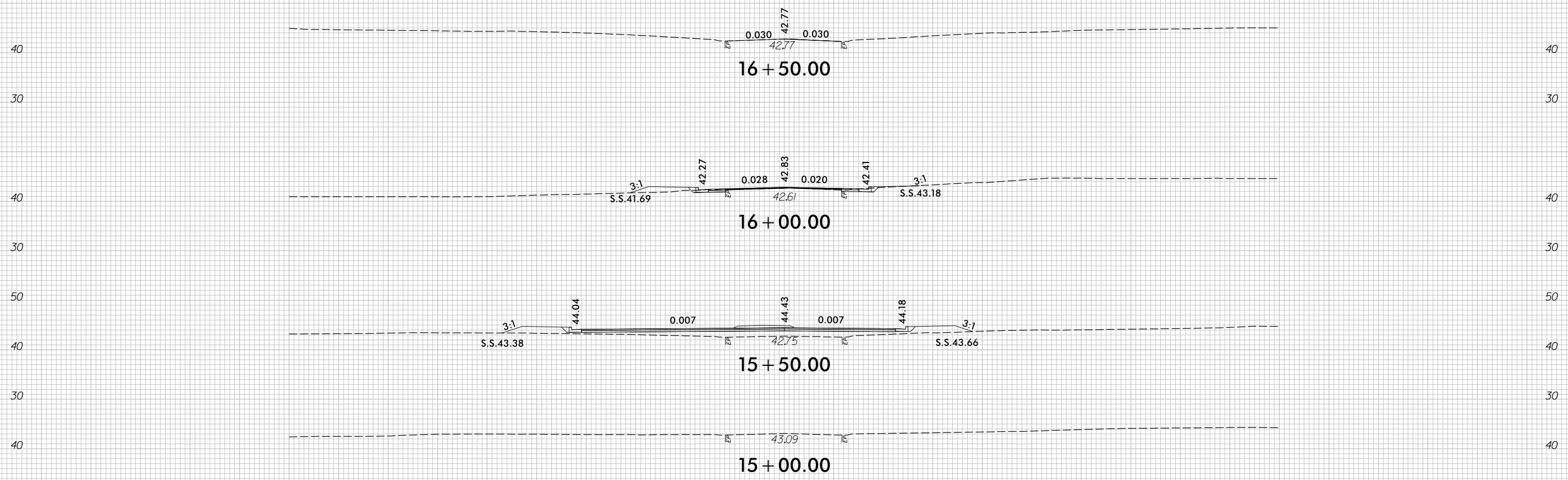

-Y3-

150 140 130 120 110 100 90 80 70 60 50 40 30 20 10 0 10 20 30 40 50 60 70 80 90 100 110 120 130 140 150

7/5/2017
r:\Roadway\XSC\U4751_Rdy_XPL_Y3.dgn
c:\proves

8/23/99



PROJ. REFERENCE NO.
U-4751

SHEET NO.
X-166

150 140 130 120 110 100 90 80 70 60 50 40 30 20 10 0 10 20 30 40 50 60 70 80 90 100 110 120 130 140 150

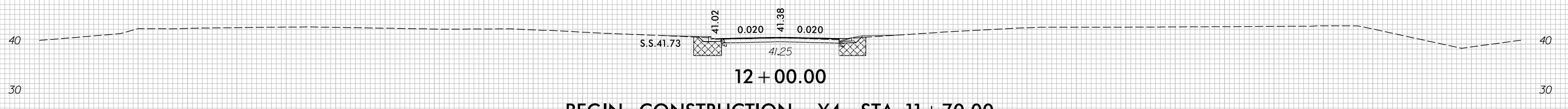
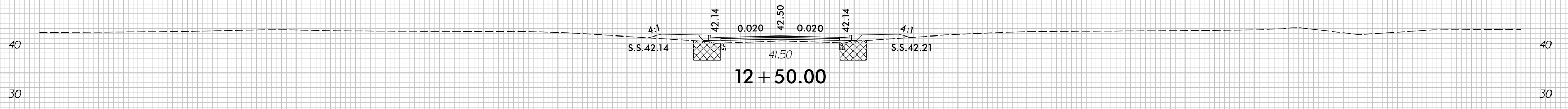
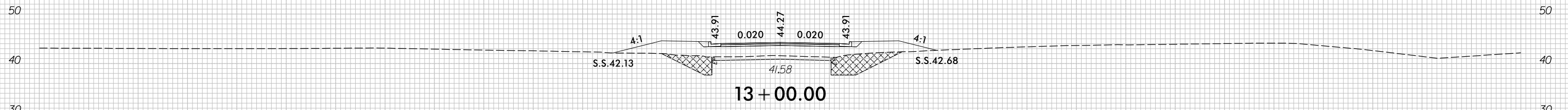
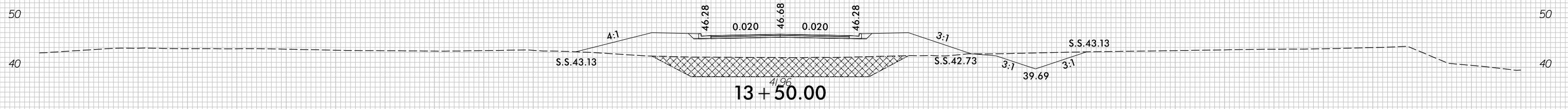
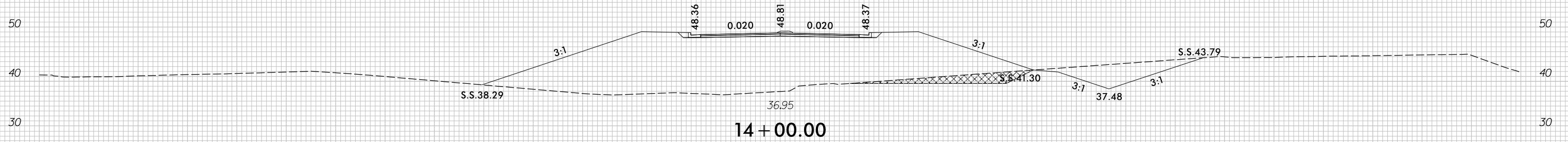

BEGIN CONSTRUCTION -Y4- STA. 11 + 70.00

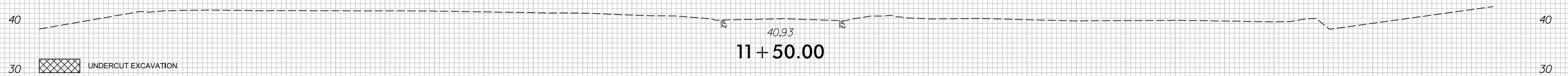

-Y4-

150 140 130 120 110 100 90 80 70 60 50 40 30 20 10 0 10 20 30 40 50 60 70 80 90 100 110 120 130 140 150

UNDERCUT EXCAVATION

7/5/2017
r:\Roadway\XSC\U4751_Rdy_XPL_Y4.dgn
c:\proves

8/23/99

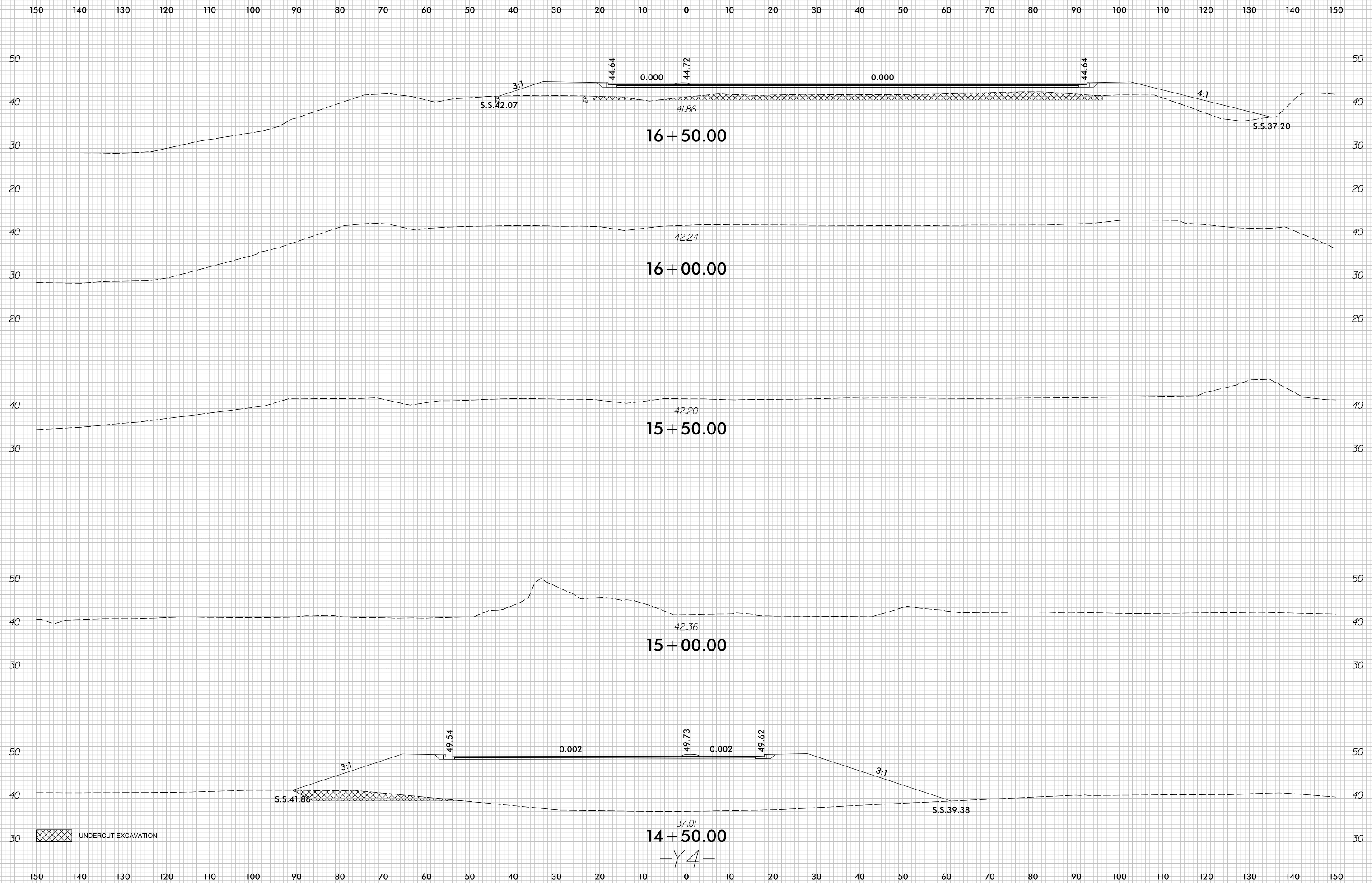

7/5/2017
r:\Roadway\XSC\U4751_Rdy_XPL_Y4.dgn
c:\proves

8/23/99

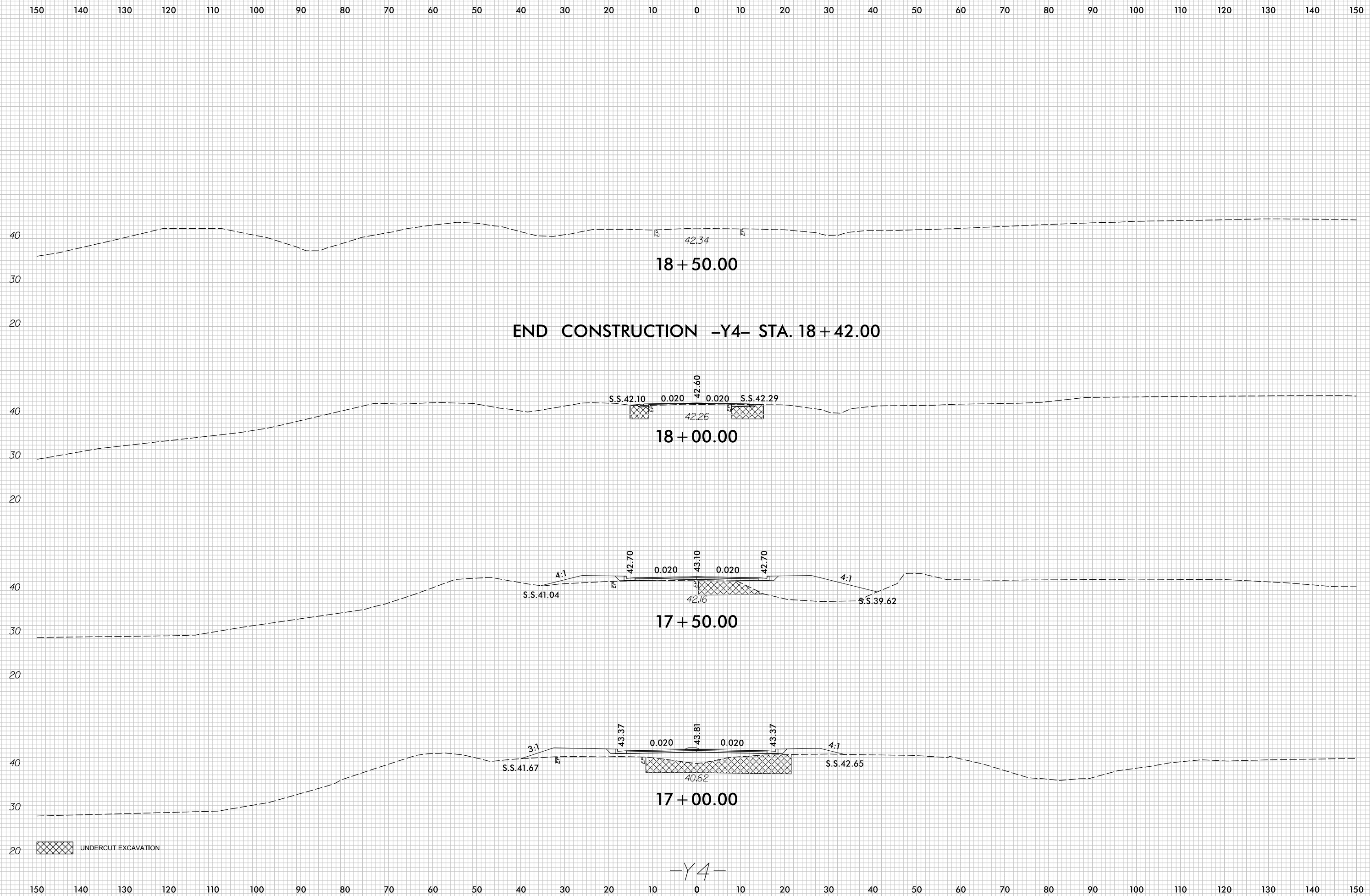

7/5/2017
r:\Roadway\XSC\U4751_Rdu_XPL_Y4.dgn
cpraves

8/23/99

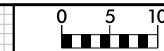

PROJ. REFERENCE NO. U-4751 SHEET NO. X-169

150 140 130 120 110 100 90 80 70 60 50 40 30 20 10 0 10 20 30 40 50 60 70 80 90 100 110 120 130 140 150

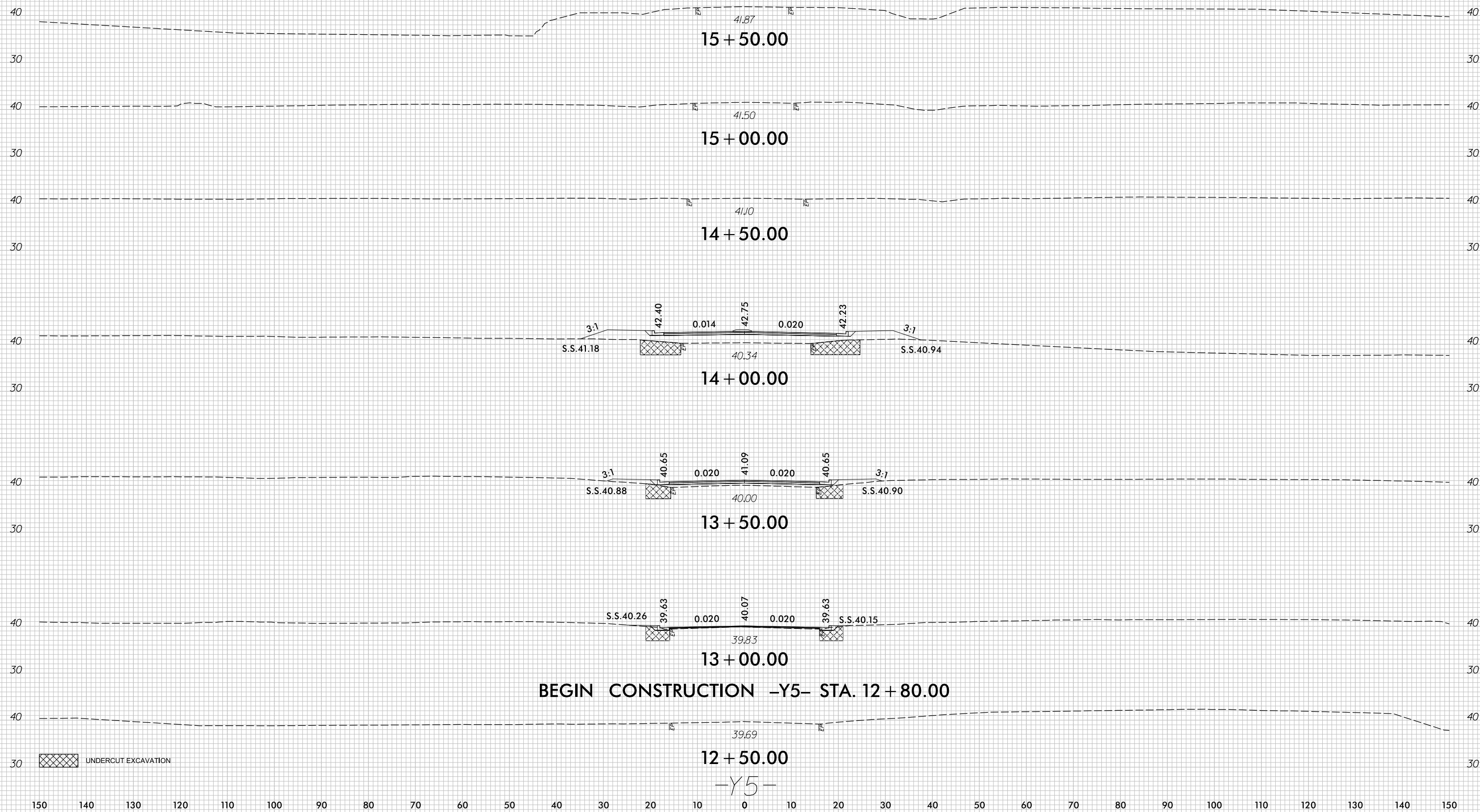

7/5/2017
r:\Roadway\XSC\U4751_Rdy_XPL_Y5.dgn
C:\Proves

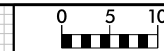

150 140 130 120 110 100 90 80 70 60 50 40 30 20 10 0 10 20 30 40 50 60 70 80 90 100 110 120 130 140 150

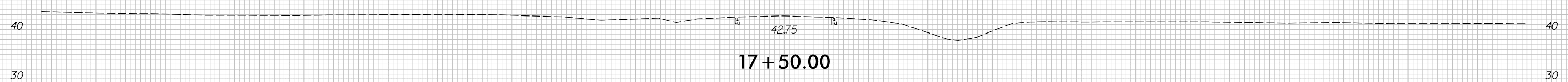

17 + 50.00

END CONSTRUCTION -Y5- STA. 17 + 00.00

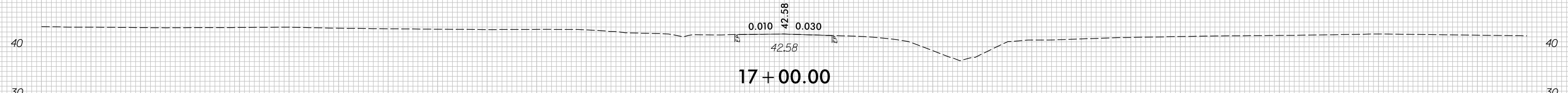

17 + 00.00

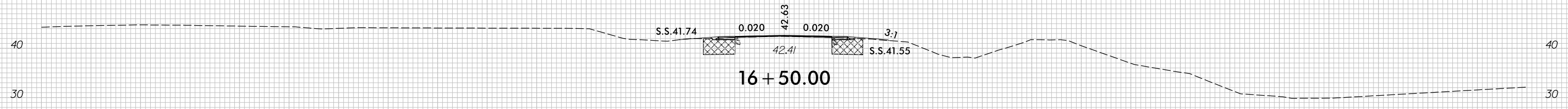

16 + 50.00

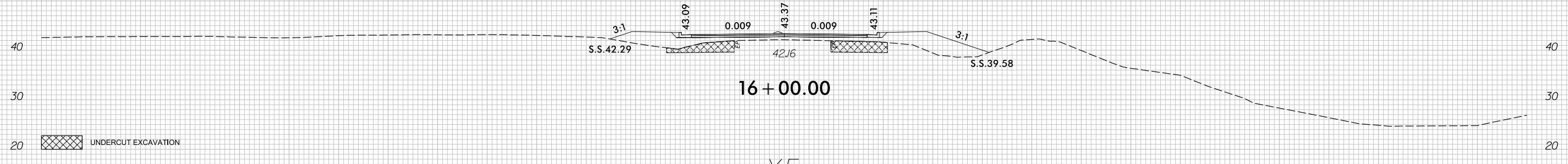

16 + 00.00

UNDERCUT EXCAVATION

-Y5-

150 140 130 120 110 100 90 80 70 60 50 40 30 20 10 0 10 20 30 40 50 60 70 80 90 100 110 120 130 140 150

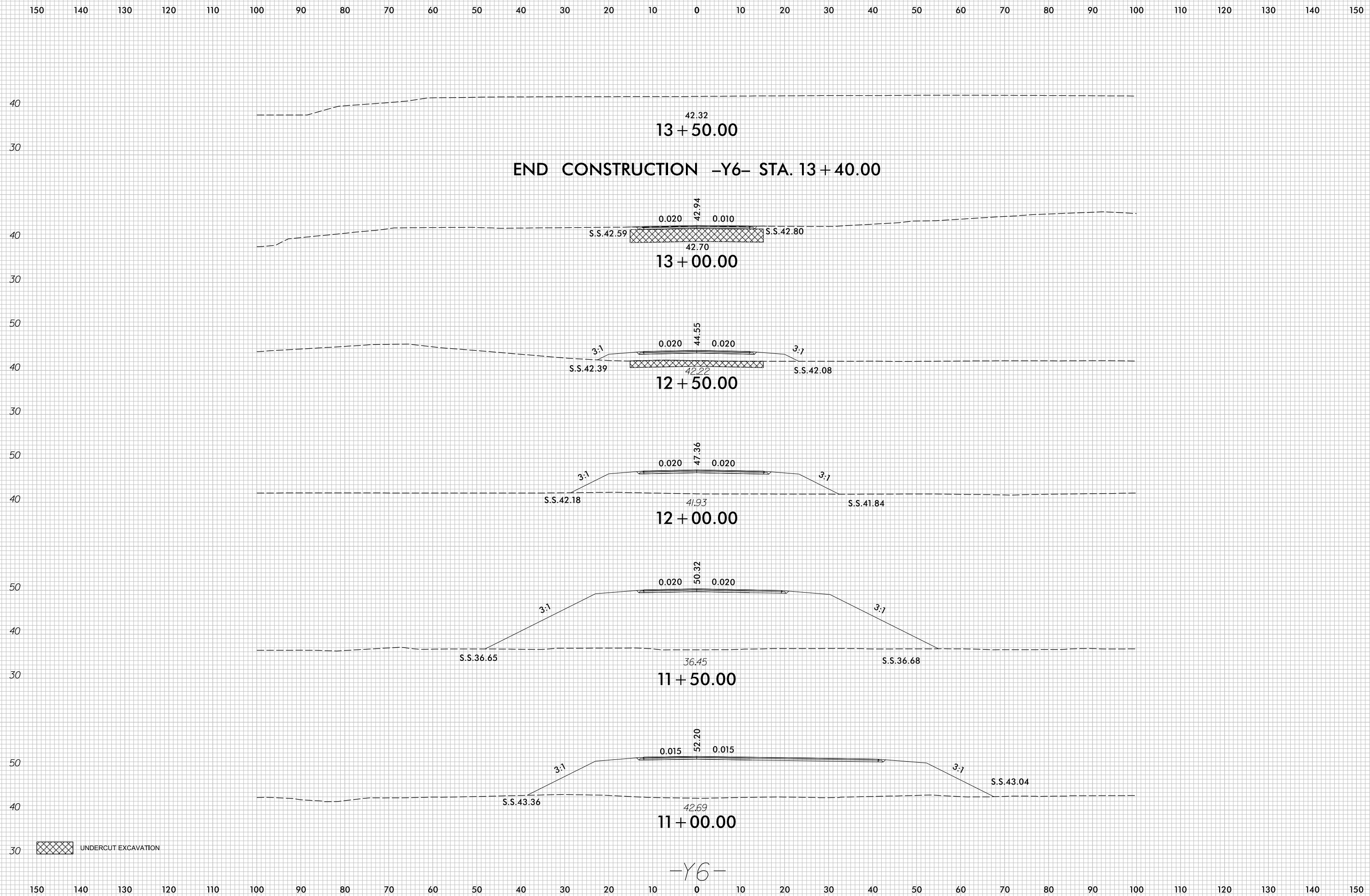

UNDERCUT EXCAVATION

-Y6-

8/23/99

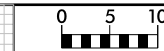

PROJ. REFERENCE NO.	SHEET NO.
U-4751	X-172

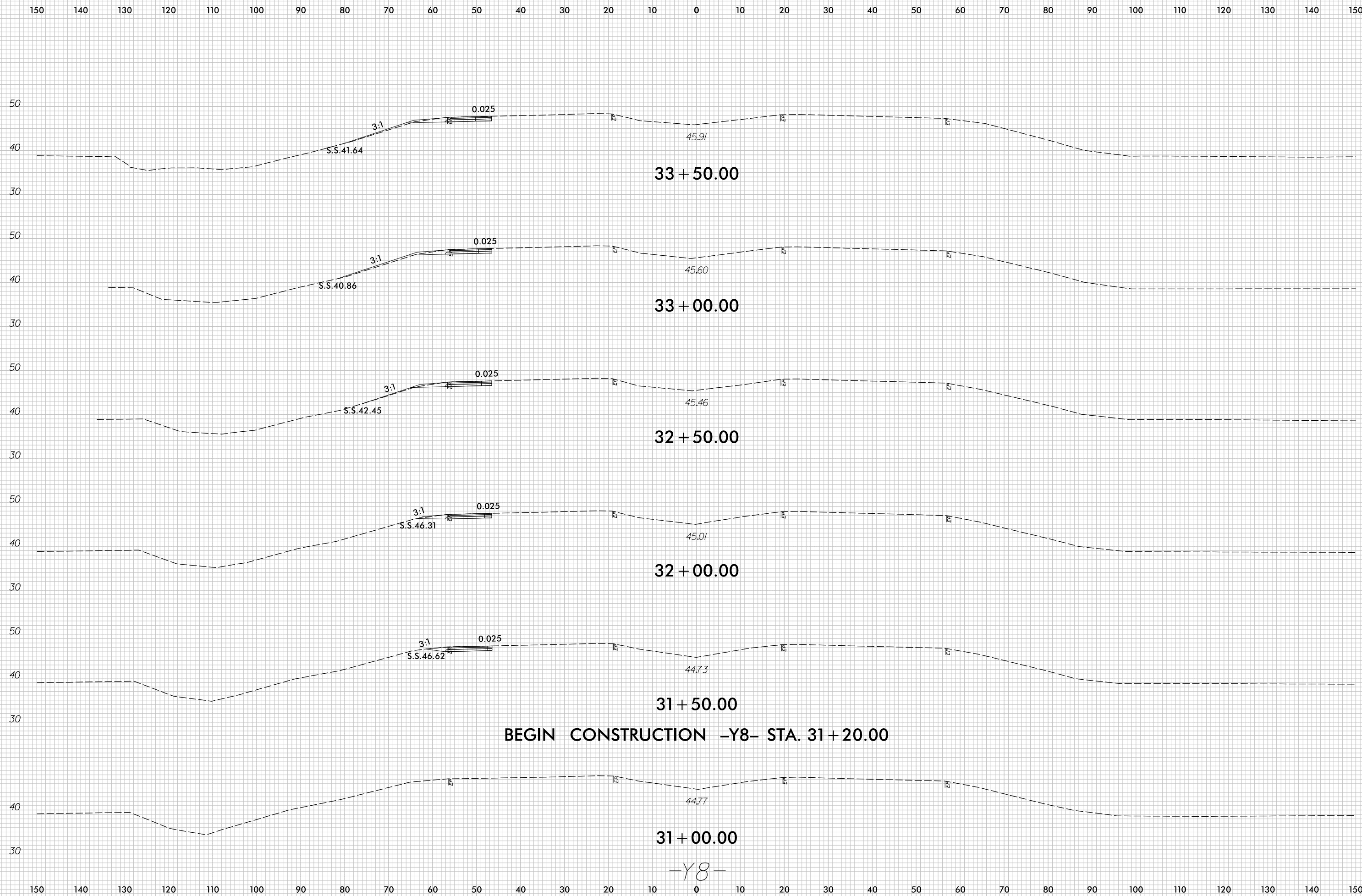

7/5/2017
r:\Roadway\XSC\U4751_Rdu_XPL_Y8.dgn
c:\proves

8/23/99

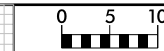

PROJ. REFERENCE NO.	SHEET NO.
U-4751	X-173

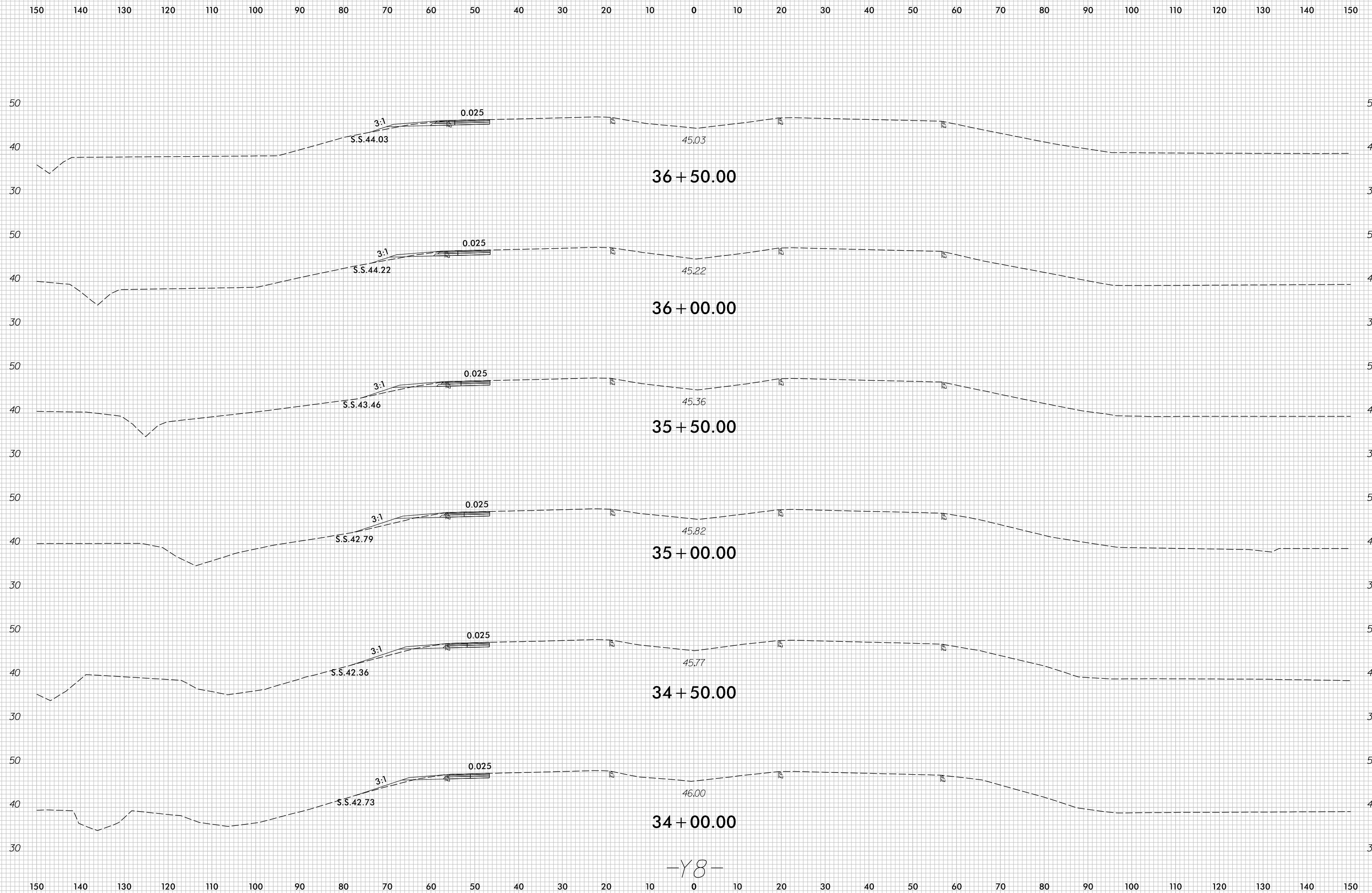

-Y8-

7/5/2017
r:\Roadway\XSC\U4751_Rdu_XPL_Y8.dgn
c:\proves

8/23/99

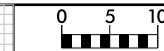

PROJ. REFERENCE NO.	SHEET NO.
U-4751	X-174

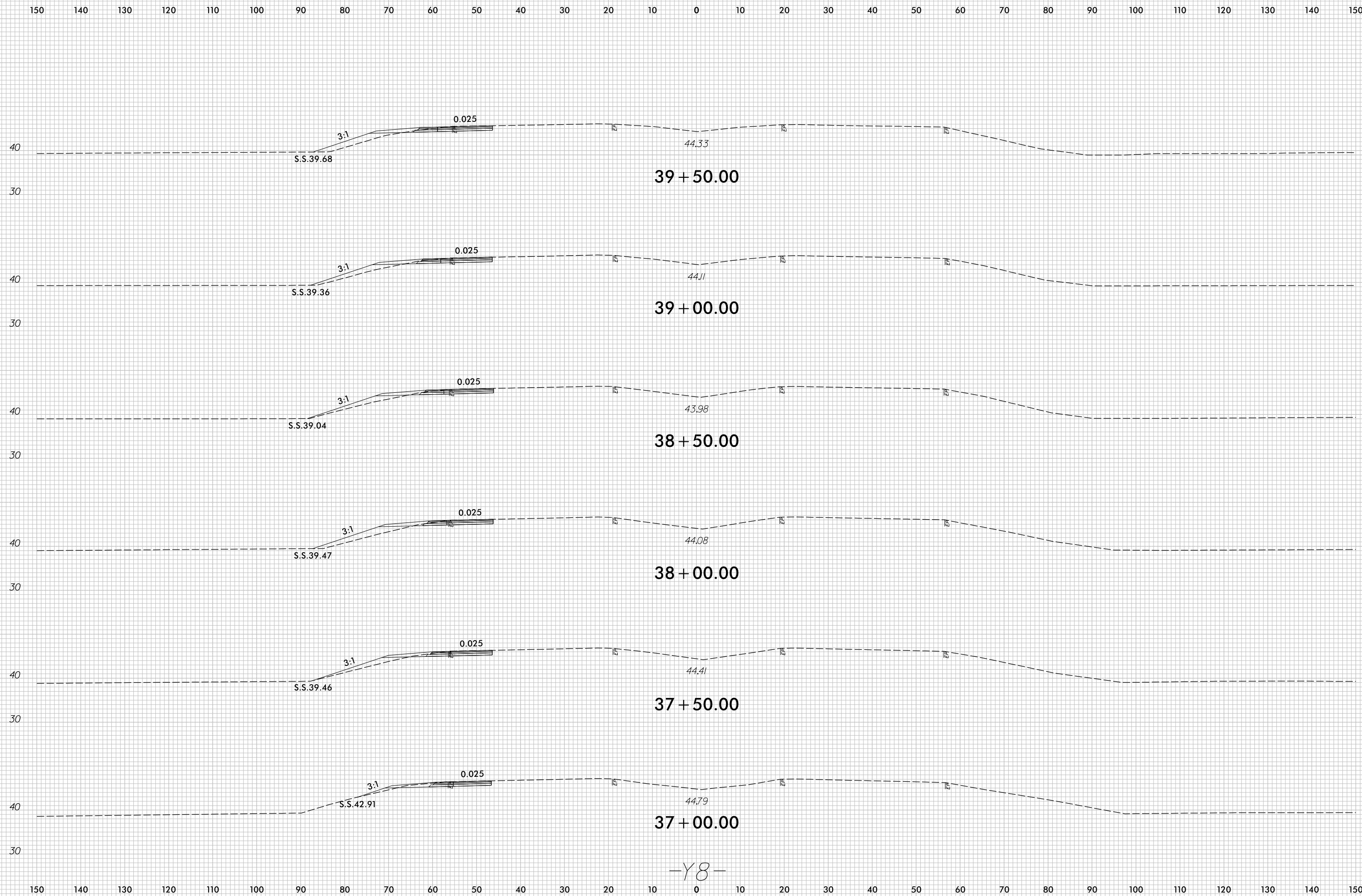

-Y8-

7/5/2017
r:\Roadway\XSC\U4751_Rdu_XPL_Y8.dgn
c:\proves

8/23/99

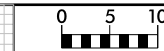

PROJ. REFERENCE NO.	SHEET NO.
U-4751	X-175

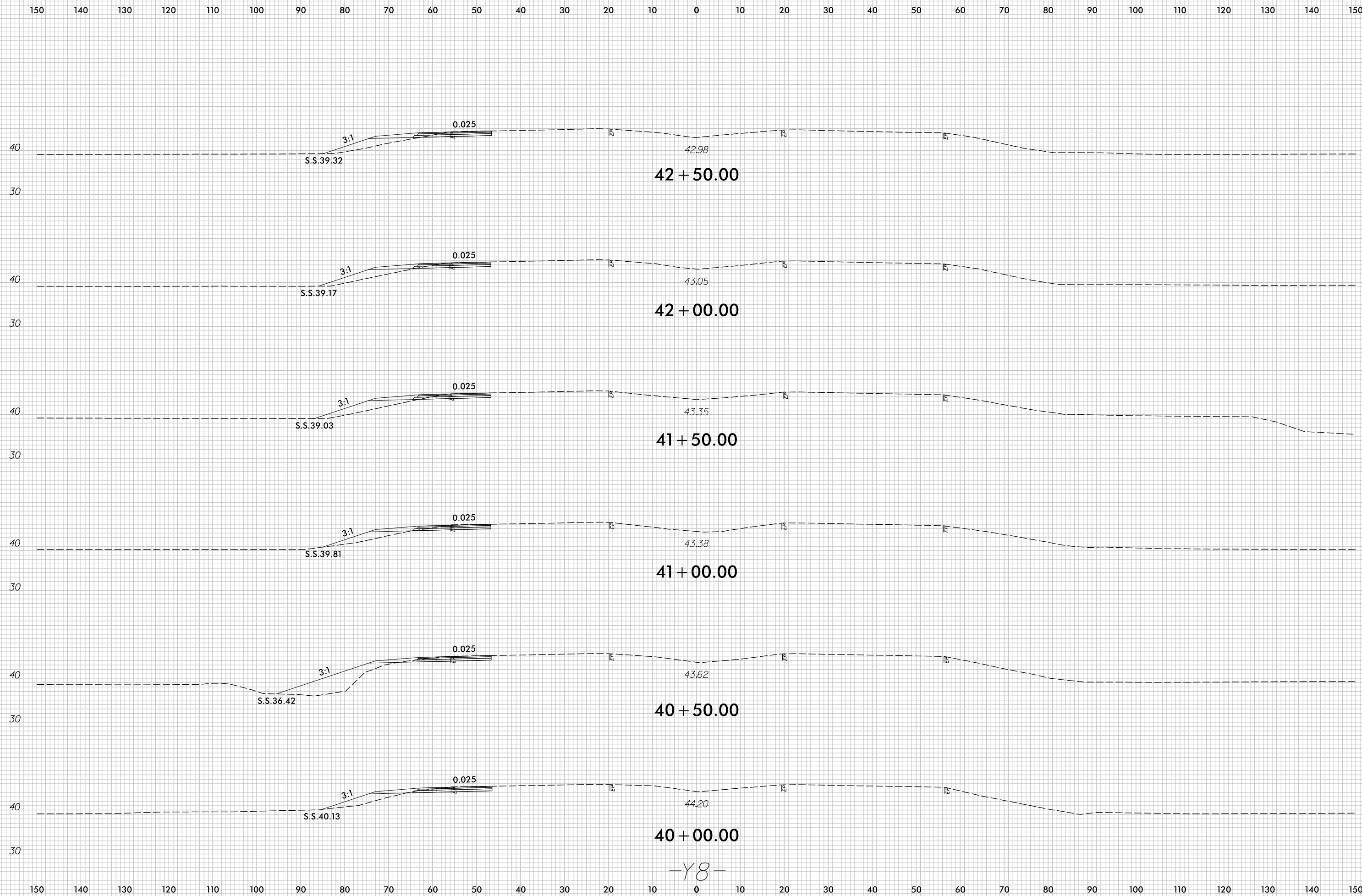

-Y8-

7/5/2017
r:\Roadway\XSC\U4751_Rdu_XPL_Y8.dgn
c:\proves

8/23/99

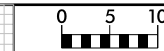

PROJ. REFERENCE NO.	SHEET NO.
U-4751	X-176

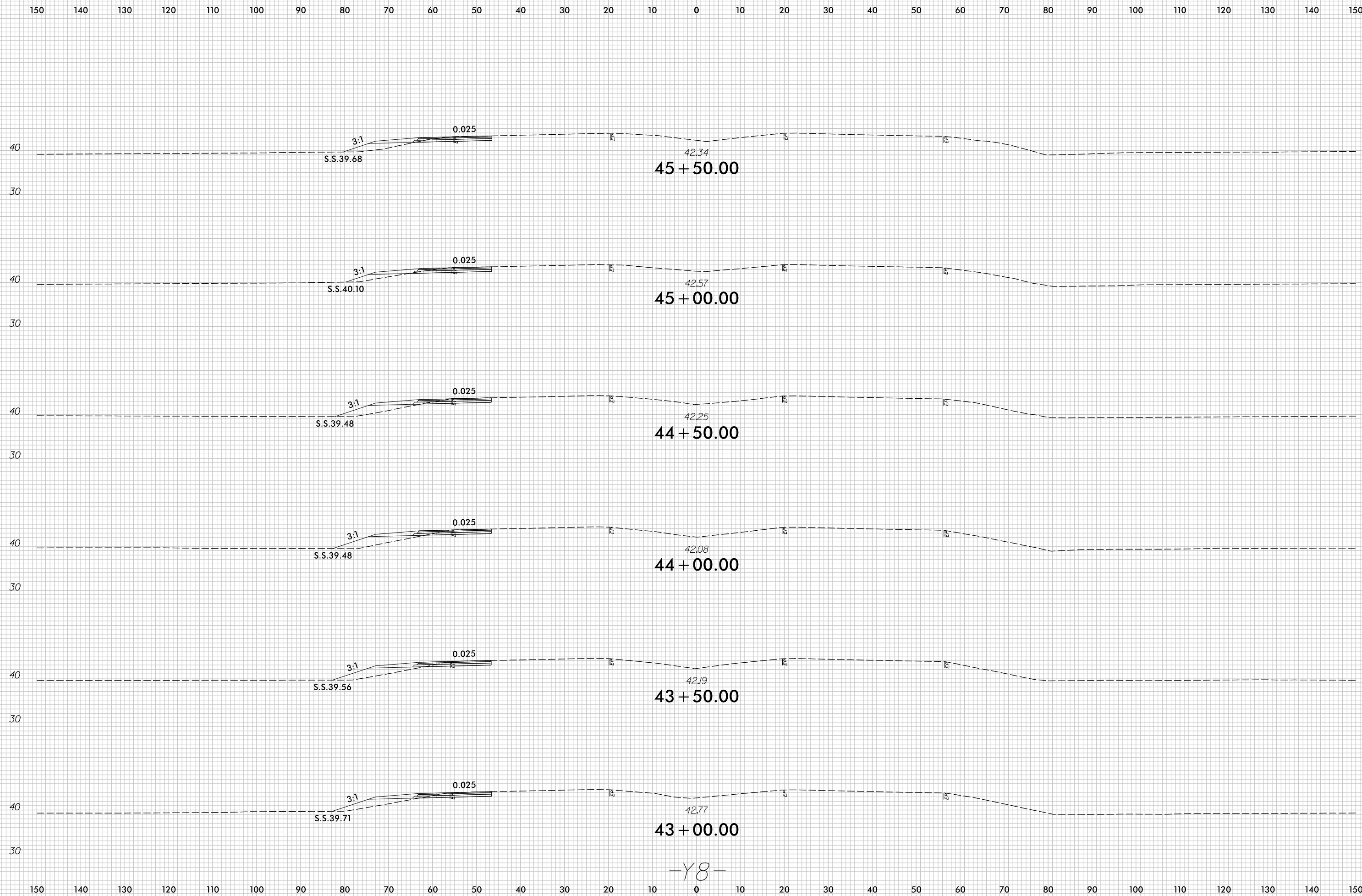

-Y8-

7/5/2017
r:\Roadway\XSC\U4751_Rdu_XPL_Y8.dgn
c:\proves

8/23/99

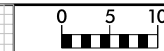

PROJ. REFERENCE NO.	SHEET NO.
U-4751	X-177

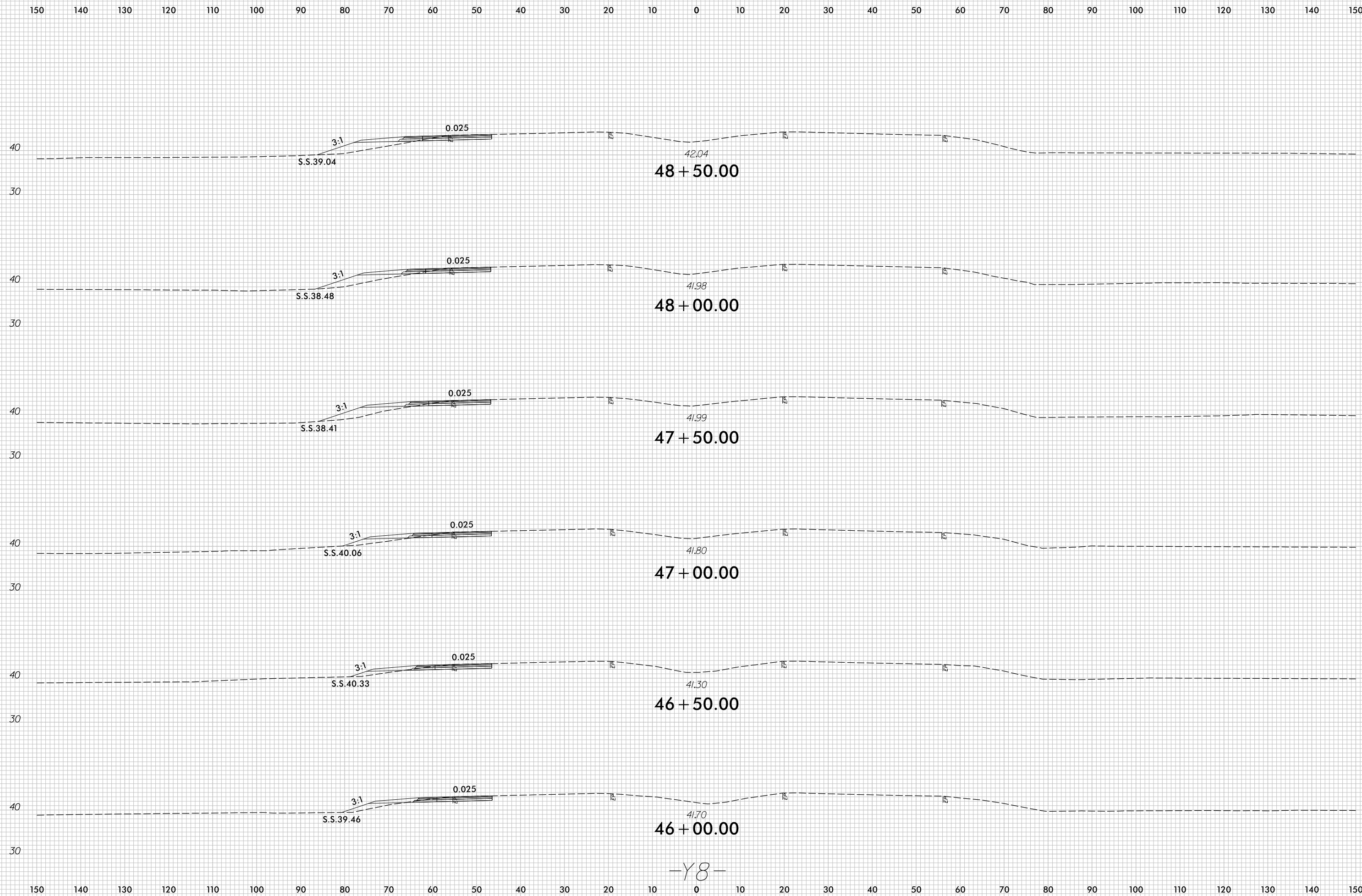

7/5/2017
r:\Roadway\XSC\U4751_Rdu_XPL_Y8.dgn
c:\proves

-Y8-

8/23/99

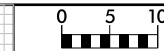

PROJ. REFERENCE NO.	SHEET NO.
U-4751	X-178

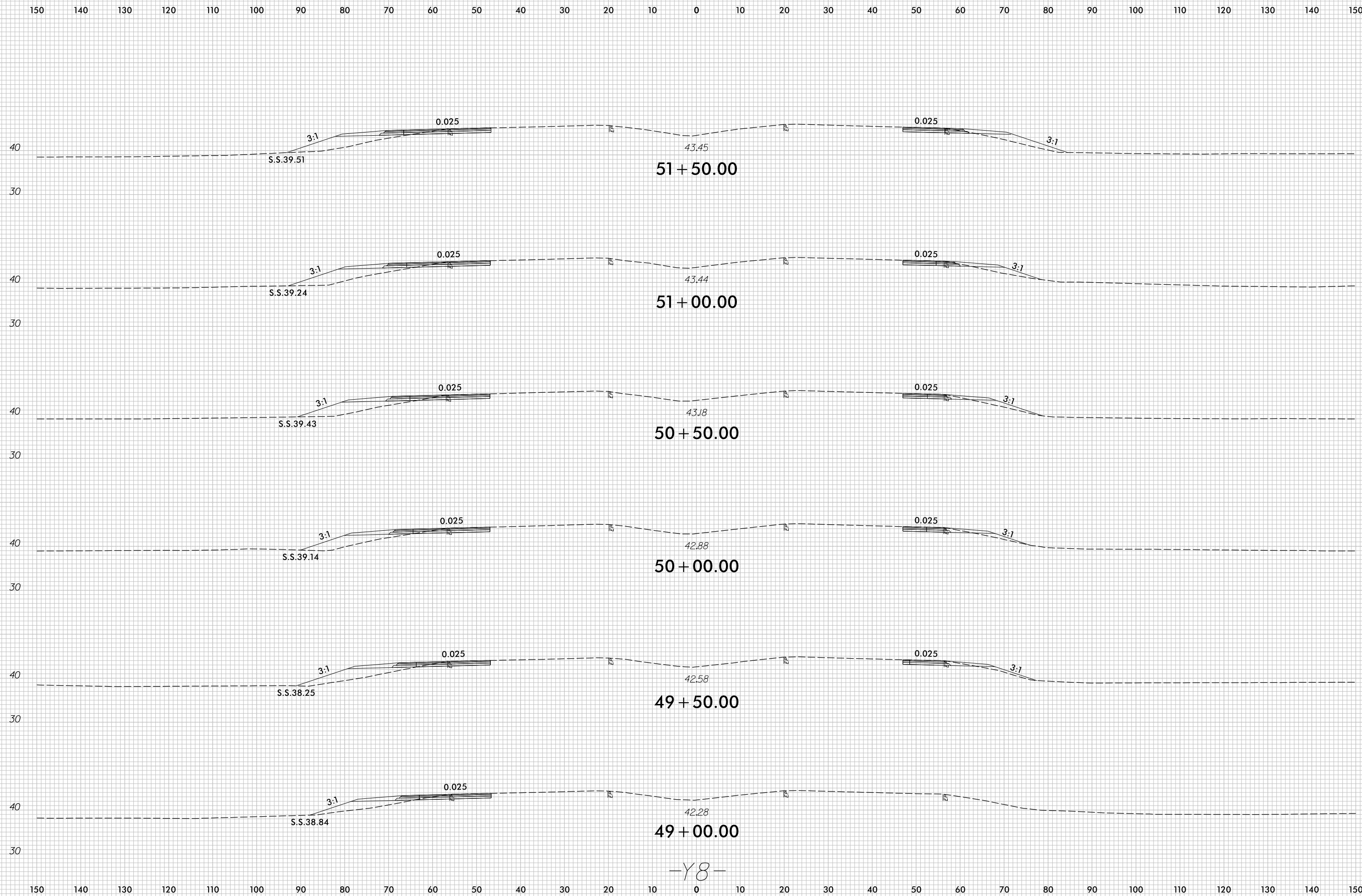

-Y8-

7/5/2017
r:\Roadway\XSC\U4751_Rdu_XPL_Y8.dgn
c:\proves

8/23/99

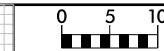

PROJ. REFERENCE NO. U-4751	SHEET NO. X-179
-------------------------------	--------------------

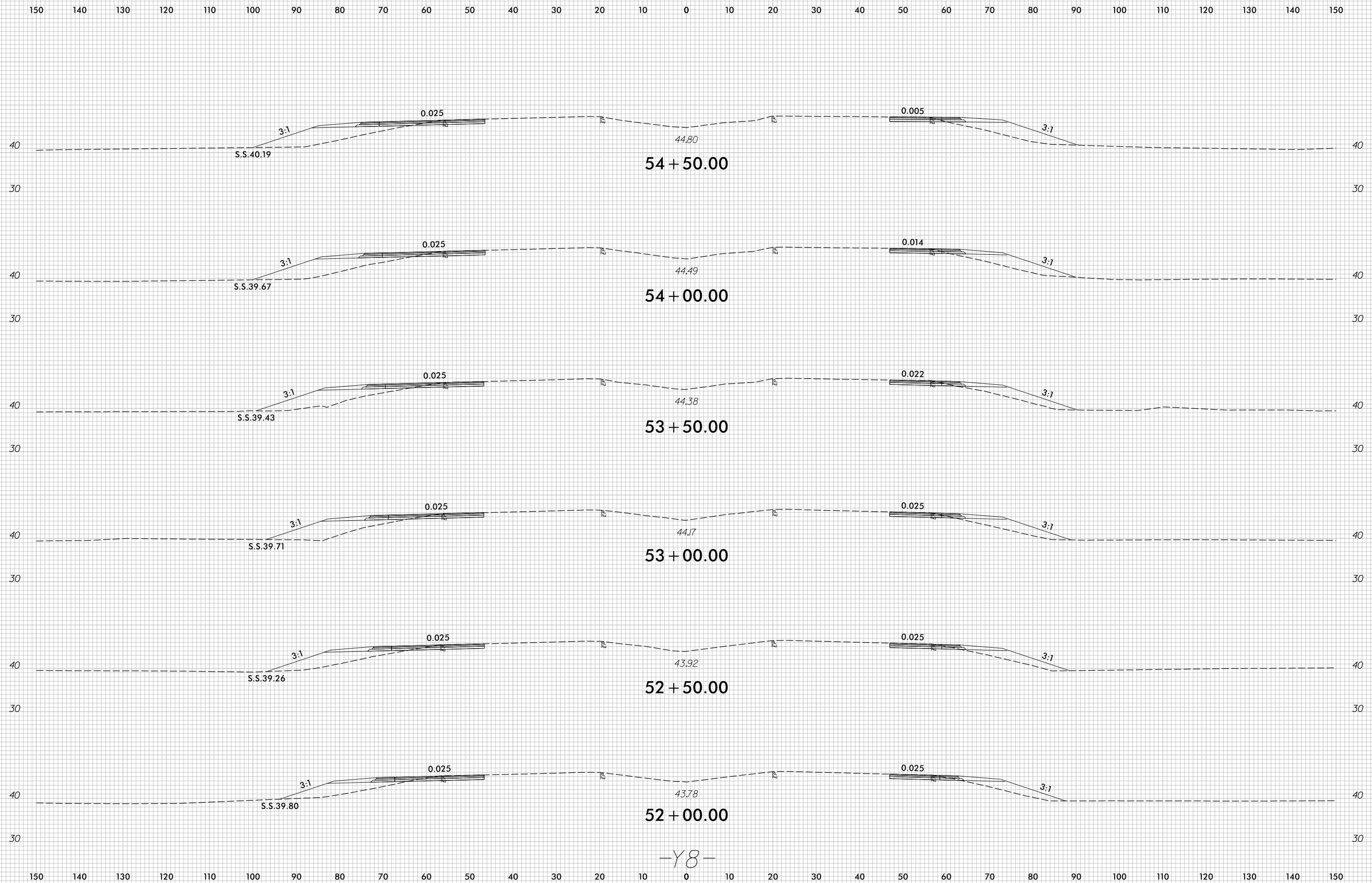

-Y8-

7/5/2017
r:\Roadway\XSC\U4751_Rdway\PL_Y8.dgn
c:\proves

8/23/99

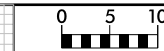

PROJ. REFERENCE NO.	SHEET NO.
U-4751	X-180

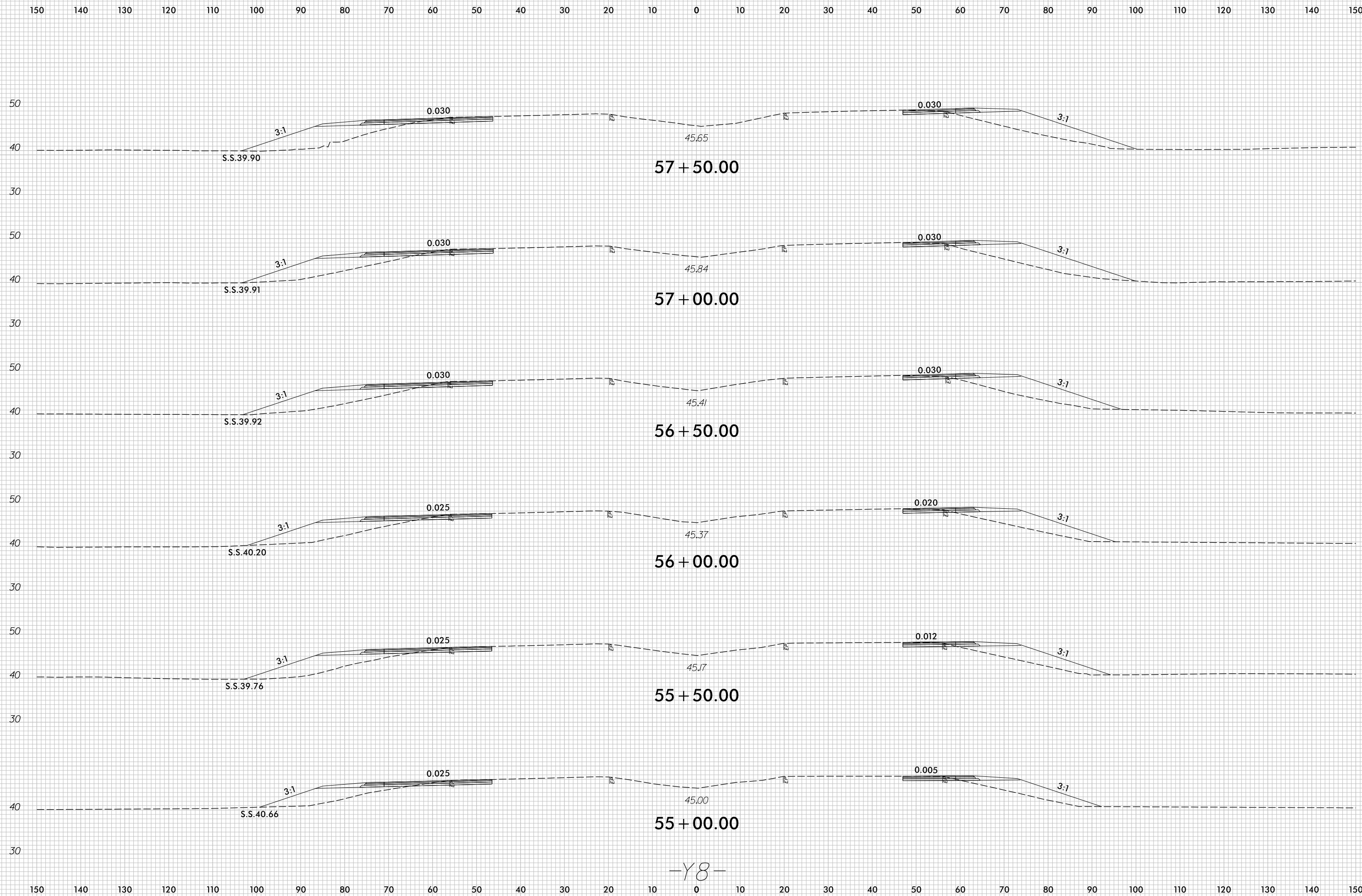

-Y8-

7/5/2017
r:\Roadway\XSC\U4751_Rdu_xPL_Y8.dgn
c:\proves

8/23/99

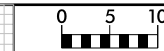

PROJ. REFERENCE NO.	SHEET NO.
U-4751	X-181

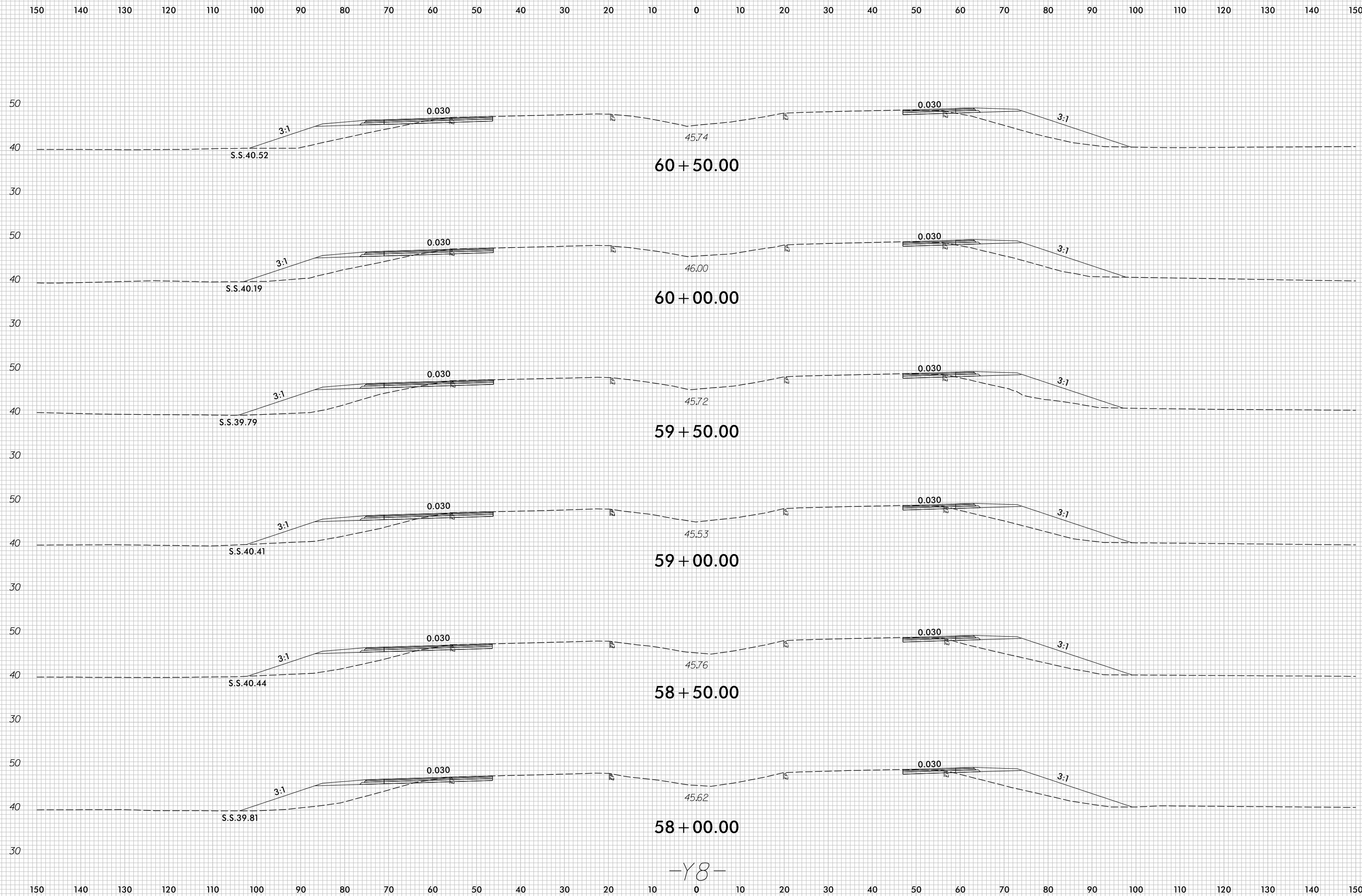

-Y8-

7/5/2017
r:\Roadway\XSC\U4751_Rdu_XPL_Y8.dgn
cproves

8/23/99

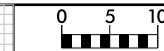

PROJ. REFERENCE NO.	SHEET NO.
U-4751	X-182

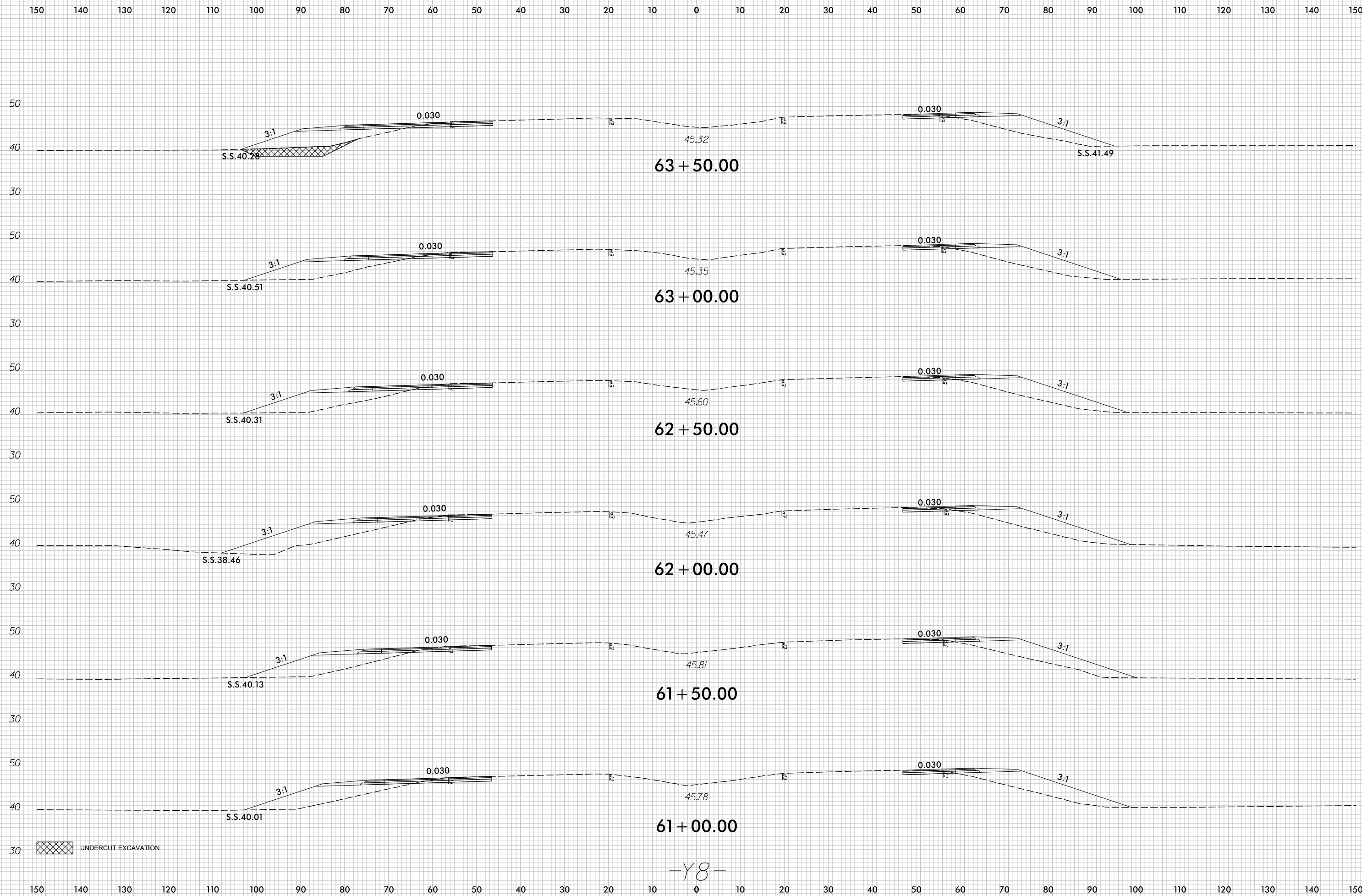

UNDERCUT EXCAVATION

-Y8-

7/5/2017
 r:\Roadway\XSC\U4751_Rdu_XPL_Y8.dgn
 c:\proves

8/23/99

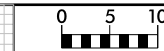

PROJ. REFERENCE NO.	SHEET NO.
U-4751	X-183

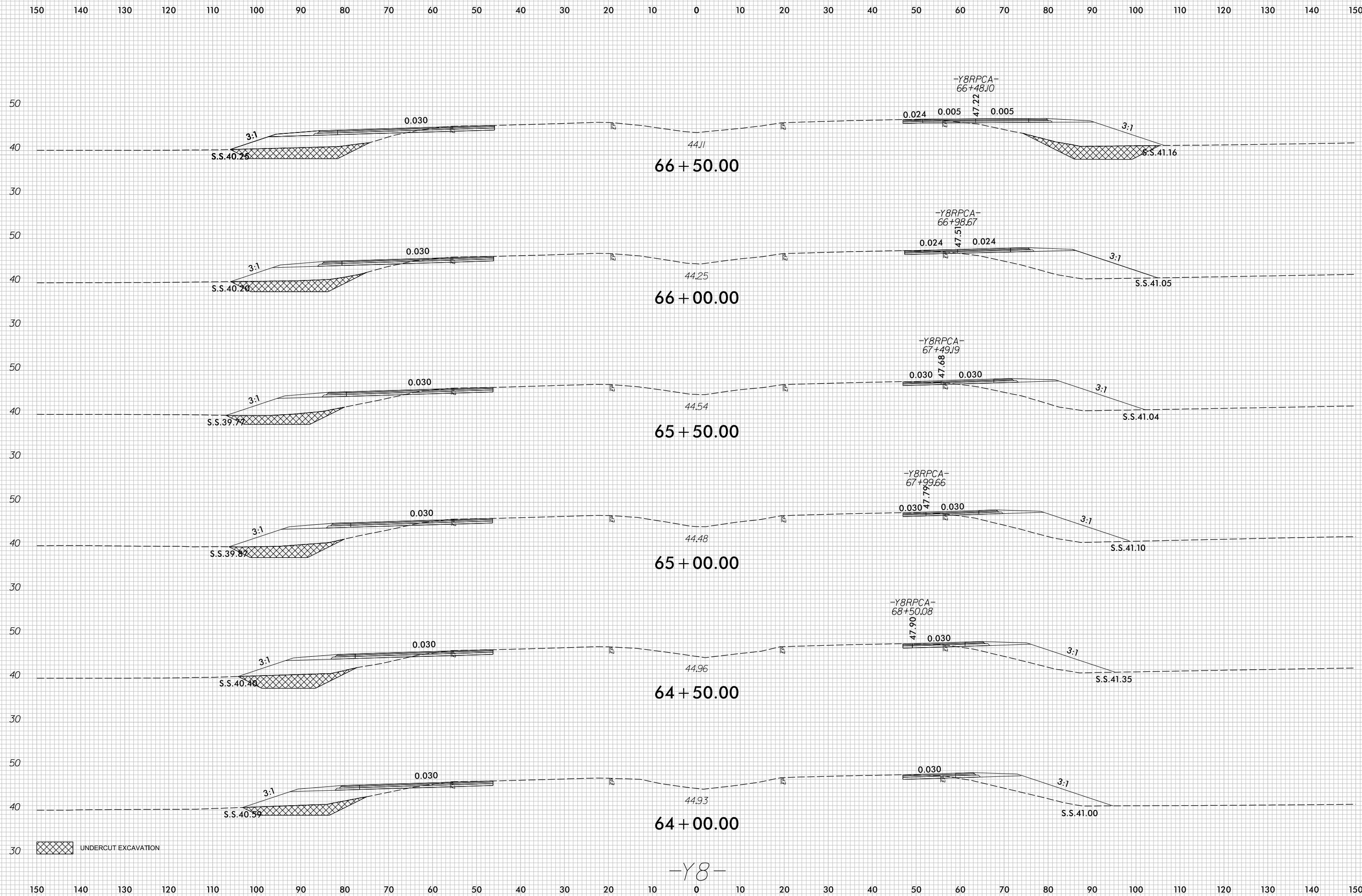

UNDERCUT EXCAVATION

7/5/2017
r:\Roadway\XSC\U4751_Rdu_XPL_Y8.dgn
cproves

8/23/99

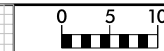

PROJ. REFERENCE NO.	SHEET NO.
U-4751	X-185

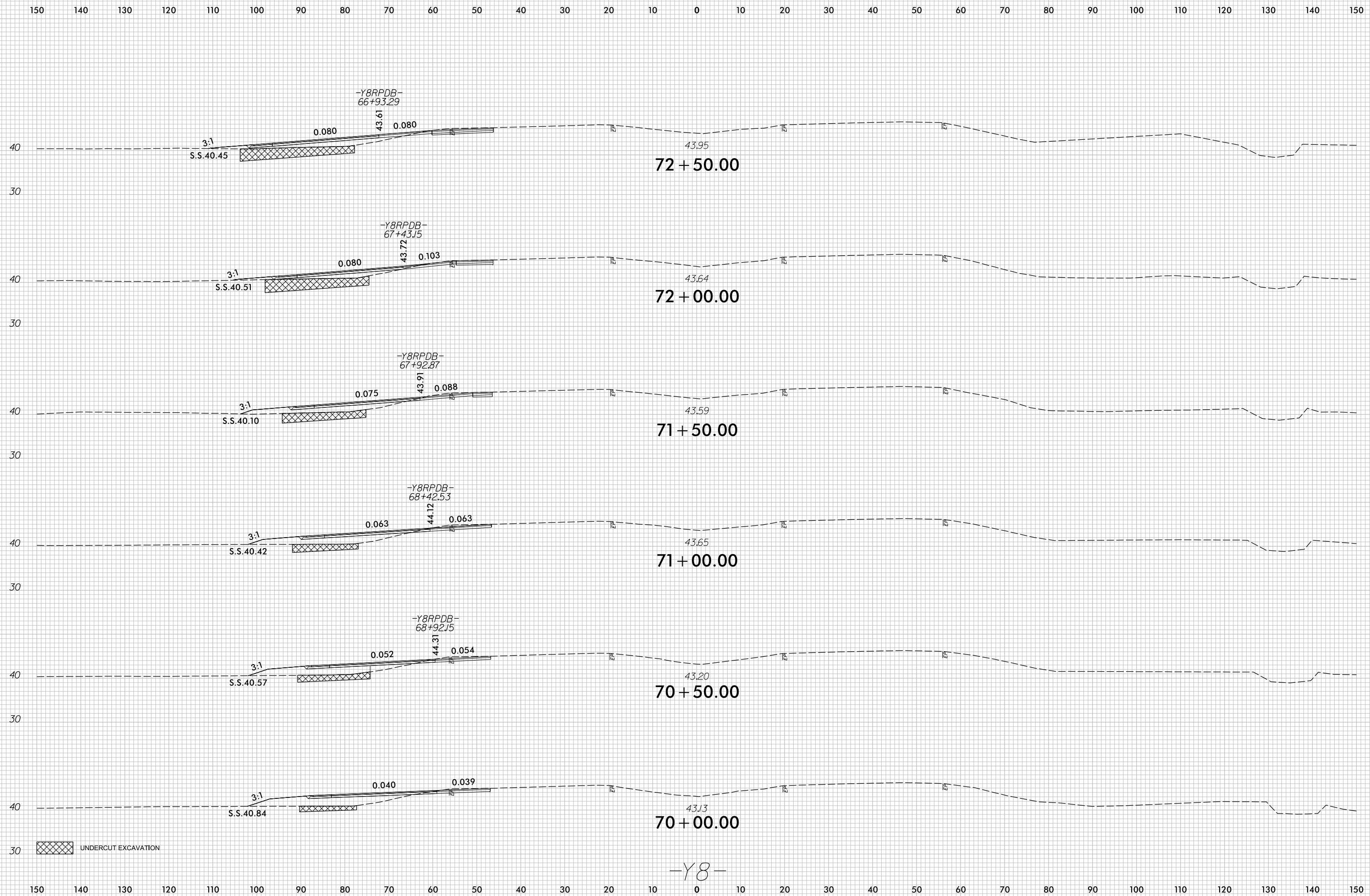

7/5/2017
r:\Roadway\XSC\U4751_Rdu_xPL_Y8.dgn
c:\proves

-Y8-

8/23/99

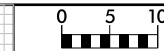

PROJ. REFERENCE NO.	SHEET NO.
U-4751	X-186

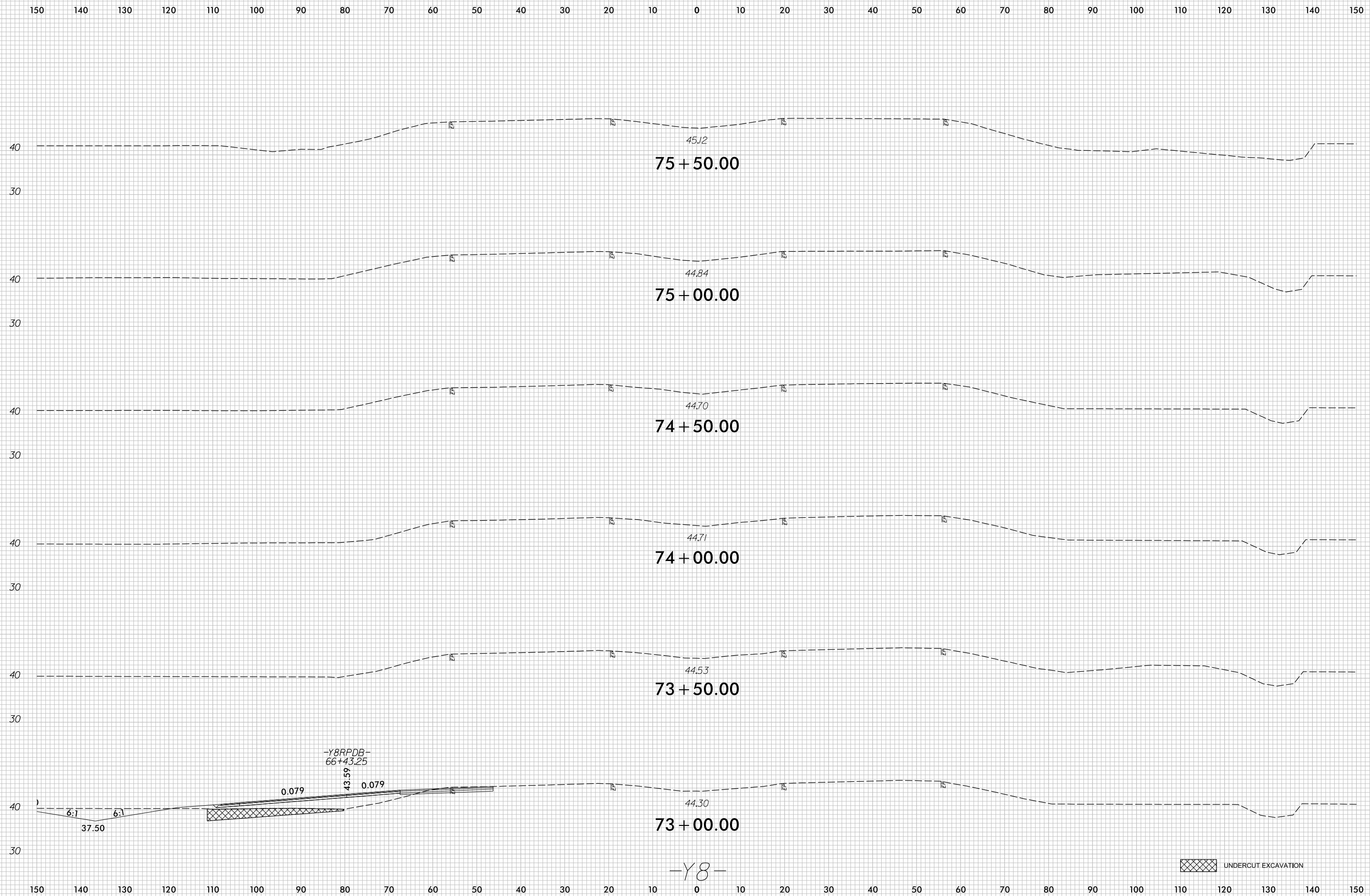

r:\Roadway\XSC\U4751_Rdu_XPL_Y8.dgn

UNDERCUT EXCAVATION

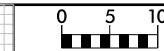

150 140 130 120 110 100 90 80 70 60 50 40 30 20 10 0 10 20 30 40 50 60 70 80 90 100 110 120 130 140 150

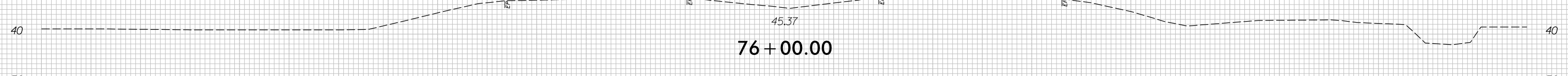
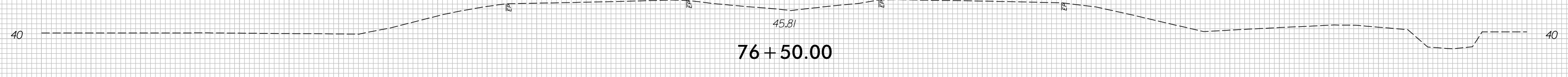
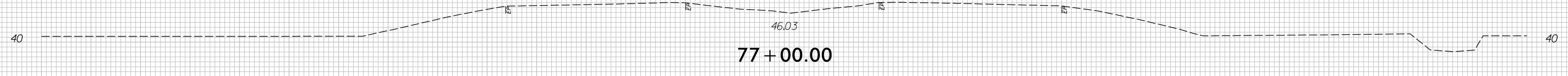
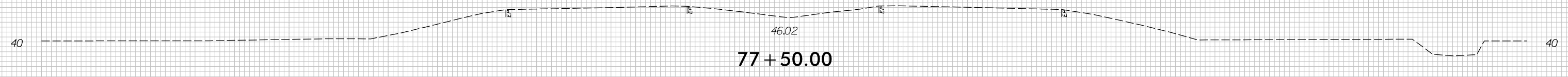
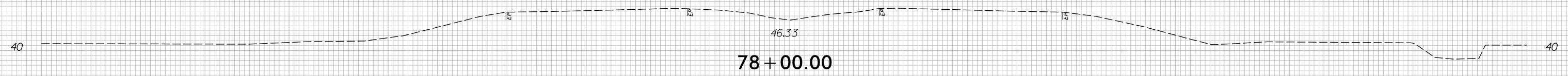
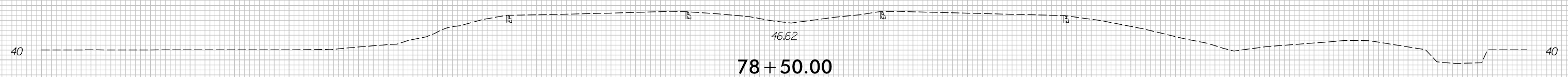

-Y8-

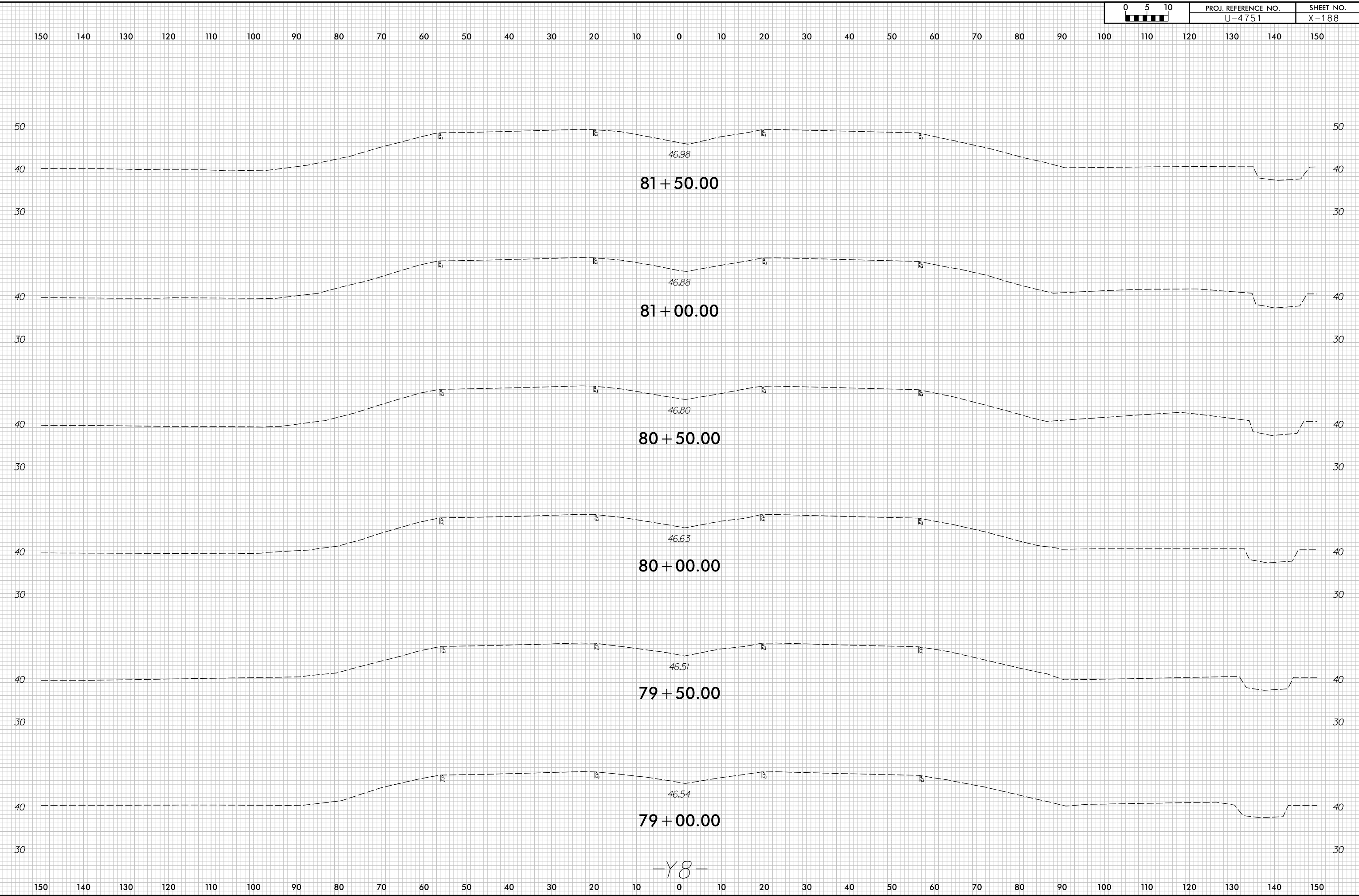

-Y8-

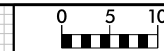

150 140 130 120 110 100 90 80 70 60 50 40 30 20 10 0 10 20 30 40 50 60 70 80 90 100 110 120 130 140 150

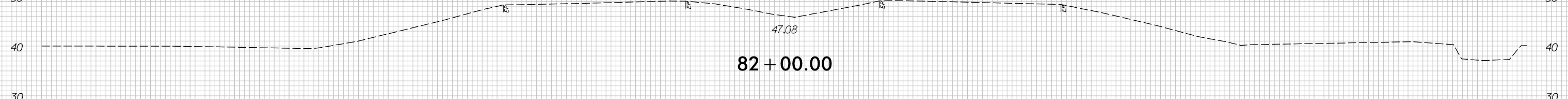
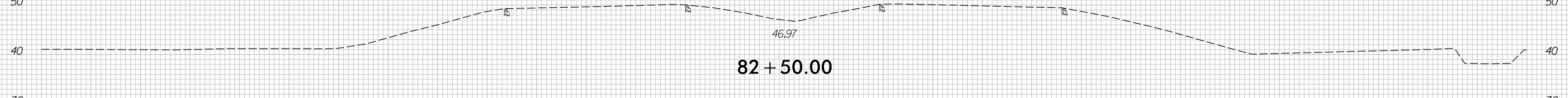
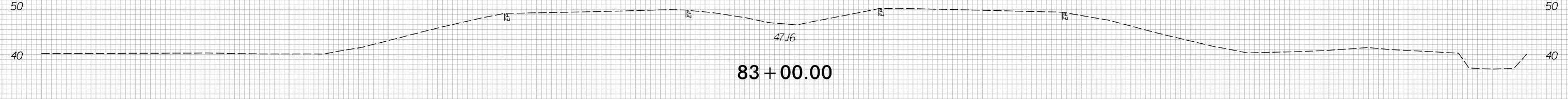
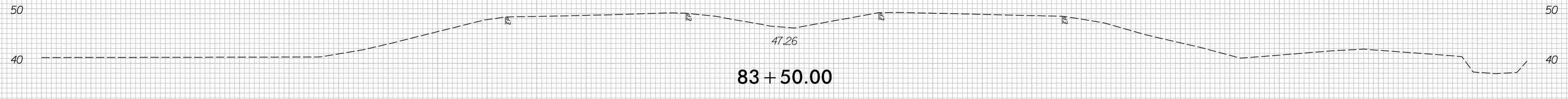
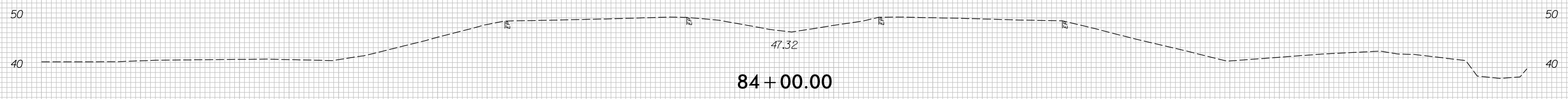

-Y8-

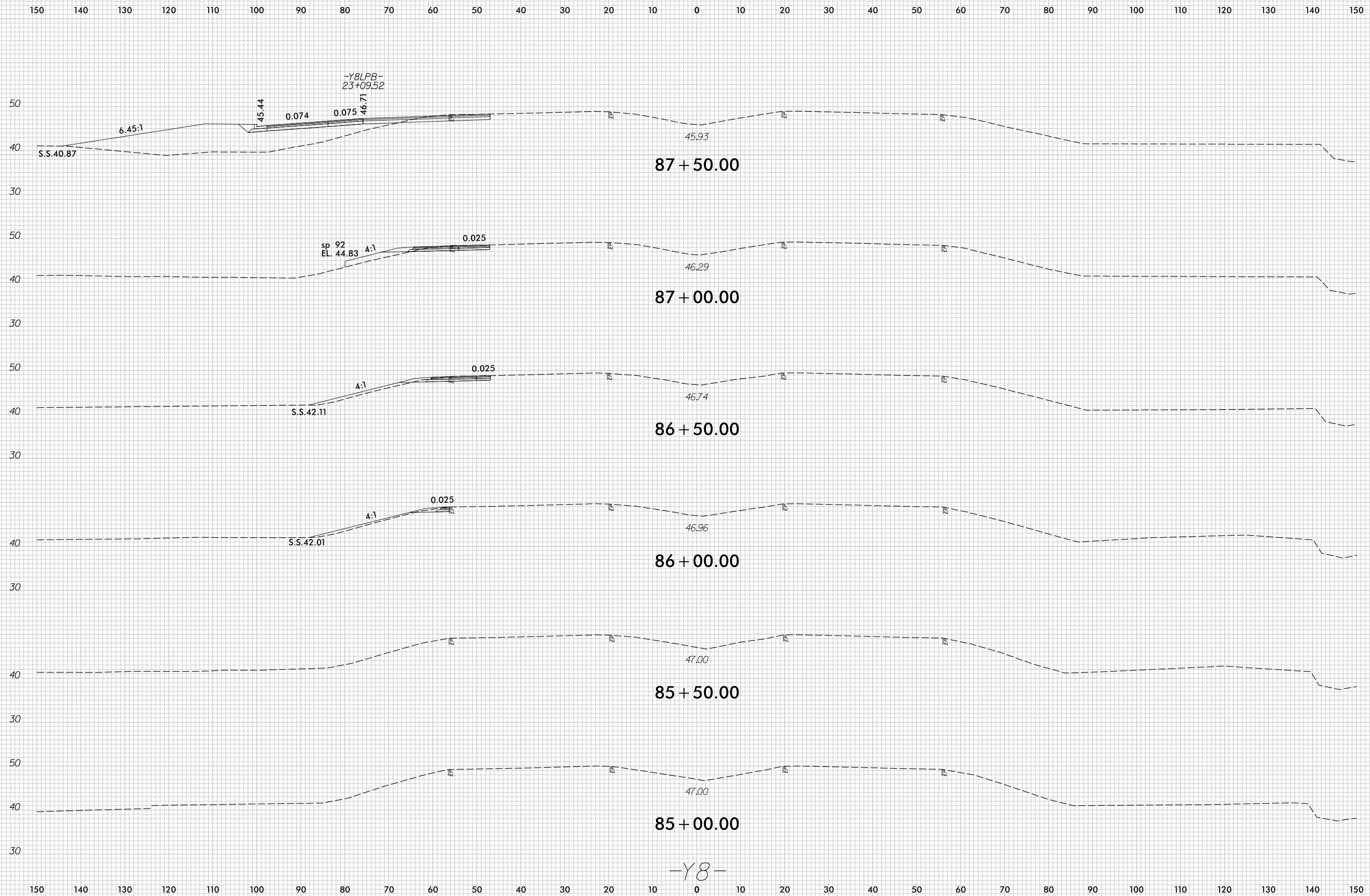

8/23/99

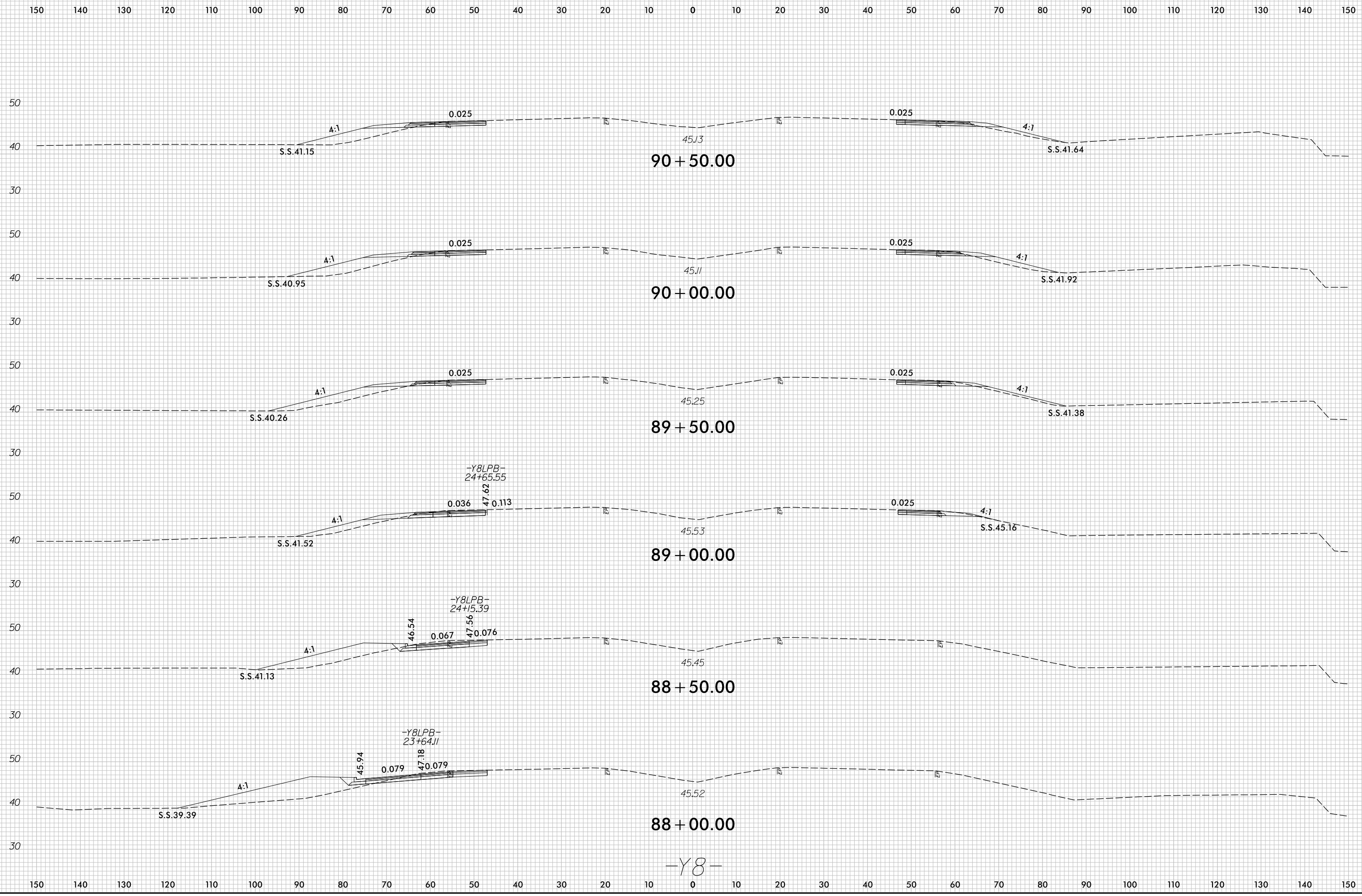

7/5/2017
r:\Roadway\XSC\U4751_Rdu_XPL_Y8.dgn
c:\proves

8/23/99

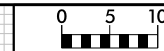

PROJ. REFERENCE NO.	SHEET NO.
U-4751	X-192

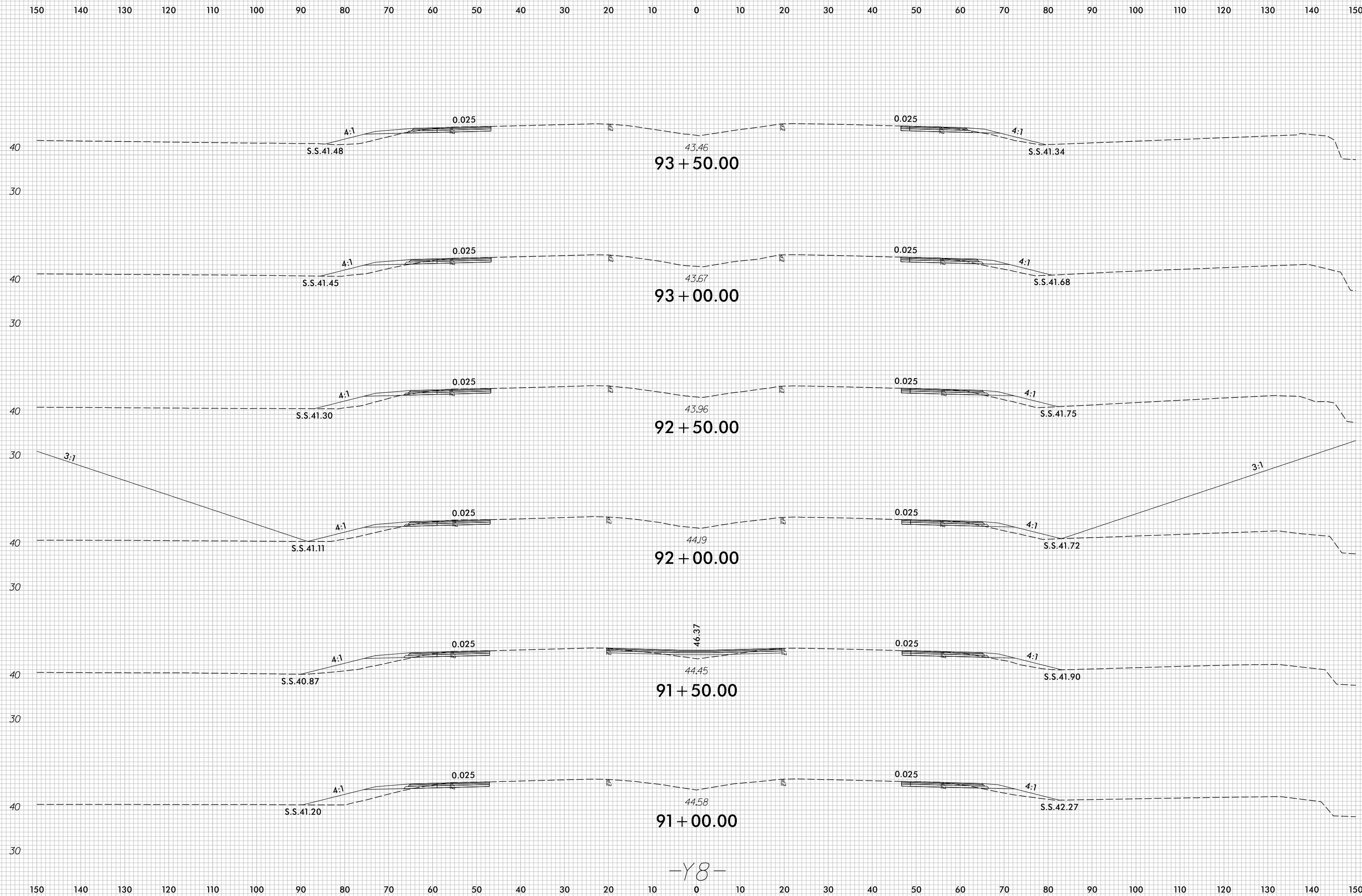

-Y8-

7/5/2017
r:\Roadway\XSC\U4751_Rdu_xPL_Y8.dgn
c:\proves

8/23/99

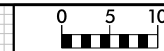

PROJ. REFERENCE NO.
U-4751

SHEET NO.
X-193

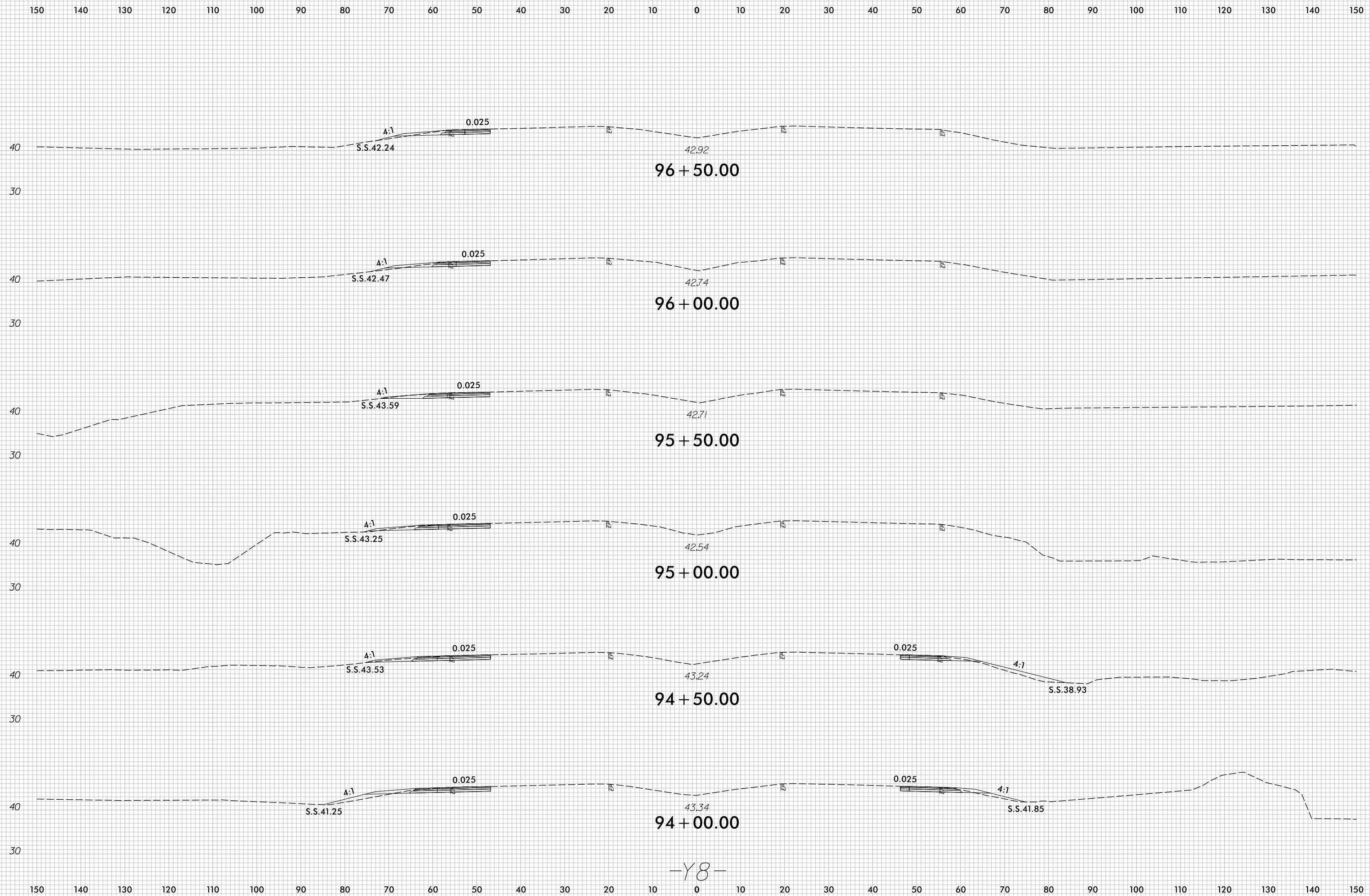

-Y8-

7/5/2017
r:\Roadway\XSC\U4751_Rdu_xPL_Y8.dgn
c:\proves

8/23/99

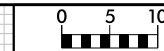

PROJ. REFERENCE NO.	SHEET NO.
U-4751	X-194

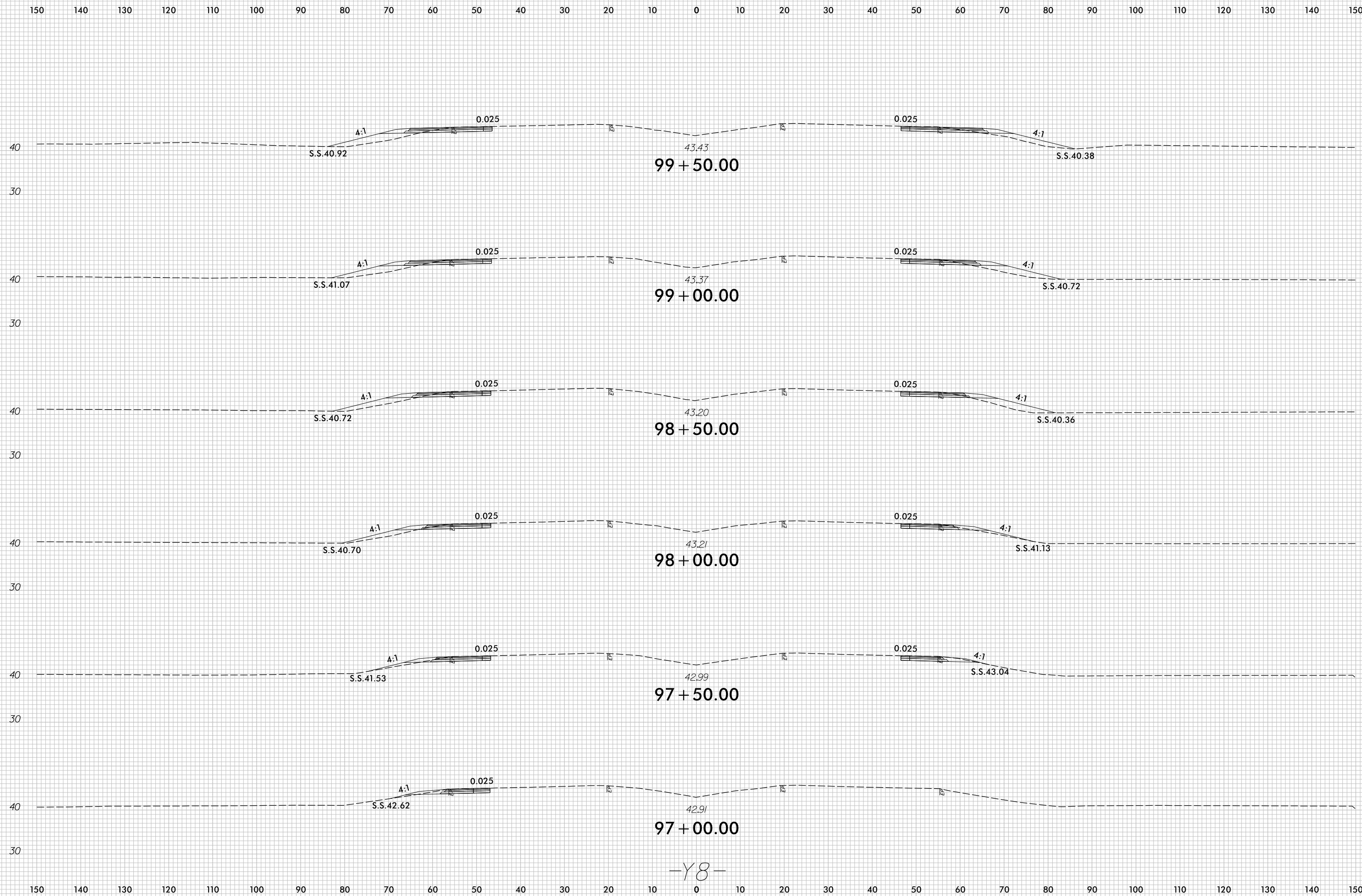

-Y8-

7/5/2017
r:\Roadway\XSC\U4751_Rdu_XPL_Y8.dgn
c:\proves

8/23/99

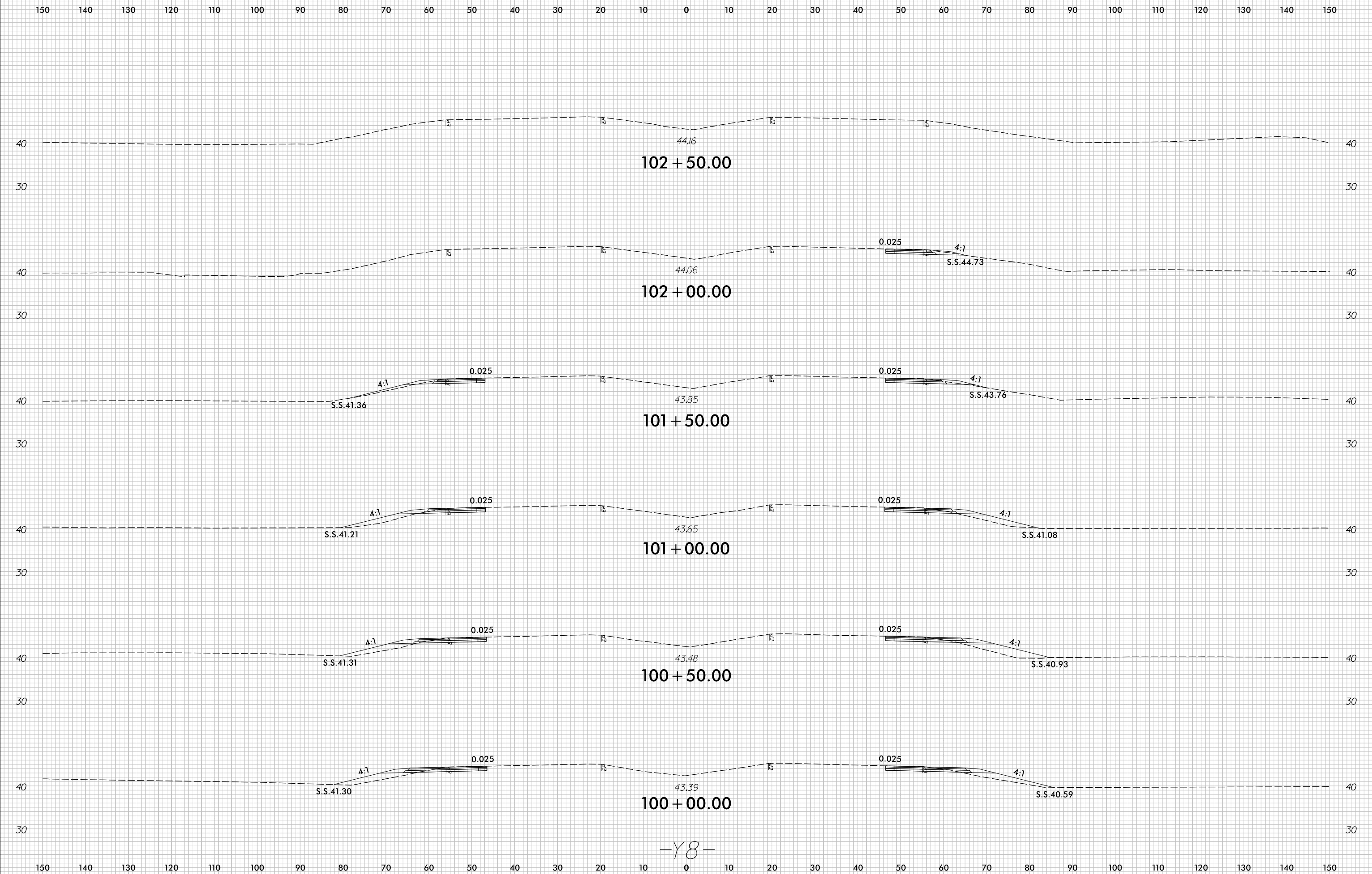

-Y8-

7/5/2017
r:\Roadway\XSC\U4751_Rdu_xPL_Y8.dgn
c:\proves

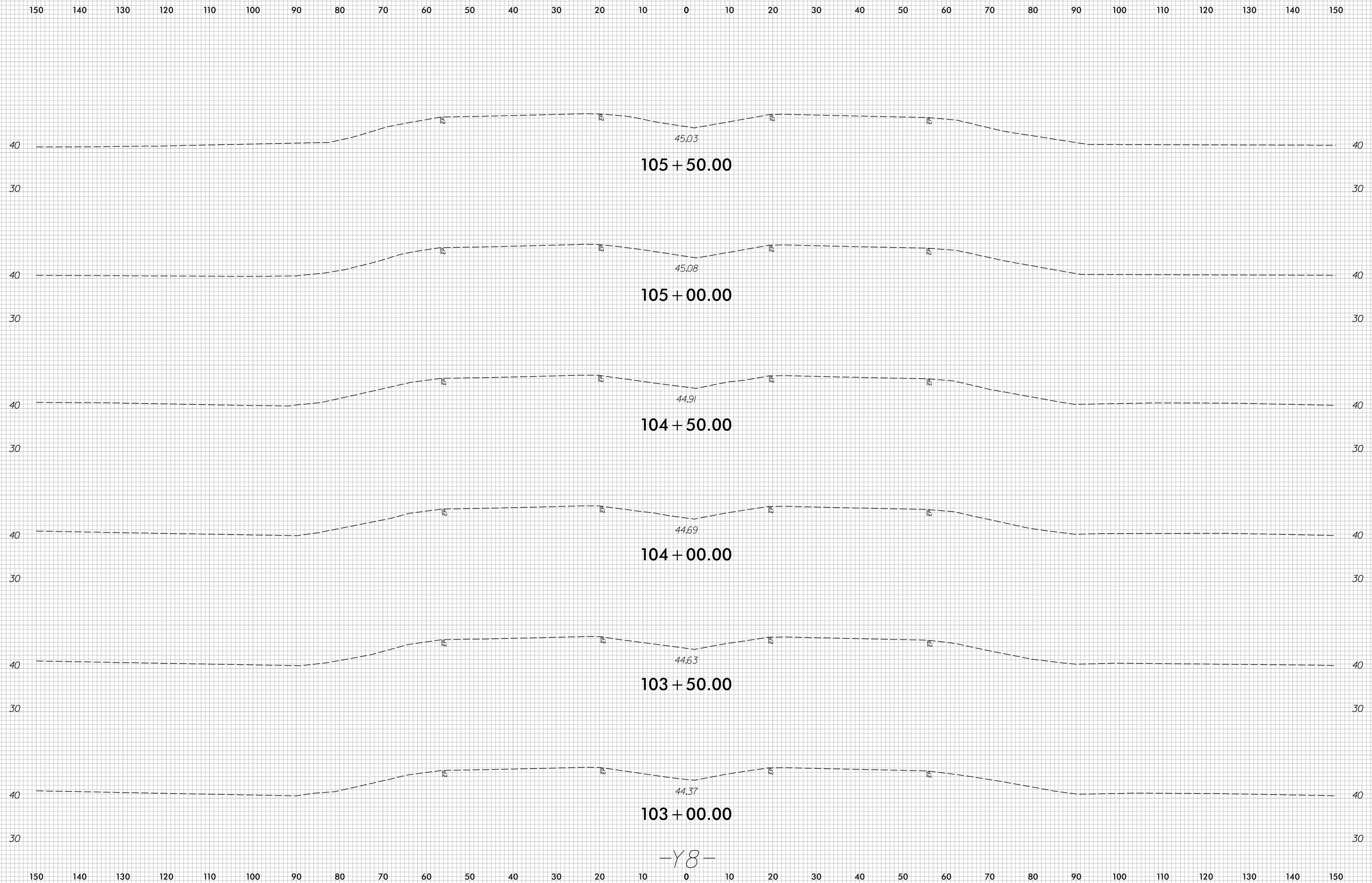

-Y8-

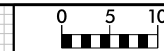

150 140 130 120 110 100 90 80 70 60 50 40 30 20 10 0 10 20 30 40 50 60 70 80 90 100 110 120 130 140 150

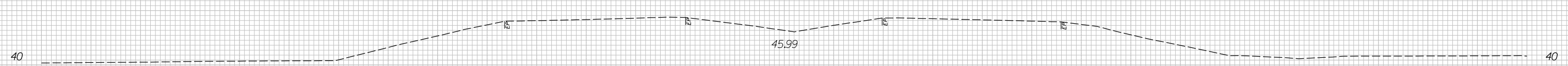

108 + 50.00

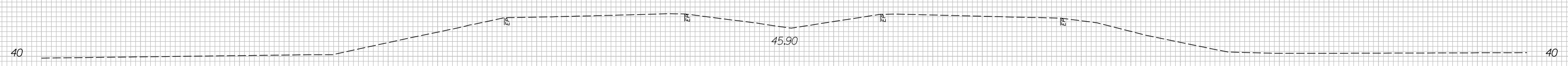

108 + 00.00

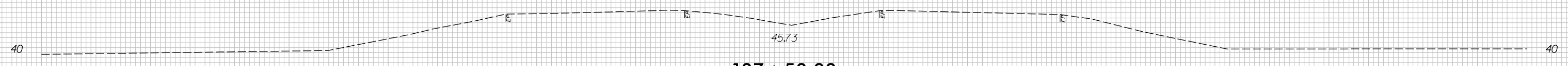

107 + 50.00

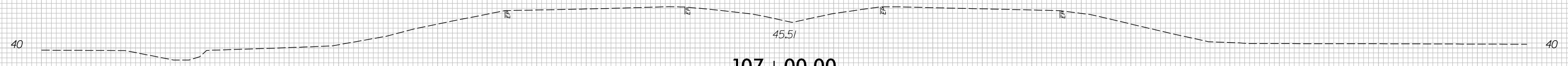

107 + 00.00

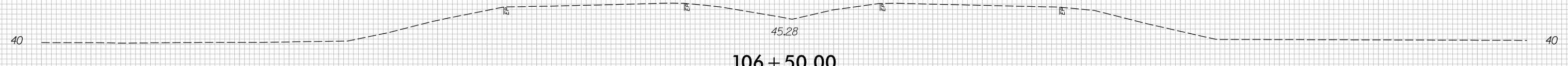

106 + 50.00

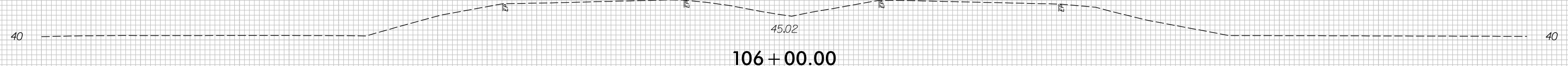

106 + 00.00

-Y8-

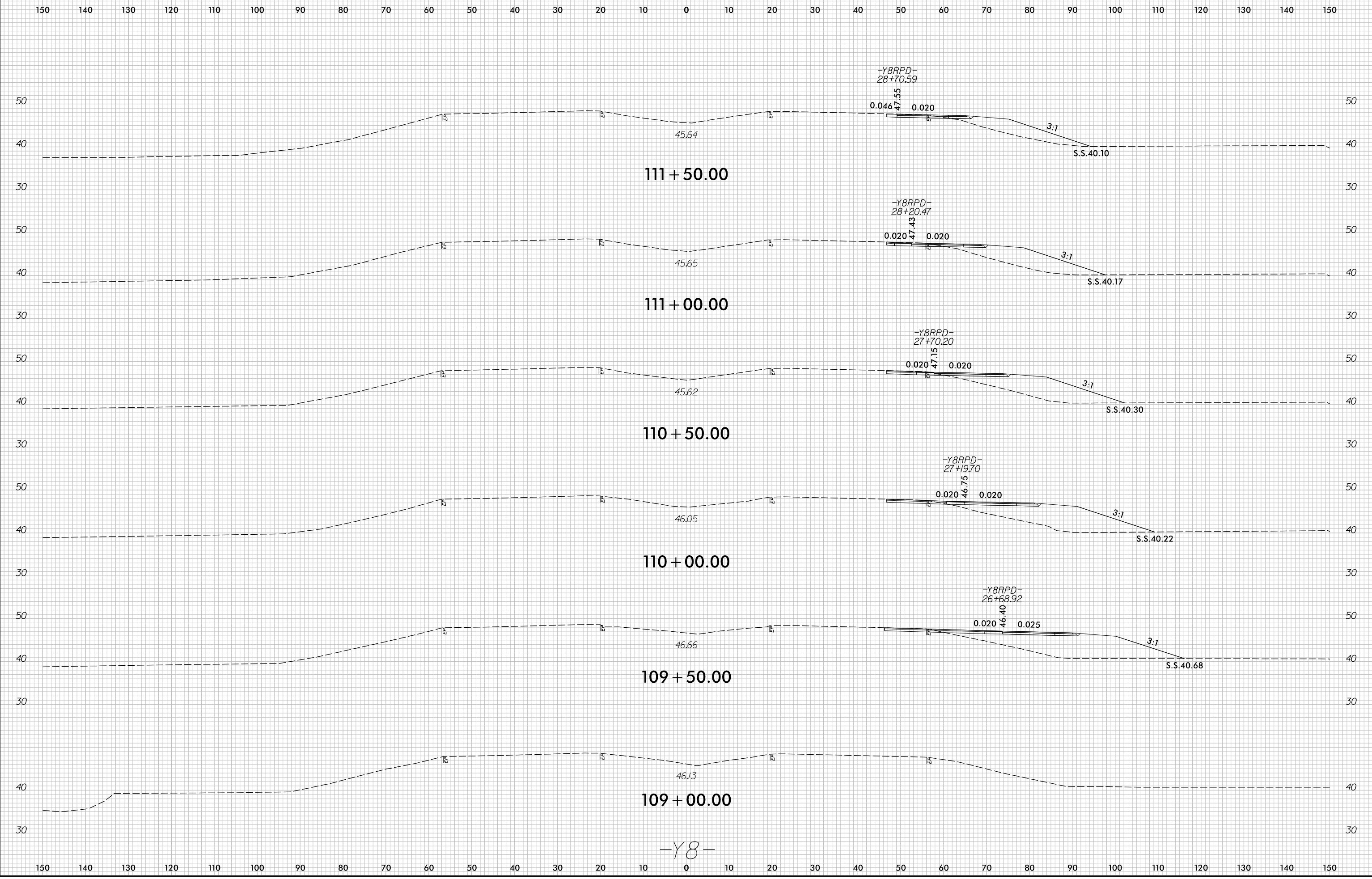

-Y8-

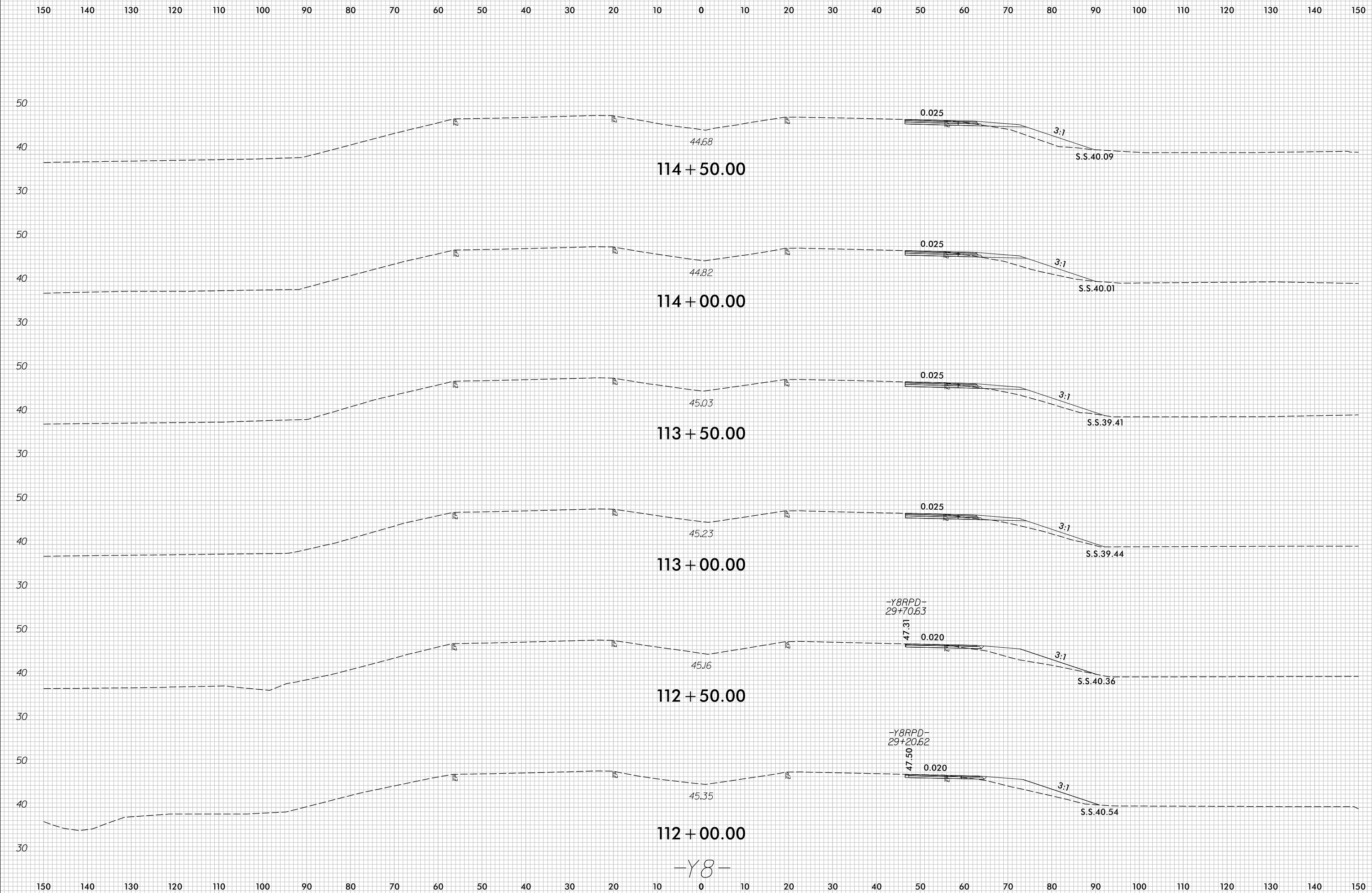
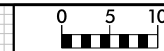

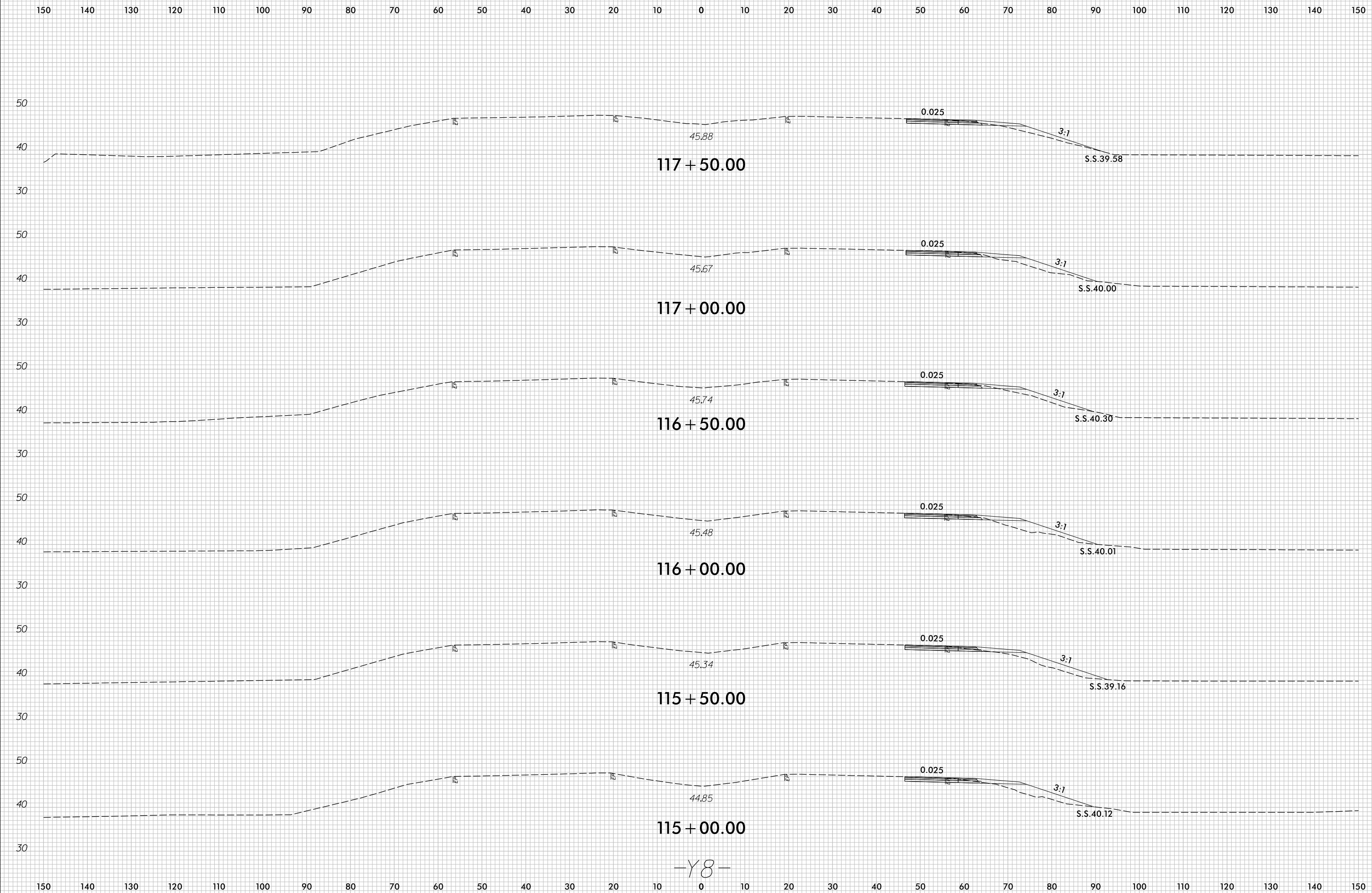

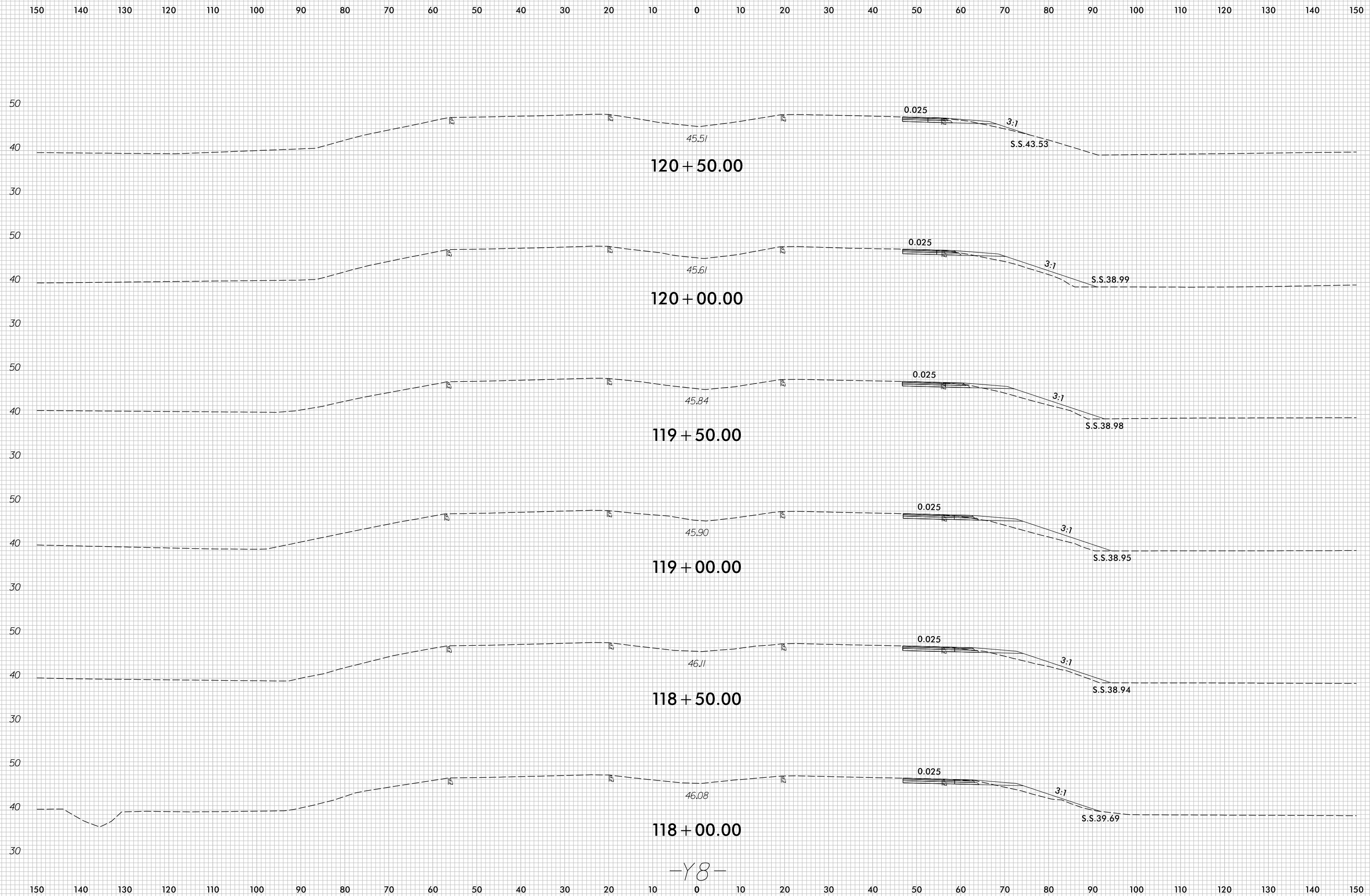

-Y8-

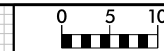

150 140 130 120 110 100 90 80 70 60 50 40 30 20 10 0 10 20 30 40 50 60 70 80 90 100 110 120 130 140 150

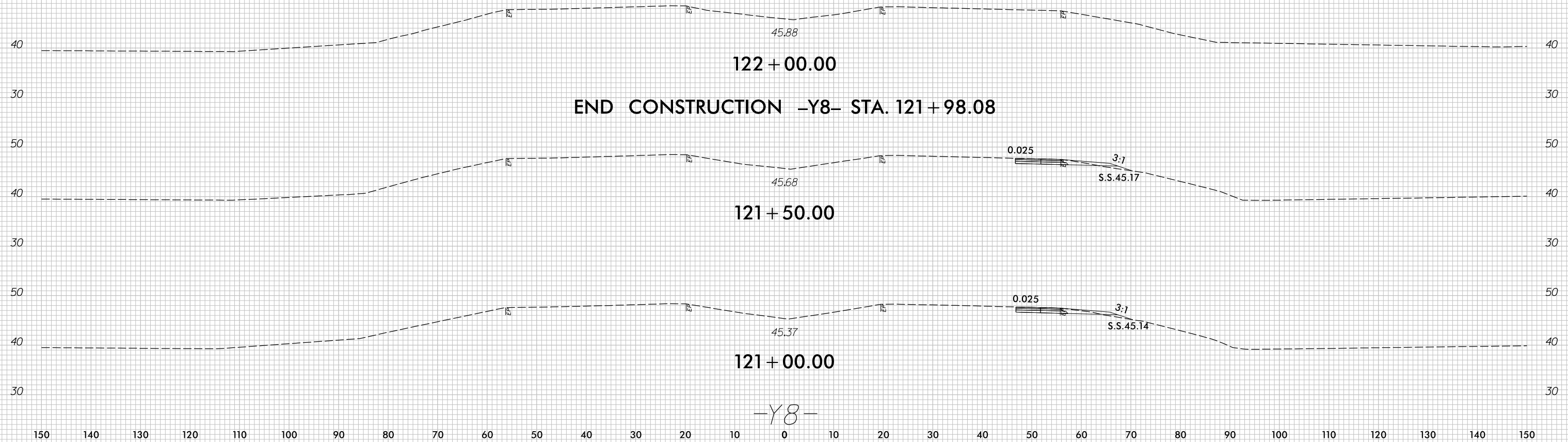

-Y8-

8/23/99

0 5 10	PROJ. REFERENCE NO.	SHEET NO.
	U-4751	X-203

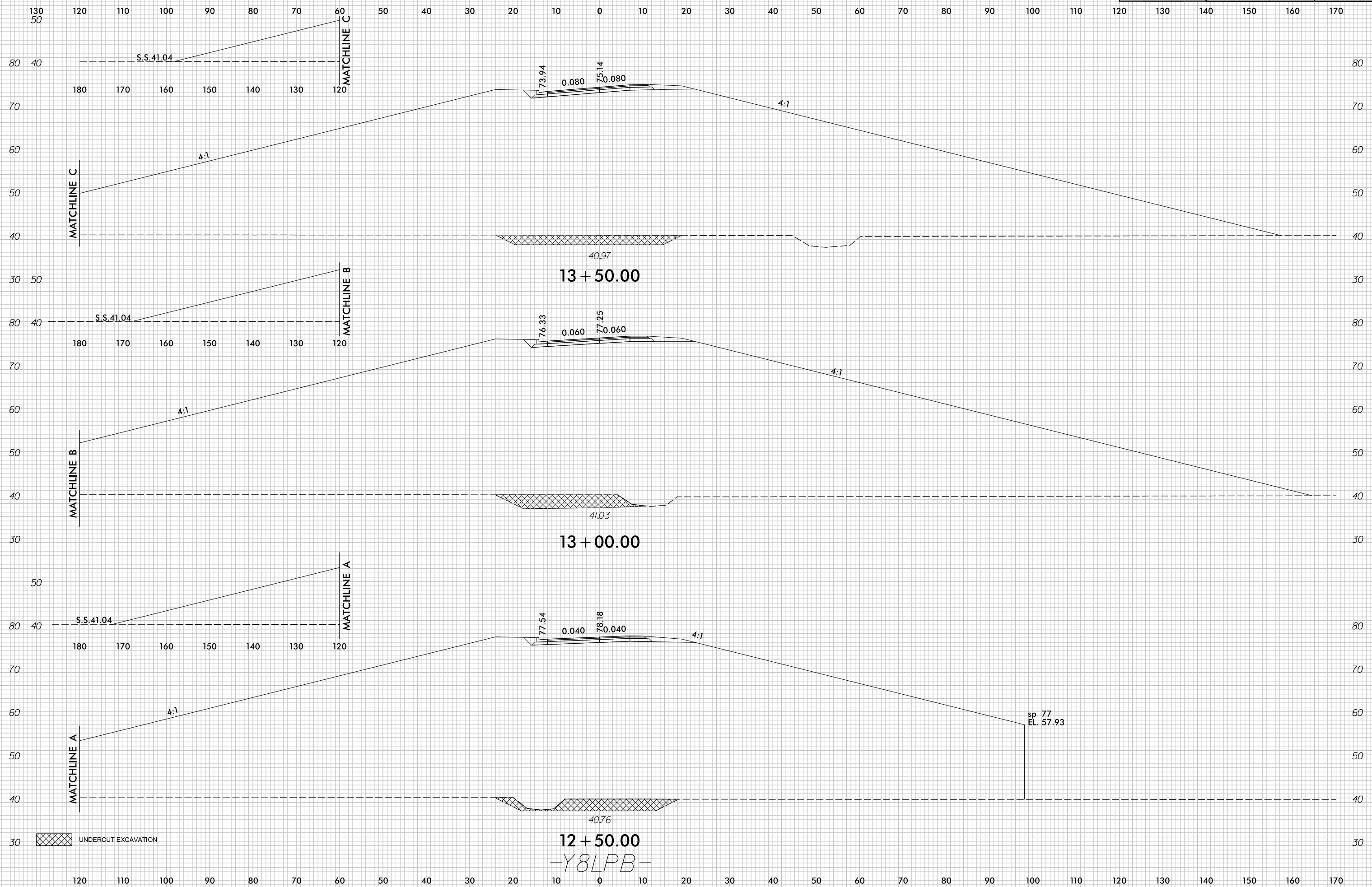

8/23/99

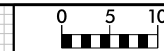

PROJ. REFERENCE NO.
U-4751

SHEET NO.
X-204

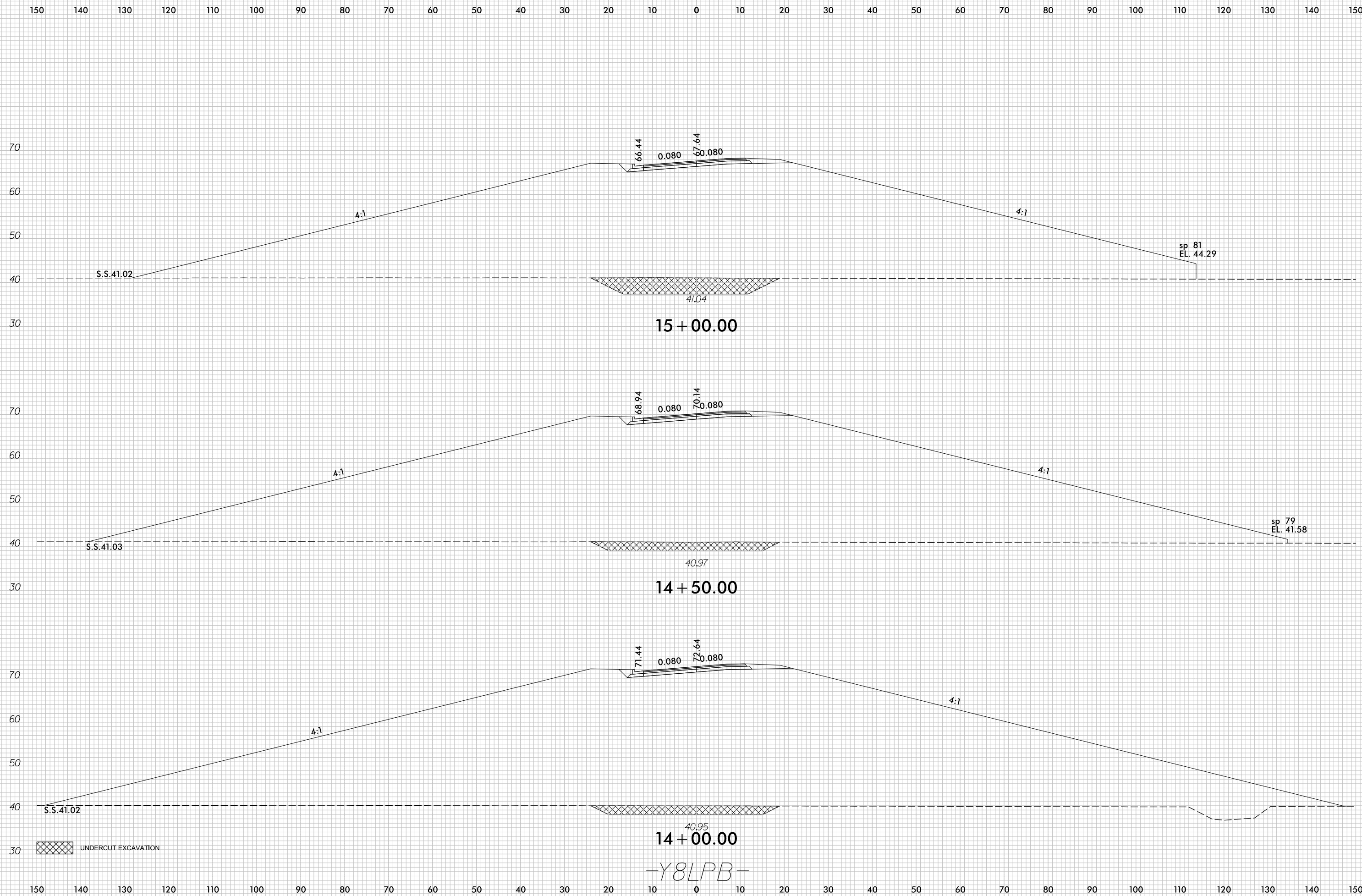

-Y8LPB-

7/5/2017
r:\Roadway\XSC\U4751_Rdu_XPL_Y8LPB.dgn
c:\proves

8/23/99

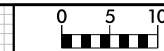

PROJ. REFERENCE NO.	SHEET NO.
U-4751	X-205

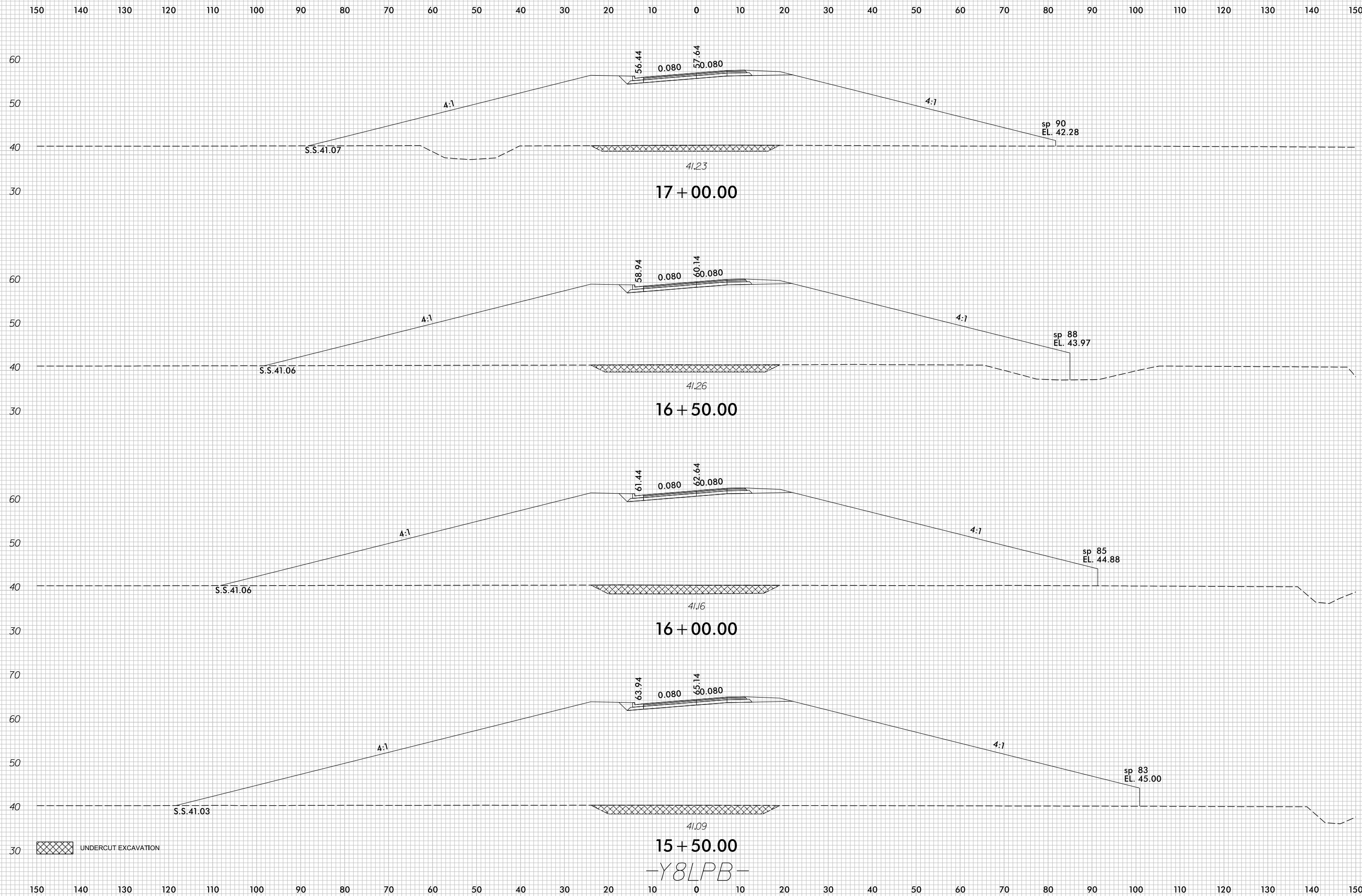

UNDERCUT EXCAVATION

15 + 50.00
-Y8LPB-

7/5/2017
r:\Roadway\XSC\U4751_Rdu_XPL_Y8LPB.dgn
cproves

8/23/99

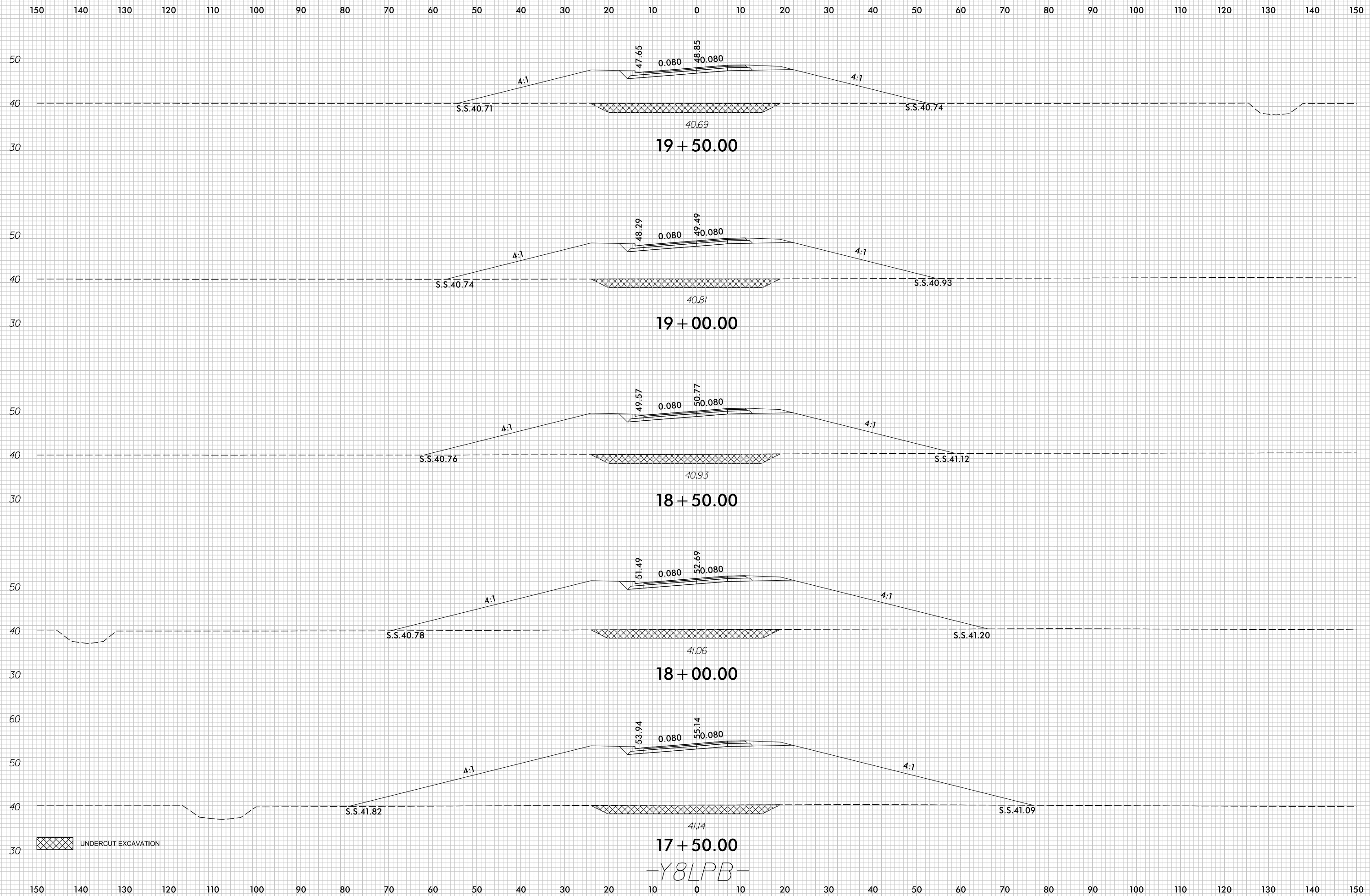

7/5/2017
r:\Roadway\XSC\U4751_Rdu_XPL_Y8LPB.dgn
c:\proves

-Y8LPB-

8/23/99

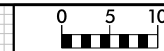

PROJ. REFERENCE NO.	SHEET NO.
U-4751	X-207

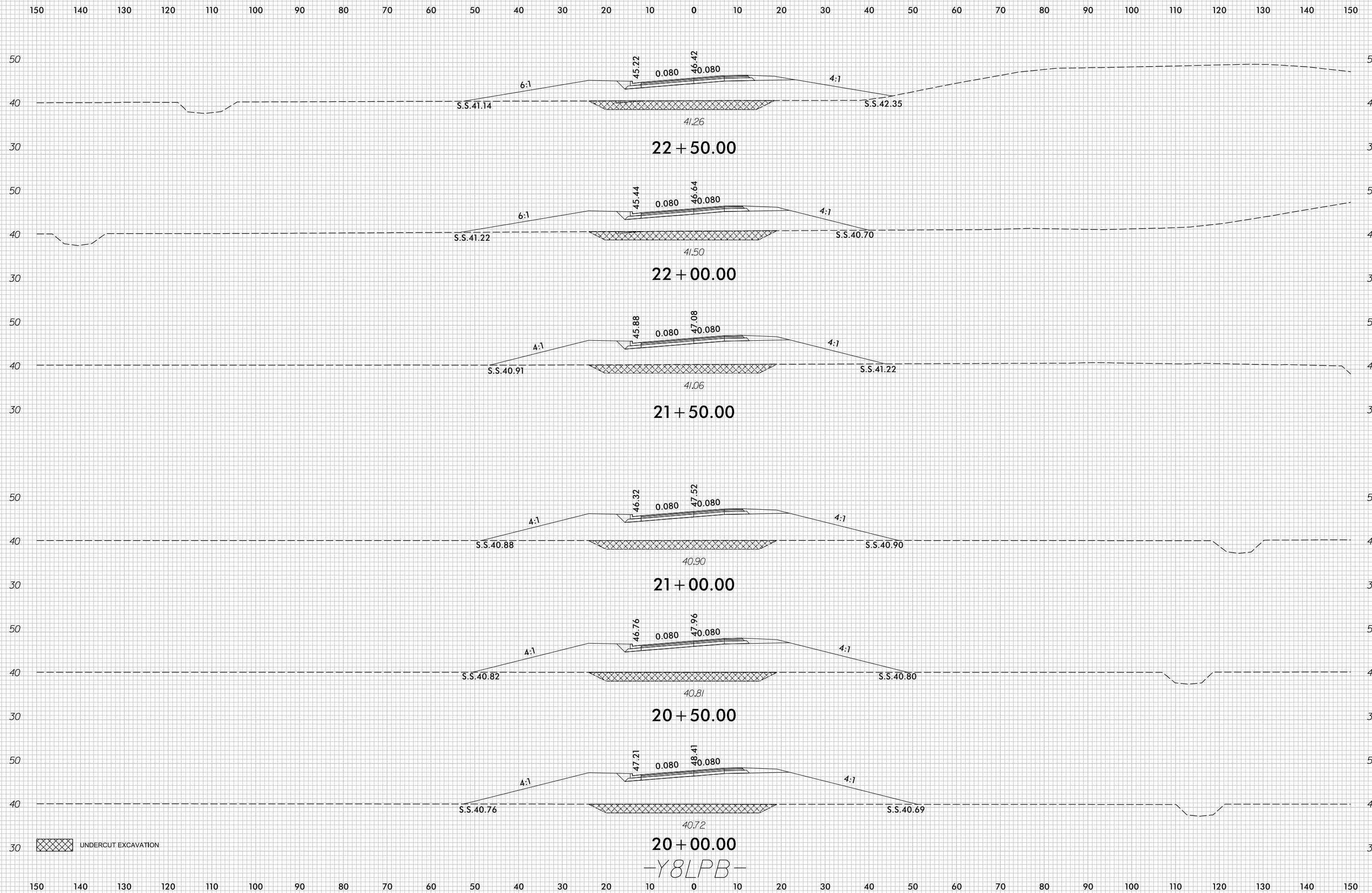

UNDERCUT EXCAVATION

—Y8LPB—

7/5/2017
r:\Roadway\XSC\U4751_Rdu_XPL_Y8LPB.dgn
c:\proves

8/23/99

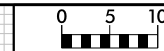

PROJ. REFERENCE NO.	SHEET NO.
U-4751	X-208

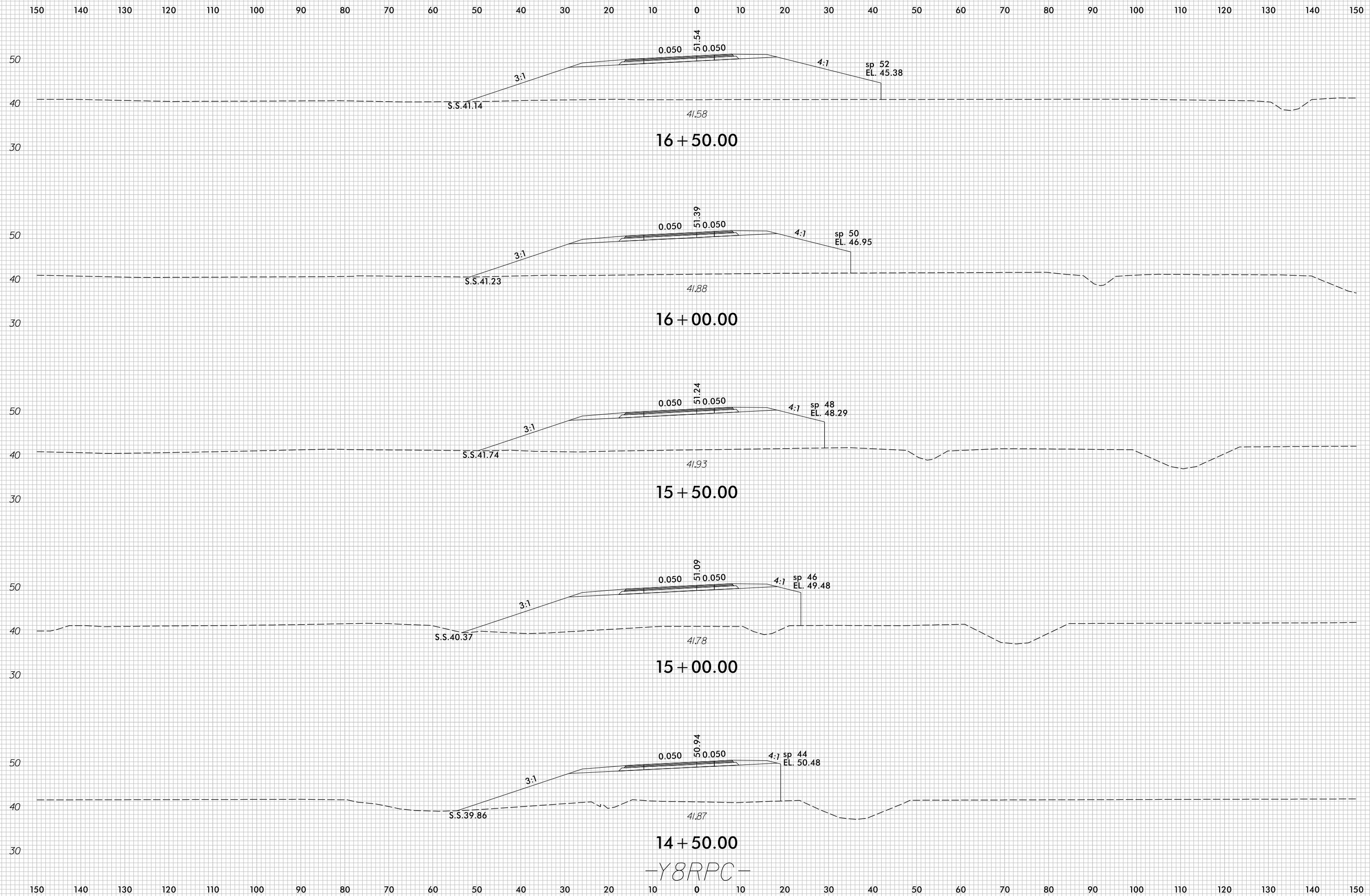

7/5/2017
r:\Roadway\XSC\U4751_Rdy_XPL_Y8RPC.dgn
c:\proves

-Y8RPC-

8/23/99

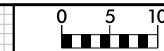

PROJ. REFERENCE NO.	SHEET NO.
U-4751	X-209

150 140 130 120 110 100 90 80 70 60 50 40 30 20 10 0 10 20 30 40 50 60 70 80 90 100 110 120 130 140 150

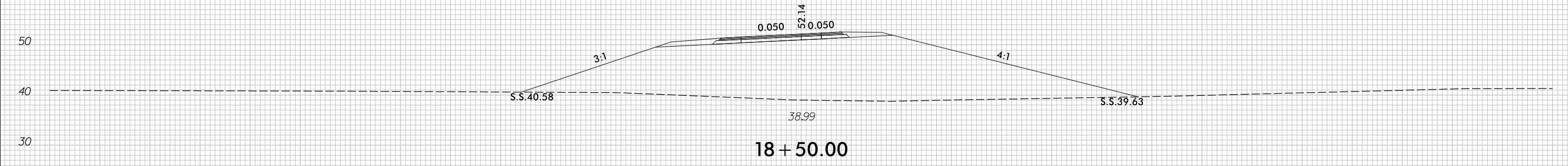

18 + 50.00

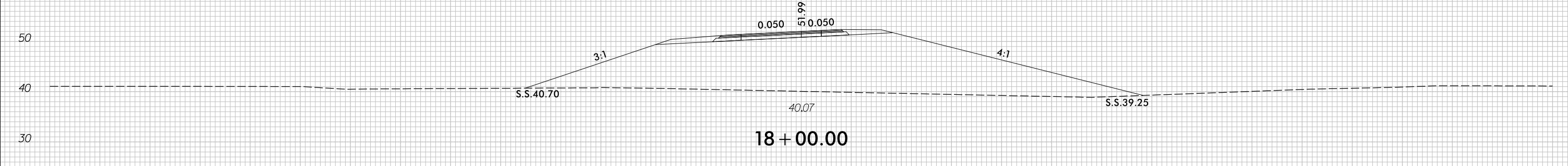

18 + 00.00

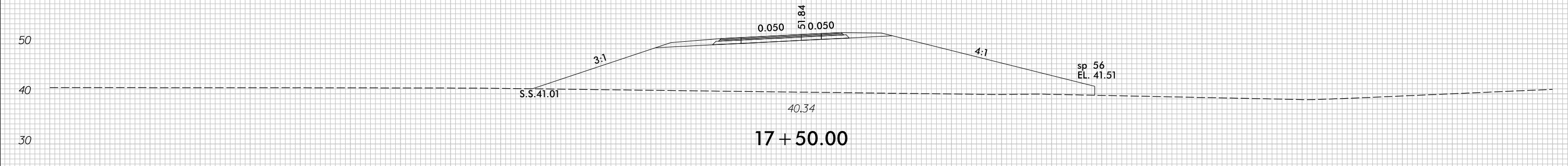

17 + 50.00

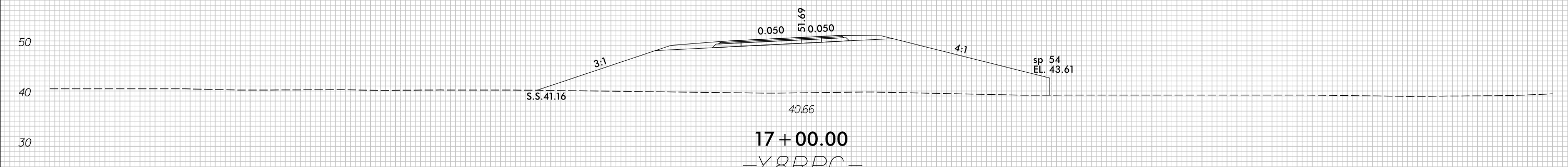

17 + 00.00

-Y8RPC-

150 140 130 120 110 100 90 80 70 60 50 40 30 20 10 0 10 20 30 40 50 60 70 80 90 100 110 120 130 140 150

7/5/2017
r:\Roadway\XSC\U4751_Rdu_XPL_Y8RPC.dgn
c:\proves

8/23/99

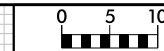

PROJ. REFERENCE NO.	SHEET NO.
U-4751	X-210

150 140 130 120 110 100 90 80 70 60 50 40 30 20 10 0 10 20 30 40 50 60 70 80 90 100 110 120 130 140 150

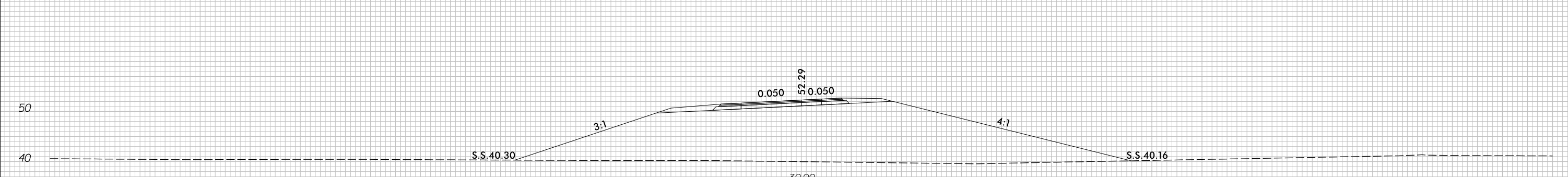
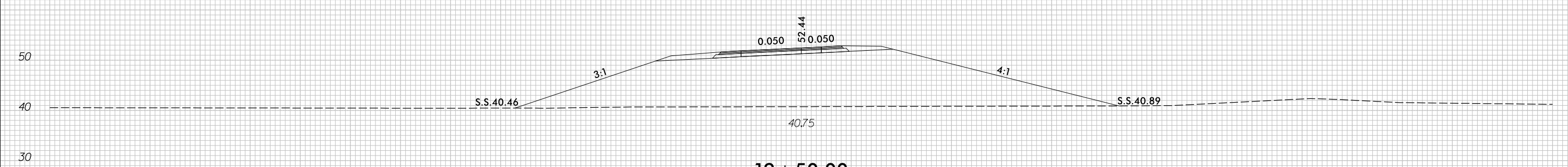
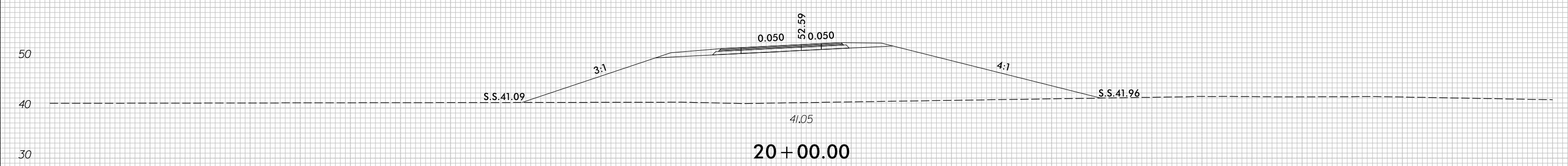
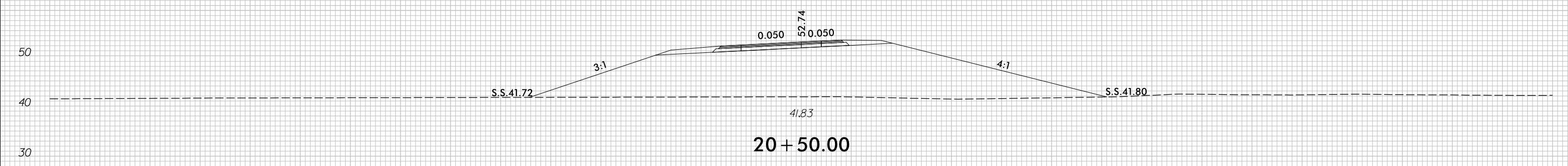

150 140 130 120 110 100 90 80 70 60 50 40 30 20 10 0 10 20 30 40 50 60 70 80 90 100 110 120 130 140 150

7/5/2017
r:\Roadway\XSC\U4751_Rdu_XPL_Y8RPC.dgn
c:\proves

-Y8RPC-

8/23/99

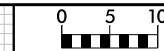

PROJ. REFERENCE NO.	SHEET NO.
U-4751	X-211

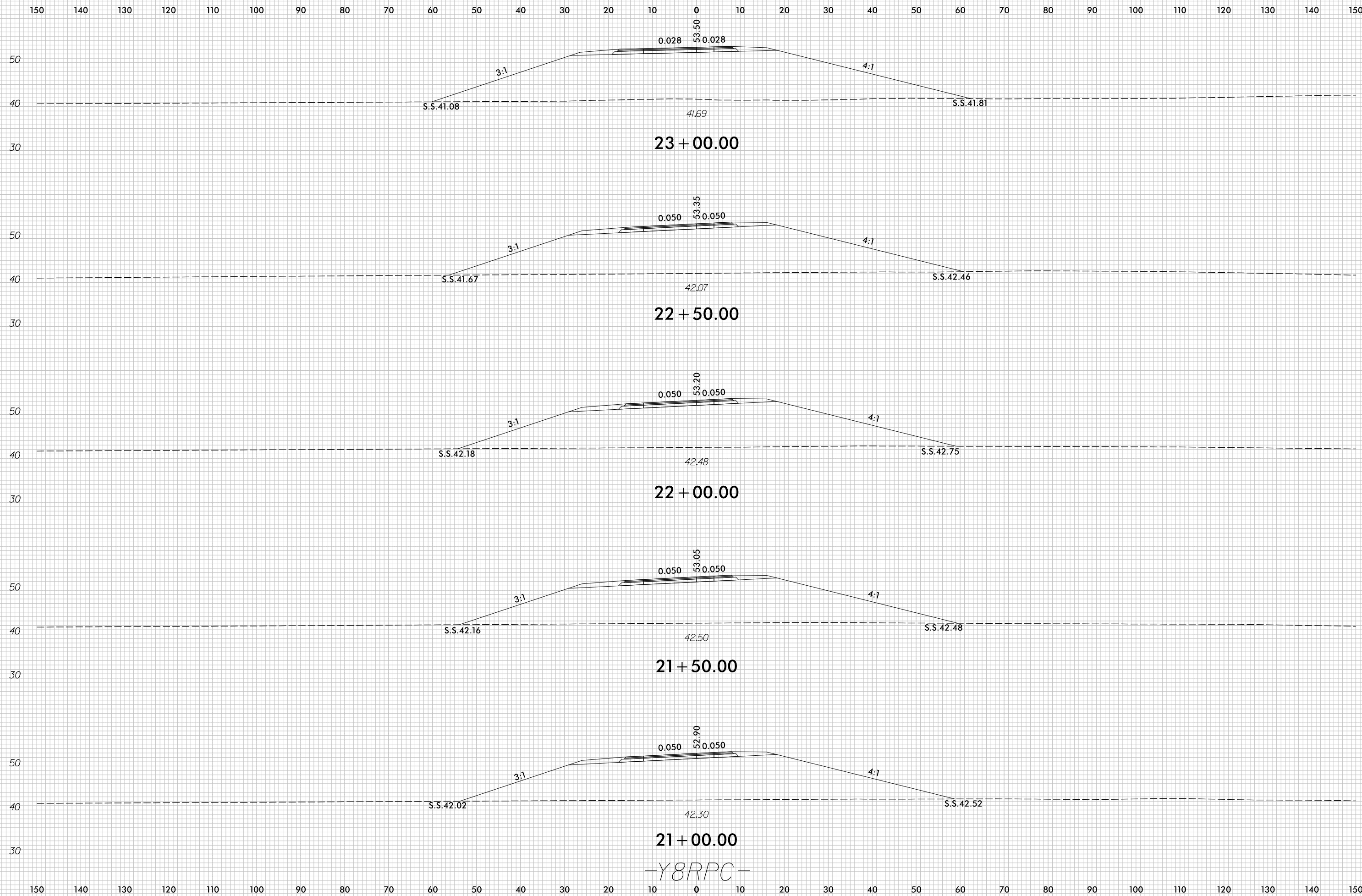

-Y8RPC-

7/5/2017
r:\Roadway\XSC\U4751_Rdy_XPL_Y8RPC.dgn
c:\proves

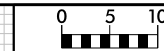

150 140 130 120 110 100 90 80 70 60 50 40 30 20 10 0 10 20 30 40 50 60 70 80 90 100 110 120 130 140 150

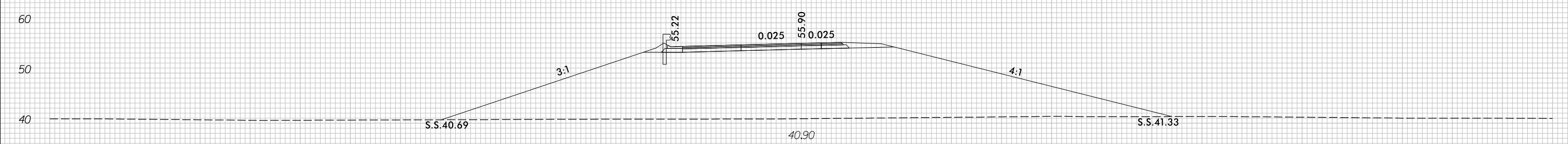

25 + 00.00

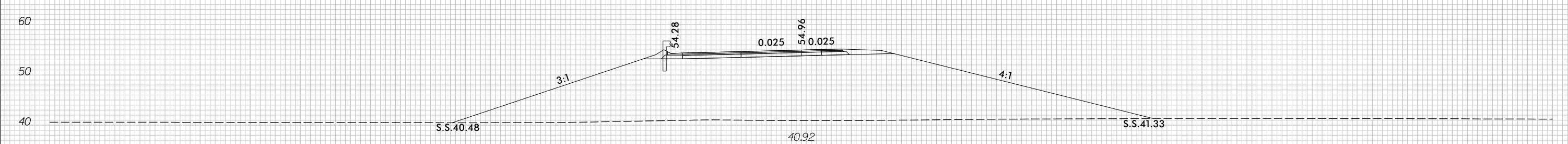

24 + 50.00

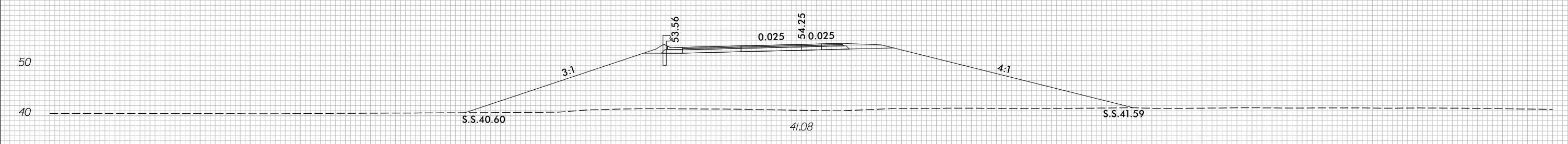

24 + 00.00

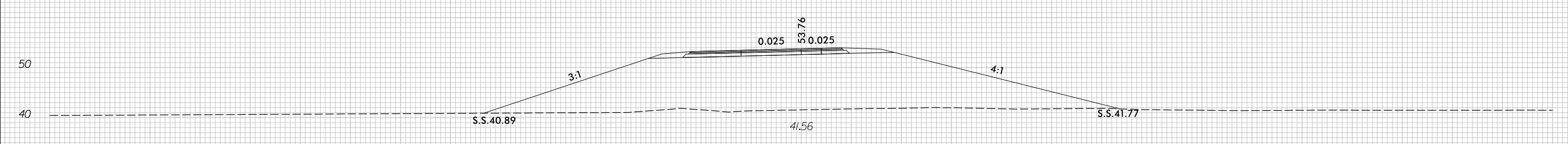

23 + 50.00

-Y8RPC-

150 140 130 120 110 100 90 80 70 60 50 40 30 20 10 0 10 20 30 40 50 60 70 80 90 100 110 120 130 140 150

8/23/99

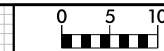

PROJ. REFERENCE NO.	SHEET NO.
U-4751	X-213

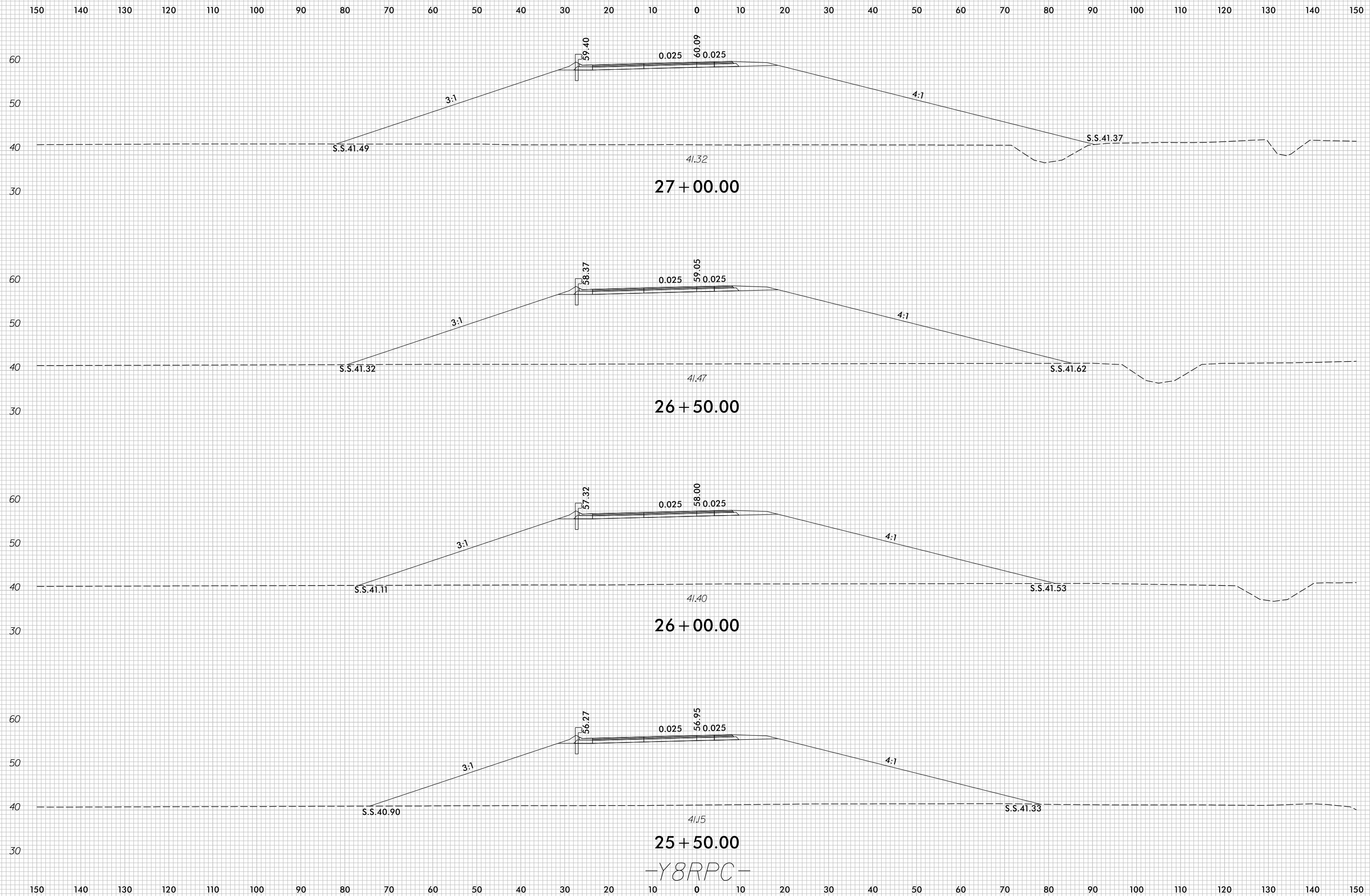

7/5/2017
r:\Roadway\XSC\U4751_Rdu_XPL_Y8RPC.dgn
c:\proves

-Y8RPC-

8/23/99

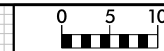

PROJ. REFERENCE NO.	SHEET NO.
U-4751	X-214

PROJ. REFERENCE NO.	SHEET NO.
U-4751	X-214

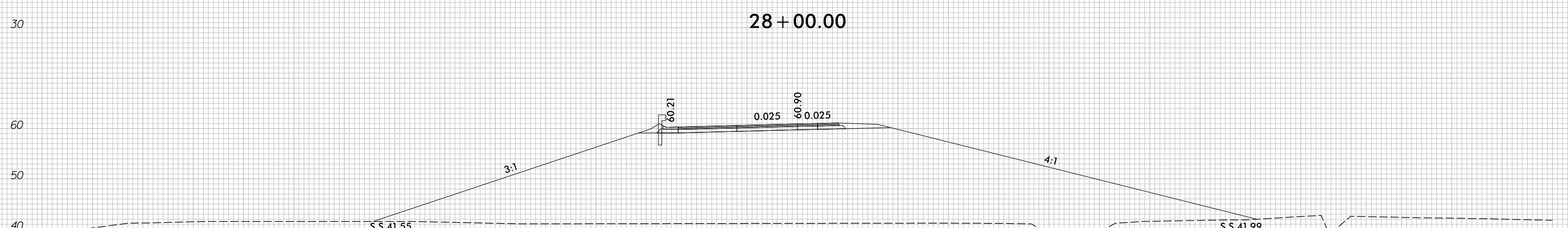
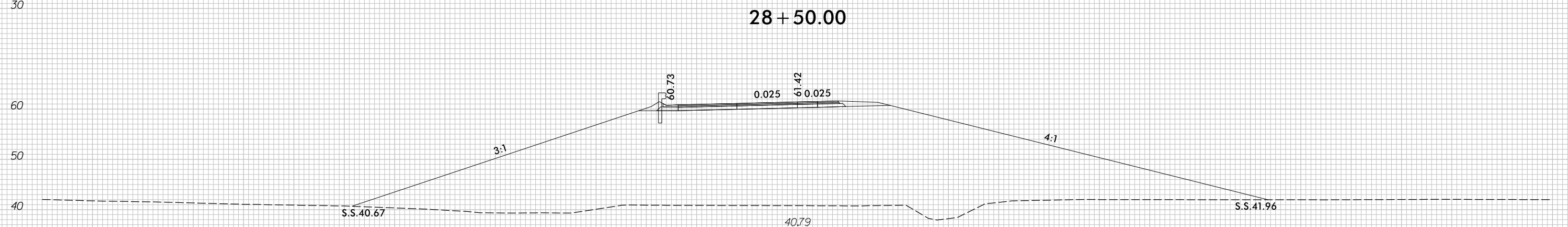
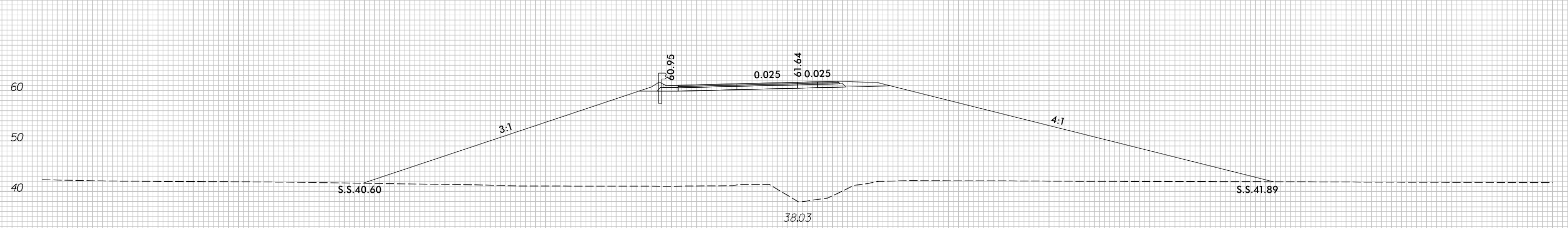
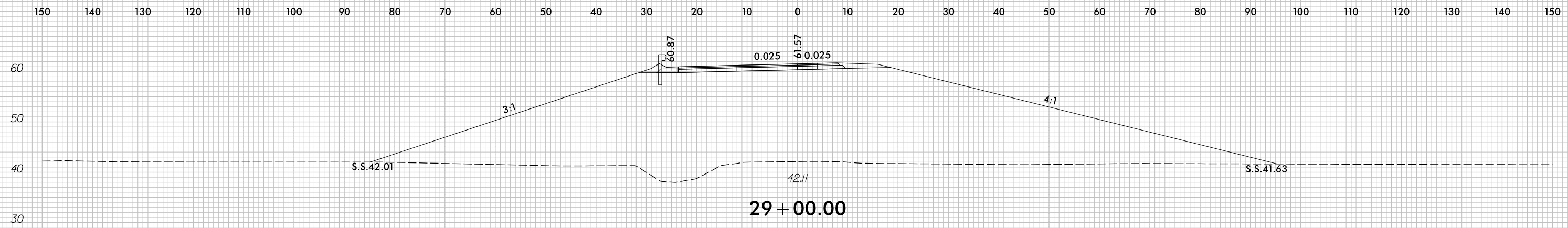

—Y8RPC—

7/5/2017
 r:\Roadway\XSC\U4751_Rdy_XPL_Y8RPC.dgn
 c:\proves

8/23/99

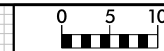

PROJ. REFERENCE NO.	SHEET NO.
U-4751	X-215

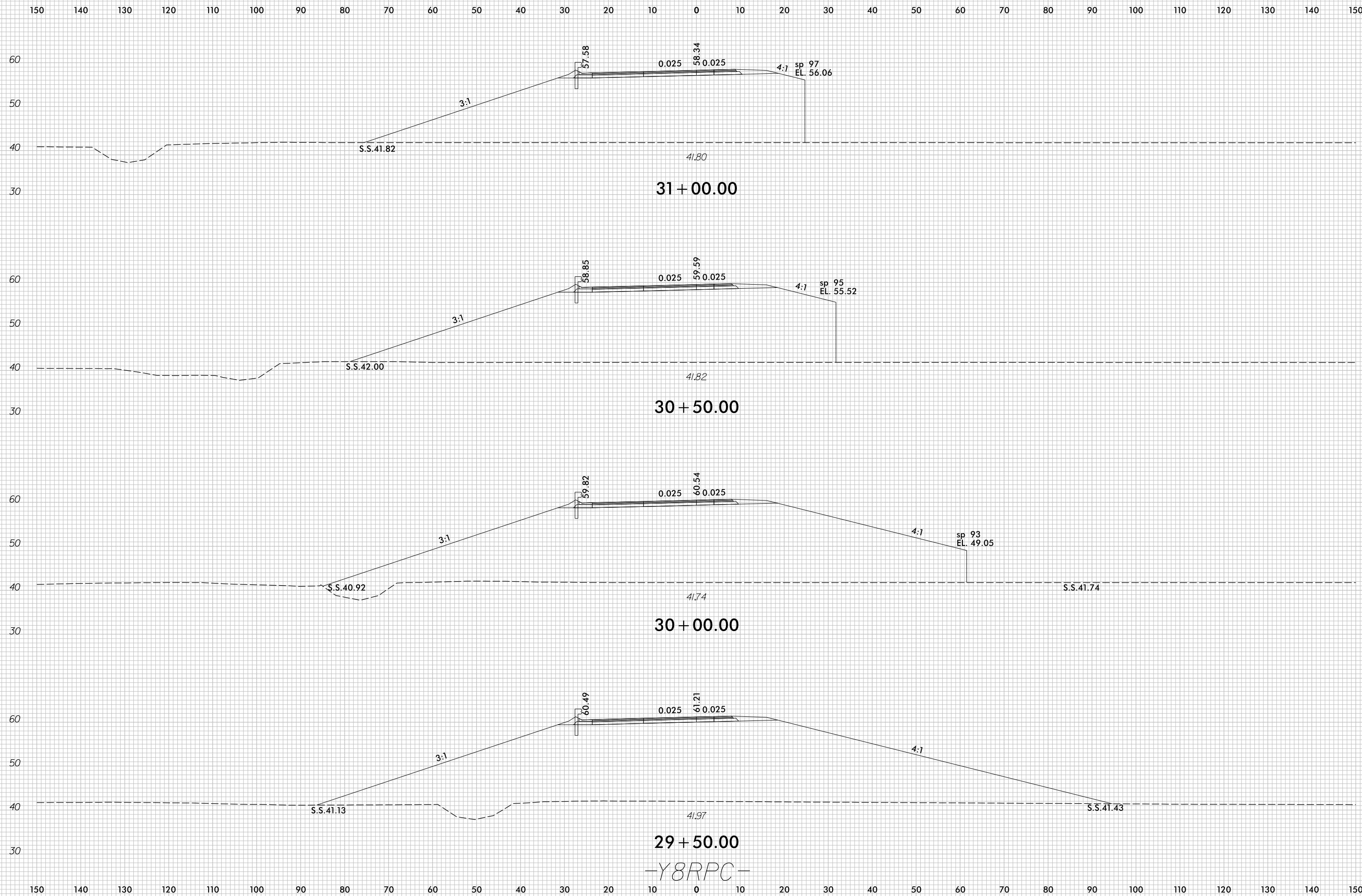

29 + 50.00
 -Y8RPC-

7/5/2017
 r:\Roadway\XSC\U4751_Rdy_XPL_Y8RPC.dgn
 c:\proves

8/23/99

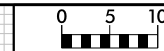

PROJ. REFERENCE NO.	SHEET NO.
U-4751	X-216

150 140 130 120 110 100 90 80 70 60 50 40 30 20 10 0 10 20 30 40 50 60 70 80 90 100 110 120 130 140 150

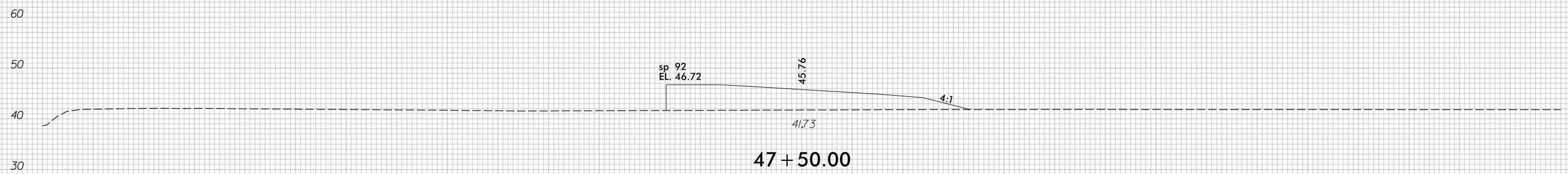
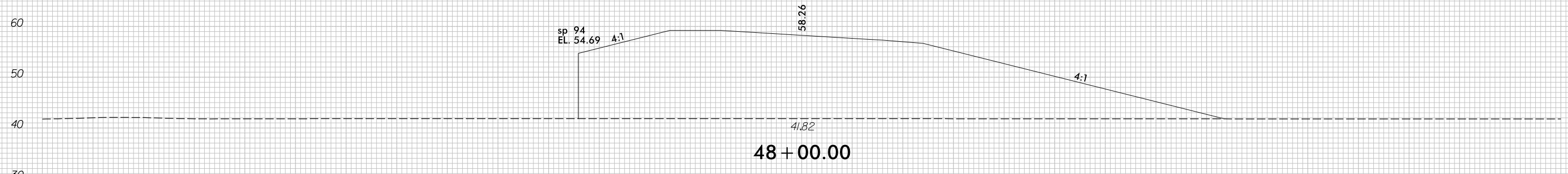
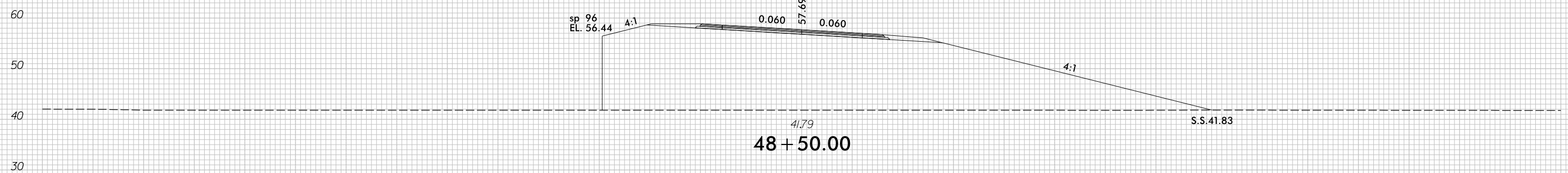
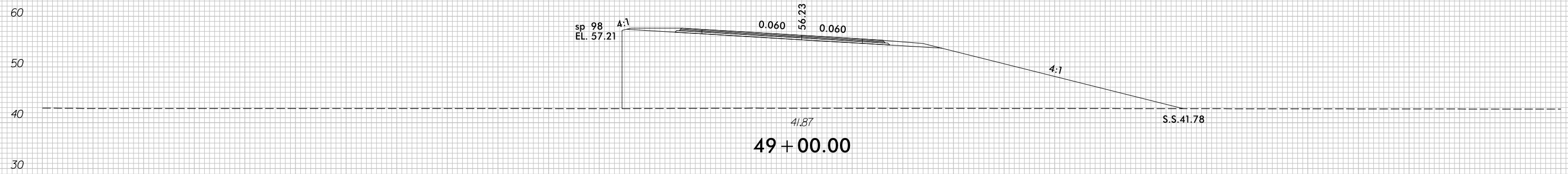

-Y8RPCA-

7/5/2017
r:\Roadway\XSC\U4751_Rdy_XPL_Y8RPCA.dgn
c:\proves

150 140 130 120 110 100 90 80 70 60 50 40 30 20 10 0 10 20 30 40 50 60 70 80 90 100 110 120 130 140 150

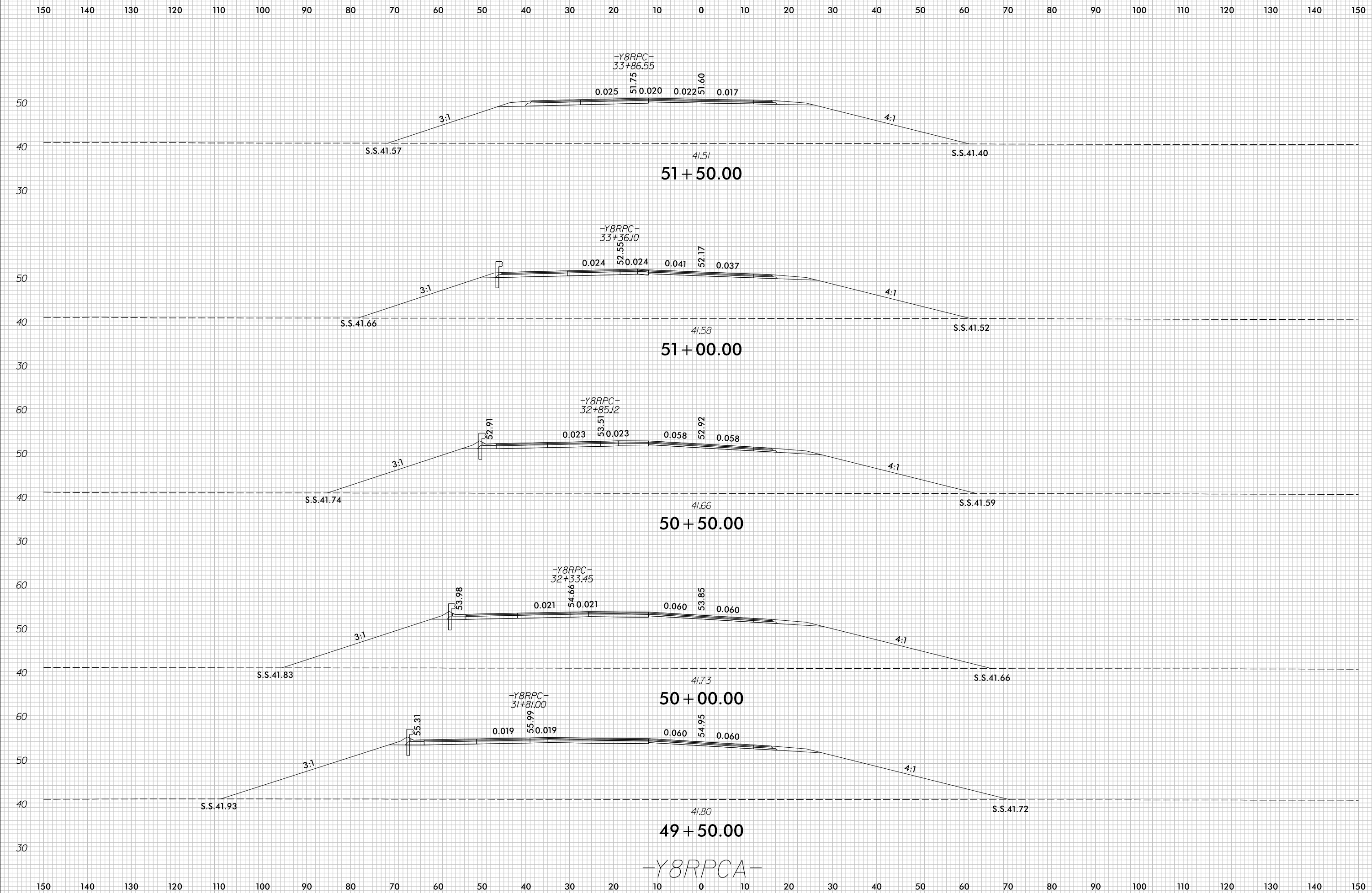
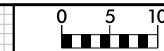

8/23/99

150 140 130 120 110 100 90 80 70 60 50 40 30 20 10 0 10 20 30 40 50 60 70 80 90 100 110 120 130 140 150

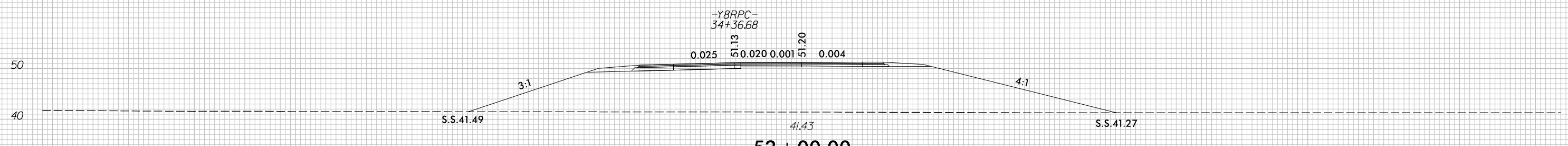
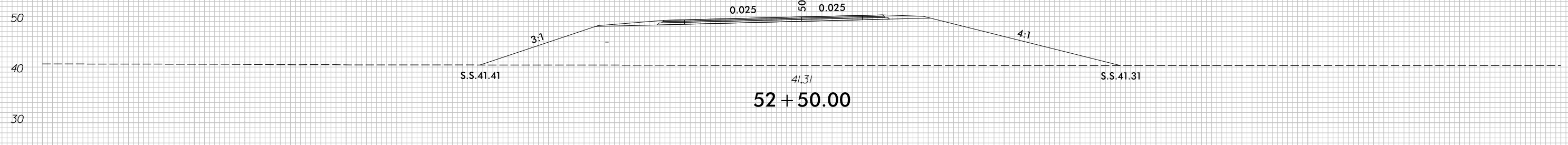
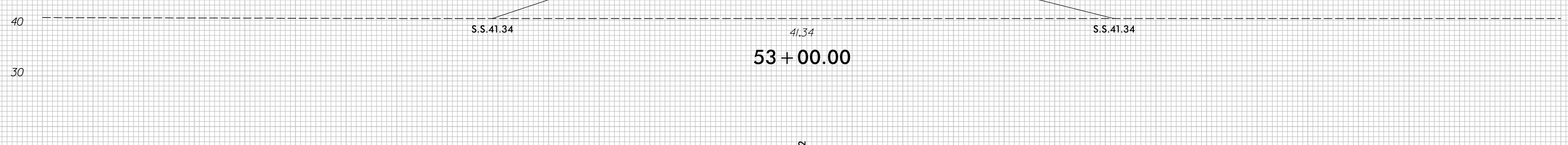
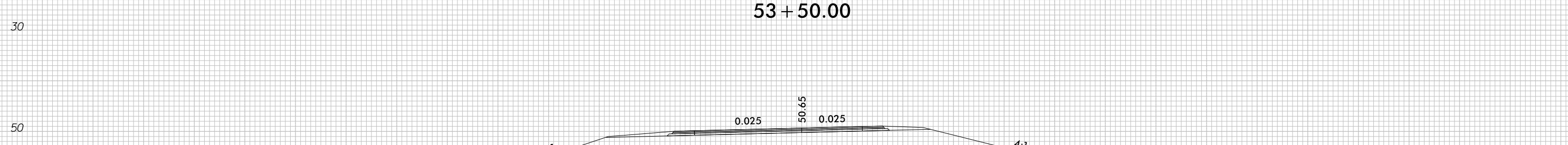
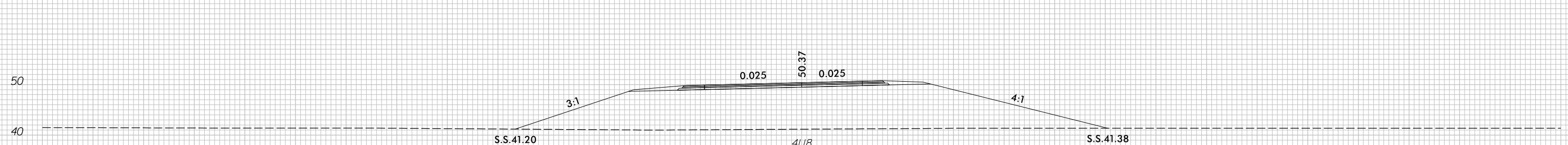
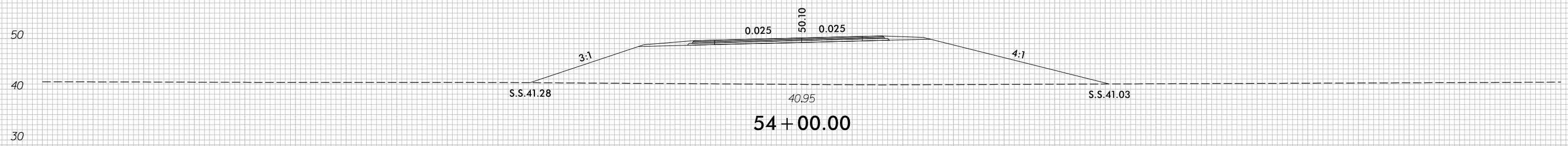

150 140 130 120 110 100 90 80 70 60 50 40 30 20 10 0 10 20 30 40 50 60 70 80 90 100 110 120 130 140 150

7/5/2017 r:\Roadway\XSC\U4751_Rdy_XPL_Y8RPCA.dgn c:\proves

-Y8RPC-
34+36.68
51.13
0.025 51.020 0.001 51.20 0.004
41.43
-Y8RPCA-

8/23/99

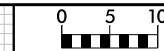

PROJ. REFERENCE NO.	SHEET NO.
U-4751	X-219

150 140 130 120 110 100 90 80 70 60 50 40 30 20 10 0 10 20 30 40 50 60 70 80 90 100 110 120 130 140 150

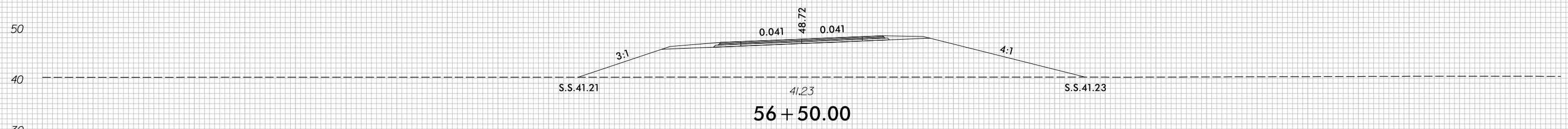

56 + 50.00

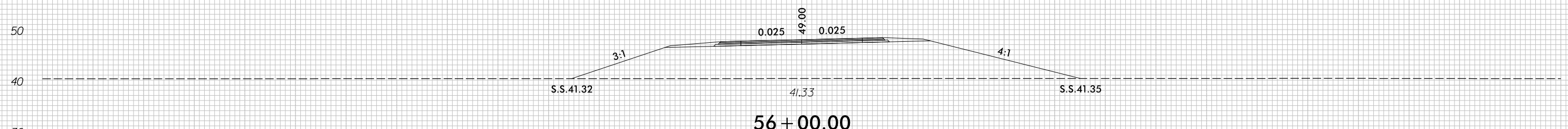

56 + 00.00

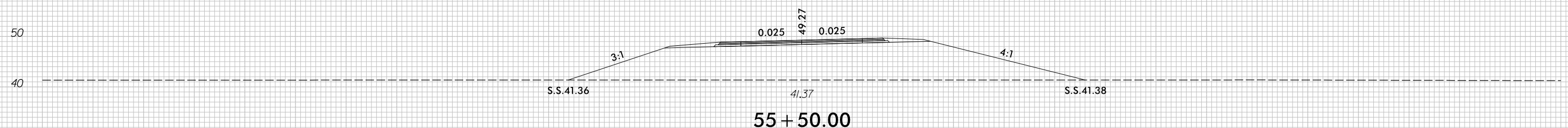

55 + 50.00

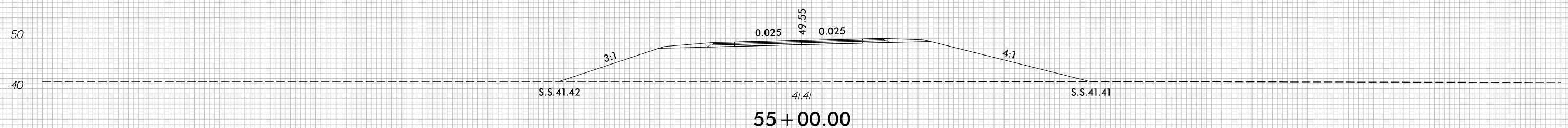

55 + 00.00

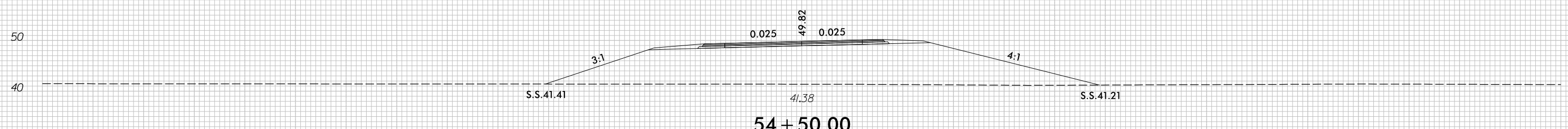

54 + 50.00

-Y8RPCA-

150 140 130 120 110 100 90 80 70 60 50 40 30 20 10 0 10 20 30 40 50 60 70 80 90 100 110 120 130 140 150

7/5/2017
r:\Roadway\XSC\U4751_Rdy_XPL_Y8RPCA.dgn
c:\proves

8/23/99

0 5 10	PROJ. REFERENCE NO.	SHEET NO.
	U-4751	X-220

150 140 130 120 110 100 90 80 70 60 50 40 30 20 10 0 10 20 30 40 50 60 70 80 90 100 110 120 130 140 150

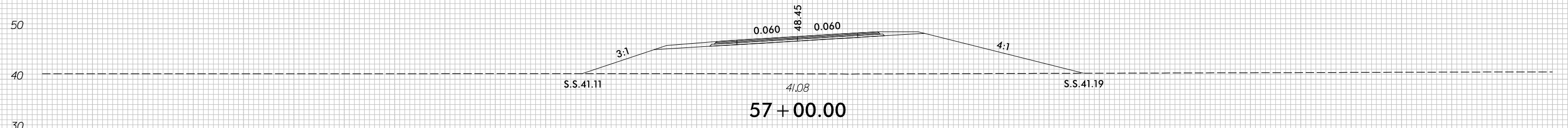
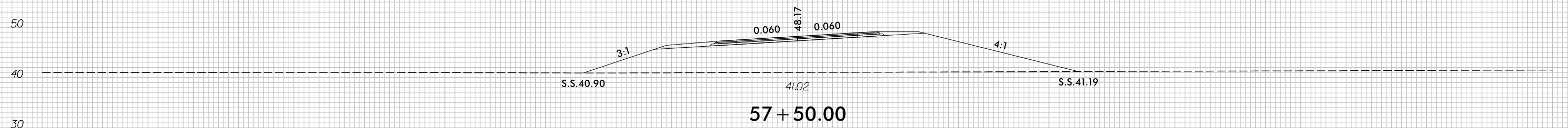
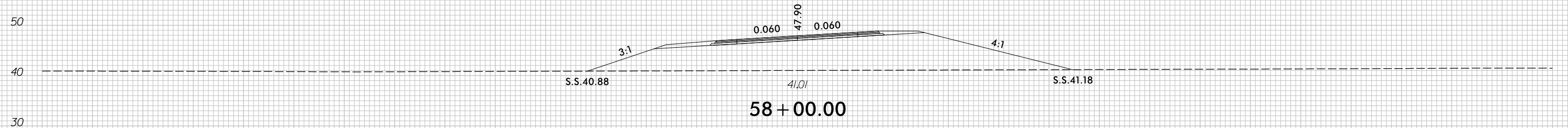
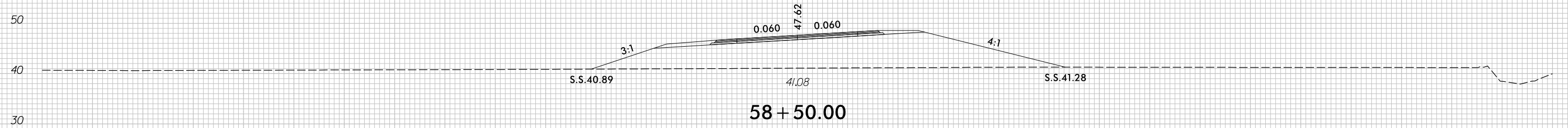
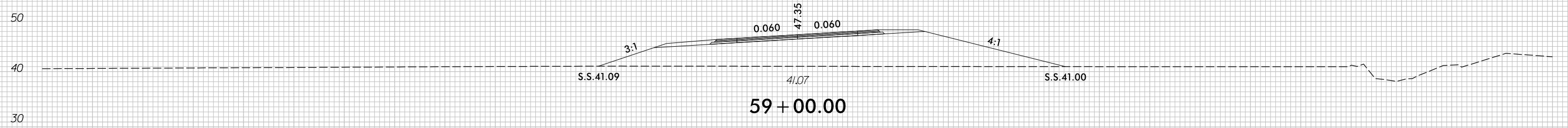

-Y8RPCA-

7/5/2017
r:\Roadway\XSC\U4751_Rdu_XPL_Y8RPCA.dgn
c:\proves

150 140 130 120 110 100 90 80 70 60 50 40 30 20 10 0 10 20 30 40 50 60 70 80 90 100 110 120 130 140 150

8/23/99



PROJ. REFERENCE NO.	SHEET NO.
U-4751	X-221

PROJ. REFERENCE NO.	SHEET NO.
U-4751	X-221

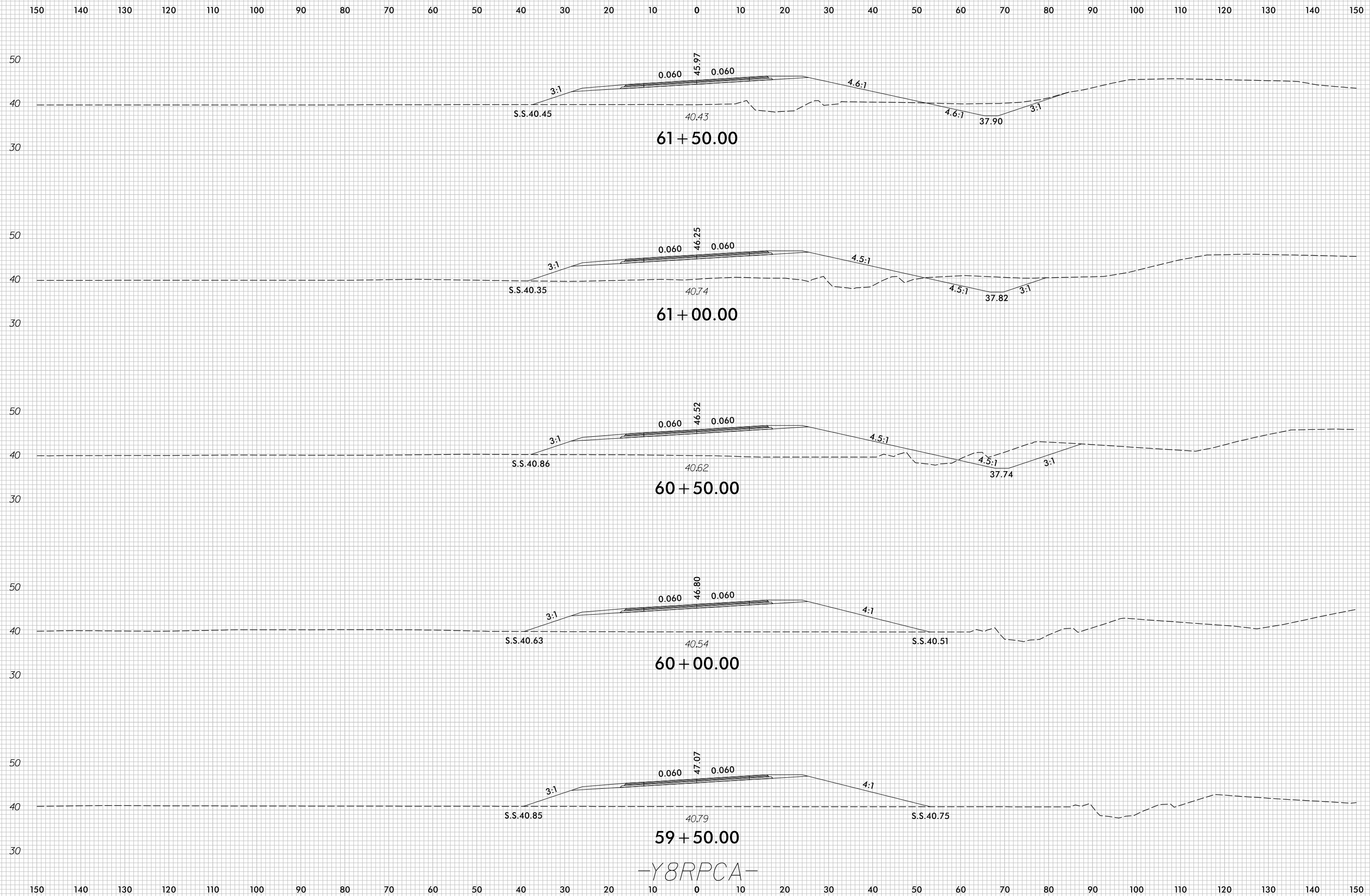

-Y8RPCA-

7/5/2017
 r:\Roadway\XSC\U4751_Rdu_XPL_Y8RPCA.dgn
 c:\proves

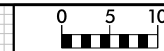

150 140 130 120 110 100 90 80 70 60 50 40 30 20 10 0 10 20 30 40 50 60 70 80 90 100 110 120 130 140 150

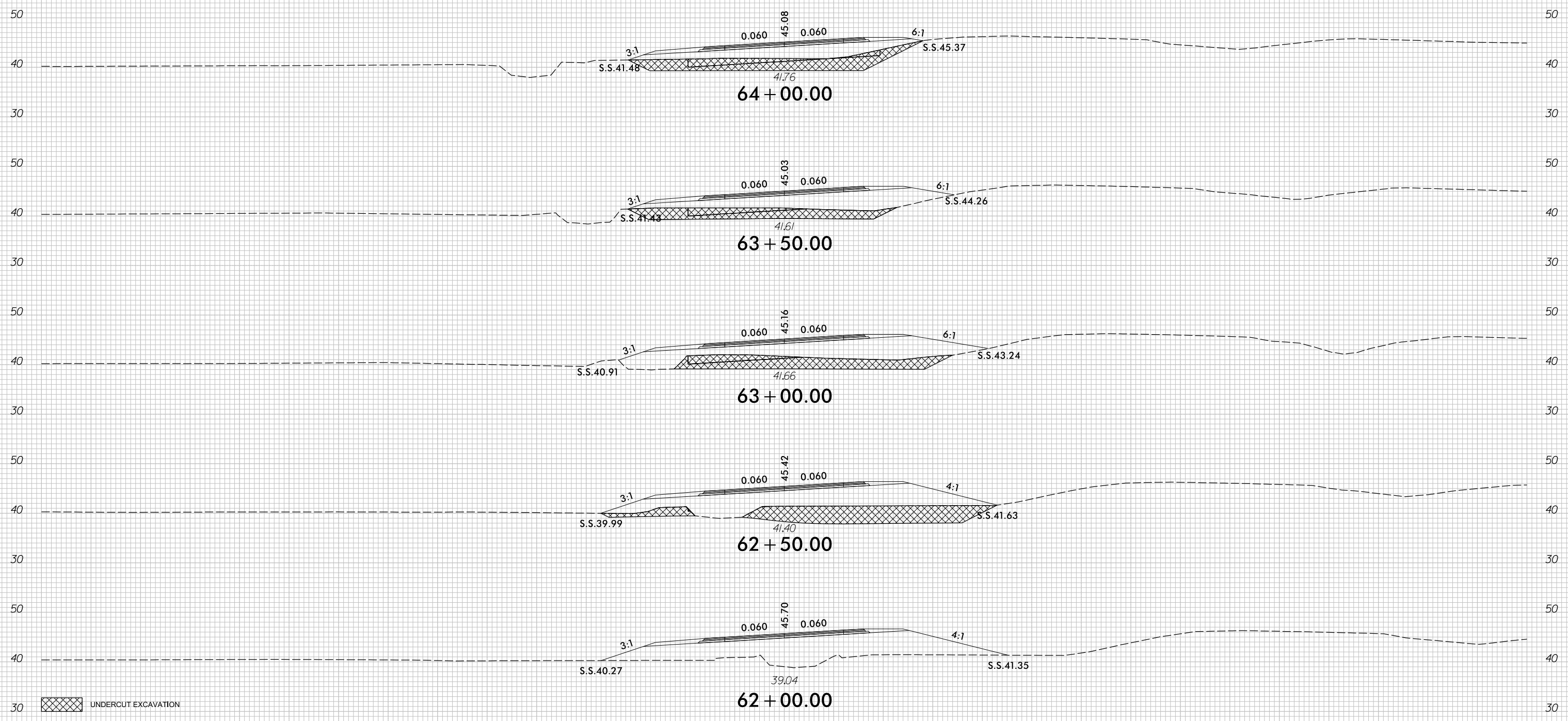

UNDERCUT EXCAVATION

-Y8RPCA-

150 140 130 120 110 100 90 80 70 60 50 40 30 20 10 0 10 20 30 40 50 60 70 80 90 100 110 120 130 140 150

8/23/99

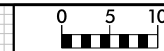

PROJ. REFERENCE NO.	SHEET NO.
U-4751	X-223

150 140 130 120 110 100 90 80 70 60 50 40 30 20 10 0 10 20 30 40 50 60 70 80 90 100 110 120 130 140 150

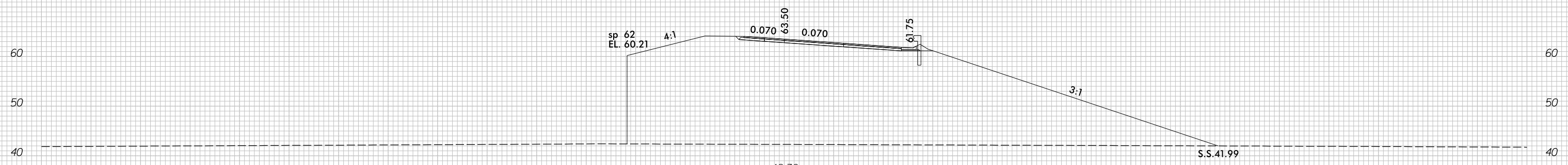

15 + 50.00

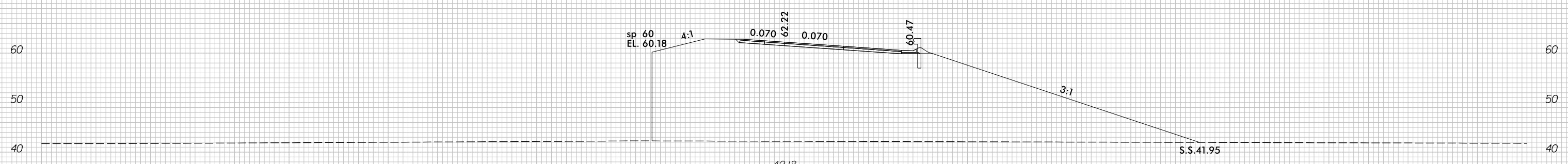

15 + 00.00

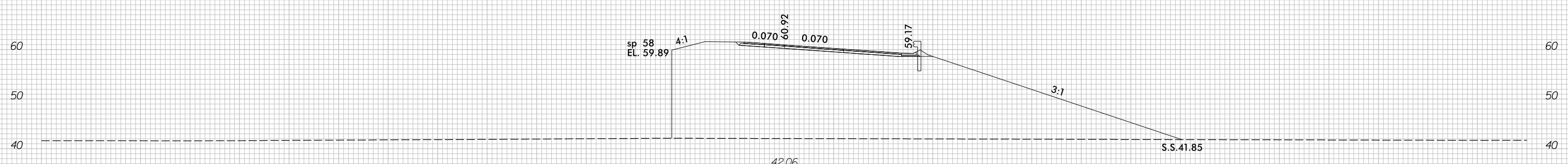

14 + 50.00

-Y8RPD-

150 140 130 120 110 100 90 80 70 60 50 40 30 20 10 0 10 20 30 40 50 60 70 80 90 100 110 120 130 140 150

7/5/2017
r:\Roadway\XSC\U4751_Rdy_XPL_Y8RPD.dgn
c:\proves

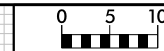

150 140 130 120 110 100 90 80 70 60 50 40 30 20 10 0 10 20 30 40 50 60 70 80 90 100 110 120 130 140 150

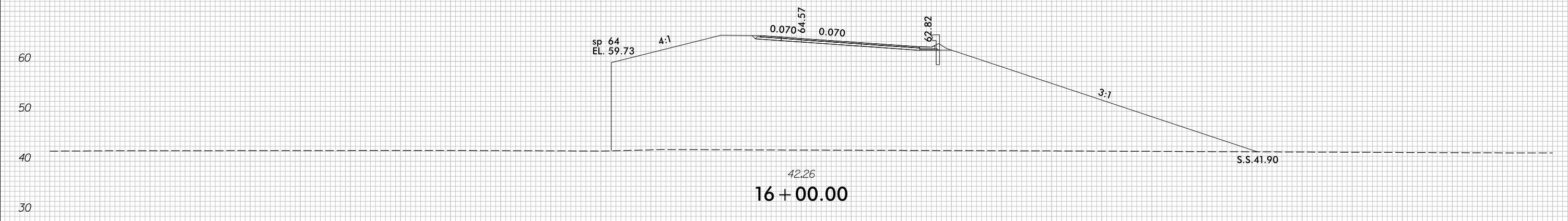
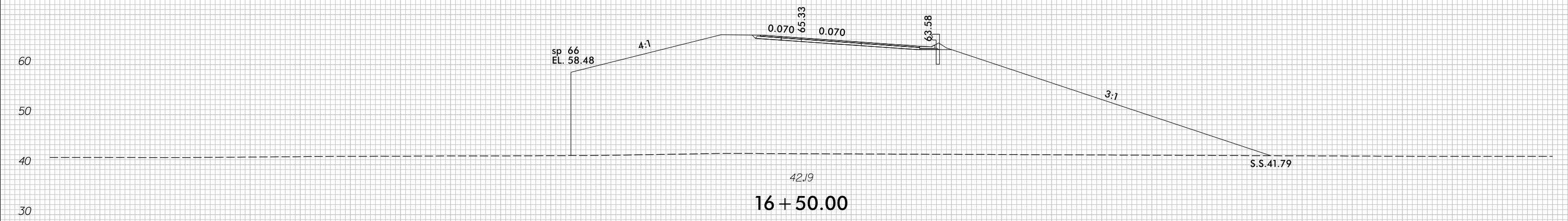
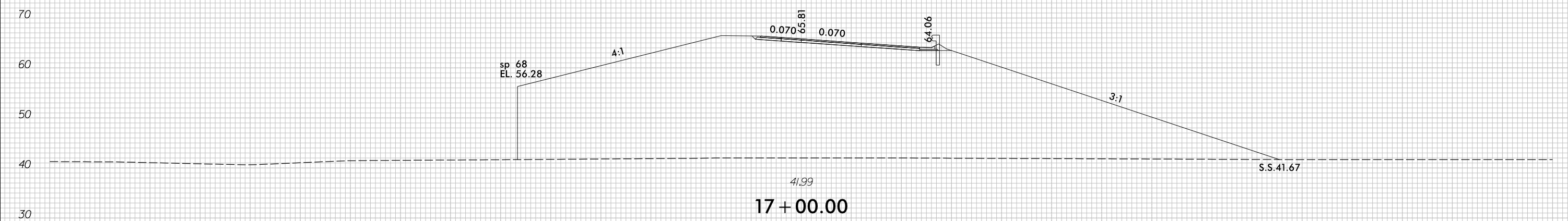

150 140 130 120 110 100 90 80 70 60 50 40 30 20 10 0 10 20 30 40 50 60 70 80 90 100 110 120 130 140 150

-Y8RPD-

8/23/99

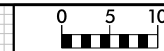

PROJ. REFERENCE NO.	SHEET NO.
U-4751	X-225

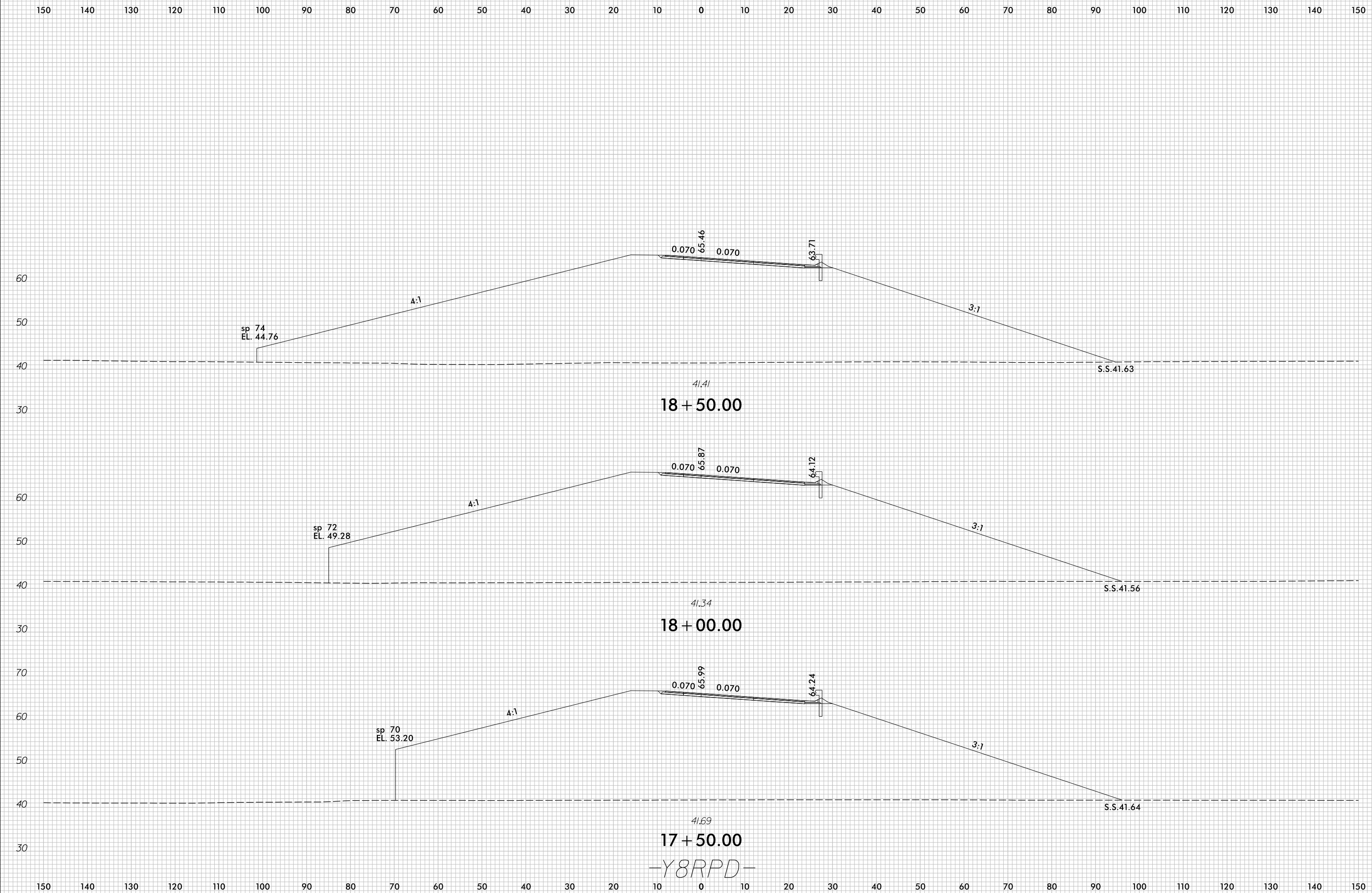

-Y8RPD-

7/5/2017
r:\Roadway\XSC\U4751_Rdu_XPL_Y8RPD.dgn
c:\proves

8/23/99

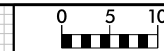

PROJ. REFERENCE NO.	SHEET NO.
U-4751	X-226

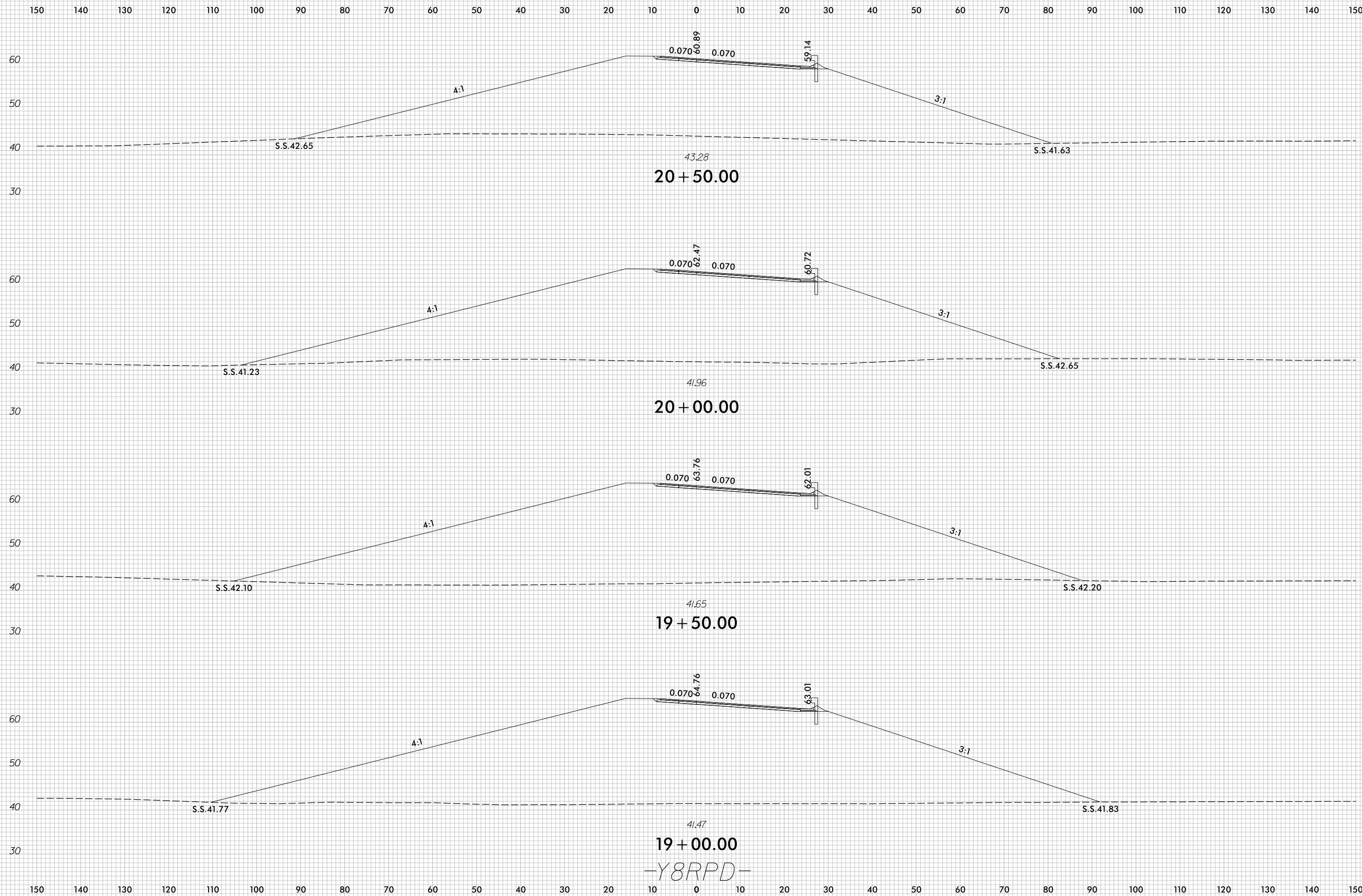

-Y8RPD-

7/5/2017
r:\Roadway\XSC\U4751_Rdu_XPL_Y8RPD.dgn
c:\proves

8/23/99

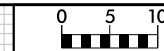

PROJ. REFERENCE NO.	SHEET NO.
U-4751	X-227

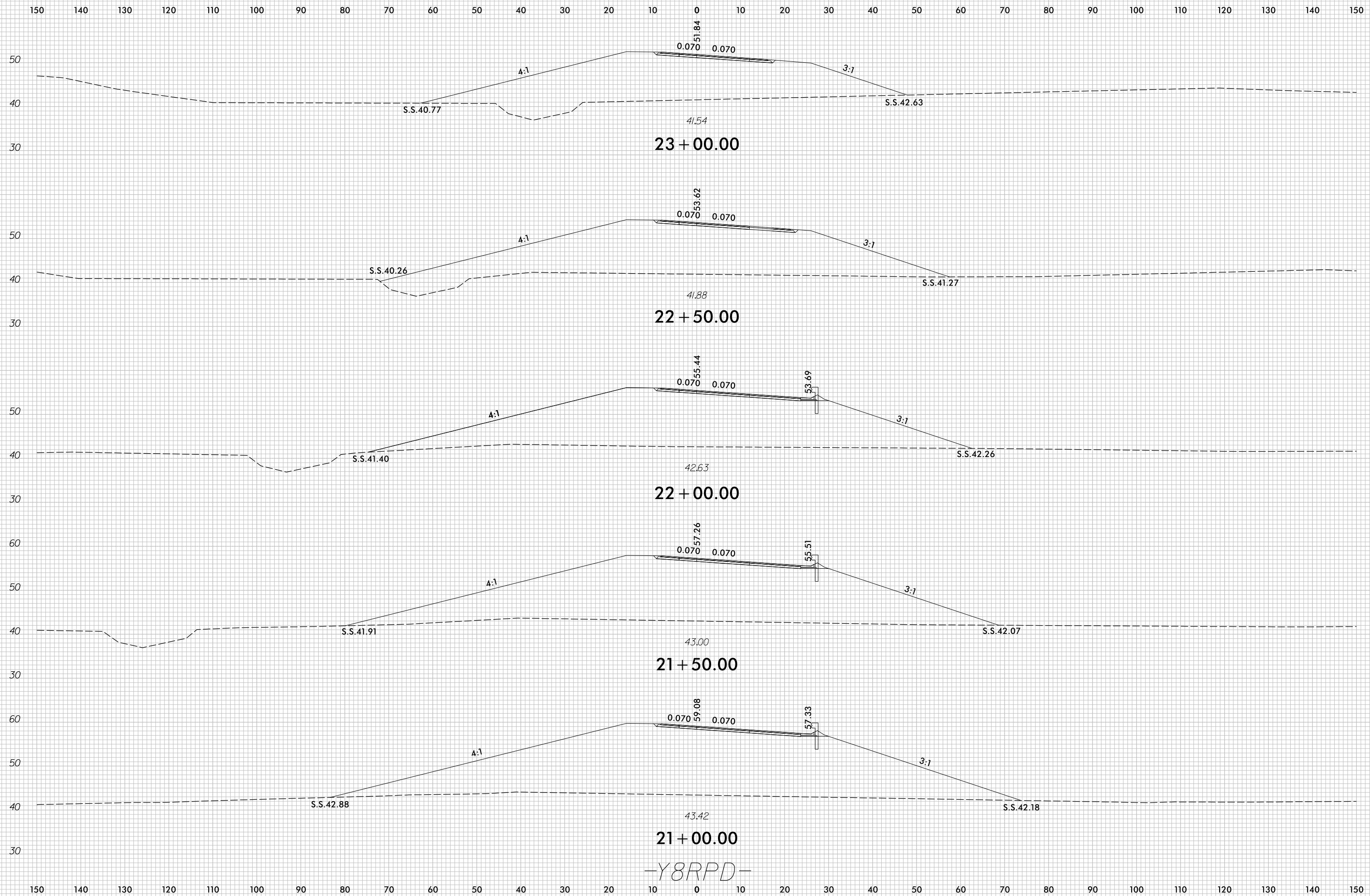

-Y8RPD-

7/5/2017
r:\Roadway\XSC\U4751_Rdu_XPL_Y8RPD.dgn
c:\proves

8/23/99

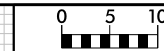

PROJ. REFERENCE NO.
U-4751

SHEET NO.
X-228

150 140 130 120 110 100 90 80 70 60 50 40 30 20 10 0 10 20 30 40 50 60 70 80 90 100 110 120 130 140 150

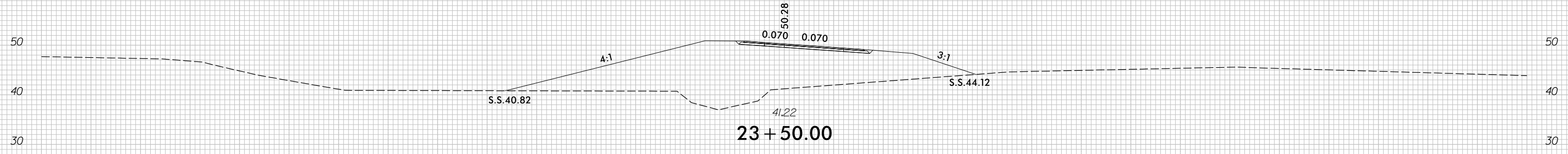
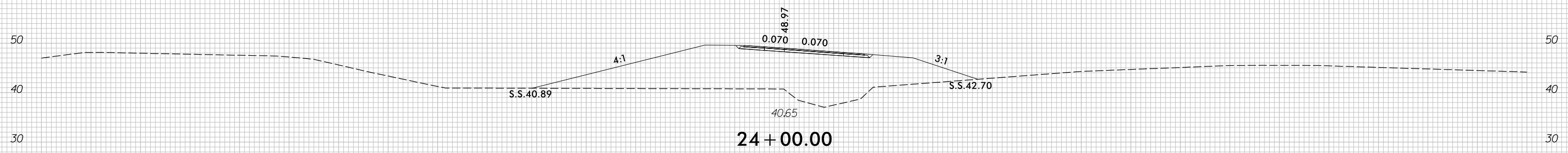
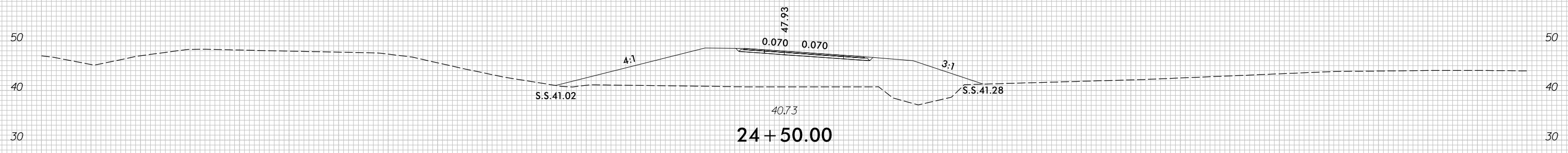
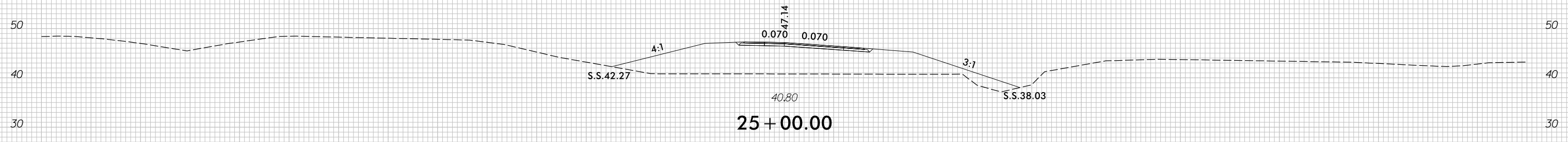
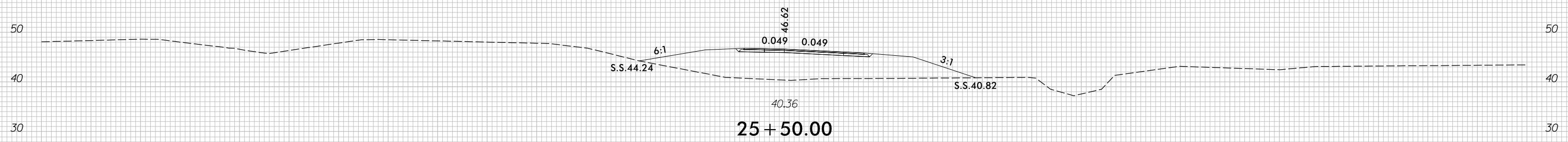

-Y8RPD-

7/5/2017
r:\Roadway\XSC\U4751_Rdy_XPL_Y8RPD.dgn
c:\proves

150 140 130 120 110 100 90 80 70 60 50 40 30 20 10 0 10 20 30 40 50 60 70 80 90 100 110 120 130 140 150

8/23/99



PROJ. REFERENCE NO.	SHEET NO.
U-4751	X-229

PROJ. REFERENCE NO.	SHEET NO.
U-4751	X-229

150 140 130 120 110 100 90 80 70 60 50 40 30 20 10 0 10 20 30 40 50 60 70 80 90 100 110 120 130 140 150

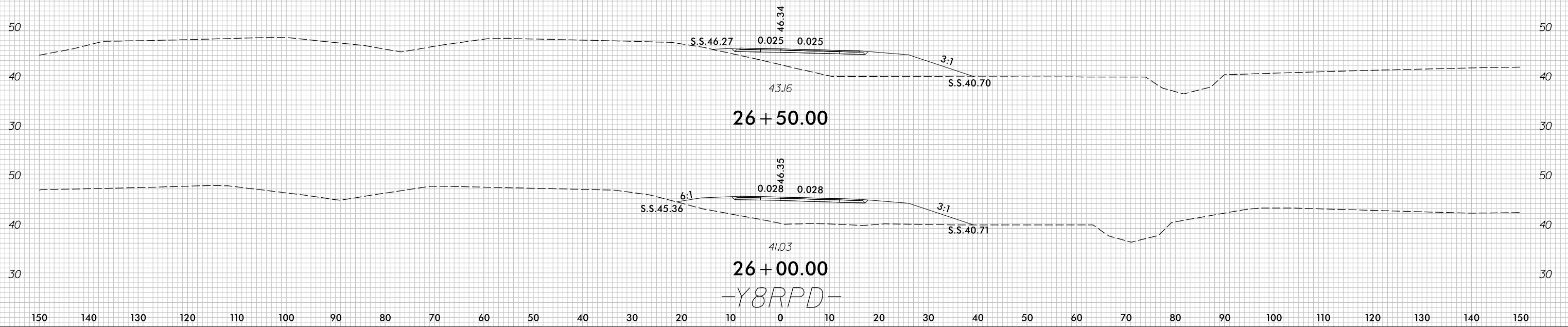

7/5/2017
 r:\Roadway\XSC\U4751_Rdu_XPL_Y8RPD.dgn
 c:\proves

8/23/99

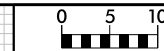

PROJ. REFERENCE NO.	SHEET NO.
U-4751	X-230

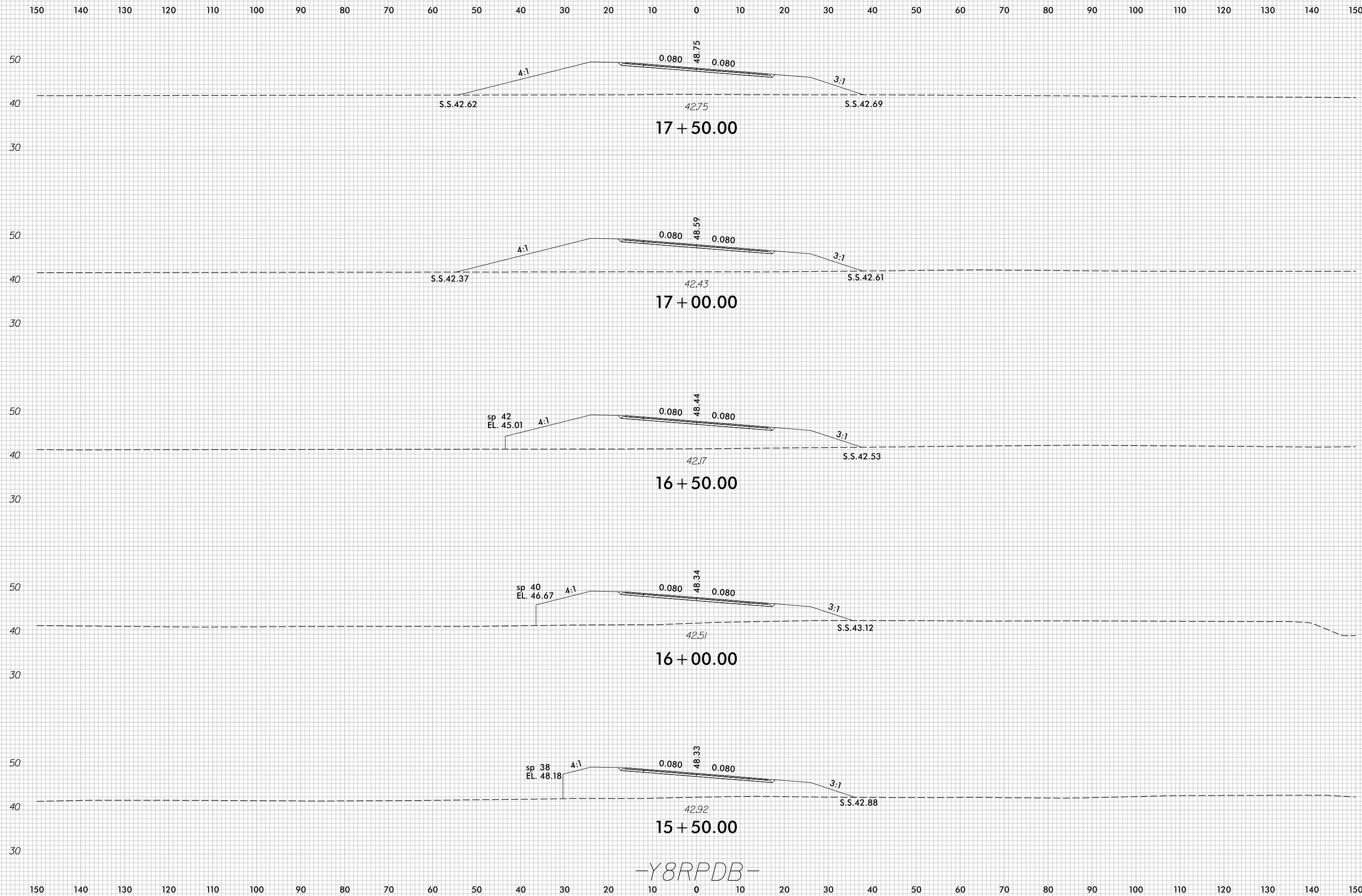

-Y8RPDB-

7/5/2017
r:\Roadway\XSC\U4751_Rdy_XPL_Y8RPDB.dgn
c:\proves

8/23/99

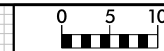

PROJ. REFERENCE NO.	SHEET NO.
U-4751	X-231

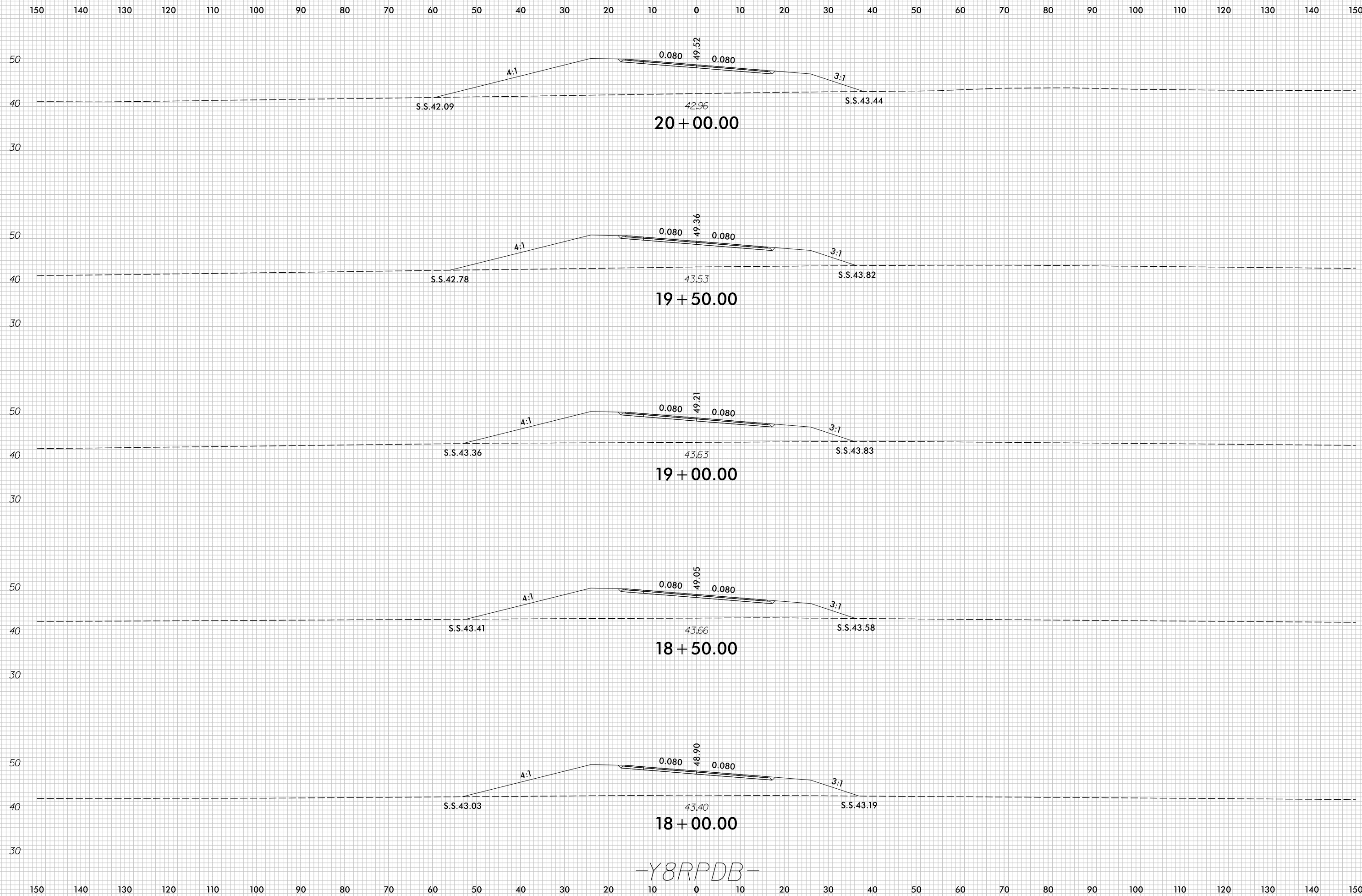

-Y8RPDB-

7/5/2017
r:\Roadway\XSC\U4751_Rdu_XPL_Y8RPDB.dgn
c:\proves

8/23/99



PROJ. REFERENCE NO.	SHEET NO.
U-4751	X-232

PROJ. REFERENCE NO.	SHEET NO.
U-4751	X-232

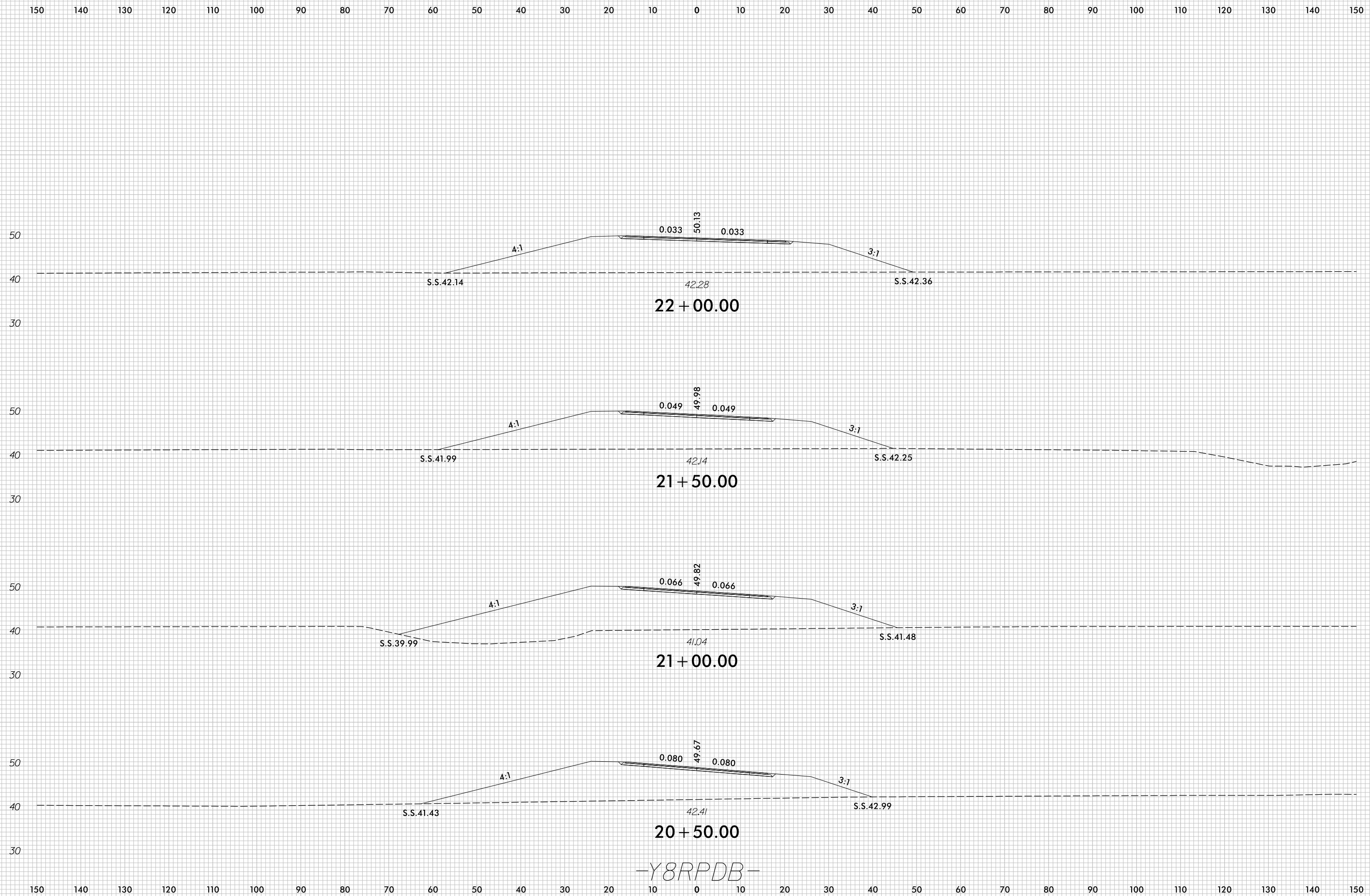

-Y8RPDB-

7/5/2017
 r:\Roadway\XSC\U4751_Rdu_XPL_Y8RPDB.dgn
 c:\proves

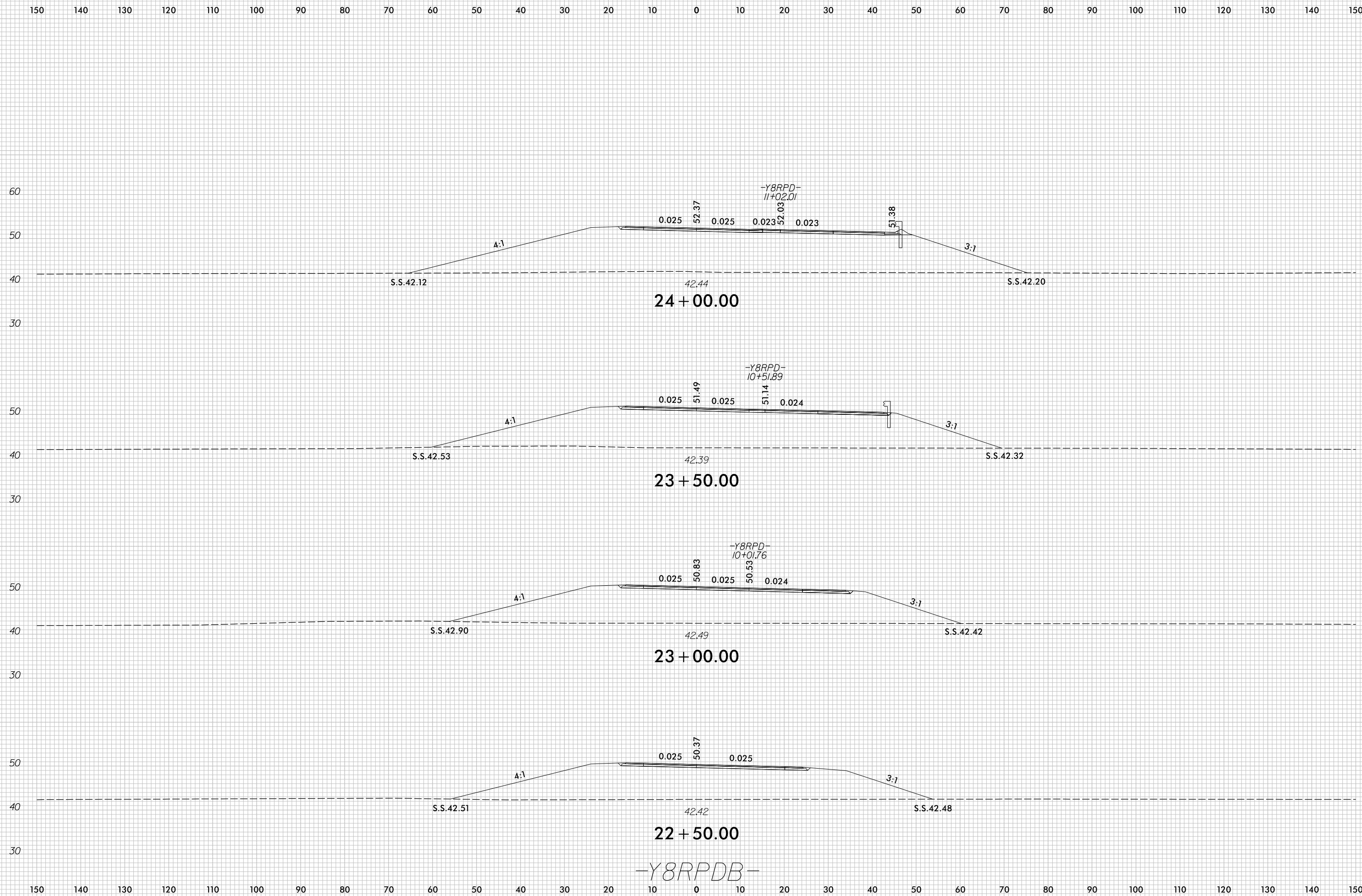

8/23/99

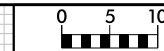

PROJ. REFERENCE NO.	SHEET NO.
U-4751	X-234

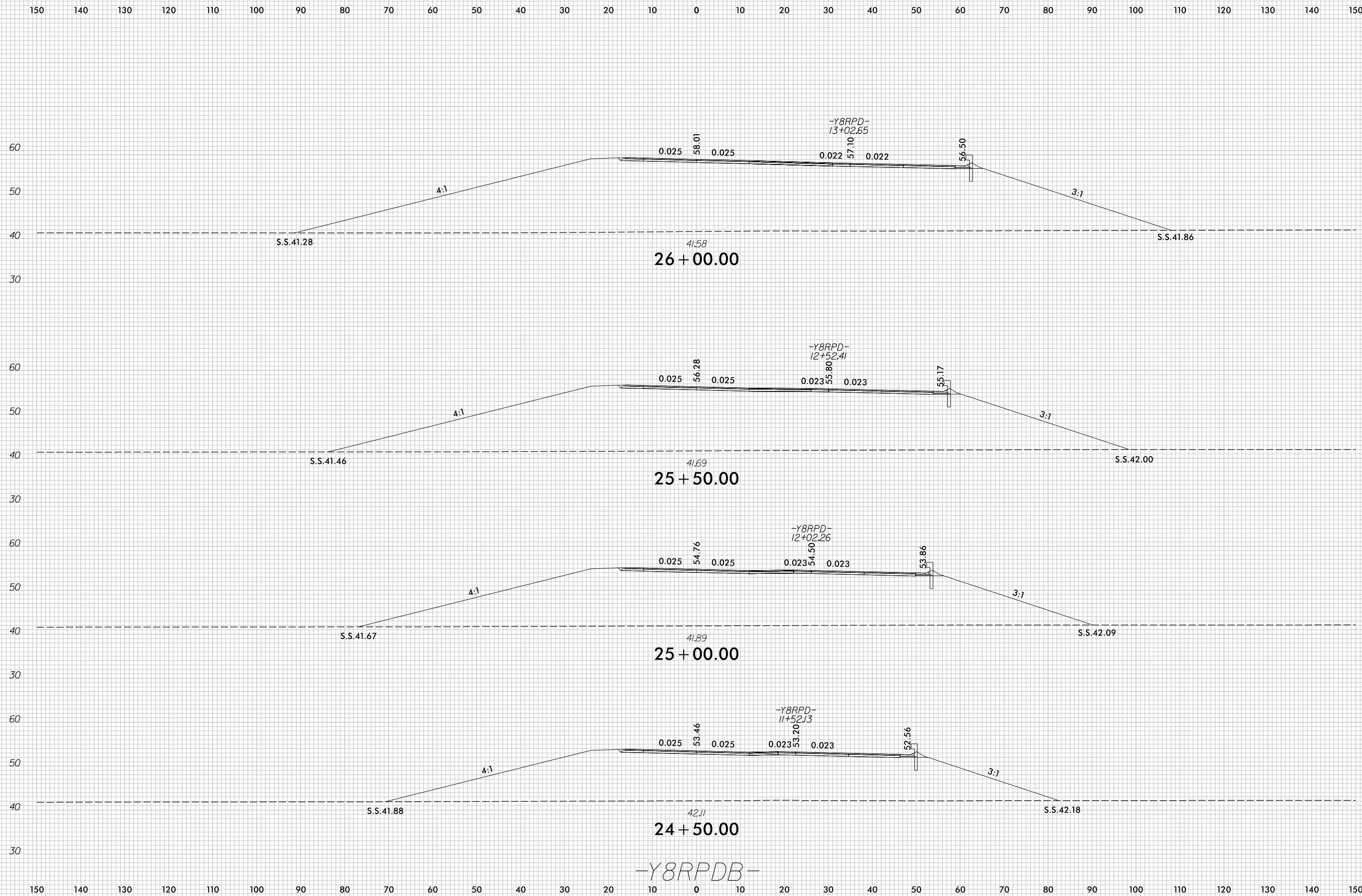

7/5/2017
r:\Roadway\XSC\U4751_Rdu_XPL_Y8RPDB.dgn
c:\proves

-Y8RPDB-

8/23/99

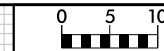

PROJ. REFERENCE NO.	SHEET NO.
U-4751	X-235

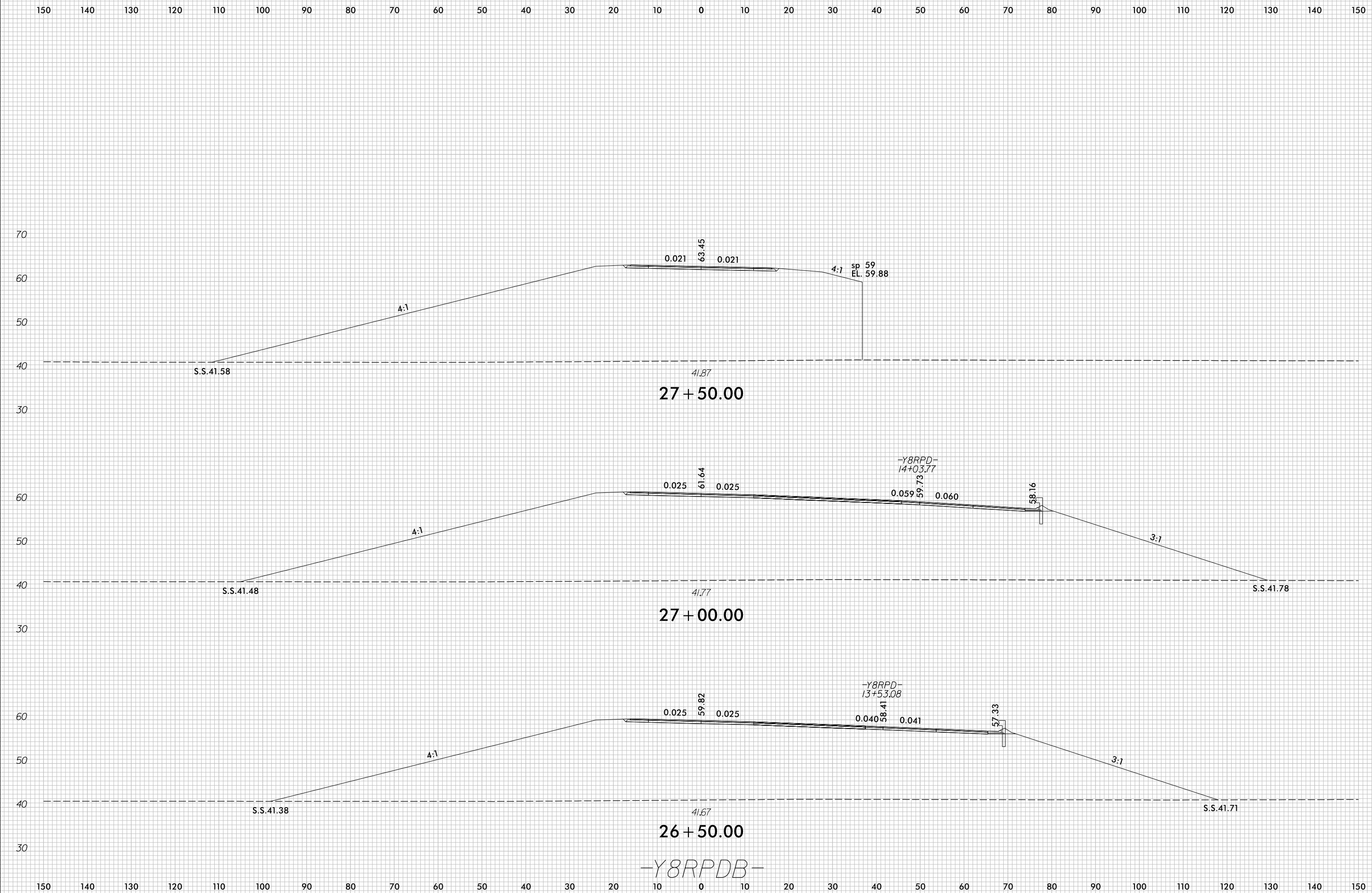

7/5/2017
r:\Roadway\XSC\U4751_Rdu_XPL_Y8RPDB.dgn
c:\proves

8/23/99

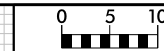

PROJ. REFERENCE NO.	SHEET NO.
U-4751	X-236

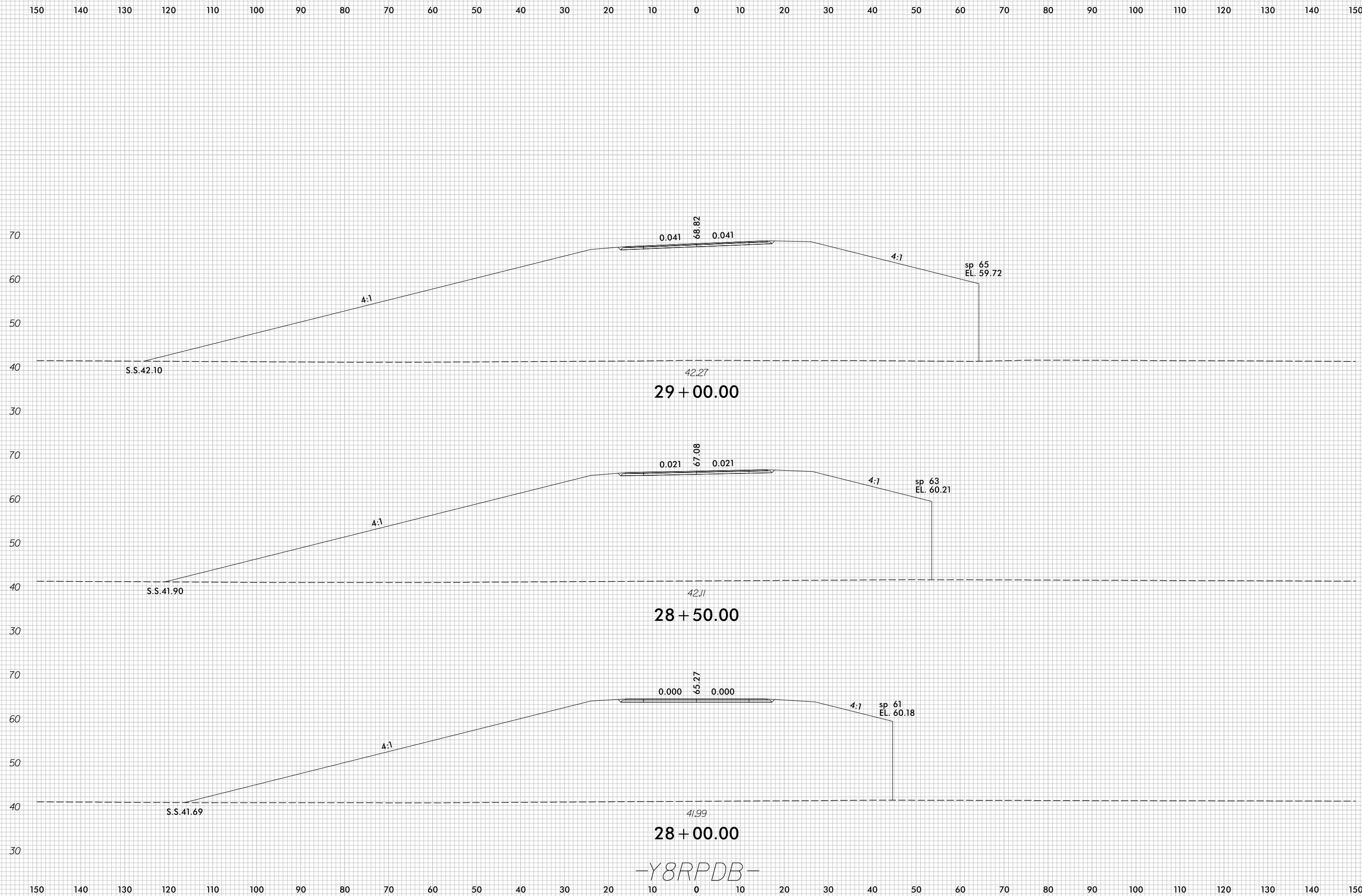

-Y8RPDB-

7/5/2017
r:\Roadway\XSC\U4751_Rdy_XPL_Y8RPDB.dgn
c:\proves

8/23/99

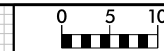

PROJ. REFERENCE NO.	SHEET NO.
U-4751	X-237

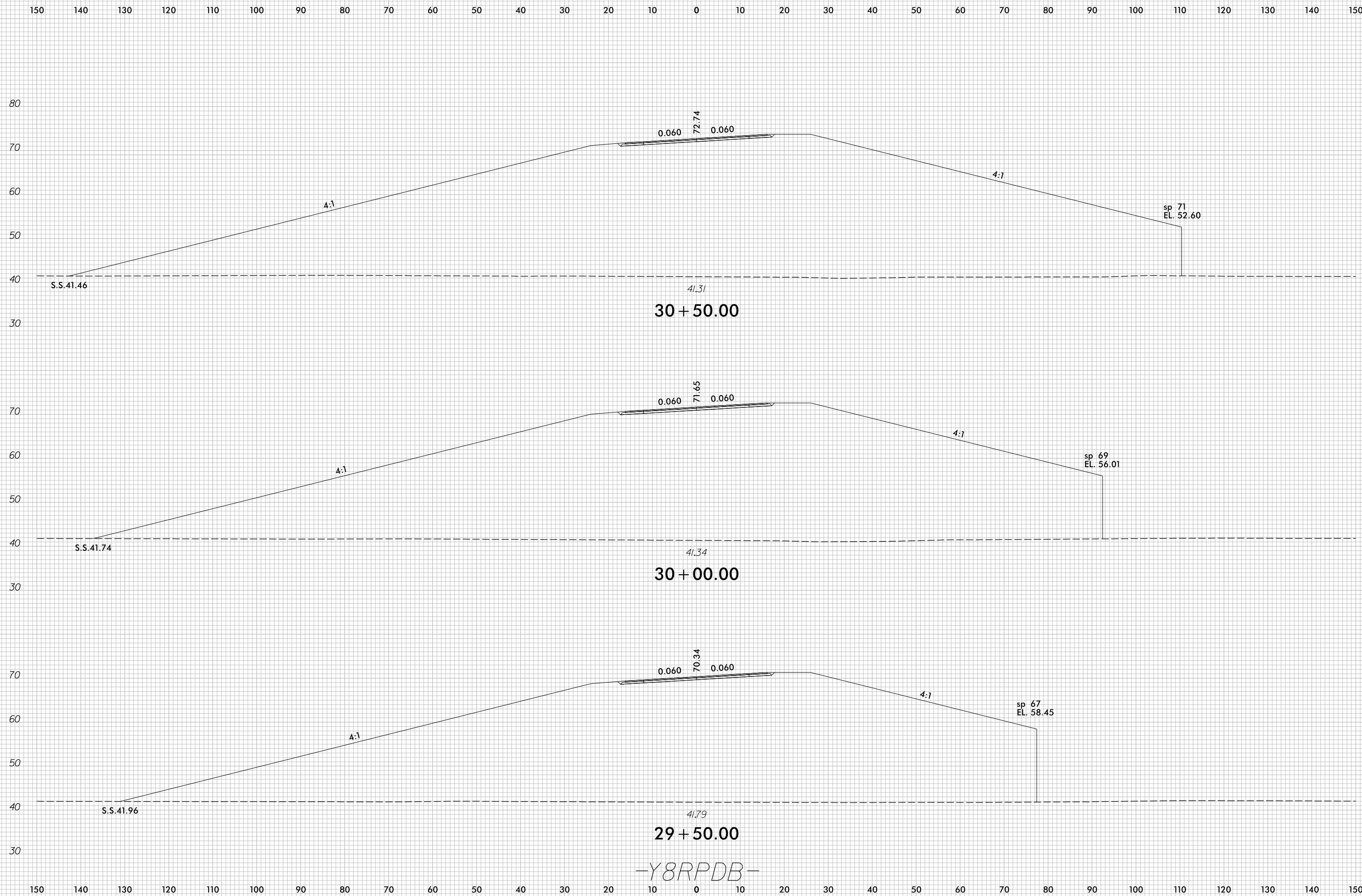

-Y8RPDB-

7/5/2017
r:\Roadway\XSC\U4751_Rdy_XPL_Y8RPDB.dgn
c:\proves

8/23/99



PROJ. REFERENCE NO.
U-4751

SHEET NO.
X-238

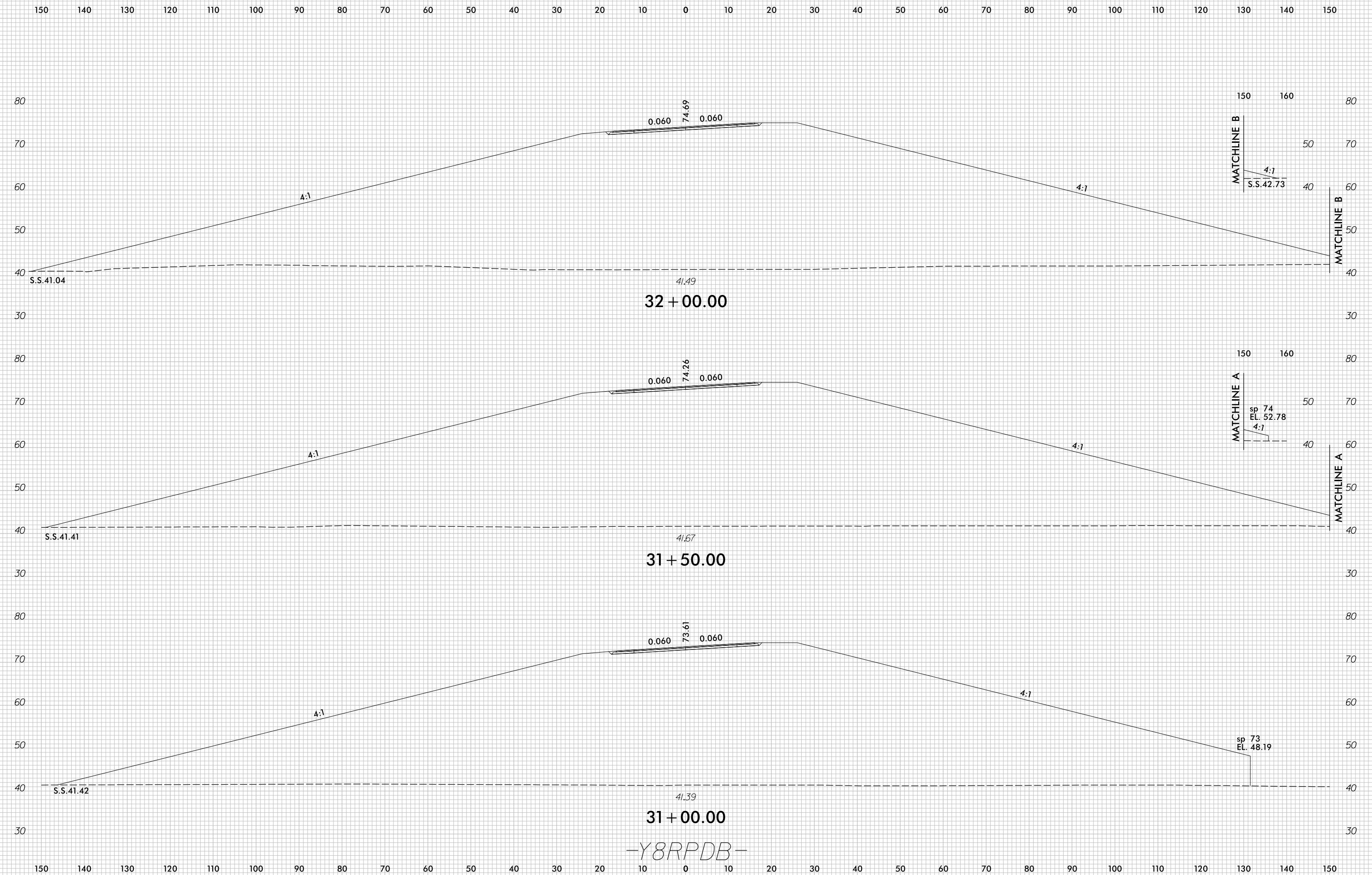

7/5/2017
r:\Roadway\XSC\U4751_Rdu_XPL_Y8RPDB.dgn
c:\proves

-Y8RPDB-

8/23/99

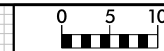

PROJ. REFERENCE NO.	SHEET NO.
U-4751	X-239

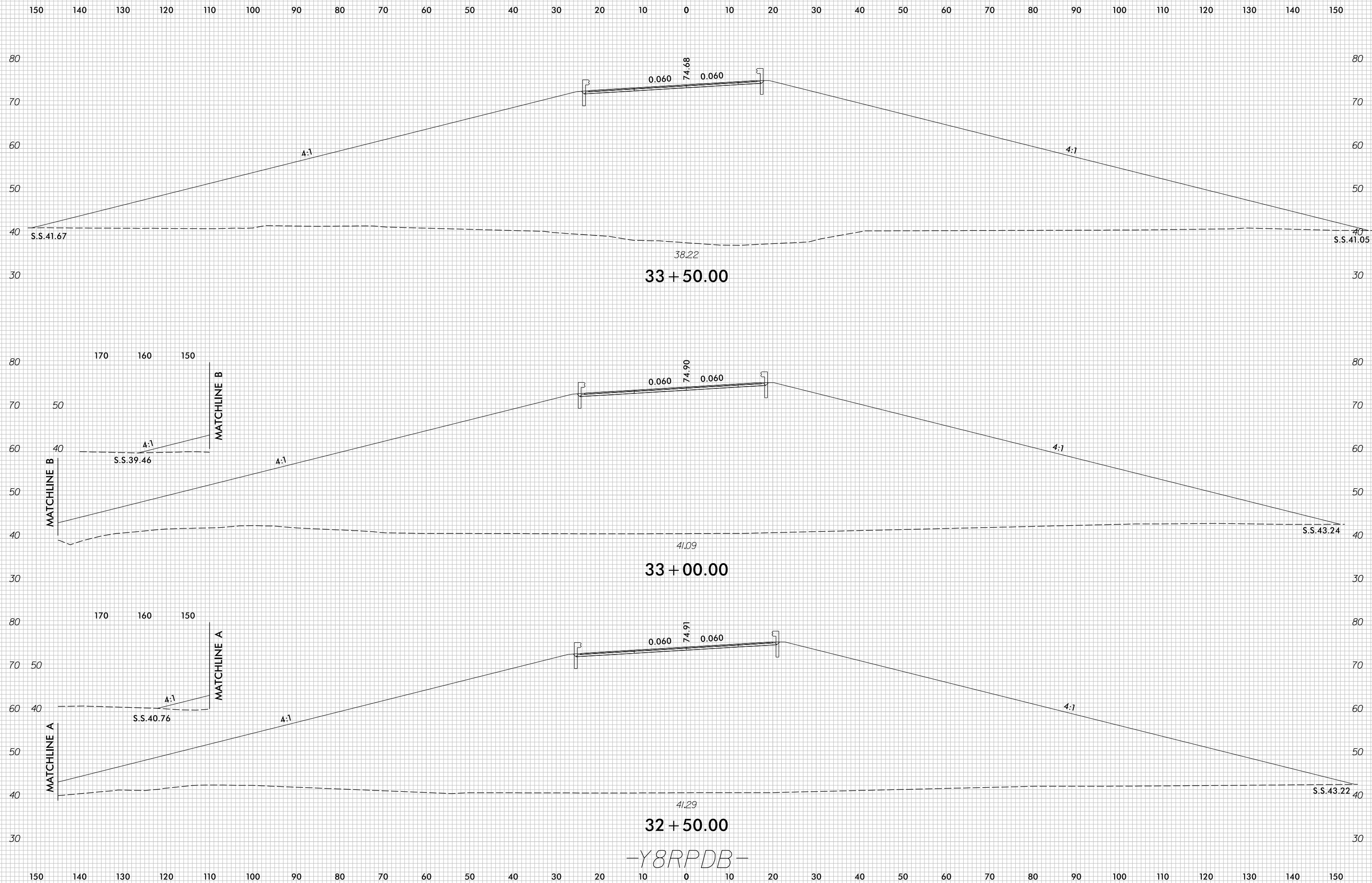

-Y8RPDB-

7/5/2017
r:\Roadway\XSC\U4751_Rdu_XPL_Y8RPDB.dgn
c:\proves

8/23/99

0 5 10	PROJ. REFERENCE NO.	SHEET NO.
	U-4751	X-240

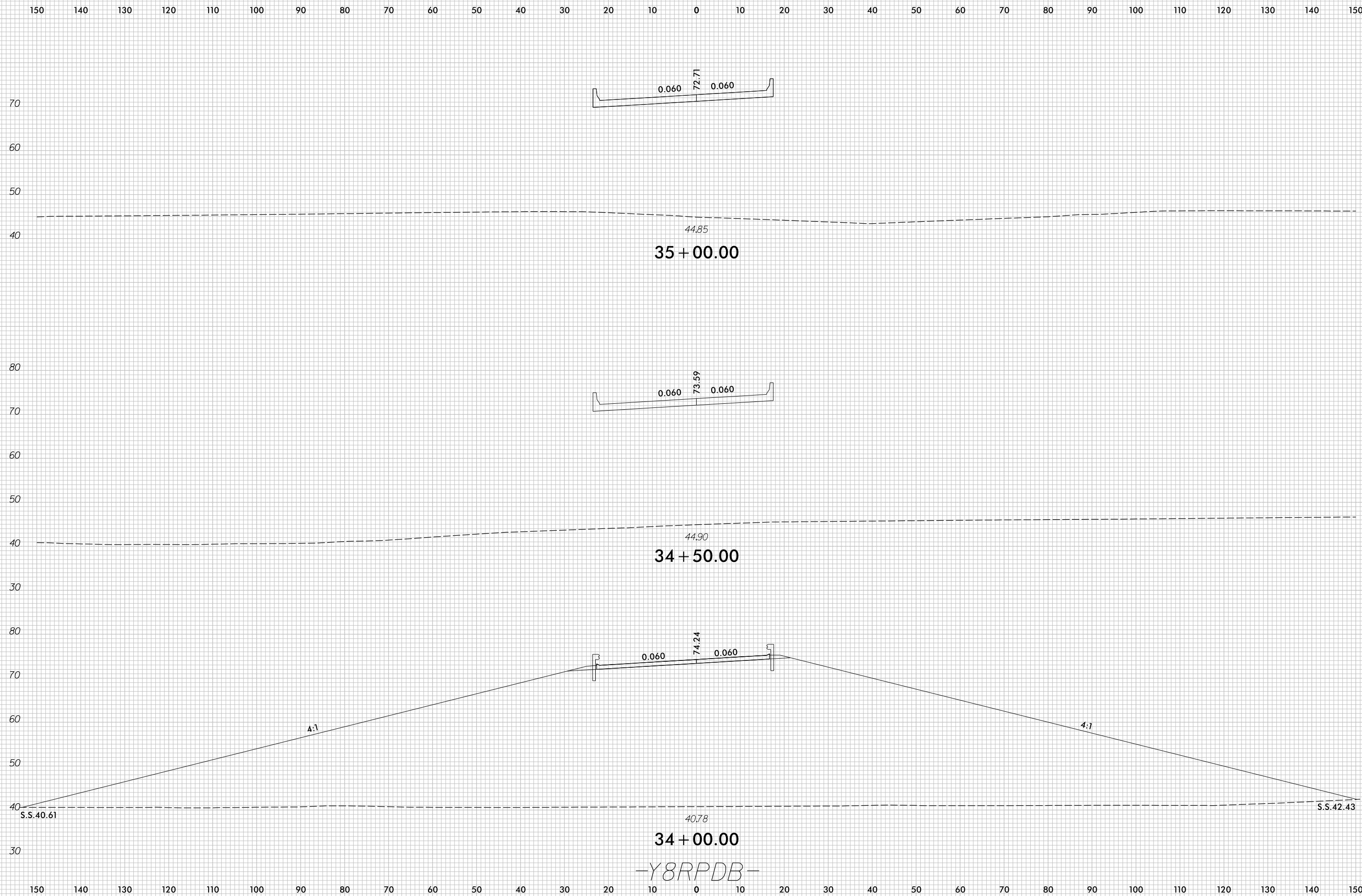

7/5/2017
r:\Roadway\XSC\U4751_Rdu_XPL_Y8RPDB.dgn
c:\proves

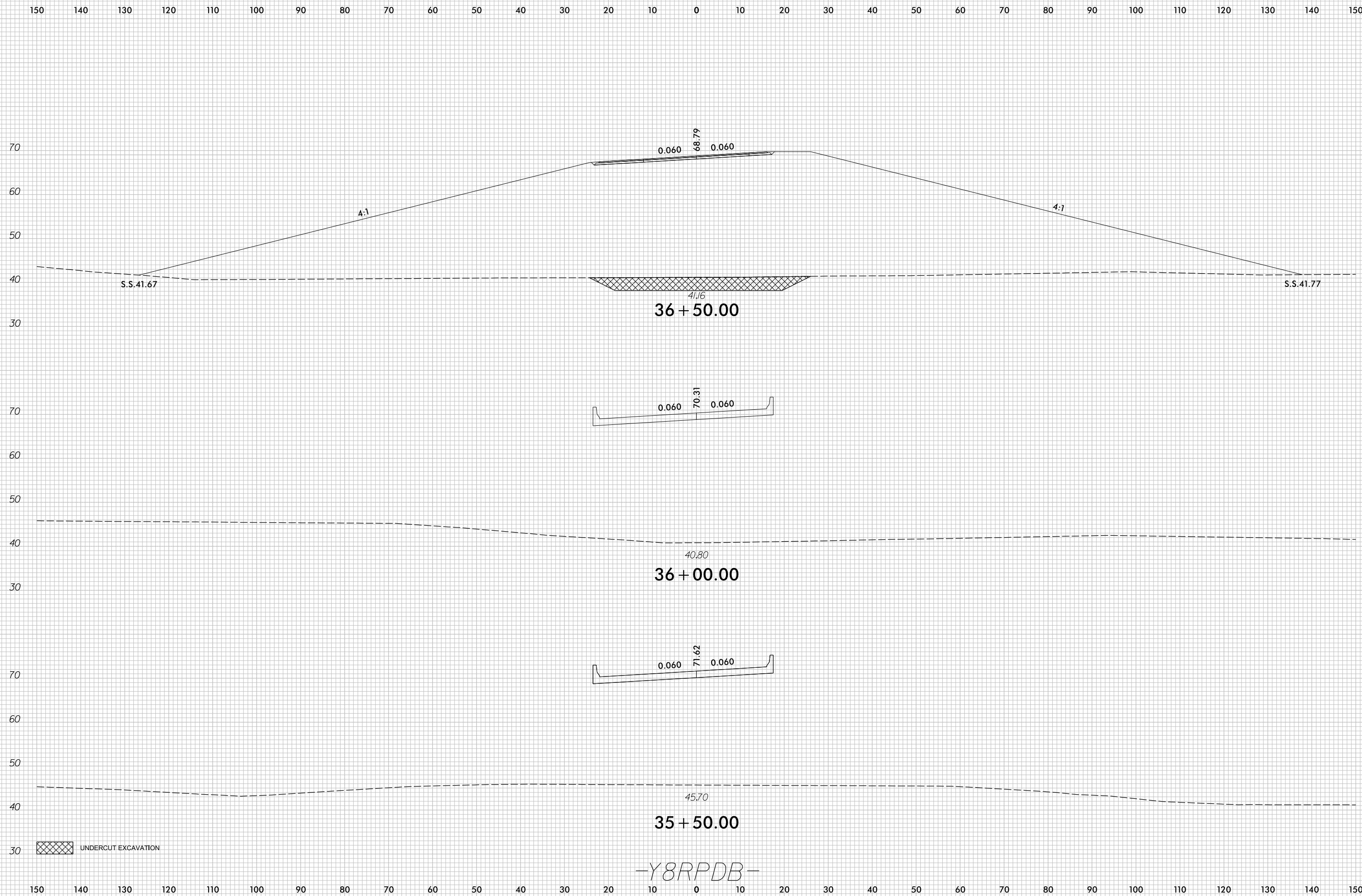

8/23/99

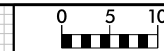

PROJ. REFERENCE NO.	SHEET NO.
U-4751	X-242

PROJ. REFERENCE NO.	SHEET NO.
U-4751	X-242

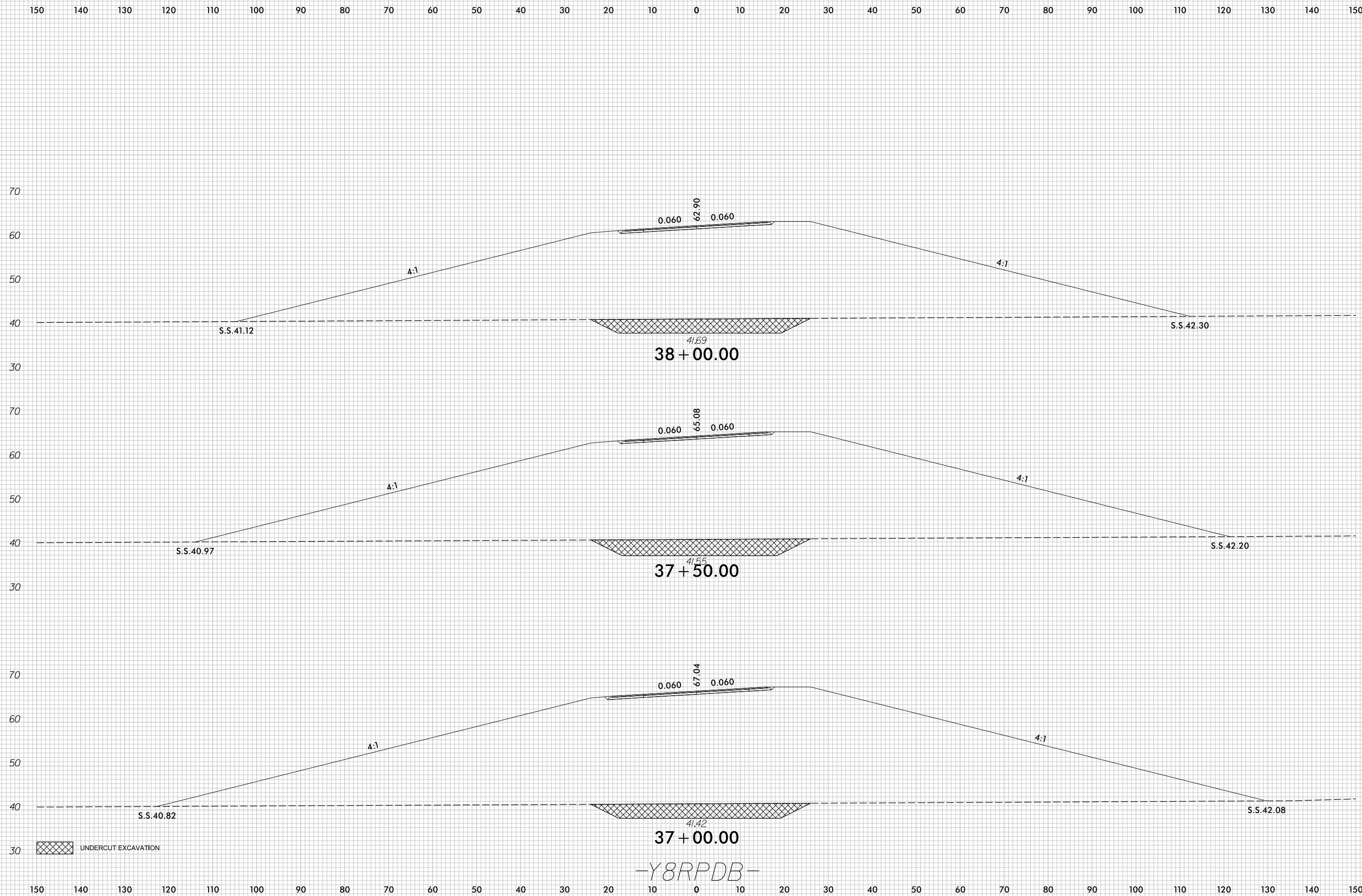

UNDERCUT EXCAVATION

-Y8RPDB-

7/5/2017
r:\Roadway\XSC\U4751_Rdu_XPL_Y8RPDB.dgn
c:\proves

8/23/99

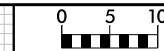

PROJ. REFERENCE NO.	SHEET NO.
U-4751	X-243

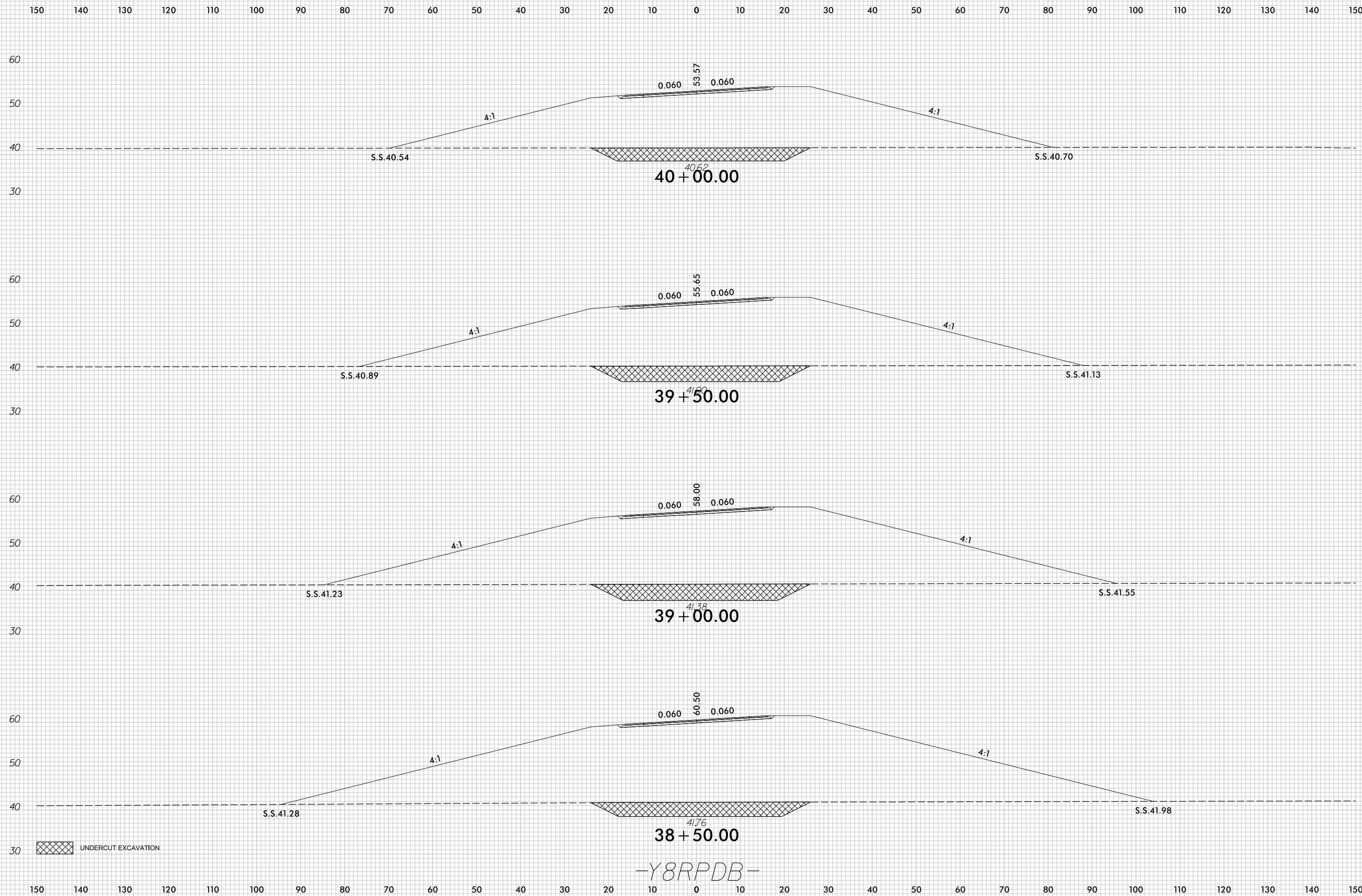

UNDERCUT EXCAVATION

-Y8RPDB-

7/5/2017
r:\Roadway\XSC\U4751_Rdu_XPL_Y8RPDB.dgn
c:\proves

8/23/99



PROJ. REFERENCE NO.	SHEET NO.
U-4751	X-244

PROJ. REFERENCE NO.	SHEET NO.
U-4751	X-244

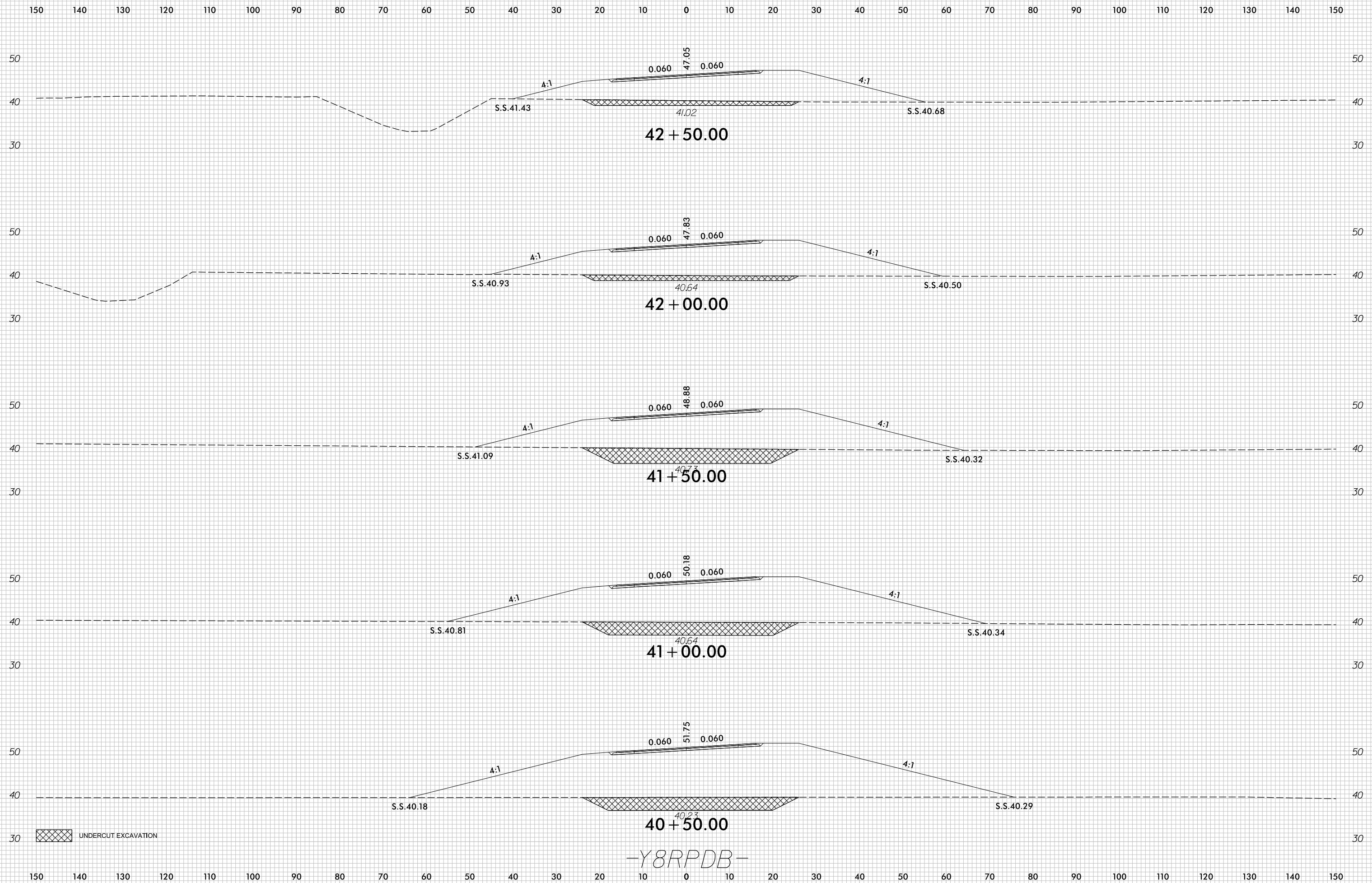

UNDERCUT EXCAVATION

-Y8RPDB-

7/5/2017
r:\Roadway\XSC\U4751_Rdu_XPL_Y8RPDB.dgn
c:\proves

8/23/99

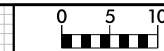

PROJ. REFERENCE NO.	SHEET NO.
U-4751	X-245

150 140 130 120 110 100 90 80 70 60 50 40 30 20 10 0 10 20 30 40 50 60 70 80 90 100 110 120 130 140 150

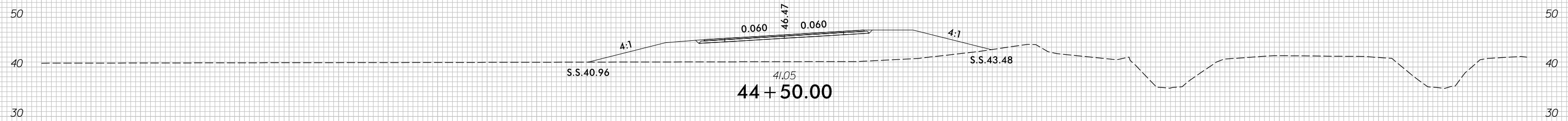

44 + 50.00

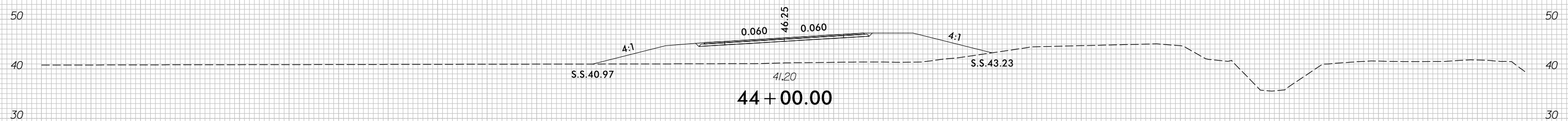

44 + 00.00

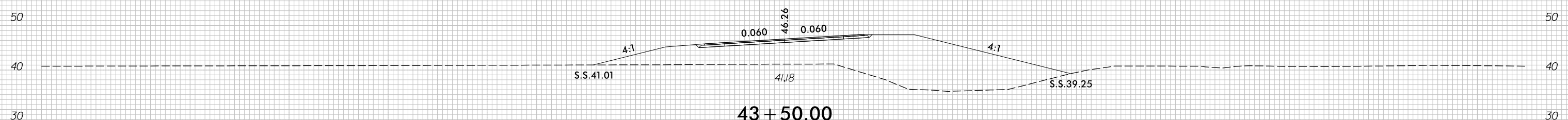

43 + 50.00

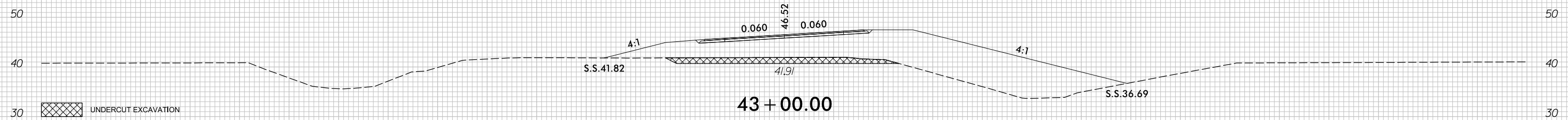

43 + 00.00

-Y8RPDB-

UNDERCUT EXCAVATION

7/5/2017
r:\Roadway\XSC\U4751_Rdu_XPL_Y8RPDB.dgn
c:\proves

150 140 130 120 110 100 90 80 70 60 50 40 30 20 10 0 10 20 30 40 50 60 70 80 90 100 110 120 130 140 150

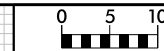

150 140 130 120 110 100 90 80 70 60 50 40 30 20 10 0 10 20 30 40 50 60 70 80 90 100 110 120 130 140 150

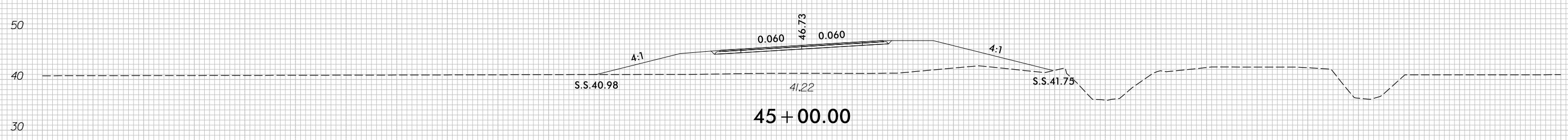
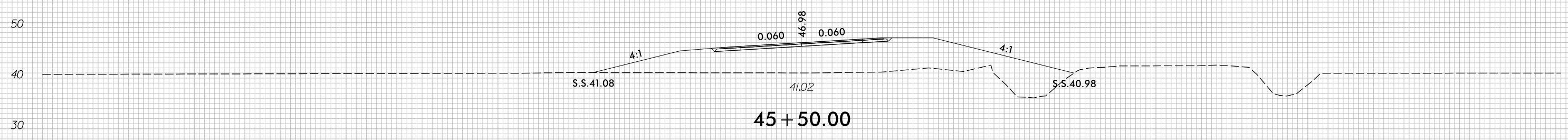
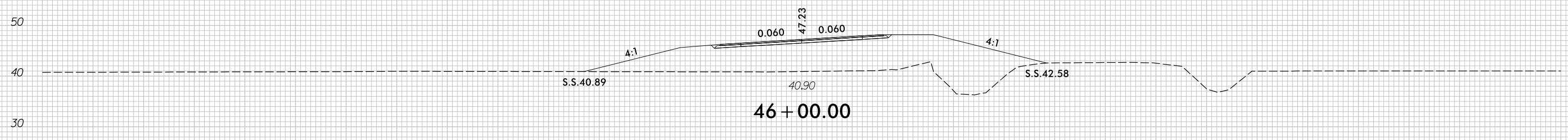
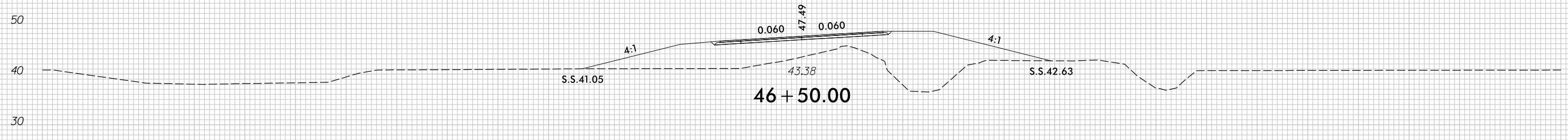
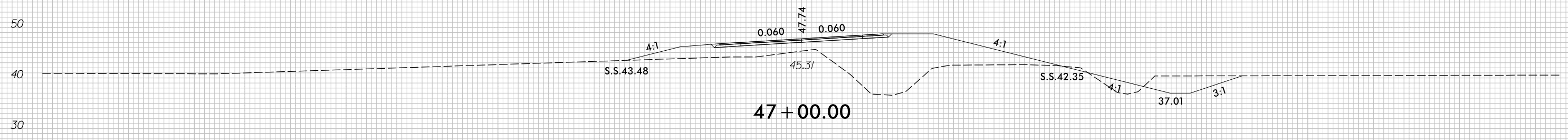

150 140 130 120 110 100 90 80 70 60 50 40 30 20 10 0 10 20 30 40 50 60 70 80 90 100 110 120 130 140 150

-Y8RPDB-

8/23/99

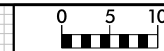

PROJ. REFERENCE NO.	SHEET NO.
U-4751	X-247

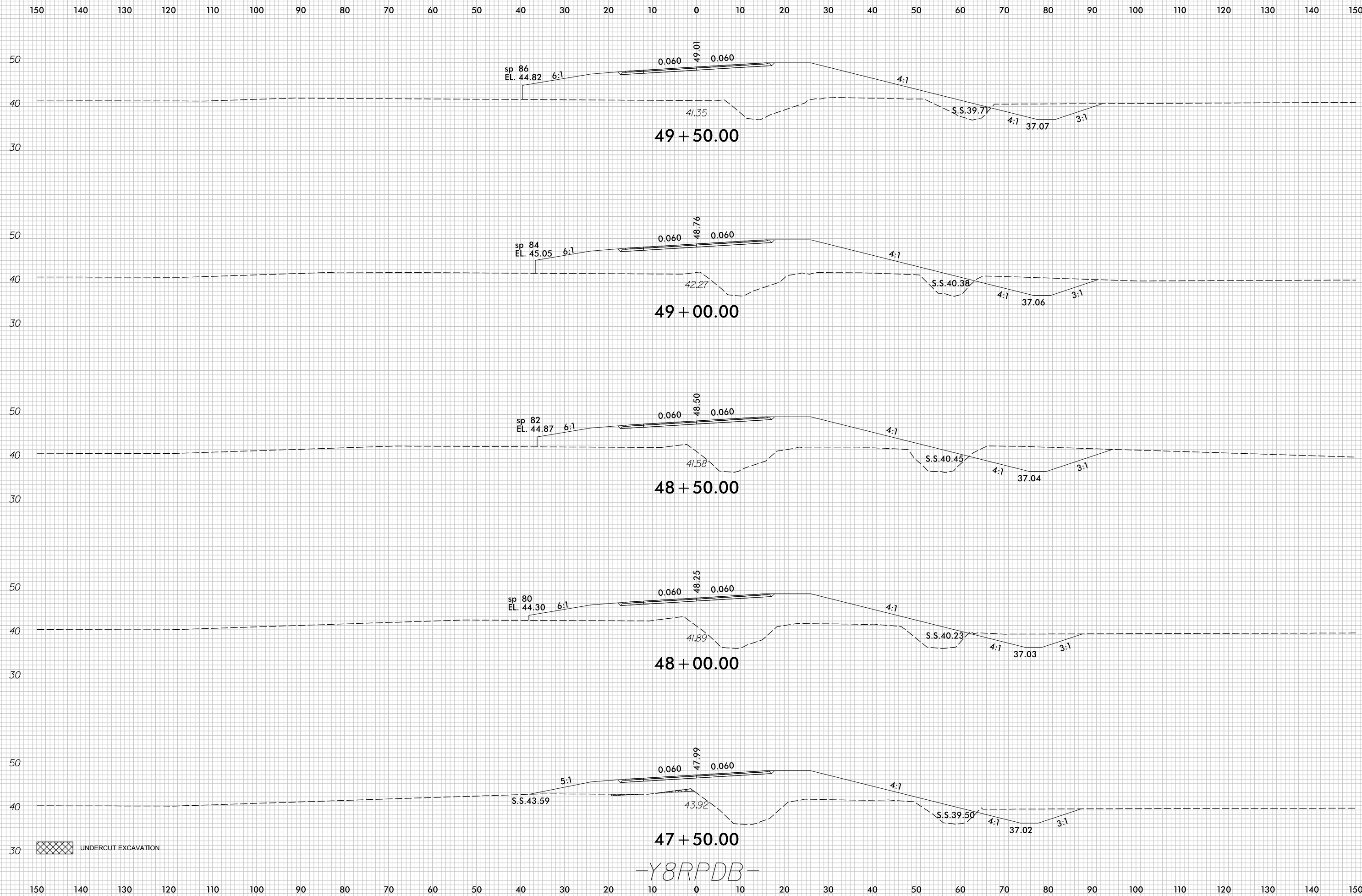

7/5/2017
r:\Roadway\XSC\U4751_Rdy_XPL_Y8RPDB.dgn
c:\proves

-Y8RPDB-

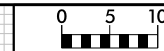

150 140 130 120 110 100 90 80 70 60 50 40 30 20 10 0 10 20 30 40 50 60 70 80 90 100 110 120 130 140 150

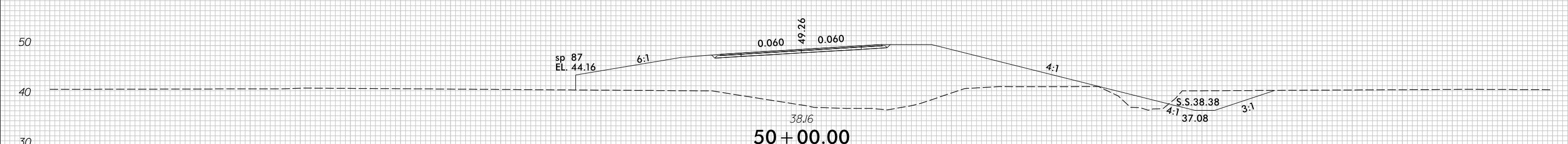
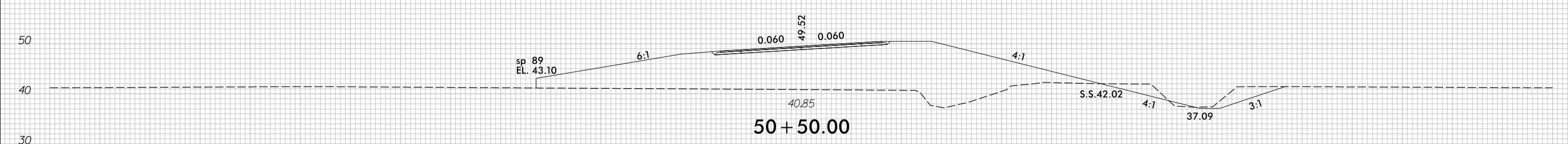
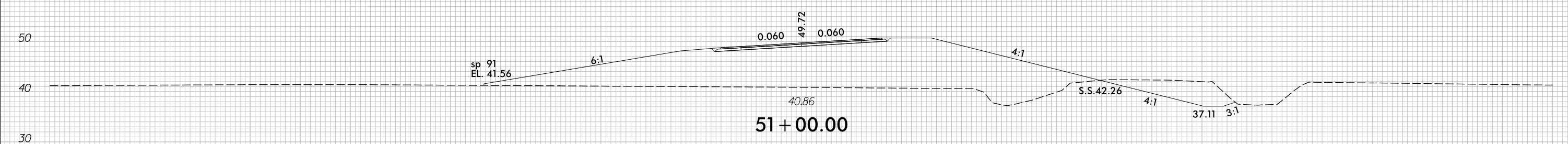
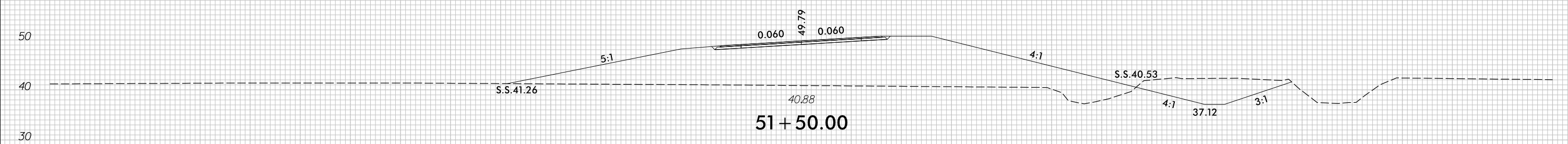

150 140 130 120 110 100 90 80 70 60 50 40 30 20 10 0 10 20 30 40 50 60 70 80 90 100 110 120 130 140 150

50+00.00
-Y8RPDB-

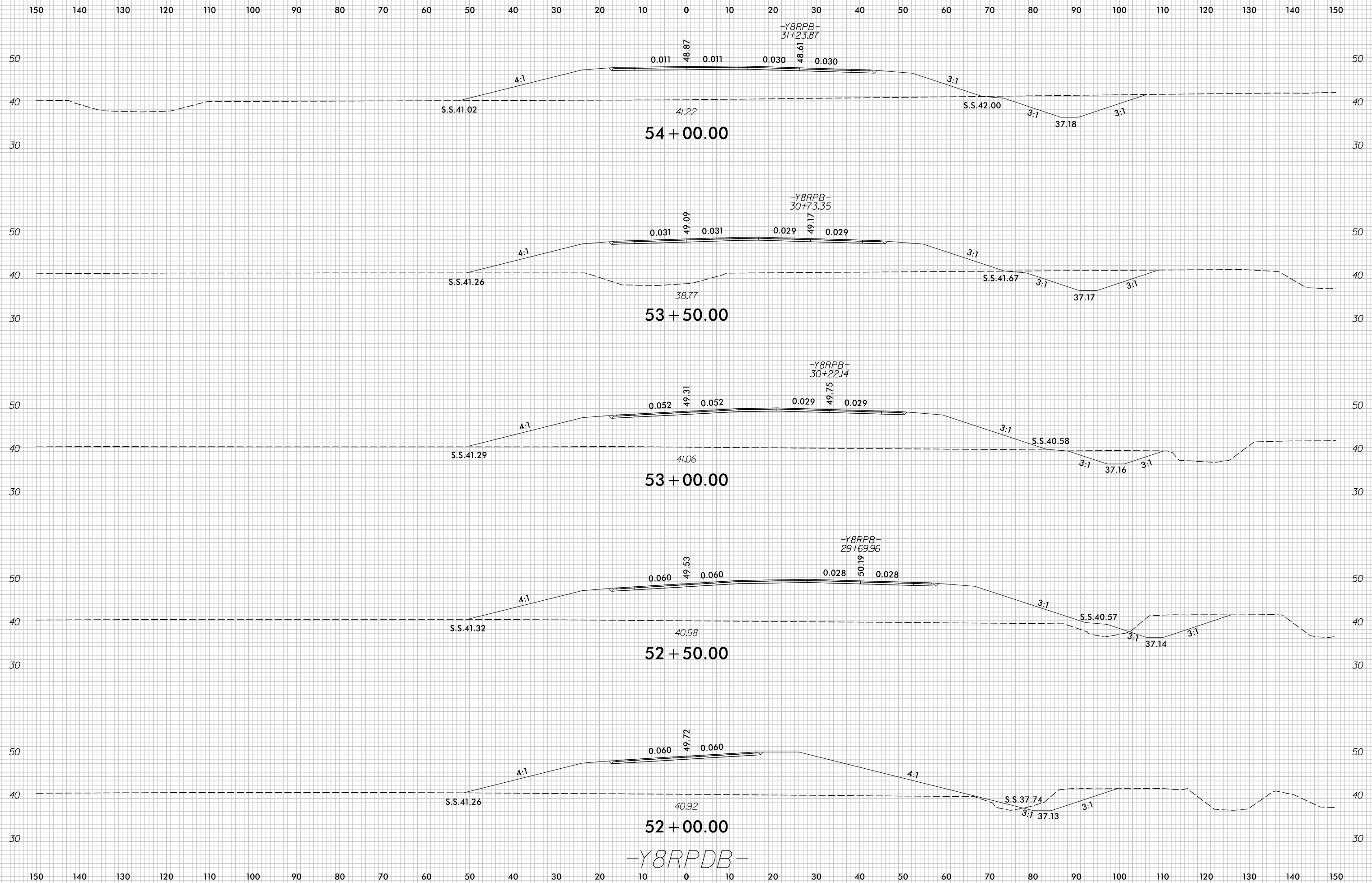

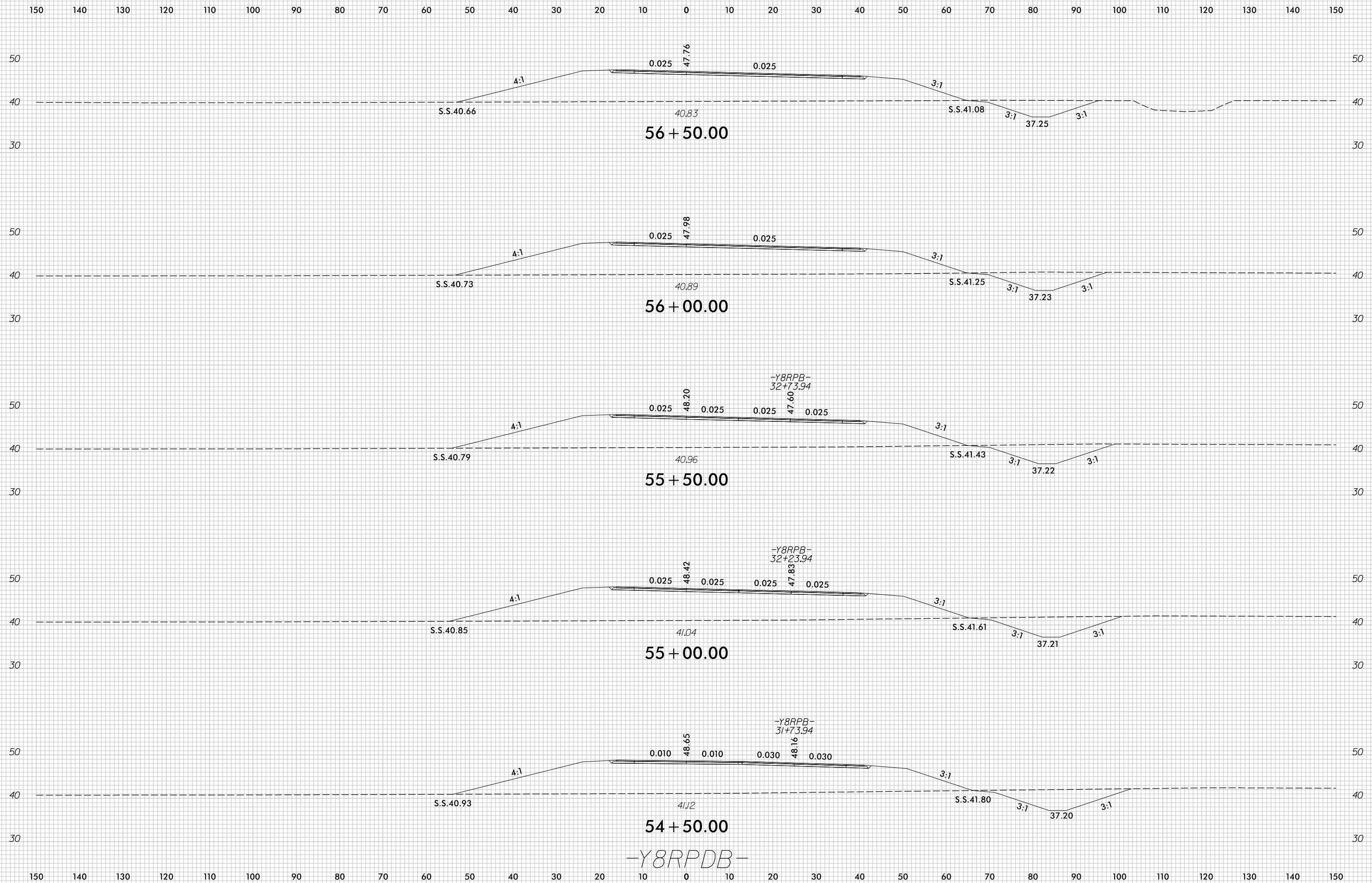

8/23/99

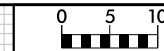

PROJ. REFERENCE NO.	SHEET NO.
U-4751	X-251

150 140 130 120 110 100 90 80 70 60 50 40 30 20 10 0 10 20 30 40 50 60 70 80 90 100 110 120 130 140 150

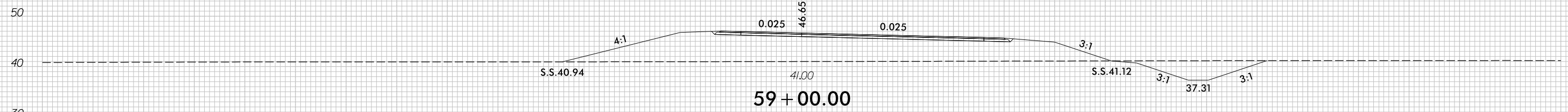

59 + 00.00

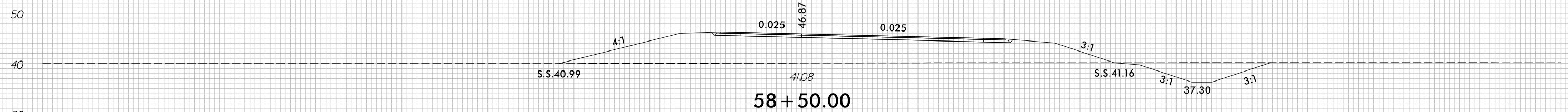

58 + 50.00

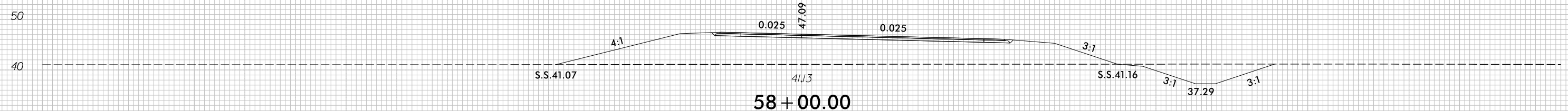

58 + 00.00

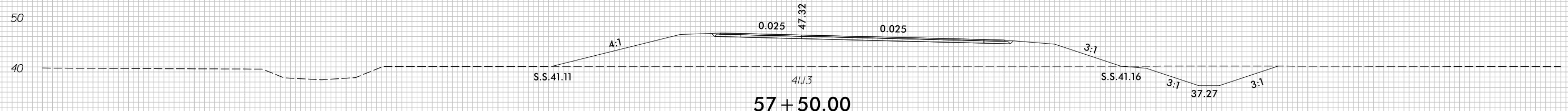

57 + 50.00

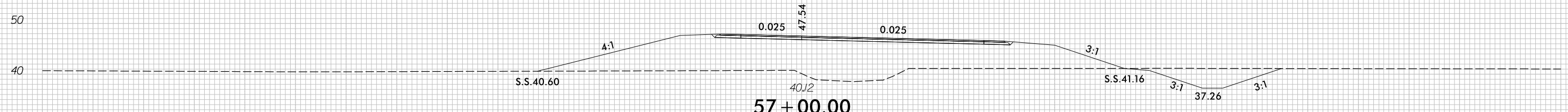

57 + 00.00

-Y8RPDB-

150 140 130 120 110 100 90 80 70 60 50 40 30 20 10 0 10 20 30 40 50 60 70 80 90 100 110 120 130 140 150

7/5/2017
r:\Roadway\XSC\U4751_Rdu_XPL_Y8RPDB.dgn
c:\proves