

**This electronic collection of documents is provided  
for the convenience of the user  
and is Not a Certified Document –**

**The documents contained herein were originally issued  
and sealed by the individuals whose names and license  
numbers appear on each page, on the dates appearing  
with their signature on that page.**

**This file or an individual page  
shall not be considered a certified document.**

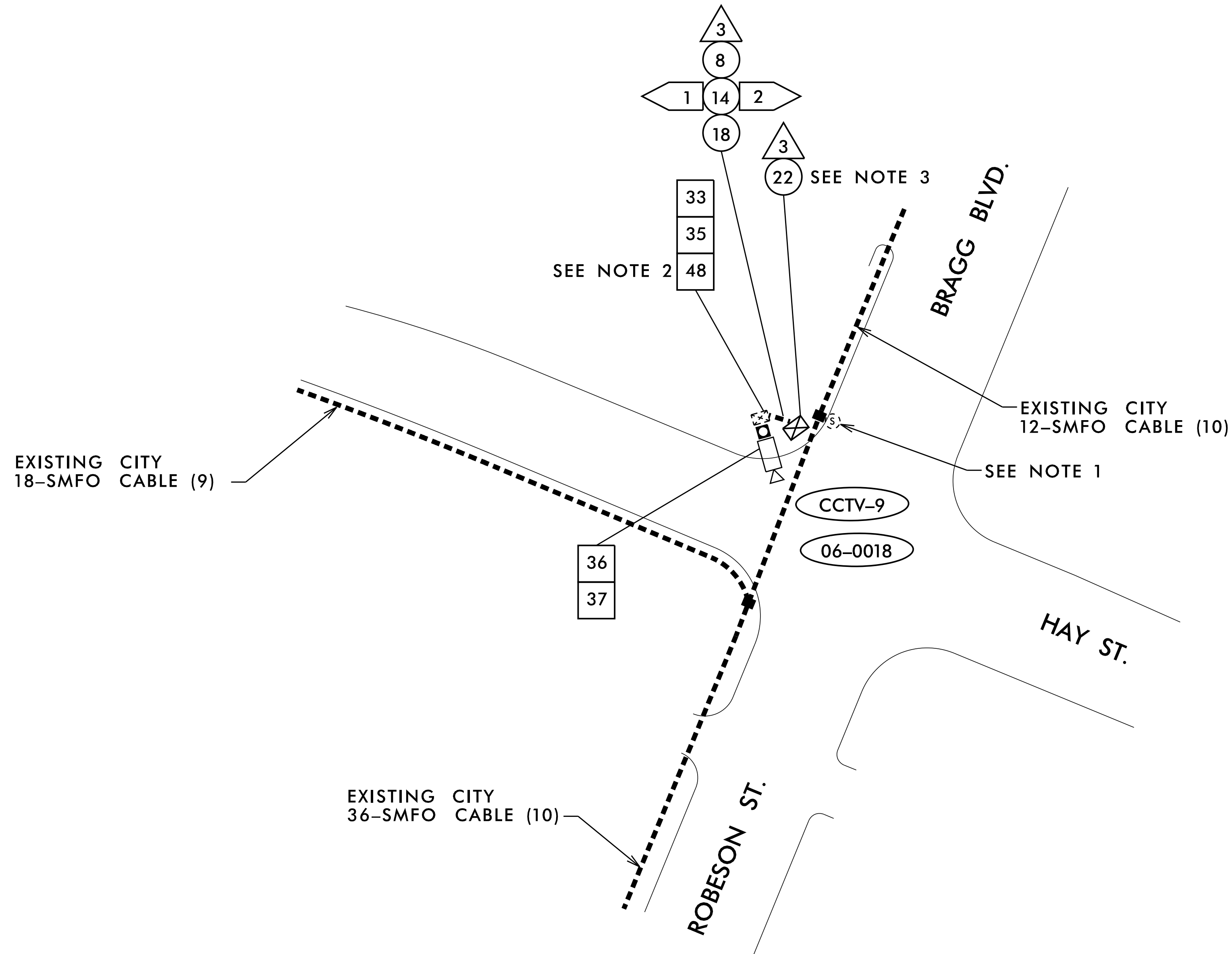

**NOTES:**

1. MODIFY EXISTING CCTV SPLICE ENCLOSURE PER SPLICE DETAILS.
2. REMOVE EXISTING DROP CABLE FROM CCTV CABINET AND REMOVE FROM EXISTING CONDUIT AND/OR MESSENGER CABLE BACK TO EXISTING SPLICE ENCLOSURE.
3. SEE SUMMARY OF WORK TABLES FOR ADDITIONAL CABINET AND COMMUNICATIONS WORK TO BE PERFORMED.
4. THIS AREA HAS BEEN DETERMINED TO CONTAIN PROPERTIES WITH DOCUMENTED HISTORIC SIGNIFICANCE. IF IT IS NECESSARY TO DEVIATE FROM THESE PLANS IN THIS AREA, PLEASE ALERT THE ENGINEER TO CONTACT PROJECT DEVELOPMENT AND ENVIRONMENTAL ANALYSIS BRANCH - HISTORIC ARCHITECTURE GROUP OF THE NORTH CAROLINA DEPARTMENT OF TRANSPORTATION FOR AN EFFECT DETERMINATION BEFORE PROCEEDING.

11/15/2016 KARAL\_TPTD\_ITS\_01036305 - Fayetteville\_Sig\_Sys\Plans\01036305\_ITS\_psh\_r26-CCTV09.dgn

**Kimley»Horn**  
 NC License #F-0102  
 421 Fayetteville St., Suite 600  
 Raleigh, NC 27636  
 Tel: (919) 677-2000  
 Fax: (919) 677-2050

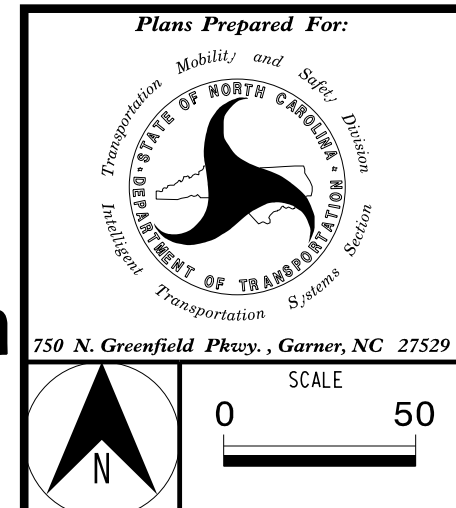

|                              |               |   |             |
|------------------------------|---------------|---|-------------|
| Plans Prepared For:          |               | FAYETTEVILLE COMPUTERIZED SIGNAL SYSTEM |             |
| EXISTING CCTV 9 INSTALLATION |               | SEAL                                    |             |
| DIVISION 06                  |               | CUMBERLAND COUNTY                       |             |
| PLAN DATE:                   | NOVEMBER 2016 | REVIEWED BY:                            | K. NICHOLAS |
| PREPARED BY:                 | J. CROSS      | REVIEWED BY:                            | K. SMITH    |
| REVISIONS                    | INIT.         | DATE                                    |             |
|                              |               |   |             |
|                              |               |   |             |
|                              |               |   |             |
|                              |               |   |             |

|                                  |            |
|----------------------------------|------------|
| DocuSigned by:<br>Kevin W. Smith | 11/15/2016 |
| SIGNATURE                        | DATE       |
| CADD Filename:                   |            |

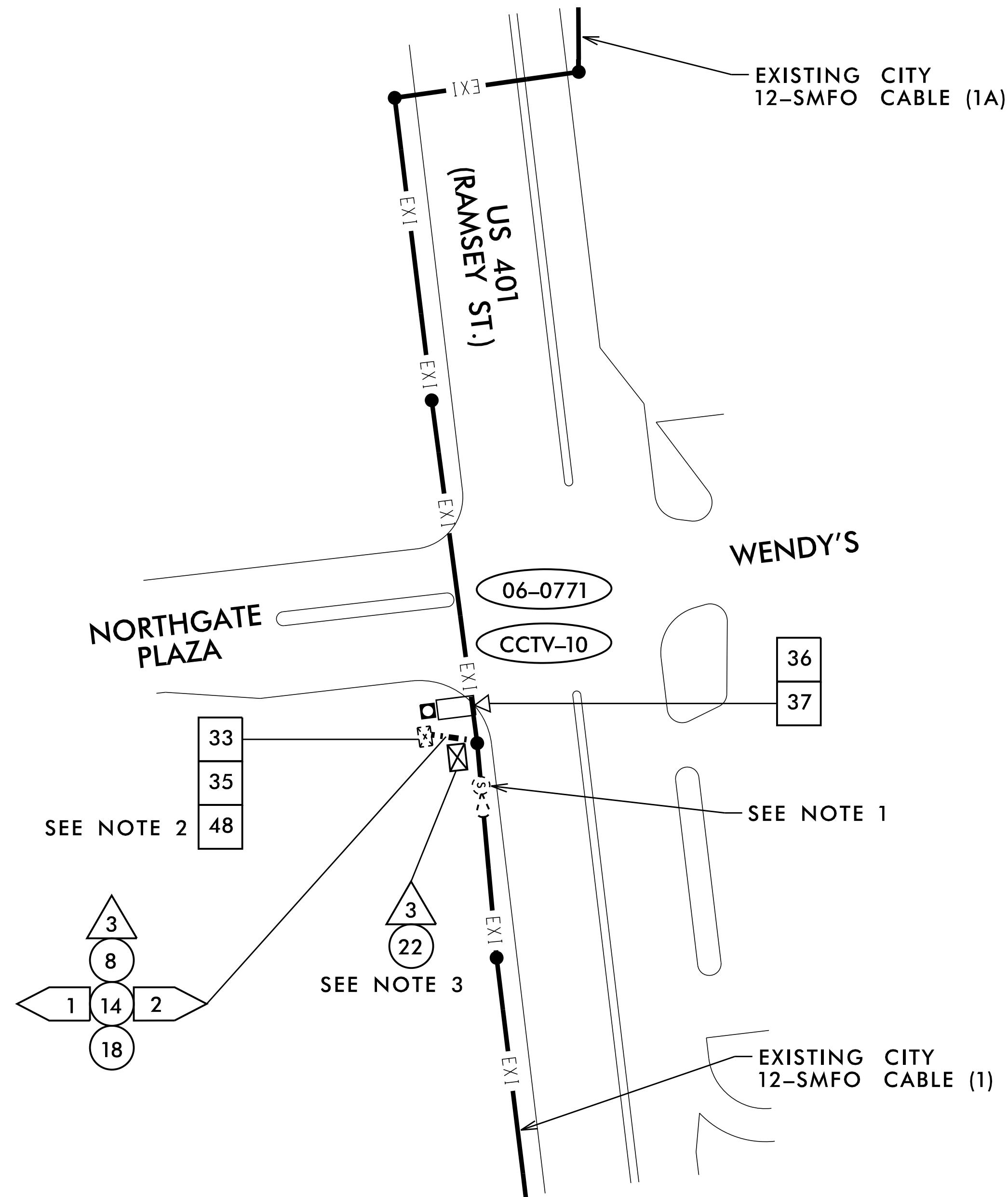

**NOTES:**

1. MODIFY EXISTING CCTV SPLICE ENCLOSURE PER SPLICE DETAILS.
2. REMOVE EXISTING DROP CABLE FROM CCTV CABINET AND REMOVE FROM EXISTING CONDUIT AND/OR MESSENGER CABLE BACK TO EXISTING SPLICE ENCLOSURE.
3. SEE SUMMARY OF WORK TABLES FOR ADDITIONAL CABINET AND COMMUNICATIONS WORK TO BE PERFORMED.

11/15/2016 KARAL\_TPTD\_ITS\_01036305 - Fayetteville Sig Sys\Plans\01036305\_ITS\_psh\_127-CCTV10.dgn

**Kimley»Horn**  
 NC License #F-0102  
 421 Fayetteville St., Suite 600  
 Raleigh, NC 27636  
 Tel: (919) 677-2000  
 Fax: (919) 677-2050

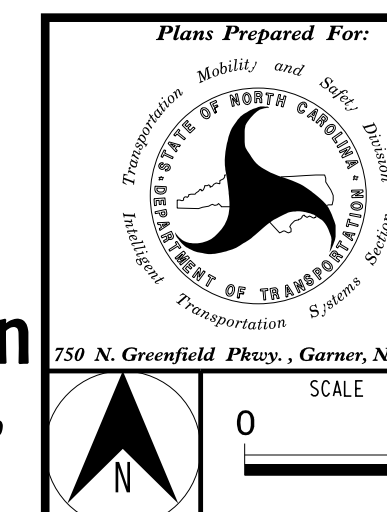

|  |                          |
|--|--------------------------|
| <b>FAYETTEVILLE COMPUTERIZED SIGNAL SYSTEM</b><br><b>EXISTING CCTV 10 INSTALLATION</b> |                          |
| DIVISION 06  | CUMBERLAND COUNTY        |
| PLAN DATE: NOVEMBER 2016   | REVIEWED BY: K. NICHOLAS |
| PREPARED BY: J. CROSS  | REVIEWED BY: K. SMITH    |
| REVISIONS  | INIT. DATE               |
|  |                          |
|  |                          |
|  |                          |

|                                      |
|--------------------------------------|
| SEAL                                 |
|                                      |
| Kevin W. Smith<br>11/15/2016<br>DATE |
| CADD Filename:                       |

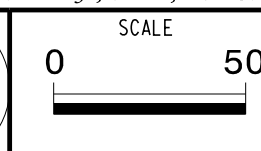
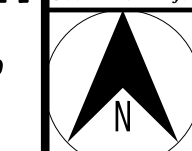

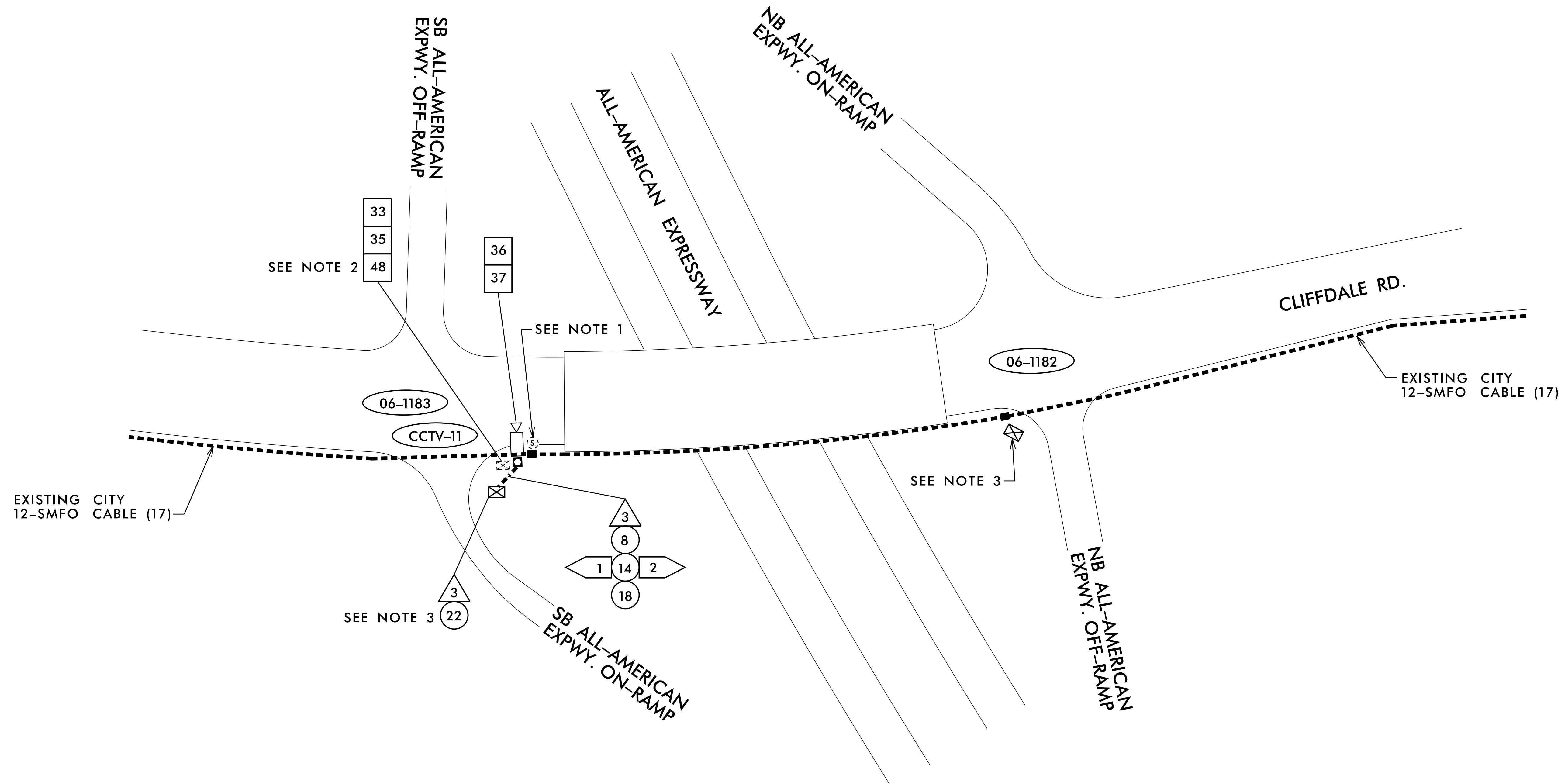

**NOTES:**

1. MODIFY EXISTING CCTV SPLICE ENCLOSURE PER SPLICE DETAILS.
2. REMOVE EXISTING DROP CABLE FROM CCTV CABINET AND REMOVE FROM EXISTING CONDUIT AND/OR MESSENGER CABLE BACK TO EXISTING SPLICE ENCLOSURE.
3. SEE SUMMARY OF WORK TABLES FOR ADDITIONAL CABINET AND COMMUNICATIONS WORK TO BE PERFORMED.

11/15/2016 K:\ARL\TPTD\ITS\01036305 - Fayetteville Sig Sys\Plans\01036305\_ITS\_psh\_r28-CCTV11.dgn

**Kimley»Horn**  
 NC License #F-0102  
 421 Fayetteville St., Suite 600  
 Raleigh, NC 27636  
 Tel: (919) 677-2000  
 Fax: (919) 677-2050

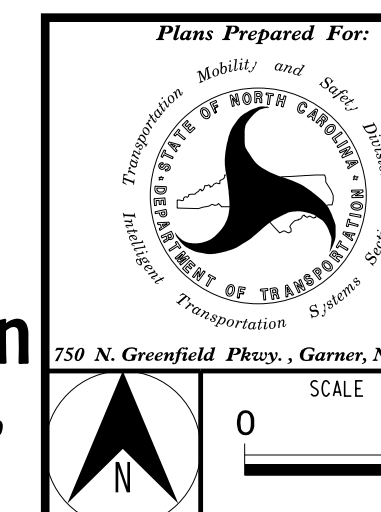

|  |                          |
|--|--------------------------|
| <b>FAYETTEVILLE COMPUTERIZED SIGNAL SYSTEM</b><br><b>EXISTING CCTV 11 INSTALLATION</b> |                          |
| DIVISION 06  | CUMBERLAND COUNTY        |
| PLAN DATE: NOVEMBER 2016   | REVIEWED BY: K. NICHOLAS |
| PREPARED BY: J. CROSS  | REVIEWED BY: K. SMITH    |
| REVISIONS  | INIT. DATE               |
|  |                          |
|  |                          |
|  |                          |
|  |                          |

|                |            |
|----------------|------------|
| SEAL           | DATE       |
|                | 11/15/2016 |
| SIGNATURE      | DATE       |
| Kevin W. Smith | 11/15/2016 |
| CADD Filename: |            |

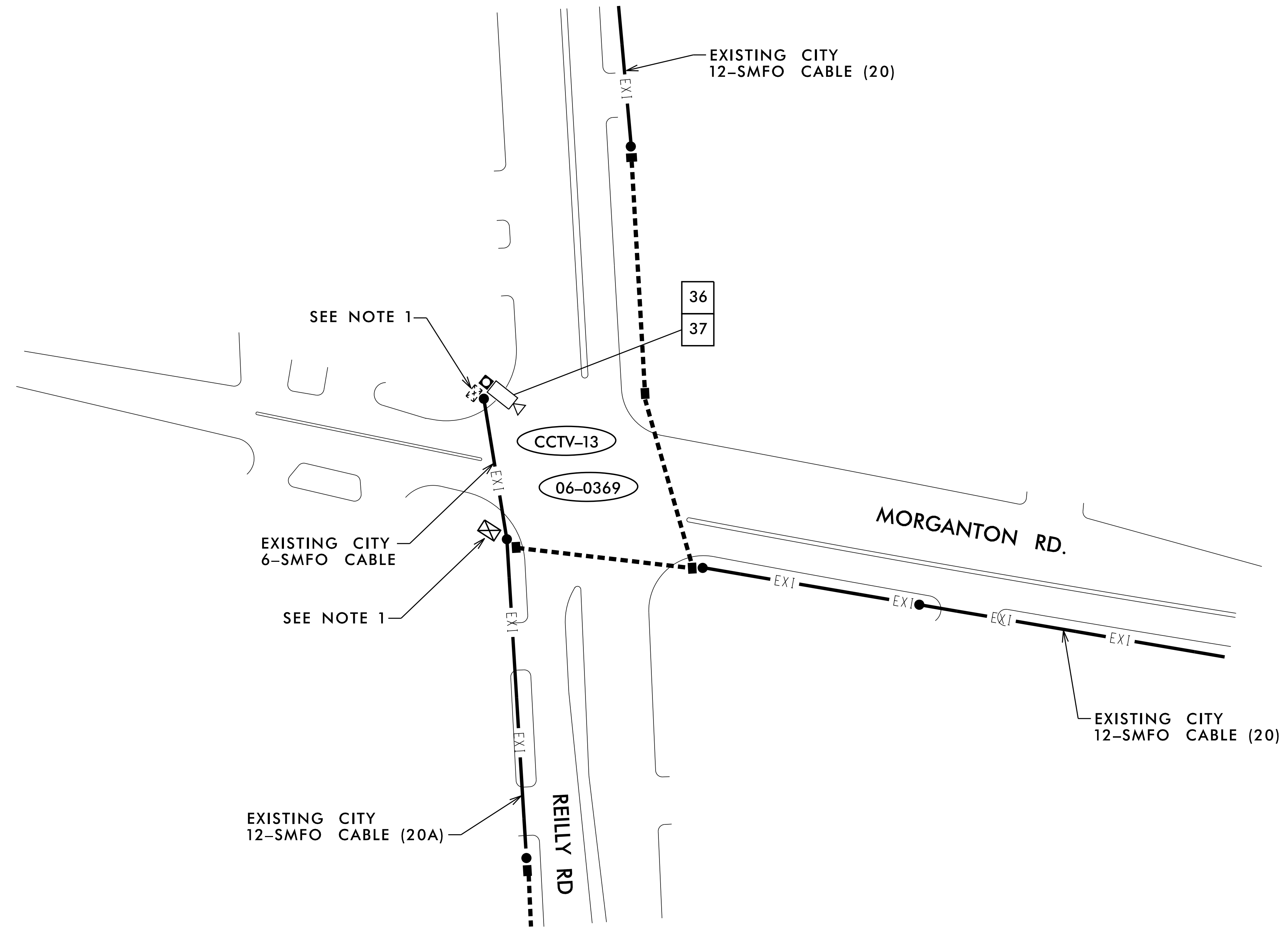

NOTES:  
 1. SEE SUMMARY OF WORK TABLES FOR ADDITIONAL CABINET AND COMMUNICATIONS WORK TO BE PERFORMED.

11/15/2016 K:\ARL\TPTD\ITS\01036305 - Fayetteville Sig Sys\Plans\01036305\_ITS\_psh\_p29-CCTV13.dgn

**Kimley»Horn**  
 NC License #F-0102  
 421 Fayetteville St., Suite 600  
 Raleigh, NC 27636  
 Tel: (919) 677-2000  
 Fax: (919) 677-2050



|  |                          |
|--|--------------------------|
| <b>FAYETTEVILLE COMPUTERIZED SIGNAL SYSTEM</b><br><b>EXISTING CCTV 13 INSTALLATION</b> |                          |
| DIVISION 06  | CUMBERLAND COUNTY        |
| PLAN DATE: NOVEMBER 2016   | REVIEWED BY: K. NICHOLAS |
| PREPARED BY: J. CROSS  | REVIEWED BY: K. SMITH    |
| REVISIONS  | INIT. DATE               |
|  |                          |
|  |                          |
|  |                          |

|  |
|--|
| SEAL   |
|  |
| DocuSigned by:<br>Kevin W. Smith<br>0686E483B0440F<br>SIGNATURE DATE<br>11/15/2016<br>CADD Filename: |

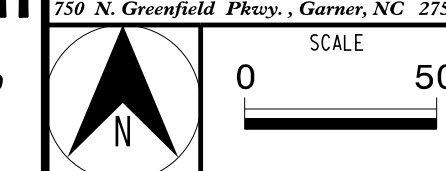

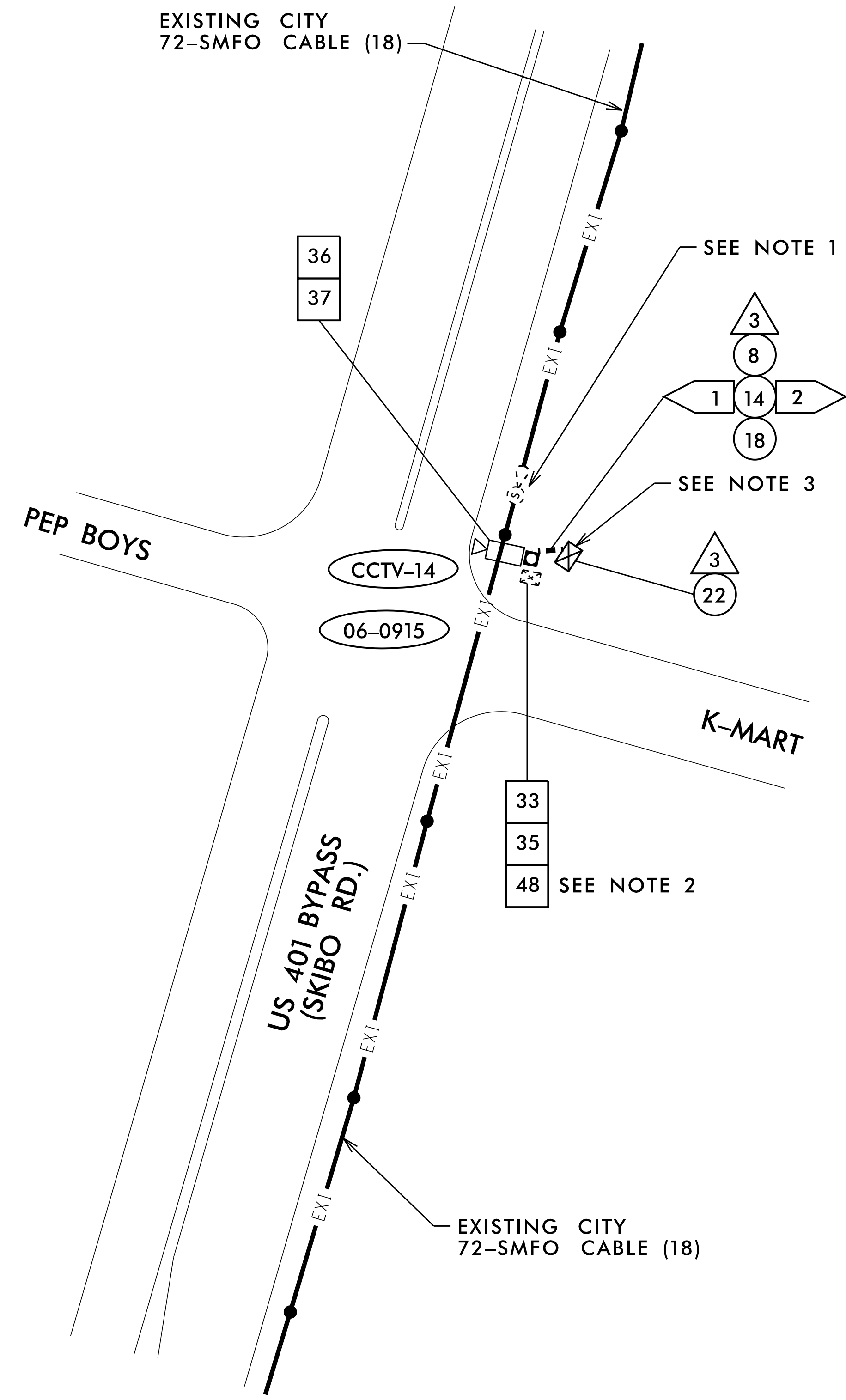

- NOTES:
1. MODIFY EXISTING CCTV SPLICE ENCLOSURE PER SPLICE DETAILS.
  2. REMOVE EXISTING DROP CABLE FROM CCTV CABINET AND REMOVE FROM EXISTING CONDUIT AND/OR MESSENGER CABLE BACK TO EXISTING SPLICE ENCLOSURE.
  3. SEE SUMMARY OF WORK TABLES FOR ADDITIONAL CABINET AND COMMUNICATIONS WORK TO BE PERFORMED.

|                                   |  |  |                      |
|-----------------------------------|--|--|----------------------|
|                                   | <b>FAYETTEVILLE COMPUTERIZED SIGNAL SYSTEM</b><br><b>EXISTING CCTV 14 INSTALLATION</b> |  |                      |
|                                   | DIVISION 06<br>PLAN DATE: NOVEMBER 2016<br>PREPARED BY: J. CROSS                       | CUMBERLAND COUNTY<br>REVIEWED BY: K. NICHOLAS<br>REVIEWED BY: K. SMITH |                      |
| REVISIONS: _____ INIT. DATE _____ |  |  | CADD Filename: _____ |

**Kimley»Horn**  
 NC License #F-0102  
 421 Fayetteville St., Suite 600  
 Raleigh, NC 27636  
 Tel: (919) 677-2000  
 Fax: (919) 677-2050

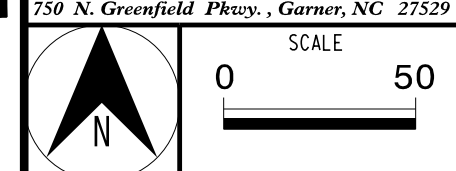

11/15/2016  
 KARAL\_TPTD\_ITS\_01036305 - Fayetteville Sig Sys\Plans\01036305\_ITS\_psh\_b30-CCTV4.dgn

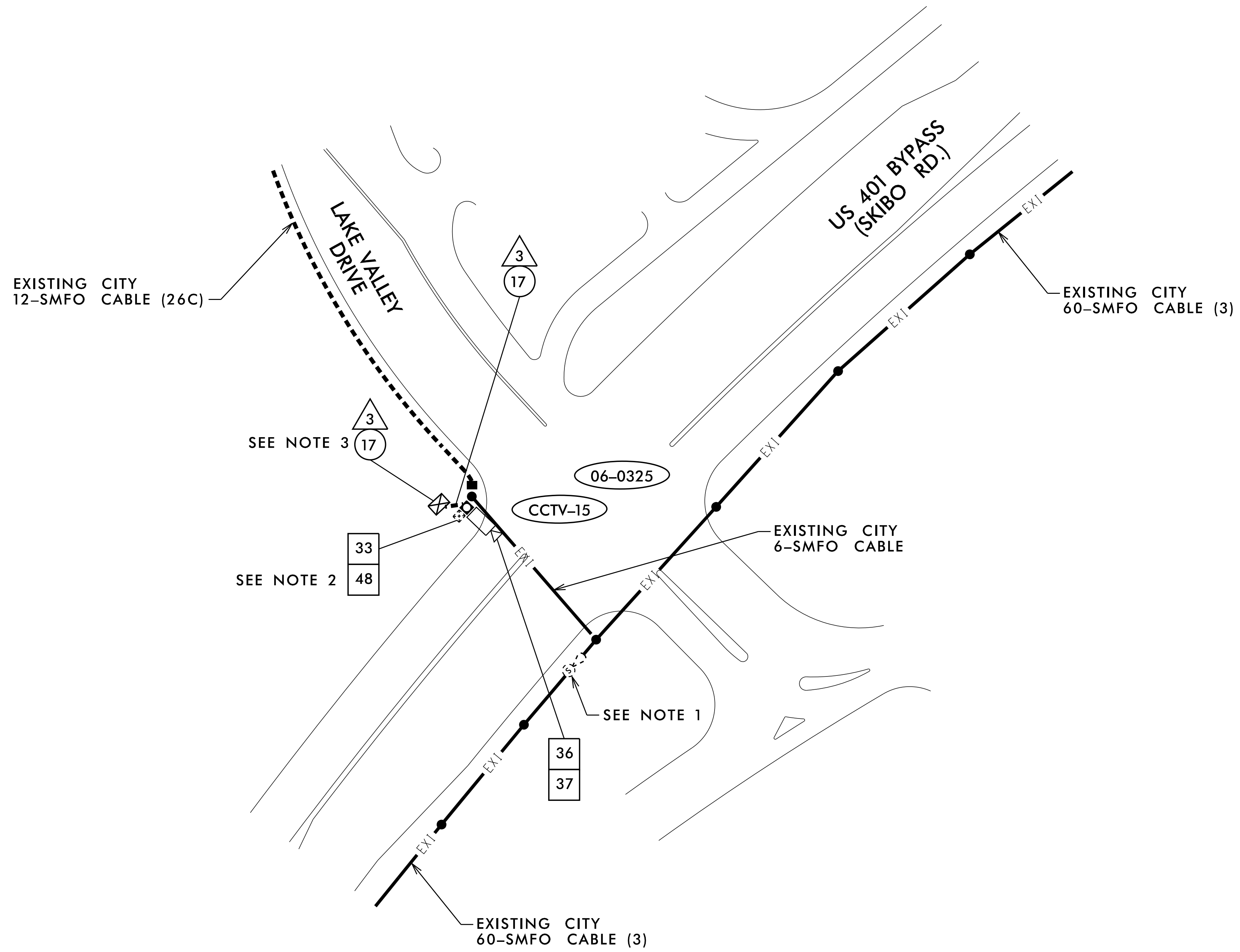

- NOTES:**
1. MODIFY EXISTING CCTV SPLICE ENCLOSURE PER SPLICE DETAILS.
  2. REMOVE EXISTING DROP CABLE FROM CCTV CABINET AND REMOVE FROM EXISTING CONDUIT AND/OR MESSENGER CABLE BACK TO EXISTING SPLICE ENCLOSURE.
  3. SEE SUMMARY OF WORK TABLES FOR ADDITIONAL CABINET AND COMMUNICATIONS WORK TO BE PERFORMED.

11/15/2016 KARAL\_TPTD\_ITS\_01036305 - Fayetteville Sig Sys Plans\01036305\_ITS\_psh\_131-CCTV15.dgn

**Kimley»Horn**  
 NC License #F-0102  
 421 Fayetteville St., Suite 600  
 Raleigh, NC 27636  
 Tel: (919) 677-2000  
 Fax: (919) 677-2050

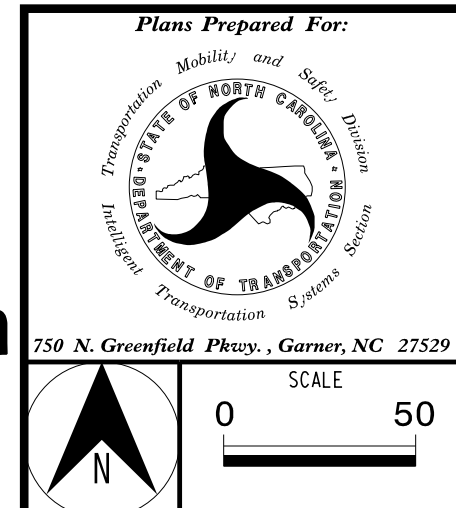

|                     |               |   |             |                                      |  |
|---------------------|---------------|---|-------------|--------------------------------------|--|
| Plans Prepared For: |               | FAYETTEVILLE COMPUTERIZED SIGNAL SYSTEM |             | SEAL                                 |  |
| DIVISION 06         |               | CUMBERLAND COUNTY                       |             | NORTH CAROLINA PROFESSIONAL ENGINEER |  |
| PLAN DATE:          | NOVEMBER 2016 | REVIEWED BY:                            | K. NICHOLAS | KEVIN W. SMITH                       |  |
| PREPARED BY:        | J. CROSS      | REVIEWED BY:                            | K. SMITH    | SEAL 030472                          |  |
| REVISIONS           | INIT.         | DATE                                    | 11/15/2016  |                                      |  |
| SIGNATURE           |               |   | DATE        |                                      |  |
| CADD Filename:      |               |   |             |                                      |  |

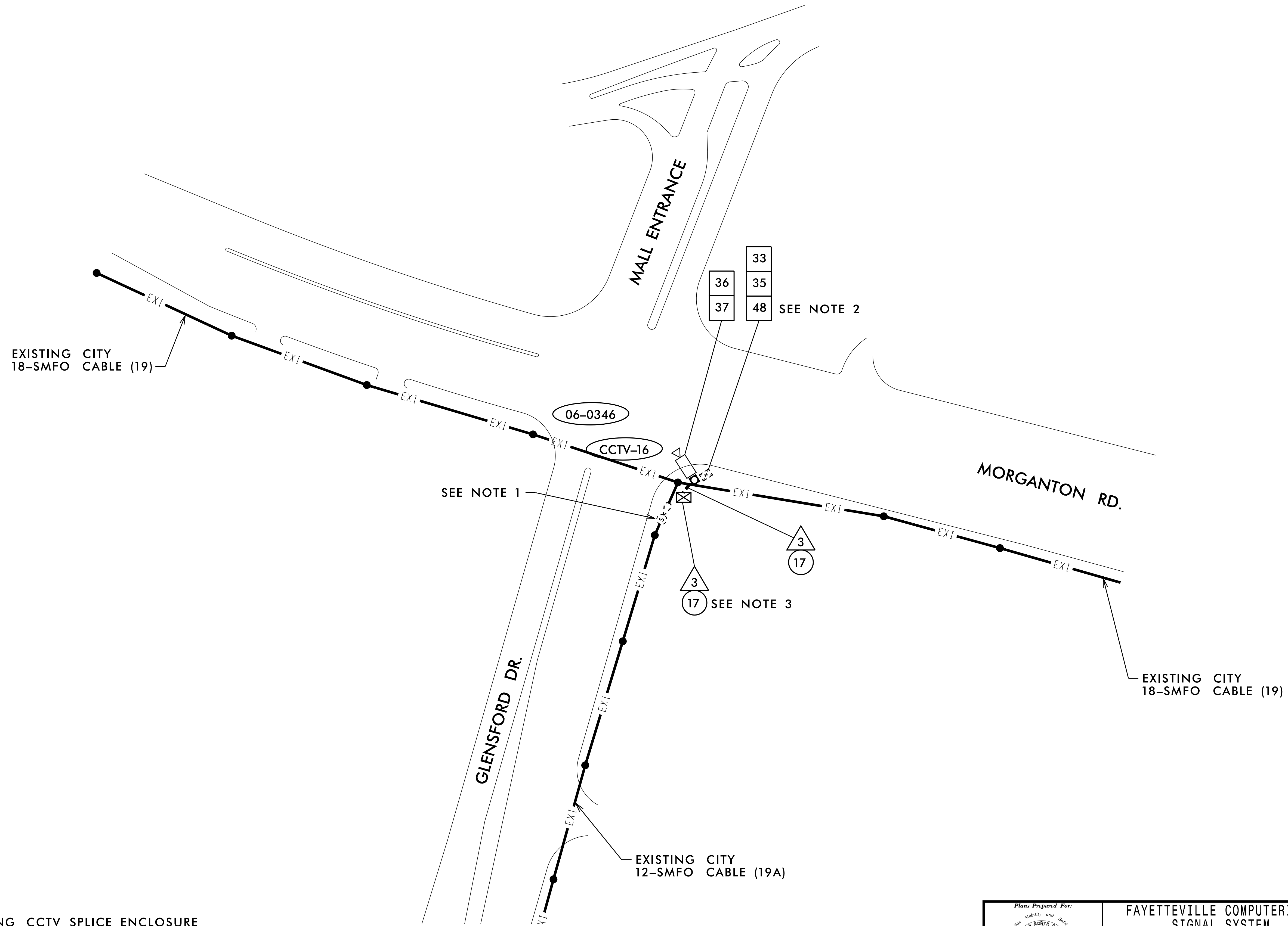

- NOTES:
1. MODIFY EXISTING CCTV SPLICE ENCLOSURE PER SPLICE DETAILS.
  2. REMOVE EXISTING DROP CABLE FROM CCTV CABINET AND REMOVE FROM EXISTING CONDUIT AND/OR MESSENGER CABLE BACK TO EXISTING SPLICE ENCLOSURE.
  3. SEE SUMMARY OF WORK TABLES FOR ADDITIONAL CABINET AND COMMUNICATIONS WORK TO BE PERFORMED.

11/15/2016 KARAL.TPTD.ITS.01036305 - Fayetteville Sig Sys\Plans\01036305.ITS.psh\_b2-CCTV6.dgn

**Kimley»Horn**  
 NC License #F-0102  
 421 Fayetteville St., Suite 600  
 Raleigh, NC 27636  
 Tel: (919) 677-2000  
 Fax: (919) 677-2050

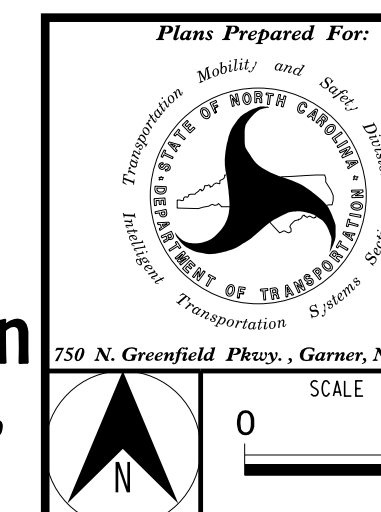

|                               |                          |   |      |
|-------------------------------|--------------------------|---|------|
| Plans Prepared For:           |                          | FAYETTEVILLE COMPUTERIZED SIGNAL SYSTEM |      |
| EXISTING CCTV 16 INSTALLATION |                          | SEAL 030472                             |      |
| DIVISION 06                   |                          | CUMBERLAND COUNTY                       |      |
| PLAN DATE: NOVEMBER 2016      | REVIEWED BY: K. NICHOLAS | REVISIONS                               |      |
| PREPARED BY: J. CROSS         | REVIEWED BY: K. SMITH    | INIT.                                   | DATE |
|                               |                          |   |      |
|                               |                          |   |      |
|                               |                          |   |      |

|                |            |
|----------------|------------|
| SEAL           | DATE       |
| KEVIN W. SMITH | 11/15/2016 |
| SIGNATURE      | DATE       |
| CADD Filename: |            |



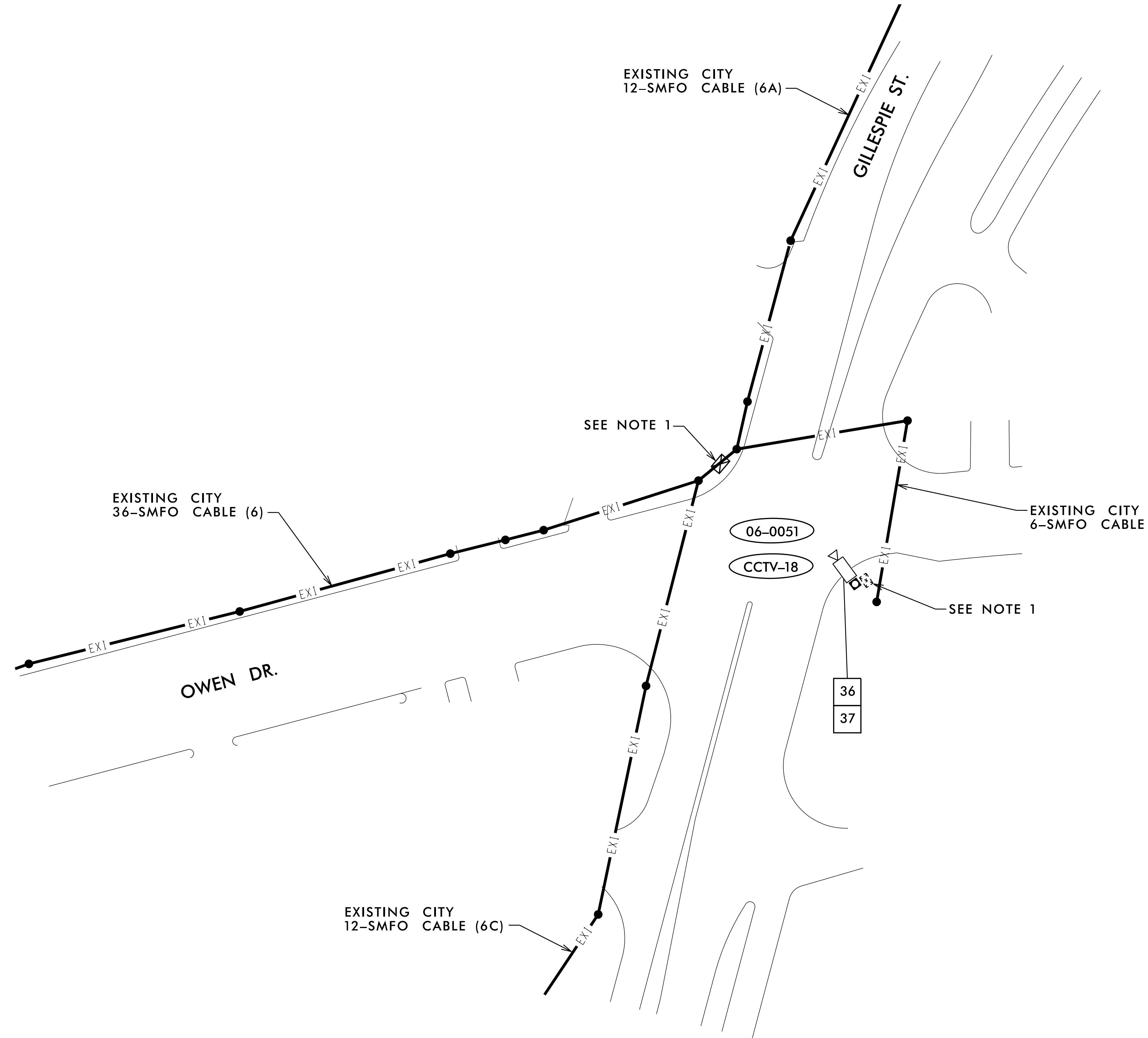



**NOTES:**  
 1. SEE SUMMARY OF WORK TABLES FOR ADDITIONAL CABINET AND COMMUNICATIONS WORK TO BE PERFORMED.

11/15/2016 K:\ARL\TPTD\ITS\01036305 - Fayetteville Sig Sys\Plans\01036305\_ITS\_psh\_B3-CCTV18.dgn

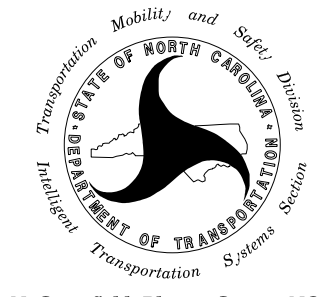
**Kimley»Horn**  
 NC License #F-0102  
 421 Fayetteville St., Suite 600  
 Raleigh, NC 27636  
 Tel: (919) 677-2000  
 Fax: (919) 677-2050

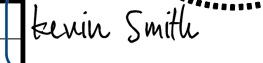
| <br>Plans Prepared For:<br>Transportation Mobility and Safety Division<br>STATE OF NORTH CAROLINA<br>DEPARTMENT OF TRANSPORTATION | <b>FAYETTEVILLE COMPUTERIZED SIGNAL SYSTEM</b><br><b>EXISTING CCTV 18 INSTALLATION</b>   |       | SEAL<br><br>KEVIN W. SMITH<br>ENGINEER<br>030472 |       |      |  |  |  |  |  |  |   |
|--|--|-------|---|-------|------|--|--|--|--|--|--|---|
|  | DIVISION 06 CUMBERLAND COUNTY<br>PLAN DATE: NOVEMBER 2016 REVIEWED BY: K. NICHOLAS<br>PREPARED BY: J. CROSS REVIEWED BY: K. SMITH  |       |   |       |      |  |  |  |  |  |  |   |
| <br>SCALE<br>0 50   | <table border="1"> <thead> <tr> <th>REVISIONS</th> <th>INIT.</th> <th>DATE</th> </tr> </thead> <tbody> <tr> <td> </td> <td> </td> <td> </td> </tr> <tr> <td> </td> <td> </td> <td> </td> </tr> </tbody> </table> |       | REVISIONS   | INIT. | DATE |  |  |  |  |  |  | DocuSigned By:<br><br>KEVIN W. SMITH<br>11/15/2016<br>SEAL<br>030472<br>SIGNATURE DATE<br>CADD Filename: |
|  | REVISIONS  | INIT. | DATE  |       |      |  |  |  |  |  |  |   |
|  |  |       |   |       |      |  |  |  |  |  |  |   |
|  |  |       |   |       |      |  |  |  |  |  |  |   |

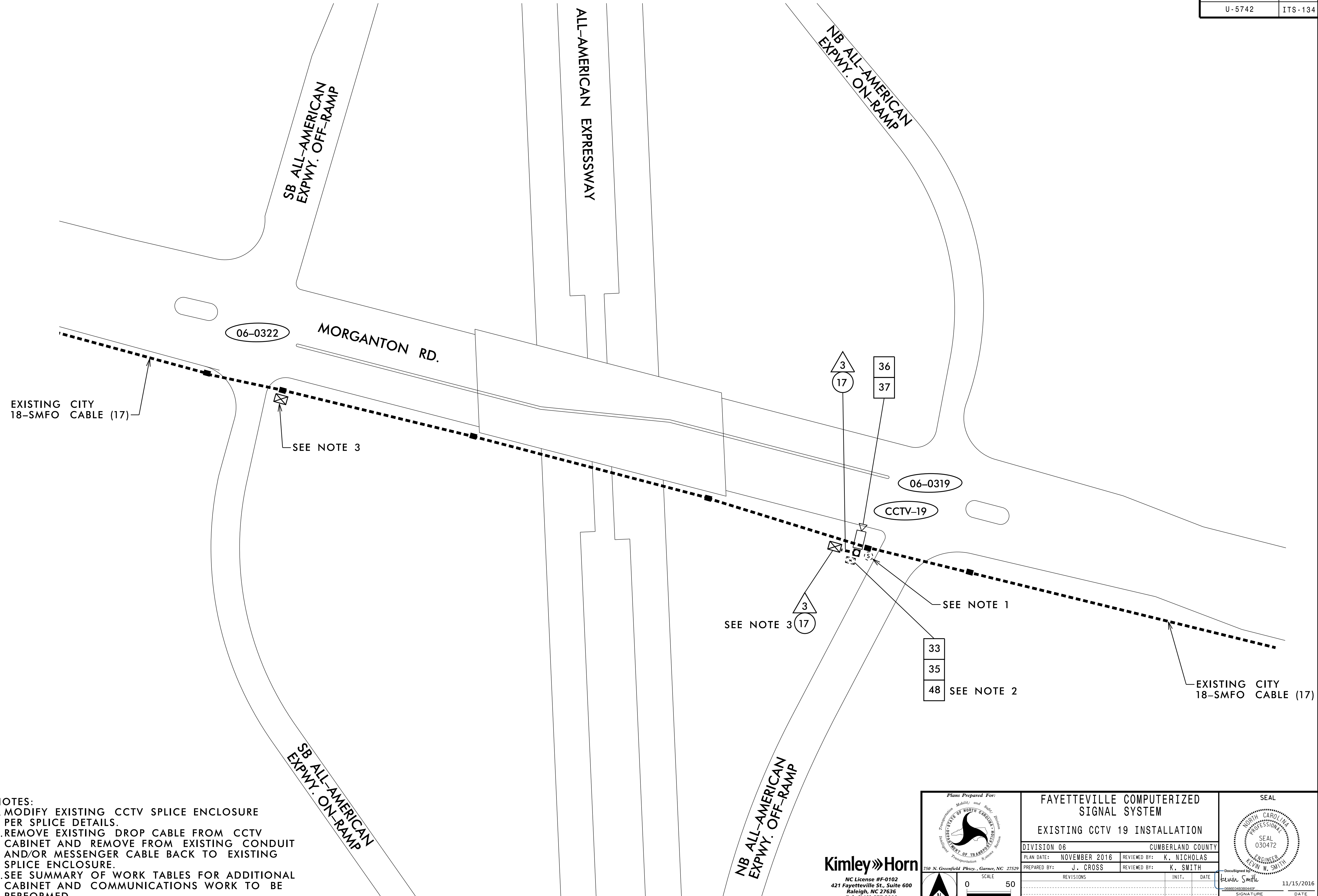

- NOTES:**
1. MODIFY EXISTING CCTV SPLICE ENCLOSURE PER SPLICE DETAILS.
  2. REMOVE EXISTING DROP CABLE FROM CCTV CABINET AND REMOVE FROM EXISTING CONDUIT AND/OR MESSENGER CABLE BACK TO EXISTING SPLICE ENCLOSURE.
  3. SEE SUMMARY OF WORK TABLES FOR ADDITIONAL CABINET AND COMMUNICATIONS WORK TO BE PERFORMED.

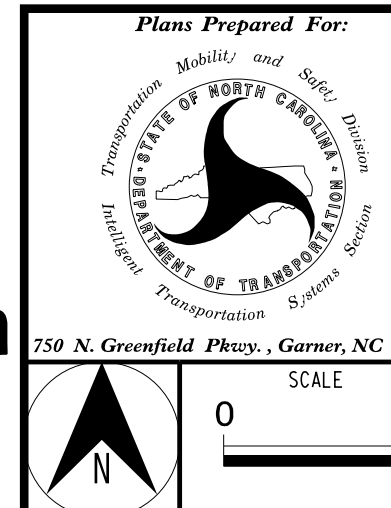



**Kimley-Horn**  
 NC License #F-0102  
 421 Fayetteville St., Suite 600  
 Raleigh, NC 27636  
 Tel: (919) 677-2000  
 Fax: (919) 677-2050

|   |  |  |  |  |
|---|--|--|--|--|
| Plans Prepared For:<br>DEPARTMENT OF TRANSPORTATION<br>Transportation Systems Section |  | <b>FAYETTEVILLE COMPUTERIZED SIGNAL SYSTEM</b><br><b>EXISTING CCTV 19 INSTALLATION</b> |  | SEAL<br>   |
| DIVISION 06<br>PLAN DATE: NOVEMBER 2016<br>PREPARED BY: J. CROSS                      |  | CUMBERLAND COUNTY<br>REVIEWED BY: K. NICHOLAS<br>REVIEWED BY: K. SMITH                 |  | DocuSigned by:<br>Kevin W. Smith<br>11/15/2016<br>SIGNATURE DATE<br>CADD Filename: |
| REVISIONS<br>_____<br>_____<br>_____  |  | INIT. DATE<br>_____<br>_____<br>_____  |  |  |

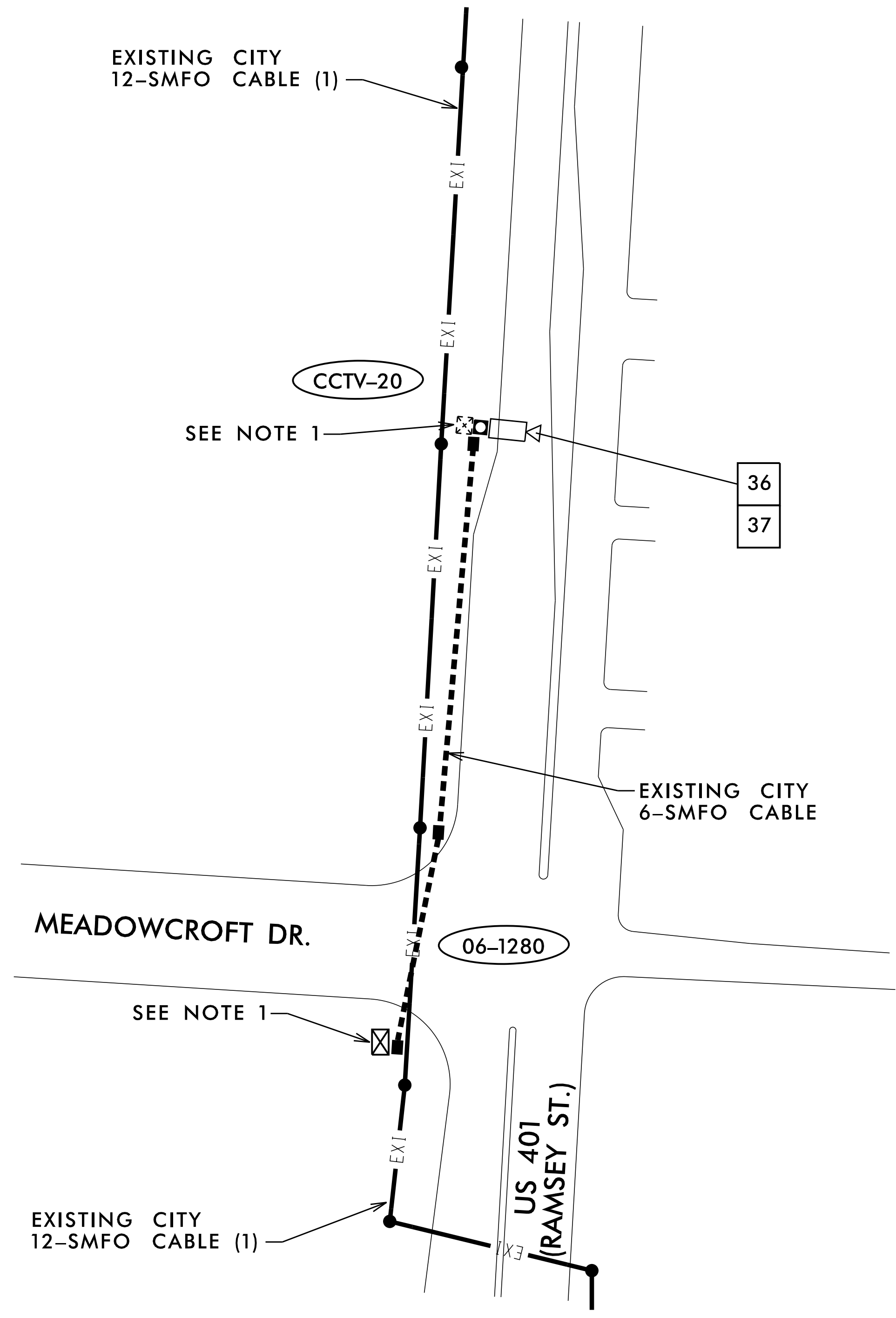
11/15/2016  
 K:\ARL\TPTD\ITS\01036305 - Fayetteville Sig Sys\Plans\01036305\_ITS\_psh\_134-CCTV19.dgn

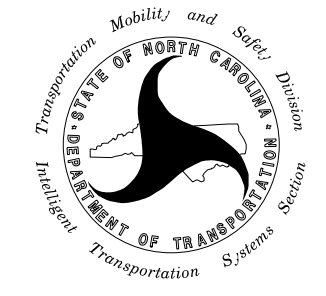

NOTES:  
 1. SEE SUMMARY OF WORK TABLES FOR ADDITIONAL CABINET AND COMMUNICATIONS WORK TO BE PERFORMED.

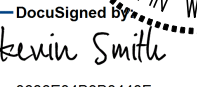
| <br>Plans Prepared For:<br>Transportation Mobility and Safety Division<br>STATE OF NORTH CAROLINA<br>DEPARTMENT OF TRANSPORTATION<br>250 N. Greenfield Place, Garner, NC 27529 | <b>FAYETTEVILLE COMPUTERIZED SIGNAL SYSTEM</b><br><b>EXISTING CCTV 20 INSTALLATION</b>   |       | SEAL<br><br>KEVIN W. SMITH<br>ENGINEER<br>SEAL<br>030472 |       |      |  |  |  |  |  |  |  |  |  |   |
|---|--|-------|---|-------|------|--|--|--|--|--|--|--|--|--|---|
|   | DIVISION 06 CUMBERLAND COUNTY<br>PLAN DATE: NOVEMBER 2016 REVIEWED BY: K. NICHOLAS<br>PREPARED BY: J. CROSS REVIEWED BY: K. SMITH  |       |   |       |      |  |  |  |  |  |  |  |  |  |   |
| <br>SCALE<br>0 50  | <table border="1"> <thead> <tr> <th>REVISIONS</th> <th>INIT.</th> <th>DATE</th> </tr> </thead> <tbody> <tr> <td> </td> <td> </td> <td> </td> </tr> <tr> <td> </td> <td> </td> <td> </td> </tr> <tr> <td> </td> <td> </td> <td> </td> </tr> </tbody> </table> |       | REVISIONS   | INIT. | DATE |  |  |  |  |  |  |  |  |  | DocuSigned By:<br><br>0686E483B0440F<br>SIGNATURE DATE<br>11/15/2016<br>CADD Filename: |
|   | REVISIONS  | INIT. | DATE  |       |      |  |  |  |  |  |  |  |  |  |   |
|   |  |       |   |       |      |  |  |  |  |  |  |  |  |  |   |
|   |  |       |   |       |      |  |  |  |  |  |  |  |  |  |   |
|   |  |       |   |       |      |  |  |  |  |  |  |  |  |  |   |

**Kimley»Horn**  
 NC License #F-0102  
 421 Fayetteville St., Suite 600  
 Raleigh, NC 27636  
 Tel: (919) 677-2000  
 Fax: (919) 677-2050

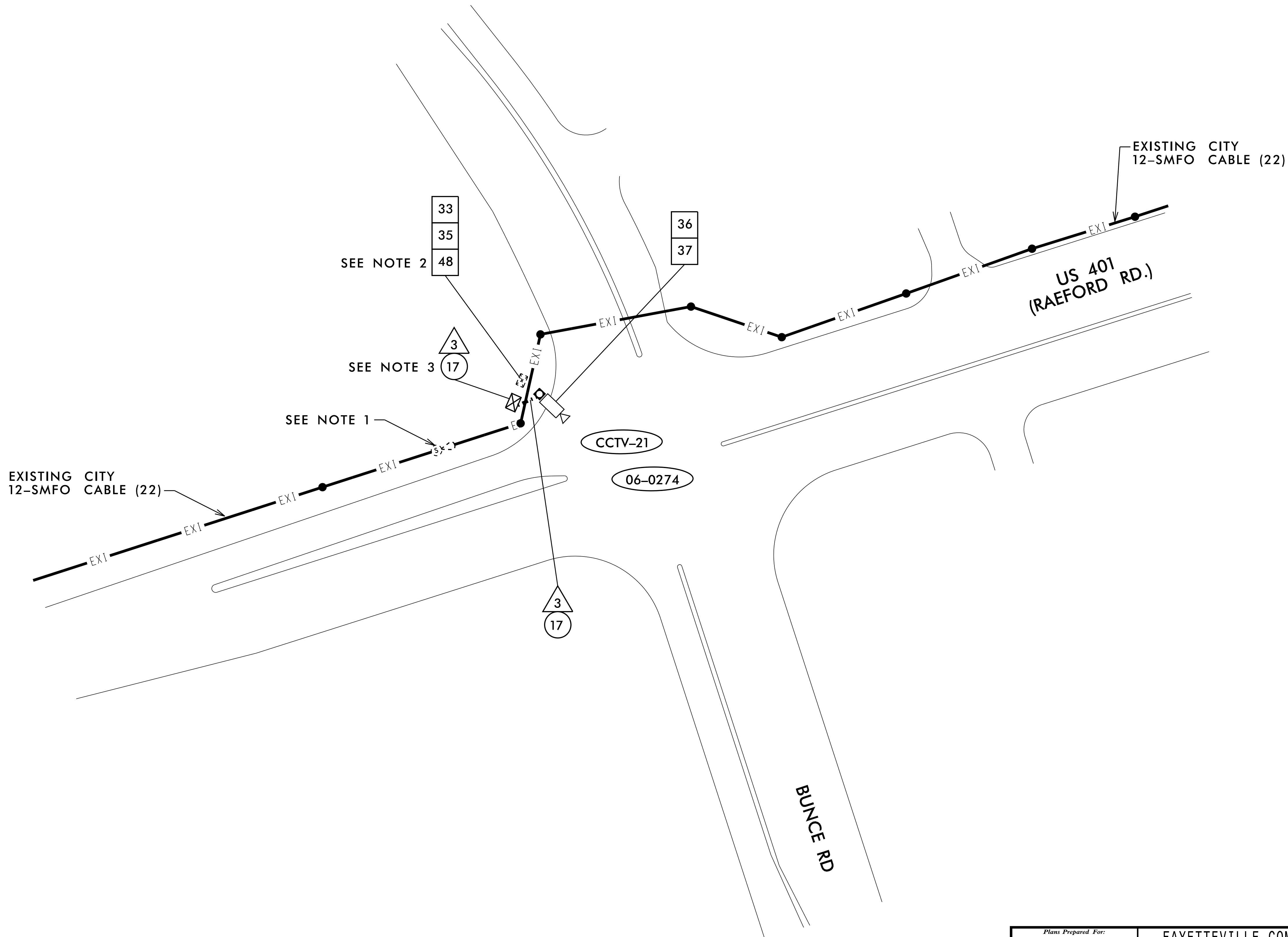

**NOTES:**

1. MODIFY EXISTING CCTV SPLICE ENCLOSURE PER SPLICE DETAILS.
2. REMOVE EXISTING DROP CABLE FROM CCTV CABINET AND REMOVE FROM EXISTING CONDUIT AND/OR MESSENGER CABLE BACK TO EXISTING SPLICE ENCLOSURE.
3. SEE SUMMARY OF WORK TABLES FOR ADDITIONAL CABINET AND COMMUNICATIONS WORK TO BE PERFORMED.

11/15/2016 KARAL\_TPTD\_ITS\_01036305 - Fayetteville Sig Sys\Plans\01036305\_ITS\_psh\_b6-CCTV21.dgn

**Kimley»Horn**  
 NC License #F-0102  
 421 Fayetteville St., Suite 600  
 Raleigh, NC 27636  
 Tel: (919) 677-2000  
 Fax: (919) 677-2050

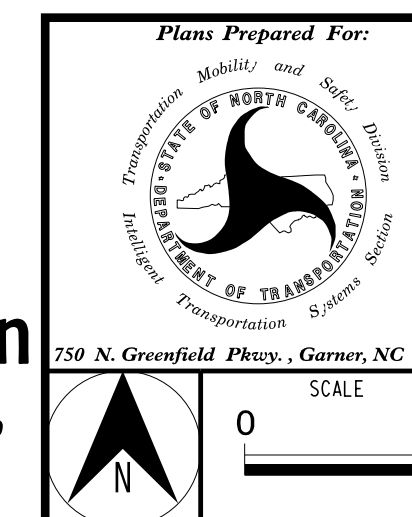

|  |                          |
|--|--------------------------|
| <b>FAYETTEVILLE COMPUTERIZED SIGNAL SYSTEM</b><br><b>EXISTING CCTV 21 INSTALLATION</b> |                          |
| DIVISION 06  | CUMBERLAND COUNTY        |
| PLAN DATE: NOVEMBER 2016   | REVIEWED BY: K. NICHOLAS |
| PREPARED BY: J. CROSS  | REVIEWED BY: K. SMITH    |
| REVISIONS  | INIT. DATE               |
|  |                          |
|  |                          |
|  |                          |

|                |            |
|----------------|------------|
| SEAL           | DATE       |
|                | 11/15/2016 |
| SIGNATURE      | DATE       |
| Kevin W. Smith | 11/15/2016 |
| CADD Filename: |            |

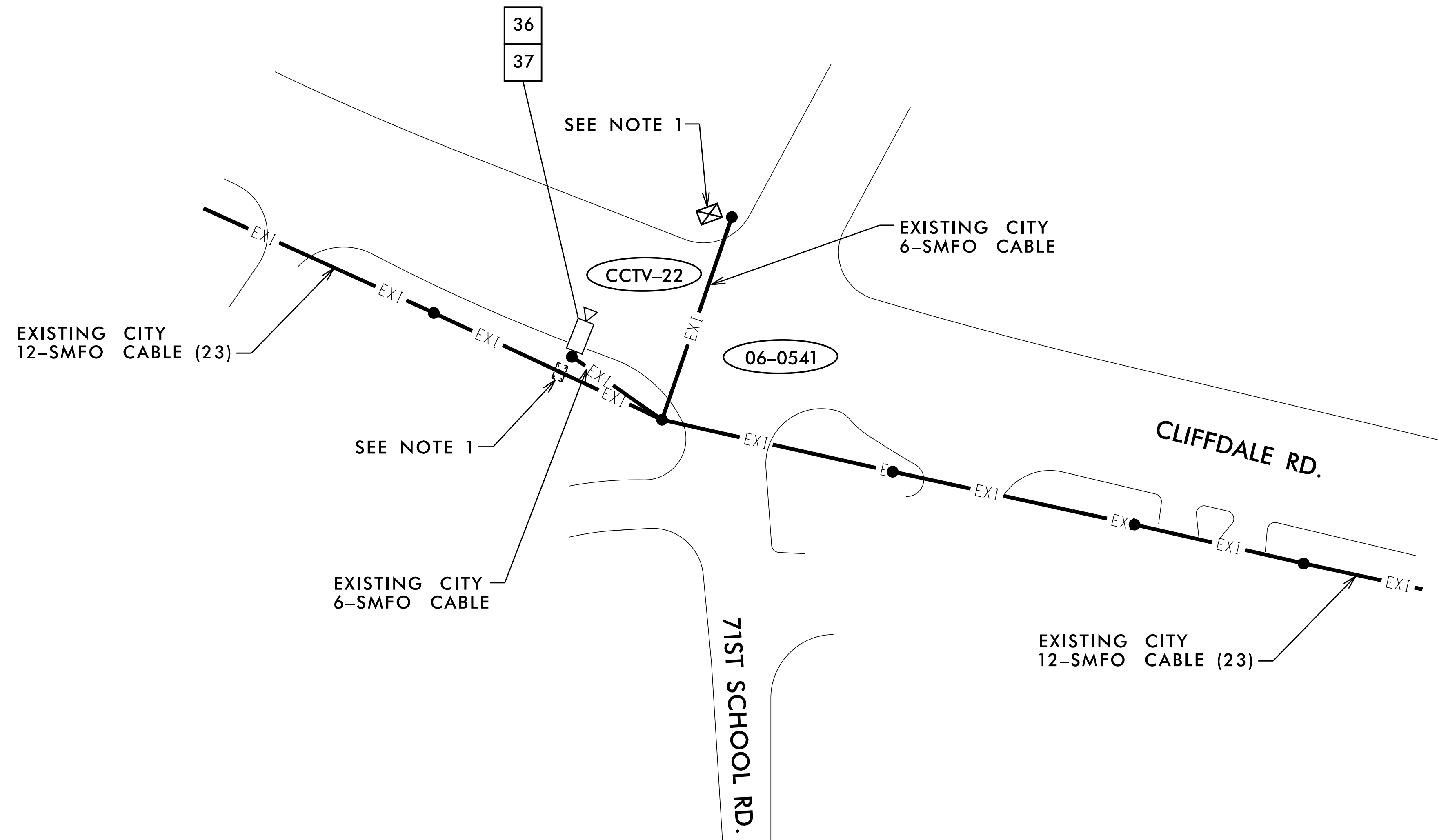

NOTES:  
 1. SEE SUMMARY OF WORK TABLES FOR ADDITIONAL CABINET AND COMMUNICATIONS WORK TO BE PERFORMED.

11/15/2016 K:\ARL\TPTD\ITS\01036305 - Fayetteville Sig Sys\Plans\01036305\_ITS\_psh\_137-CCTV22.dgn

**Kimley»Horn**  
 NC License #F-0102  
 421 Fayetteville St., Suite 600  
 Raleigh, NC 27636  
 Tel: (919) 677-2000  
 Fax: (919) 677-2050

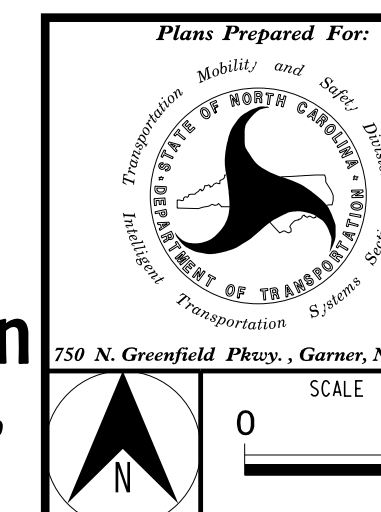

|   |                          |
|---|--------------------------|
| FAYETTEVILLE COMPUTERIZED SIGNAL SYSTEM |                          |
| EXISTING CCTV 22 INSTALLATION           |                          |
| DIVISION 06                             | CUMBERLAND COUNTY        |
| PLAN DATE: NOVEMBER 2016                | REVIEWED BY: K. NICHOLAS |
| PREPARED BY: J. CROSS                   | REVIEWED BY: K. SMITH    |
| REVISIONS                               | INIT. DATE               |
|   |                          |
|   |                          |
|   |                          |

|   |
|---|
| SEAL  |
|   |
| DocuSigned by:<br>Kevin W. Smith<br>0686E4B3B440F<br>SIGNATURE DATE<br>11/15/2016<br>CADD Filename: |

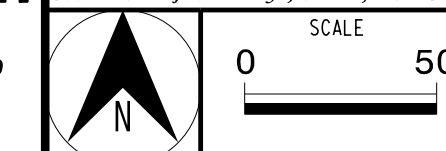

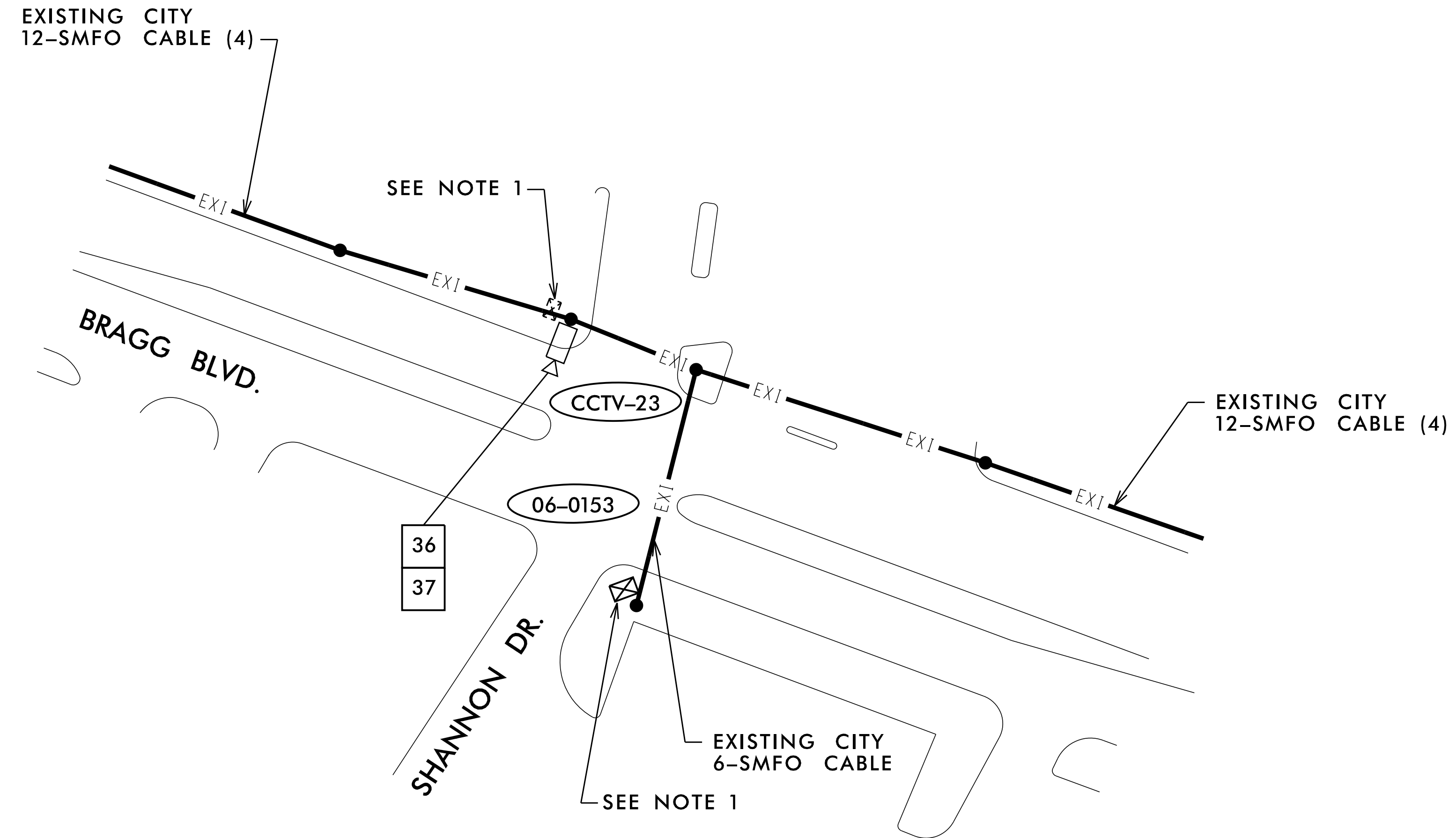



NOTES:  
 1. SEE SUMMARY OF WORK TABLES FOR ADDITIONAL CABINET AND COMMUNICATIONS WORK TO BE PERFORMED.

11/15/2016 K:\ARL\TPTD\ITS\01036305 - Fayetteville Sig Sys\Plans\01036305\_ITS\_psh\_B8-CCTV23.dgn

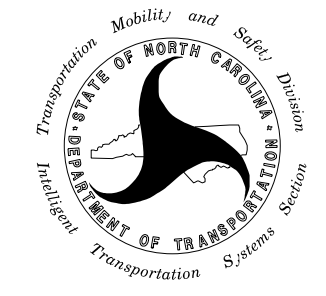
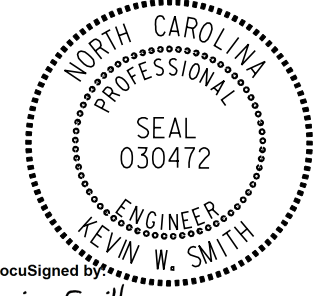
**Kimley»Horn**  
 NC License #F-0102  
 421 Fayetteville St., Suite 600  
 Raleigh, NC 27636  
 Tel: (919) 677-2000  
 Fax: (919) 677-2050

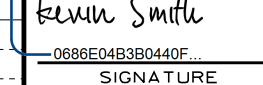
|  |   |   |  |
|--|---|---|--|
| <br>Plans Prepared For:<br>FAYETTEVILLE COMPUTERIZED SIGNAL SYSTEM<br>EXISTING CCTV 23 INSTALLATION | DIVISION 06 CUMBERLAND COUNTY                     |   | SEAL<br><br>KEVIN W. SMITH<br>ENGINEER<br>SEAL 030472 |
|  | PLAN DATE: NOVEMBER 2016<br>PREPARED BY: J. CROSS | REVIEWED BY: K. NICHOLAS<br>REVIEWED BY: K. SMITH   |  |
| 750 N. Greenfield Place, Garner, NC 27529<br> SCALE 0 50  |   | DocuSigned by:<br><br>KEVIN W. SMITH<br>11/15/2016<br>SIGNATURE DATE<br>CADD Filename: |  |

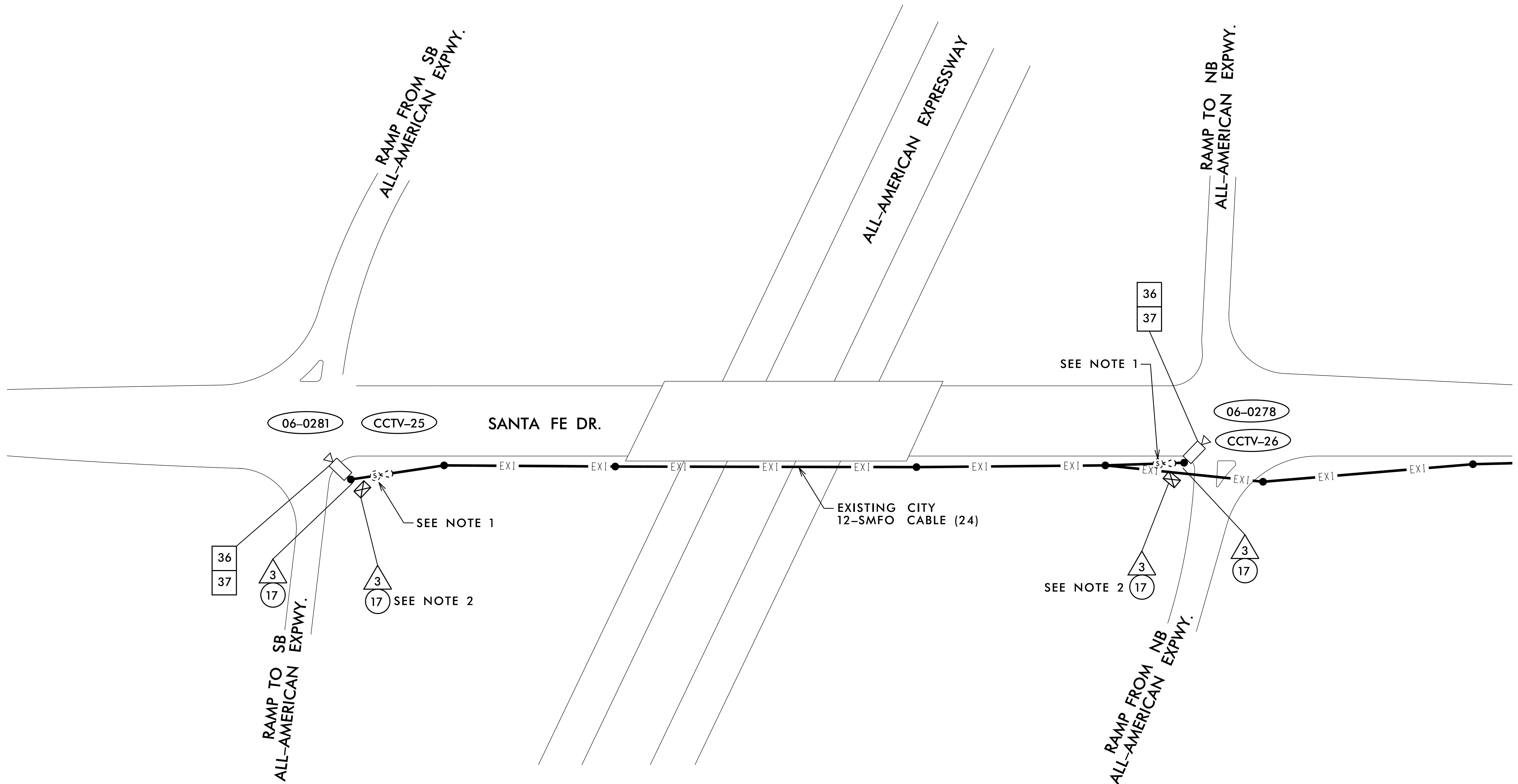

**NOTE:**  
 1. MODIFY EXISTING CCTV SPLICE ENCLOSURE PER SPLICE DETAILS.  
 2. SEE SUMMARY OF WORK TABLES FOR ADDITIONAL CABINET AND COMMUNICATIONS WORK TO BE PERFORMED.

11/15/2016 K:\ARL\TPTD\ITS\01036305 - Fayetteville Sig Sys\Plans\01036305\_ITS\_psh\_B9-CCTV25-26.dgn



**Kimley»Horn**  
 NC License #F-0102  
 421 Fayetteville St., Suite 600  
 Raleigh, NC 27636  
 Tel: (919) 677-2000  
 Fax: (919) 677-2050

|                          |  |                   |  |
|--------------------------|--|-------------------|--|
|                          | <b>FAYETTEVILLE COMPUTERIZED SIGNAL SYSTEM</b> |                   |  |
|                          | EXISTING CCTV 25&26 INSTALLATION               |                   |  |
| DIVISION 06              |  | CUMBERLAND COUNTY |  |
| PLAN DATE: NOVEMBER 2016 | REVIEWED BY: K. NICHOLAS                       |                   | I,  Kevin W. Smith<br>0686E0483B0440F<br>SIGNATURE DATE 11/15/2016<br>CADD Filename: |
| PREPARED BY: J. CROSS    | REVIEWED BY: K. SMITH                          |                   |  |
| REVISIONS                | INIT.  | DATE              |  |

# NOT USED

11/15/2016 KARAL\_TPTD\_ITS\_01036305 - Fayetteville Sig Sys\Plans\01036305\_ITS\_psh\_40-CCTV27.dgn

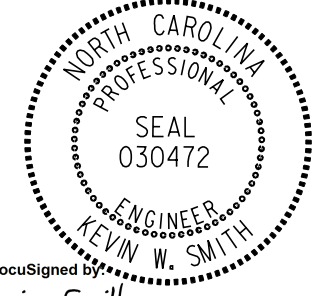
**Kimley»Horn**  
 NC License #F-0102  
 421 Fayetteville St., Suite 600  
 Raleigh, NC 27636  
 Tel: (919) 677-2000  
 Fax: (919) 677-2050

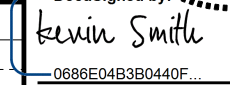
| <br>Plans Prepared For:<br>Transportation Mobility and Safety Division<br>DEPARTMENT OF TRANSPORTATION<br>State of North Carolina | <b>FAYETTEVILLE COMPUTERIZED SIGNAL SYSTEM</b><br><b>EXISTING CCTV 27 INSTALLATION</b>  |  | SEAL<br><br>KEVIN W. SMITH<br>ENGINEER |       |      |  |  |  |  |  |  |  |  |  |  |
|--|---|--|---|-------|------|--|--|--|--|--|--|--|--|--|--|
|  | DIVISION 06 CUMBERLAND COUNTY<br>PLAN DATE: NOVEMBER 2016 REVIEWED BY: K. NICHOLAS<br>PREPARED BY: J. CROSS REVIEWED BY: K. SMITH |  |   |       |      |  |  |  |  |  |  |  |  |  |  |
|   | SCALE<br>0 50   | <table border="1"> <thead> <tr> <th>REVISIONS</th> <th>INIT.</th> <th>DATE</th> </tr> </thead> <tbody> <tr> <td> </td> <td> </td> <td> </td> </tr> <tr> <td> </td> <td> </td> <td> </td> </tr> <tr> <td> </td> <td> </td> <td> </td> </tr> </tbody> </table> | REVISIONS   | INIT. | DATE |  |  |  |  |  |  |  |  |  | DocuSigned by:<br><br>088E0483B0440E 11/15/2016<br>SIGNATURE DATE<br>CADD Filename: |
| REVISIONS  | INIT.   | DATE   |   |       |      |  |  |  |  |  |  |  |  |  |  |
|  |   |  |   |       |      |  |  |  |  |  |  |  |  |  |  |
|  |   |  |   |       |      |  |  |  |  |  |  |  |  |  |  |
|  |   |  |   |       |      |  |  |  |  |  |  |  |  |  |  |



# NOT USED

11/15/2016 KARAL\_TPTD\_ITS\_01036305 - Fayetteville Sig Sys\Plans\01036305\_ITS\_psh\_4f-CCTV28.dgn

**Kimley»Horn**  
 NC License #F-0102  
 421 Fayetteville St., Suite 600  
 Raleigh, NC 27636  
 Tel: (919) 677-2000  
 Fax: (919) 677-2050

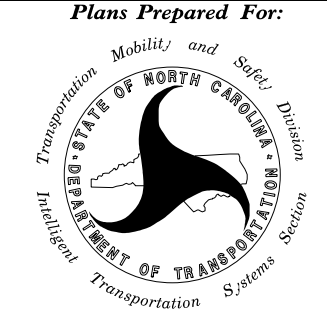
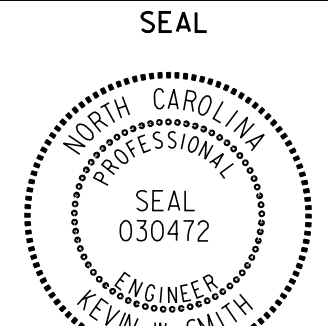
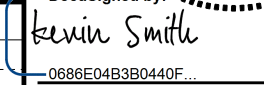
|   |   |   |   |
|---|---|---|---|
|  | <b>FAYETTEVILLE COMPUTERIZED SIGNAL SYSTEM</b><br>EXISTING CCTV 28 INSTALLATION |   |  |
|   | DIVISION 06   | CUMBERLAND COUNTY   |   |
| PLAN DATE: NOVEMBER 2016<br>PREPARED BY: J. CROSS                                     | REVIEWED BY: K. NICHOLAS<br>REVIEWED BY: K. SMITH                               | DocuSigned by:<br> |   |
| REVISIONS<br>_____<br>_____<br>_____  | INIT.<br>_____<br>_____<br>_____  | DATE<br>_____<br>_____<br>_____   | 11/15/2016<br>_____<br>_____<br>_____   |
| CADD Filename:  |   |   |   |

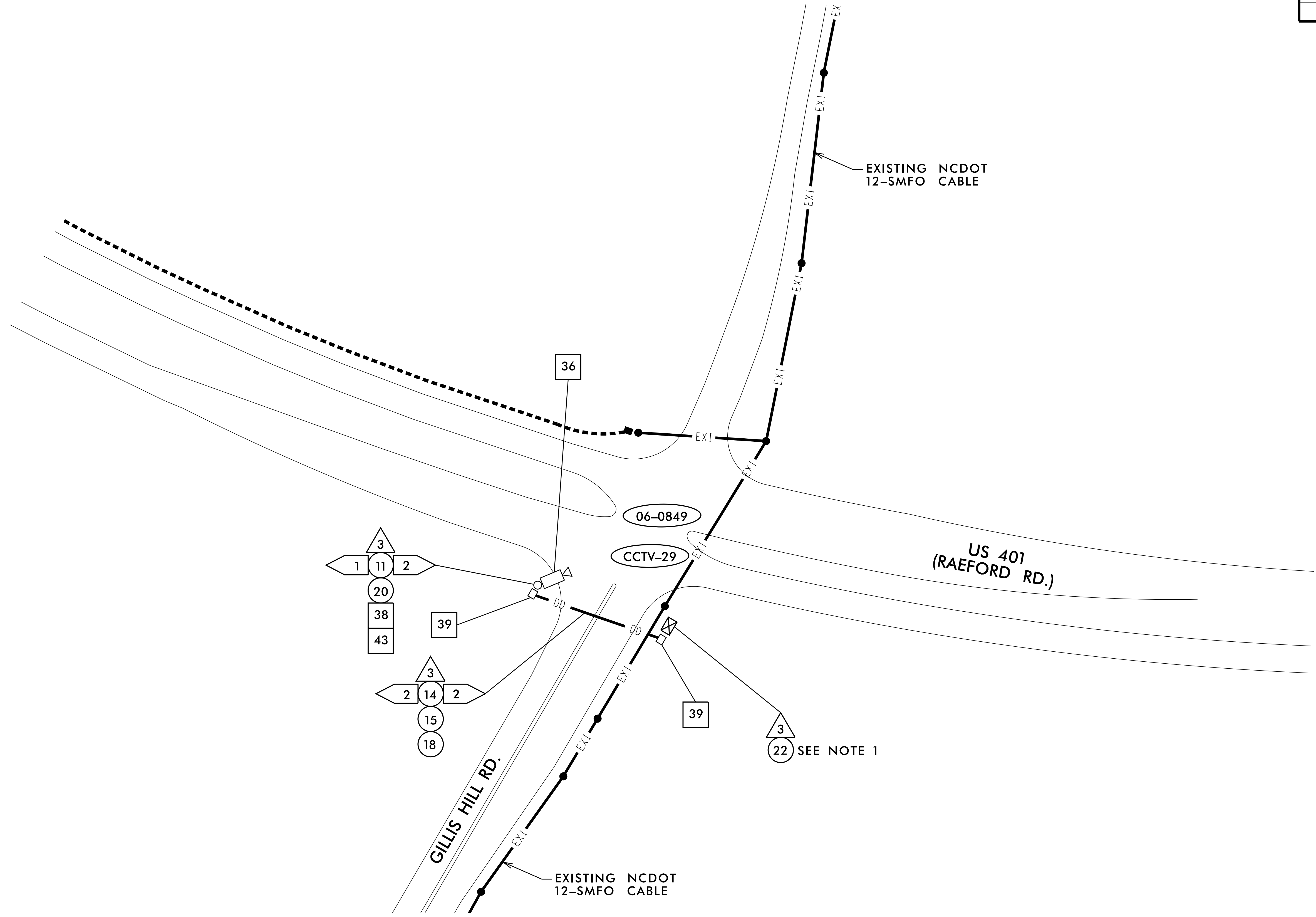

**NOTE:**  
 1. SEE SUMMARY OF WORK TABLES FOR ADDITIONAL CABINET AND COMMUNICATIONS WORK TO BE PERFORMED.

11/15/2016 K:\ARL\TPTD\ITS\01036305 - Fayetteville Sig Sys\Plans\01036305\_ITS\_psh\_42-CCTV29.dgn

**Kimley»Horn**  
 NC License #F-0102  
 421 Fayetteville St., Suite 600  
 Raleigh, NC 27636  
 Tel: (919) 677-2000  
 Fax: (919) 677-2050

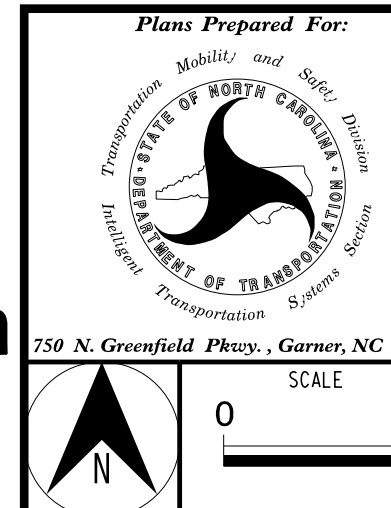

|  |                          |
|--|--------------------------|
| <b>FAYETTEVILLE COMPUTERIZED SIGNAL SYSTEM</b><br><b>PROPOSED CCTV 29 INSTALLATION</b> |                          |
| DIVISION 06  | CUMBERLAND COUNTY        |
| PLAN DATE: NOVEMBER 2016   | REVIEWED BY: K. NICHOLAS |
| PREPARED BY: J. CROSS  | REVIEWED BY: K. SMITH    |
| REVISIONS  | INIT. DATE               |
|  |                          |
|  |                          |
|  |                          |

SEAL

Kevin W. Smith  
 11/15/2016  
 SIGNATURE DATE  
 CADD Filename:

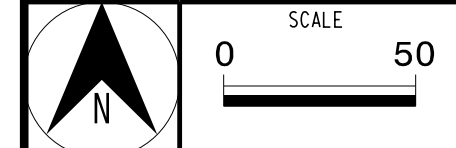

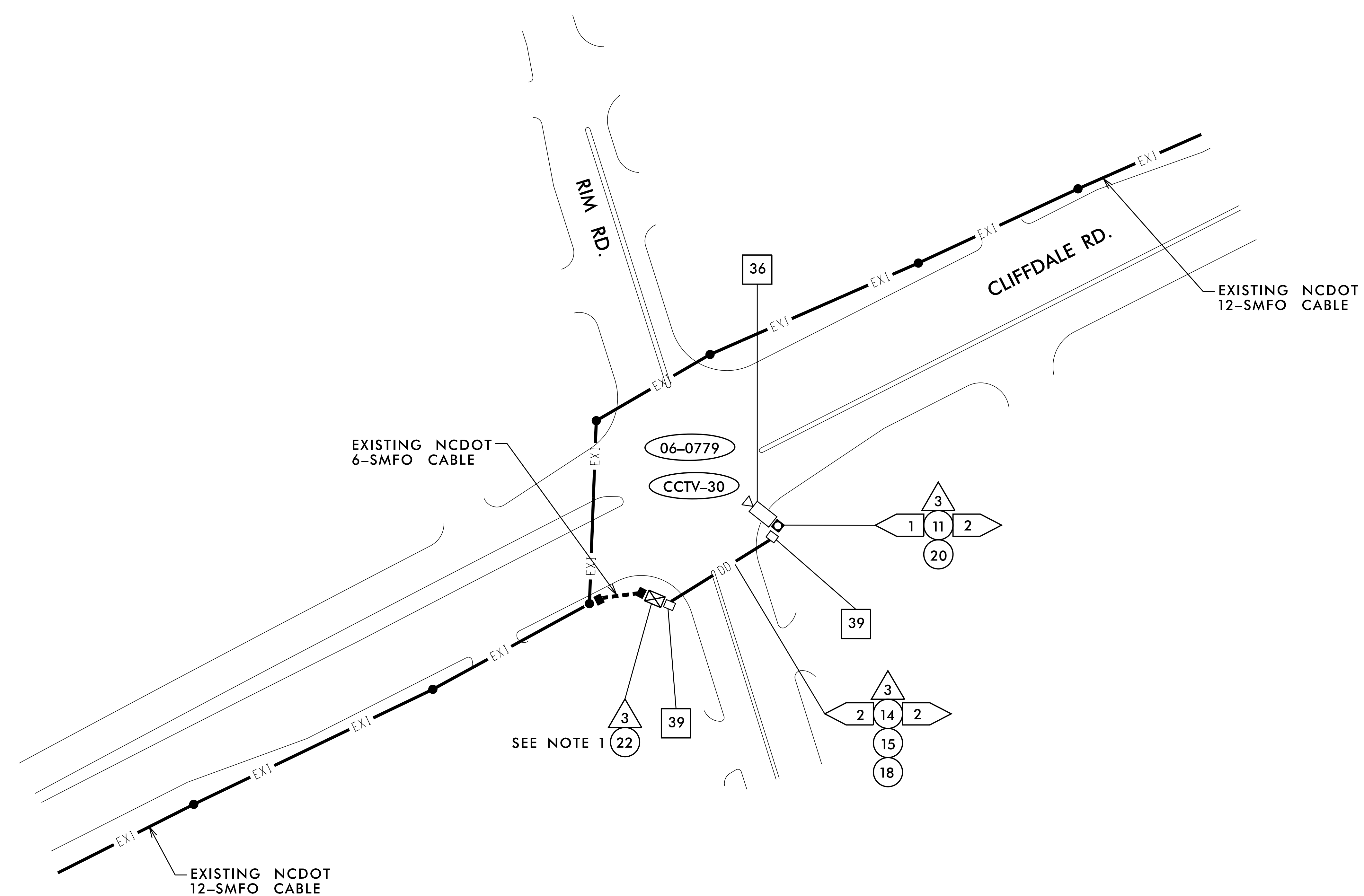

**NOTE:**  
 1. SEE SUMMARY OF WORK TABLES FOR ADDITIONAL CABINET AND COMMUNICATIONS WORK TO BE PERFORMED.

11/15/2016 KARAL\_TPTD\_ITS\_01036305 - Fayetteville Sig Sys Plans\01036305\_ITS\_psh\_43-CCTV30.dgn

**Kimley»Horn**  
 NC License #F-0102  
 421 Fayetteville St., Suite 600  
 Raleigh, NC 27636  
 Tel: (919) 677-2000  
 Fax: (919) 677-2050

|           | <b>FAYETTEVILLE COMPUTERIZED SIGNAL SYSTEM</b><br><b>PROPOSED CCTV 30 INSTALLATION</b> |  |           |  |      |  |  |  |  |
|-----------|--|--|-----------|--|------|--|--|--|--|
|           | DIVISION 06<br>PLAN DATE: NOVEMBER 2016<br>PREPARED BY: J. CROSS                       | CUMBERLAND COUNTY<br>REVIEWED BY: K. NICHOLAS<br>REVIEWED BY: K. SMITH   |           | SEAL<br>030472<br>KEVIN W. SMITH<br>ENGINEER |      |  |  |  |  |
|           | SCALE<br>0 50  | <table border="1"> <thead> <tr> <th>REVISIONS</th> <th>INIT.</th> <th>DATE</th> </tr> </thead> <tbody> <tr> <td> </td> <td> </td> <td> </td> </tr> </tbody> </table> | REVISIONS | INIT.  | DATE |  |  |  | DocuSigned by:<br><br>11/15/2016<br>SIGNATURE DATE<br>CADD Filename: |
| REVISIONS | INIT.  | DATE   |           |  |      |  |  |  |  |
|           |  |  |           |  |      |  |  |  |  |

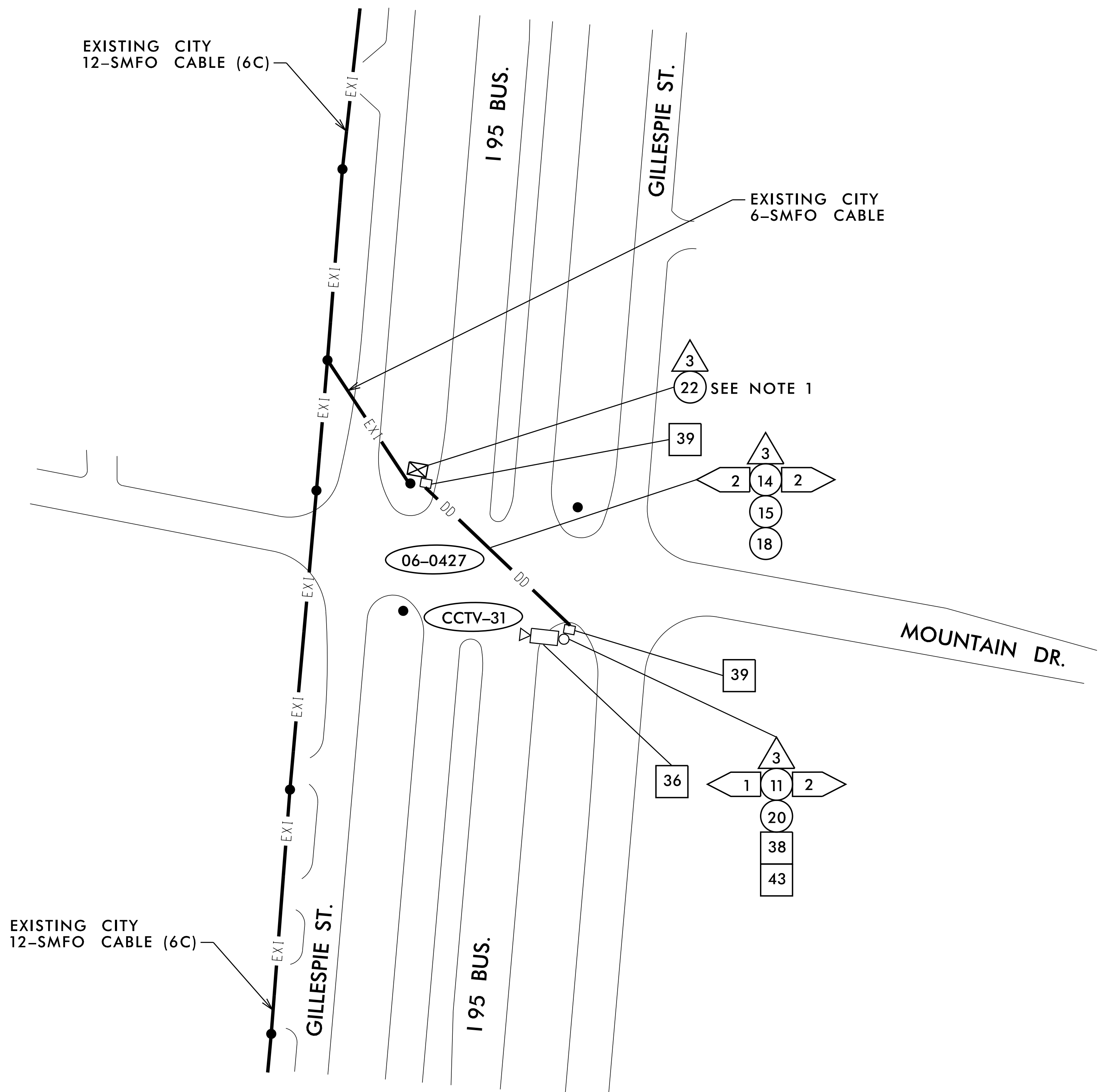

**NOTE:**  
 1. SEE SUMMARY OF WORK TABLES FOR ADDITIONAL CABINET AND COMMUNICATIONS WORK TO BE PERFORMED.

11/15/2016  
 K:\ARL\TPTD\ITS\01036305 - Fayetteville Sig Sys\Plans\01036305\_ITS\_psh\_144-CCTV31.dgn

**Kimley»Horn**  
 NC License #F-0102  
 421 Fayetteville St., Suite 600  
 Raleigh, NC 27636  
 Tel: (919) 677-2000  
 Fax: (919) 677-2050

|  |  |  |                              |
|--|--|--|------------------------------|
|  | <b>FAYETTEVILLE COMPUTERIZED SIGNAL SYSTEM</b> |  | SEAL<br>                     |
|  | <b>PROPOSED CCTV 31 INSTALLATION</b>           |  |                              |
| DIVISION 06      CUMBERLAND COUNTY               |  | PLAN DATE: NOVEMBER 2016      REVIEWED BY: K. NICHOLAS |                              |
| PREPARED BY: J. CROSS      REVIEWED BY: K. SMITH |  | DATE: _____  |                              |
| REVISIONS  | INIT.  | DATE   | SIGNATURE                    |
|  |  |  | KEVIN W. SMITH<br>11/15/2016 |
| SCALE: 0 = 50                                    |  | CADD Filename:   |                              |

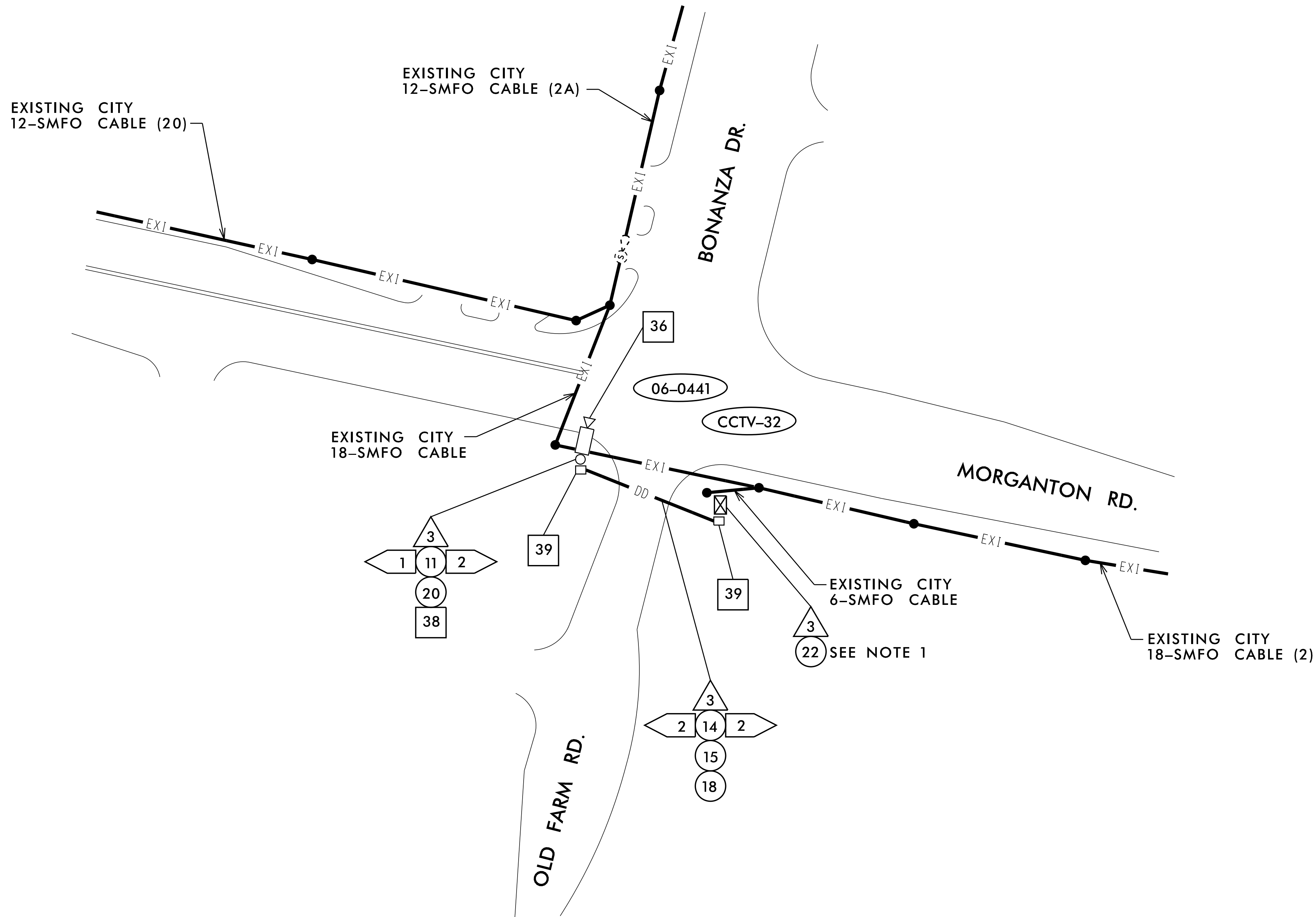

**NOTE:**  
 1. SEE SUMMARY OF WORK TABLES FOR ADDITIONAL CABINET AND COMMUNICATIONS WORK TO BE PERFORMED.

11/15/2016 KARAL\_TPTD\_ITS\_01036305 - Fayetteville Sig Sys Plans\01036305\_ITS\_psh\_45-CCTV32.dgn

**Kimley»Horn**  
 NC License #F-0102  
 421 Fayetteville St., Suite 600  
 Raleigh, NC 27636  
 Tel: (919) 677-2000  
 Fax: (919) 677-2050

|           | <b>FAYETTEVILLE COMPUTERIZED SIGNAL SYSTEM</b><br><b>PROPOSED CCTV 32 INSTALLATION</b>   |  |       |  |  |  |  |                    |
|-----------|--|--|-------|--|--|--|--|--------------------|
|           | DIVISION 06<br>PLAN DATE: NOVEMBER 2016<br>PREPARED BY: J. CROSS   | CUMBERLAND COUNTY<br>REVIEWED BY: K. NICHOLAS<br>REVIEWED BY: K. SMITH |       | SEAL<br>NORTH CAROLINA PROFESSIONAL ENGINEER<br>KEVIN W. SMITH<br>11/15/2016 |  |  |  |                    |
|           | <table border="1"> <thead> <tr> <th>REVISIONS</th> <th>INIT.</th> <th>DATE</th> </tr> </thead> <tbody> <tr> <td> </td> <td> </td> <td> </td> </tr> </tbody> </table> | REVISIONS  | INIT. | DATE   |  |  |  | DocuSigned by:<br> |
| REVISIONS | INIT.  | DATE   |       |  |  |  |  |                    |
|           |  |  |       |  |  |  |  |                    |

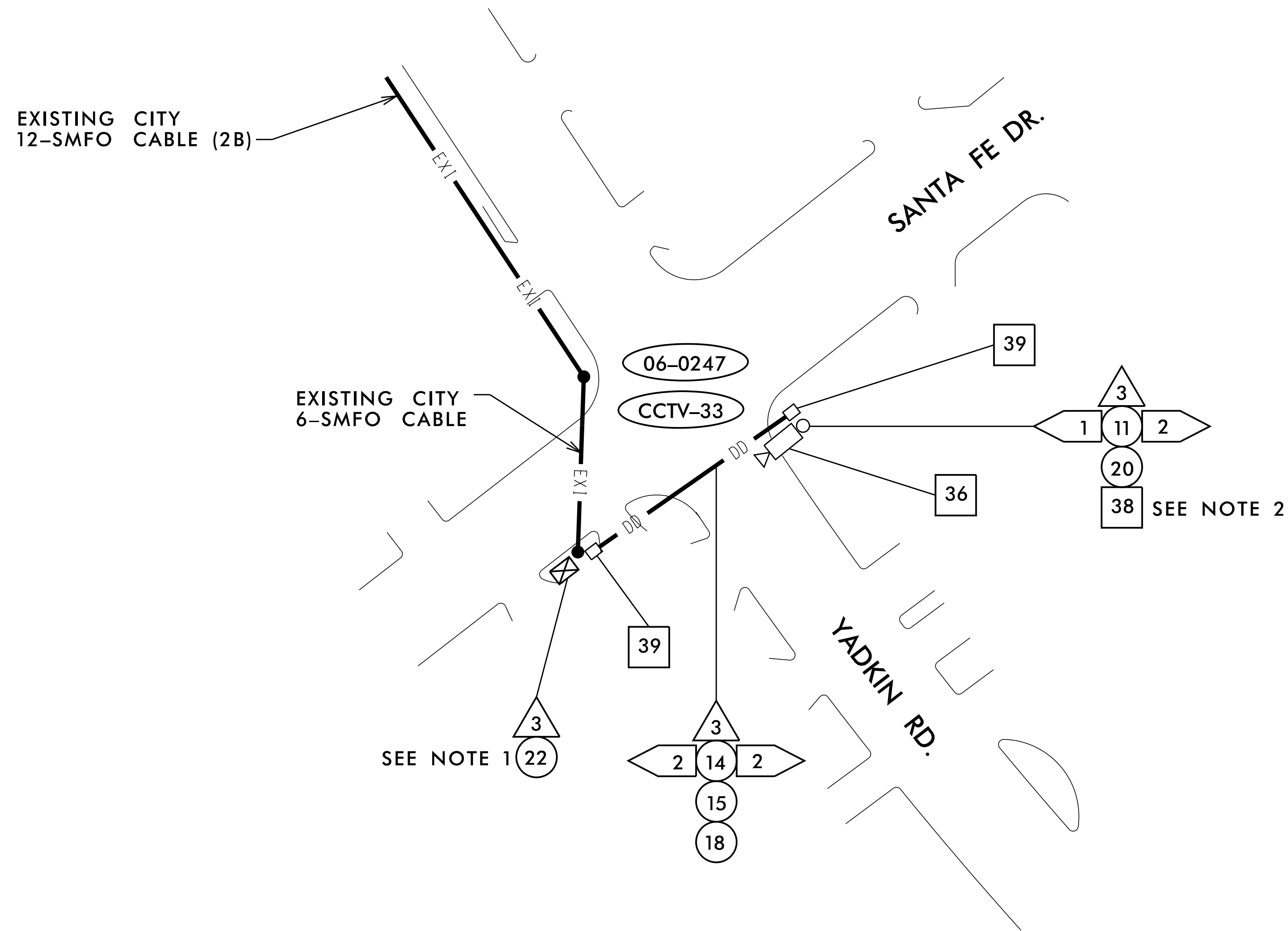

**NOTE:**

1. SEE SUMMARY OF WORK TABLES FOR ADDITIONAL CABINET AND COMMUNICATIONS WORK TO BE PERFORMED.
2. INSTALL NEW CCTV WOOD POLE AND INTERCEPT SIGNAL SPAN WIRE COMING FROM SOUTH QUADRANT.

11/15/2016 K:\ARL\TPTD\ITS\01036305 - Fayetteville Sig Sys\Plans\01036305\_ITS\_psh\_46-CCTV33.dgn

**Kimley»Horn**  
 NC License #F-0102  
 421 Fayetteville St., Suite 600  
 Raleigh, NC 27636  
 Tel: (919) 677-2000  
 Fax: (919) 677-2050

|                          |  |                       |                              |
|--------------------------|--|-----------------------|------------------------------|
|                          | <b>FAYETTEVILLE COMPUTERIZED SIGNAL SYSTEM</b><br><b>PROPOSED CCTV 33 INSTALLATION</b> |                       |                              |
|                          | DIVISION 06  | CUMBERLAND COUNTY     |                              |
| PLAN DATE: NOVEMBER 2016 | REVIEWED BY: K. NICHOLAS   | PREPARED BY: J. CROSS | REVIEWED BY: K. SMITH        |
| REVISIONS                | INIT.  | DATE                  | SIGNATURE                    |
|                          |  |                       | KEVIN W. SMITH<br>11/15/2016 |

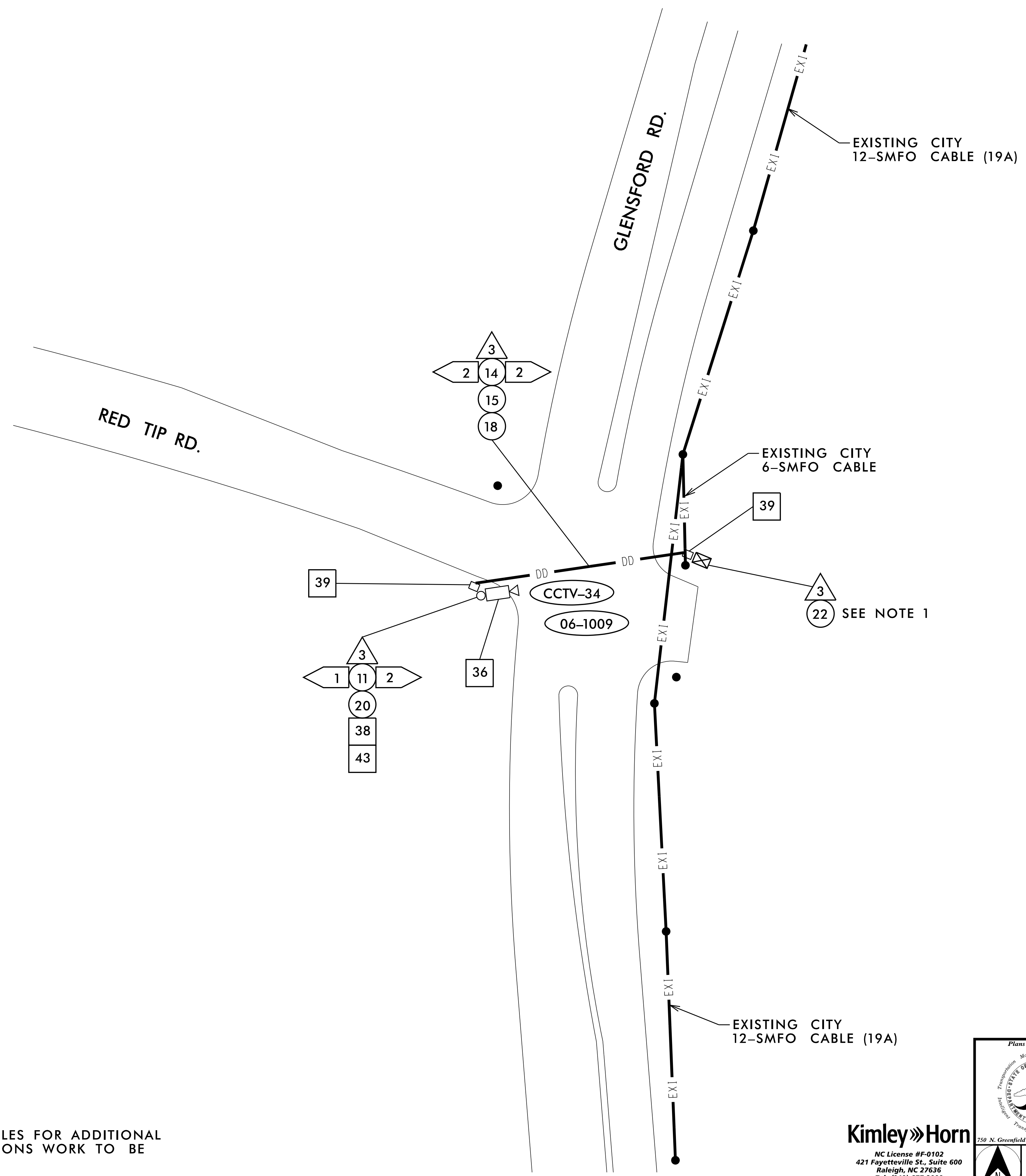

**NOTE:**  
 1. SEE SUMMARY OF WORK TABLES FOR ADDITIONAL CABINET AND COMMUNICATIONS WORK TO BE PERFORMED.

11/15/2016 K:\ARL\TPTD\ITS\01036305 - Fayetteville Sig Sys\Plans\01036305\_ITS\_psh\_147-CCTV34.dgn

**Kimley»Horn**  
 NC License #F-0102  
 421 Fayetteville St., Suite 600  
 Raleigh, NC 27636  
 Tel: (919) 677-2000  
 Fax: (919) 677-2050

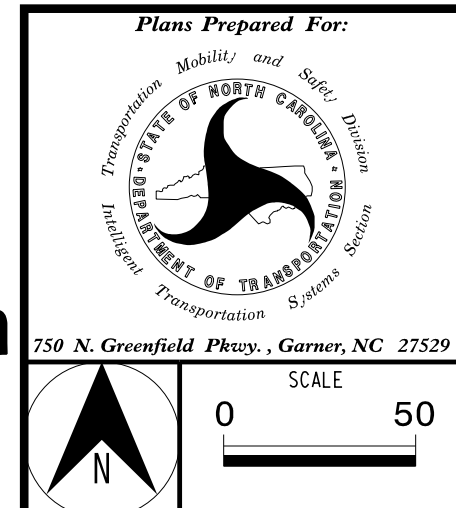

|  |                          |
|--|--------------------------|
| <b>FAYETTEVILLE COMPUTERIZED SIGNAL SYSTEM</b><br><b>PROPOSED CCTV 34 INSTALLATION</b> |                          |
| DIVISION 06  | CUMBERLAND COUNTY        |
| PLAN DATE: NOVEMBER 2016   | REVIEWED BY: K. NICHOLAS |
| PREPARED BY: J. CROSS  | REVIEWED BY: K. SMITH    |
| REVISIONS  | INIT. DATE               |
|  |                          |
|  |                          |
|  |                          |

SEAL  
 NORTH CAROLINA PROFESSIONAL ENGINEER  
 KEVIN W. SMITH  
 SEAL 030472  
 11/15/2016  
 CADD Filename:

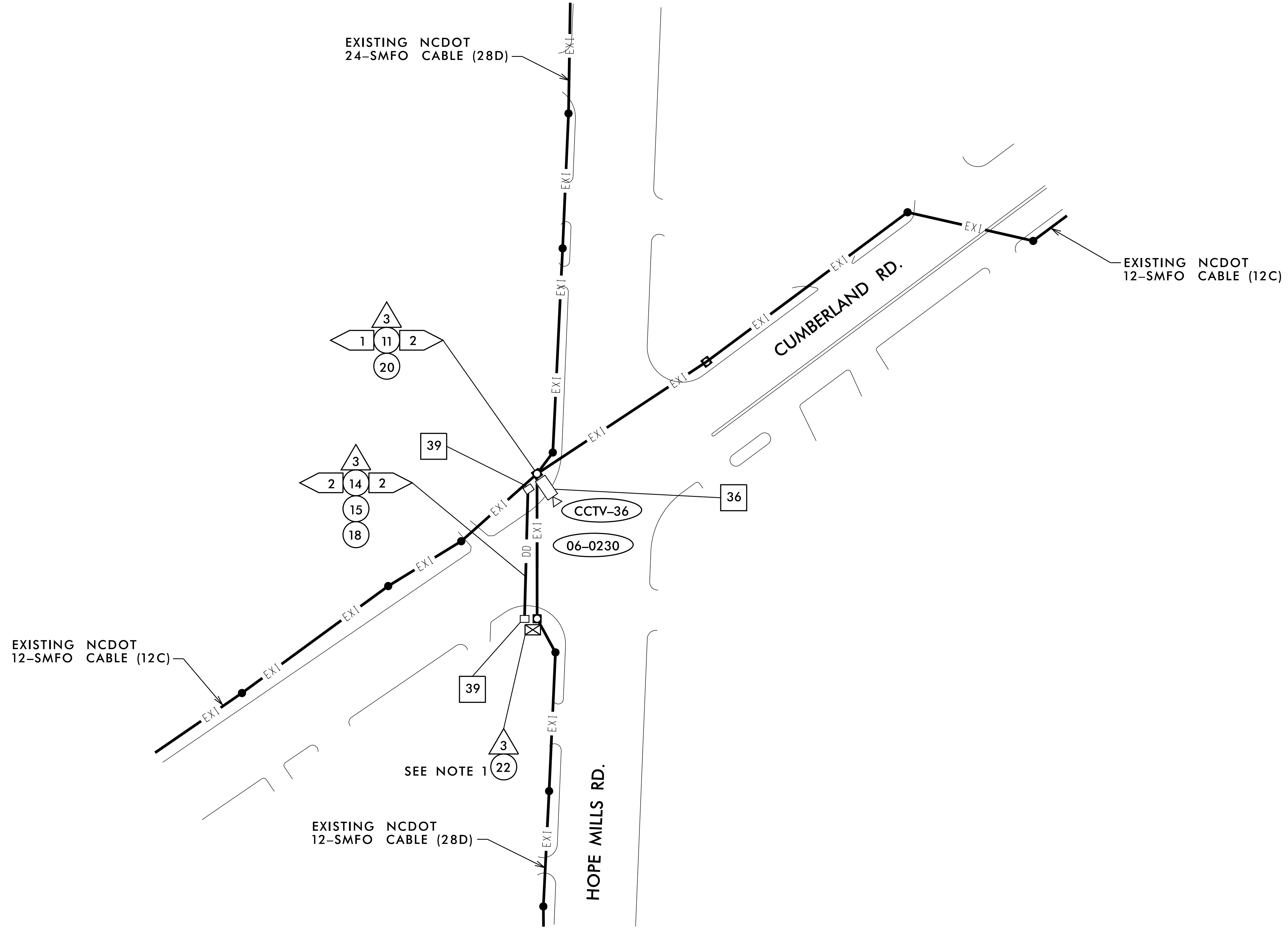

EXISTING NCDOT  
12-SMFO CABLE (12C)

EXISTING NCDOT  
24-SMFO CABLE (28D)

EXISTING NCDOT  
12-SMFO CABLE (12C)

EXISTING NCDOT  
12-SMFO CABLE (28D)

SEE NOTE 1

**NOTE:**  
1. SEE SUMMARY OF WORK TABLES FOR ADDITIONAL CABINET AND COMMUNICATIONS WORK TO BE PERFORMED.

11/15/2016 K:\ARL\TPTD\ITS\01036305 - Fayetteville Sig Sys\Plans\01036305\_ITS\_psh\_48-CCTV36.dgn

**Kimley»Horn**  
NC License #F-0102  
421 Fayetteville St., Suite 600  
Raleigh, NC 27636  
Tel: (919) 677-2000  
Fax: (919) 677-2050

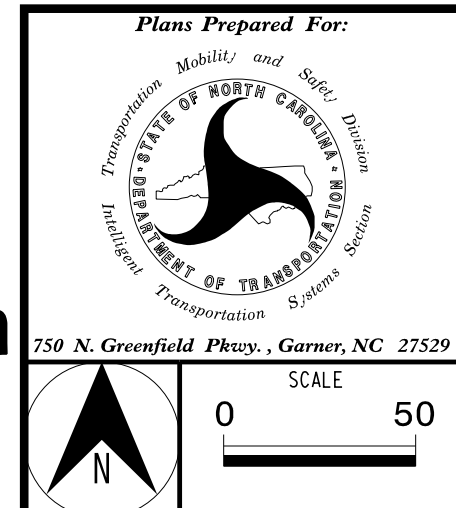

|   |                          |
|---|--------------------------|
| FAYETTEVILLE COMPUTERIZED SIGNAL SYSTEM |                          |
| PROPOSED CCTV 36 INSTALLATION           |                          |
| DIVISION 06                             | CUMBERLAND COUNTY        |
| PLAN DATE: NOVEMBER 2016                | REVIEWED BY: K. NICHOLAS |
| PREPARED BY: J. CROSS                   | REVIEWED BY: K. SMITH    |
| REVISIONS                               | INIT. DATE               |
|   |                          |
|   |                          |
|   |                          |

SEAL  
NORTH CAROLINA PROFESSIONAL ENGINEER  
SEAL 030472  
KEVIN W. SMITH  
11/15/2016  
SIGNATURE DATE  
CADD Filename:

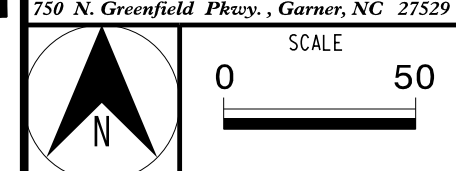



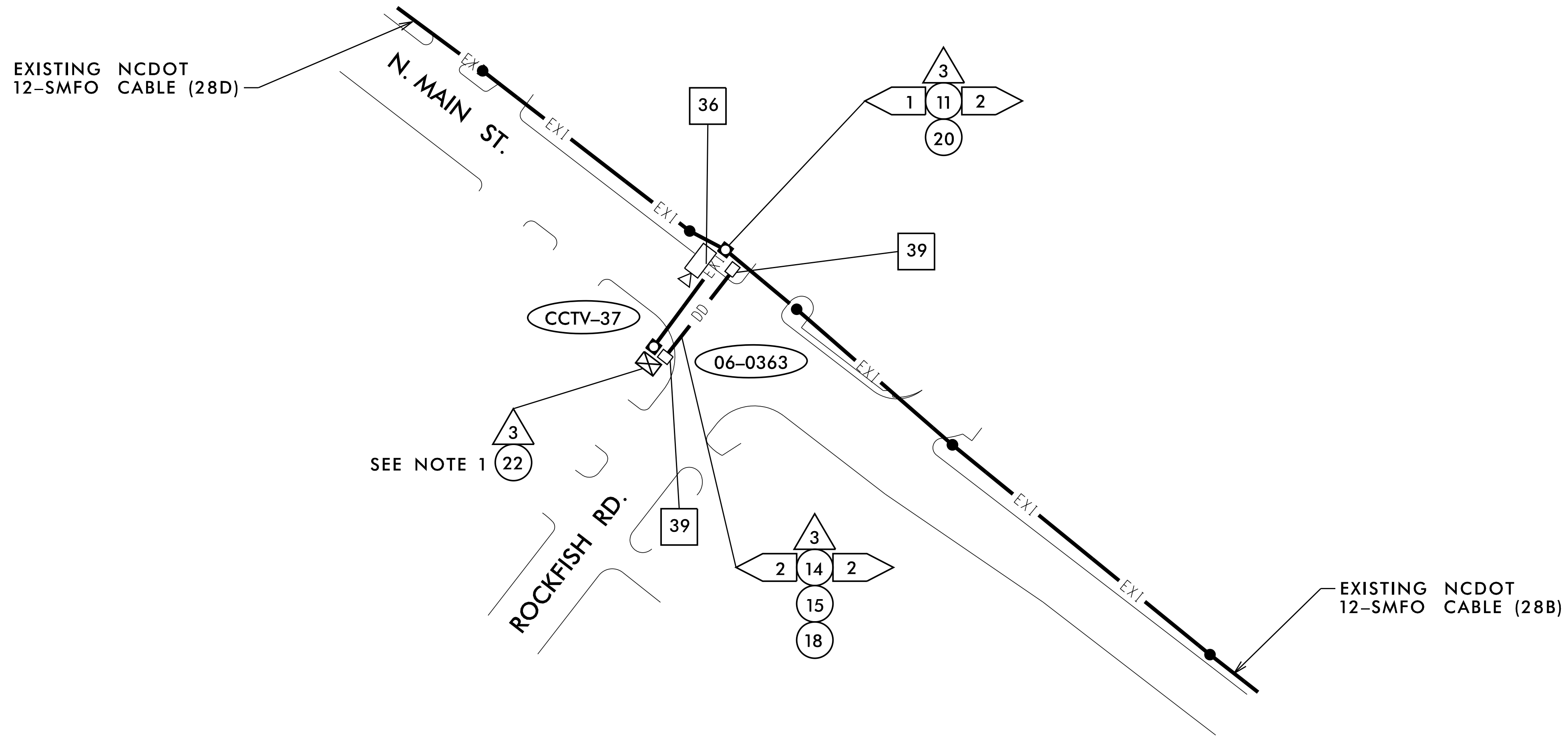

**NOTE:**  
 1. SEE SUMMARY OF WORK TABLES FOR ADDITIONAL CABINET AND COMMUNICATIONS WORK TO BE PERFORMED.

11/15/2016 KARAL\_TPTD\_ITS\_01036305 - Fayetteville Sig Sys\Plans\01036305\_ITS\_psh\_49-CCTV37.dgn

**Kimley»Horn**  
 NC License #F-0102  
 421 Fayetteville St., Suite 600  
 Raleigh, NC 27636  
 Tel: (919) 677-2000  
 Fax: (919) 677-2050

|                          |  |                   |  |
|--------------------------|--|-------------------|--|
|                          | <b>FAYETTEVILLE COMPUTERIZED SIGNAL SYSTEM</b><br><b>PROPOSED CCTV 37 INSTALLATION</b> |                   |  |
|                          | DIVISION 06  | CUMBERLAND COUNTY |  |
| PLAN DATE: NOVEMBER 2016 | REVIEWED BY: K. NICHOLAS   |                   |  |
| PREPARED BY: J. CROSS    | REVIEWED BY: K. SMITH  |                   |  |
| REVISIONS                | INIT.  | DATE              |  |
|                          |  |                   |  |
|                          |  |                   |  |
|                          |  |                   |  |
|                          |  |                   |  |

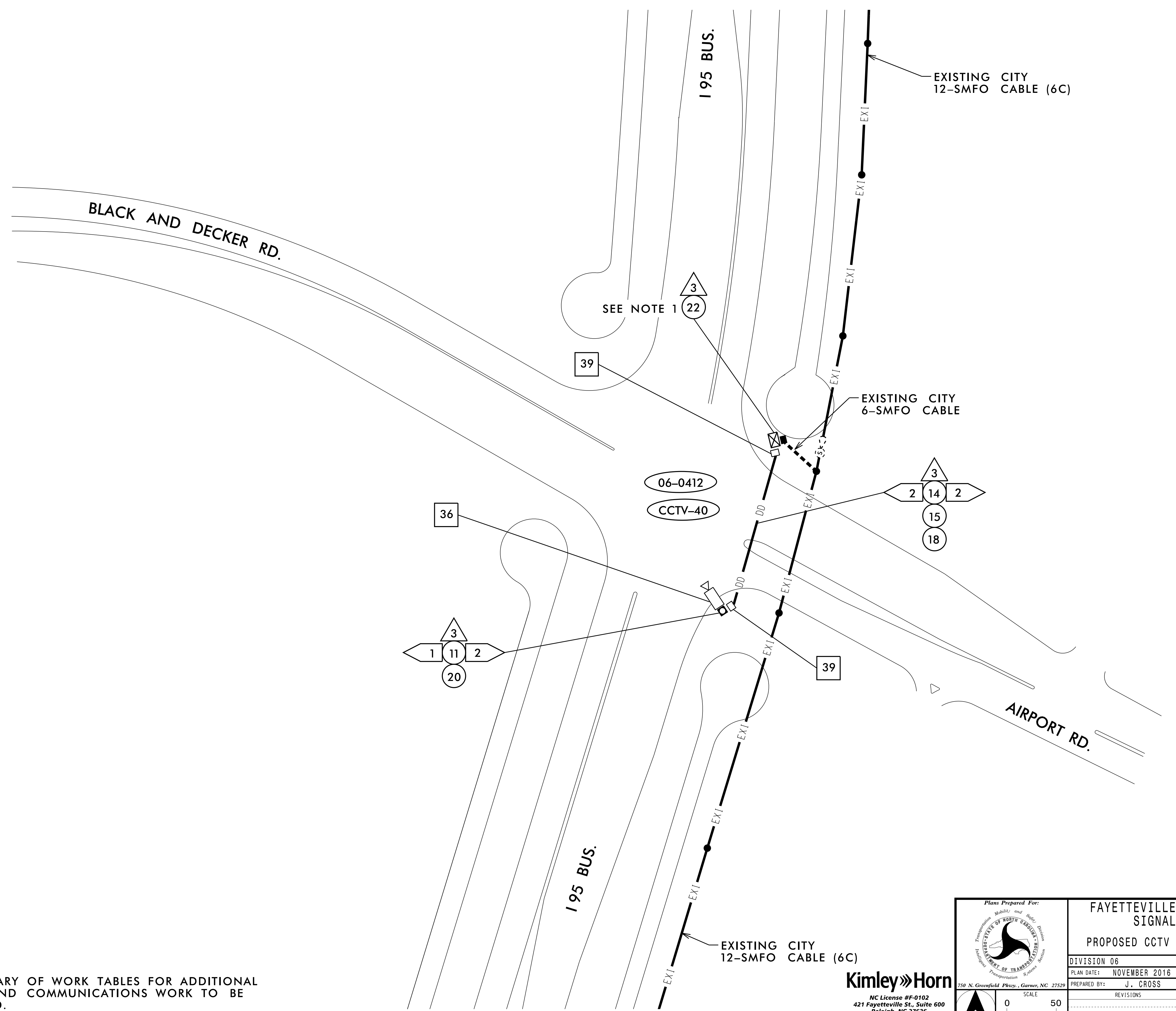

**NOTE:**  
 1. SEE SUMMARY OF WORK TABLES FOR ADDITIONAL CABINET AND COMMUNICATIONS WORK TO BE PERFORMED.

11/15/2016 K:\ARL\TPTD\ITS\01036305 - Fayetteville Sig Sys\Plans\01036305\_ITS\_psh\_b0-CCTV40.dgn

**Kimley»Horn**  
 NC License #F-0102  
 421 Fayetteville St., Suite 600  
 Raleigh, NC 27636  
 Tel: (919) 677-2000  
 Fax: (919) 677-2050

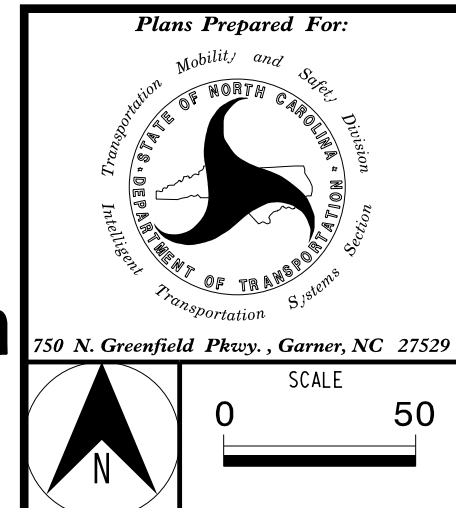

|   |                                  |   |
|---|----------------------------------|---|
| <b>FAYETTEVILLE COMPUTERIZED SIGNAL SYSTEM</b><br><b>PROPOSED CCTV 40 INSTALLATION</b>  |                                  | SEAL<br>NORTH CAROLINA PROFESSIONAL ENGINEER<br>KEVIN W. SMITH<br>SEAL 030472 |
| DIVISION 06 CUMBERLAND COUNTY<br>PLAN DATE: NOVEMBER 2016<br>PREPARED BY: J. CROSS<br>REVIEWED BY: K. NICHOLAS<br>REVIEWED BY: K. SMITH |                                  |   |
| REVISIONS<br>_____<br>_____<br>_____  | INIT.<br>_____<br>_____<br>_____ | DATE<br>_____<br>_____<br>_____   |
| CADD Filename:  |                                  | 11/15/2016  |

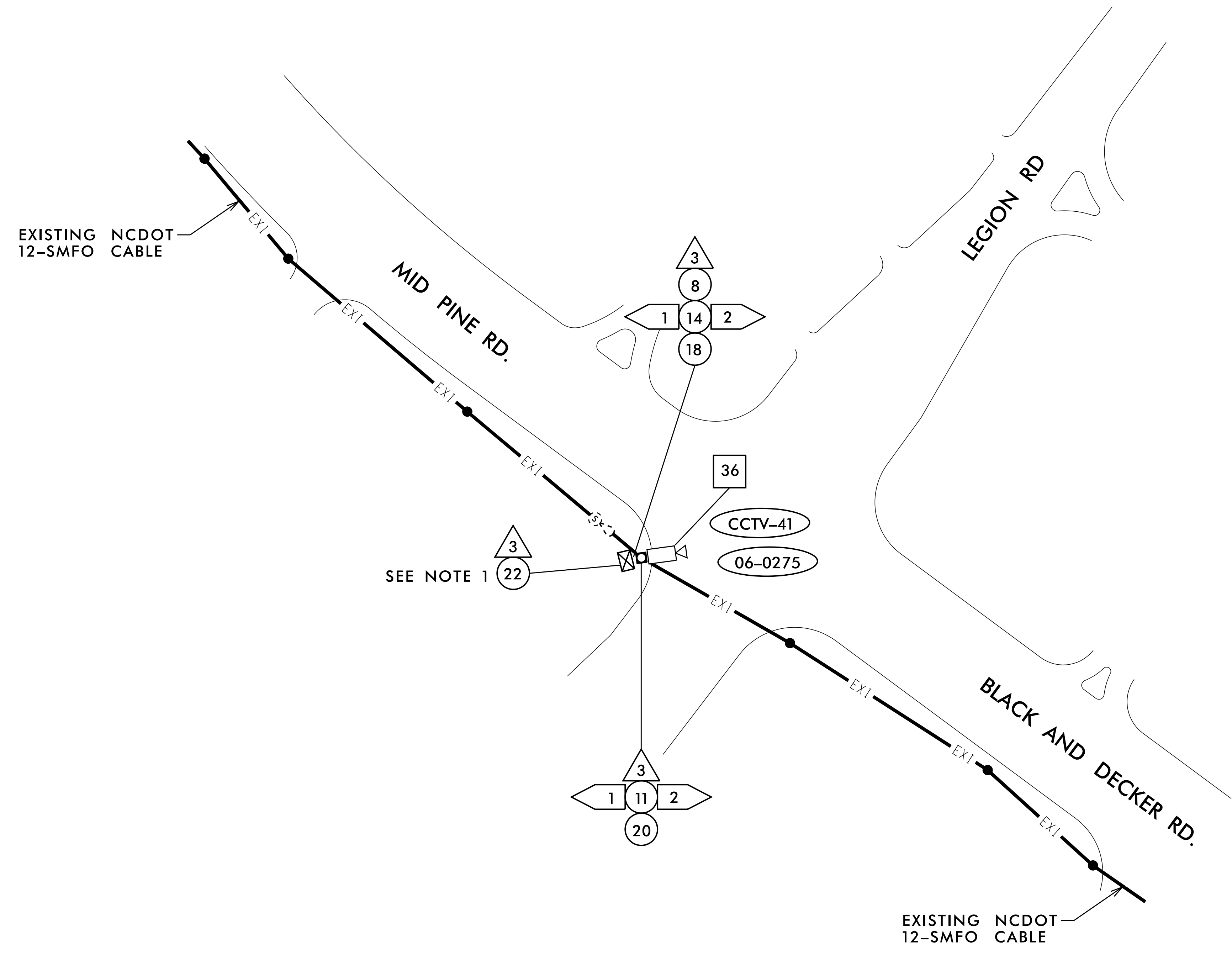

**NOTE:**  
 1. SEE SUMMARY OF WORK TABLES FOR ADDITIONAL CABINET AND COMMUNICATIONS WORK TO BE PERFORMED.

11/15/2016 K:\ARL\TPTD\ITS\01036305 - Fayetteville Sig Sys\Plans\01036305\_ITS\_psh\_IBI-CCTV41.dgn

**Kimley»Horn**  
 NC License #F-0102  
 421 Fayetteville St., Suite 600  
 Raleigh, NC 27636  
 Tel: (919) 677-2000  
 Fax: (919) 677-2050

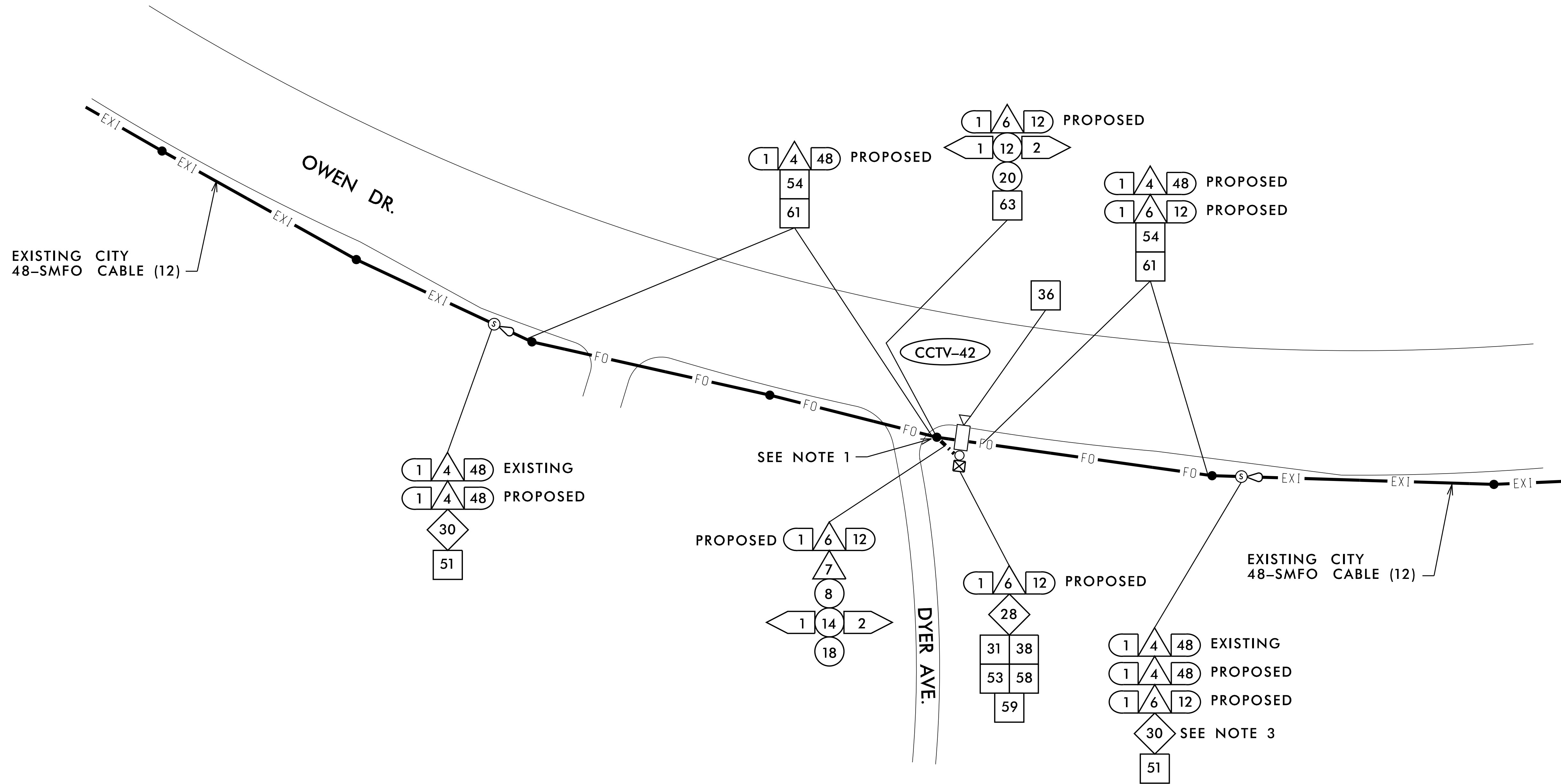

|                          |  |                   |            |
|--------------------------|--|-------------------|------------|
|                          | <b>FAYETTEVILLE COMPUTERIZED SIGNAL SYSTEM</b><br><b>PROPOSED CCTV 41 INSTALLATION</b> |                   |            |
|                          | DIVISION 06  | CUMBERLAND COUNTY |            |
| PLAN DATE: NOVEMBER 2016 | REVIEWED BY: K. NICHOLAS   |                   |            |
| PREPARED BY: J. CROSS    | REVIEWED BY: K. SMITH  |                   |            |
| REVISIONS                | INIT.  | DATE              |            |
|                          |  |                   |            |
| DocuSigned by:<br>       |  |                   | 11/15/2016 |
| CADD Filename:           |  |                   |            |



**NOTE:**  
 1. CUT EXISTING CITY 48-SMFO CABLE AT THIS POLE. BACKPULL BOTH ENDS OF CABLE TO NEW SPlice ENCLOSURES SHOWN ON THIS SHEET. DO NOT CUT EXISTING PWC 144-SMFO CABLE THAT IS LASHED TO CITY CABLE AND MESSENGER CABLE.  
 2. SPlice LIKE BUFFER TUBES AND FIBERS IN EXISTING CABLE TO PROPOSED CABLE.  
 3. SPlice EXISTING CABLE TO PROPOSED CABLES ACCORDING TO SPlice DETAIL ON SHEET ITS-198.

11/15/2016 K:\ARL\TPTD\ITS\01036305 - Fayetteville Sig Sys\Plans\01036305\_ITS\_psh\_52-CCTV42.dgn

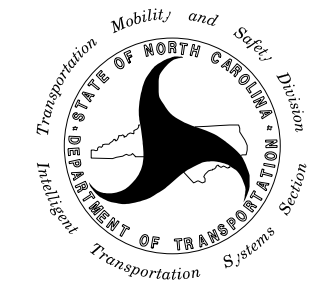
**Kimley»Horn**  
 NC License #F-0102  
 421 Fayetteville St., Suite 600  
 Raleigh, NC 27636  
 Tel: (919) 677-2000  
 Fax: (919) 677-2050

|   |   |                         |   |
|---|---|-------------------------|---|
| <br>Plans Prepared For:<br>Transportation Mobility and Safety Division<br>DEPARTMENT OF TRANSPORTATION<br>250 N. Greenfield Place - Garner, NC 27529 | <b>FAYETTEVILLE COMPUTERIZED SIGNAL SYSTEM</b><br>PROPOSED CCTV 42 INSTALLATION   |                         | SEAL<br><br>KEVIN W. SMITH<br>ENGINEER<br>No. 030472 |
|   | DIVISION 06 CUMBERLAND COUNTY<br>PLAN DATE: NOVEMBER 2016 REVIEWED BY: K. NICHOLAS<br>PREPARED BY: J. CROSS REVIEWED BY: K. SMITH |                         |   |
|    | SCALE<br>0 50   | REVISIONS<br>INIT. DATE | SIGNATURE<br>DATE<br>11/15/2016<br>CADD Filename:   |

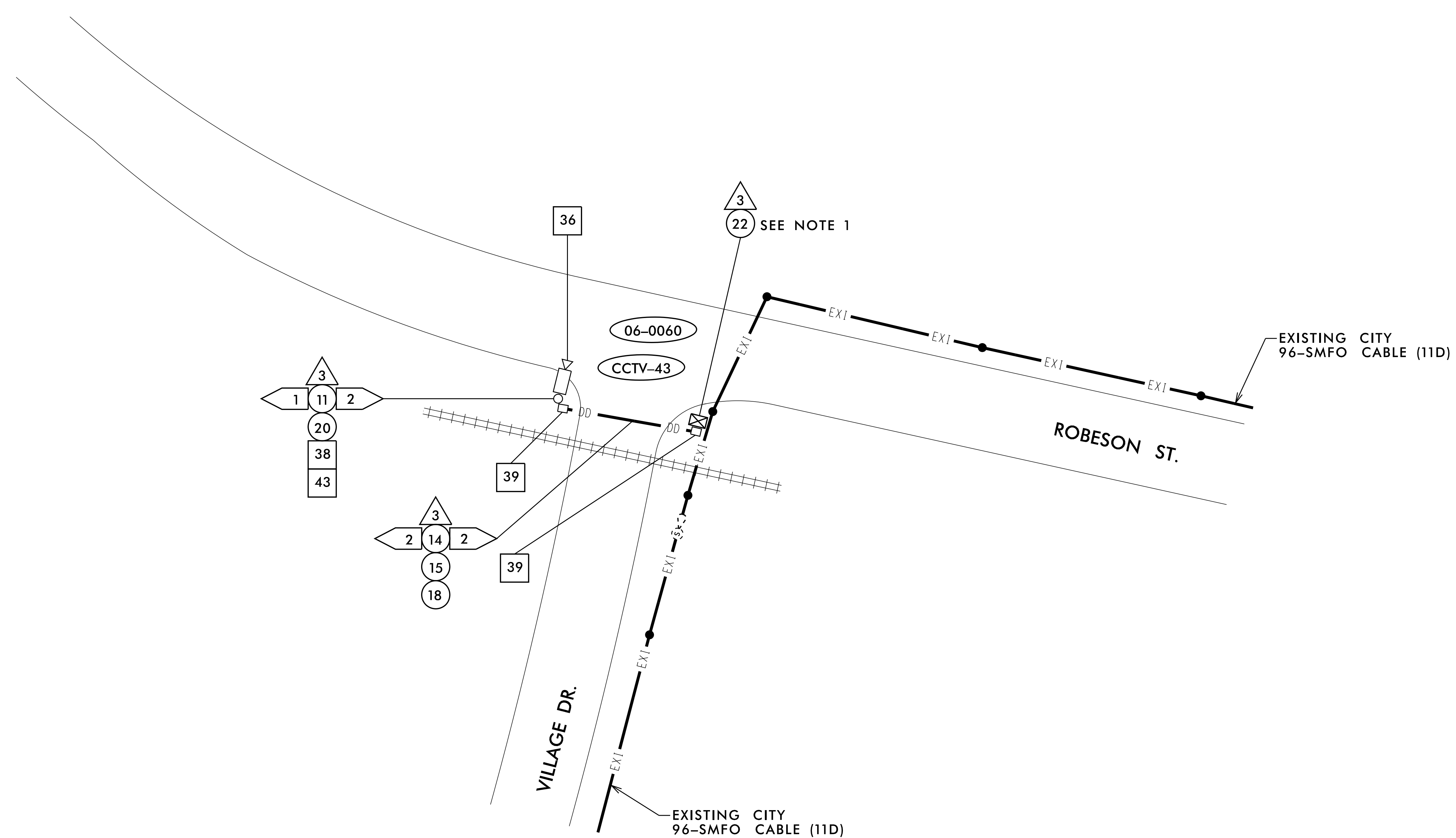

**NOTE:**  
 1. SEE SUMMARY OF WORK TABLES FOR ADDITIONAL CABINET AND COMMUNICATIONS WORK TO BE PERFORMED.

11/15/2016 KARAL\_TPTD\_ITS\_01036305 - Fayetteville\_Sig\_Sys\Plans\01036305\_ITS\_psh\_63-CCTV43.dgn

**Kimley»Horn**  
 NC License #F-0102  
 421 Fayetteville St., Suite 600  
 Raleigh, NC 27636  
 Tel: (919) 677-2000  
 Fax: (919) 677-2050

|   |   |                                      |                             |
|---|---|--------------------------------------|-----------------------------|
|   | <b>FAYETTEVILLE COMPUTERIZED SIGNAL SYSTEM</b>    |                                      |                             |
|   | DIVISION 06 CUMBERLAND COUNTY                     |                                      |                             |
| PLAN DATE: NOVEMBER 2016<br>PREPARED BY: J. CROSS | REVIEWED BY: K. NICHOLAS<br>REVIEWED BY: K. SMITH | SEAL<br>KEVIN W. SMITH<br>11/15/2016 |                             |
| REVISIONS<br>_____<br>_____                       | INIT.<br>_____<br>_____                           | DATE<br>_____<br>_____               | SIGNATURE<br>_____<br>_____ |

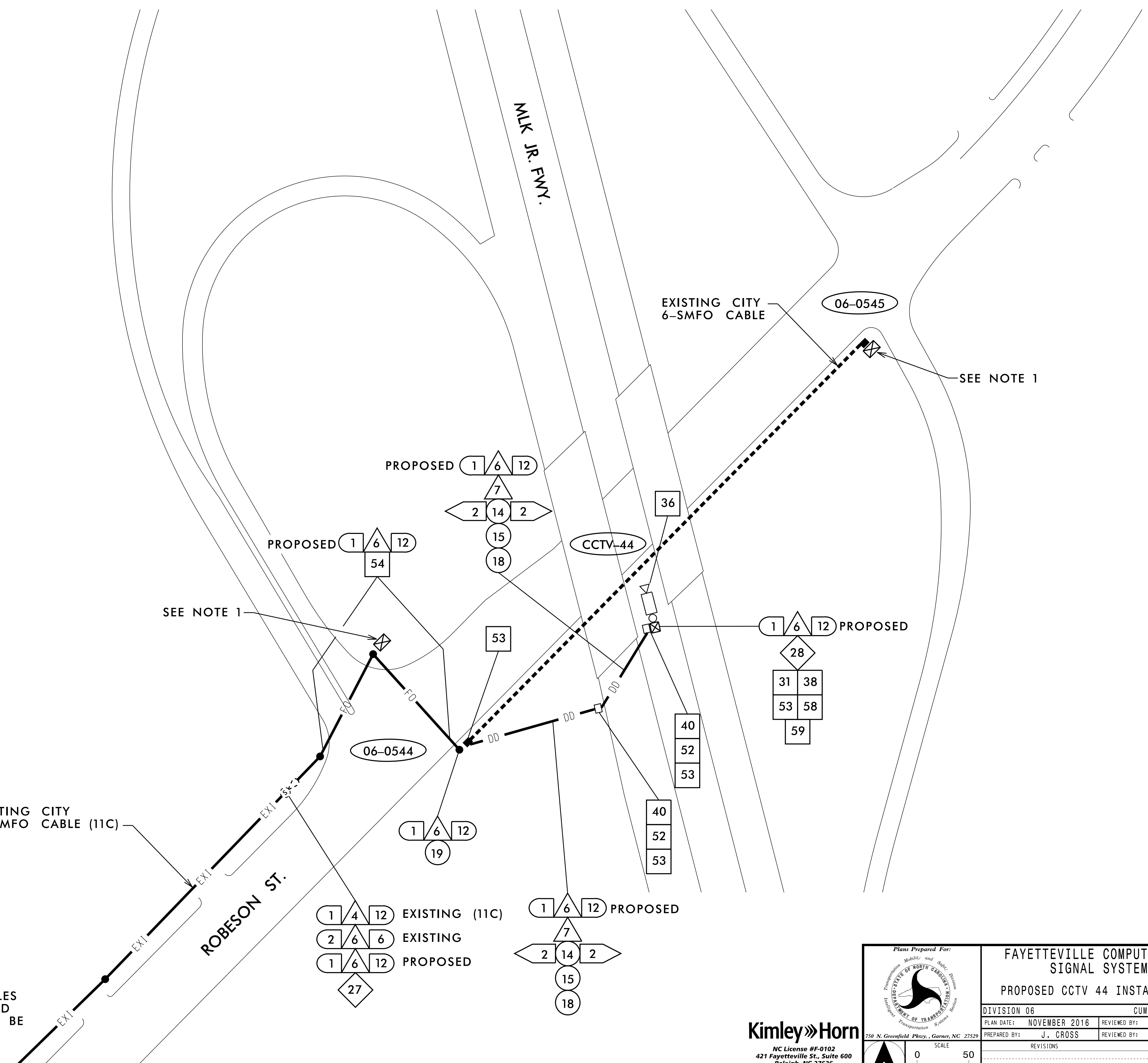

NOTE:  
 1. SEE SUMMARY OF WORK TABLES FOR ADDITIONAL CABINET AND COMMUNICATIONS WORK TO BE PERFORMED.

|   |   |   |                         |
|---|---|---|-------------------------|
| <br>Plans Prepared For:<br>FAYETTEVILLE COMPUTERIZED SIGNAL SYSTEM<br>PROPOSED CCTV 44 INSTALLATION | DIVISION 06 CUMBERLAND COUNTY                     |   |                         |
|   | PLAN DATE: NOVEMBER 2016<br>PREPARED BY: J. CROSS | REVIEWED BY: K. NICHOLAS<br>REVIEWED BY: K. SMITH |                         |
| REVISIONS<br>INIT. DATE   | REVISIONS<br>INIT. DATE                           | REVISIONS<br>INIT. DATE                           | REVISIONS<br>INIT. DATE |

Kimley Horn  
 NC License #F-0102  
 421 Fayetteville St., Suite 600  
 Raleigh, NC 27636  
 Tel: (919) 677-2000  
 Fax: (919) 677-2050

250 N. Greenfield Place - Garner, NC 27529  
 SCALE 0 50  
 DATE 11/15/2016  
 CADD File name:

11/15/2016  
 K:\ARL\TPTD\ITS\01036305 - Fayetteville Sig Sys\Plans\01036305\_ITS\_psh\_154-CCTV44.dgn

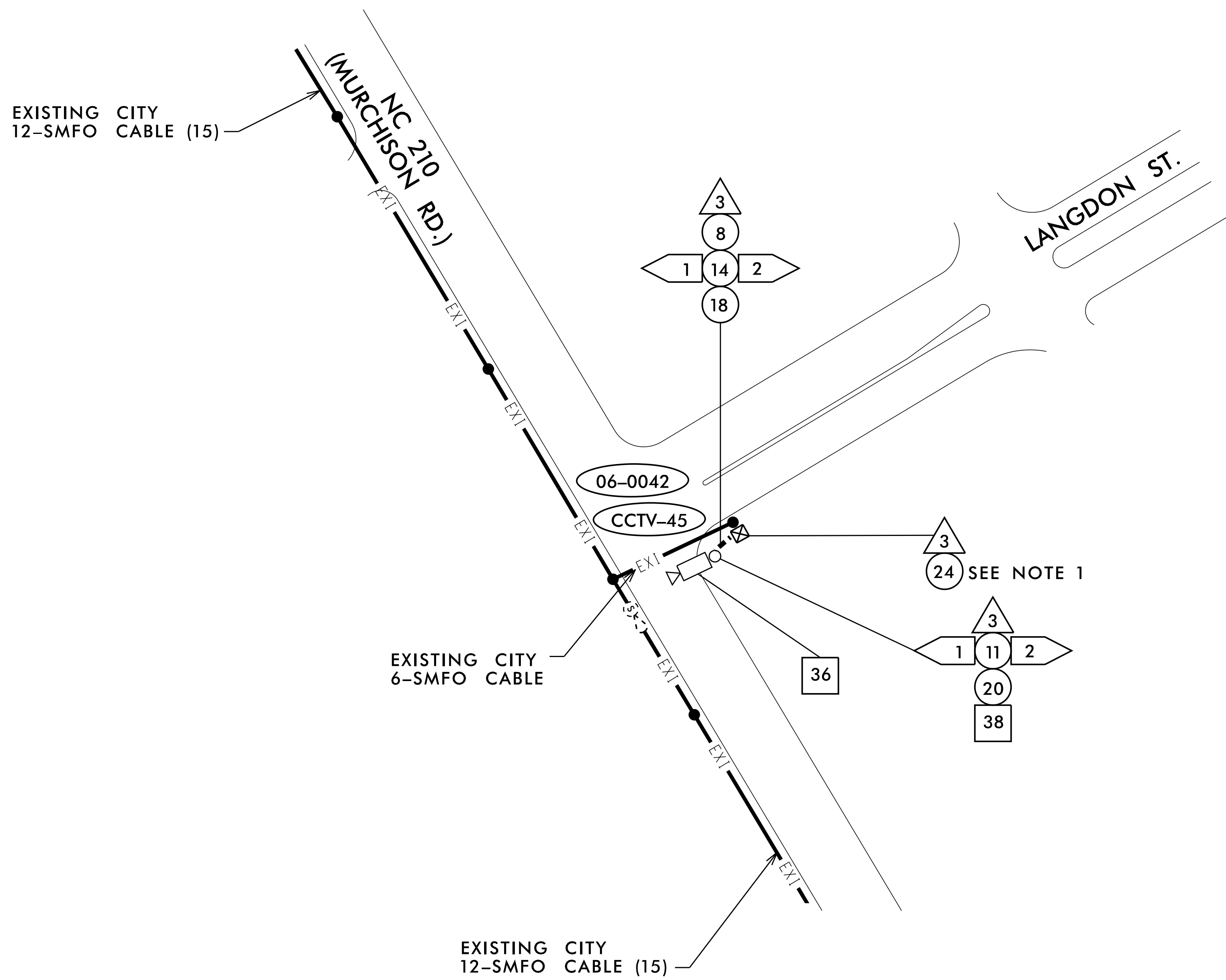

**NOTE:**  
 1. SEE SUMMARY OF WORK TABLES FOR ADDITIONAL CABINET AND COMMUNICATIONS WORK TO BE PERFORMED.

11/15/2016  
 K:\ARL\TPTD\ITS\01036305 - Fayetteville Sig Sys\Plans\01036305\_ITS\_psh\_b5-CCTV45.dgn

**Kimley»Horn**  
 NC License #F-0102  
 421 Fayetteville St., Suite 600  
 Raleigh, NC 27636  
 Tel: (919) 677-2000  
 Fax: (919) 677-2050

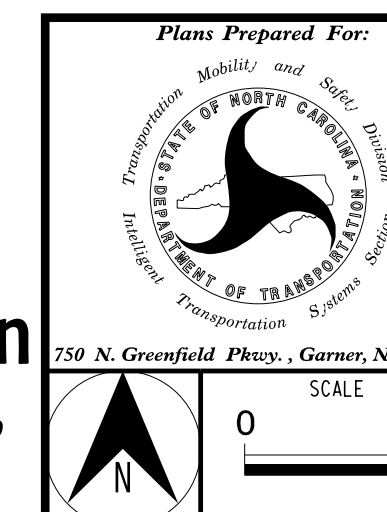

|  |                          |
|--|--------------------------|
| <b>FAYETTEVILLE COMPUTERIZED SIGNAL SYSTEM</b><br><b>PROPOSED CCTV 45 INSTALLATION</b> |                          |
| DIVISION 06  | CUMBERLAND COUNTY        |
| PLAN DATE: NOVEMBER 2016   | REVIEWED BY: K. NICHOLAS |
| PREPARED BY: J. CROSS  | REVIEWED BY: K. SMITH    |
| REVISIONS  | INIT. DATE               |
|  |                          |
|  |                          |
|  |                          |

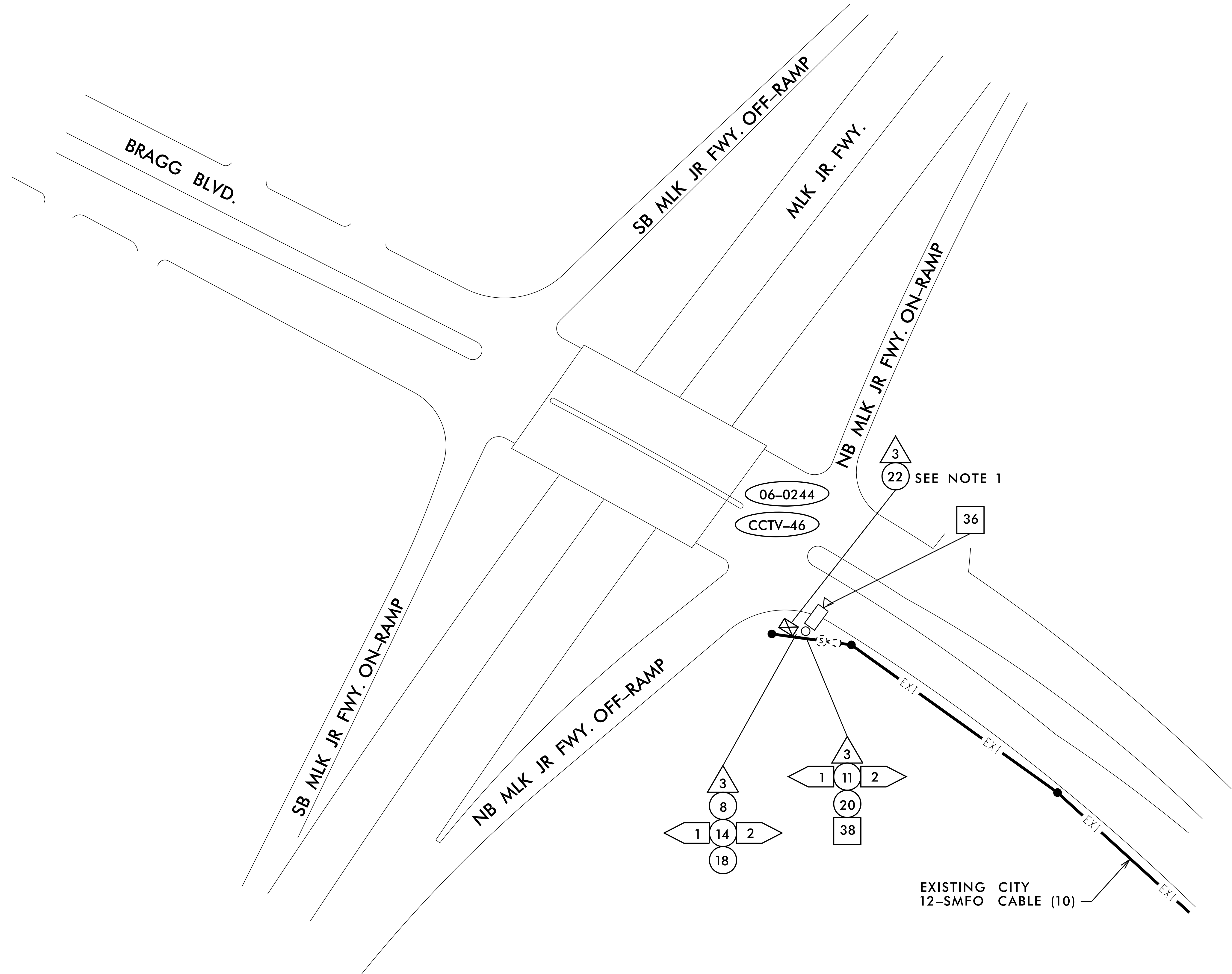

|                |            |
|----------------|------------|
| SEAL           | DATE       |
|                | 11/15/2016 |
| SIGNATURE      | DATE       |
| Kevin W. Smith |            |
| CADD Filename: |            |



11/15/2016 K:\ARL\TPTD\ITS\01036305 - Fayetteville Sig Sys\Plans\01036305\_ITS\_psh\_b6-CCTV46.dgn

**NOTE:**  
 1. SEE SUMMARY OF WORK TABLES FOR ADDITIONAL CABINET AND COMMUNICATIONS WORK TO BE PERFORMED.

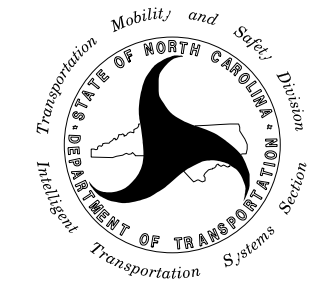
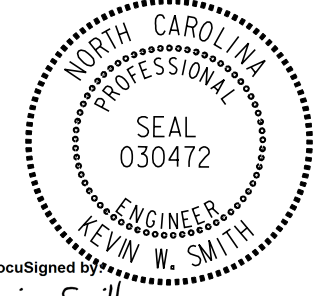
**Kimley»Horn**  
 NC License #F-0102  
 421 Fayetteville St., Suite 600  
 Raleigh, NC 27636  
 Tel: (919) 677-2000  
 Fax: (919) 677-2050

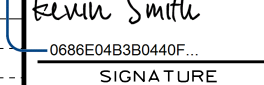
|  |   |                                       |   |
|--|---|---------------------------------------|---|
| <br>Plans Prepared For:<br>DEPARTMENT OF TRANSPORTATION<br>Division of Transportation Systems | <b>FAYETTEVILLE COMPUTERIZED SIGNAL SYSTEM</b><br><b>PROPOSED CCTV 46 INSTALLATION</b>  |                                       | SEAL<br><br>KEVIN W. SMITH<br>ENGINEER   |
|  | DIVISION 06 CUMBERLAND COUNTY<br>PLAN DATE: NOVEMBER 2016 REVIEWED BY: K. NICHOLAS<br>PREPARED BY: J. CROSS REVIEWED BY: K. SMITH |                                       |   |
| <br>SCALE<br>0 50   | REVISIONS<br>_____<br>_____<br>_____  | INIT. DATE<br>_____<br>_____<br>_____ | DocuSigned by:<br><br>SEAL<br>030472<br>11/15/2016<br>SIGNATURE DATE<br>CADD Filename: |



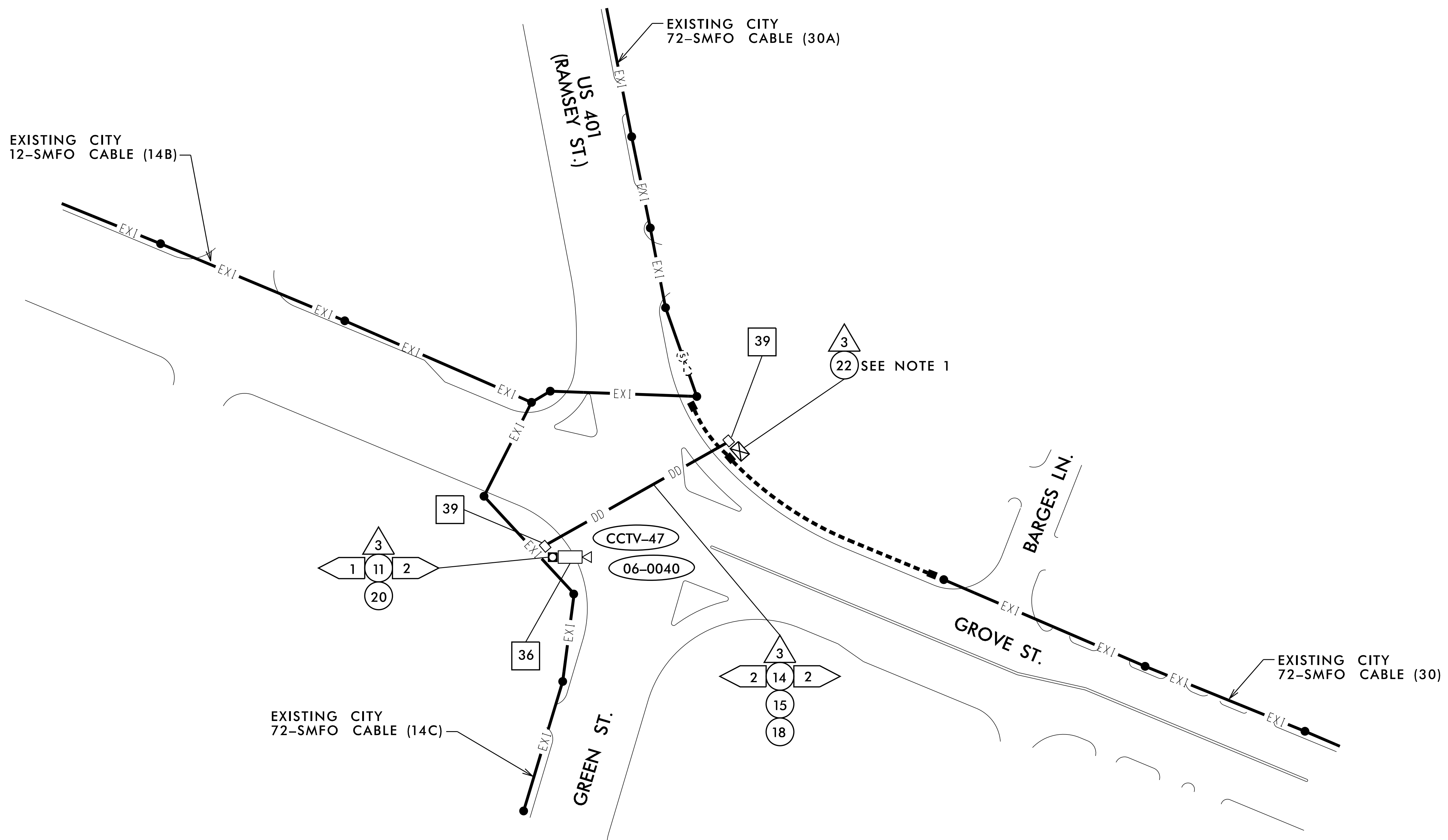

**NOTE:**  
 1. SEE SUMMARY OF WORK TABLES FOR ADDITIONAL CABINET AND COMMUNICATIONS WORK TO BE PERFORMED.

11/15/2016 K:\ARL\TPTD\ITS\01036305 - Fayetteville Sig Sys\Plans\01036305\_ITS\_psh\_157-CCTV47.dgn

**Kimley»Horn**  
 NC License #F-0102  
 421 Fayetteville St., Suite 600  
 Raleigh, NC 27636  
 Tel: (919) 677-2000  
 Fax: (919) 677-2050

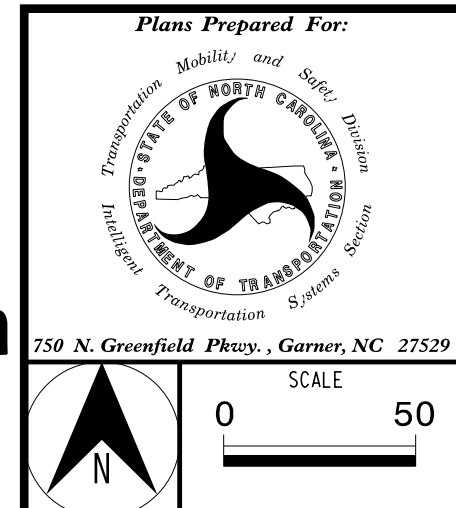

|   |                          |
|---|--------------------------|
| FAYETTEVILLE COMPUTERIZED SIGNAL SYSTEM |                          |
| PROPOSED CCTV 47 INSTALLATION           |                          |
| DIVISION 06                             | CUMBERLAND COUNTY        |
| PLAN DATE: NOVEMBER 2016                | REVIEWED BY: K. NICHOLAS |
| PREPARED BY: J. CROSS                   | REVIEWED BY: K. SMITH    |
| REVISIONS                               | INIT. DATE               |
|   |                          |
|   |                          |
|   |                          |

SEAL

DocuSigned by:  
 Kevin W. Smith  
 068E04380440F  
 SIGNATURE DATE 11/15/2016  
 CADD Filename:

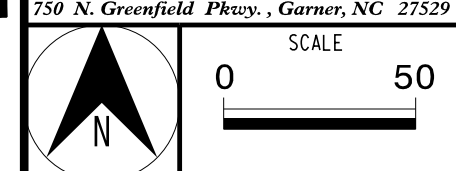

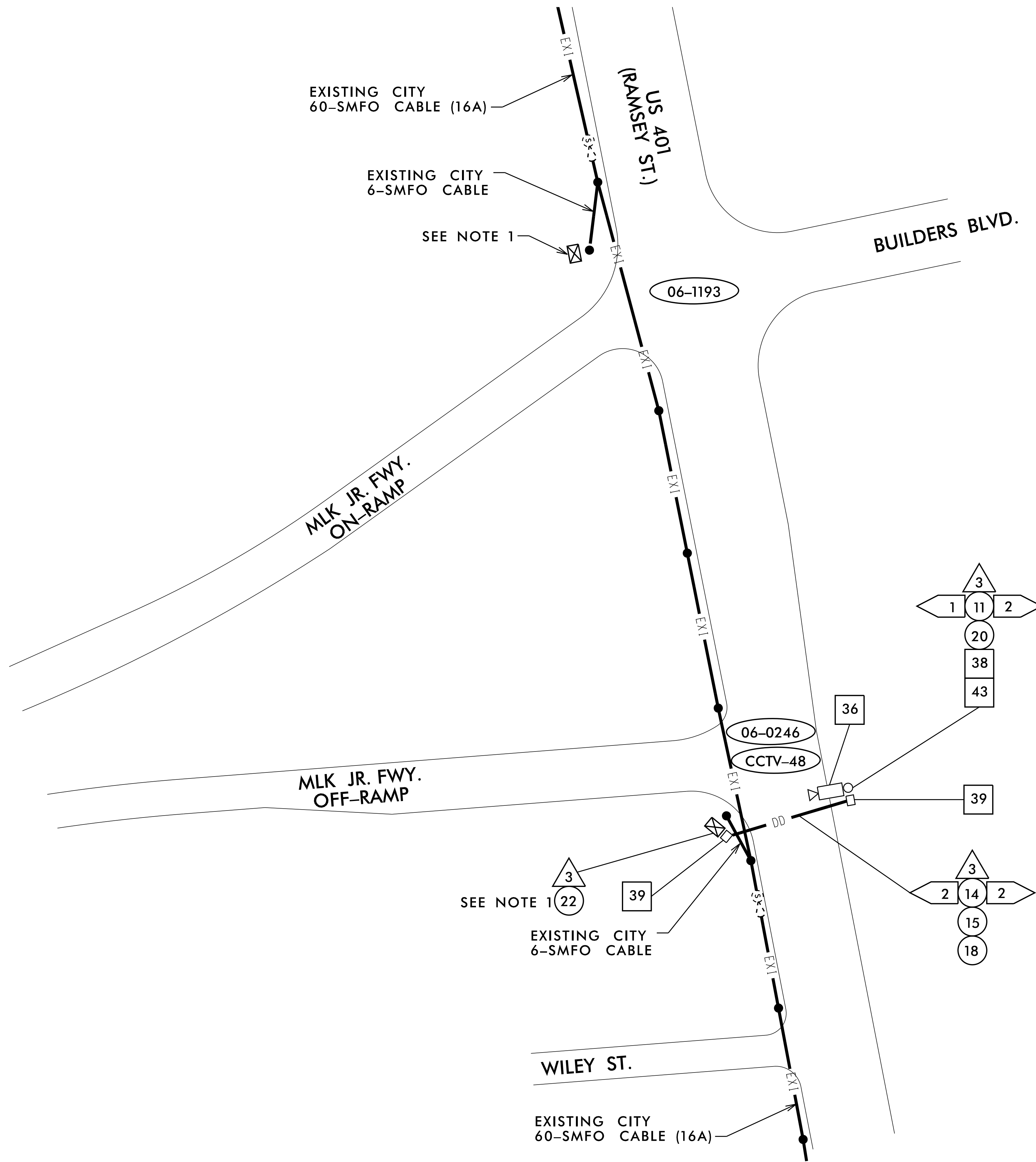

**NOTE:**  
 1. SEE SUMMARY OF WORK TABLES FOR ADDITIONAL CABINET AND COMMUNICATIONS WORK TO BE PERFORMED.

11/15/2016 K:\ARL\TPTD\ITS\01036305 - Fayetteville Sig Sys\Plans\01036305\_ITS\_psh\_B8-CCTV48.dgn

**Kimley»Horn**  
 NC License #F-0102  
 421 Fayetteville St., Suite 600  
 Raleigh, NC 27636  
 Tel: (919) 677-2000  
 Fax: (919) 677-2050

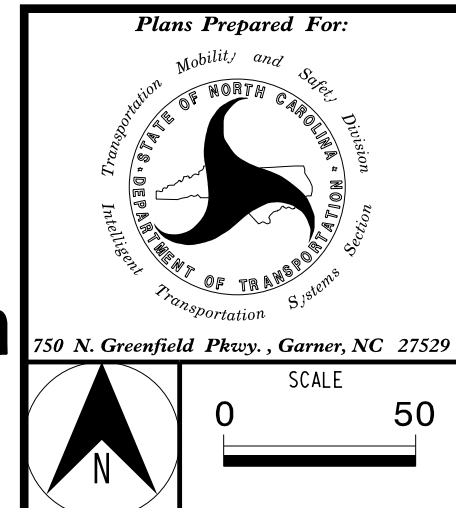

|   |                          |
|---|--------------------------|
| FAYETTEVILLE COMPUTERIZED SIGNAL SYSTEM |                          |
| PROPOSED CCTV 48 INSTALLATION           |                          |
| DIVISION 06                             | CUMBERLAND COUNTY        |
| PLAN DATE: NOVEMBER 2016                | REVIEWED BY: K. NICHOLAS |
| PREPARED BY: J. CROSS                   | REVIEWED BY: K. SMITH    |
| REVISIONS                               | INIT. DATE               |
|   |                          |
|   |                          |
|   |                          |

|                |            |
|----------------|------------|
| SEAL           | DATE       |
|                | 11/15/2016 |
| SIGNATURE      | DATE       |
| Kevin W. Smith |            |
| CADD Filename: |            |

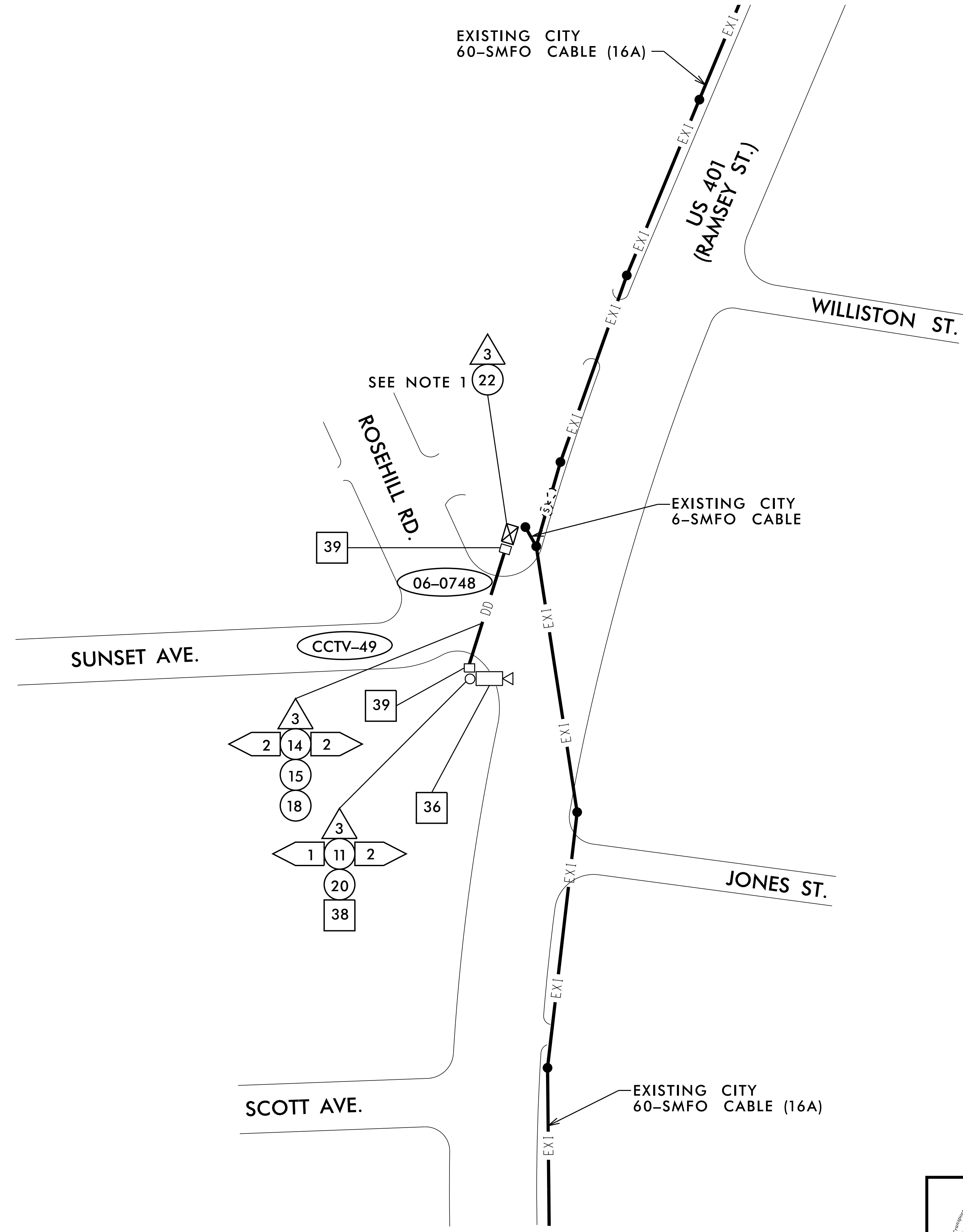

**NOTE:**  
 1. SEE SUMMARY OF WORK TABLES FOR ADDITIONAL CABINET AND COMMUNICATIONS WORK TO BE PERFORMED.

11/15/2016 KARAL\_TPTD\_ITS\01036305 - Fayetteville Sig Sys\Plans\01036305\_ITS\_psh\_b9-CCTV49.dgn

**Kimley»Horn**  
 NC License #F-0102  
 421 Fayetteville St., Suite 600  
 Raleigh, NC 27636  
 Tel: (919) 677-2000  
 Fax: (919) 677-2050

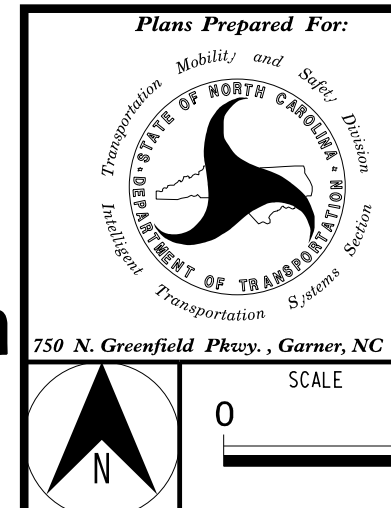

|                     |               |  |             |  |
|---------------------|---------------|--|-------------|--|
| Plans Prepared For: |               | <b>FAYETTEVILLE COMPUTERIZED SIGNAL SYSTEM</b> |             | SEAL   |
|                     |               | <b>PROPOSED CCTV 49 INSTALLATION</b>           |             |  |
| DIVISION 06         |               | CUMBERLAND COUNTY                              |             | KEVIN W. SMITH<br>ENGINEER<br>SEAL<br>030472 |
| PLAN DATE:          | NOVEMBER 2016 | REVIEWED BY:                                   | K. NICHOLAS |  |
| PREPARED BY:        | J. CROSS      | REVIEWED BY:                                   | K. SMITH    |  |
| REVISIONS           |               | INIT.  | DATE        | DATE   |
|                     |               |  |             | 11/15/2016                                   |
|                     |               |  |             | CADD Filename:                               |

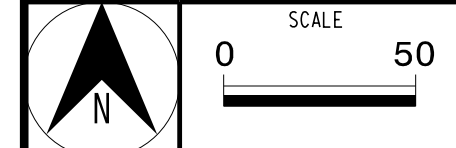

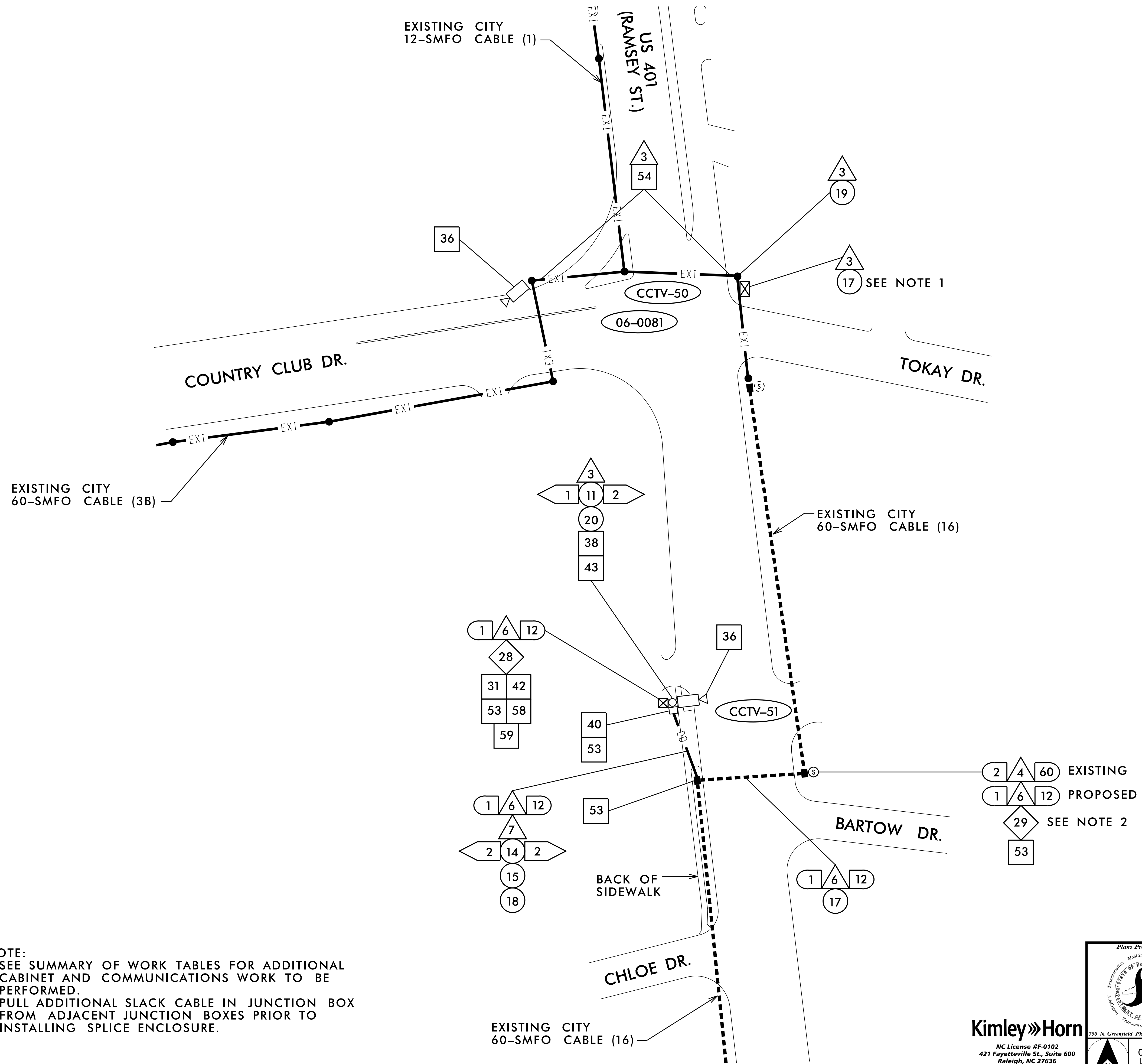

**NOTE:**  
 1. SEE SUMMARY OF WORK TABLES FOR ADDITIONAL CABINET AND COMMUNICATIONS WORK TO BE PERFORMED.  
 2. PULL ADDITIONAL SLACK CABLE IN JUNCTION BOX FROM ADJACENT JUNCTION BOXES PRIOR TO INSTALLING SPLICE ENCLOSURE.

11/15/2016 K:\ARL\TPTD\ITS\01036305 - Fayetteville Sig Sys\Plans\01036305\_ITS\_psh\_160-CCTV50-51.dgn

**Kimley»Horn**  
 NC License #F-0102  
 421 Fayetteville St., Suite 600  
 Raleigh, NC 27636  
 Tel: (919) 677-2000  
 Fax: (919) 677-2050

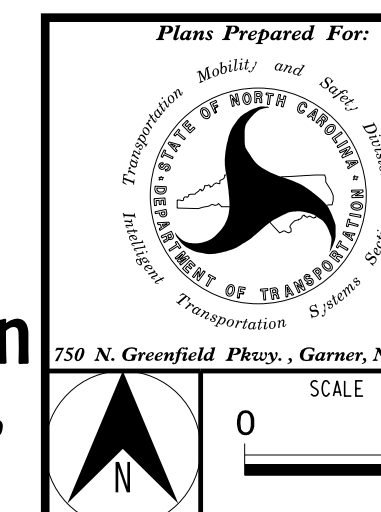

|  |                          |
|--|--------------------------|
| FAYETTEVILLE COMPUTERIZED SIGNAL SYSTEM<br>PROPOSED CCTV 50&51<br>INSTALLATION |                          |
| DIVISION 06  | CUMBERLAND COUNTY        |
| PLAN DATE: NOVEMBER 2016   | REVIEWED BY: K. NICHOLAS |
| PREPARED BY: J. CROSS  | REVIEWED BY: K. SMITH    |
| REVISIONS  | INIT. DATE               |
|  |                          |
|  |                          |
|  |                          |

|                |            |
|----------------|------------|
| SEAL           | DATE       |
|                | 11/15/2016 |
| SIGNATURE      | DATE       |
| Kevin W. Smith |            |
| CADD Filename: |            |

| ID      | Street 1          | Street 2                            | Splicing Detail Sheet No. | ID      | Street 1          | Street 2                       | Splicing Detail Sheet No. | ID      | Street 1                       | Street 2                            | Splicing Detail Sheet No. |
|---------|-------------------|-------------------------------------|---------------------------|---------|-------------------|--------------------------------|---------------------------|---------|--------------------------------|-------------------------------------|---------------------------|
| 06-0018 | Hay Street        | Bragg Boulevard/Robeson Street      | ITS-195                   | 06-0452 | Murchison Road    | Shaw Road                      | ITS-184                   | CCTV-1  | Skibo Road                     | Raeford Road                        | ITS-213                   |
| 06-0041 | Eastern Boulevard | Grove Street                        | ITS-194                   | 06-0454 | Hope Mills Road   | Cameron Road                   | ITS-251                   | CCTV-2  | Skibo Road                     | Morganton Road                      | ITS-208                   |
| 06-0051 | Gillespie Street  | Owen Drive                          | ITS-190                   | 06-0455 | Elk Road / NC 162 | Legion Road                    | ITS-241                   | CCTV-3  | Skibo Road                     | Cliffdale Road                      | ITS-206                   |
| 06-0055 | Skibo Road        | McPherson Church Road / Yadkin Road | ITS-236                   | 06-0456 | Natal Street      | Cumberland Road                | ITS-199                   | CCTV-4  | Skibo Road                     | McPherson Church Road / Yadkin Road | ITS-236                   |
| 06-0056 | Murchison Road    | Country Club Drive                  | ITS-182                   | 06-0458 | Hope Mills Road   | Wingate Road / Butternut Drive | ITS-249                   | CCTV-5  | Raeford Road                   | Hope Mills Road / Glensford Road    | ITS-212                   |
| 06-0058 | Owen Drive        | Village Drive                       | ITS-197                   | 06-0541 | Cliffdale Road    | Seventy First School Road      | ITS-215                   | CCTV-6  | Raeford Road                   | All American Expressway NB          | ITS-201                   |
| 06-0065 | Bragg Boulevard   | Spring Avenue                       | ITS-226                   | 06-0544 | Robeson Street    | Martin Luther King Jr Fwy SB   | ITS-196                   | CCTV-7  | Owen Drive                     | Village Drive                       | ITS-197                   |
| 06-0069 | Hope Mills Road   | Lakeview Road                       | ITS-250                   | 06-0545 | Robeson Street    | Martin Luther King Jr Fwy NB   | ITS-196                   | CCTV-8  | Eastern Boulevard              | Grove Street                        | ITS-194                   |
| 06-0073 | Bragg Boulevard   | Manchester Road                     | ITS-231                   | 06-0575 | Fisher Road       | George Owen Drive              | ITS-238                   | CCTV-9  | Bragg Boulevard/Robeson Street | Hay Street                          | ITS-195                   |
| 06-0081 | Ramsey Street     | Country Club Drive                  | ITS-204                   | 06-0700 | Bragg Boulevard   | McKenzie Road                  | ITS-229                   | CCTV-10 | Ramsey Street                  | Northgate Shopping Center           | ITS-173                   |
| 06-0094 | Skibo Road        | Cliffdale Road                      | ITS-206                   | 06-0705 | Skibo Road        | Cross Creek Mall               | ITS-232                   | CCTV-11 | Cliffdale Road                 | All American Expressway SB          | ITS-205                   |
| 06-0095 | Skibo Road        | Morganton Road                      | ITS-208                   | 06-0706 | Fisher Road       | Lakewood Drive                 | ITS-240                   | CCTV-13 | Reilly Road                    | Morganton Road                      | ITS-211                   |
| 06-0096 | Skibo Road        | Raeford Road                        | ITS-213                   | 06-0768 | McArthur Road     | Honeycutt Road                 | ITS-180                   | CCTV-14 | Skibo Road                     | Kmart                               | ITS-207                   |
| 06-0153 | Bragg Boulevard   | Shannon Drive                       | ITS-189                   | 06-0771 | Ramsey Street     | Northgate Shopping Center      | ITS-173                   | CCTV-15 | Skibo Road                     | Cross Creek Mall/Lake Valley Drive  | ITS-233                   |
| 06-0155 | Raeford Road      | Hope Mills Road / Glensford Road    | ITS-212                   | 06-0788 | McArthur Road     | Andrews Road                   | ITS-181                   | CCTV-16 | Morganton Road                 | Glensford Road / Cross Creek Mall   | ITS-210                   |
| 06-0223 | Ramsey Street     | Cumberland Street                   | ITS-202                   | 06-0824 | Hope Mills Road   | Parkton Road                   | ITS-252                   | CCTV-17 | Murchison Road                 | Country Club Drive                  | ITS-182                   |
| 06-0265 | Bragg Boulevard   | Johnson Street / Mike Street        | ITS-217                   | 06-0862 | Legion Road       | Lakeview Road                  | ITS-243                   | CCTV-18 | Gillespie Street               | Owen Drive                          | ITS-190                   |
| 06-0274 | Raeford Road      | Bunce Road                          | ITS-214                   | 06-0905 | Bragg Boulevard   | Knox Street                    | ITS-224                   | CCTV-19 | Morganton Road                 | All American Expressway NB          | ITS-209                   |
| 06-0278 | Santa Fe Drive    | All American Expressway NB Ramp     | ITS-219                   | 06-0915 | Skibo Road        | Kmart                          | ITS-207                   | CCTV-20 | Ramsey Street                  | Meadowcroft Drive                   | ITS-174                   |
| 06-0279 | Bragg Boulevard   | Santa Fe Drive                      | ITS-218                   | 06-1161 | Skibo Road        | Walmart                        | ITS-188                   | CCTV-21 | Raeford Road                   | Bunce Road                          | ITS-214                   |
| 06-0281 | Santa Fe Drive    | All American Expressway SB Ramp     | ITS-220                   | 06-1183 | Cliffdale Road    | All American Expy SB Ramp      | ITS-205                   | CCTV-22 | Cliffdale Road                 | Seventy First School Road           | ITS-215                   |
| 06-0293 | Murchison Road    | Honeycutt Road S                    | ITS-225                   | 06-1223 | Ramsey Street     | NC-295                         | ITS-176                   | CCTV-23 | Bragg Boulevard                | Shannon Drive                       | ITS-189                   |
| 06-0318 | Skibo Road        | All American Expressway W           | ITS-235                   | 06-1252 | NC-210            | Walmart                        | ITS-227                   | CCTV-24 | Bragg Boulevard                | Santa Fe Drive                      | ITS-218                   |
| 06-0319 | Morganton Road    | All American Expressway NB          | ITS-209                   | 06-1266 | Bunce Road        | Marykirk Drive                 | ITS-237                   | CCTV-25 | Santa Fe Drive                 | All American Expressway SB Ramp     | ITS-220                   |
| 06-0321 | Skibo Road        | All American Expressway E           | ITS-234                   | 06-1280 | Ramsey Street     | Meadowcroft Drive              | ITS-174                   | CCTV-26 | Santa Fe Drive                 | All American Expressway NB Ramp     | ITS-219                   |
| 06-0323 | Raeford Road      | All American Expressway NB          | ITS-201                   | 06-1287 | Elk Road          | South View HS / Alexwood Drive | ITS-245                   | CCTV-31 | Gillespie Street               | West Mountain /East Mountain        | ITS-191                   |
| 06-0325 | Skibo Road        | Lake Valley Drive                   | ITS-233                   | 06-1288 | Elk Road / NC-162 | Southview Middle School        | ITS-244                   | CCTV-35 | Fisher Road                    | George Owen Drive                   | ITS-238                   |
| 06-0332 | US 301            | Tom Starling Road                   | ITS-247                   | 06-1289 | Elk Road          | US 301                         | ITS-246                   | CCTV-38 | Elk Road / NC 162              | Legion Road                         | ITS-241                   |
| 06-0333 | Murchison Road    | Shaw Mill Road                      | ITS-183                   | 06-1300 | Bragg Boulevard   | NC-295 SB Ramp                 | ITS-223                   | CCTV-39 | Elk Road                       | US 301                              | ITS-246                   |
| 06-0337 | Hope Mills Road   | Redwood Road                        | ITS-248                   | 06-1301 | Bragg Boulevard   | NC-295 NB Ramp                 | ITS-222                   | CCTV-40 | US 301                         | Black & Decker Rd / Airport Road    | ITS-193                   |
| 06-0341 | McArthur Road     | Rosehill Road / Stacey Weaver Road  | ITS-177                   | 06-1302 | Murchison Road    | NC-295 SB Ramp                 | ITS-186                   | CCTV-42 | Owen Drive                     | Dyer Street                         | ITS-198                   |
| 06-0346 | Morganton Road    | Glensford Road / Cross Creek Mall   | ITS-210                   | 06-1303 | Murchison Road    | NC-295 NB Ramp                 | ITS-185                   | CCTV-44 | Martin Luther King Jr Fwy      | Robeson Street                      | ITS-196                   |
| 06-0364 | Cliffdale Road    | Reilly Road                         | ITS-216                   | 06-1304 | McArthur Road     | NC-295 SB Ramp                 | ITS-179                   | CCTV-50 | Ramsey Street                  | Country Club Drive                  | ITS-204                   |
| 06-0369 | Morganton Road    | Reilly Road                         | ITS-211                   | 06-1305 | McArthur Road     | NC-295 NB Ramp                 | ITS-178                   | CCTV-51 | Ramsey Street                  | Bartow Drive                        | ITS-203                   |
| 06-0378 | Bragg Boulevard   | Odell Road                          | ITS-230                   | 06-1312 | Murchison Road    | Honeycutt Road N               | ITS-225                   | CCTV-52 | Bragg Boulevard                | Spring Avenue                       | ITS-226                   |
| 06-0379 | Bragg Boulevard   | N. Main Street                      | ITS-228                   | 06-1319 | NC-210            | North Fifth Street             | ITS-227                   | CCTV-53 | Bragg Boulevard                | Manchester Road                     | ITS-231                   |
| 06-0383 | Boone Trail       | Cumberland Road                     | ITS-200                   | 06-1341 | Bragg Boulevard   | Coalition Boulevard            | ITS-221                   |         |                                |                                     |                           |
| 06-0412 | US 301            | Black & Decker Road / Airport Road  | ITS-193                   | 06-1346 | US 301            | Ivan Drive                     | ITS-192                   |         |                                |                                     |                           |
| 06-0427 | Gillespie Street  | West Mountain /East Mountain        | ITS-191                   | 06-1352 | Fisher Road       | Whitehaven Drive               | ITS-239                   |         |                                |                                     |                           |
| 06-0448 | Ramsey Street     | Stacey Weaver Drive                 | ITS-175                   | 06-1354 | Legion Road       | Walmart-High School Entrance   | ITS-242                   |         |                                |                                     |                           |

11/15/2016 KARAL\_TPTD ITS 01036305 - Fayetteville Sig Sys Plans\Splicing\01036305 ITS.psh.tbl-index.dgn

**Kimley»Horn**  
 NC License #F-0102  
 421 Fayetteville St., Suite 600  
 Raleigh, NC 27636  
 Tel: (919) 677-2000  
 Fax: (919) 677-2050

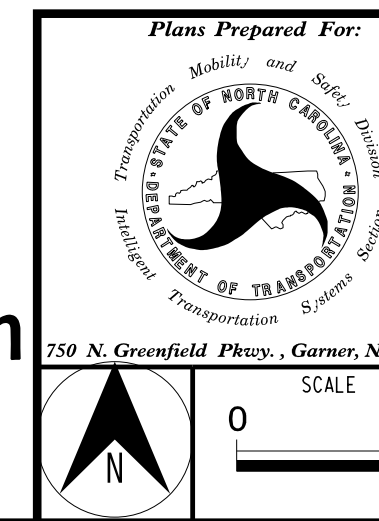

|  |                          |
|--|--------------------------|
| <b>FAYETTEVILLE COMPUTERIZED SIGNAL SYSTEM INDEX SHEET FOR CABLE SCHEMATIC</b> |                          |
| DIVISION 06 CUMBERLAND COUNTY  |                          |
| PLAN DATE: NOVEMBER 2016   | REVIEWED BY: K. NICHOLAS |
| PREPARED BY: J. CROSS  | REVIEWED BY: K. SMITH    |
| REVISIONS  | INIT. DATE               |
| _____  | _____                    |
| _____  | _____                    |
| _____  | _____                    |

|   |
|---|
| SEAL<br>NORTH CAROLINA PROFESSIONAL ENGINEER<br>SEAL 030472<br>KEVIN W. SMITH<br>11/15/2016<br>SIGNATURE DATE<br>CADD Filename: |
|---|

- EXISTING COMMUNICATIONS CABLE
- PROPOSED COMMUNICATIONS CABLE
- - - - CHANNEL BOUNDARY
- SPLICE LOCATION
- ⊠ CABINET
- ◼ EXISTING CCTV LOCATION
- ◻ PROPOSED CCTV LOCATION
- XX EXISTING CABLE NAME (TOP) AND EXISTING FIBER COUNT (BOTTOM)
- XX PROPOSED CABLE NAME (TOP) AND PROPOSED FIBER COUNT (BOTTOM)
- 06-XXXX FUTURE NCDOT SIGNAL
- C-XXX FUTURE CITY SIGNAL

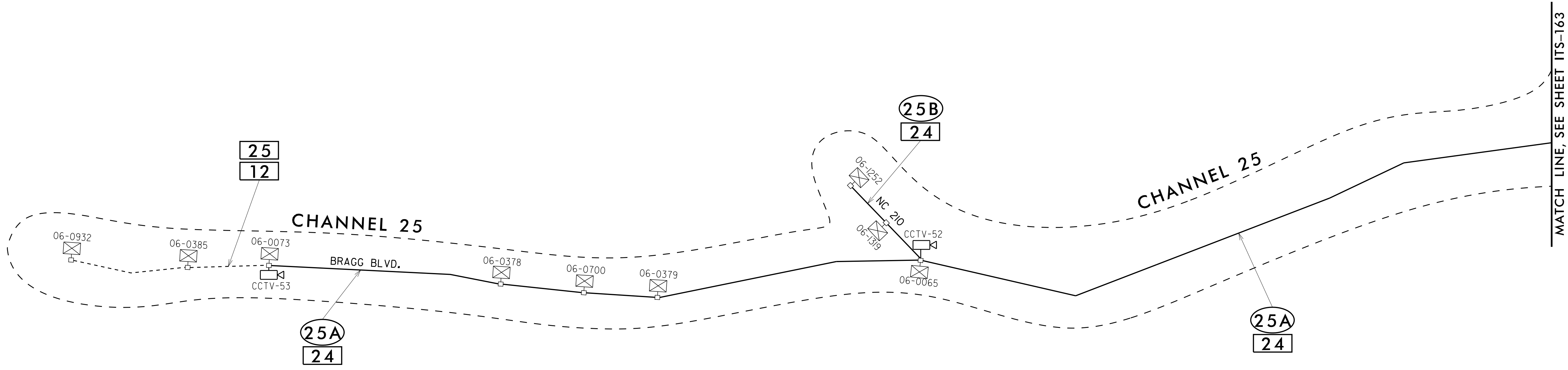

11/15/2016 K:\ARL\TPTD\_ITS\01036305 - Fayetteville Sig Sys\Plans\Splicing\01036305\_ITS\_psh.l62-schmi.dgn

**Kimley»Horn**  
 NC License #F-0102  
 421 Fayetteville St., Suite 600  
 Raleigh, NC 27636  
 Tel: (919) 677-2000  
 Fax: (919) 677-2050

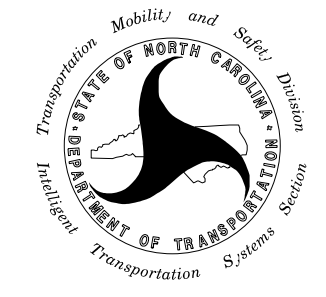
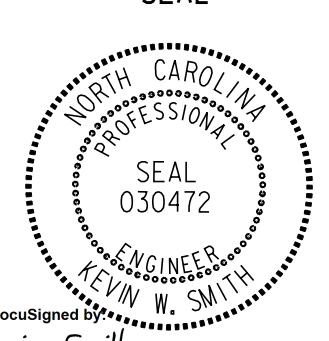
|   |  |       |   |
|---|--|-------|---|
|  | <b>FAYETTEVILLE COMPUTERIZED SIGNAL SYSTEM</b><br><b>CABLE SCHEMATIC</b> |       |  |
|   | DIVISION 06 CUMBERLAND COUNTY  |       |   |
| PLAN DATE: NOVEMBER 2016  | REVIEWED BY: K. NICHOLAS   |       | Documented by: Kevin Smith<br>11/15/2016  |
| PREPARED BY: J. CROSS   | REVIEWED BY: K. SMITH  |       |   |
| REVISIONS   | INIT.  | DATE  | SIGNATURE   |
| _____   | _____  | _____ | _____   |
| CADD Filename:  |  |       |   |

MATCH LINE, SEE SHEET ITS-170

3B  
60

3A  
60

3D  
24

CHANNEL 25

MATCH LINE, SEE SHEET ITS-162

3E  
24

MURCHISON RD.

NCDOT CCTV X-0002F

CHANNEL 3

PAMALEE DR.

24D  
24

24C  
24

24B  
24

3A  
60

CHANNEL 24

BRAGG BLVD.

NCDOT CCTV X-2000F

CCTV-24

3  
60

24  
12

SANTA FE DR.

24A  
12

MATCH LINE, SEE SHEET ITS-166

- EXISTING COMMUNICATIONS CABLE
- PROPOSED COMMUNICATIONS CABLE
- - - - CHANNEL BOUNDARY
- SPLICE LOCATION
- ⊠ CABINET
- ▶ EXISTING CCTV LOCATION
- ◀ PROPOSED CCTV LOCATION
- XX EXISTING CABLE NAME (TOP) AND EXISTING FIBER COUNT (BOTTOM)
- XX PROPOSED CABLE NAME (TOP) AND PROPOSED FIBER COUNT (BOTTOM)
- 06-XXXX FUTURE NCDOT SIGNAL
- C-XXX FUTURE CITY SIGNAL

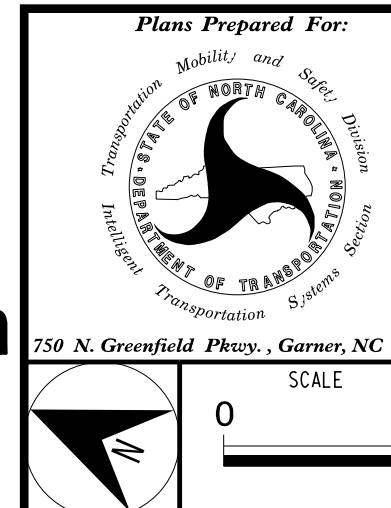

|   |          |                   |             |
|---|----------|-------------------|-------------|
| FAYETTEVILLE COMPUTERIZED SIGNAL SYSTEM |          | CUMBERLAND COUNTY |             |
| DIVISION 06                             |          | NOVEMBER 2016     |             |
| PREPARED BY:                            | J. CROSS | REVIEWED BY:      | K. NICHOLAS |
| REVISIONS                               | INIT.    | DATE              |             |
|   |          |                   |             |
|   |          |                   |             |
|   |          |                   |             |

|                |            |
|----------------|------------|
| SEAL           | DATE       |
| KEVIN W. SMITH | 11/15/2016 |
| SIGNATURE      | DATE       |
|                |            |

**Kimley»Horn**  
 NC License #F-0102  
 421 Fayetteville St., Suite 600  
 Raleigh, NC 27636  
 Tel: (919) 677-2000  
 Fax: (919) 677-2050

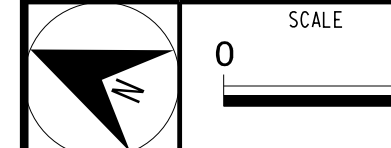

11/15/2016 K:\ARL\TPTD\ITS\01036305 - Fayetteville Sig Sys\Plans\Splicing\01036305-ITS\_psh.l63-schm2.dgn

- EXISTING COMMUNICATIONS CABLE
- PROPOSED COMMUNICATIONS CABLE
- - - - CHANNEL BOUNDARY
- SPLICE LOCATION
- ⊠ CABINET
- ⊠ EXISTING CCTV LOCATION
- ⊠ PROPOSED CCTV LOCATION
- XX EXISTING CABLE NAME (TOP) AND EXISTING FIBER COUNT (BOTTOM)
- XX PROPOSED CABLE NAME (TOP) AND PROPOSED FIBER COUNT (BOTTOM)
- 06-XXXX FUTURE NCDOT SIGNAL
- C-XXX FUTURE CITY SIGNAL

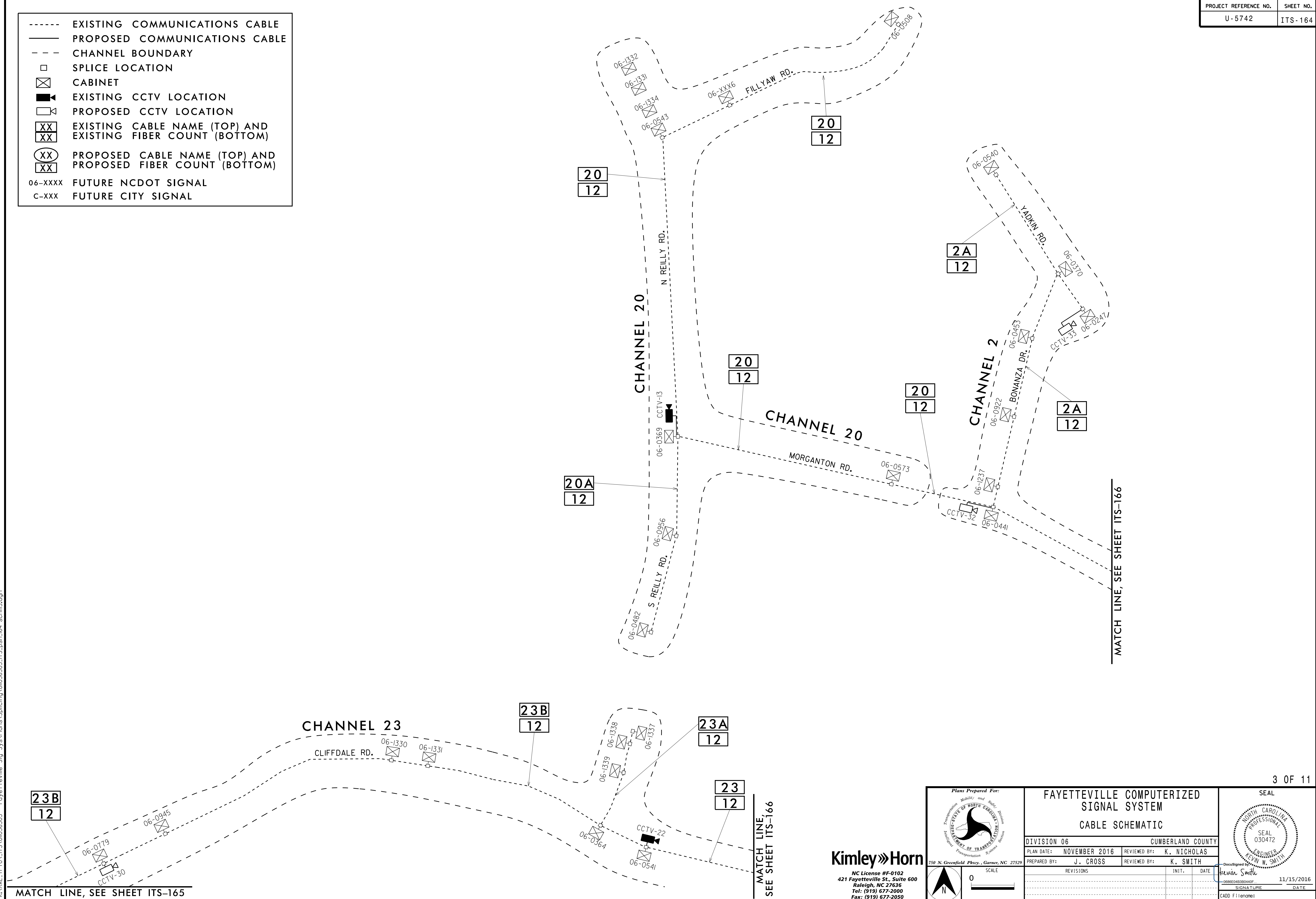

11/15/2016 KARAL.TPTD.ITS\01036305 - Fayetteville Sig Sys\Plans\Splicing\01036305.ITS.psh.l64-schm3.dgn

MATCH LINE, SEE SHEET ITS-165

MATCH LINE, SEE SHEET ITS-166

MATCH LINE, SEE SHEET ITS-166

**Kimley»Horn**  
 NC License #F-0102  
 421 Fayetteville St., Suite 600  
 Raleigh, NC 27636  
 Tel: (919) 677-2000  
 Fax: (919) 677-2050

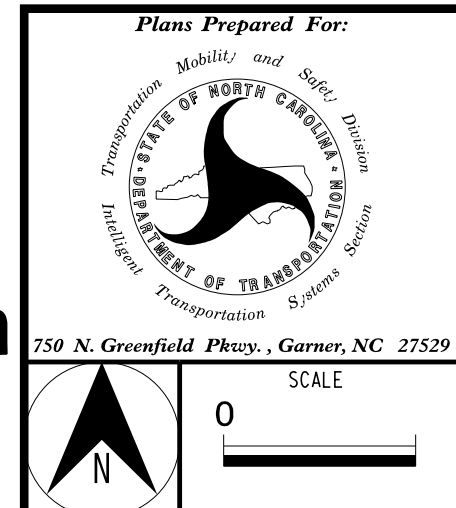

|  |                          |
|--|--------------------------|
| <b>FAYETTEVILLE COMPUTERIZED SIGNAL SYSTEM</b> |                          |
| <b>CABLE SCHEMATIC</b>                         |                          |
| DIVISION 06 CUMBERLAND COUNTY                  |                          |
| PLAN DATE: NOVEMBER 2016                       | REVIEWED BY: K. NICHOLAS |
| PREPARED BY: J. CROSS                          | REVIEWED BY: K. SMITH    |
| REVISIONS                                      | INIT. DATE               |
|  |                          |
|  |                          |
|  |                          |

SEAL

DocuSigned by:  
 Kevin W. Smith  
 0688E48B8440F  
 SIGNATURE DATE  
 11/15/2016  
 CADD Filename:



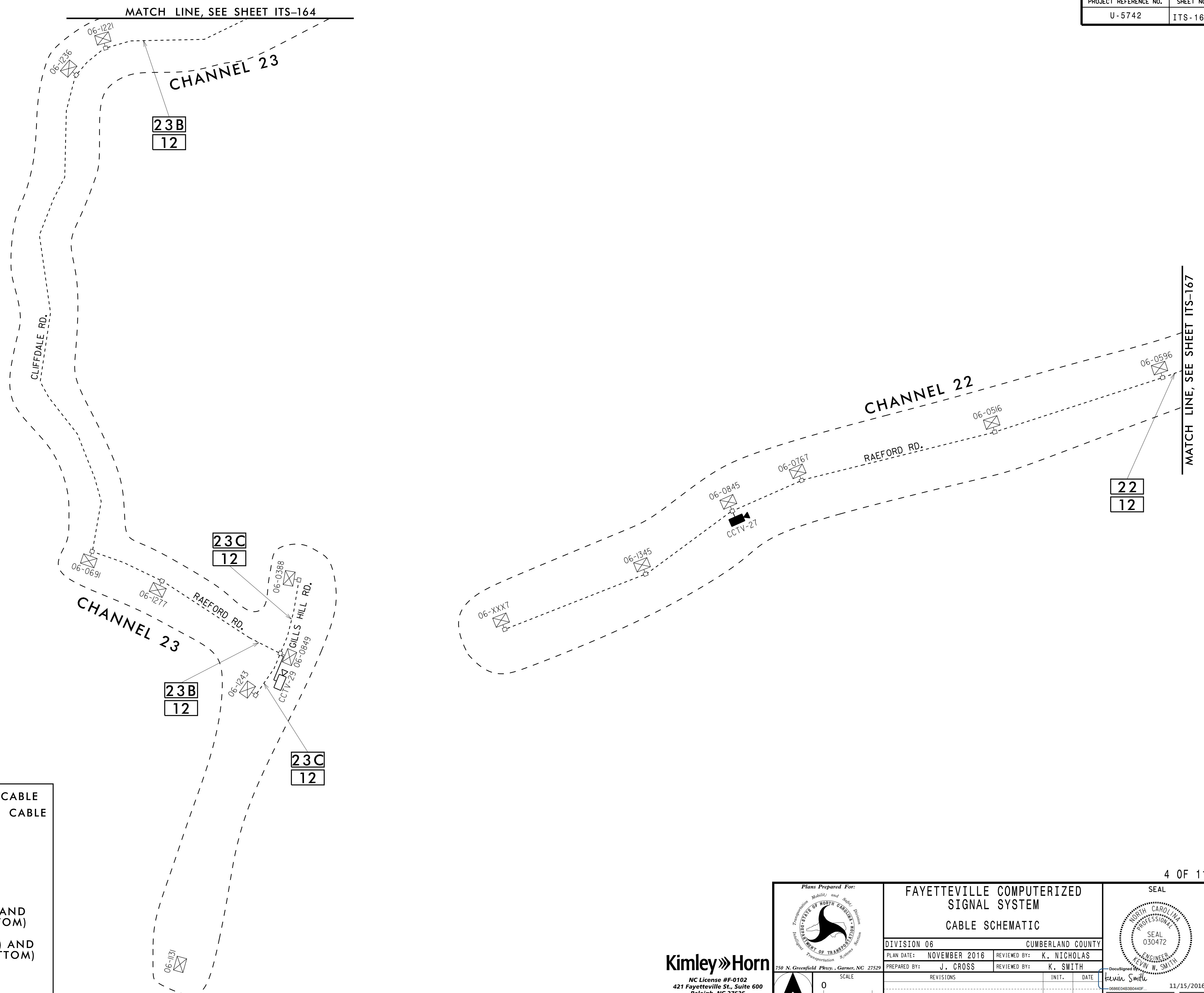

- EXISTING COMMUNICATIONS CABLE
- PROPOSED COMMUNICATIONS CABLE
- - - CHANNEL BOUNDARY
- SPLICE LOCATION
- ⊠ CABINET
- 📹 EXISTING CCTV LOCATION
- 📹 PROPOSED CCTV LOCATION
- XX EXISTING CABLE NAME (TOP) AND EXISTING FIBER COUNT (BOTTOM)
- XX PROPOSED CABLE NAME (TOP) AND PROPOSED FIBER COUNT (BOTTOM)
- 06-XXXX FUTURE NCDOT SIGNAL
- C-XXX FUTURE CITY SIGNAL

11/15/2016 KARAL.TPTD.ITS.01036305 - Fayetteville Sig Sys\Plans\Splicing\01036305-ITS.psh.l65-schm4.dgn

**Kimley»Horn**  
 NC License #F-0102  
 421 Fayetteville St., Suite 600  
 Raleigh, NC 27636  
 Tel: (919) 677-2000  
 Fax: (919) 677-2050

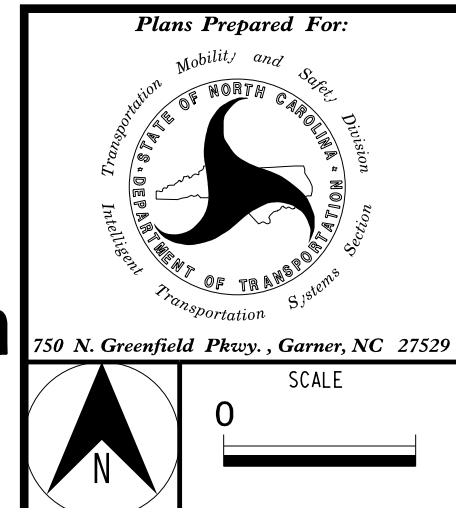

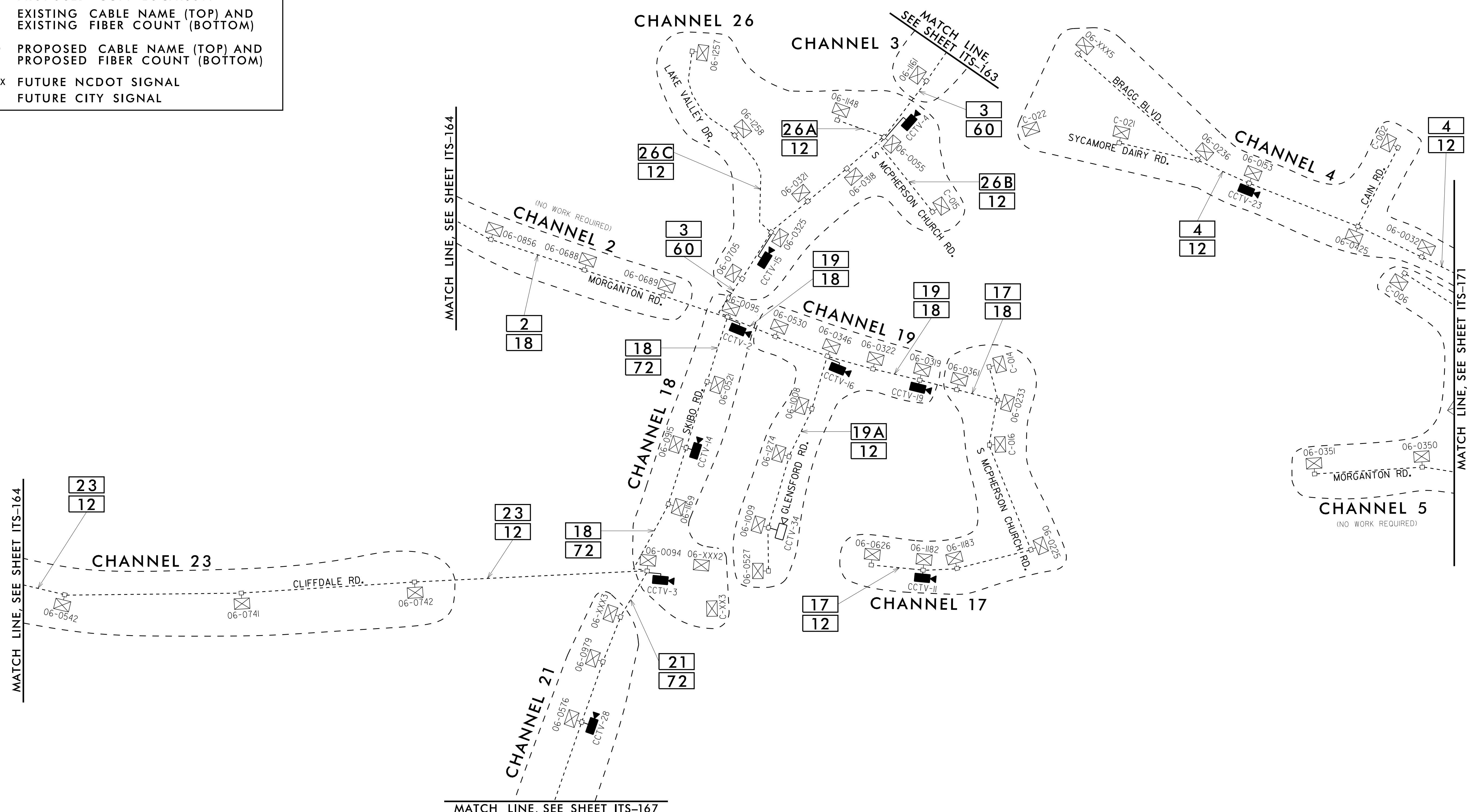

|                          |                          |  |                       |  |
|--------------------------|--------------------------|--|-----------------------|--|
| Plans Prepared For:<br>  |                          | <b>FAYETTEVILLE COMPUTERIZED SIGNAL SYSTEM</b><br><b>CABLE SCHEMATIC</b> |                       | SEAL<br>                                       |
| DIVISION 06              |                          | CUMBERLAND COUNTY  |                       | DocuSigned By:<br>Kevin W. Smith<br>11/15/2016 |
| PLAN DATE: NOVEMBER 2016 | REVIEWED BY: K. NICHOLAS | PREPARED BY: J. CROSS  | REVIEWED BY: K. SMITH |  |
| REVISIONS                | INIT.                    | DATE   | SIGNATURE             | DATE   |
|                          |                          |  |                       |  |
| CADD Filename:           |                          |  |                       |  |

- EXISTING COMMUNICATIONS CABLE
- PROPOSED COMMUNICATIONS CABLE
- - - - CHANNEL BOUNDARY
- SPLICE LOCATION
- ⊠ CABINET
- EXISTING CCTV LOCATION
- EXISTING CCTV LOCATION
- ⊠ EXISTING CABLE NAME (TOP) AND EXISTING FIBER COUNT (BOTTOM)
- ⊠ PROPOSED CABLE NAME (TOP) AND PROPOSED FIBER COUNT (BOTTOM)
- 06-XXXX FUTURE NCDOT SIGNAL
- C-XXX FUTURE CITY SIGNAL

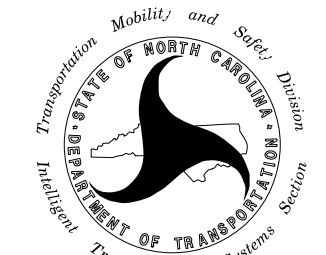
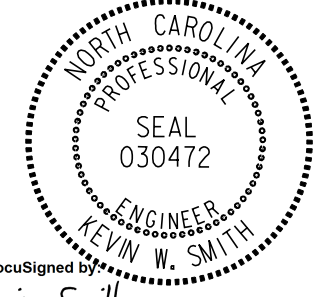

11/15/2016 K:\ARL\TPTD\ITS\01036305 - Fayetteville Sig Sys\Plans\Splicing\01036305-ITS.psh.l66-schm5.dgn

**Kimley»Horn**  
 NC License #F-0102  
 421 Fayetteville St., Suite 600  
 Raleigh, NC 27636  
 Tel: (919) 677-2000  
 Fax: (919) 677-2050

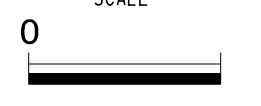
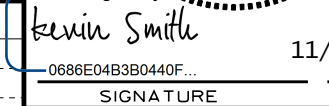
| <br>Plans Prepared For:<br>Transportation Mobility and Safety Division<br>DEPARTMENT OF TRANSPORTATION<br>State of North Carolina | <b>FAYETTEVILLE COMPUTERIZED SIGNAL SYSTEM</b><br><b>CABLE SCHEMATIC</b>  |   | SEAL<br><br>KEVIN W. SMITH<br>ENGINEER<br>SEAL 030472 |             |       |      |  |  |  |  |   |
|--|---|---|--|-------------|-------|------|--|--|--|--|---|
|  | DIVISION 06 CUMBERLAND COUNTY<br>PLAN DATE: NOVEMBER 2016 REVIEWED BY: K. NICHOLAS<br>PREPARED BY: J. CROSS REVIEWED BY: K. SMITH |   |  |             |       |      |  |  |  |  |   |
|   | SCALE<br>                                    | REVISIONS<br><table border="1"> <thead> <tr> <th>NO.</th> <th>DESCRIPTION</th> <th>INIT.</th> <th>DATE</th> </tr> </thead> <tbody> <tr> <td> </td> <td> </td> <td> </td> <td> </td> </tr> </tbody> </table> | NO.  | DESCRIPTION | INIT. | DATE |  |  |  |  | DocuSign<br><br>KEVIN W. SMITH<br>11/15/2016<br>SIGNATURE DATE<br>CADD Filename: |
| NO.  | DESCRIPTION   | INIT.   | DATE   |             |       |      |  |  |  |  |   |
|  |   |   |  |             |       |      |  |  |  |  |   |

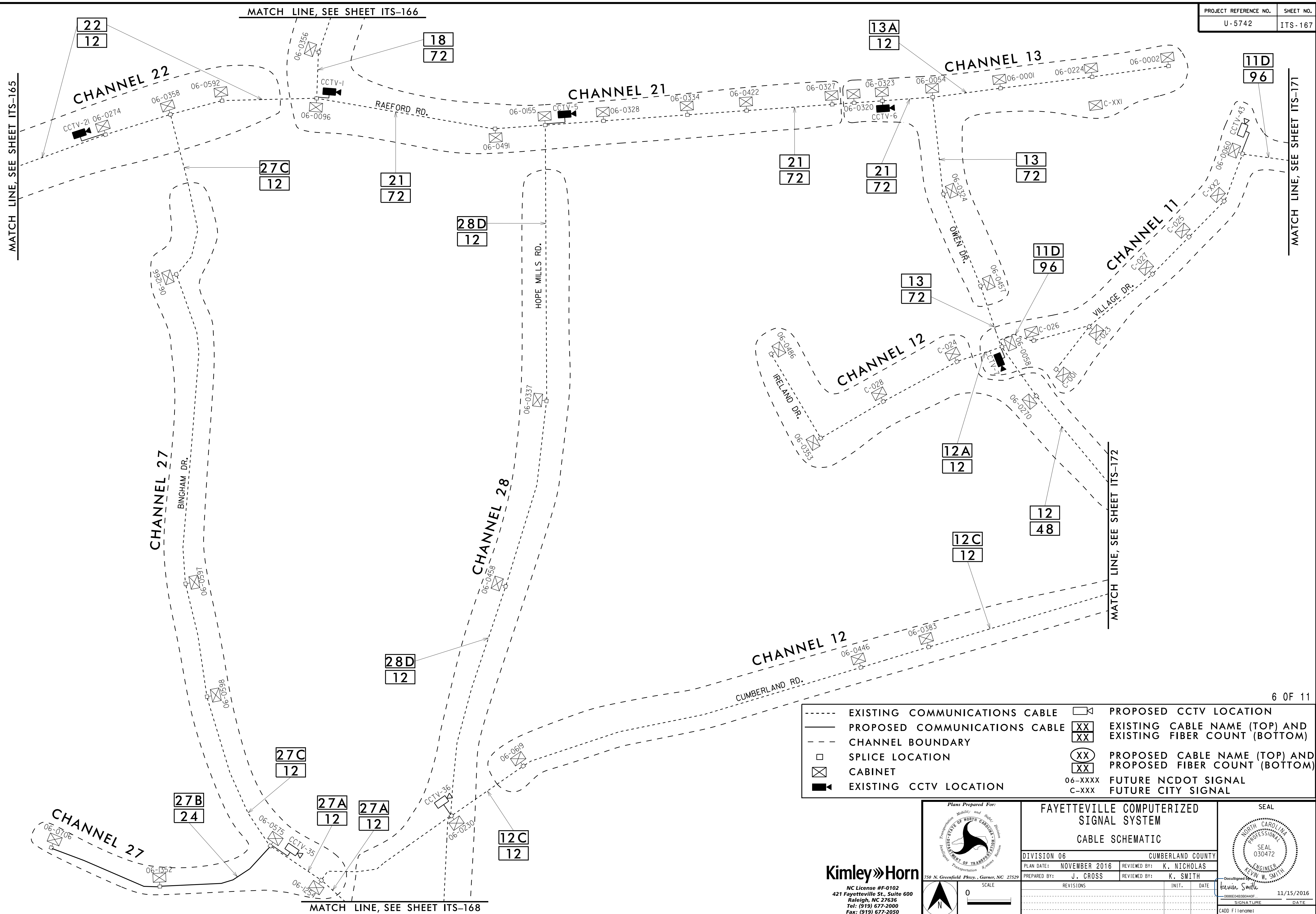

|       |                               |          |   |
|-------|-------------------------------|----------|---|
| ----- | EXISTING COMMUNICATIONS CABLE | ☒        | PROPOSED CCTV LOCATION                                      |
| —     | PROPOSED COMMUNICATIONS CABLE | XX<br>XX | EXISTING CABLE NAME (TOP) AND EXISTING FIBER COUNT (BOTTOM) |
| - - - | CHANNEL BOUNDARY              | ☒        | PROPOSED CABLE NAME (TOP) AND PROPOSED FIBER COUNT (BOTTOM) |
| □     | SPLICE LOCATION               | 06-XXXX  | FUTURE NCDOT SIGNAL   |
| ☒     | CABINET                       | C-XXX    | FUTURE CITY SIGNAL  |
| ▶     | EXISTING CCTV LOCATION        |          |   |

6 OF 11

11/5/2016 K:\ARL\TPTD\ITS\01036305 - Fayetteville Sig Sys\Plans\Splicing\01036305.ITS.pst.l67-schm6.dgn

**Kimley»Horn**  
 NC License #F-0102  
 421 Fayetteville St., Suite 600  
 Raleigh, NC 27636  
 Tel: (919) 677-2000  
 Fax: (919) 677-2050

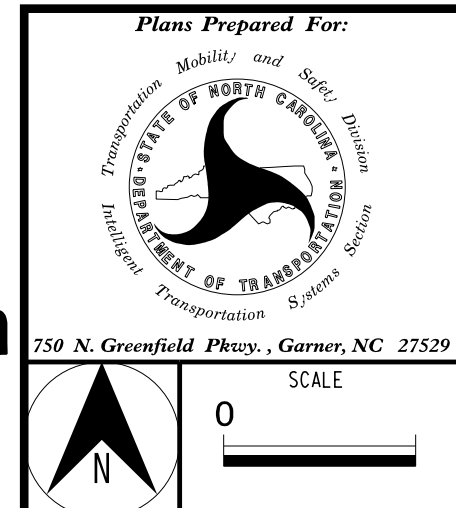

|   |                          |
|---|--------------------------|
| Plans Prepared For:<br><b>FAYETTEVILLE COMPUTERIZED SIGNAL SYSTEM</b><br><b>CABLE SCHEMATIC</b> |                          |
| DIVISION 06   | CUMBERLAND COUNTY        |
| PLAN DATE: NOVEMBER 2016  | REVIEWED BY: K. NICHOLAS |
| PREPARED BY: J. CROSS   | REVIEWED BY: K. SMITH    |
| REVISIONS   | INIT. DATE               |
|   |                          |
|   |                          |

|                 |            |
|-----------------|------------|
| SEAL            | DATE       |
|                 | 11/15/2016 |
| SIGNATURE       | DATE       |
| Kevin W. Smith  | 11/15/2016 |
| CADD File name: |            |

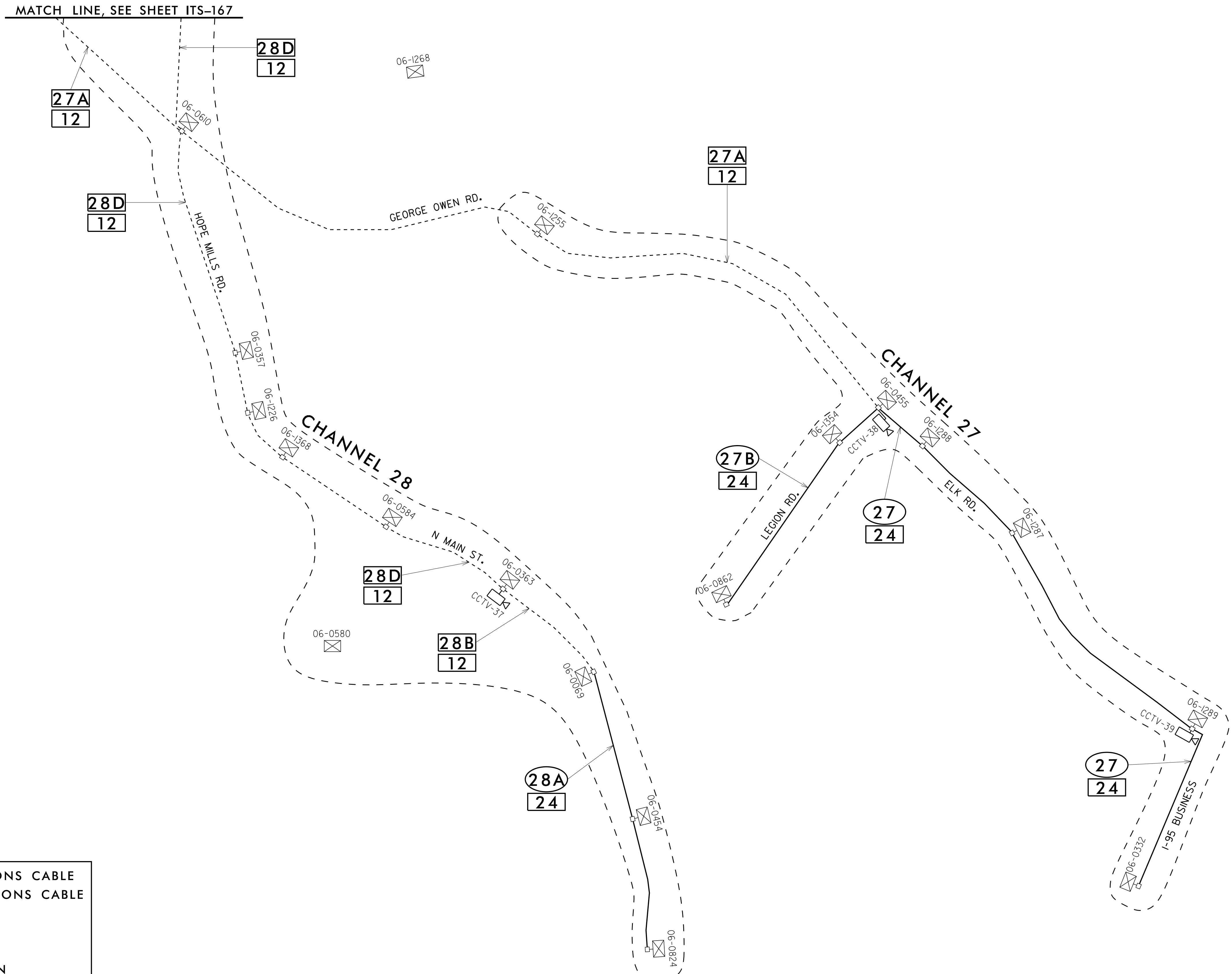

|         |   |
|---------|---|
| -----   | EXISTING COMMUNICATIONS CABLE                               |
| _____   | PROPOSED COMMUNICATIONS CABLE                               |
| - - - - | CHANNEL BOUNDARY  |
| □       | SPLICE LOCATION   |
| ⊠       | CABINET   |
| ◼       | EXISTING CCTV LOCATION                                      |
| ◻       | PROPOSED CCTV LOCATION                                      |
| XX      | EXISTING CABLE NAME (TOP) AND EXISTING FIBER COUNT (BOTTOM) |
| XX      | PROPOSED CABLE NAME (TOP) AND PROPOSED FIBER COUNT (BOTTOM) |
| 06-XXXX | FUTURE NCDOT SIGNAL   |
| C-XXX   | FUTURE CITY SIGNAL  |

11/15/2016 K:\ARL\TPTD\ITS\01036305 - Fayetteville Sig Sys\Plans\Splicing\01036305-ITS\_psh.l68-schm7.dgn

**Kimley»Horn**  
 NC License #F-0102  
 421 Fayetteville St., Suite 600  
 Raleigh, NC 27636  
 Tel: (919) 677-2000  
 Fax: (919) 677-2050

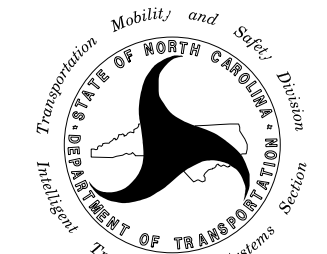
Plans Prepared For:  
  
 250 N. Greenfield Place, Garner, NC 27529

|  |                          |
|--|--------------------------|
| <b>FAYETTEVILLE COMPUTERIZED SIGNAL SYSTEM</b> |                          |
| <b>CABLE SCHEMATIC</b>                         |                          |
| DIVISION 06                                    | CUMBERLAND COUNTY        |
| PLAN DATE: NOVEMBER 2016                       | REVIEWED BY: K. NICHOLAS |
| PREPARED BY: J. CROSS                          | REVIEWED BY: K. SMITH    |
| REVISIONS                                      | INIT. DATE               |
|  |                          |
|  |                          |
|  |                          |

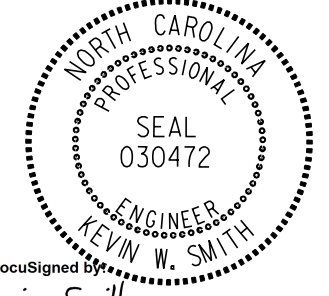
SEAL  
  
 SEAL 030472  
 KEVIN W. SMITH  
 ENGINEER  
 DocuSign  
 Kevin Smith  
 11/15/2016  
 SIGNATURE DATE  
 CADD Filename:

- EXISTING COMMUNICATIONS CABLE
- \_\_\_\_\_ PROPOSED COMMUNICATIONS CABLE
- - - CHANNEL BOUNDARY
- SPLICE LOCATION
- ▣ CABINET
- EXISTING CCTV LOCATION
- EXISTING CCTV LOCATION
- XX EXISTING CABLE NAME (TOP) AND EXISTING FIBER COUNT (BOTTOM)
- XX PROPOSED CABLE NAME (TOP) AND PROPOSED FIBER COUNT (BOTTOM)
- 06-XXXX FUTURE NCDOT SIGNAL
- C-XXX FUTURE CITY SIGNAL

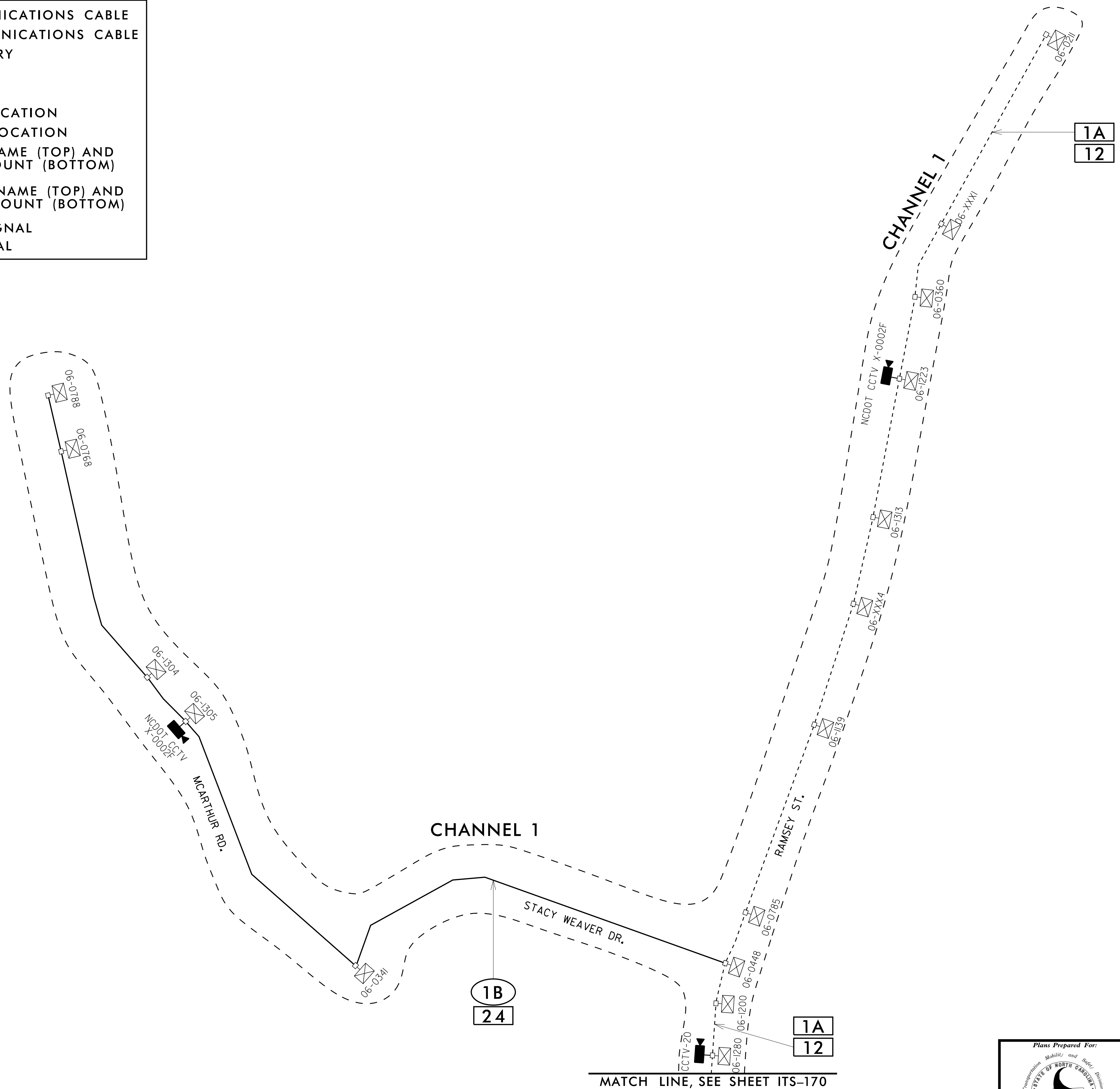

11/15/2016 K:\ARL\TPTD\ITS\01036305 - Fayetteville Sig Sys\Plans\Splicing\01036305-ITS\_psh.l69-schm8.dgn

**Kimley»Horn**  
 NC License #F-0102  
 421 Fayetteville St., Suite 600  
 Raleigh, NC 27636  
 Tel: (919) 677-2000  
 Fax: (919) 677-2050

|                          |  |                   |      |
|--------------------------|--|-------------------|------|
|                          | <b>FAYETTEVILLE COMPUTERIZED SIGNAL SYSTEM</b> |                   |      |
|                          | <b>CABLE SCHEMATIC</b>                         |                   |      |
| DIVISION 06              |  | CUMBERLAND COUNTY |      |
| PLAN DATE: NOVEMBER 2016 | REVIEWED BY: K. NICHOLAS                       |                   |      |
| PREPARED BY: J. CROSS    | REVIEWED BY: K. SMITH                          |                   |      |
| REVISIONS                | INIT.  | DATE              | DATE |
|                          |  |                   |      |
| CADD Filename:           |  |                   |      |

- EXISTING COMMUNICATIONS CABLE
- PROPOSED COMMUNICATIONS CABLE
- - - - CHANNEL BOUNDARY
- SPLICE LOCATION
- ⊠ CABINET
- ◼ EXISTING CCTV LOCATION
- ◻ PROPOSED CCTV LOCATION
- XX EXISTING CHANNEL NAME
- XX EXISTING FIBER COUNT
- XX PROPOSED CABLE NAME
- XX PROPOSED FIBER COUNT
- 06-XXXX FUTURE SIGNAL

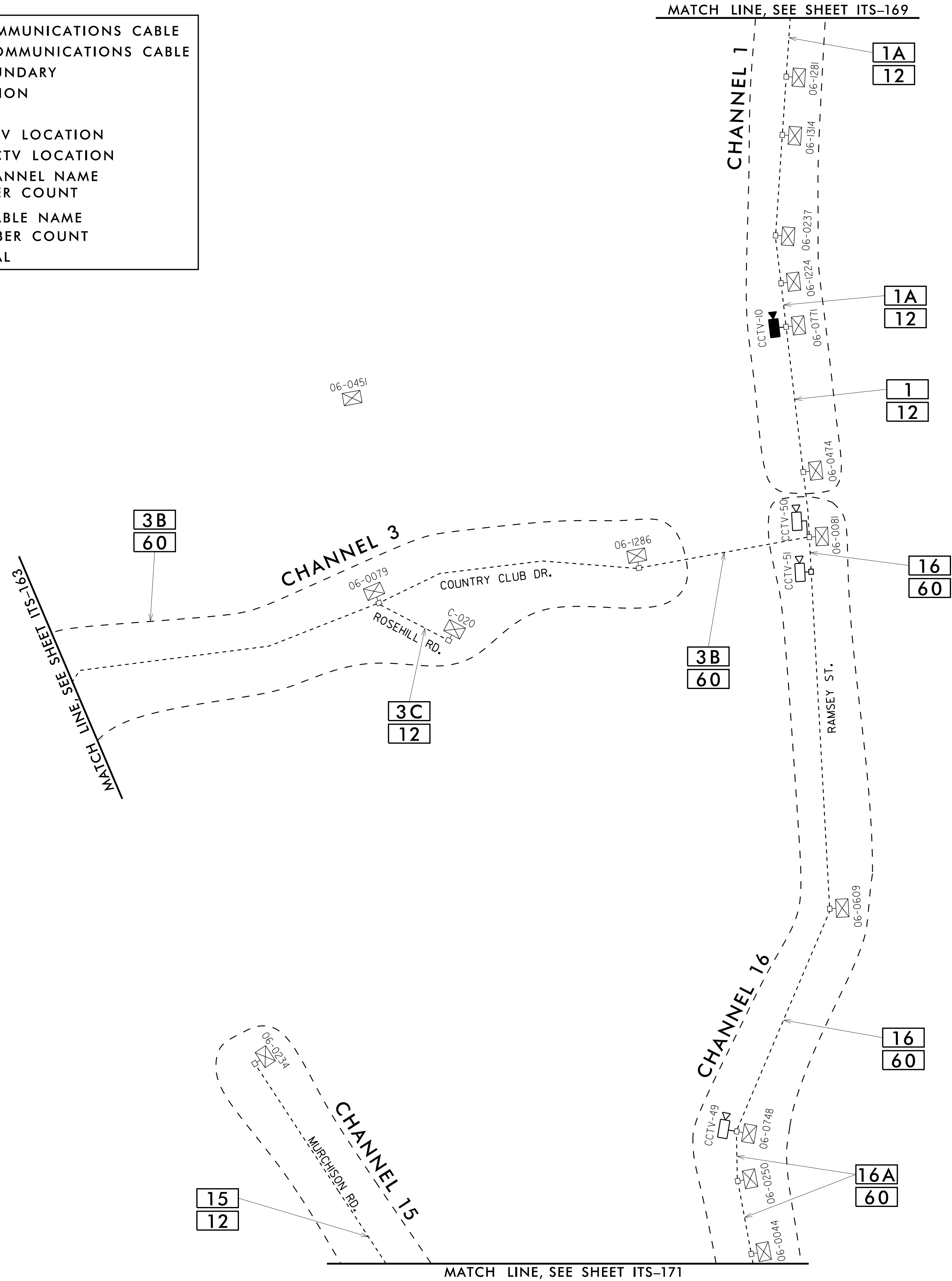

11/15/2016 K:\ARL\TPTD\ITS\01036305 - Fayetteville Sig Sys\Plans\Splicing\01036305-ITS\_psh\_170-schm9.dgn

**Kimley Horn**  
 NC License #F-0102  
 421 Fayetteville St., Suite 600  
 Raleigh, NC 27636  
 Tel: (919) 677-2000  
 Fax: (919) 677-2050

Plans Prepared For:  
 Transportation Mobility and Safety Division  
 NORTH CAROLINA DEPARTMENT OF TRANSPORTATION  
 250 N. Greenfield Place - Garner, NC 27529

| <b>FAYETTEVILLE COMPUTERIZED SIGNAL SYSTEM</b> |                          |      |
|--|--------------------------|------|
| <b>CABLE SCHEMATIC</b>                         |                          |      |
| DIVISION 06                                    | CUMBERLAND COUNTY        |      |
| PLAN DATE: NOVEMBER 2016                       | REVIEWED BY: K. NICHOLAS |      |
| PREPARED BY: J. CROSS                          | REVIEWED BY: K. SMITH    |      |
| REVISIONS                                      | INIT.                    | DATE |
|  |                          |      |
|  |                          |      |
|  |                          |      |

SEAL

NORTH CAROLINA PROFESSIONAL ENGINEER  
 SEAL  
 030472  
 KEVIN W. SMITH

11/15/2016  
 DATE

CADD File name:

MATCH LINE, SEE SHEET ITS-171

MATCH LINE, SEE SHEET ITS-169

----- EXISTING COMMUNICATIONS CABLE  
 ——— PROPOSED COMMUNICATIONS CABLE  
 - - - CHANNEL BOUNDARY  
 □ SPlice LOCATION  
 ⊠ CABINET  
 ■ EXISTING CCTV LOCATION  
 □ PROPOSED CCTV LOCATION  
 XX EXISTING CABLE NAME (TOP) AND EXISTING FIBER COUNT (BOTTOM)  
 XX PROPOSED CABLE NAME (TOP) AND PROPOSED FIBER COUNT (BOTTOM)  
 06-XXXX FUTURE NCDOT SIGNAL  
 C-XXX FUTURE CITY SIGNAL

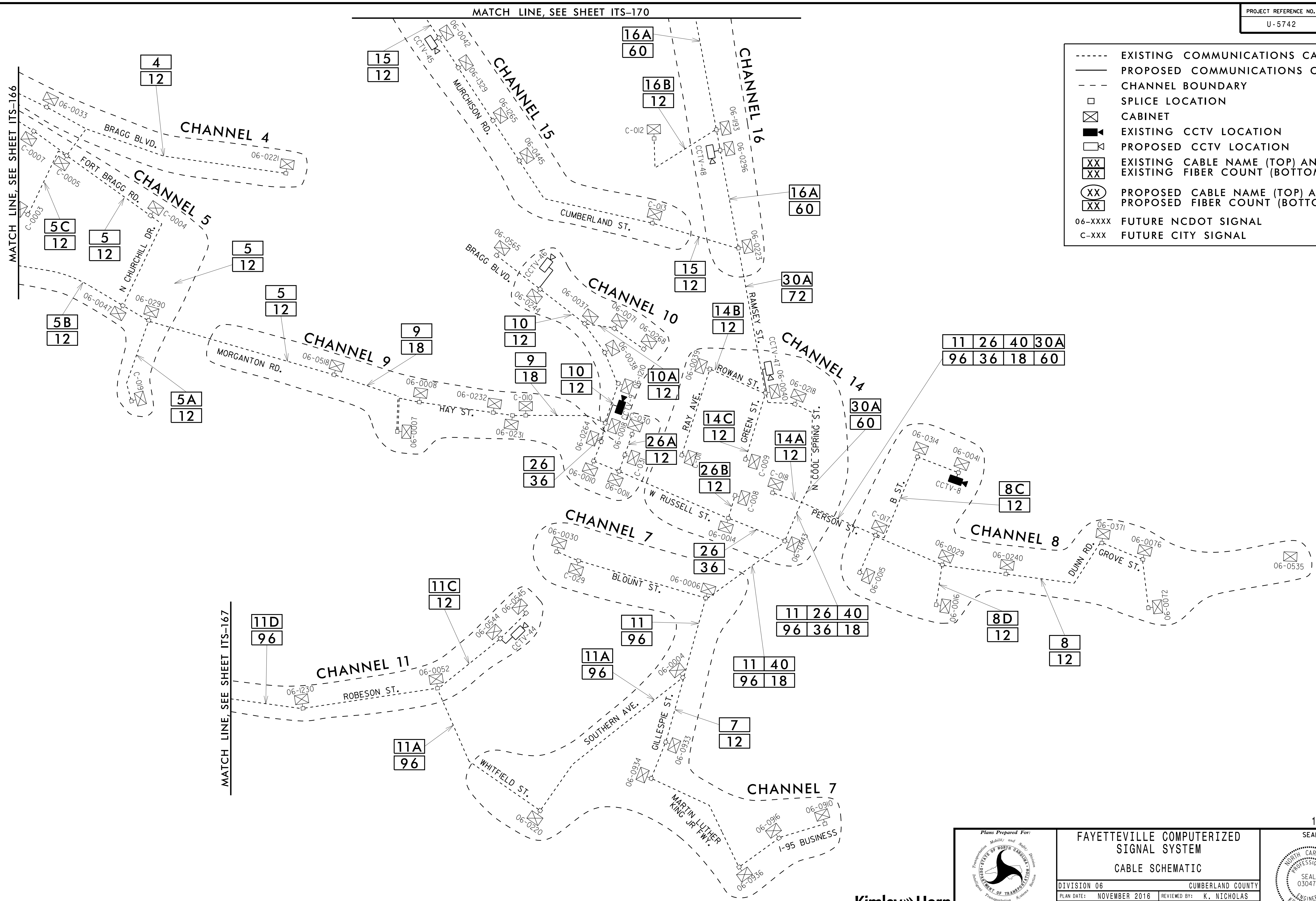

11/15/2016 K:\ARL\TPTD\ITS\01036305 - Fayetteville Sig Sys\Plans\Splicing\01036305-ITS\_psh\171-schml0.dgn

**Kimley»Horn**  
 NC License #F-0102  
 421 Fayetteville St., Suite 600  
 Raleigh, NC 27636  
 Tel: (919) 677-2000  
 Fax: (919) 677-2050

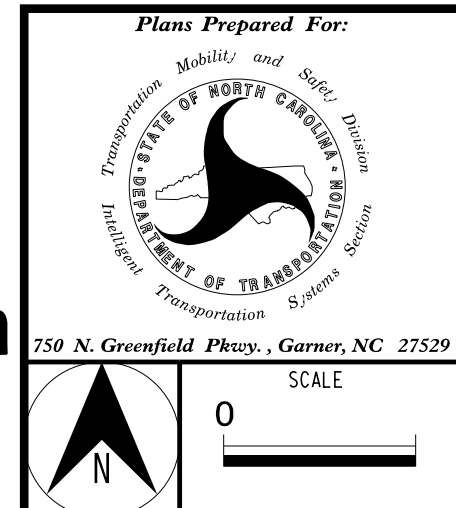

|  |                          |   |
|--|--------------------------|---|
| <b>FAYETTEVILLE COMPUTERIZED SIGNAL SYSTEM</b> |                          | SEAL<br>NORTH CAROLINA PROFESSIONAL ENGINEER<br>SEAL 030472<br>KEVIN W. SMITH |
| <b>CABLE SCHEMATIC</b>                         |                          |   |
| DIVISION 06 CUMBERLAND COUNTY                  |                          | DocuSigned by:<br>Kevin W. Smith<br>11/15/2016                                |
| PLAN DATE: NOVEMBER 2016                       | REVIEWED BY: K. NICHOLAS |   |
| PREPARED BY: J. CROSS                          | REVIEWED BY: K. SMITH    | SIGNATURE DATE  |
| REVISIONS                                      | INIT. DATE               |   |
| CADD File name:                                |                          |   |

- EXISTING COMMUNICATIONS CABLE
- PROPOSED COMMUNICATIONS CABLE
- - - CHANNEL BOUNDARY
- SPLICE LOCATION
- ⊠ CABINET
- ◼ EXISTING CCTV LOCATION
- ◻ PROPOSED CCTV LOCATION
- XX EXISTING CABLE NAME (TOP) AND EXISTING FIBER COUNT (BOTTOM)
- XX PROPOSED CABLE NAME (TOP) AND PROPOSED FIBER COUNT (BOTTOM)
- 06-XXXX FUTURE NCDOT SIGNAL
- C-XXX FUTURE CITY SIGNAL

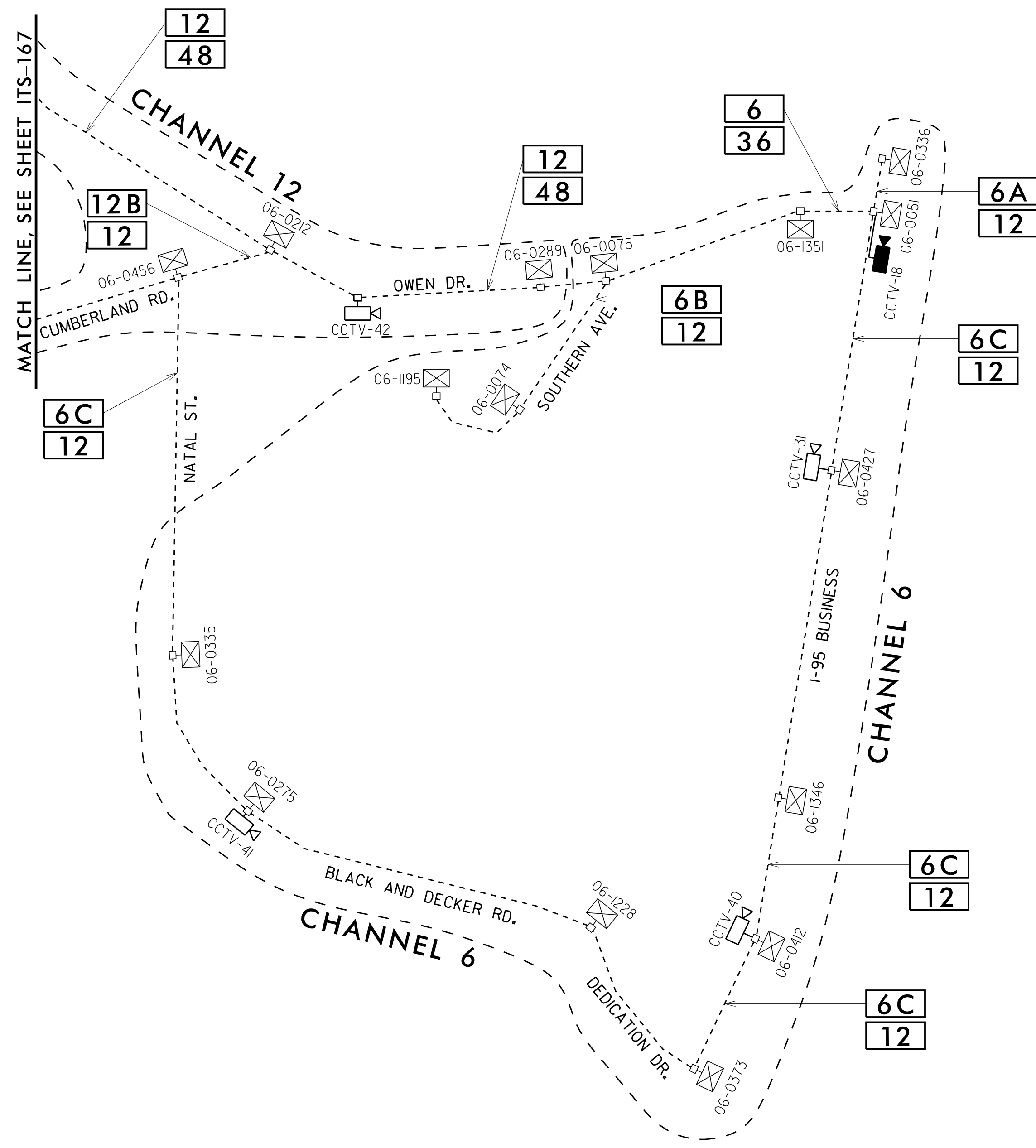

11/15/2016 K:\ARL\TPTD\_ITS\01036305 - Fayetteville Sig Sys\Plans\Splicing\01036305-ITS\_psh\_172-schml.dgn

**Kimley»Horn**  
 NC License #F-0102  
 421 Fayetteville St., Suite 600  
 Raleigh, NC 27636  
 Tel: (919) 677-2000  
 Fax: (919) 677-2050

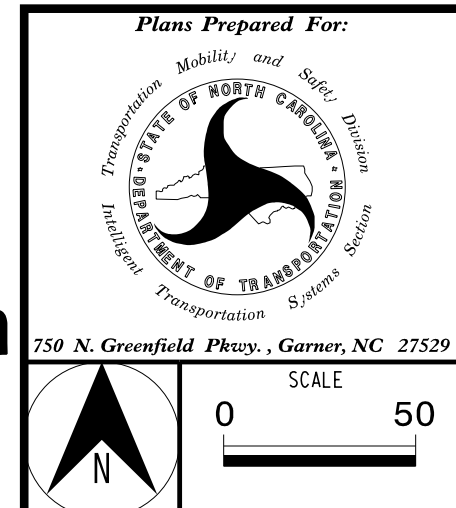

|  |                          |   |
|--|--------------------------|---|
| <b>FAYETTEVILLE COMPUTERIZED SIGNAL SYSTEM</b> |                          | SEAL<br>NORTH CAROLINA PROFESSIONAL ENGINEER<br>SEAL 030472<br>KEVIN W. SMITH                       |
| <b>CABLE SCHEMATIC</b>                         |                          |   |
| DIVISION 06 CUMBERLAND COUNTY                  |                          | DocuSigned by:<br>Kevin W. Smith<br>0688E4B8B440F<br>SIGNATURE DATE<br>11/15/2016<br>CADD Filename: |
| PLAN DATE: NOVEMBER 2016                       | REVIEWED BY: K. NICHOLAS |   |
| PREPARED BY: J. CROSS                          | REVIEWED BY: K. SMITH    |   |
| REVISIONS                                      | INIT.                    | DATE  |
|  |                          |   |



**CHANNEL 1 EXTENSION  
EXISTING SPLICE ENCLOSURE  
US 401 (RAMSEY ST) AND NORTHGATE  
SHOPPING CENTER DRIVEWAY  
SIG ID 06-0771  
CCTV 10**

**COLOR CODE**  
TIA/EIA 598-C

|            |             |
|------------|-------------|
| (1) BLUE   | (7) RED     |
| (2) ORANGE | (8) BLACK   |
| (3) GREEN  | (9) YELLOW  |
| (4) BROWN  | (10) VIOLET |
| (5) SLATE  | (11) ROSE   |
| (6) WHITE  | (12) AQUA   |

**LEGEND**

X - FUSION SPLICE INDIVIDUAL FIBER  
 O - EXISTING SPLICE  
 □ - EXPRESS INDIVIDUAL FIBER

EXPRESS - EXPRESS ENTIRE BUFFER TUBE  
 SPLICE - SPLICE ENTIRE BUFFER TUBE OR MAINTAIN IF EXISTING EXPRESSED

**NOTES:**

- FIBER INTERCONNECT CENTER RACKS ARE SCHEMATIC ONLY - ACTUAL EQUIPMENT FORM MAY VARY.
- ETHERNET SWITCH TERMINATION CONFIGURATIONS ARE GENERIC. CONTRACTOR IS RESPONSIBLE FOR DETERMINING /ENSURING PROPER TERMINATION.
- CONTRACTOR IS RESPONSIBLE FOR FIELD VERIFYING EXISTING SPLICING. THE CONTRACTOR SHALL COORDINATE WITH THE ENGINEER WHERE EXISTING SPLICING IS NOT AS EXPECTED.

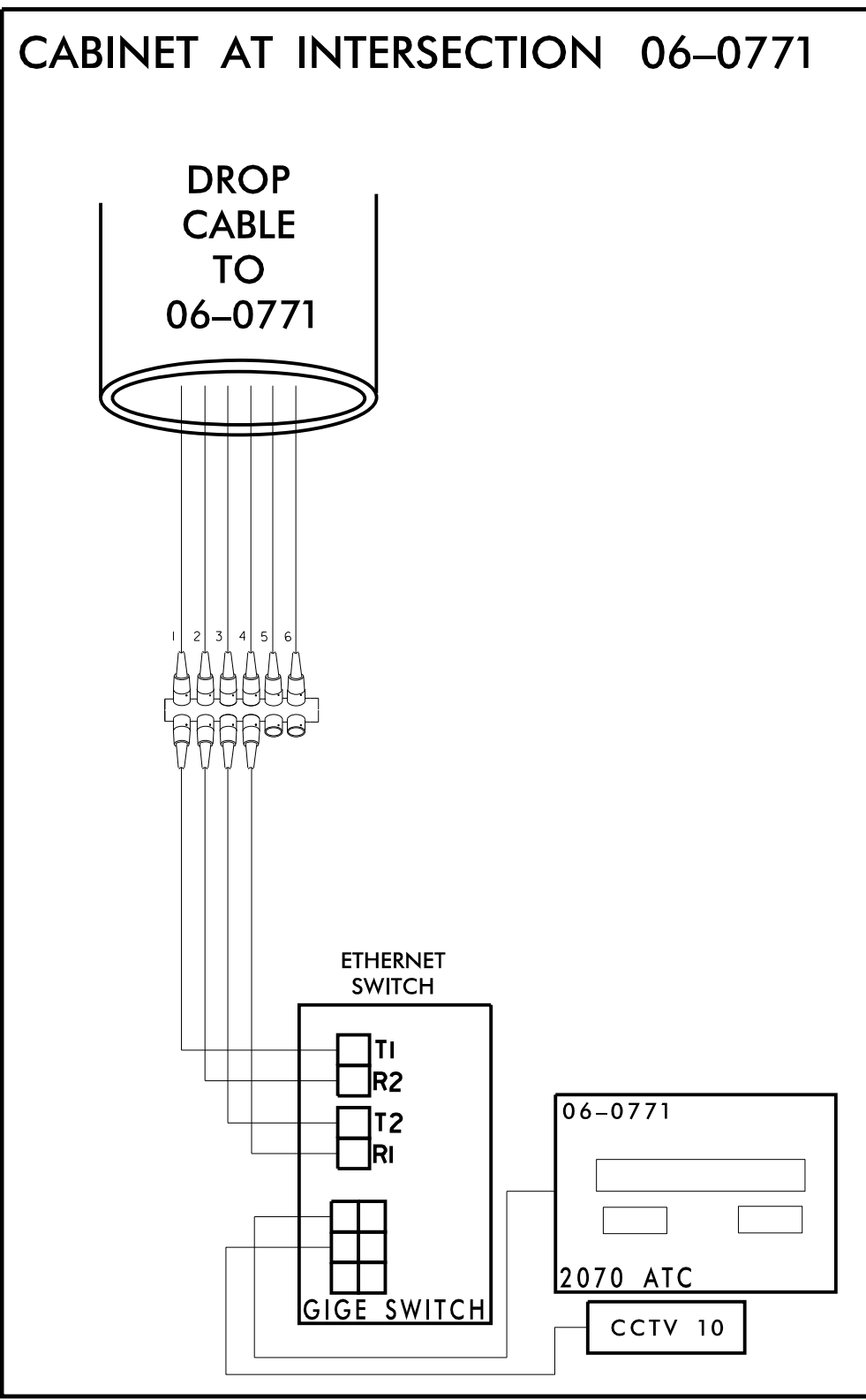
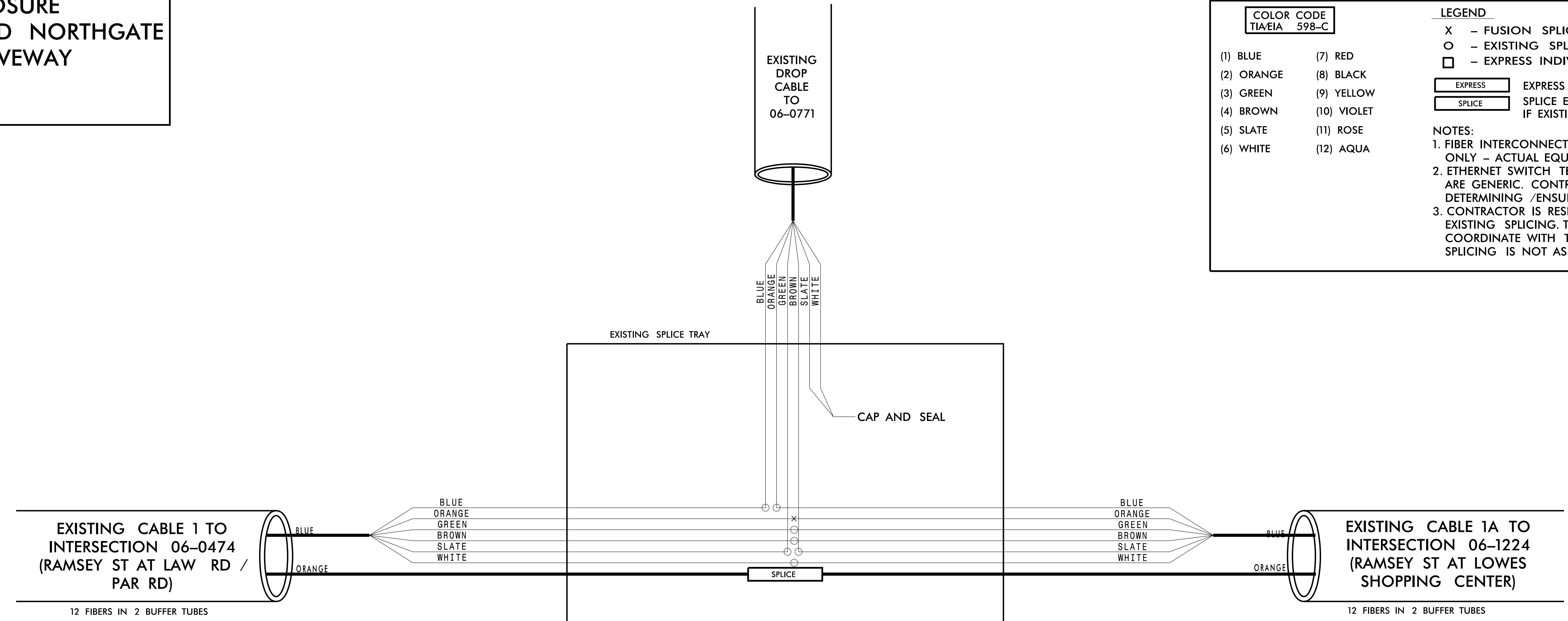

**CHANNEL 1 EXTENSION**

**FAYETTEVILLE COMPUTERIZED SIGNAL SYSTEM  
SPLICE DETAIL**

DIVISION 06 CUMBERLAND COUNTY

PLAN DATE: NOVEMBER 2016 REVIEWED BY: N. M. MENGELKOCH

PREPARED BY: KHA REVIEWED BY: K. W. SMITH

| REVISIONS | INIT. | DATE |
|-----------|-------|------|
|           |       |      |
|           |       |      |

SCALE: 0

Kimley»Horn  
 NC License #F-0102  
 421 Fayetteville St., Suite 600  
 Raleigh, NC 27636  
 Tel: (919) 677-2000  
 Fax: (919) 677-2050

Seal: NORTH CAROLINA PROFESSIONAL ENGINEER KEVIN W. SMITH SEAL 030472

Signature: Kevin W. Smith DATE: 11/15/2016

11/15/2016 K:\ARL\TPTD\ITS\01036305 - Fayetteville Sig Sys\Plans\Splicing\01036305-ITS\_psh.IT3-CHCCTV Harvest at 071.dgn

**CHANNEL 1 EXTENSION  
EXISTING SPLICE ENCLOSURE  
(US 401 (RAMSEY ST) AND  
MEDOWCROFT DR /  
NORTH WAL-MART ENTRANCE)  
SIG ID 06-1280  
CCTV 20**

**COLOR CODE**  
TIA/EIA 598-C

|            |             |
|------------|-------------|
| (1) BLUE   | (7) RED     |
| (2) ORANGE | (8) BLACK   |
| (3) GREEN  | (9) YELLOW  |
| (4) BROWN  | (10) VIOLET |
| (5) SLATE  | (11) ROSE   |
| (6) WHITE  | (12) AQUA   |

**LEGEND**

- X - FUSION SPLICE INDIVIDUAL FIBER
- O - EXISTING SPLICE
- - EXPRESS INDIVIDUAL FIBER
- EXPRESS - EXPRESS ENTIRE BUFFER TUBE
- SPLICE - SPLICE ENTIRE BUFFER TUBE OR MAINTAIN IF EXISTING EXPRESSED

**NOTES:**

- FIBER INTERCONNECT CENTER RACKS ARE SCHEMATIC ONLY - ACTUAL EQUIPMENT FORM MAY VARY.
- ETHERNET SWITCH TERMINATION CONFIGURATIONS ARE GENERIC. CONTRACTOR IS RESPONSIBLE FOR DETERMINING /ENSURING PROPER TERMINATION.
- CONTRACTOR IS RESPONSIBLE FOR FIELD VERIFYING EXISTING SPLICING. THE CONTRACTOR SHALL COORDINATE WITH THE ENGINEER WHERE EXISTING SPLICING IS NOT AS EXPECTED.

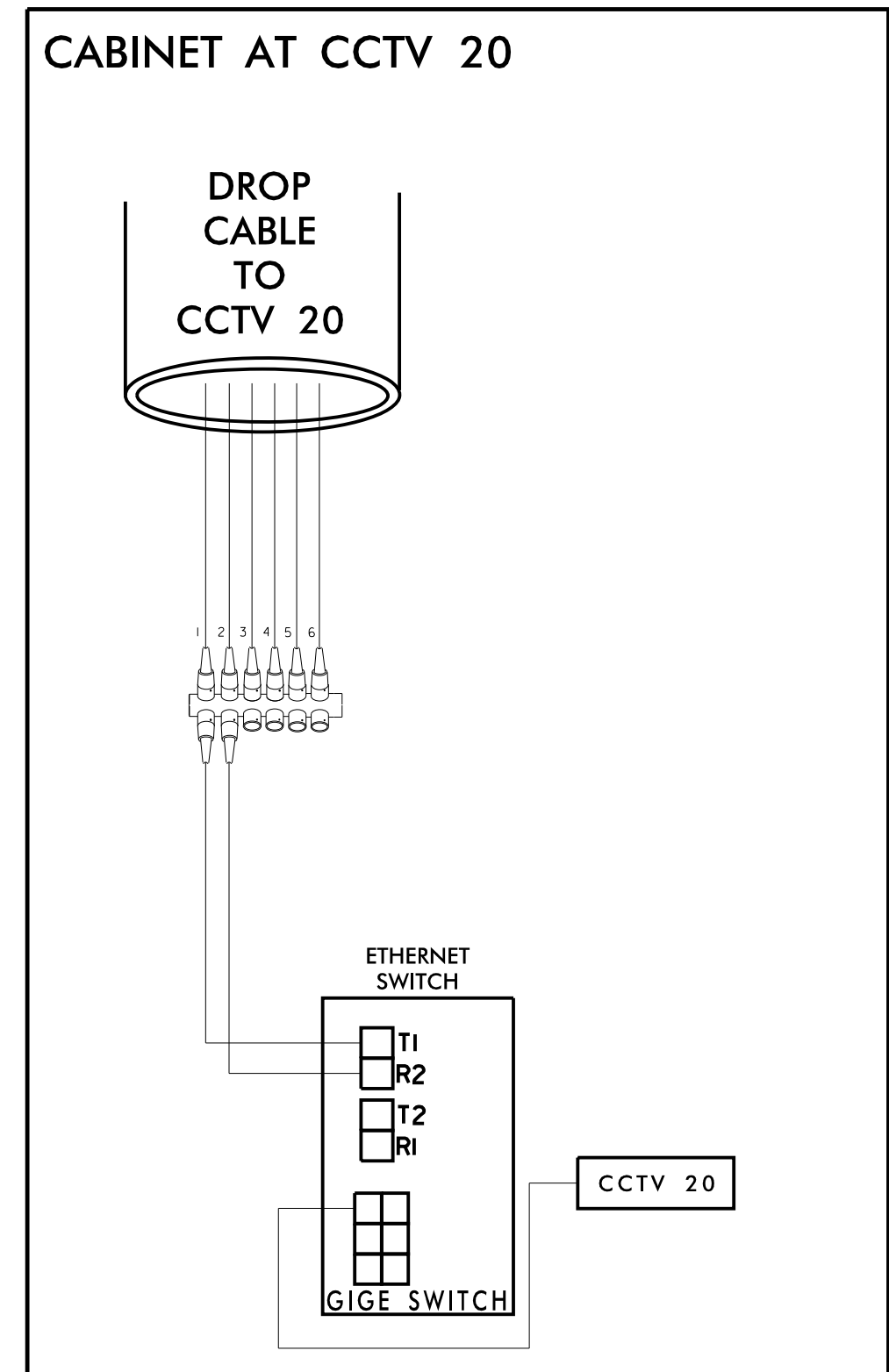
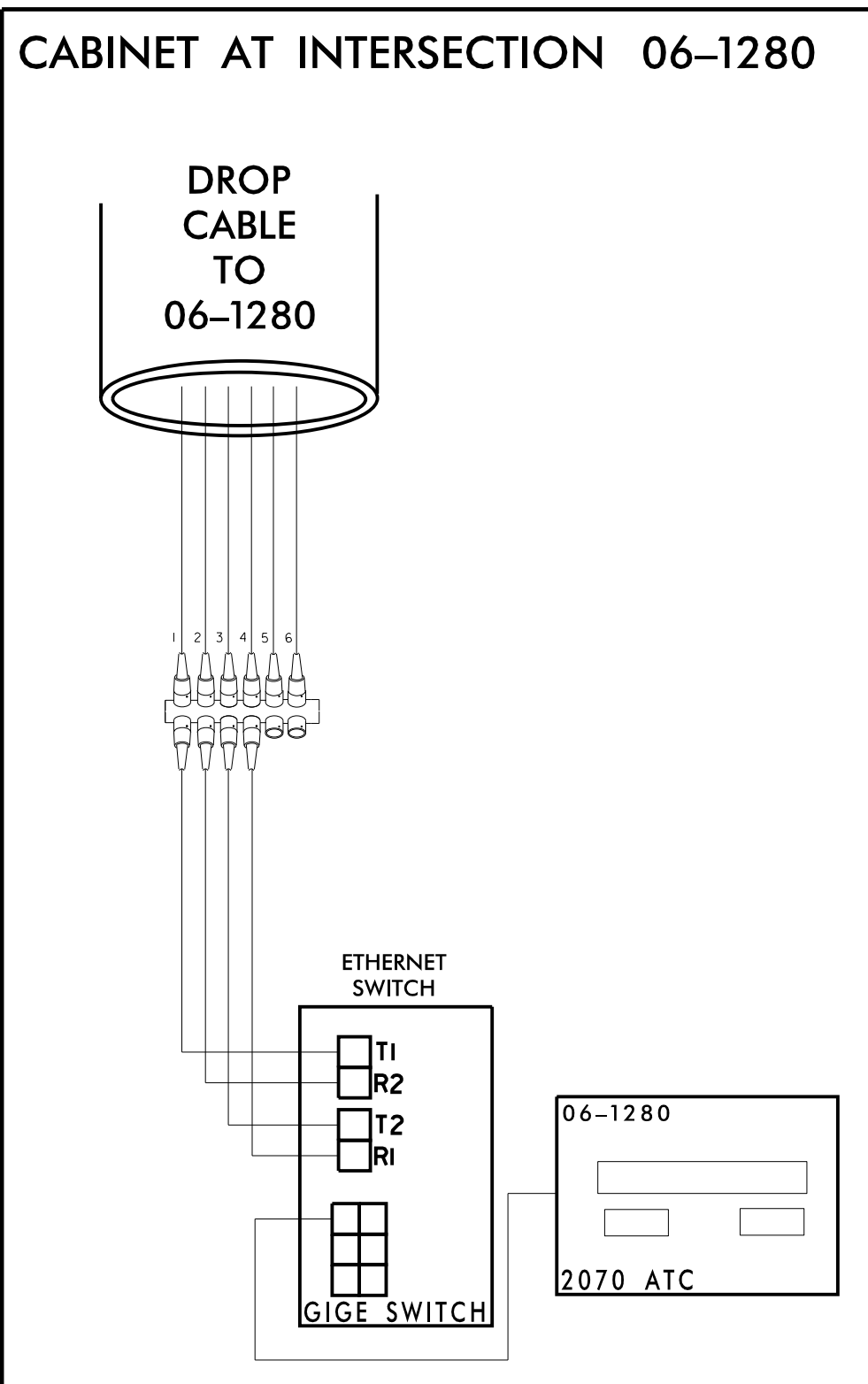
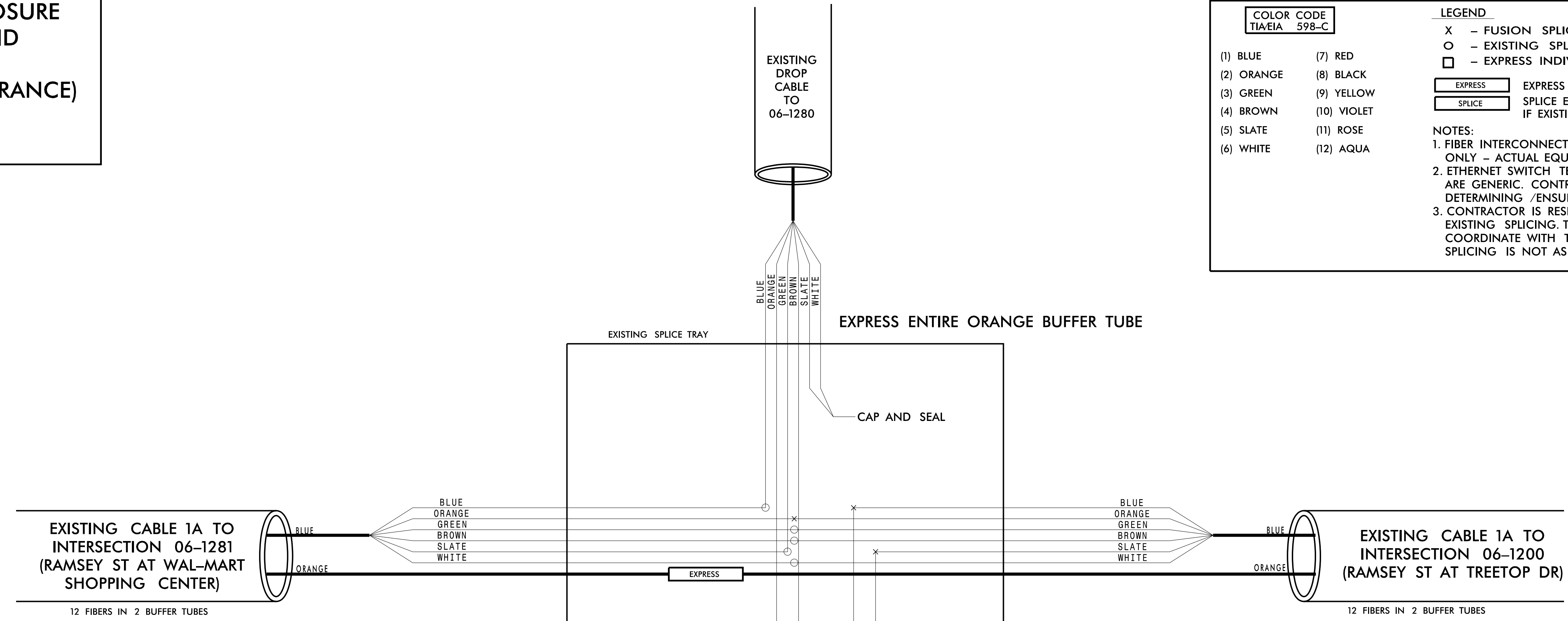

**CHANNEL 1 EXTENSION**

**FAYETTEVILLE COMPUTERIZED SIGNAL SYSTEM**

**SPLICE DETAIL**

DIVISION 06 CUMBERLAND COUNTY

PLAN DATE: NOVEMBER 2016 REVIEWED BY: N.M. MENGELKOCH

PREPARED BY: KHA REVIEWED BY: K.W. SMITH

250 N. Greenfield Place, Garner, NC 27529

SCALE: 0

**Kimley»Horn**  
NC License #F-0102  
421 Fayetteville St., Suite 600  
Raleigh, NC 27636  
Tel: (919) 677-2000  
Fax: (919) 677-2050

SEAL  
NORTH CAROLINA PROFESSIONAL ENGINEER  
SEAL 030472  
KEVIN W. SMITH

11/15/2016

11/15/2016 K:\ARL\TPTD\ITS\01036305 - Fayetteville Sig Sys\Plans\Splicing\01036305-ITS\_psh\14-CHCCTV Harvest at 1280.dgn

**CHANNEL 1  
EXISTING SPLICE ENCLOSURE  
(RAMSEY ST AT STACEY WEAVER DR)  
SIG ID 06-0448**

**COLOR CODE**  
TIA/EIA 598-C

|            |             |
|------------|-------------|
| (1) BLUE   | (7) RED     |
| (2) ORANGE | (8) BLACK   |
| (3) GREEN  | (9) YELLOW  |
| (4) BROWN  | (10) VIOLET |
| (5) SLATE  | (11) ROSE   |
| (6) WHITE  | (12) AQUA   |

**LEGEND**

X - FUSION SPLICE INDIVIDUAL FIBER  
 O - EXISTING SPLICE  
 □ - EXPRESS INDIVIDUAL FIBER

EXPRESS - EXPRESS ENTIRE BUFFER TUBE  
 SPLICE - SPLICE ENTIRE BUFFER TUBE OR MAINTAIN IF EXISTING EXPRESSED

**NOTES:**

- FIBER INTERCONNECT CENTER RACKS ARE SCHEMATIC ONLY - ACTUAL EQUIPMENT FORM MAY VARY.
- ETHERNET SWITCH TERMINATION CONFIGURATIONS ARE GENERIC. CONTRACTOR IS RESPONSIBLE FOR DETERMINING /ENSURING PROPER TERMINATION.
- CONTRACTOR IS RESPONSIBLE FOR FIELD VERIFYING EXISTING SPLICING. THE CONTRACTOR SHALL COORDINATE WITH THE ENGINEER WHERE EXISTING SPLICING IS NOT AS EXPECTED.

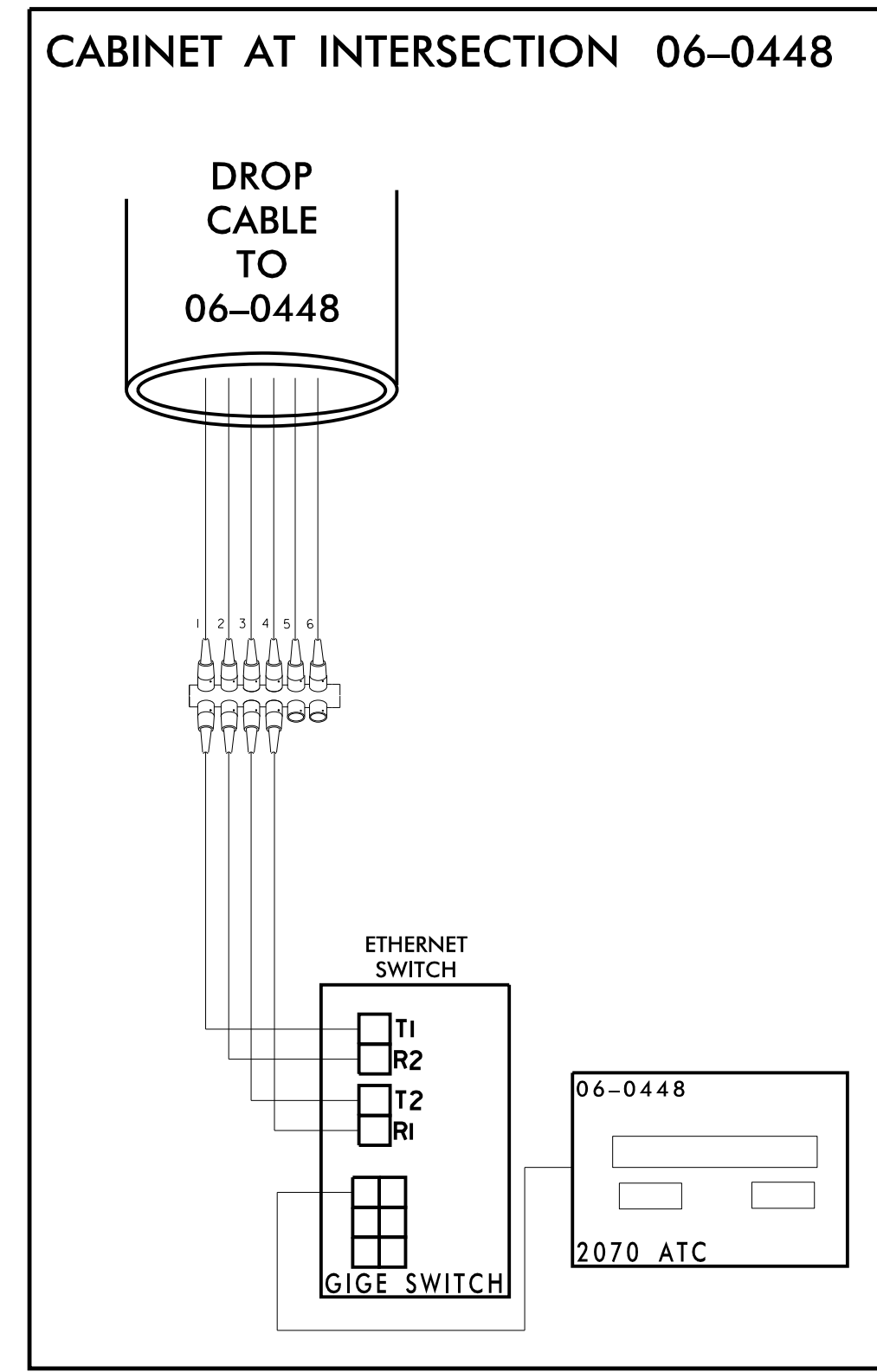
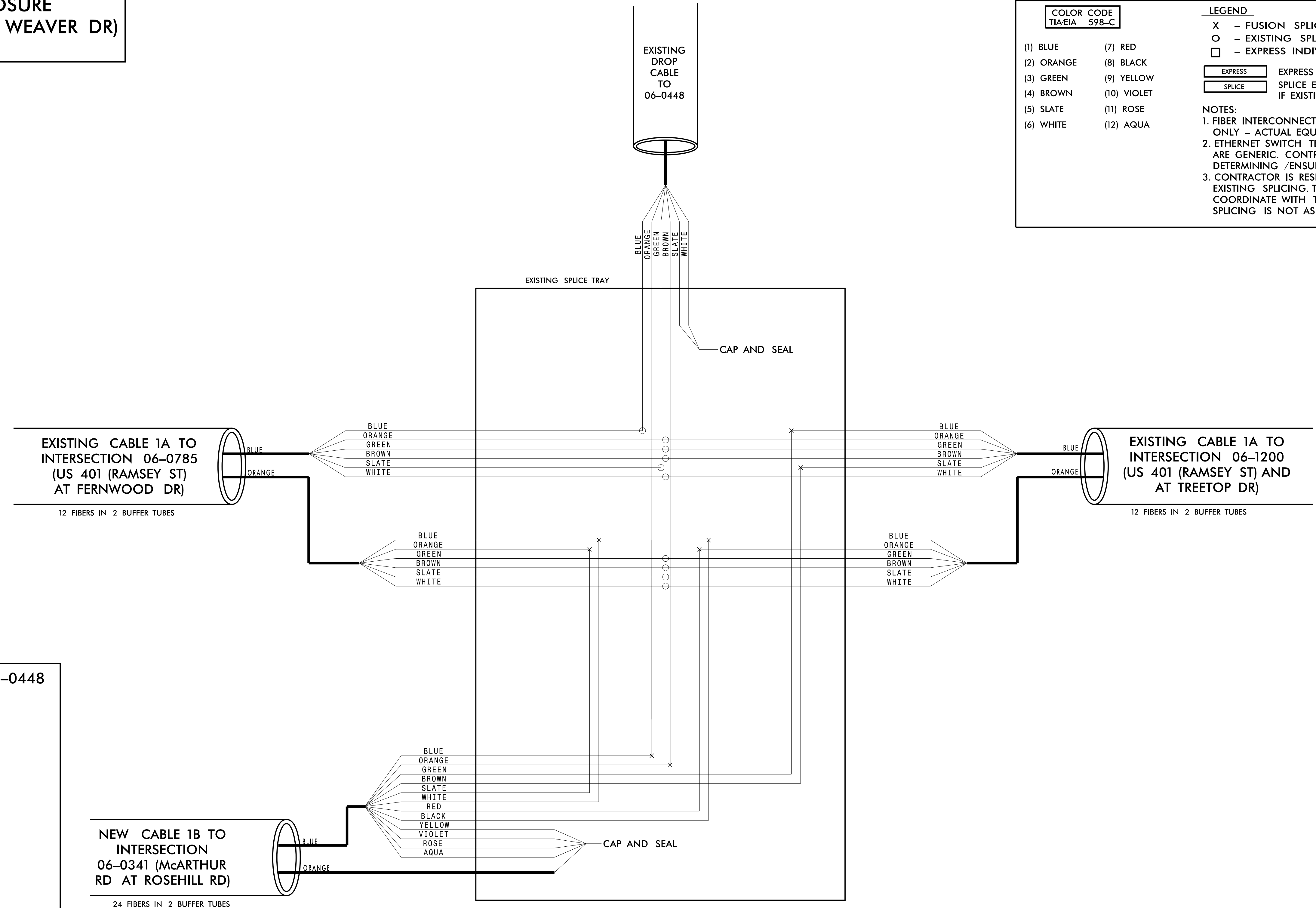

11/15/2016 K:\ARL\TPTD\ITS\01036305 - Fayetteville Sig Sys\Plans\Splicing\01036305-ITS\_psh\_175-CH06-0448.dgn

**CHANNEL 1**

**Kimley»Horn**  
 NC License #F-0102  
 421 Fayetteville St., Suite 600  
 Raleigh, NC 27636  
 Tel: (919) 677-2000  
 Fax: (919) 677-2050

|   |  |  |  |                    |
|---|--|--|--|--------------------|
| Plans Prepared For:<br>                                     |  | <b>FAYETTEVILLE COMPUTERIZED SIGNAL SYSTEM</b><br><b>SPLICE DETAIL</b>         |  | SEAL<br>           |
| DIVISION 06<br>PLAN DATE: NOVEMBER 2016<br>PREPARED BY: KHA |  | CUMBERLAND COUNTY<br>REVIEWED BY: N. M. MENGELKOCH<br>REVIEWED BY: K. W. SMITH |  | DocuSigned by:<br> |
| SCALE<br>0  |  | REVISIONS<br>INIT. DATE  |  | DATE<br>11/15/2016 |
| 250 N. Greenfield Place, Garner, NC 27529                   |  | SIGNATURE<br>DATE  |  | CADD Filename:     |

**CHANNEL 1 EXTENSION  
EXISTING SPLICE ENCLOSURE  
(US 401 (RAMSEY ST) AND NC-295)  
SIG ID 06-1223**

**COLOR CODE**  
TIA/EIA 598-C

|            |             |
|------------|-------------|
| (1) BLUE   | (7) RED     |
| (2) ORANGE | (8) BLACK   |
| (3) GREEN  | (9) YELLOW  |
| (4) BROWN  | (10) VIOLET |
| (5) SLATE  | (11) ROSE   |
| (6) WHITE  | (12) AQUA   |

**LEGEND**

- X - FUSION SPLICE INDIVIDUAL FIBER
- O - EXISTING SPLICE
- - EXPRESS INDIVIDUAL FIBER

**EXPRESS**    EXPRESS ENTIRE BUFFER TUBE  
**SPLICE**      SPLICE ENTIRE BUFFER TUBE OR MAINTAIN IF EXISTING EXPRESSED

**NOTES:**

- FIBER INTERCONNECT CENTER RACKS ARE SCHEMATIC ONLY - ACTUAL EQUIPMENT FORM MAY VARY.
- ETHERNET SWITCH TERMINATION CONFIGURATIONS ARE GENERIC. CONTRACTOR IS RESPONSIBLE FOR DETERMINING /ENSURING PROPER TERMINATION.
- CONTRACTOR IS RESPONSIBLE FOR FIELD VERIFYING EXISTING SPLICING. THE CONTRACTOR SHALL COORDINATE WITH THE ENGINEER WHERE EXISTING SPLICING IS NOT AS EXPECTED.

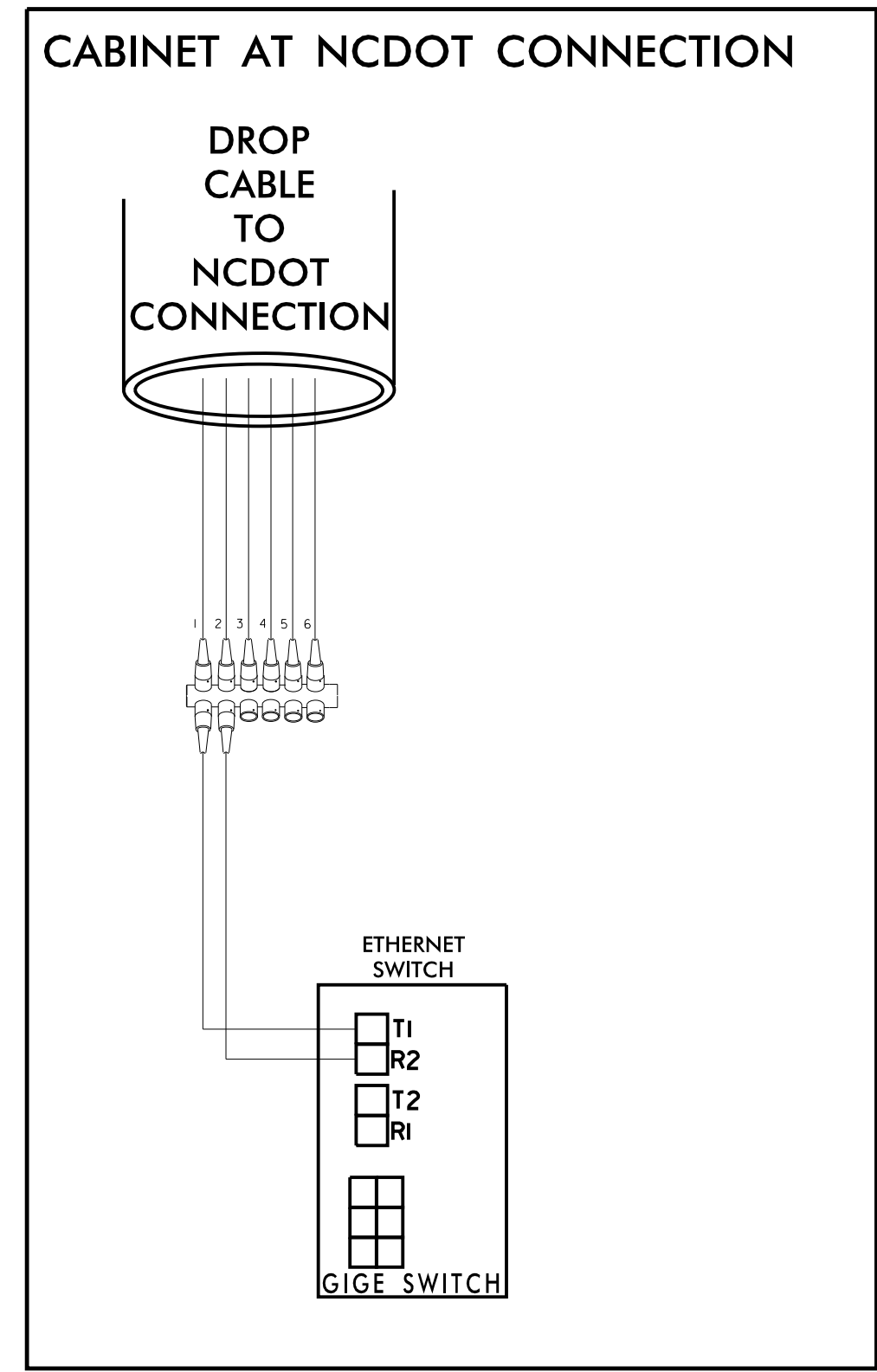
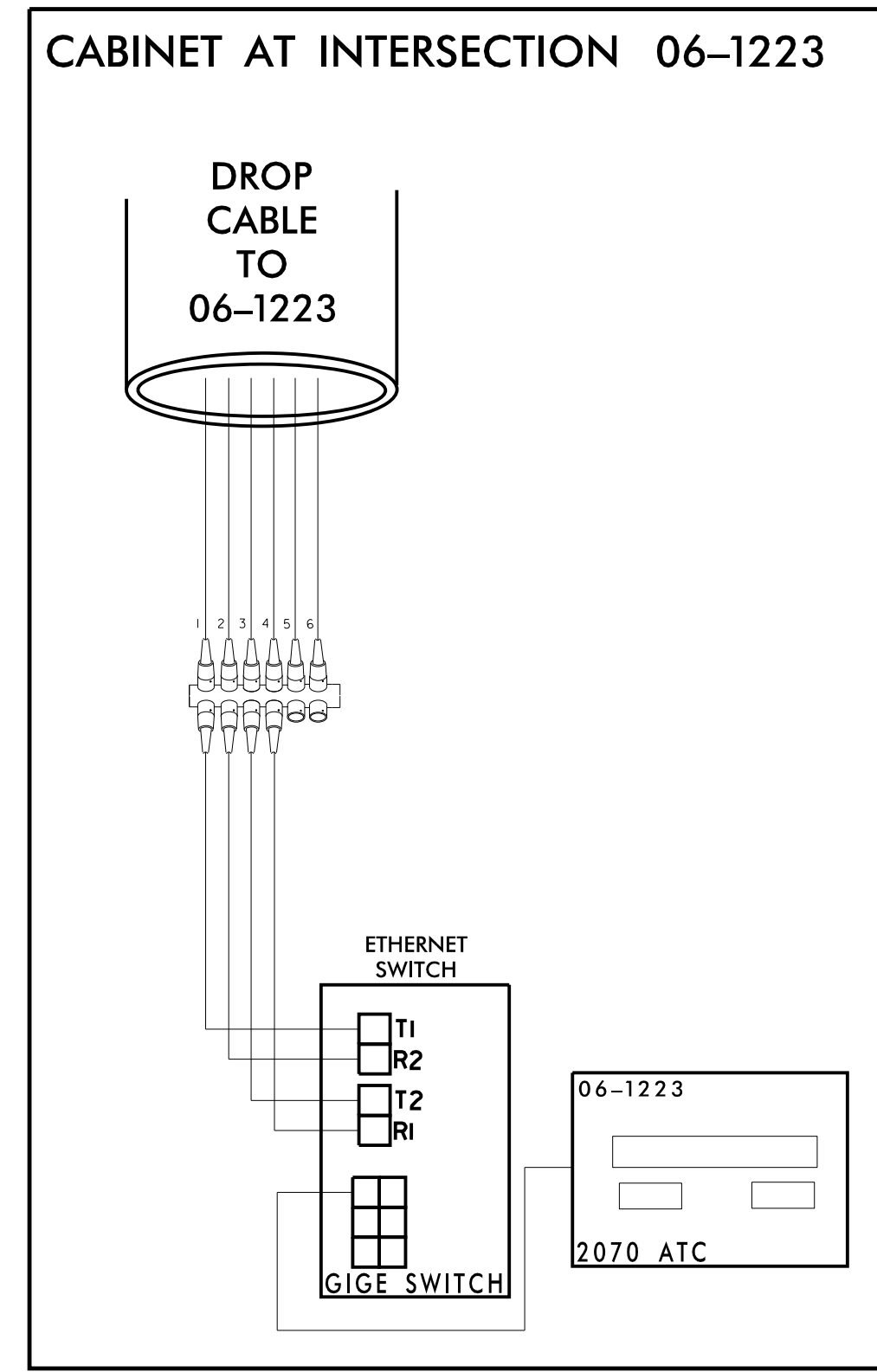
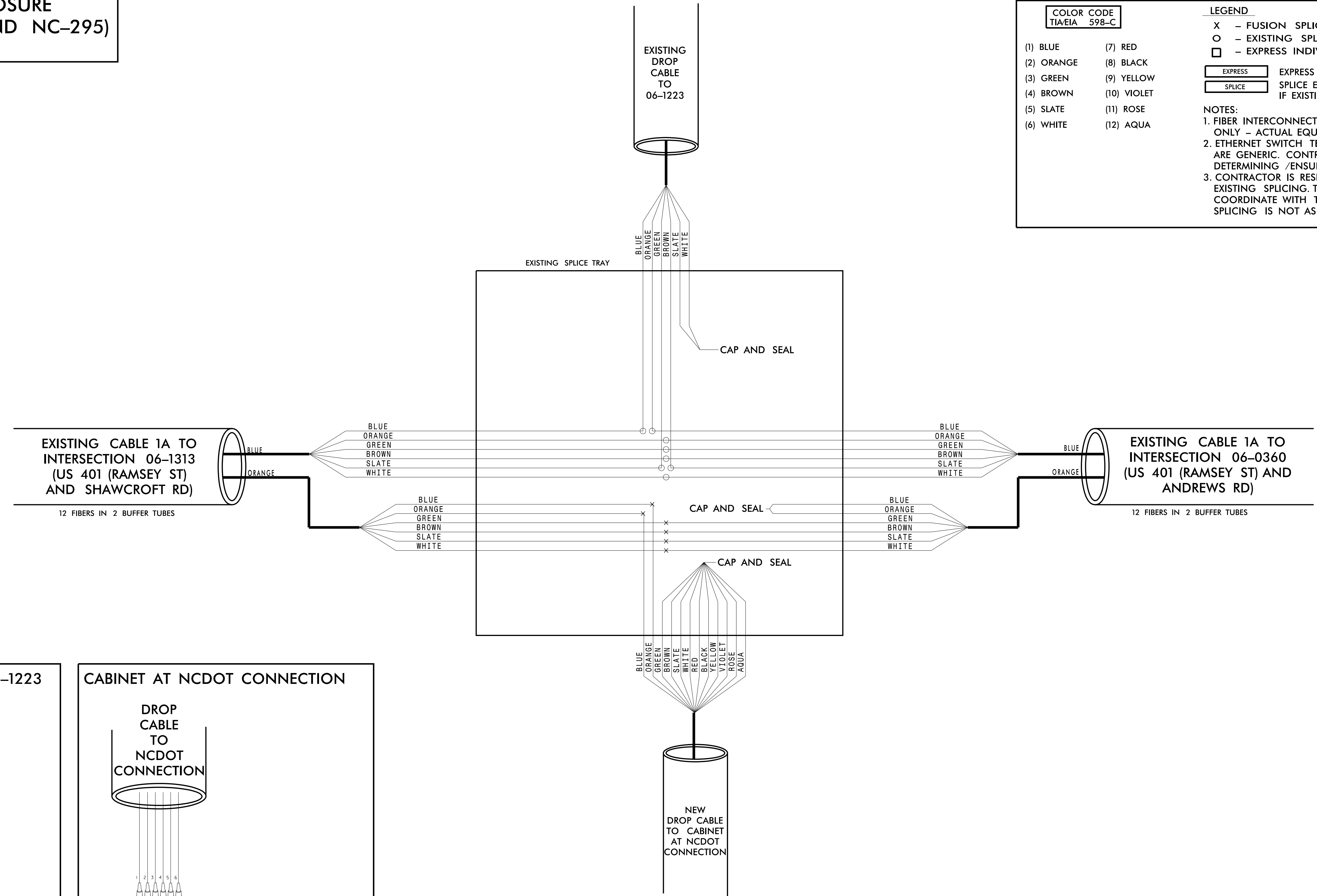

**CHANNEL 1 EXTENSION**

**FAYETTEVILLE COMPUTERIZED SIGNAL SYSTEM**

**SPLICE DETAIL**

DIVISION 06      CUMBERLAND COUNTY

PLAN DATE: NOVEMBER 2016    REVIEWED BY: N.M. MENGELKOCH

PREPARED BY: KHA    REVIEWED BY: K.W. SMITH

250 N. Greenfield Place, Garner, NC 27529

SCALE: 0

| REVISIONS | INIT. | DATE |
|-----------|-------|------|
|           |       |      |

DocuSigned By: *Kevin W. Smith*    11/15/2016

SEAL: NORTH CAROLINA PROFESSIONAL ENGINEER KEVIN W. SMITH SEAL 030472

SIGNATURE: \_\_\_\_\_ DATE: \_\_\_\_\_

CADD Filename: \_\_\_\_\_

**Kimley»Horn**

NC License #F-0102  
421 Fayetteville St., Suite 600  
Raleigh, NC 27636  
Tel: (919) 677-2000  
Fax: (919) 677-2050

11/15/2016 K:\ARL\TPTD\ITS\01036305 - Fayetteville Sig Sys\Plans\Splicing\01036305-ITS\_psh.IT6-CHINCDOT\_AT\_40106-0360.dgn

**CHANNEL 1 EXTENSION  
NEW SPLICE ENCLOSURE  
(McARTHUR RD AT ROSEHILL RD)  
SIG ID 06-0341**

**COLOR CODE**  
TIA/EIA 598-C

|            |             |
|------------|-------------|
| (1) BLUE   | (7) RED     |
| (2) ORANGE | (8) BLACK   |
| (3) GREEN  | (9) YELLOW  |
| (4) BROWN  | (10) VIOLET |
| (5) SLATE  | (11) ROSE   |
| (6) WHITE  | (12) AQUA   |

**LEGEND**

X - FUSION SPLICE INDIVIDUAL FIBER  
 O - EXISTING SPLICE  
 □ - EXPRESS INDIVIDUAL FIBER

EXPRESS - EXPRESS ENTIRE BUFFER TUBE  
 SPLICE - SPLICE ENTIRE BUFFER TUBE OR MAINTAIN IF EXISTING EXPRESSED

**NOTES:**

- FIBER INTERCONNECT CENTER RACKS ARE SCHEMATIC ONLY - ACTUAL EQUIPMENT FORM MAY VARY.
- ETHERNET SWITCH TERMINATION CONFIGURATIONS ARE GENERIC. CONTRACTOR IS RESPONSIBLE FOR DETERMINING /ENSURING PROPER TERMINATION.
- CONTRACTOR IS RESPONSIBLE FOR FIELD VERIFYING EXISTING SPLICING. THE CONTRACTOR SHALL COORDINATE WITH THE ENGINEER WHERE EXISTING SPLICING IS NOT AS EXPECTED.

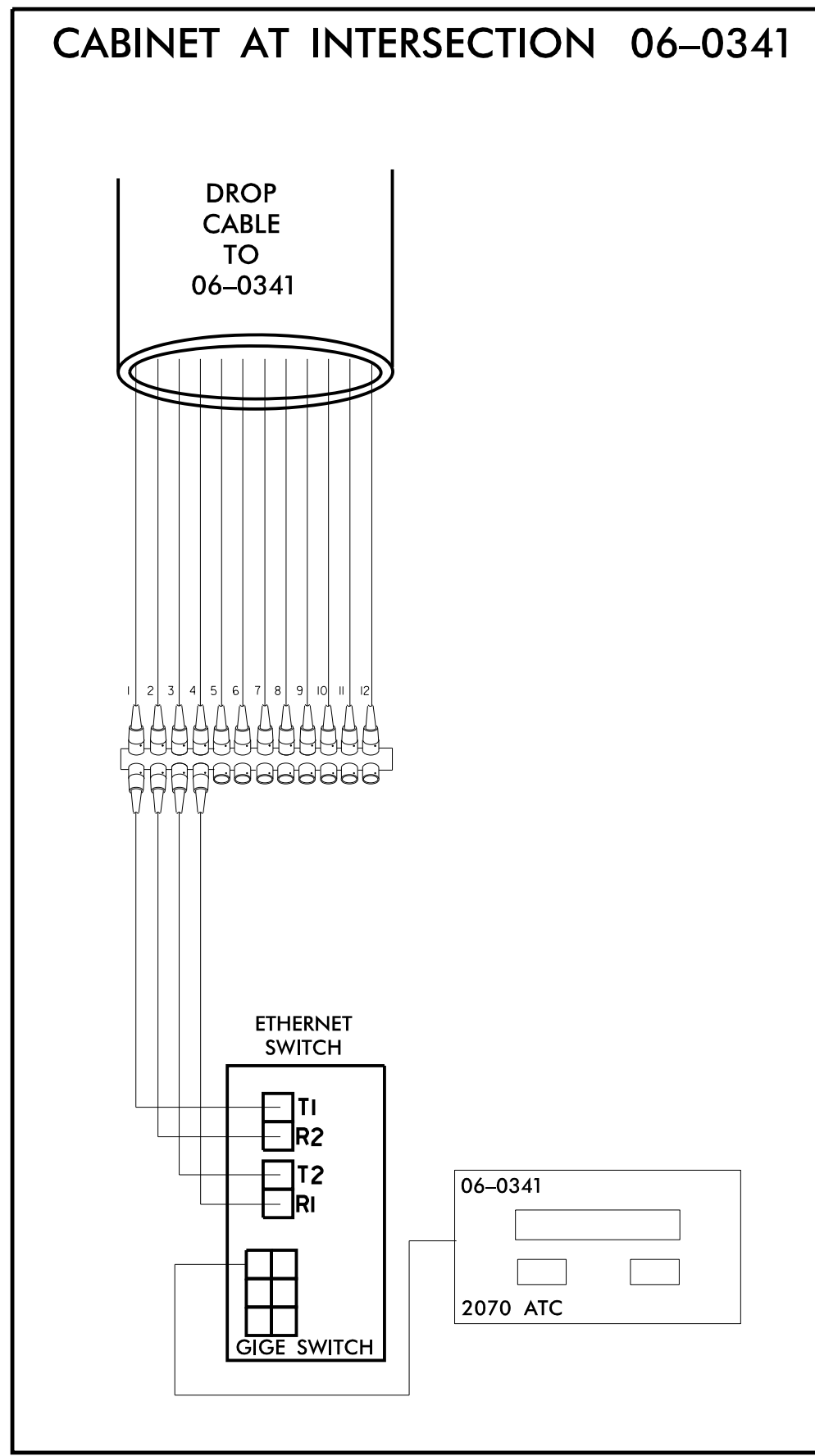
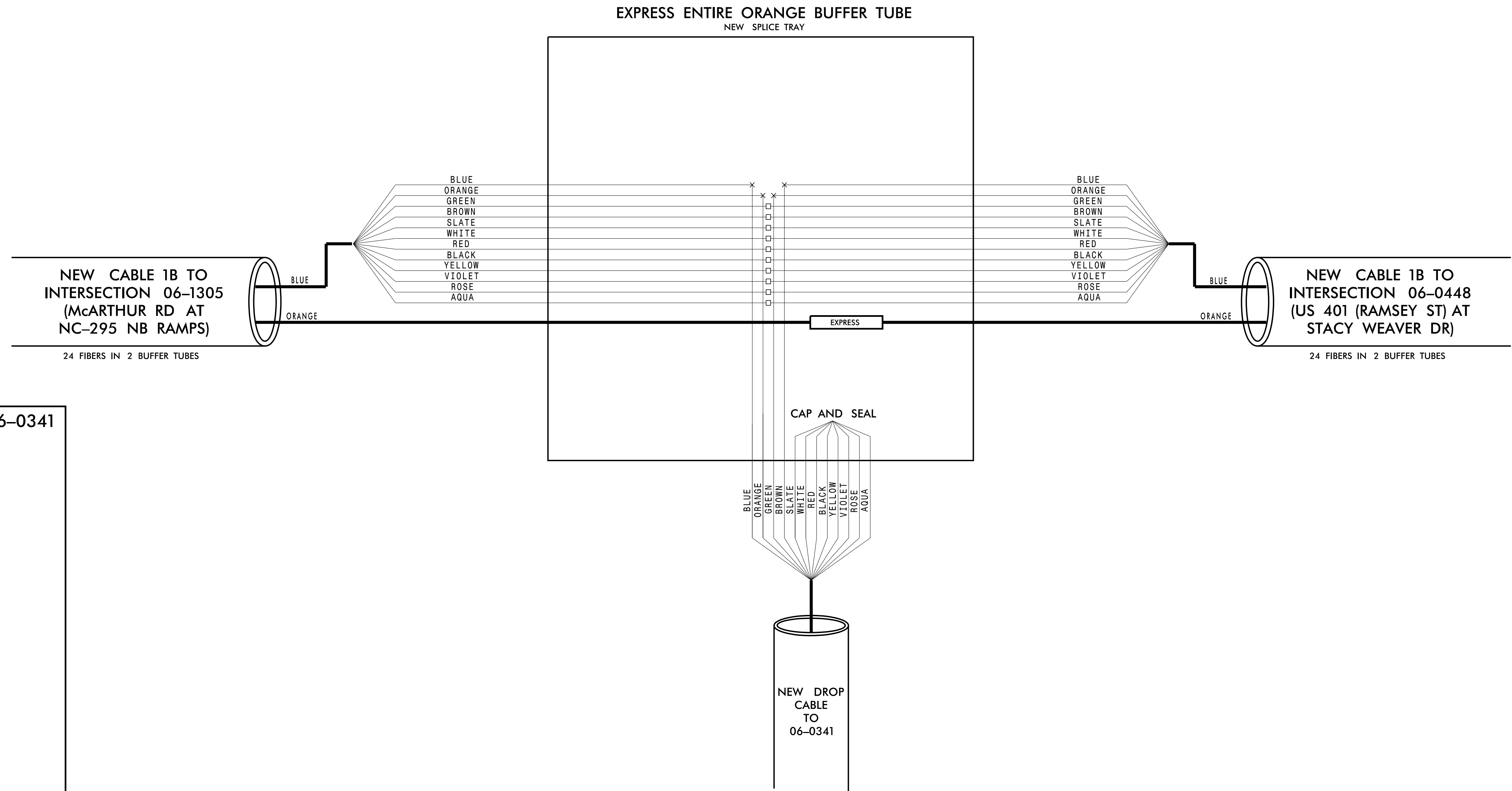

**CHANNEL 1 EXTENSION**

FAYETTEVILLE COMPUTERIZED SIGNAL SYSTEM  
SPLICE DETAIL

DIVISION 06 CUMBERLAND COUNTY

PLAN DATE: NOVEMBER 2016 REVIEWED BY: N. M. MENGELKOCH

PREPARED BY: KHA REVIEWED BY: K. W. SMITH

250 N. Greenfield Place, Garner, NC 27529

SCALE: 0

Kimley»Horn  
 NC License #F-0102  
 421 Fayetteville St., Suite 600  
 Raleigh, NC 27636  
 Tel: (919) 677-2000  
 Fax: (919) 677-2050

SEAL  
 NORTH CAROLINA PROFESSIONAL ENGINEER  
 KEVIN W. SMITH  
 SEAL 030472  
 11/15/2016

11/15/2016 K:\ARL\TPTD\ITS\01036305 - Fayetteville Sig Sys\Plans\Splicing\01036305-ITS\_psh\_177-CH06-0341.dgn

**CHANNEL 1 EXTENSION  
NEW SPLICE ENCLOSURE  
(McARTHUR RD AT NC-295  
NB RAMPS)  
SIG ID 06-1305**

**COLOR CODE**  
TIA/EIA 598-C

|            |             |
|------------|-------------|
| (1) BLUE   | (7) RED     |
| (2) ORANGE | (8) BLACK   |
| (3) GREEN  | (9) YELLOW  |
| (4) BROWN  | (10) VIOLET |
| (5) SLATE  | (11) ROSE   |
| (6) WHITE  | (12) AQUA   |

**LEGEND**

- X - FUSION SPLICE INDIVIDUAL FIBER
- - EXISTING SPLICE
- - EXPRESS INDIVIDUAL FIBER

EXPRESS [ ] EXPRESS ENTIRE BUFFER TUBE  
SPLICE [ ] SPLICE ENTIRE BUFFER TUBE OR MAINTAIN IF EXISTING EXPRESSED

**NOTES:**

- FIBER INTERCONNECT CENTER RACKS ARE SCHEMATIC ONLY - ACTUAL EQUIPMENT FORM MAY VARY.
- ETHERNET SWITCH TERMINATION CONFIGURATIONS ARE GENERIC. CONTRACTOR IS RESPONSIBLE FOR DETERMINING /ENSURING PROPER TERMINATION.
- CONTRACTOR IS RESPONSIBLE FOR FIELD VERIFYING EXISTING SPLICING. THE CONTRACTOR SHALL COORDINATE WITH THE ENGINEER WHERE EXISTING SPLICING IS NOT AS EXPECTED.

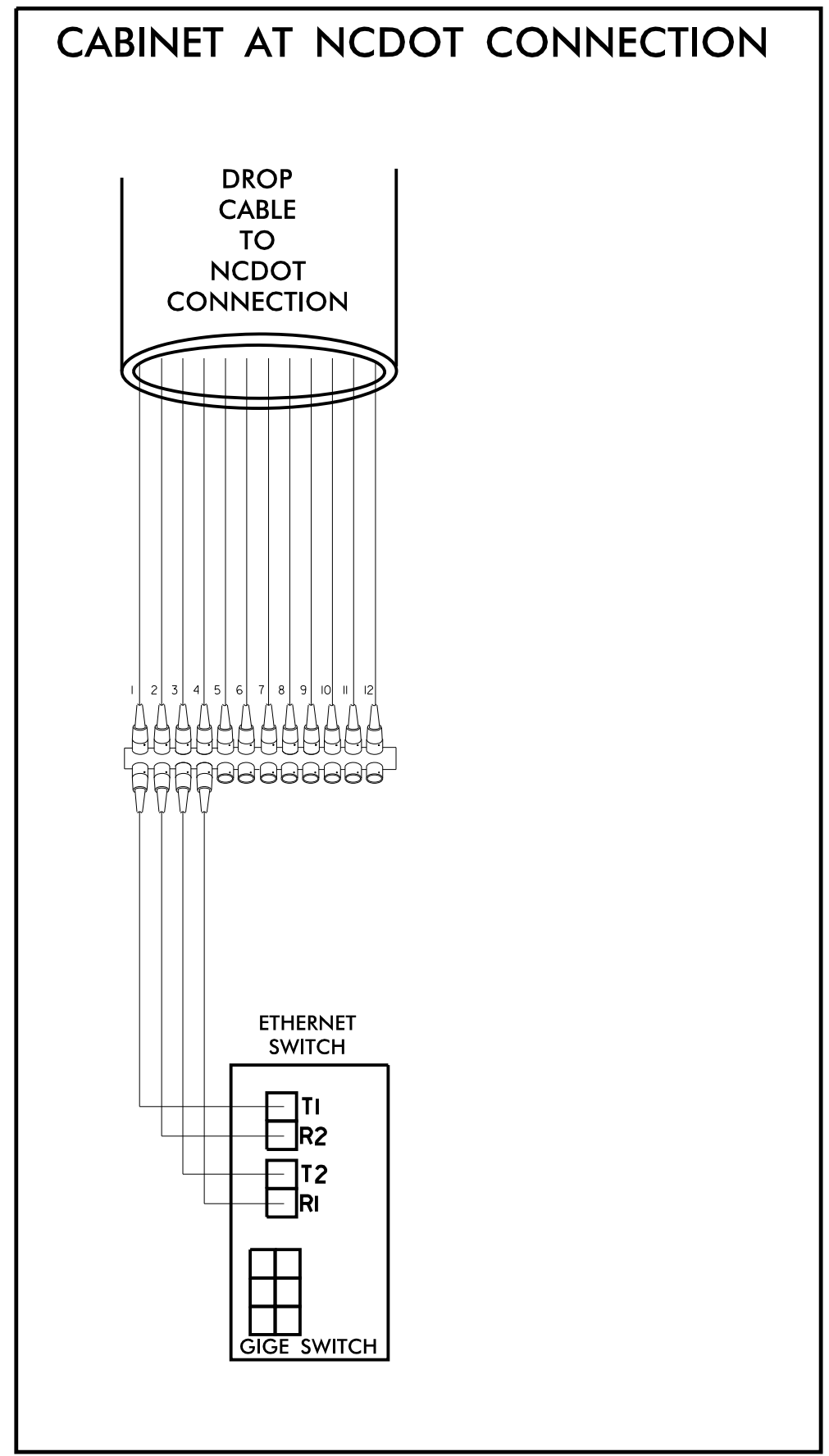
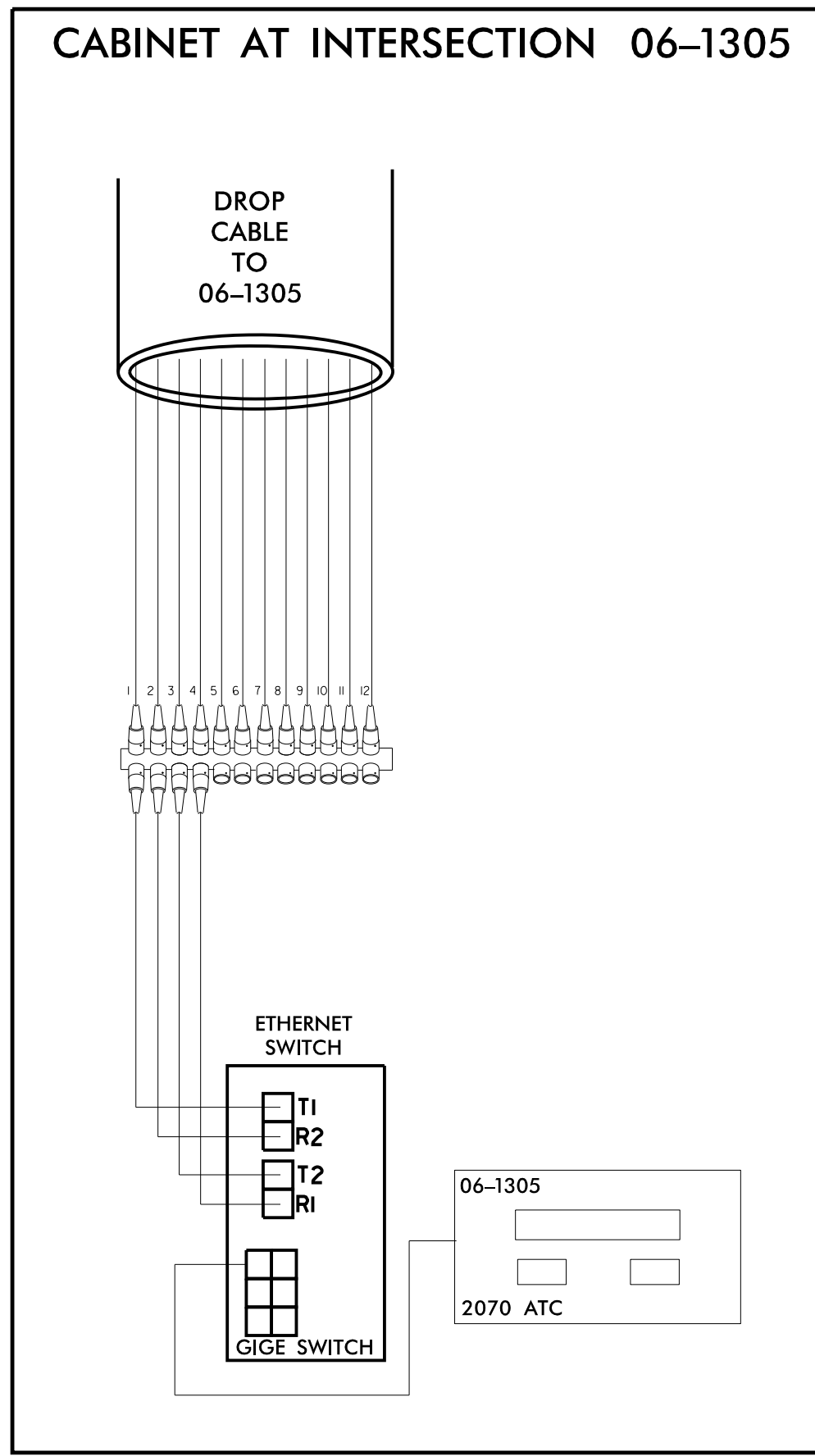
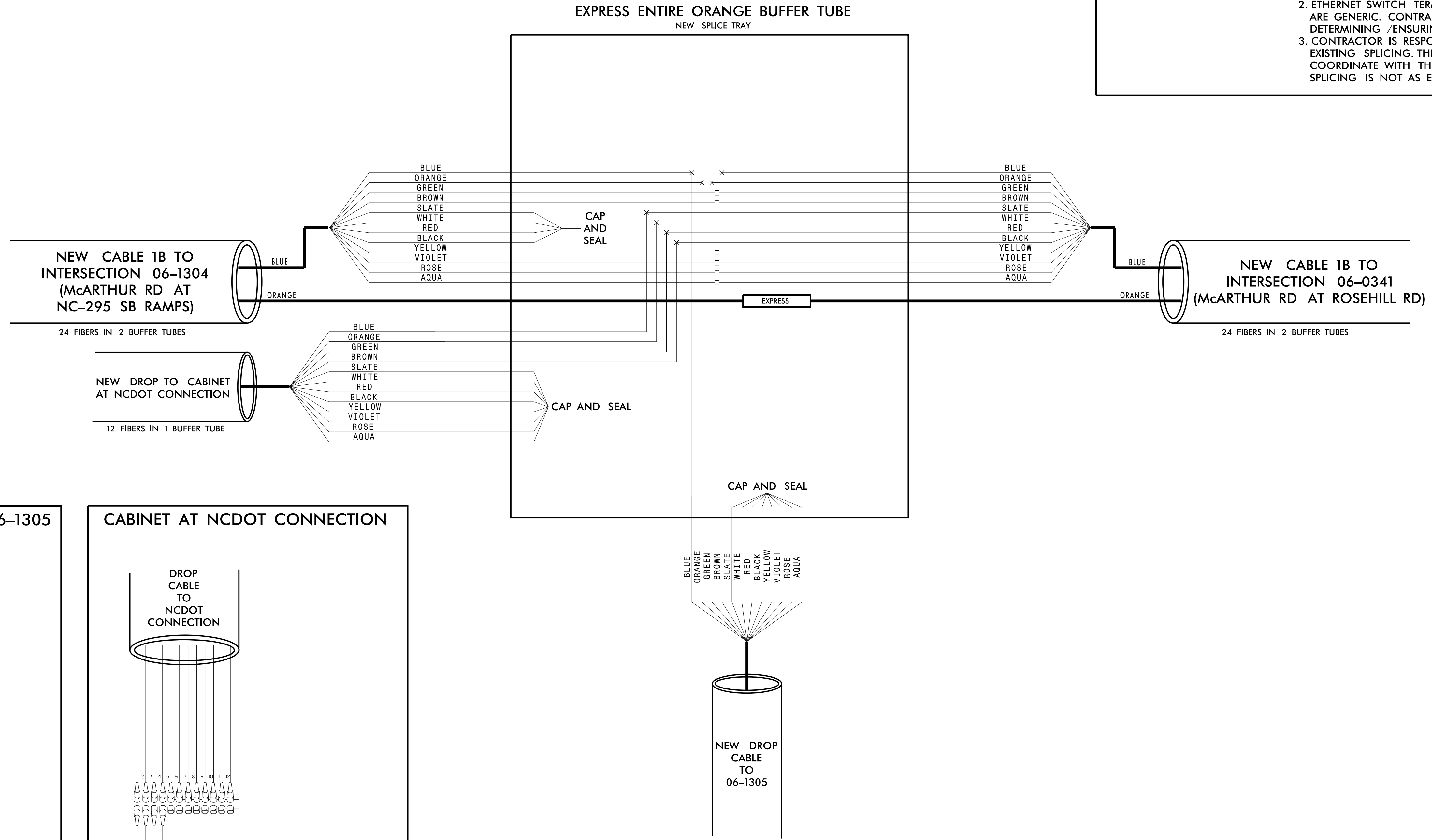

**CHANNEL 1 EXTENSION**

**FAYETTEVILLE COMPUTERIZED SIGNAL SYSTEM**

**SPLICE DETAIL**

DIVISION 06 CUMBERLAND COUNTY

PLAN DATE: NOVEMBER 2016 REVIEWED BY: N. M. MENGELKOCH

PREPARED BY: KHA REVIEWED BY: K. W. SMITH

SCALE: 0

**Kimley»Horn**  
NC License #F-0102  
421 Fayetteville St., Suite 600  
Raleigh, NC 27636  
Tel: (919) 677-2000  
Fax: (919) 677-2050

SEAL  
NORTH CAROLINA PROFESSIONAL ENGINEER  
KEVIN W. SMITH  
SEAL 030472

DocuSigned By:  
Kevin W. Smith  
11/15/2016

SIGNATURE DATE

CADD Filename:

11/15/2016 K:\ARL\_TPTD\_ITS\01036305 - Fayetteville Sig Sys\Plans\Splicing\01036305\_ITS\_psh\_178-CHINCDOT\_AT\_06-1305.dgn

**CHANNEL 1 EXTENSION  
NEW SPLICE ENCLOSURE  
(McARTHUR RD AT NC-295  
SB RAMPS)  
SIG ID 06-1304**

**COLOR CODE**  
TIA/EIA 598-C

|            |             |
|------------|-------------|
| (1) BLUE   | (7) RED     |
| (2) ORANGE | (8) BLACK   |
| (3) GREEN  | (9) YELLOW  |
| (4) BROWN  | (10) VIOLET |
| (5) SLATE  | (11) ROSE   |
| (6) WHITE  | (12) AQUA   |

**LEGEND**

X - FUSION SPLICE INDIVIDUAL FIBER  
 O - EXISTING SPLICE  
 □ - EXPRESS INDIVIDUAL FIBER

EXPRESS - EXPRESS ENTIRE BUFFER TUBE  
 SPLICE - SPLICE ENTIRE BUFFER TUBE OR MAINTAIN IF EXISTING EXPRESSED

**NOTES:**  
 1. FIBER INTERCONNECT CENTER RACKS ARE SCHEMATIC ONLY - ACTUAL EQUIPMENT FORM MAY VARY.  
 2. ETHERNET SWITCH TERMINATION CONFIGURATIONS ARE GENERIC. CONTRACTOR IS RESPONSIBLE FOR DETERMINING /ENSURING PROPER TERMINATION.  
 3. CONTRACTOR IS RESPONSIBLE FOR FIELD VERIFYING EXISTING SPLICING. THE CONTRACTOR SHALL COORDINATE WITH THE ENGINEER WHERE EXISTING SPLICING IS NOT AS EXPECTED.

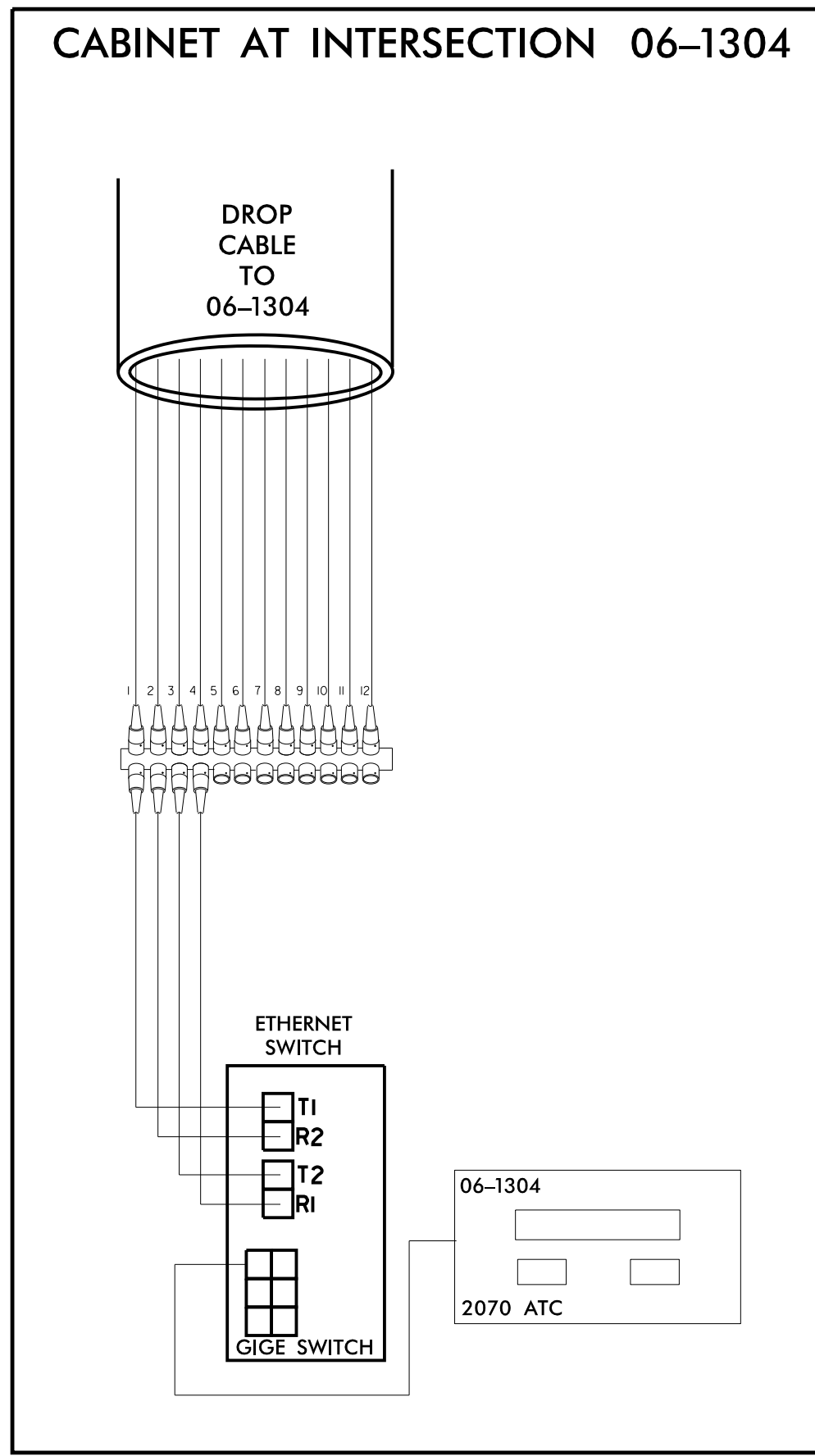
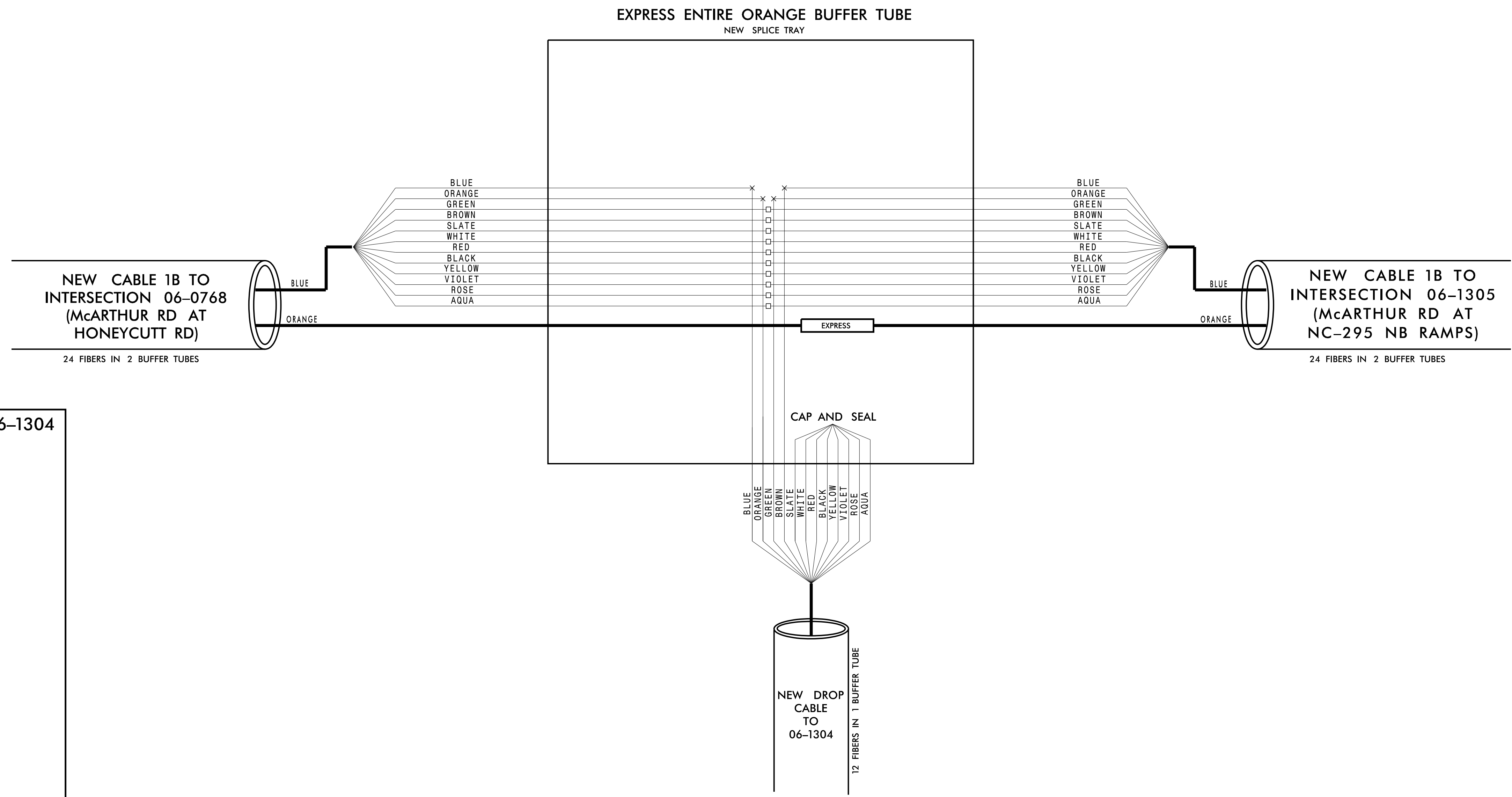

**CHANNEL 1 EXTENSION**

**FAYETTEVILLE COMPUTERIZED SIGNAL SYSTEM**

**SPLICE DETAIL**

DIVISION 06 CUMBERLAND COUNTY

PLAN DATE: NOVEMBER 2016 REVIEWED BY: N. M. MENGELKOCH

PREPARED BY: KHA REVIEWED BY: K. W. SMITH

SCALE: 0

Signature: Kevin Smith, 11/15/2016

Seal: NORTH CAROLINA PROFESSIONAL ENGINEER SEAL 030472

**Kimley»Horn**  
 NC License #F-0102  
 421 Fayetteville St., Suite 600  
 Raleigh, NC 27636  
 Tel: (919) 677-2000  
 Fax: (919) 677-2050

11/15/2016 K:\ARL\TPTD\ITS\01036305 - Fayetteville Sig Sys\Plans\Splicing\01036305-ITS\_psh\_179-CH06-1304.dgn

**CHANNEL 1 EXTENSION  
NEW SPLICE ENCLOSURE  
(McARTHUR RD AT HONEYCUTT  
RD)  
SIG ID 06-0768**

**COLOR CODE**  
TIA/EIA 598-C

|            |             |
|------------|-------------|
| (1) BLUE   | (7) RED     |
| (2) ORANGE | (8) BLACK   |
| (3) GREEN  | (9) YELLOW  |
| (4) BROWN  | (10) VIOLET |
| (5) SLATE  | (11) ROSE   |
| (6) WHITE  | (12) AQUA   |

**LEGEND**

X - FUSION SPLICE INDIVIDUAL FIBER  
 O - EXISTING SPLICE  
 □ - EXPRESS INDIVIDUAL FIBER

EXPRESS - EXPRESS ENTIRE BUFFER TUBE  
 SPLICE - SPLICE ENTIRE BUFFER TUBE OR MAINTAIN IF EXISTING EXPRESSED

**NOTES:**

- FIBER INTERCONNECT CENTER RACKS ARE SCHEMATIC ONLY - ACTUAL EQUIPMENT FORM MAY VARY.
- ETHERNET SWITCH TERMINATION CONFIGURATIONS ARE GENERIC. CONTRACTOR IS RESPONSIBLE FOR DETERMINING /ENSURING PROPER TERMINATION.
- CONTRACTOR IS RESPONSIBLE FOR FIELD VERIFYING EXISTING SPLICING. THE CONTRACTOR SHALL COORDINATE WITH THE ENGINEER WHERE EXISTING SPLICING IS NOT AS EXPECTED.

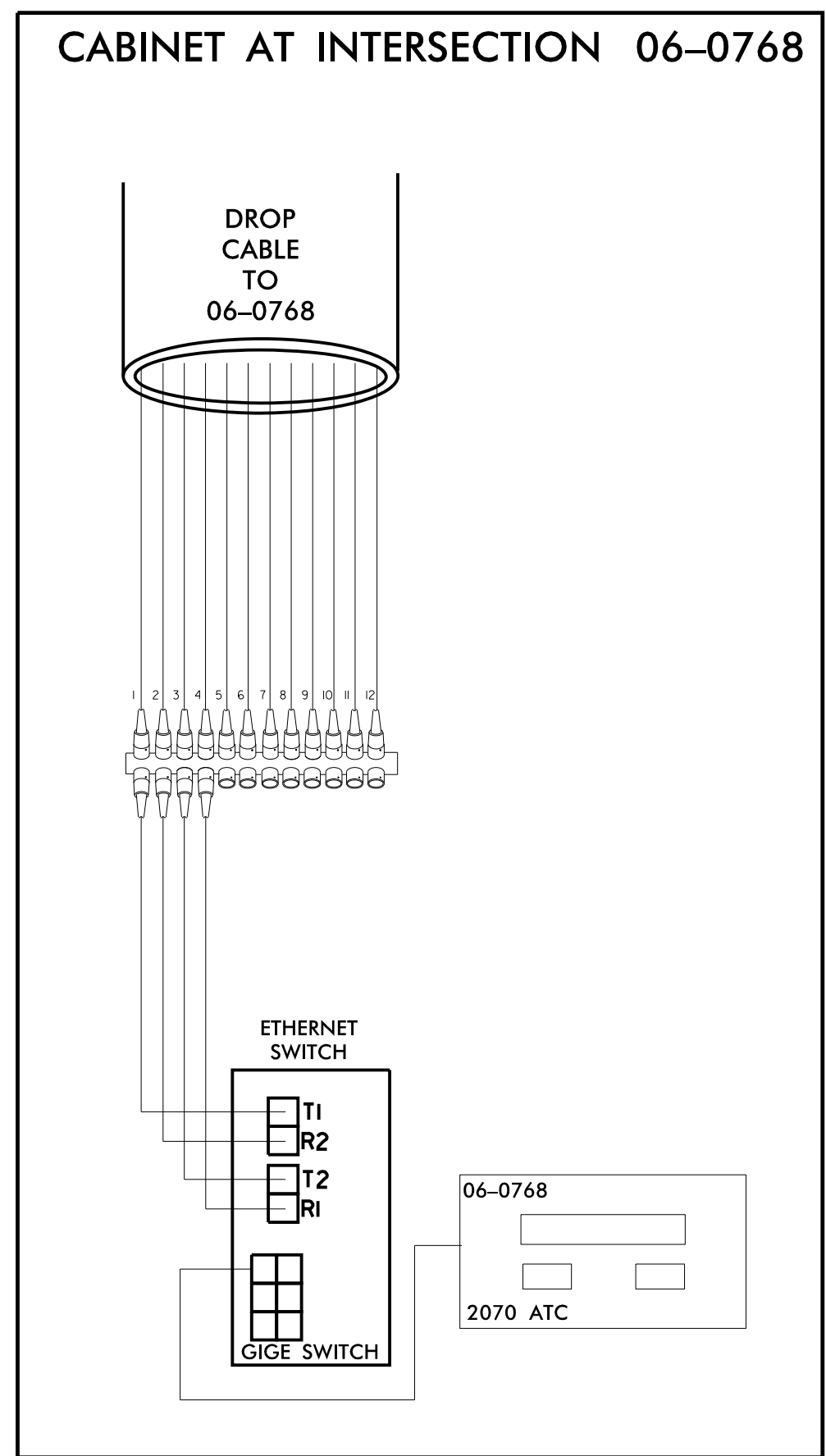
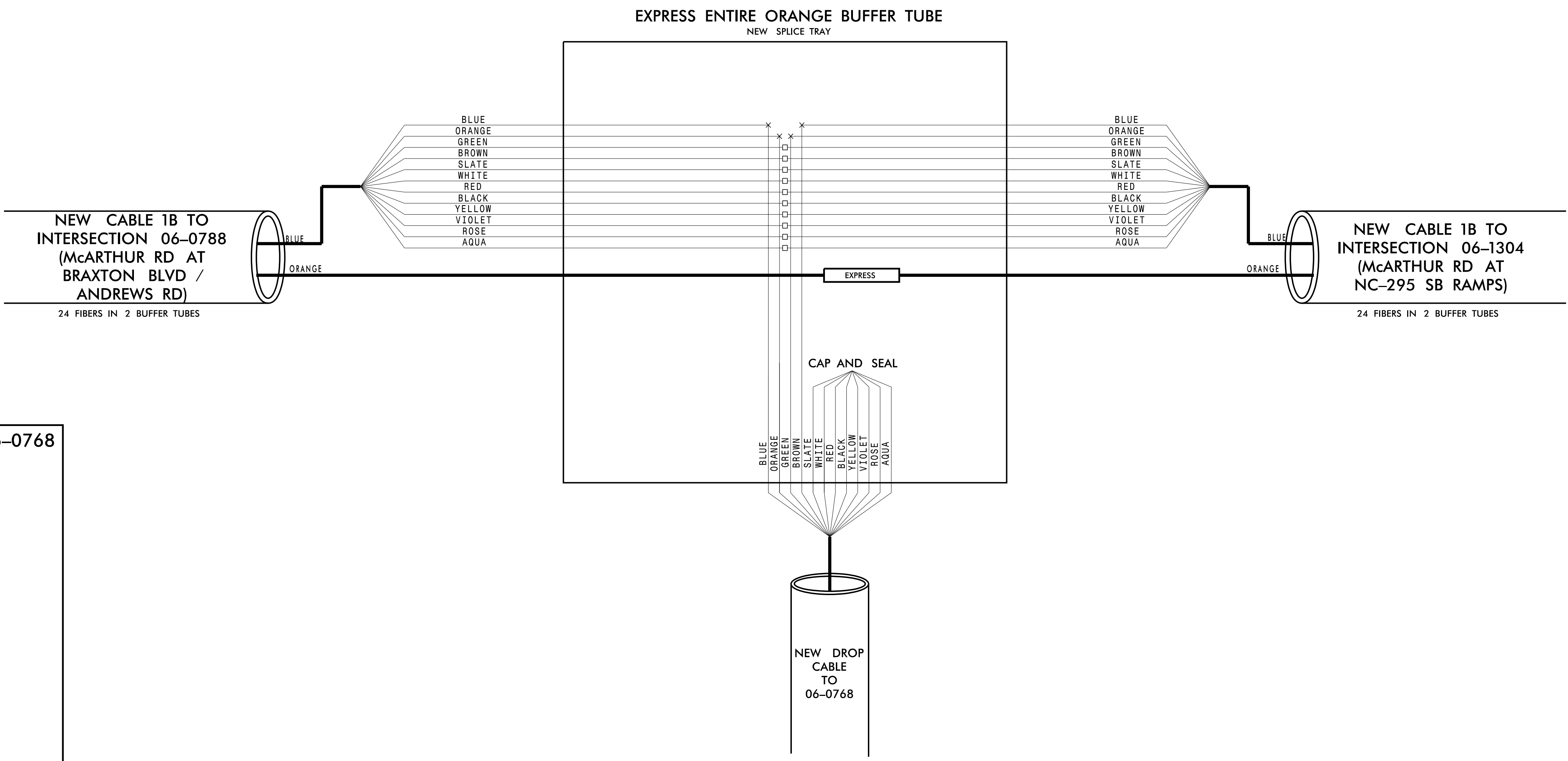

**CHANNEL 1 EXTENSION**

**FAYETTEVILLE COMPUTERIZED SIGNAL SYSTEM**

**SPLICE DETAIL**

DIVISION 06 CUMBERLAND COUNTY

PLAN DATE: NOVEMBER 2016 REVIEWED BY: N. M. MENGELKOCH

PREPARED BY: KHA REVIEWED BY: K. W. SMITH

Scale: 0

Signature: Kevin W. Smith, 11/15/2016

Seal: NORTH CAROLINA PROFESSIONAL ENGINEER SEAL 030472

**Kimley»Horn**  
 NC License #F-0102  
 421 Fayetteville St., Suite 600  
 Raleigh, NC 27636  
 Tel: (919) 677-2000  
 Fax: (919) 677-2050

11/15/2016 KARAL\_TPTD\_ITS\_01036305 - Fayetteville Sig Sys Plans\Splicing\01036305-ITS\_psh\_IB0-CH06-0768.dgn



**CHANNEL 1 EXTENSION  
NEW SPLICE ENCLOSURE  
(McARTHUR RD AT ANDREWS  
RD /BRAXTON BLVD)  
SIG ID 06-0788**

**COLOR CODE**  
TIA/EIA 598-C

|            |             |
|------------|-------------|
| (1) BLUE   | (7) RED     |
| (2) ORANGE | (8) BLACK   |
| (3) GREEN  | (9) YELLOW  |
| (4) BROWN  | (10) VIOLET |
| (5) SLATE  | (11) ROSE   |
| (6) WHITE  | (12) AQUA   |

**LEGEND**

X - FUSION SPLICE INDIVIDUAL FIBER  
 O - EXISTING SPLICE  
 □ - EXPRESS INDIVIDUAL FIBER

EXPRESS - EXPRESS ENTIRE BUFFER TUBE  
 SPLICE - SPLICE ENTIRE BUFFER TUBE OR MAINTAIN IF EXISTING EXPRESSED

**NOTES:**

- FIBER INTERCONNECT CENTER RACKS ARE SCHEMATIC ONLY - ACTUAL EQUIPMENT FORM MAY VARY.
- ETHERNET SWITCH TERMINATION CONFIGURATIONS ARE GENERIC. CONTRACTOR IS RESPONSIBLE FOR DETERMINING /ENSURING PROPER TERMINATION.
- CONTRACTOR IS RESPONSIBLE FOR FIELD VERIFYING EXISTING SPLICING. THE CONTRACTOR SHALL COORDINATE WITH THE ENGINEER WHERE EXISTING SPLICING IS NOT AS EXPECTED.

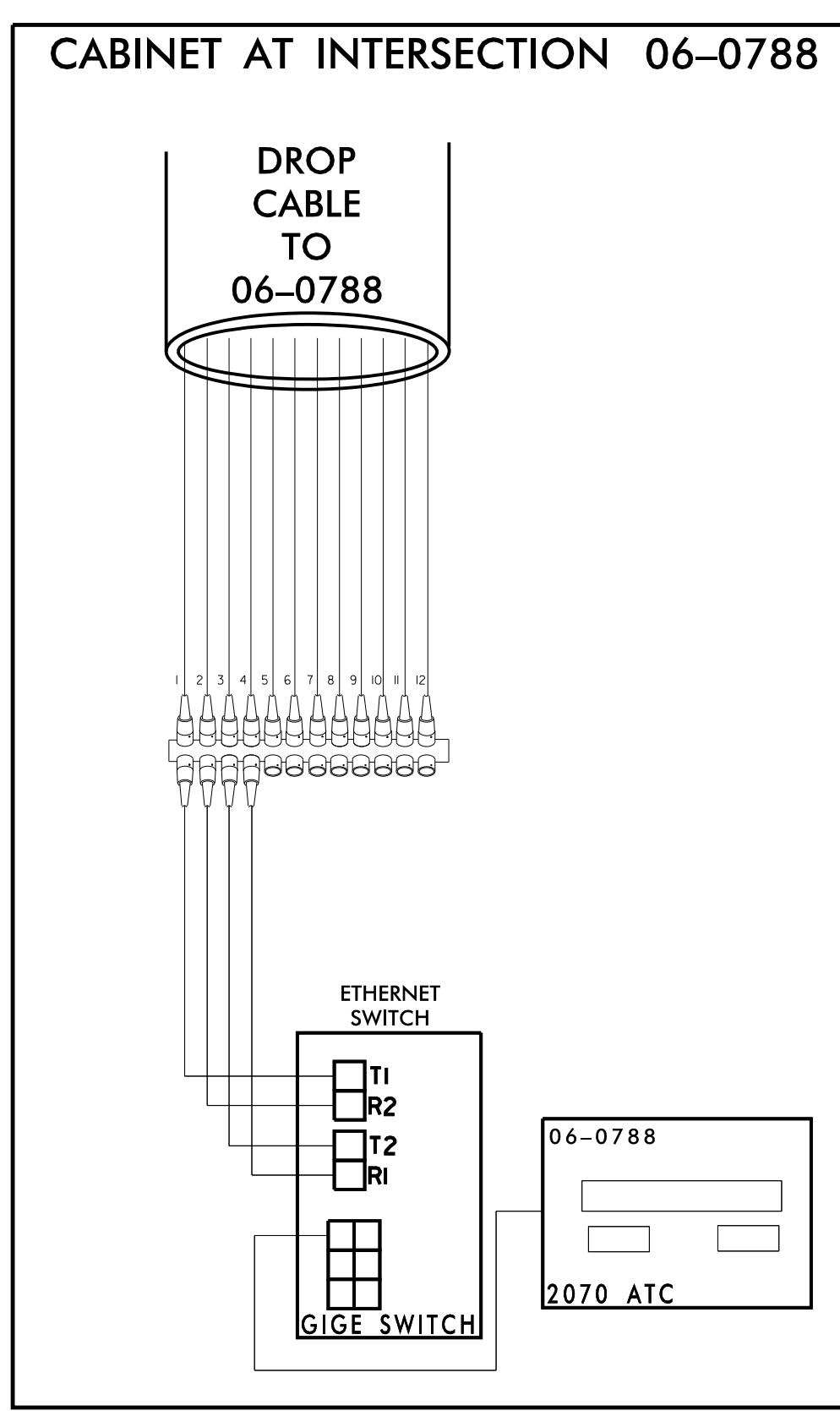
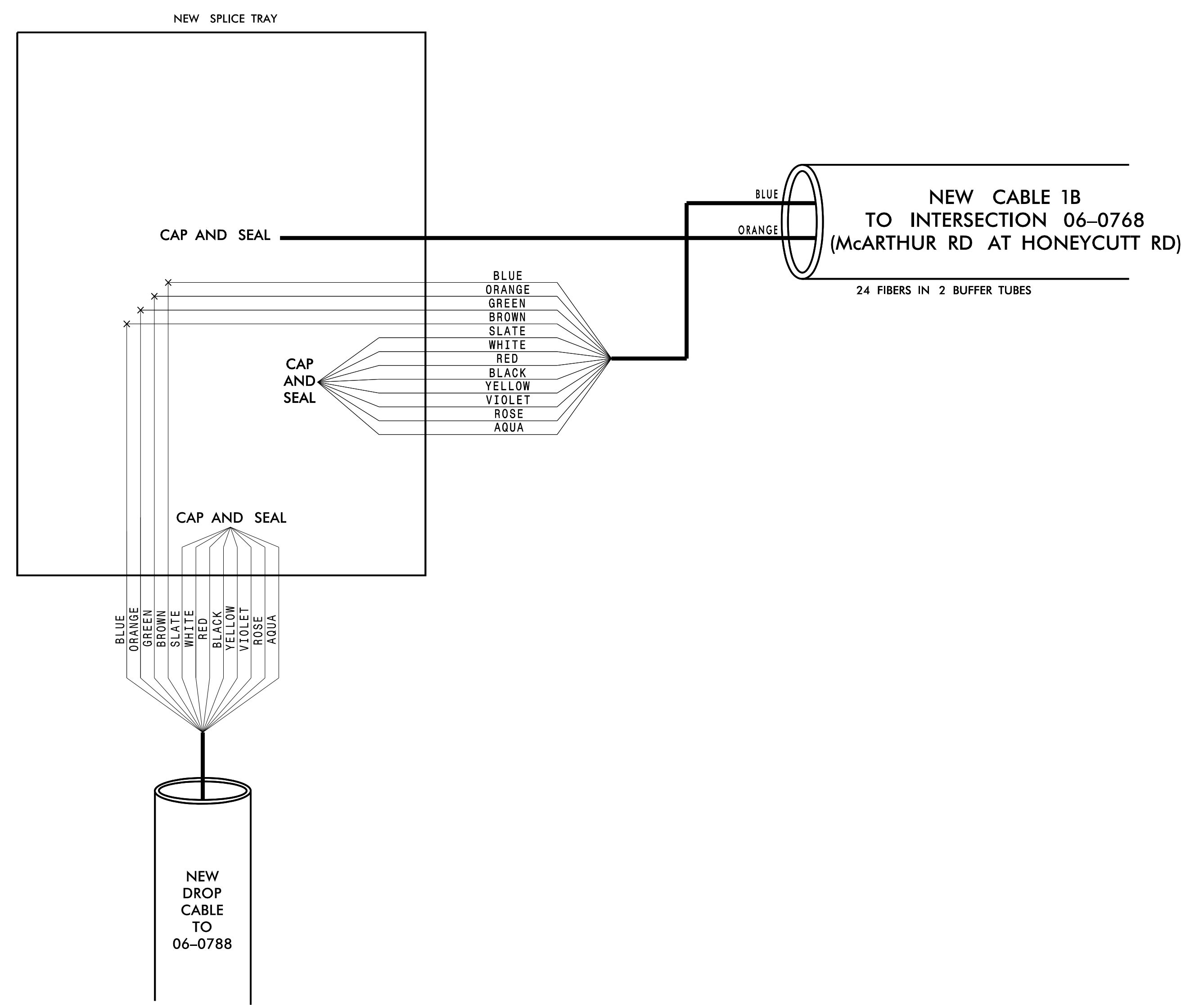

**CHANNEL 1 EXTENSION**

**FAYETTEVILLE COMPUTERIZED SIGNAL SYSTEM  
SPLICE DETAIL**

DIVISION 06 CUMBERLAND COUNTY

PLAN DATE: NOVEMBER 2016 REVIEWED BY: N. M. MENGELKOCH

PREPARED BY: KHA REVIEWED BY: K. W. SMITH

| REVISIONS | INIT. | DATE |
|-----------|-------|------|
|           |       |      |

SCALE: 0

Kimley»Horn  
 NC License #F-0102  
 421 Fayetteville St., Suite 600  
 Raleigh, NC 27636  
 Tel: (919) 677-2000  
 Fax: (919) 677-2050

SEAL  
 NORTH CAROLINA PROFESSIONAL ENGINEER  
 KEVIN W. SMITH  
 SEAL 030472  
 11/15/2016  
 DATE

11/15/2016 K:\ARL\TPTD\_ITS\01036305 - Fayetteville Sig Sys\Plans\Splicing\01036305-ITS\_psh-IBI-CHI-06-0788.dgn

**CHANNEL 3  
EXISTING SPLICE ENCLOSURE  
MURCHISON RD AT  
COUNTRY CLUB DR  
SIG ID 06-0056 AND CCTV 17**

**COLOR CODE**  
TIA/EIA 598-C

|            |             |
|------------|-------------|
| (1) BLUE   | (7) RED     |
| (2) ORANGE | (8) BLACK   |
| (3) GREEN  | (9) YELLOW  |
| (4) BROWN  | (10) VIOLET |
| (5) SLATE  | (11) ROSE   |
| (6) WHITE  | (12) AQUA   |

**LEGEND**

X - FUSION SPLICE INDIVIDUAL FIBER  
 O - EXISTING SPLICE  
 □ - EXPRESS INDIVIDUAL FIBER

EXPRESS - EXPRESS ENTIRE BUFFER TUBE  
 SPLICE - SPLICE ENTIRE BUFFER TUBE OR MAINTAIN IF EXISTING EXPRESSED

**NOTES:**  
 1. FIBER INTERCONNECT CENTER RACKS ARE SCHEMATIC ONLY - ACTUAL EQUIPMENT FORM MAY VARY.  
 2. ETHERNET SWITCH TERMINATION CONFIGURATIONS ARE GENERIC. CONTRACTOR IS RESPONSIBLE FOR DETERMINING /ENSURING PROPER TERMINATION.  
 3. CONTRACTOR IS RESPONSIBLE FOR FIELD VERIFYING EXISTING SPICING. THE CONTRACTOR SHALL COORDINATE WITH THE ENGINEER WHERE EXISTING SPICING IS NOT AS EXPECTED.

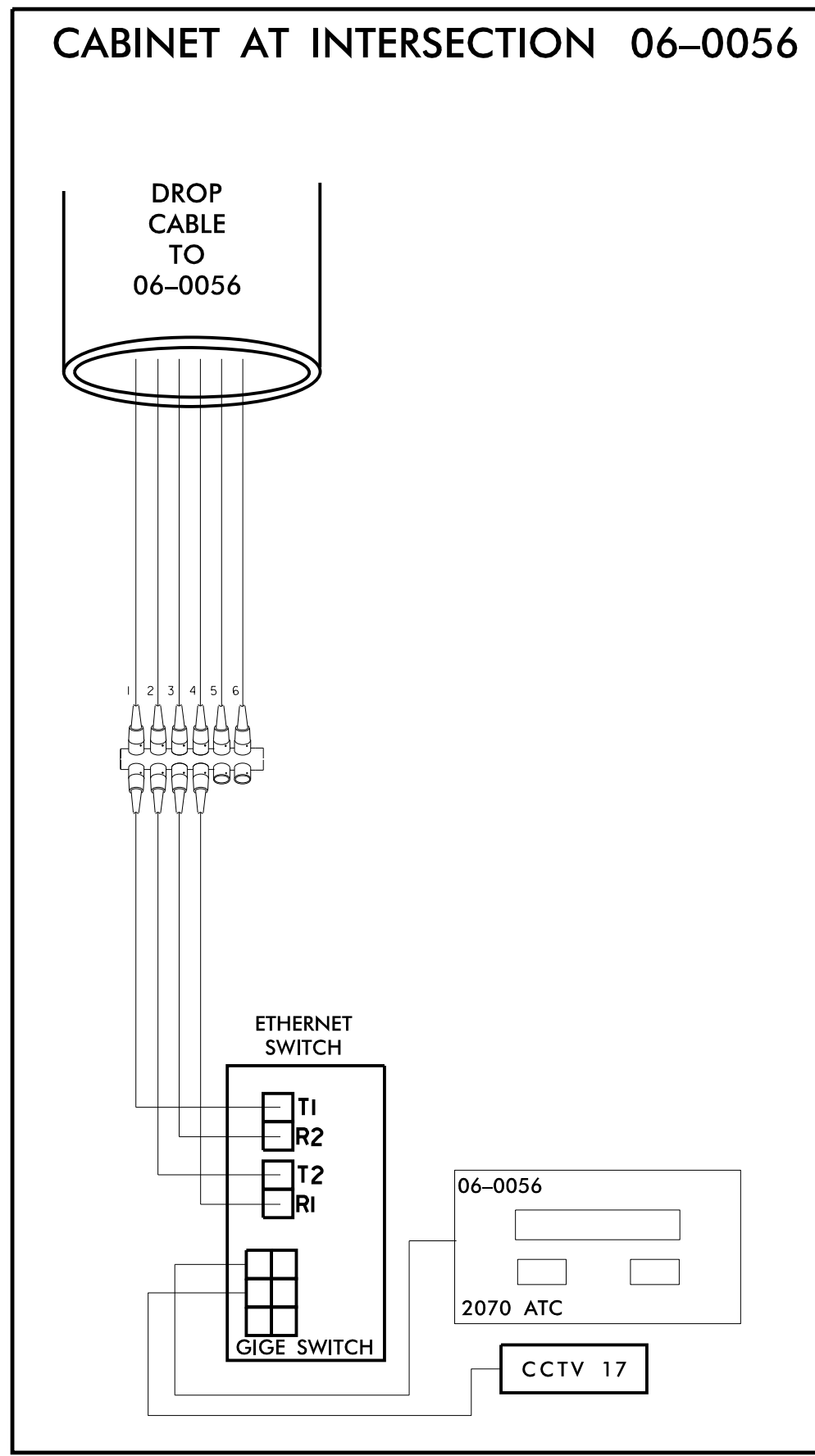
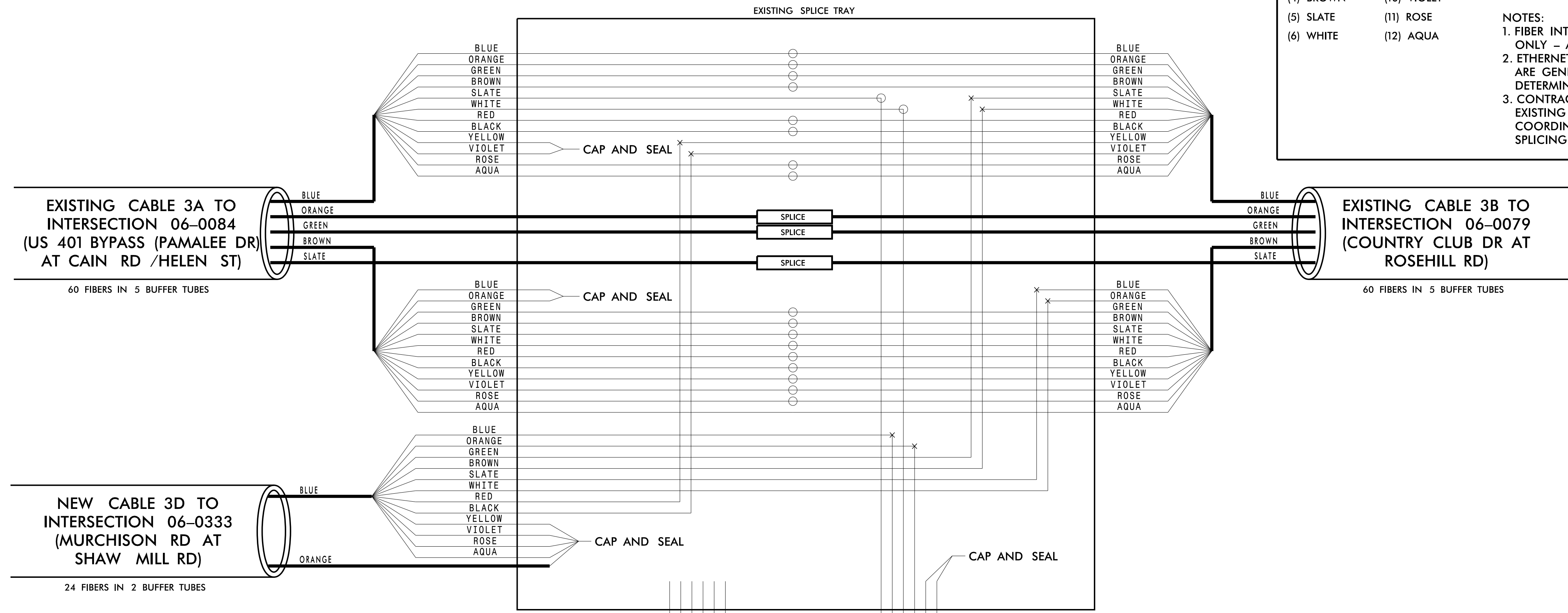

11/15/2016 K:\ARL\TPTD\ITS\01036305 - Fayetteville Sig Sys\Plans\Splicing\01036305-ITS\_psh-182-CH3 06-0056 rev.dgn

**Kimley»Horn**  
 NC License #F-0102  
 421 Fayetteville St., Suite 600  
 Raleigh, NC 27636  
 Tel: (919) 677-2000  
 Fax: (919) 677-2050

**CHANNEL 3  
FAYETTEVILLE COMPUTERIZED  
SIGNAL SYSTEM  
SPLICE DETAIL**

SEAL  
 NORTH CAROLINA PROFESSIONAL ENGINEER  
 KEVIN W. SMITH  
 SEAL 030472

DIVISION 06 CUMBERLAND COUNTY  
 PLAN DATE: NOVEMBER 2016 REVIEWED BY: N. M. MENGELKOCH  
 PREPARED BY: KHA REVIEWED BY: K. W. SMITH

250 N. Greenfield Place, Garner, NC 27529  
 SCALE 0

| REVISIONS | INIT. | DATE |
|-----------|-------|------|
|           |       |      |

DocuSigned by: Kevin W. Smith  
 11/15/2016  
 CADD Filename:

**CHANNEL 3 EXTENSION  
NEW SPLICE ENCLOSURE  
MURCHISON RD AT SHAW  
MILL RD  
SIG ID 06-0333**

**COLOR CODE**  
TIA/EIA 598-C

|            |             |
|------------|-------------|
| (1) BLUE   | (7) RED     |
| (2) ORANGE | (8) BLACK   |
| (3) GREEN  | (9) YELLOW  |
| (4) BROWN  | (10) VIOLET |
| (5) SLATE  | (11) ROSE   |
| (6) WHITE  | (12) AQUA   |

**LEGEND**

X - FUSION SPLICE INDIVIDUAL FIBER  
 O - EXISTING SPLICE  
 □ - EXPRESS INDIVIDUAL FIBER

EXPRESS - EXPRESS ENTIRE BUFFER TUBE  
 SPLICE - SPLICE ENTIRE BUFFER TUBE OR MAINTAIN IF EXISTING EXPRESSED

**NOTES:**

- FIBER INTERCONNECT CENTER RACKS ARE SCHEMATIC ONLY - ACTUAL EQUIPMENT FORM MAY VARY.
- ETHERNET SWITCH TERMINATION CONFIGURATIONS ARE GENERIC. CONTRACTOR IS RESPONSIBLE FOR DETERMINING /ENSURING PROPER TERMINATION.
- CONTRACTOR IS RESPONSIBLE FOR FIELD VERIFYING EXISTING SPLICING. THE CONTRACTOR SHALL COORDINATE WITH THE ENGINEER WHERE EXISTING SPLICING IS NOT AS EXPECTED.

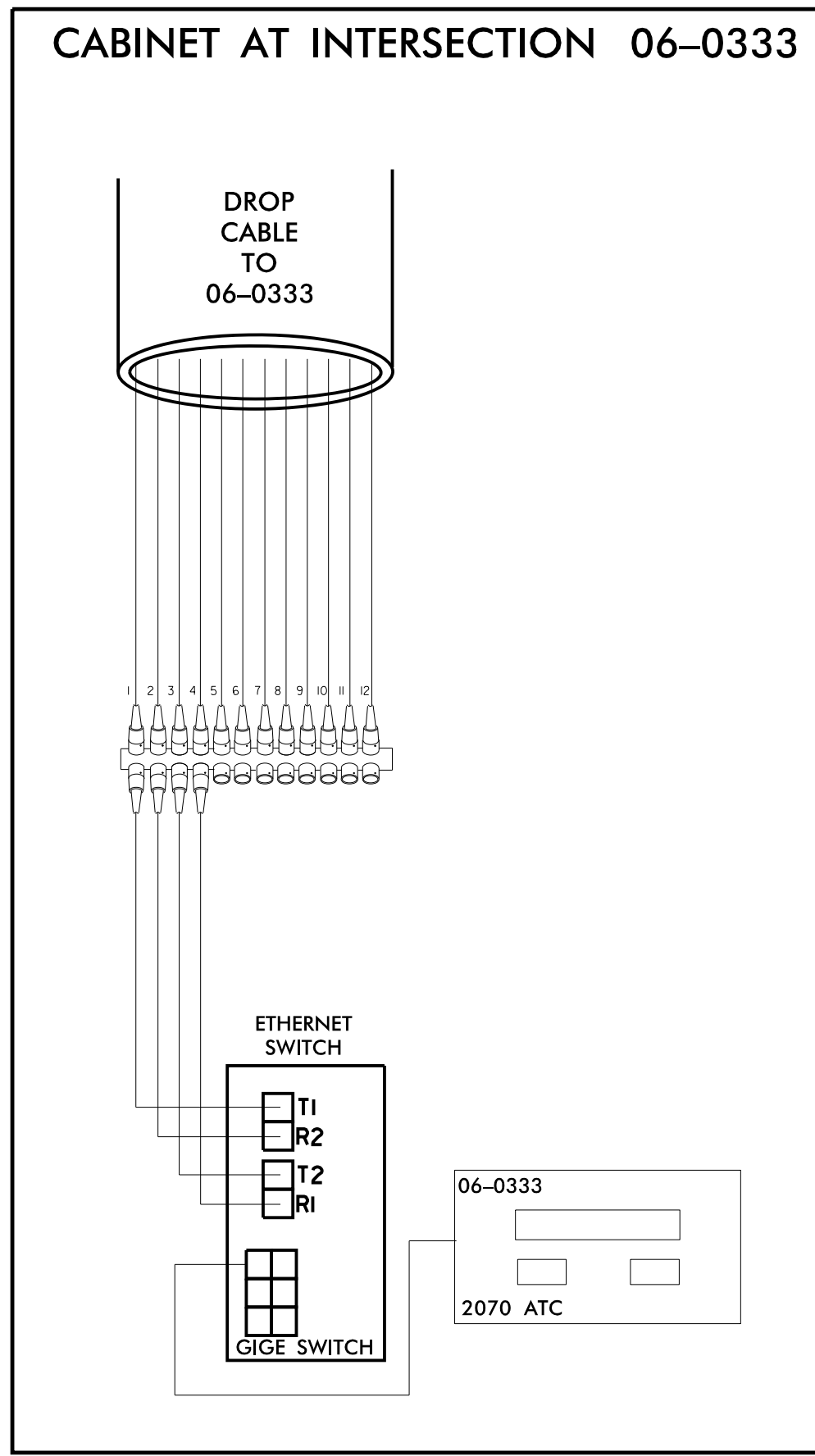
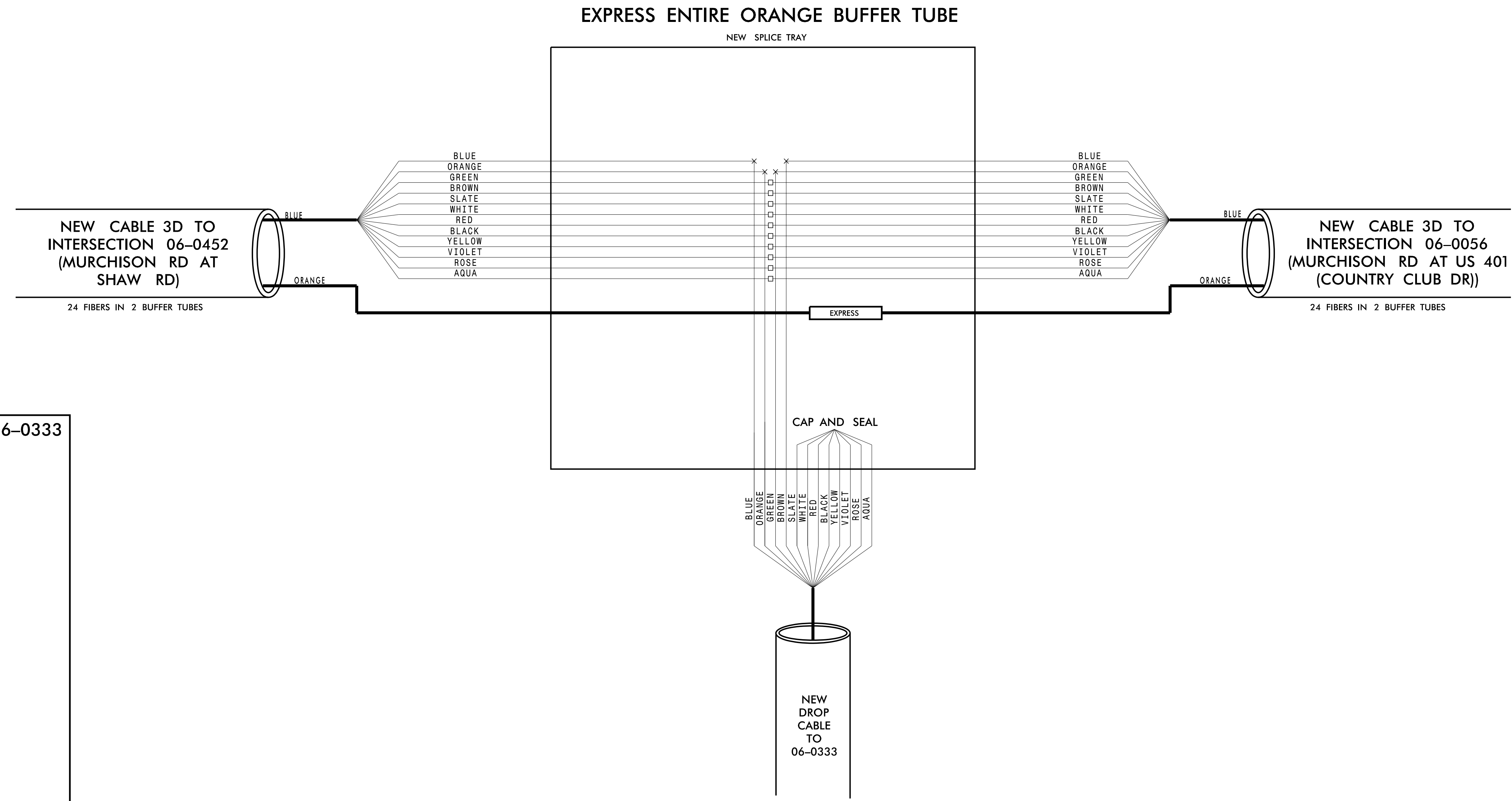

**CHANNEL 3 EXTENSION**

**FAYETTEVILLE COMPUTERIZED SIGNAL SYSTEM**

**SPLICE DETAIL**

DIVISION 06 CUMBERLAND COUNTY

PLAN DATE: NOVEMBER 2016 REVIEWED BY: N. M. MENGELKOCH

PREPARED BY: KHA REVIEWED BY: K. W. SMITH

SCALE: 0

Signature: Kevin W. Smith, 11/15/2016

Seal: NORTH CAROLINA PROFESSIONAL ENGINEER SEAL 030472

**Kimley»Horn**  
 NC License #F-0102  
 421 Fayetteville St., Suite 600  
 Raleigh, NC 27636  
 Tel: (919) 677-2000  
 Fax: (919) 677-2050

11/15/2016 KARAL\_TPTD\_ITS\_01036305 - Fayetteville Sig Sys Plans\Splicing\01036305\_ITS\_psh-I83-CH3 06-0333.dgn

**CHANNEL 3 EXTENSION  
EXISTING SPLICE ENCLOSURE  
MURCHISON RD AT SHAW RD  
SIG ID 06-0452**

**COLOR CODE**  
TIA/EIA 598-C

|            |             |
|------------|-------------|
| (1) BLUE   | (7) RED     |
| (2) ORANGE | (8) BLACK   |
| (3) GREEN  | (9) YELLOW  |
| (4) BROWN  | (10) VIOLET |
| (5) SLATE  | (11) ROSE   |
| (6) WHITE  | (12) AQUA   |

**LEGEND**

X - FUSION SPLICE INDIVIDUAL FIBER  
 O - EXISTING SPLICE  
 □ - EXPRESS INDIVIDUAL FIBER

EXPRESS - EXPRESS ENTIRE BUFFER TUBE  
 SPLICE - SPLICE ENTIRE BUFFER TUBE OR MAINTAIN IF EXISTING EXPRESSED

**NOTES:**

- FIBER INTERCONNECT CENTER RACKS ARE SCHEMATIC ONLY - ACTUAL EQUIPMENT FORM MAY VARY.
- ETHERNET SWITCH TERMINATION CONFIGURATIONS ARE GENERIC. CONTRACTOR IS RESPONSIBLE FOR DETERMINING /ENSURING PROPER TERMINATION.
- CONTRACTOR IS RESPONSIBLE FOR FIELD VERIFYING EXISTING SPLICING. THE CONTRACTOR SHALL COORDINATE WITH THE ENGINEER WHERE EXISTING SPLICING IS NOT AS EXPECTED.

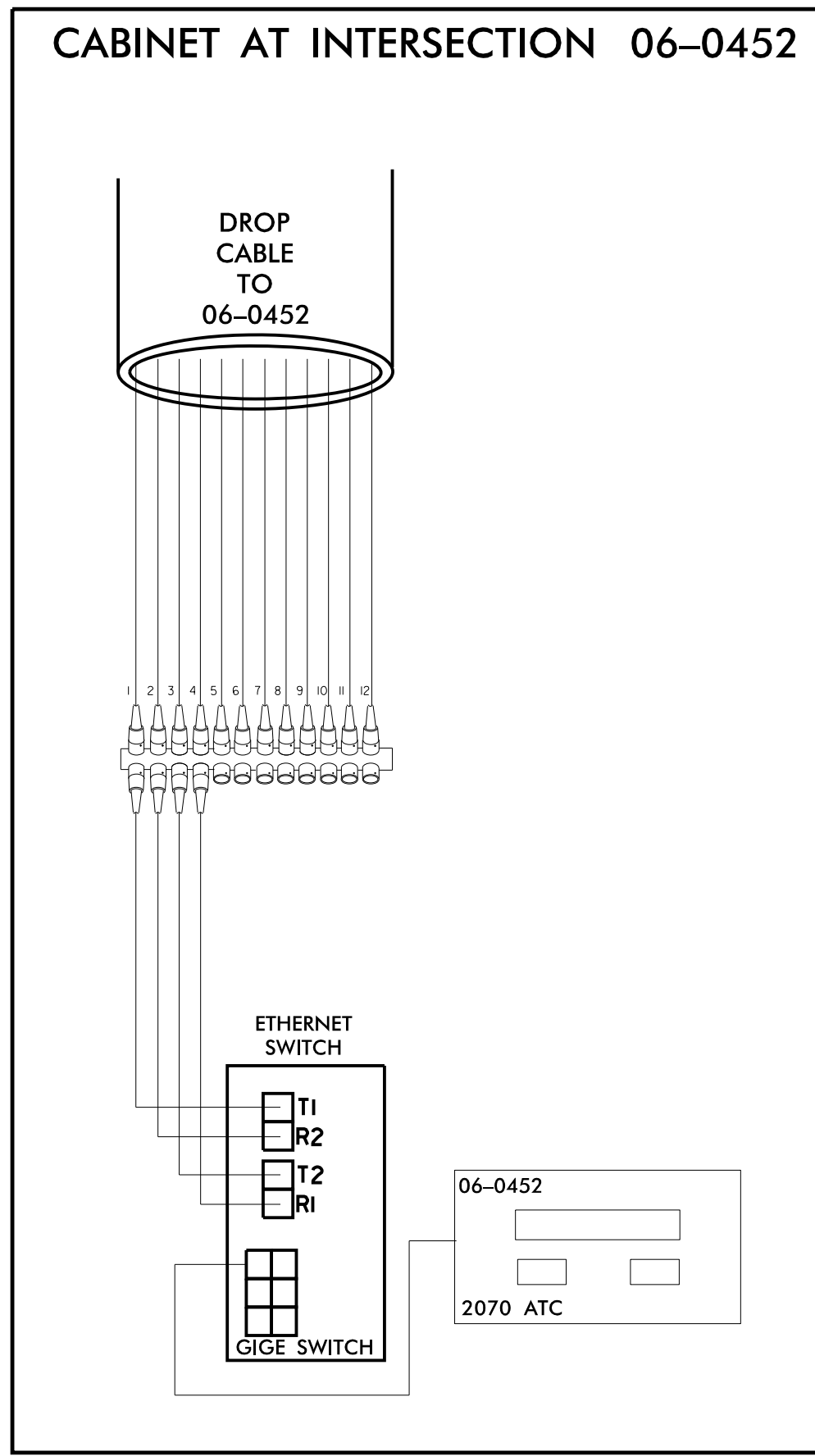
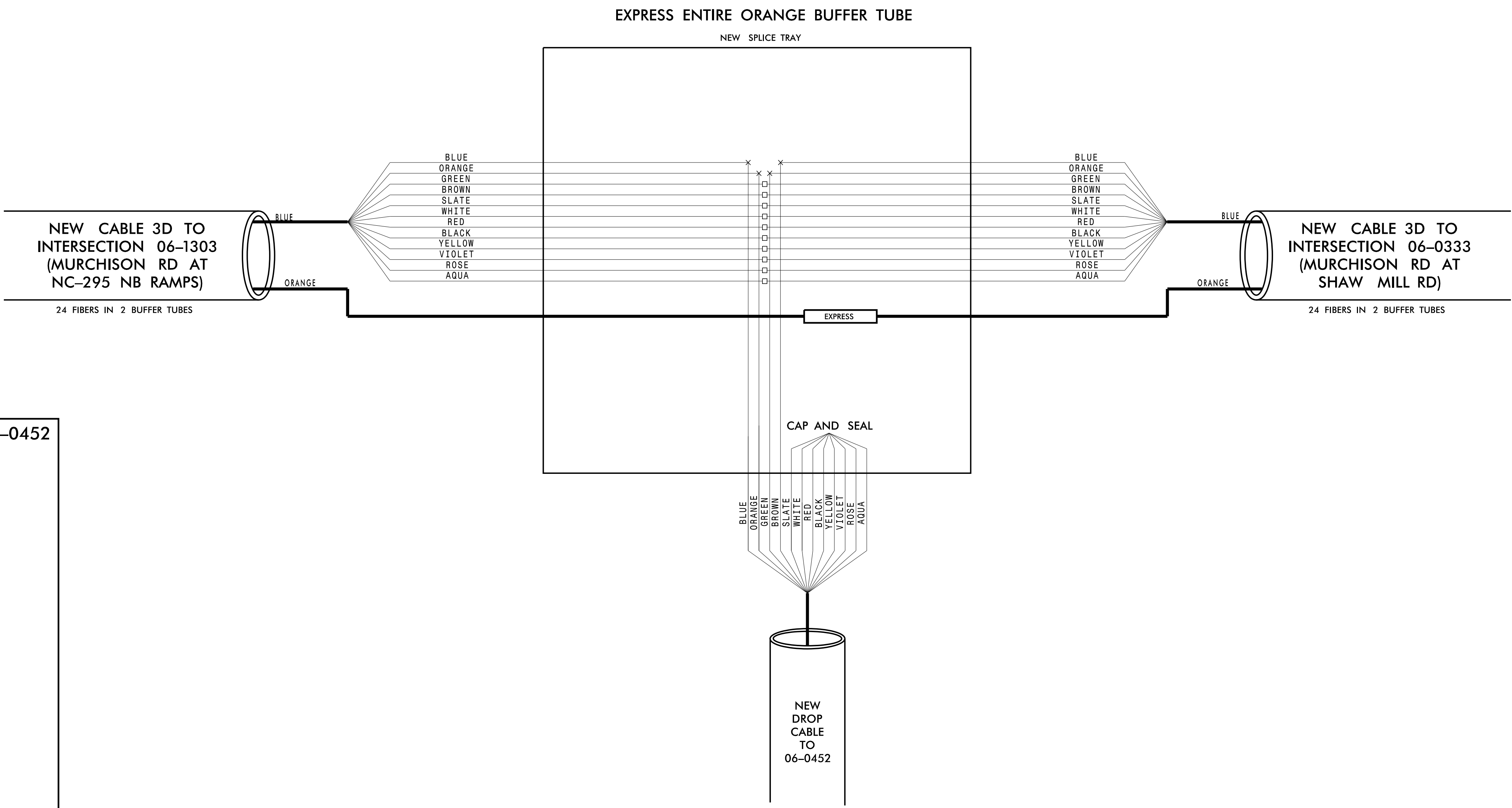

11/15/2016 K:\ARL\TPTD\ITS\01036305 - Fayetteville Sig Sys\Plans\Splicing\01036305-ITS\_psh-184-CH3 06-0452.dgn

**CHANNEL 3 EXTENSION**

|                          |  |            |                                  |
|--------------------------|--|------------|----------------------------------|
|                          | <b>FAYETTEVILLE COMPUTERIZED SIGNAL SYSTEM</b><br><b>SPLICE DETAIL</b> |            | SEAL<br>                         |
|                          | DIVISION 06 CUMBERLAND COUNTY  |            |                                  |
| PLAN DATE: NOVEMBER 2016 | REVIEWED BY: N. M. MENGELKOCH  |            | DocuSigned by:<br><br>11/15/2016 |
| PREPARED BY: KHA         | REVIEWED BY: K. W. SMITH   |            |                                  |
| SCALE<br>0               | REVISIONS  | INIT. DATE | SIGNATURE DATE                   |
| CADD Filename:           |  |            |                                  |

**Kimley»Horn**  
 NC License #F-0102  
 421 Fayetteville St., Suite 600  
 Raleigh, NC 27636  
 Tel: (919) 677-2000  
 Fax: (919) 677-2050

**CHANNEL 3 EXTENSION  
NEW SPLICE ENCLOSURE  
(MURCHISON RD AT NC-295  
NB RAMPS)  
SIG ID 06-1303**

**COLOR CODE**  
TIA/EIA 598-C

|            |             |
|------------|-------------|
| (1) BLUE   | (7) RED     |
| (2) ORANGE | (8) BLACK   |
| (3) GREEN  | (9) YELLOW  |
| (4) BROWN  | (10) VIOLET |
| (5) SLATE  | (11) ROSE   |
| (6) WHITE  | (12) AQUA   |

**LEGEND**

X - FUSION SPLICE INDIVIDUAL FIBER  
 O - EXISTING SPLICE  
 □ - EXPRESS INDIVIDUAL FIBER

EXPRESS - EXPRESS ENTIRE BUFFER TUBE  
 SPLICE - SPLICE ENTIRE BUFFER TUBE OR MAINTAIN IF EXISTING EXPRESSED

**NOTES:**

- FIBER INTERCONNECT CENTER RACKS ARE SCHEMATIC ONLY - ACTUAL EQUIPMENT FORM MAY VARY.
- ETHERNET SWITCH TERMINATION CONFIGURATIONS ARE GENERIC. CONTRACTOR IS RESPONSIBLE FOR DETERMINING /ENSURING PROPER TERMINATION.
- CONTRACTOR IS RESPONSIBLE FOR FIELD VERIFYING EXISTING SPLICING. THE CONTRACTOR SHALL COORDINATE WITH THE ENGINEER WHERE EXISTING SPLICING IS NOT AS EXPECTED.

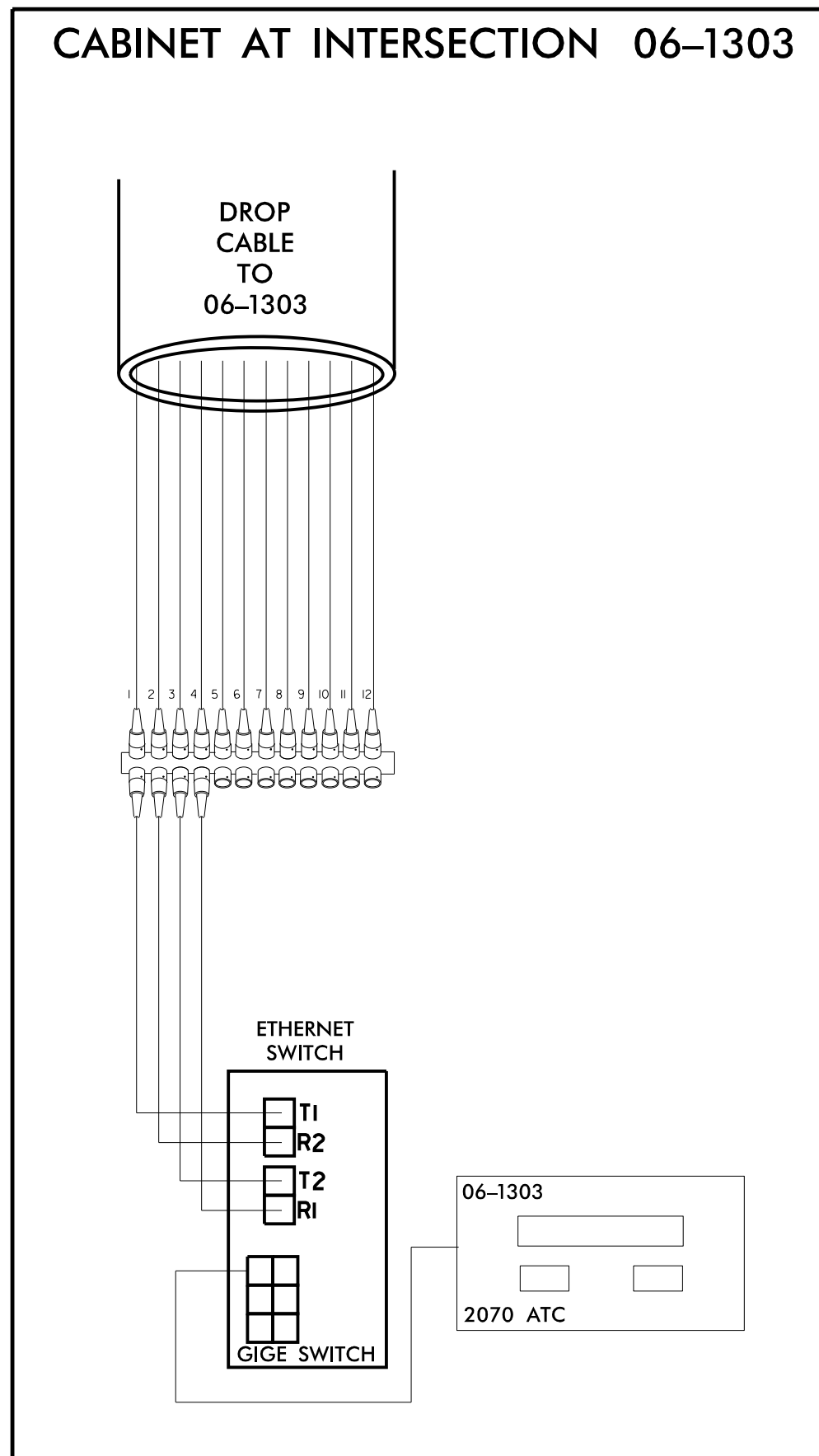
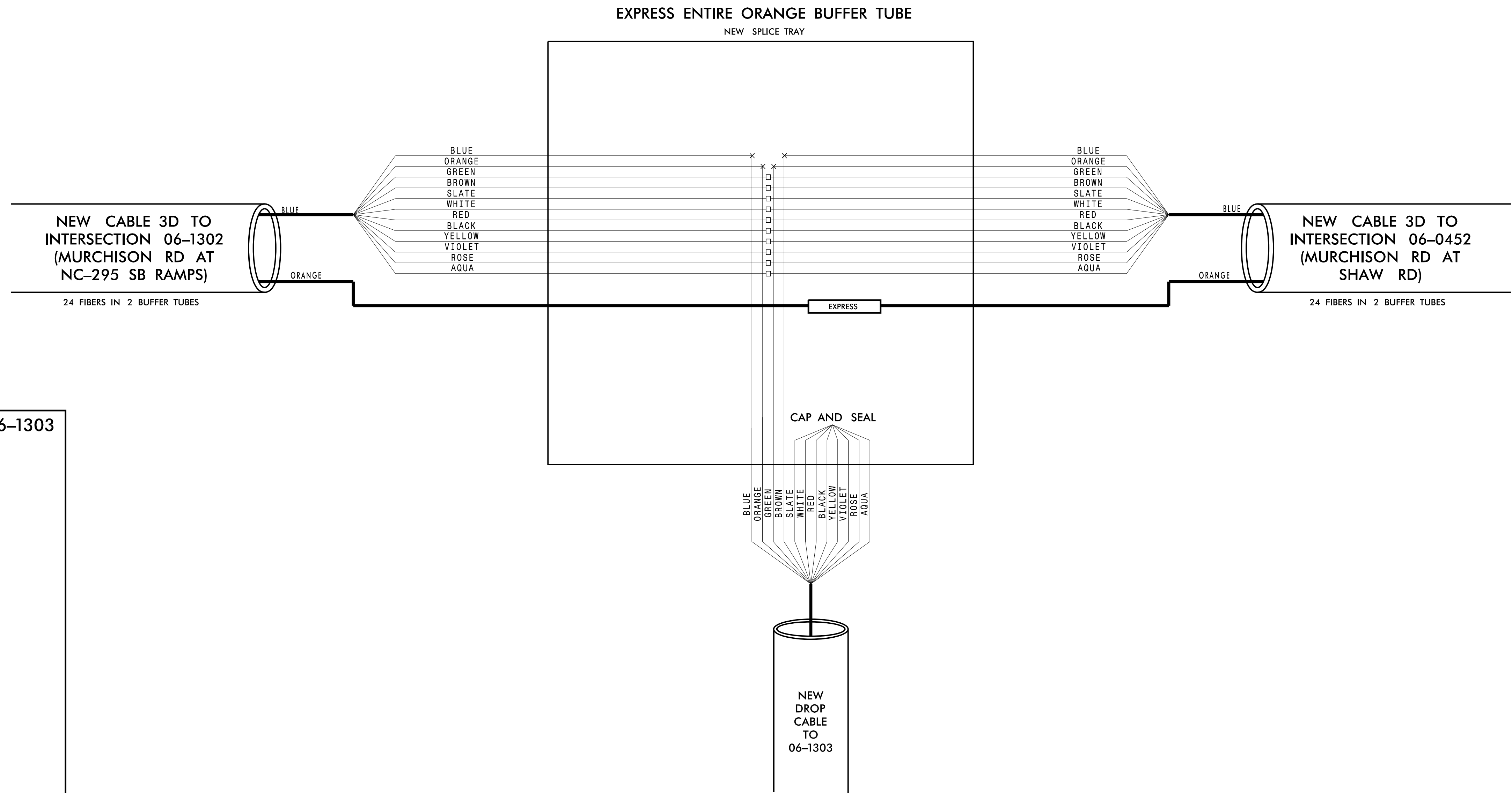

**CHANNEL 3 EXTENSION**

**FAYETTEVILLE COMPUTERIZED SIGNAL SYSTEM**

**SPLICE DETAIL**

DIVISION 06 CUMBERLAND COUNTY

PLAN DATE: NOVEMBER 2016 REVIEWED BY: N. M. MENGELKOCH

PREPARED BY: KHA REVIEWED BY: K. W. SMITH

SCALE: 0

REVISIONS: \_\_\_\_\_ INIT. DATE

Signature: Kevin W. Smith, 11/15/2016

Seal: NORTH CAROLINA PROFESSIONAL ENGINEER SEAL 030472

**Kimley»Horn**

NC License #F-0102  
 421 Fayetteville St., Suite 600  
 Raleigh, NC 27636  
 Tel: (919) 677-2000  
 Fax: (919) 677-2050

11/15/2016 K:\ARL\TPTD\ITS\01036305 - Fayetteville Sig Sys\Plans\Splicing\01036305-ITS\_psh-IB5-CH3 06-1303.dgn

**CHANNEL 3 EXTENSION  
NEW SPLICE ENCLOSURE  
MURCHINSON RD AT NC-295  
SB RAMPS  
06-1302**

**COLOR CODE**  
TIA/EIA 598-C

|            |             |
|------------|-------------|
| (1) BLUE   | (7) RED     |
| (2) ORANGE | (8) BLACK   |
| (3) GREEN  | (9) YELLOW  |
| (4) BROWN  | (10) VIOLET |
| (5) SLATE  | (11) ROSE   |
| (6) WHITE  | (12) AQUA   |

**LEGEND**

X - FUSION SPLICE INDIVIDUAL FIBER  
 O - EXISTING SPLICE  
 □ - EXPRESS INDIVIDUAL FIBER

EXPRESS - EXPRESS ENTIRE BUFFER TUBE  
 SPLICE - SPLICE ENTIRE BUFFER TUBE OR MAINTAIN IF EXISTING EXPRESSED

**NOTES:**  
 1. FIBER INTERCONNECT CENTER RACKS ARE SCHEMATIC ONLY - ACTUAL EQUIPMENT FORM MAY VARY.  
 2. ETHERNET SWITCH TERMINATION CONFIGURATIONS ARE GENERIC. CONTRACTOR IS RESPONSIBLE FOR DETERMINING /ENSURING PROPER TERMINATION.  
 3. CONTRACTOR IS RESPONSIBLE FOR FIELD VERIFYING EXISTING SPLICING. THE CONTRACTOR SHALL COORDINATE WITH THE ENGINEER WHERE EXISTING SPLICING IS NOT AS EXPECTED.

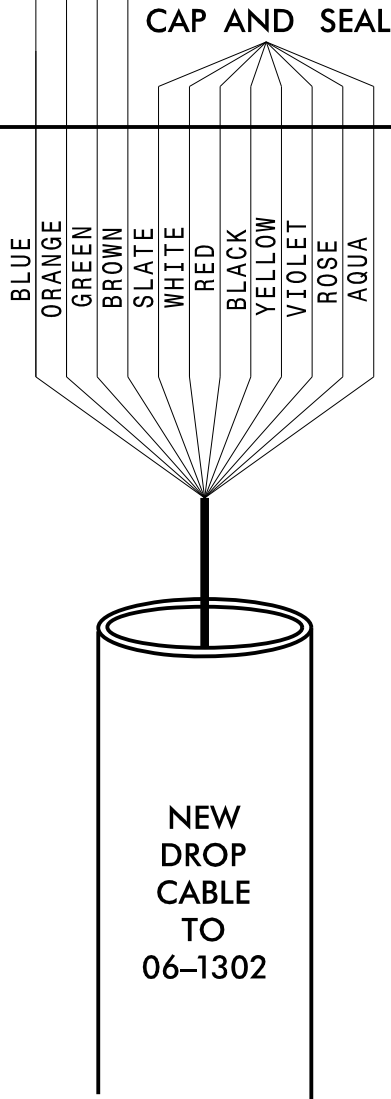
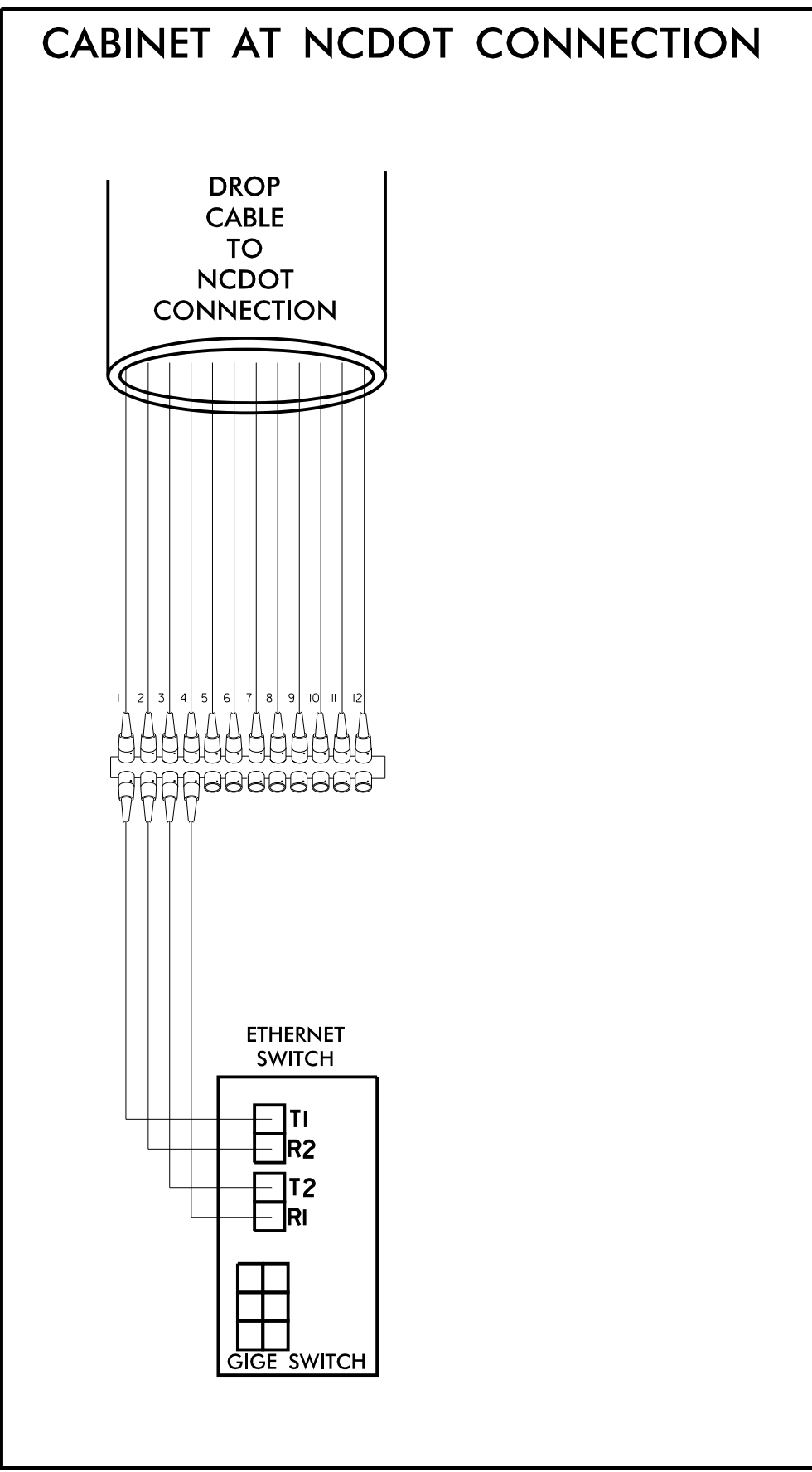
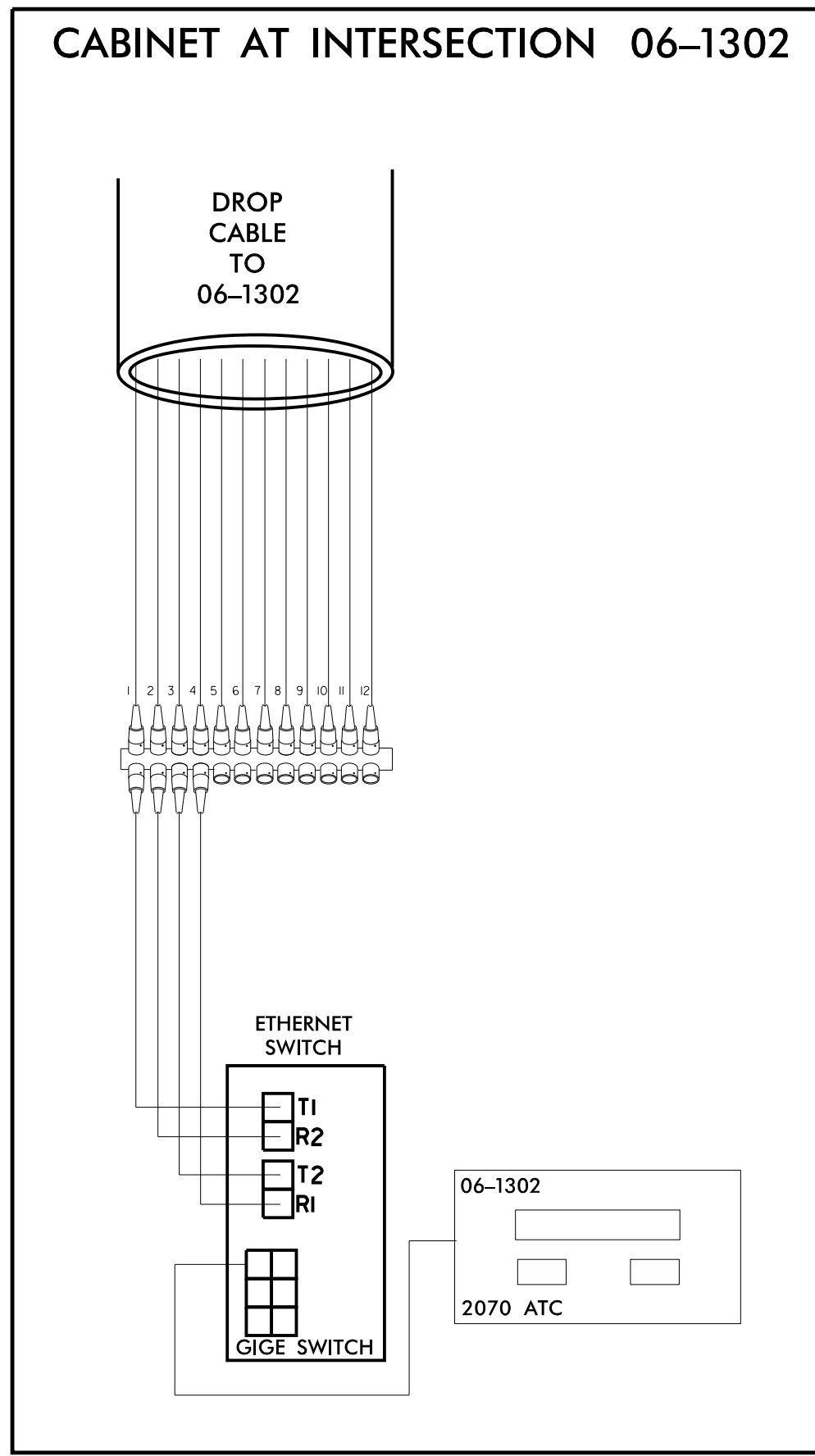
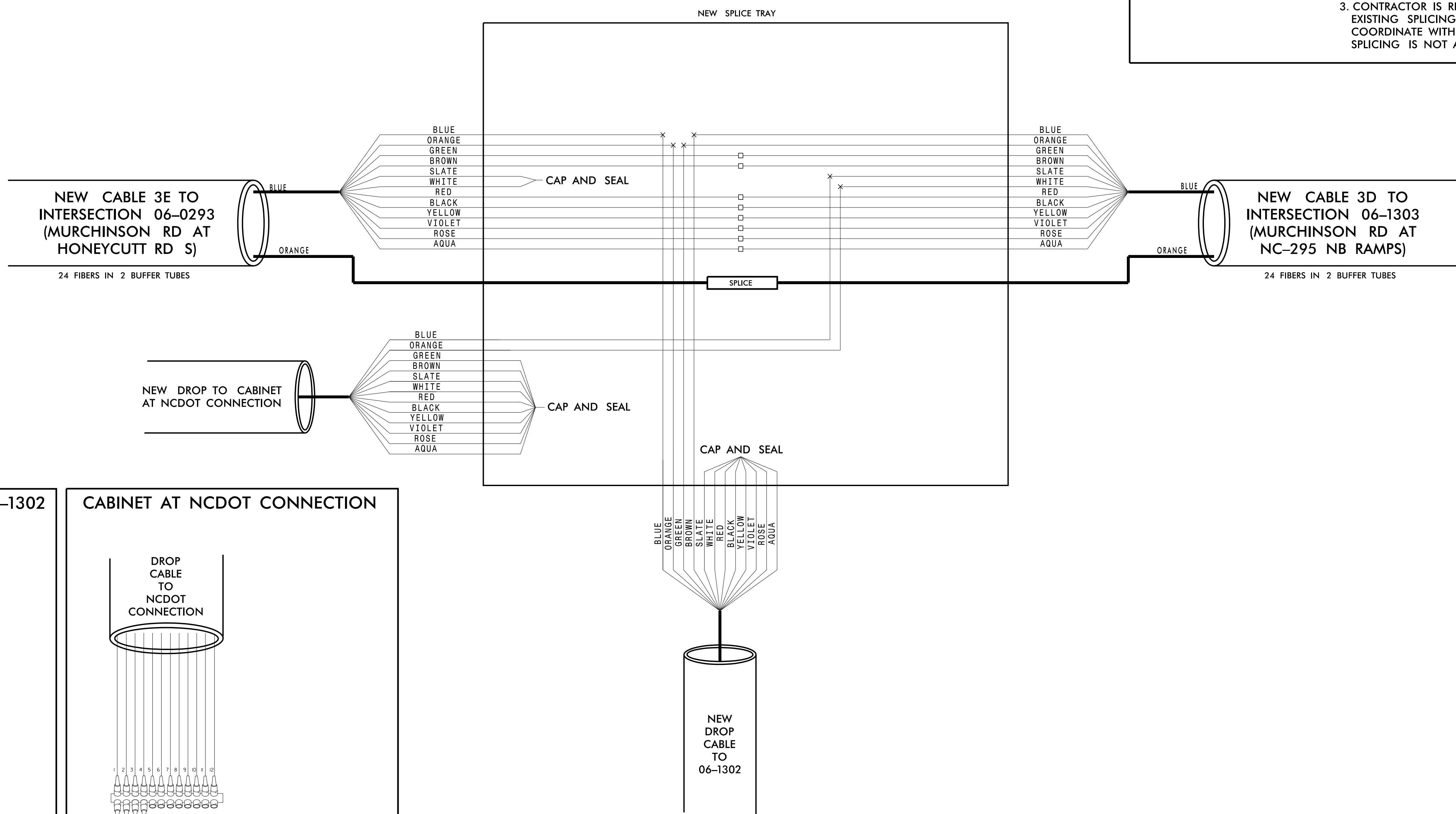

11/15/2016 K:\ARL\_TPTD\_ITS\01036305 - Fayetteville Sig Sys\Plans\Splicing\01036305-ITS\_psh-186-CH3 NCDOT AT 06-1302.dgn

**Kimley»Horn**  
 NC License #F-0102  
 421 Fayetteville St., Suite 600  
 Raleigh, NC 27636  
 Tel: (919) 677-2000  
 Fax: (919) 677-2050

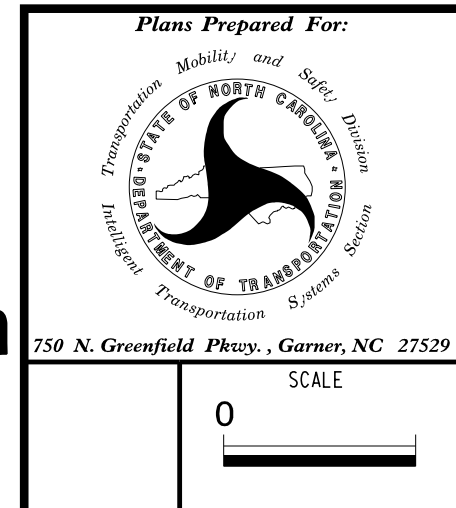

**CHANNEL 3 EXTENSION**

**FAYETTEVILLE COMPUTERIZED SIGNAL SYSTEM  
SPLICE DETAIL**

|                          |                               |                   |                          |
|--------------------------|-------------------------------|-------------------|--------------------------|
| DIVISION 06              |                               | CUMBERLAND COUNTY |                          |
| PLAN DATE: NOVEMBER 2016 | REVIEWED BY: N. M. MENGELKOCH | PREPARED BY: KHA  | REVIEWED BY: K. W. SMITH |
| REVISIONS                | INIT.                         | DATE              |                          |

SEAL

030472

Kevin W. Smith

11/15/2016

CADD File name:

**CHANNEL 3  
EXISTING SPLICE ENCLOSURE  
US 401 /US 401 BYPASS AT NC 24  
(BRAGG BLVD)**

**COLOR CODE**  
TIA/EIA 598-C

|            |             |
|------------|-------------|
| (1) BLUE   | (7) RED     |
| (2) ORANGE | (8) BLACK   |
| (3) GREEN  | (9) YELLOW  |
| (4) BROWN  | (10) VIOLET |
| (5) SLATE  | (11) ROSE   |
| (6) WHITE  | (12) AQUA   |

**LEGEND**

X - FUSION SPLICE INDIVIDUAL FIBER  
 O - EXISTING SPLICE  
 □ - EXPRESS INDIVIDUAL FIBER

EXPRESS - EXPRESS ENTIRE BUFFER TUBE  
 SPLICE - SPLICE ENTIRE BUFFER TUBE OR MAINTAIN IF EXISTING EXPRESSED

**NOTES:**

- FIBER INTERCONNECT CENTER RACKS ARE SCHEMATIC ONLY - ACTUAL EQUIPMENT FORM MAY VARY.
- ETHERNET SWITCH TERMINATION CONFIGURATIONS ARE GENERIC. CONTRACTOR IS RESPONSIBLE FOR DETERMINING /ENSURING PROPER TERMINATION.
- CONTRACTOR IS RESPONSIBLE FOR FIELD VERIFYING EXISTING SPLICING. THE CONTRACTOR SHALL COORDINATE WITH THE ENGINEER WHERE EXISTING SPLICING IS NOT AS EXPECTED.

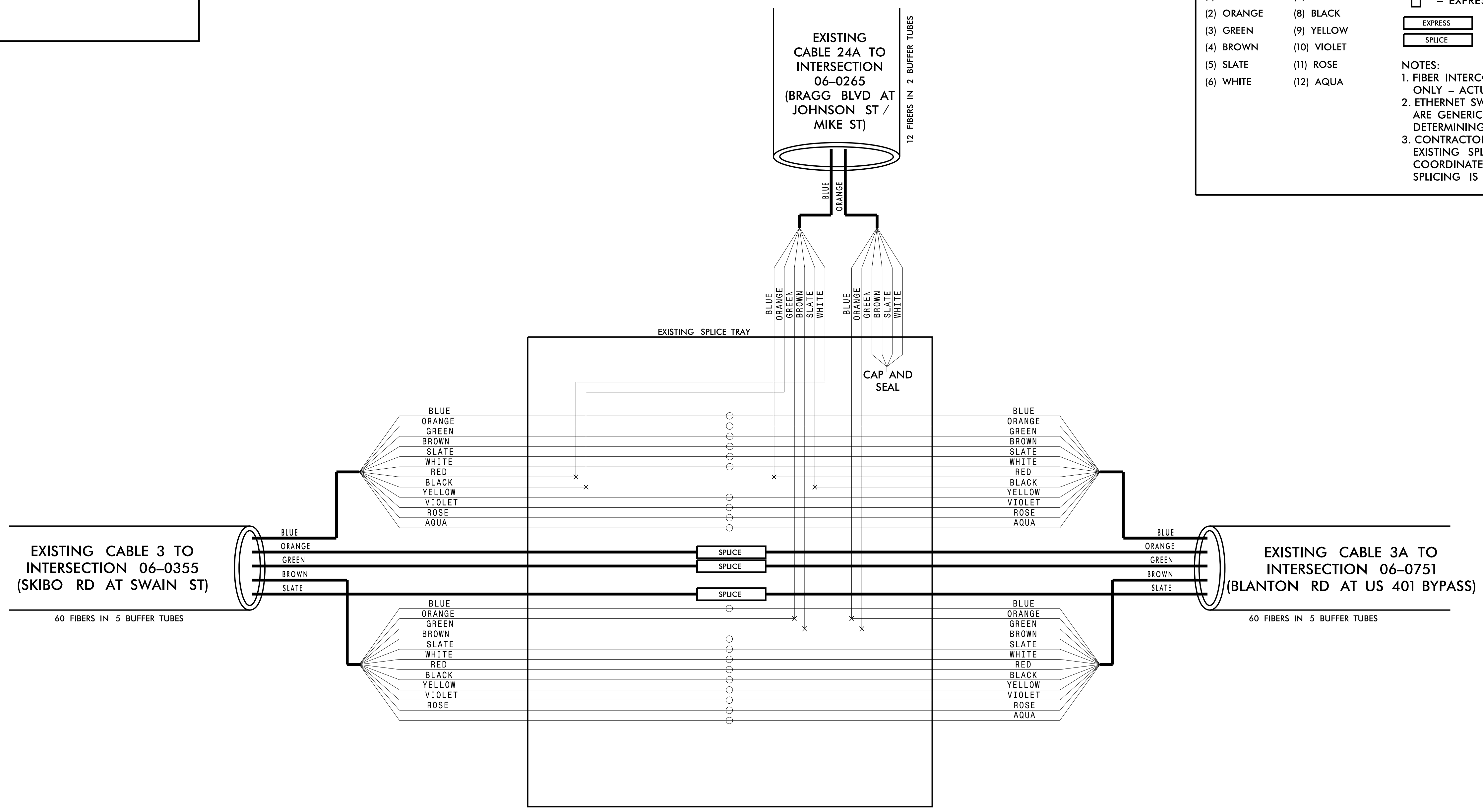

11/15/2016 KARAL\_TPTD\_ITS\_01036305 - Fayetteville Sig Sys Plans\Splicing\01036305-ITS\_psh-187-CH3 06-0083.dgn

**CHANNEL 3**

| <p><b>Kimley»Horn</b><br/>         NC License #F-0102<br/>         421 Fayetteville St., Suite 600<br/>         Raleigh, NC 27636<br/>         Tel: (919) 677-2000<br/>         Fax: (919) 677-2050</p> | <p><b>FAYETTEVILLE COMPUTERIZED SIGNAL SYSTEM</b></p> <p><b>SPLICE DETAIL</b></p>  |           | <p>SEAL</p> |      |  |  |  |  |
|---|--|-----------|-------------|------|--|--|--|--|
|   | <p>DIVISION 06 CUMBERLAND COUNTY</p> <p>PLAN DATE: NOVEMBER 2016 REVIEWED BY: N. M. MENGELKOCH</p> <p>PREPARED BY: KHA REVIEWED BY: K. W. SMITH</p>                  |           |             |      |  |  |  |  |
| <p>SCALE</p> <p>0</p>   | <table border="1"> <thead> <tr> <th>REVISIONS</th> <th>INIT.</th> <th>DATE</th> </tr> </thead> <tbody> <tr> <td> </td> <td> </td> <td> </td> </tr> </tbody> </table> | REVISIONS | INIT.       | DATE |  |  |  | <p>DocuSigned by:<br/> <br/>         SEAL<br/>         030472<br/>         KEVIN W. SMITH<br/>         ENGINEER<br/>         STATE OF NORTH CAROLINA</p> <p>11/15/2016</p> <p>SIGNATURE DATE</p> <p>CADD Filename:</p> |
| REVISIONS   | INIT.  | DATE      |             |      |  |  |  |  |
|   |  |           |             |      |  |  |  |  |

**CHANNEL 3  
EXISTING SPLICE ENCLOSURE  
(US 401 (SKIBO RD) AT WAL-MART  
ENTRANCE)  
SIG ID 06-1161**

**COLOR CODE**  
TIA/EIA 598-C

|            |             |
|------------|-------------|
| (1) BLUE   | (7) RED     |
| (2) ORANGE | (8) BLACK   |
| (3) GREEN  | (9) YELLOW  |
| (4) BROWN  | (10) VIOLET |
| (5) SLATE  | (11) ROSE   |
| (6) WHITE  | (12) AQUA   |

**LEGEND**

- X - FUSION SPLICE INDIVIDUAL FIBER
- O - EXISTING SPLICE
- - EXPRESS INDIVIDUAL FIBER

EXPRESS: EXPRESS ENTIRE BUFFER TUBE  
SPLICE: SPLICE ENTIRE BUFFER TUBE OR MAINTAIN IF EXISTING EXPRESSED

**NOTES:**

- FIBER INTERCONNECT CENTER RACKS ARE SCHEMATIC ONLY - ACTUAL EQUIPMENT FORM MAY VARY.
- ETHERNET SWITCH TERMINATION CONFIGURATIONS ARE GENERIC. CONTRACTOR IS RESPONSIBLE FOR DETERMINING /ENSURING PROPER TERMINATION.
- CONTRACTOR IS RESPONSIBLE FOR FIELD VERIFYING EXISTING SPLICING. THE CONTRACTOR SHALL COORDINATE WITH THE ENGINEER WHERE EXISTING SPLICING IS NOT AS EXPECTED.

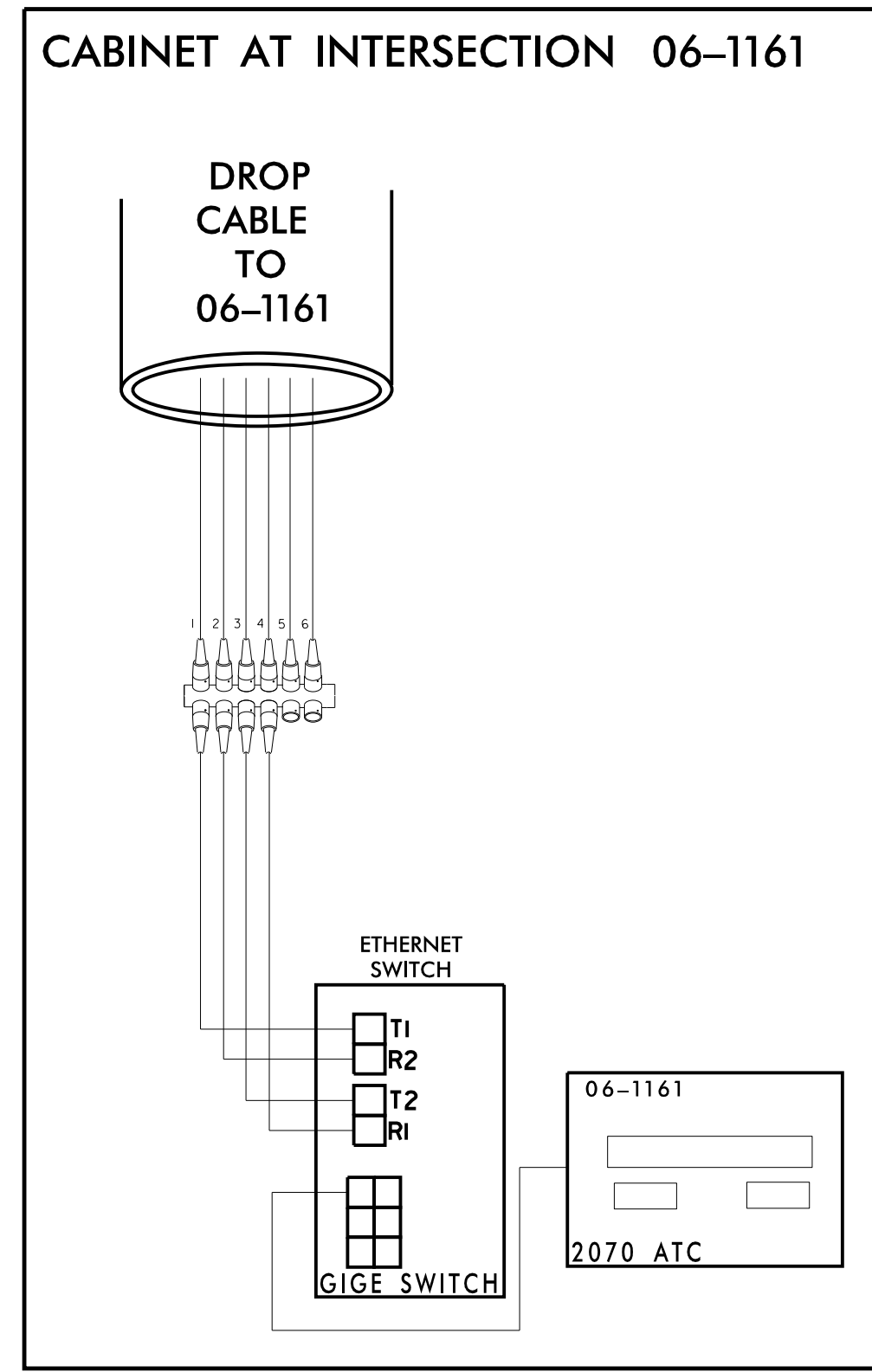
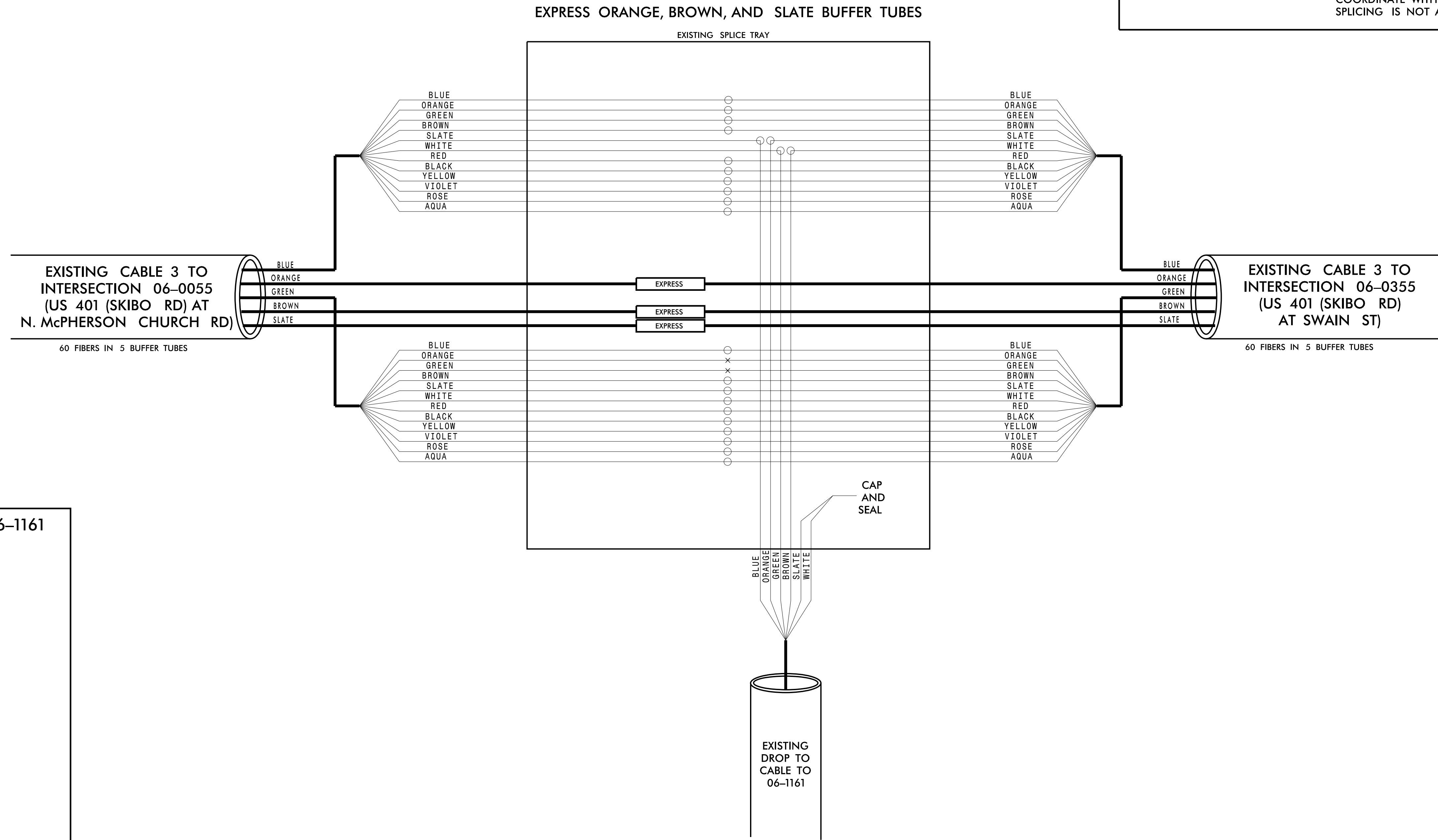

**CHANNEL 3  
FAYETTEVILLE COMPUTERIZED  
SIGNAL SYSTEM  
SPLICE DETAIL**

|                          |                               |                   |                          |
|--------------------------|-------------------------------|-------------------|--------------------------|
| DIVISION 06              |                               | CUMBERLAND COUNTY |                          |
| PLAN DATE: NOVEMBER 2016 | REVIEWED BY: N. M. MENGELKOCH | PREPARED BY: KHA  | REVIEWED BY: K. W. SMITH |
| REVISIONS                |                               | INIT.             | DATE                     |
|                          |                               |                   |                          |

11/15/2016  
 SIGNATURE: Kevin W. Smith  
 DATE: 11/15/2016  
 CADD Filename:

**Kimley»Horn**  
 NC License #F-0102  
 421 Fayetteville St., Suite 600  
 Raleigh, NC 27636  
 Tel: (919) 677-2000  
 Fax: (919) 677-2050

11/15/2016  
 K:\ARL\TPTD\ITS\01036305 - Fayetteville Sig Sys\Plans\Splicing\01036305-ITS-psr-188-CH3 06-1161.CMS Hor-vest.dgn



**CHANNEL 4**  
**EXISTING SPLICE ENCLOSURE**  
**(BRAGG BLVD AT SHANNON DR)**  
**SIG ID 06-0153**  
**CCTV 23**

**COLOR CODE**  
 TIA/EIA 598-C

|            |             |
|------------|-------------|
| (1) BLUE   | (7) RED     |
| (2) ORANGE | (8) BLACK   |
| (3) GREEN  | (9) YELLOW  |
| (4) BROWN  | (10) VIOLET |
| (5) SLATE  | (11) ROSE   |
| (6) WHITE  | (12) AQUA   |

**LEGEND**

X - FUSION SPLICE INDIVIDUAL FIBER  
 O - EXISTING SPLICE  
 □ - EXPRESS INDIVIDUAL FIBER

EXPRESS - EXPRESS ENTIRE BUFFER TUBE  
 SPLICE - SPLICE ENTIRE BUFFER TUBE OR MAINTAIN IF EXISTING EXPRESSED

**NOTES:**

- FIBER INTERCONNECT CENTER RACKS ARE SCHEMATIC ONLY - ACTUAL EQUIPMENT FORM MAY VARY.
- ETHERNET SWITCH TERMINATION CONFIGURATIONS ARE GENERIC. CONTRACTOR IS RESPONSIBLE FOR DETERMINING /ENSURING PROPER TERMINATION.
- CONTRACTOR IS RESPONSIBLE FOR FIELD VERIFYING EXISTING SPlicing. THE CONTRACTOR SHALL COORDINATE WITH THE ENGINEER WHERE EXISTING SPlicing IS NOT AS EXPECTED.

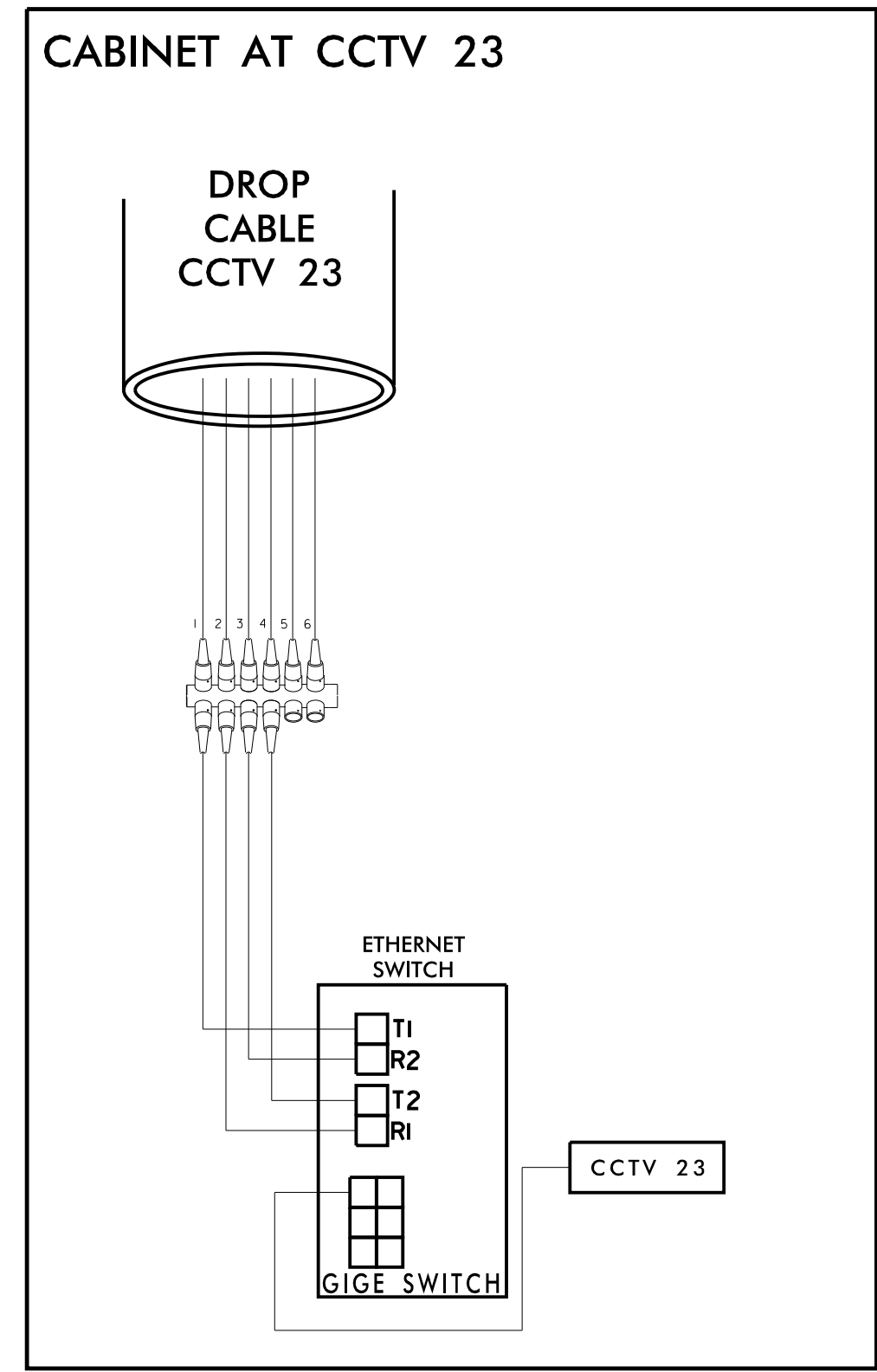
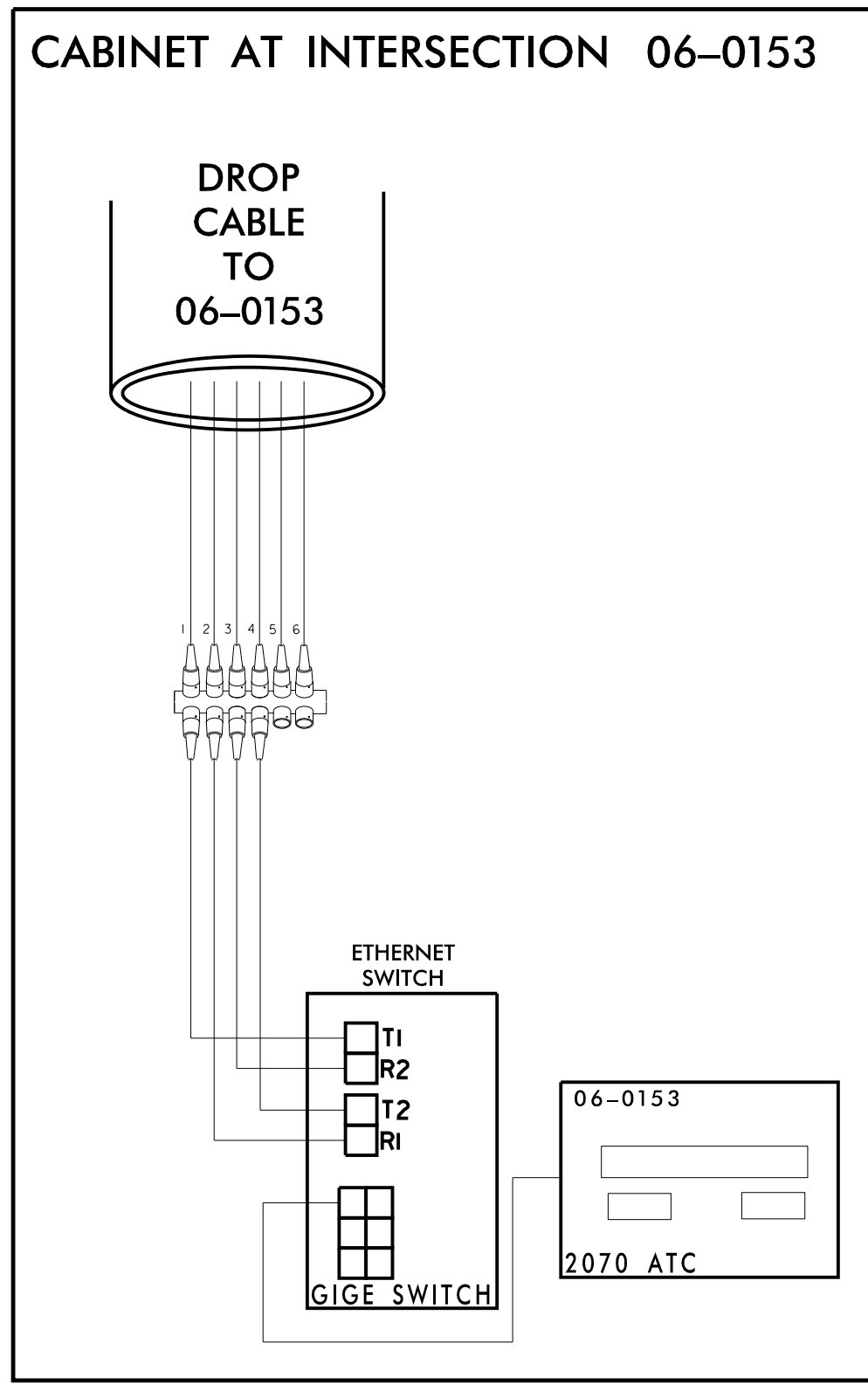
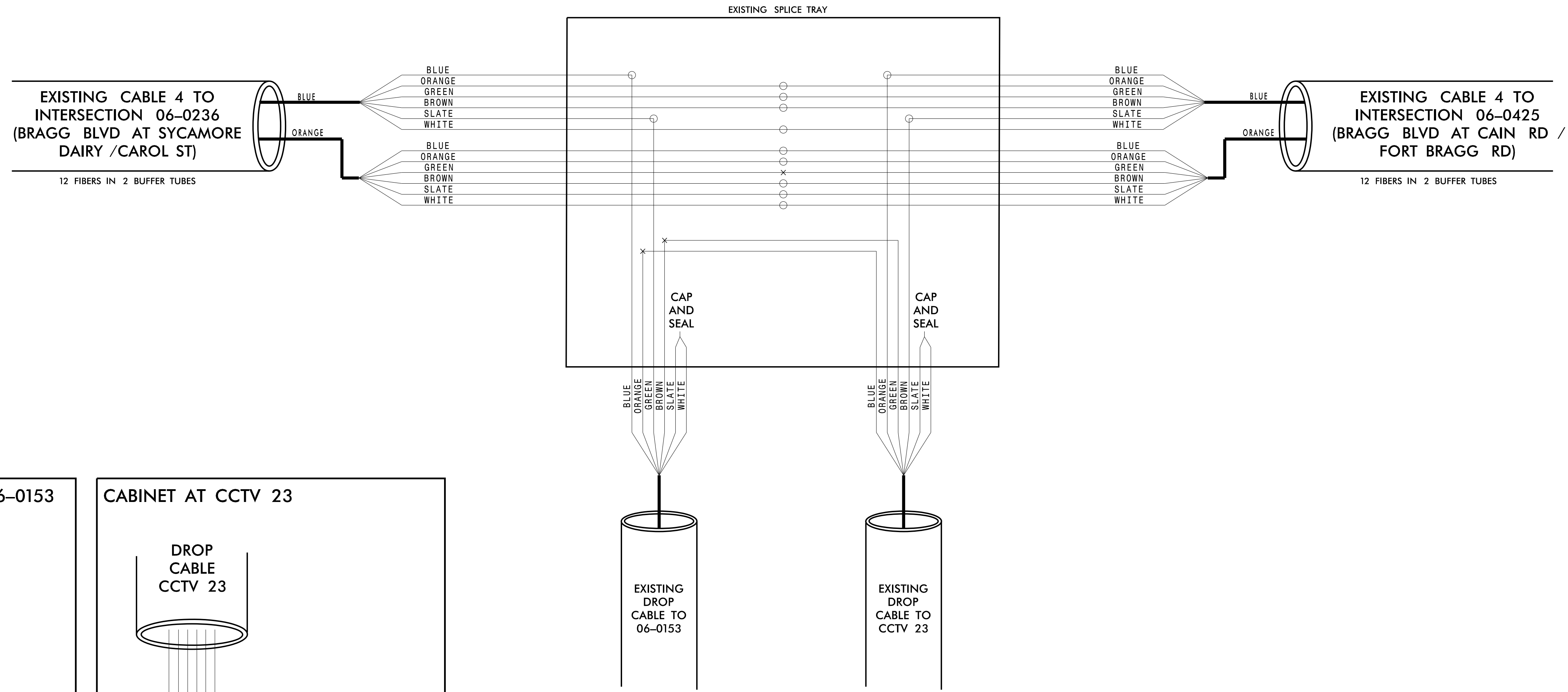

**CHANNEL 4**

**FAYETTEVILLE COMPUTERIZED SIGNAL SYSTEM**  
**SPLICE DETAIL**

DIVISION 06 CUMBERLAND COUNTY

PLAN DATE: NOVEMBER 2016 REVIEWED BY: N. W. MENGELKOCH

PREPARED BY: KHA REVIEWED BY: K. W. SMITH

SCALE: 0

SEAL: NORTH CAROLINA PROFESSIONAL ENGINEER KEVIN W. SMITH SEAL 030472

SIGNATURE: Kevin W. Smith DATE: 11/15/2016

CADD Filename:

**Kimley»Horn**  
 NC License #F-0102  
 421 Fayetteville St., Suite 600  
 Raleigh, NC 27636  
 Tel: (919) 677-2000  
 Fax: (919) 677-2050

11/15/2016 K:\ARL\TPTD\ITS\01036305 - Fayetteville Sig Sys\Plans\Splicing\01036305-ITS\_psh-189-CH4 06-0153 and CCTV23.dgn

**CHANNEL 6**  
**EXISTING SPLICE ENCLOSURE**  
**(GILLESPIE ST AT OWEN DR)**  
**SIG ID 06-0051**  
**CCTV 18**

**COLOR CODE**  
 TIA/EIA 598-C

|            |             |
|------------|-------------|
| (1) BLUE   | (7) RED     |
| (2) ORANGE | (8) BLACK   |
| (3) GREEN  | (9) YELLOW  |
| (4) BROWN  | (10) VIOLET |
| (5) SLATE  | (11) ROSE   |
| (6) WHITE  | (12) AQUA   |

**LEGEND**

X - FUSION SPLICE INDIVIDUAL FIBER  
 O - EXISTING SPLICE  
 □ - EXPRESS INDIVIDUAL FIBER

EXPRESS - EXPRESS ENTIRE BUFFER TUBE  
 SPLICE - SPLICE ENTIRE BUFFER TUBE OR MAINTAIN IF EXISTING EXPRESSED

**NOTES:**  
 1. FIBER INTERCONNECT CENTER RACKS ARE SCHEMATIC ONLY - ACTUAL EQUIPMENT FORM MAY VARY.  
 2. ETHERNET SWITCH TERMINATION CONFIGURATIONS ARE GENERIC. CONTRACTOR IS RESPONSIBLE FOR DETERMINING /ENSURING PROPER TERMINATION.  
 3. CONTRACTOR IS RESPONSIBLE FOR FIELD VERIFYING EXISTING SPlicing. THE CONTRACTOR SHALL COORDINATE WITH THE ENGINEER WHERE EXISTING SPlicing IS NOT AS EXPECTED.

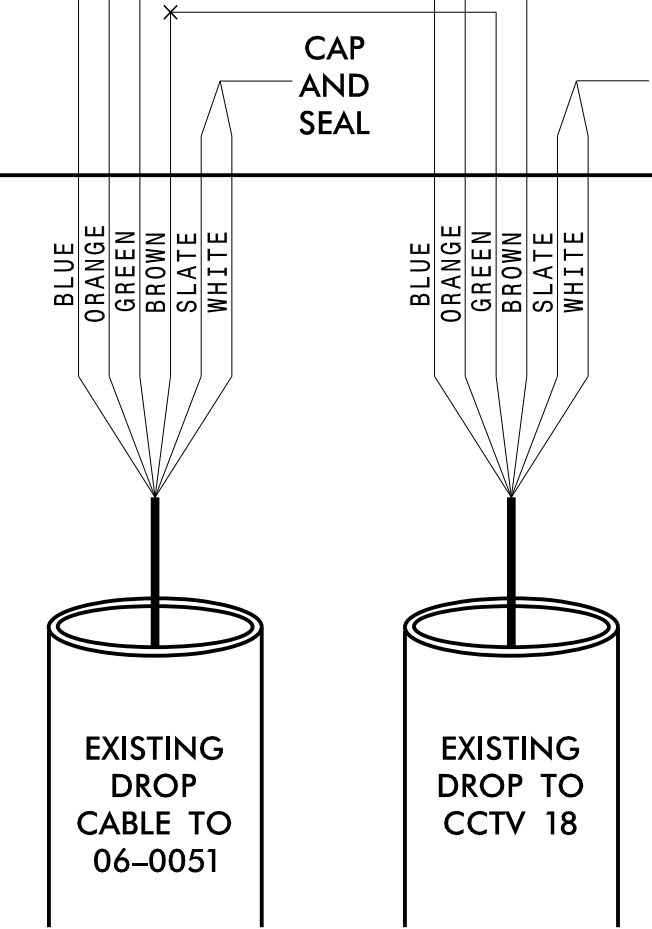
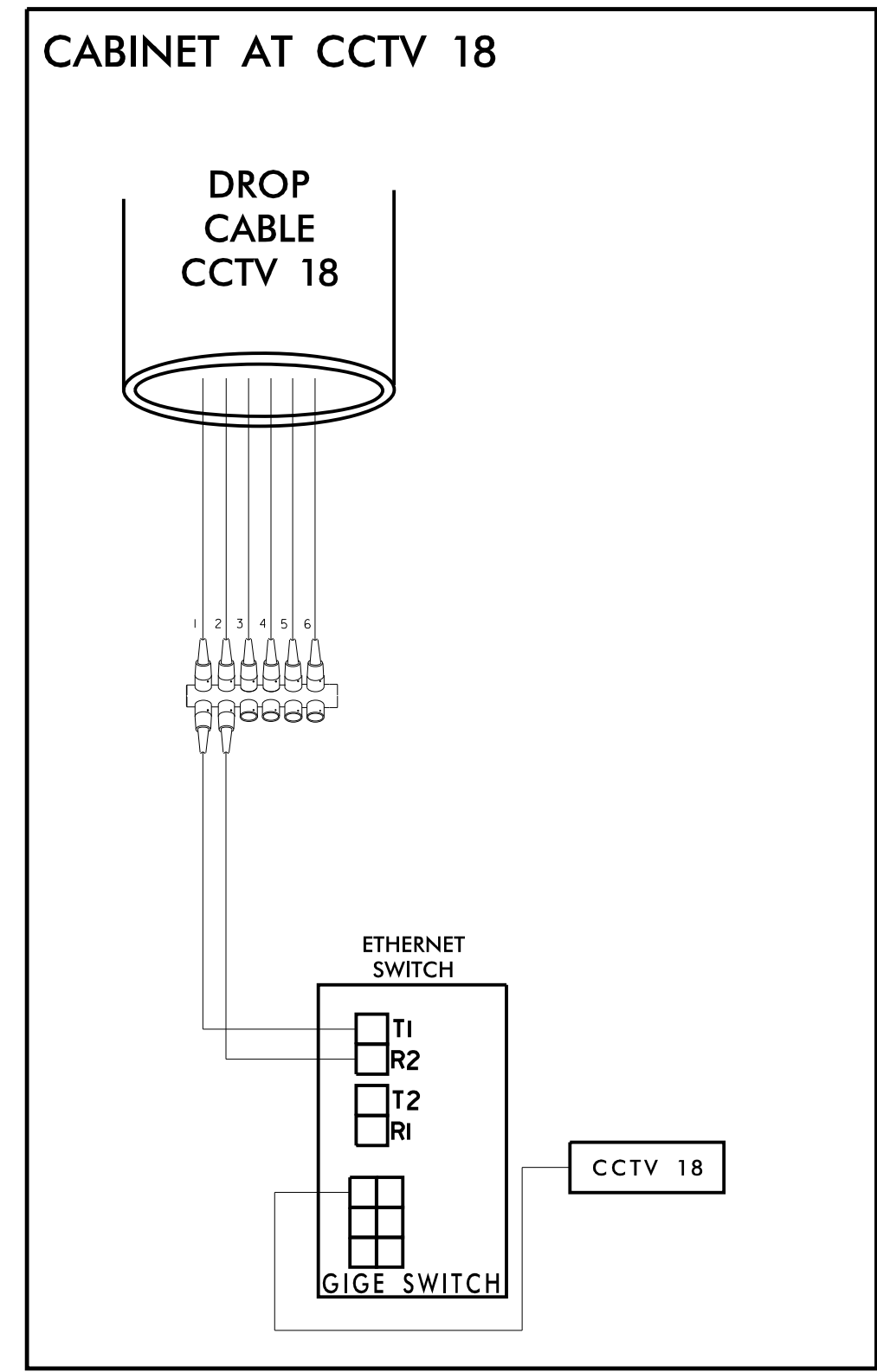
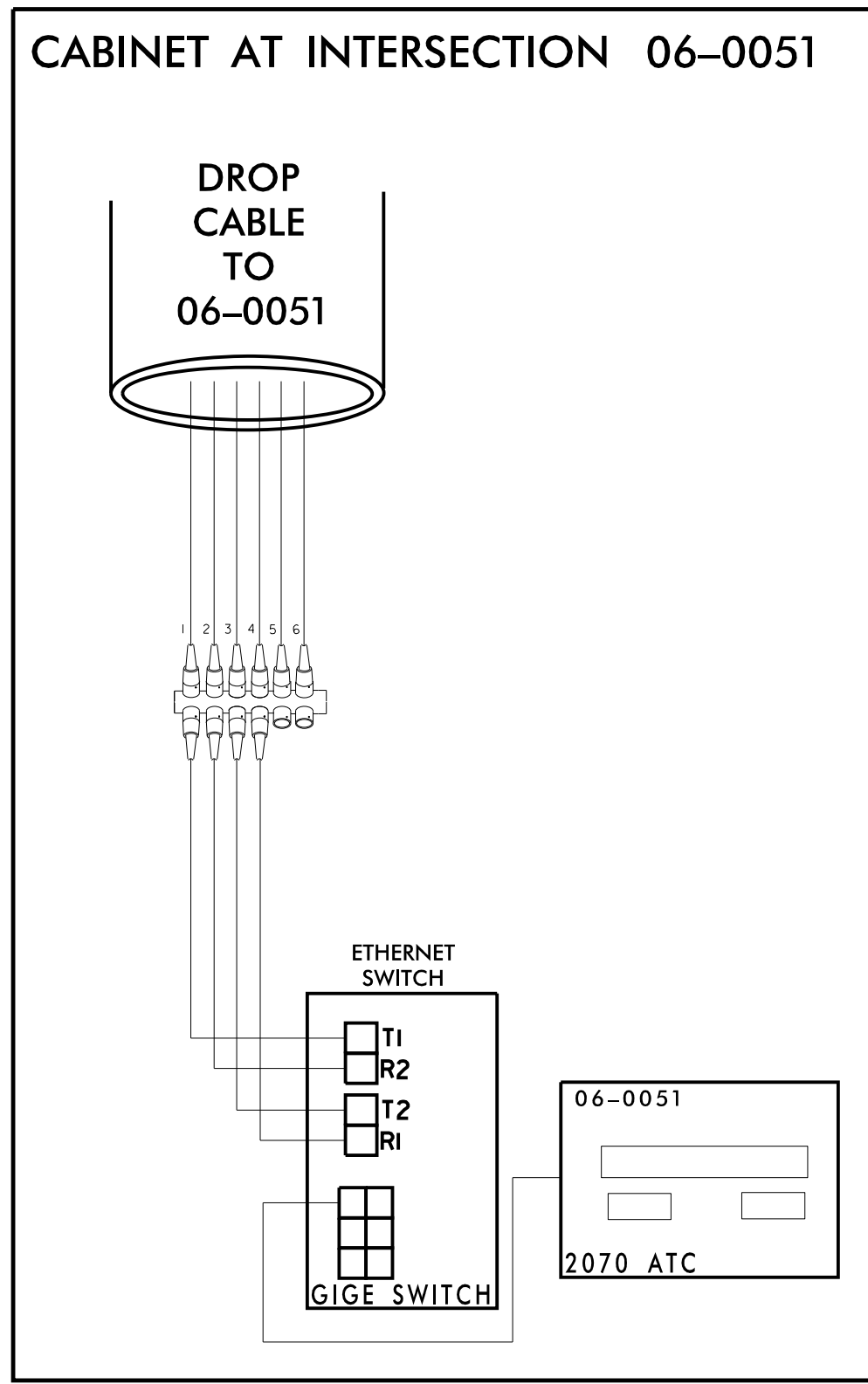
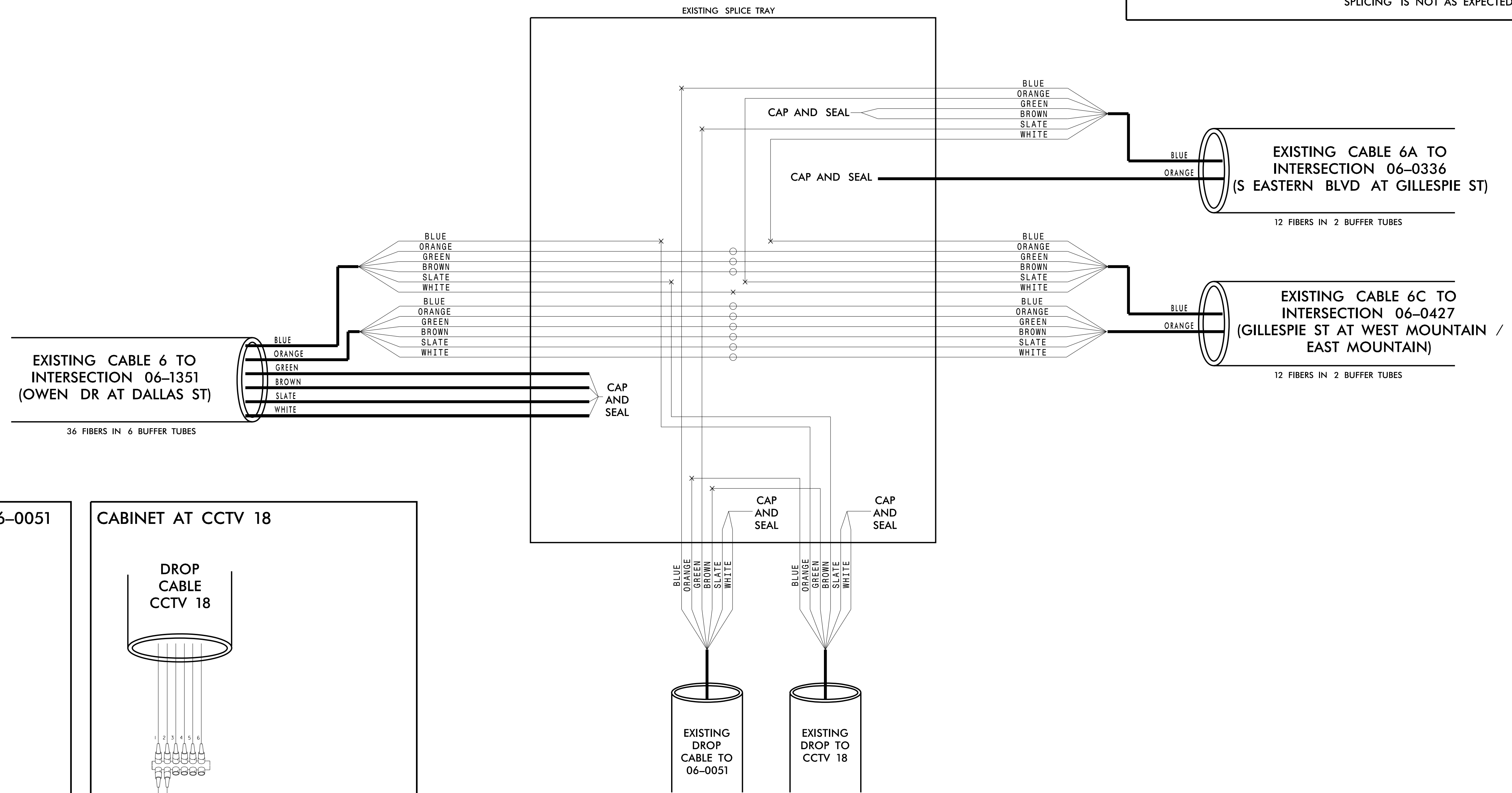

**CHANNEL 6**  
**FAYETTEVILLE COMPUTERIZED SIGNAL SYSTEM**  
**SPLICE DETAIL**

Division 06 CUMBERLAND COUNTY

PLAN DATE: NOVEMBER 2016 REVIEWED BY: N. M. MENGELKOCH

PREPARED BY: KHA REVIEWED BY: K. W. SMITH

SCALE: 0

**Kimley Horn**  
 NC License #F-0102  
 421 Fayetteville St., Suite 600  
 Raleigh, NC 27636  
 Tel: (919) 677-2000  
 Fax: (919) 677-2050

SEAL  
 NORTH CAROLINA PROFESSIONAL ENGINEER  
 KEVIN W. SMITH  
 SEAL 030472  
 11/15/2016

11/15/2016 K:\ARL\TPTD\ITS\01036305 - Fayetteville Sig Sys\Plans\Splicing\01036305-ITS\_psh\_190-Ch6 CCTV18 Harvest at 06-0051.dgn

**CHANNEL 6  
EXISTING SPLICE ENCLOSURE  
(GILLESPIE ST AT WEST MOUNTAIN /  
EAST MOUNTAIN)  
SIG ID 06-0427  
CCTV 31**

| COLOR CODE<br>TIA/EIA 598-C |             | LEGEND  |  |
|-----------------------------|-------------|---------|--|
| (1) BLUE                    | (7) RED     | X       | - FUSION SPLICE INDIVIDUAL FIBER                               |
| (2) ORANGE                  | (8) BLACK   | O       | - EXISTING SPLICE  |
| (3) GREEN                   | (9) YELLOW  | □       | - EXPRESS INDIVIDUAL FIBER                                     |
| (4) BROWN                   | (10) VIOLET | EXPRESS | EXPRESS ENTIRE BUFFER TUBE                                     |
| (5) SLATE                   | (11) ROSE   | SPLICE  | SPLICE ENTIRE BUFFER TUBE OR MAINTAIN<br>IF EXISTING EXPRESSED |
| (6) WHITE                   | (12) AQUA   |         |  |

**NOTES:**  
1. FIBER INTERCONNECT CENTER RACKS ARE SCHEMATIC ONLY - ACTUAL EQUIPMENT FORM MAY VARY.  
2. ETHERNET SWITCH TERMINATION CONFIGURATIONS ARE GENERIC. CONTRACTOR IS RESPONSIBLE FOR DETERMINING /ENSURING PROPER TERMINATION.  
3. CONTRACTOR IS RESPONSIBLE FOR FIELD VERIFYING EXISTING SPLICING. THE CONTRACTOR SHALL COORDINATE WITH THE ENGINEER WHERE EXISTING SPLICING IS NOT AS EXPECTED.

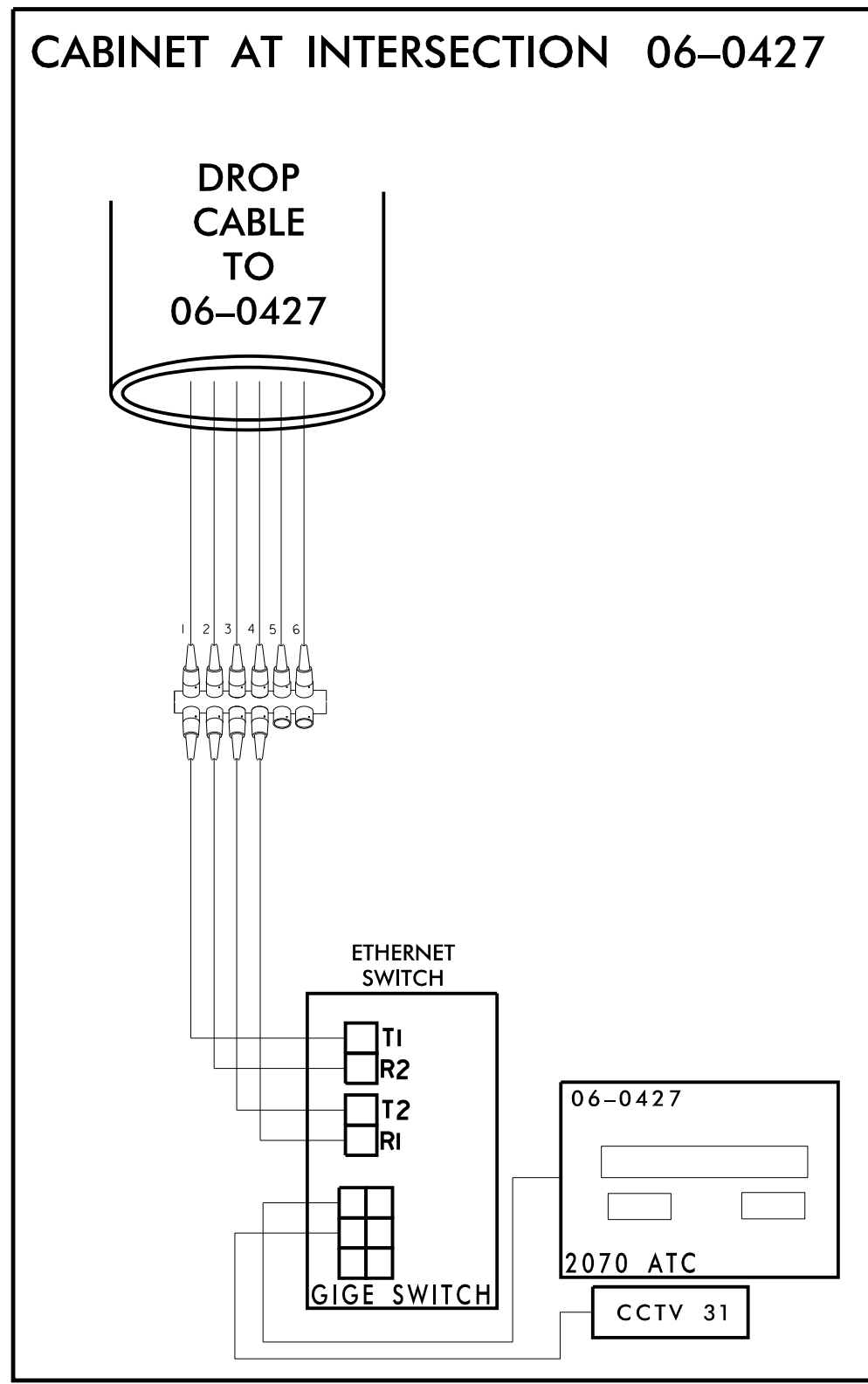
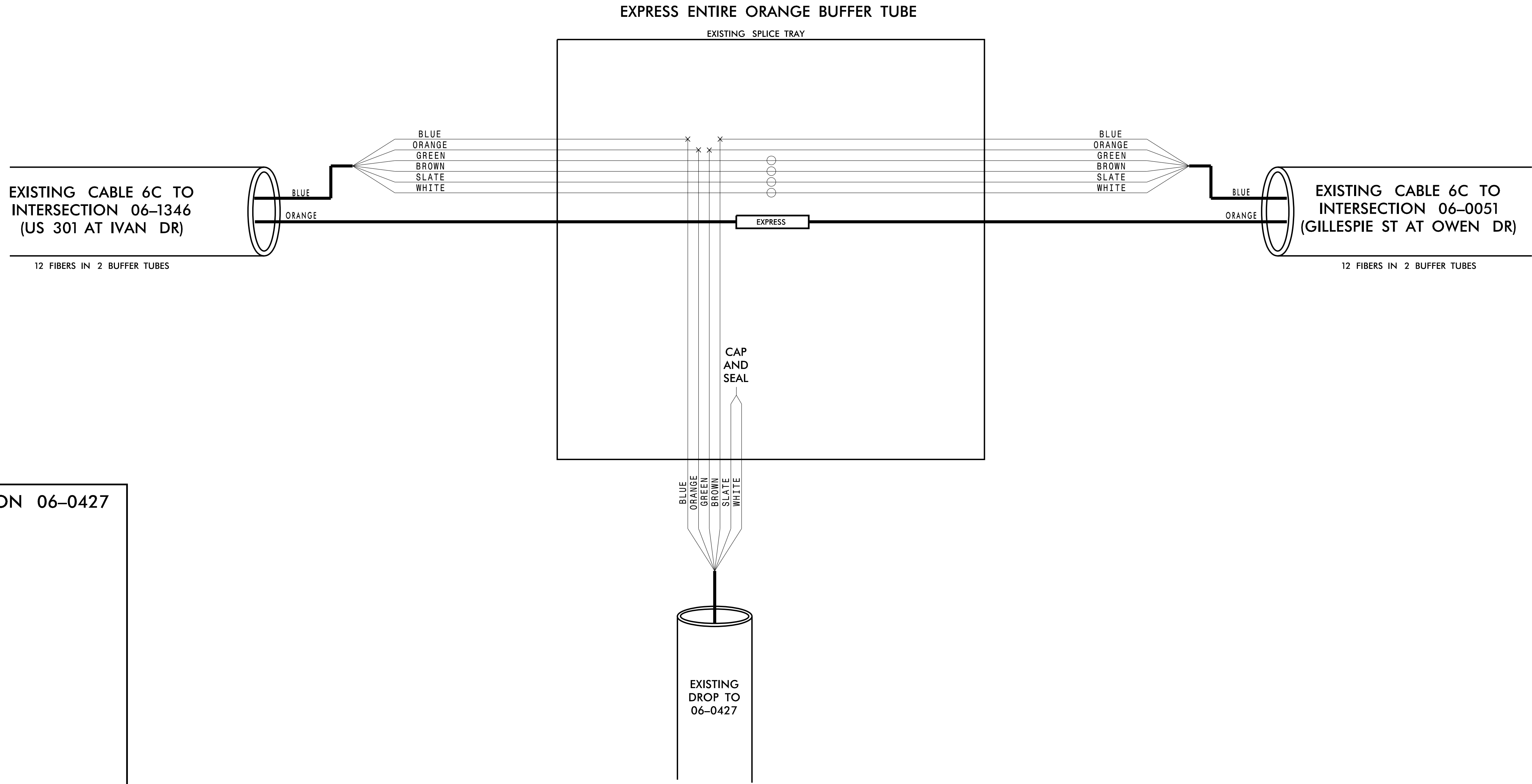

**CHANNEL 6**

|   |  |                                       |   |
|---|--|---------------------------------------|---|
| <br><b>Kimley»Horn</b><br><small>NC License #F-0102<br/>421 Fayetteville St., Suite 600<br/>Raleigh, NC 27636<br/>Tel: (919) 677-2000<br/>Fax: (919) 677-2050</small> | <b>FAYETTEVILLE COMPUTERIZED SIGNAL SYSTEM</b><br><b>SPLICE DETAIL</b>   |                                       | <br><b>SEAL</b><br>NORTH CAROLINA PROFESSIONAL ENGINEER<br>KEVIN W. SMITH<br>030472 |
|   | DIVISION 06 CUMBERLAND COUNTY<br>PLAN DATE: NOVEMBER 2016 REVIEWED BY: N. M. MENGELKOCH<br>PREPARED BY: KHA REVIEWED BY: K. W. SMITH |                                       |   |
| SCALE<br>0  | REVISIONS<br>_____<br>_____<br>_____   | INIT. DATE<br>_____<br>_____<br>_____ | DocuSigned by:<br><br>SIGNATURE DATE<br>11/15/2016<br>CADD File name:               |

11/15/2016 K:\ARL\_TPTD\_ITS\01036305 - Fayetteville Sig Sys\Plans\Splicing\01036305-ITS\_psh\_191-016\_06-0427.dgn

**CHANNEL 6  
EXISTING SPLICE ENCLOSURE  
(US 301 AT IVAN DR)  
SIG ID 06-1346**

**COLOR CODE**  
TIA/EIA 598-C

|            |             |
|------------|-------------|
| (1) BLUE   | (7) RED     |
| (2) ORANGE | (8) BLACK   |
| (3) GREEN  | (9) YELLOW  |
| (4) BROWN  | (10) VIOLET |
| (5) SLATE  | (11) ROSE   |
| (6) WHITE  | (12) AQUA   |

**LEGEND**

X - FUSION SPLICE INDIVIDUAL FIBER  
 O - EXISTING SPLICE  
 □ - EXPRESS INDIVIDUAL FIBER

EXPRESS - EXPRESS ENTIRE BUFFER TUBE  
 SPLICE - SPLICE ENTIRE BUFFER TUBE OR MAINTAIN IF EXISTING EXPRESSED

**NOTES:**  
 1. FIBER INTERCONNECT CENTER RACKS ARE SCHEMATIC ONLY - ACTUAL EQUIPMENT FORM MAY VARY.  
 2. ETHERNET SWITCH TERMINATION CONFIGURATIONS ARE GENERIC. CONTRACTOR IS RESPONSIBLE FOR DETERMINING /ENSURING PROPER TERMINATION.  
 3. CONTRACTOR IS RESPONSIBLE FOR FIELD VERIFYING EXISTING SPLICING. THE CONTRACTOR SHALL COORDINATE WITH THE ENGINEER WHERE EXISTING SPLICING IS NOT AS EXPECTED.

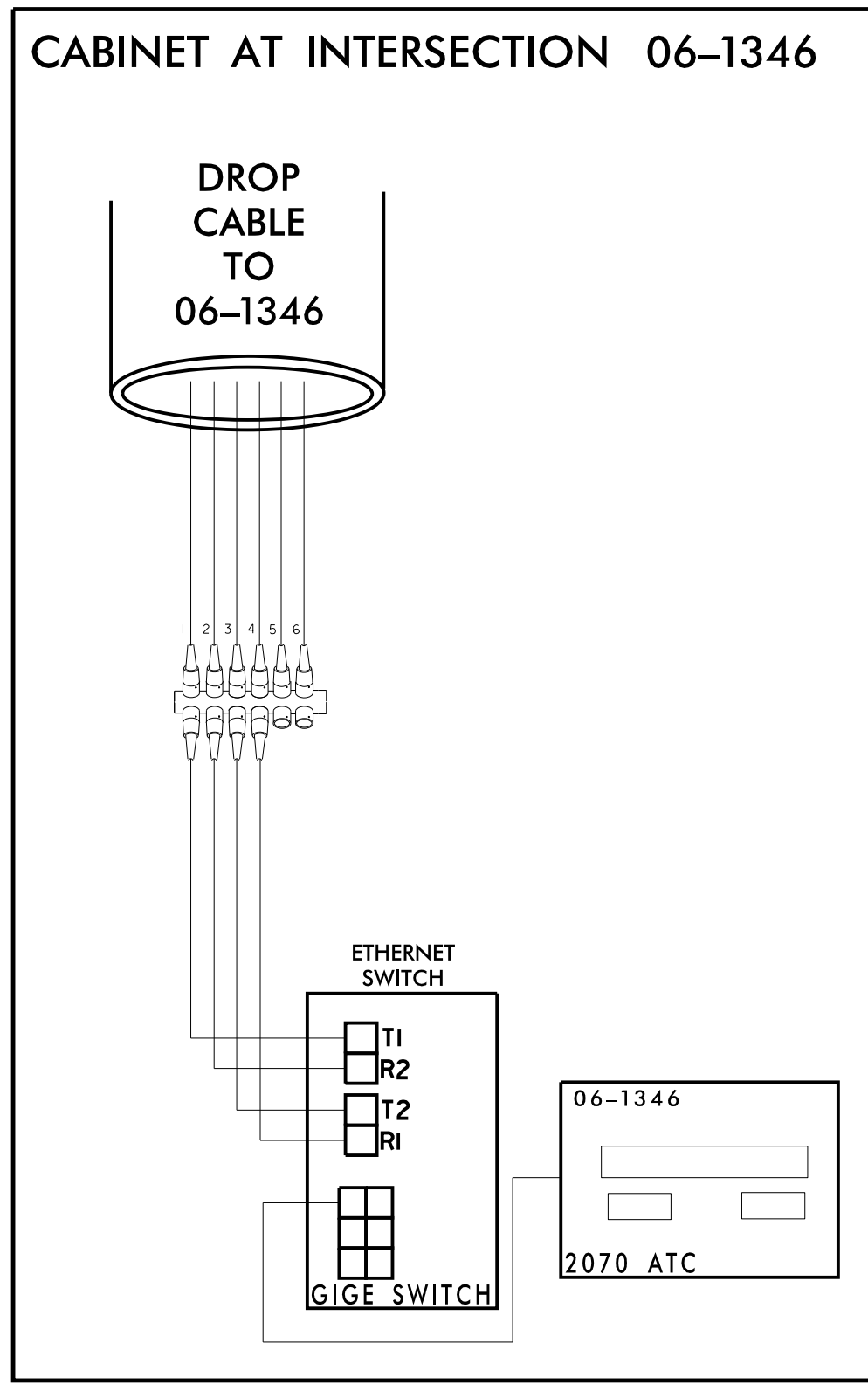
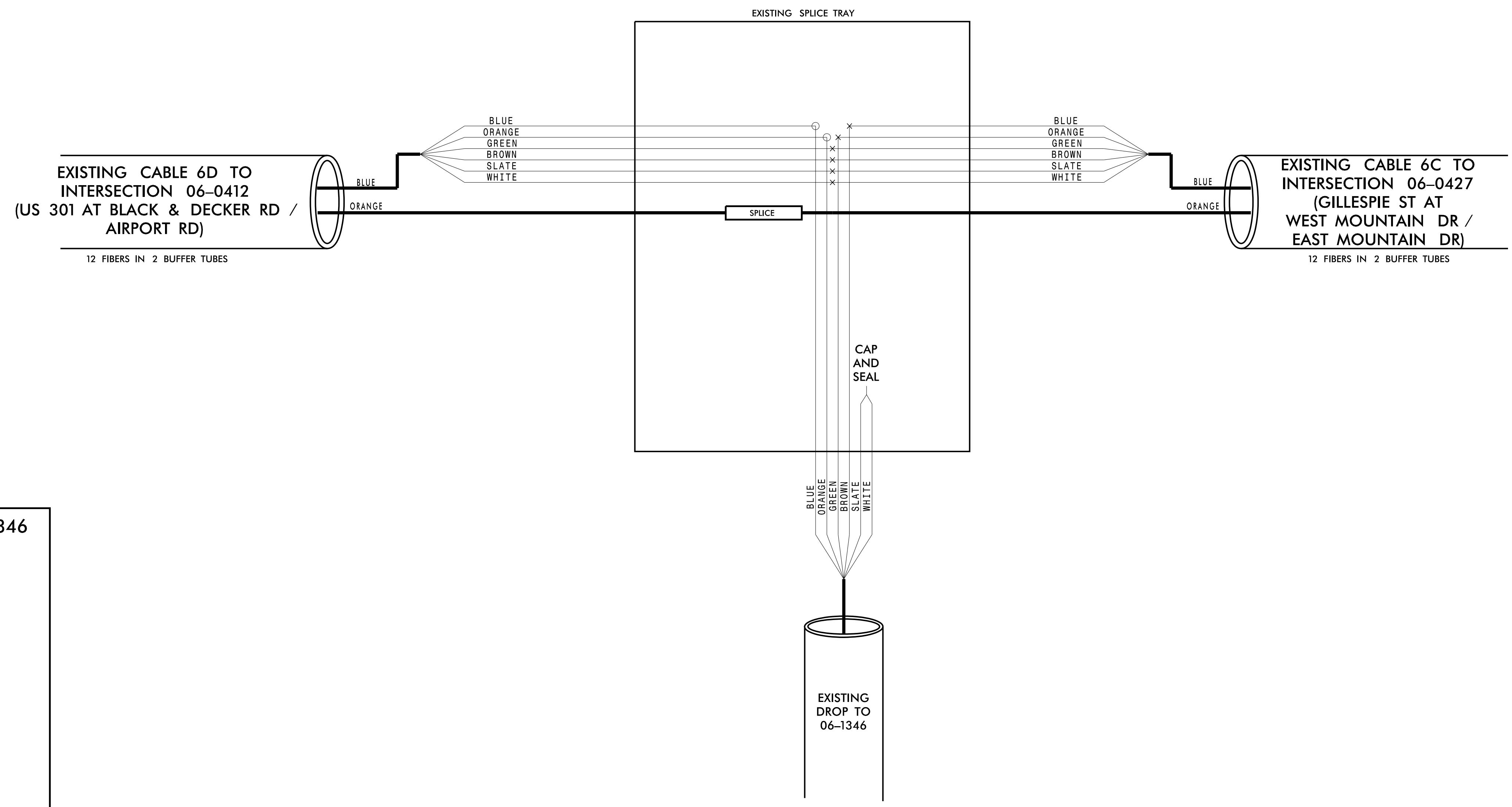

**CHANNEL 6  
FAYETTEVILLE COMPUTERIZED  
SIGNAL SYSTEM  
SPLICE DETAIL**

|  |                                       |
|--|---------------------------------------|
|  |                                       |
| DIVISION 06 CUMBERLAND COUNTY<br>PLAN DATE: NOVEMBER 2016 REVIEWED BY: N. M. MENGELKOCH<br>PREPARED BY: KHA REVIEWED BY: K. W. SMITH |                                       |
| REVISIONS<br>_____<br>_____<br>_____   | INIT. DATE<br>_____<br>_____<br>_____ |
| SCALE: 0<br>_____  |                                       |
| DocuSigned by:<br>Kevin W. Smith<br>11/15/2016<br>SIGNATURE DATE<br>CADD Filename:   |                                       |

**Kimley»Horn**  
 NC License #F-0102  
 421 Fayetteville St., Suite 600  
 Raleigh, NC 27636  
 Tel: (919) 677-2000  
 Fax: (919) 677-2050

11/15/2016 K:\ARL\TPTD\_ITS\01036305 - Fayetteville Sig Sys\Plans\Splicing\01036305-ITS\_psh\_192-CH6\_06-1346.dgn

**CHANNEL 6**  
**EXISTING SPLICE ENCLOSURE**  
**(US 301 AT BLACK & DECKER RD /**  
**AIRPORT RD)**  
**SIG ID 06-0412**  
**CCTV 40**

**COLOR CODE**  
 TIA/EIA 598-C

|            |             |
|------------|-------------|
| (1) BLUE   | (7) RED     |
| (2) ORANGE | (8) BLACK   |
| (3) GREEN  | (9) YELLOW  |
| (4) BROWN  | (10) VIOLET |
| (5) SLATE  | (11) ROSE   |
| (6) WHITE  | (12) AQUA   |

**LEGEND**

X - FUSION SPLICE INDIVIDUAL FIBER  
 O - EXISTING SPLICE  
 □ - EXPRESS INDIVIDUAL FIBER

EXPRESS - EXPRESS ENTIRE BUFFER TUBE  
 SPLICE - SPLICE ENTIRE BUFFER TUBE OR MAINTAIN IF EXISTING EXPRESSED

**NOTES:**

- FIBER INTERCONNECT CENTER RACKS ARE SCHEMATIC ONLY - ACTUAL EQUIPMENT FORM MAY VARY.
- ETHERNET SWITCH TERMINATION CONFIGURATIONS ARE GENERIC. CONTRACTOR IS RESPONSIBLE FOR DETERMINING /ENSURING PROPER TERMINATION.
- CONTRACTOR IS RESPONSIBLE FOR FIELD VERIFYING EXISTING SPLICING. THE CONTRACTOR SHALL COORDINATE WITH THE ENGINEER WHERE EXISTING SPLICING IS NOT AS EXPECTED.

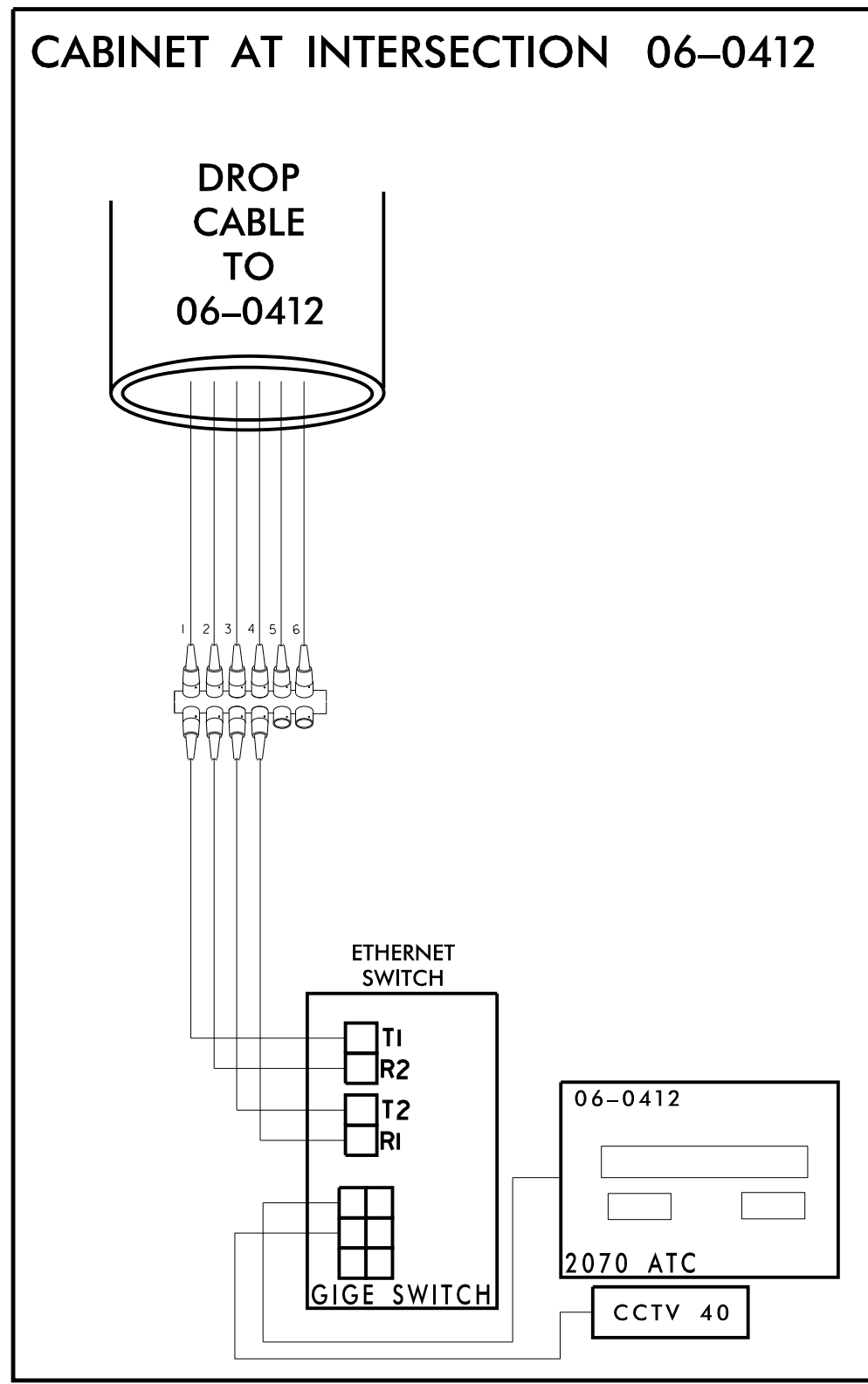
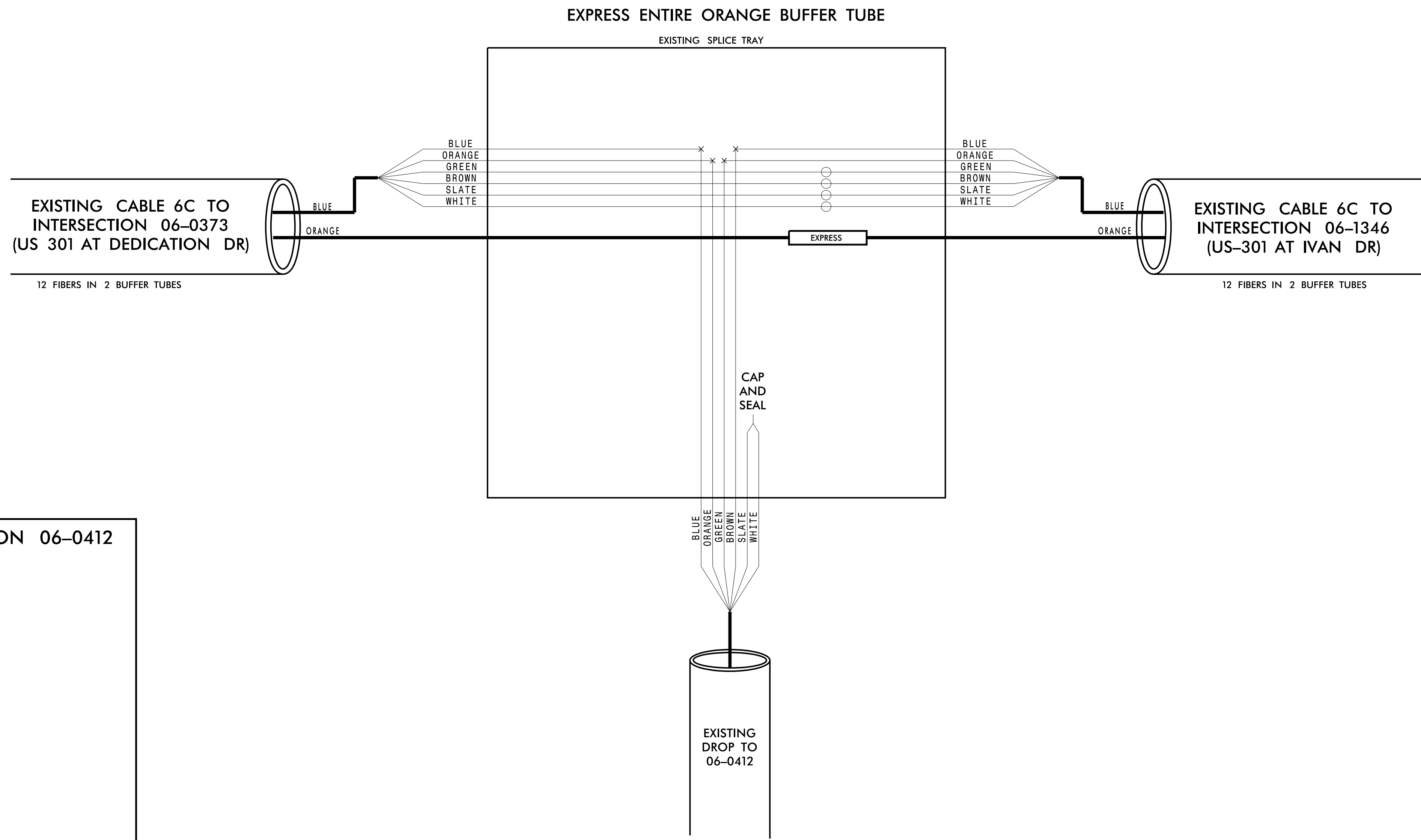

11/15/2016 K:\ARL\TPTD\ITS\01036305 - Fayetteville Sig Sys\Plans\Splicing\01036305-ITS\_psh-193-Ch6\_06-0412.dgn

**CHANNEL 6**

**FAYETTEVILLE COMPUTERIZED SIGNAL SYSTEM**  
**SPLICE DETAIL**

|                          |                               |                   |                          |
|--------------------------|-------------------------------|-------------------|--------------------------|
| DIVISION 06              |                               | CUMBERLAND COUNTY |                          |
| PLAN DATE: NOVEMBER 2016 | REVIEWED BY: N. M. MENGELKOCH | PREPARED BY: KHA  | REVIEWED BY: K. W. SMITH |
| REVISIONS                | INIT.                         | DATE              |                          |

Signature: *Kevin W. Smith*      Date: 11/15/2016  
 SEAL 030472  
 KEVIN W. SMITH  
 ENGINEER  
 STATE OF NORTH CAROLINA

CADD Filename:

**Kimley»Horn**  
 NC License #F-0102  
 421 Fayetteville St., Suite 600  
 Raleigh, NC 27636  
 Tel: (919) 677-2000  
 Fax: (919) 677-2050

**CHANNEL 8**  
**EXISTING SPLICE ENCLOSURE**  
**(EASTERN BLVD AT GROVE ST)**  
**SIG ID 06-0041**  
**CCTV 8**

**COLOR CODE**  
 TIA/EIA 598-C

|            |             |
|------------|-------------|
| (1) BLUE   | (7) RED     |
| (2) ORANGE | (8) BLACK   |
| (3) GREEN  | (9) YELLOW  |
| (4) BROWN  | (10) VIOLET |
| (5) SLATE  | (11) ROSE   |
| (6) WHITE  | (12) AQUA   |

**LEGEND**

X - FUSION SPLICE INDIVIDUAL FIBER  
 O - EXISTING SPLICE  
 □ - EXPRESS INDIVIDUAL FIBER

EXPRESS - EXPRESS ENTIRE BUFFER TUBE  
 SPLICE - SPLICE ENTIRE BUFFER TUBE OR MAINTAIN IF EXISTING EXPRESSED

**NOTES:**

- FIBER INTERCONNECT CENTER RACKS ARE SCHEMATIC ONLY - ACTUAL EQUIPMENT FORM MAY VARY.
- ETHERNET SWITCH TERMINATION CONFIGURATIONS ARE GENERIC. CONTRACTOR IS RESPONSIBLE FOR DETERMINING /ENSURING PROPER TERMINATION.
- CONTRACTOR IS RESPONSIBLE FOR FIELD VERIFYING EXISTING SPLICING. THE CONTRACTOR SHALL COORDINATE WITH THE ENGINEER WHERE EXISTING SPLICING IS NOT AS EXPECTED.

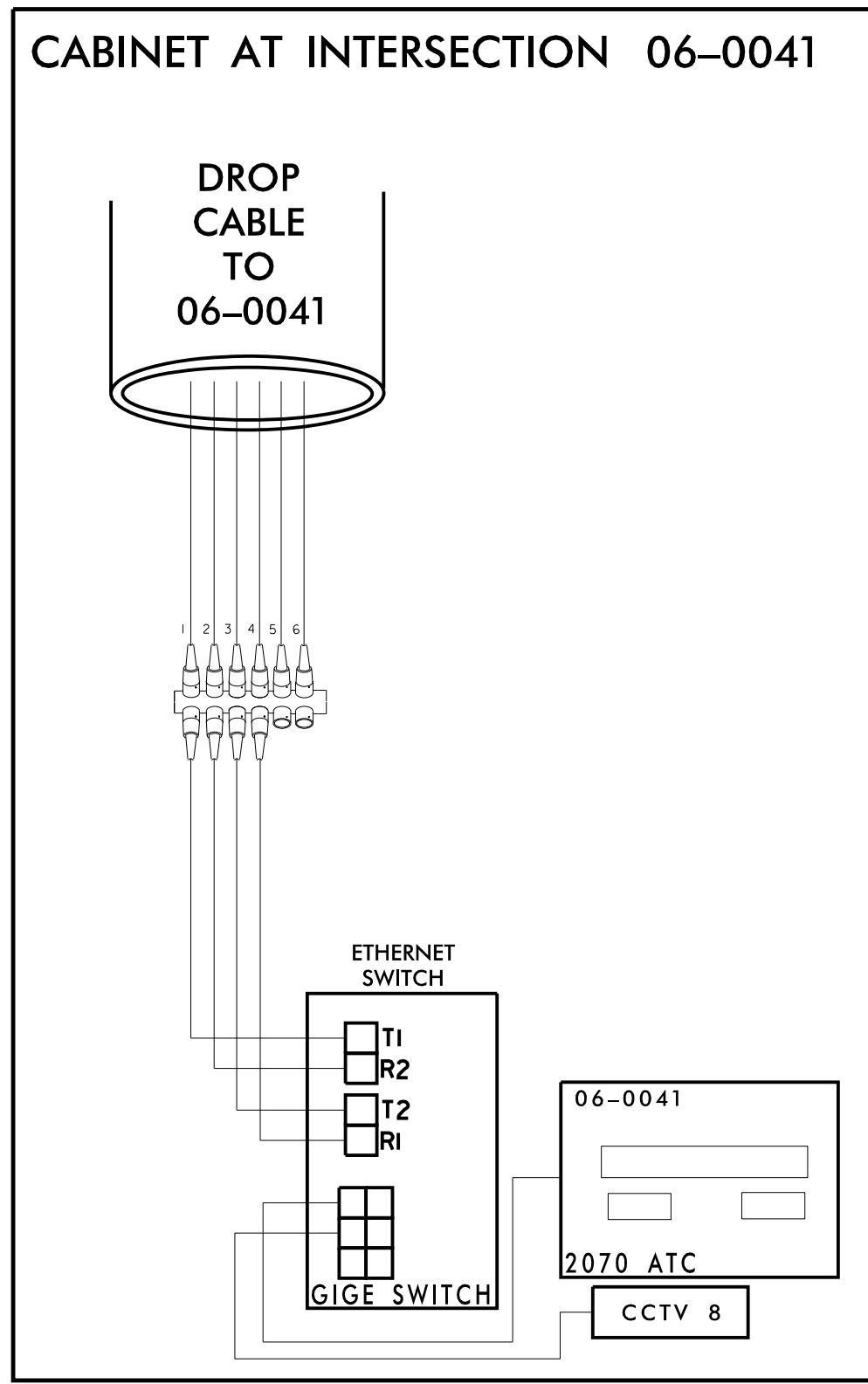
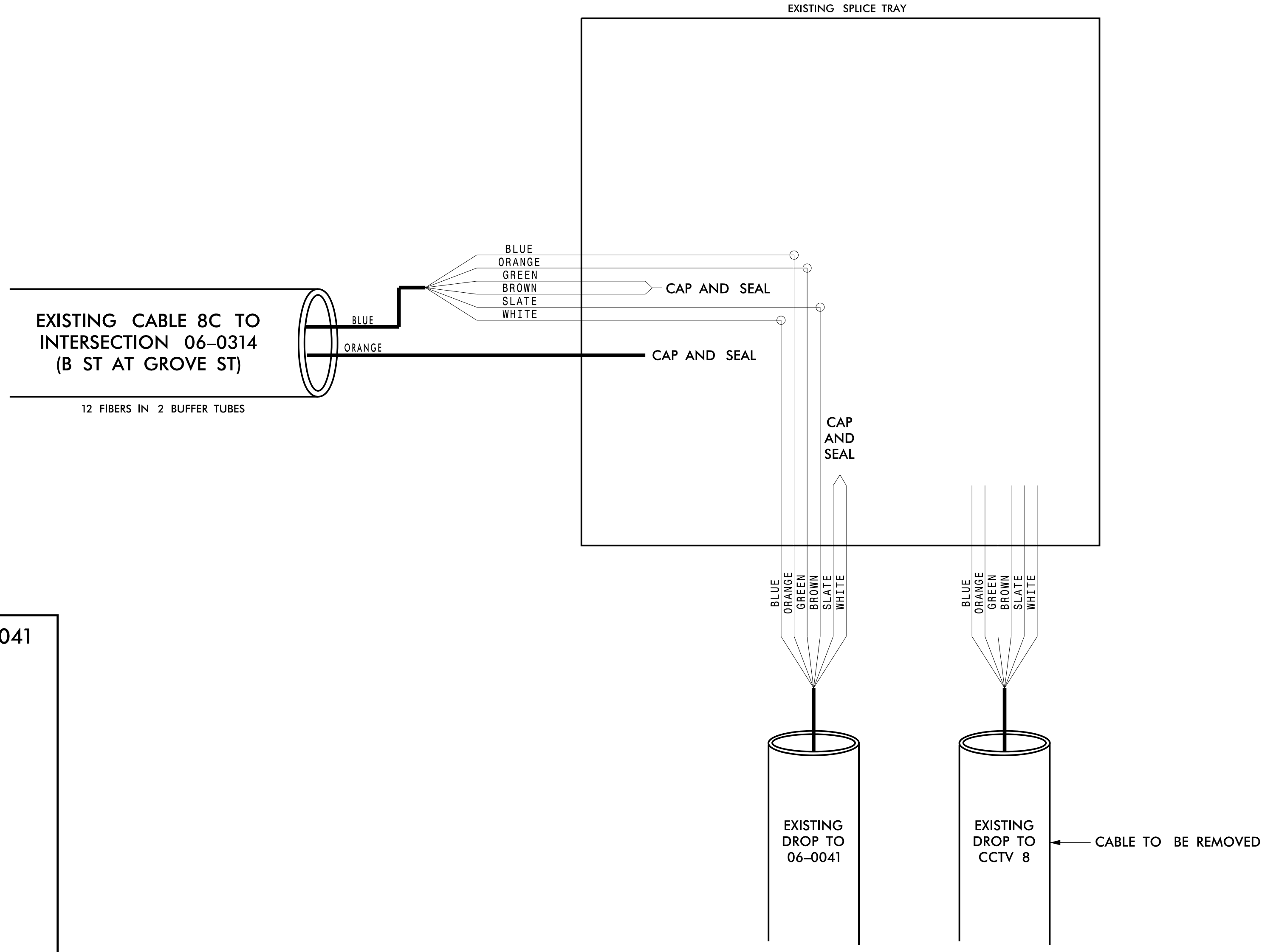

**CHANNEL 8**

**FAYETTEVILLE COMPUTERIZED SIGNAL SYSTEM**  
**SPLICE DETAIL**

DIVISION 06 CUMBERLAND COUNTY

PLAN DATE: NOVEMBER 2016 REVIEWED BY: N. M. MENGELKOCH

PREPARED BY: KHA REVIEWED BY: K. W. SMITH

250 N. Greenfield Place, Garner, NC 27529

SCALE: 0

Kimley»Horn  
 NC License #F-0102  
 421 Fayetteville St., Suite 600  
 Raleigh, NC 27636  
 Tel: (919) 677-2000  
 Fax: (919) 677-2050

SEAL  
 NORTH CAROLINA PROFESSIONAL ENGINEER  
 KEVIN W. SMITH  
 SEAL 030472  
 11/15/2016

11/15/2016 K:\ARL\TPTD\ITS\01036305 - Fayetteville Sig Sys\Plans\Splicing\01036305-ITS\_psh\_194-CH8\_Harvest CCTV8 06-0041.dgn

**CHANNEL 10  
EXISTING SPLICE ENCLOSURE  
(BRAGG BLVD /ROBESON ST  
AT HAY ST)  
SIG ID 06-0018  
CCTV 9**

**COLOR CODE**  
TIA/EIA 598-C

|            |             |
|------------|-------------|
| (1) BLUE   | (7) RED     |
| (2) ORANGE | (8) BLACK   |
| (3) GREEN  | (9) YELLOW  |
| (4) BROWN  | (10) VIOLET |
| (5) SLATE  | (11) ROSE   |
| (6) WHITE  | (12) AQUA   |

**LEGEND**

X - FUSION SPLICE INDIVIDUAL FIBER  
 O - EXISTING SPLICE  
 □ - EXPRESS INDIVIDUAL FIBER

EXPRESS - EXPRESS ENTIRE BUFFER TUBE  
 SPLICE - SPLICE ENTIRE BUFFER TUBE OR MAINTAIN IF EXISTING EXPRESSED

**NOTES:**  
 1. FIBER INTERCONNECT CENTER RACKS ARE SCHEMATIC ONLY - ACTUAL EQUIPMENT FORM MAY VARY.  
 2. ETHERNET SWITCH TERMINATION CONFIGURATIONS ARE GENERIC. CONTRACTOR IS RESPONSIBLE FOR DETERMINING /ENSURING PROPER TERMINATION.  
 3. CONTRACTOR IS RESPONSIBLE FOR FIELD VERIFYING EXISTING SPLICING. THE CONTRACTOR SHALL COORDINATE WITH THE ENGINEER WHERE EXISTING SPLICING IS NOT AS EXPECTED.

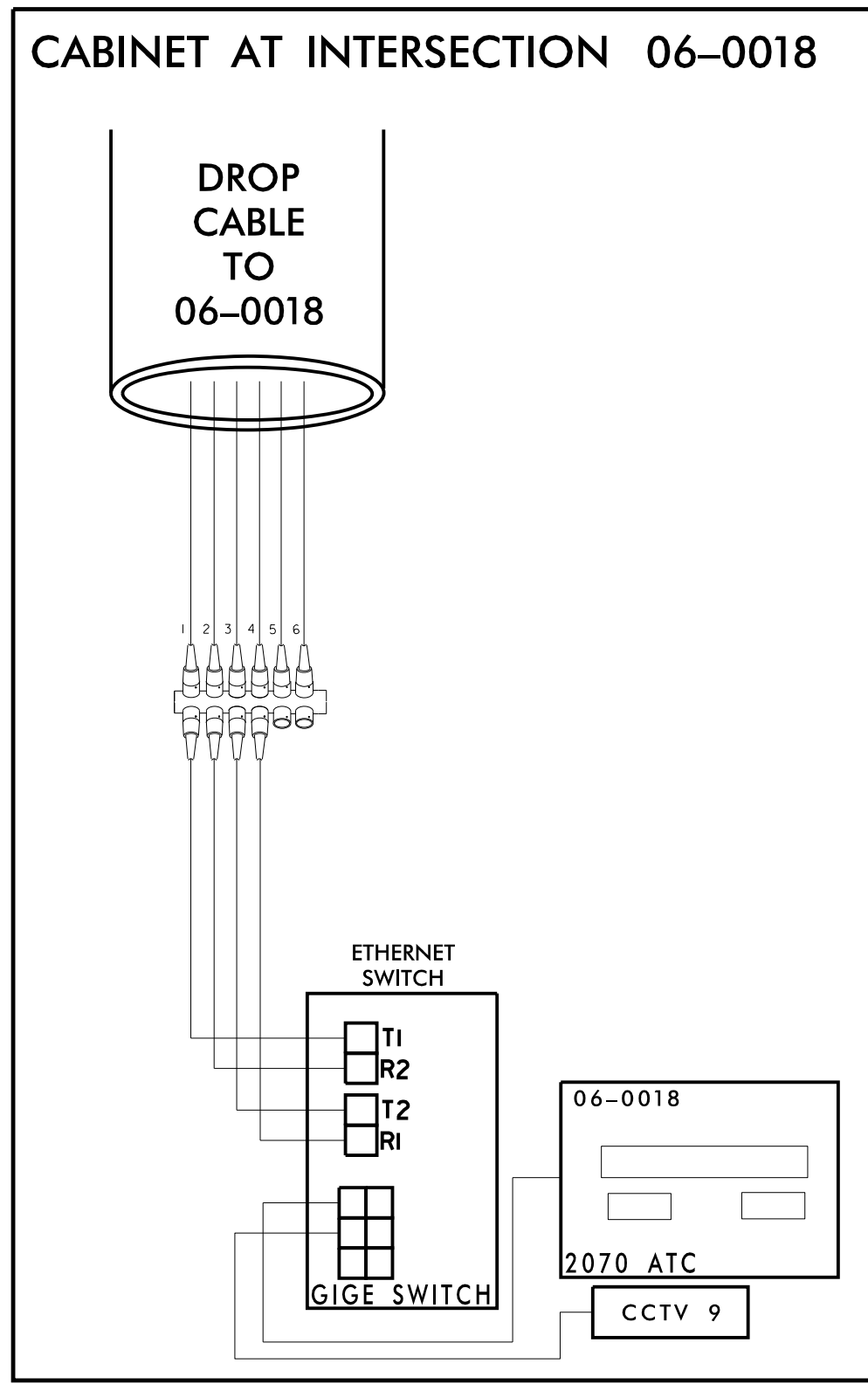
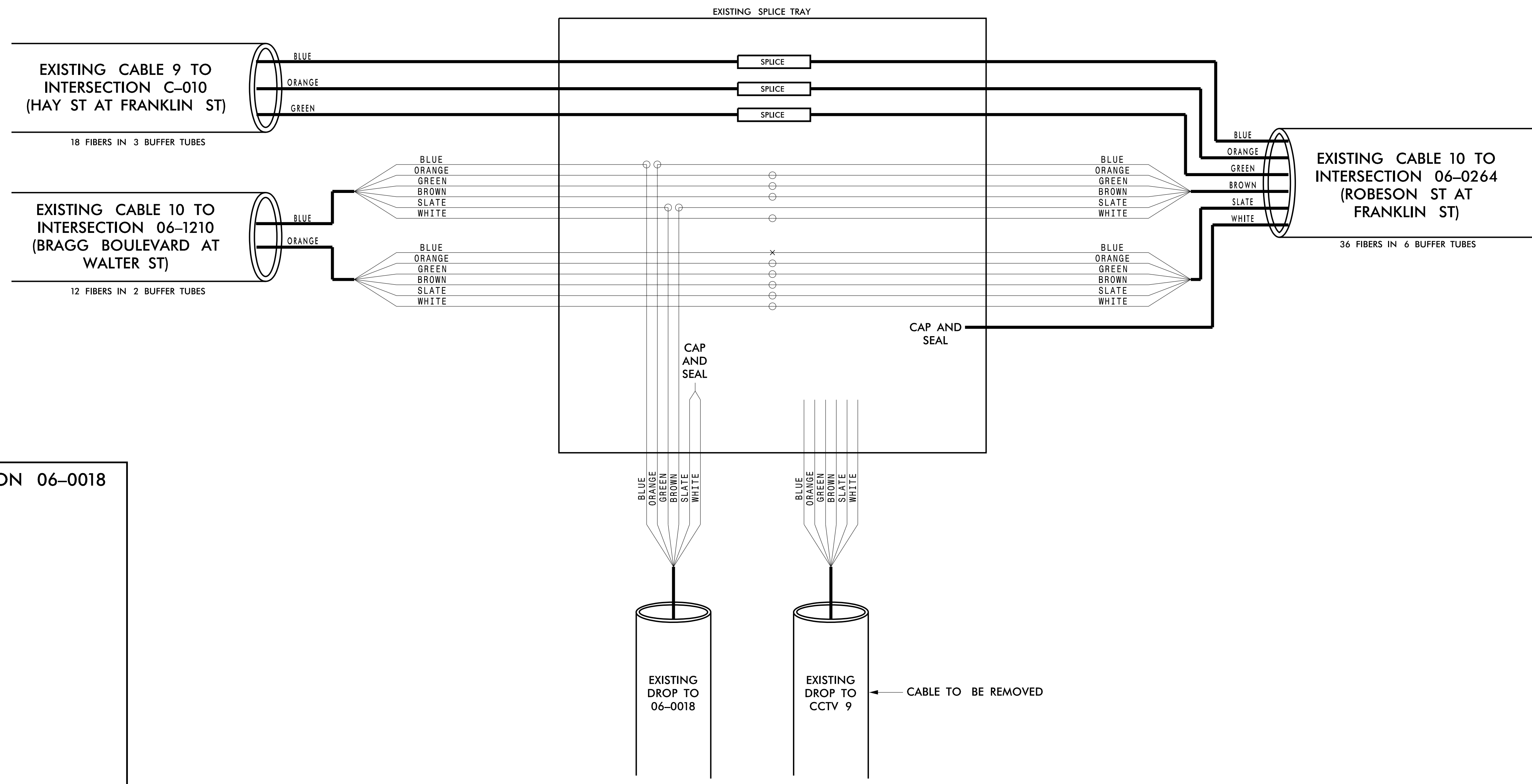

**CHANNEL 10  
FAYETTEVILLE COMPUTERIZED  
SIGNAL SYSTEM  
SPLICE DETAIL**

DIVISION 06 CUMBERLAND COUNTY  
 PLAN DATE: NOVEMBER 2016 REVIEWED BY: N. M. MENGELKOCH  
 PREPARED BY: KHA REVIEWED BY: K. W. SMITH

Kimley»Horn  
 NC License #F-0102  
 421 Fayetteville St., Suite 600  
 Raleigh, NC 27636  
 Tel: (919) 677-2000  
 Fax: (919) 677-2050

SCALE: 0

| REVISIONS | INIT. | DATE |
|-----------|-------|------|
|           |       |      |

SEAL: NORTH CAROLINA PROFESSIONAL ENGINEER KEVIN W. SMITH  
 SEAL 030472  
 Signature: Kevin Smith  
 DATE: 11/15/2016  
 CADD File name:  

11/15/2016 K:\ARL\_TPTD\_ITS\01036305 - Fayetteville Sig Sys\Plans\Splicing\01036305-ITS\_psh\_195-CH0\_Harvest CCTV9 06-0018.dgn

**CHANNEL 11  
EXISTING SPLICE ENCLOSURE  
(MARTIN LUTHER KING JR FWY W  
AT ROBESON ST)  
SIG ID 06-0544  
SIG ID 06-0545  
CCTV 44**

**COLOR CODE**  
TIA/EIA 598-C

|            |             |
|------------|-------------|
| (1) BLUE   | (7) RED     |
| (2) ORANGE | (8) BLACK   |
| (3) GREEN  | (9) YELLOW  |
| (4) BROWN  | (10) VIOLET |
| (5) SLATE  | (11) ROSE   |
| (6) WHITE  | (12) AQUA   |

**LEGEND**

X - FUSION SPLICE INDIVIDUAL FIBER  
O - EXISTING SPLICE  
□ - EXPRESS INDIVIDUAL FIBER

EXPRESS - EXPRESS ENTIRE BUFFER TUBE  
SPLICE - SPLICE ENTIRE BUFFER TUBE OR MAINTAIN IF EXISTING EXPRESSED

**NOTES:**  
1. FIBER INTERCONNECT CENTER RACKS ARE SCHEMATIC ONLY - ACTUAL EQUIPMENT FORM MAY VARY.  
2. ETHERNET SWITCH TERMINATION CONFIGURATIONS ARE GENERIC. CONTRACTOR IS RESPONSIBLE FOR DETERMINING /ENSURING PROPER TERMINATION.  
3. CONTRACTOR IS RESPONSIBLE FOR FIELD VERIFYING EXISTING SPLICING. THE CONTRACTOR SHALL COORDINATE WITH THE ENGINEER WHERE EXISTING SPLICING IS NOT AS EXPECTED.

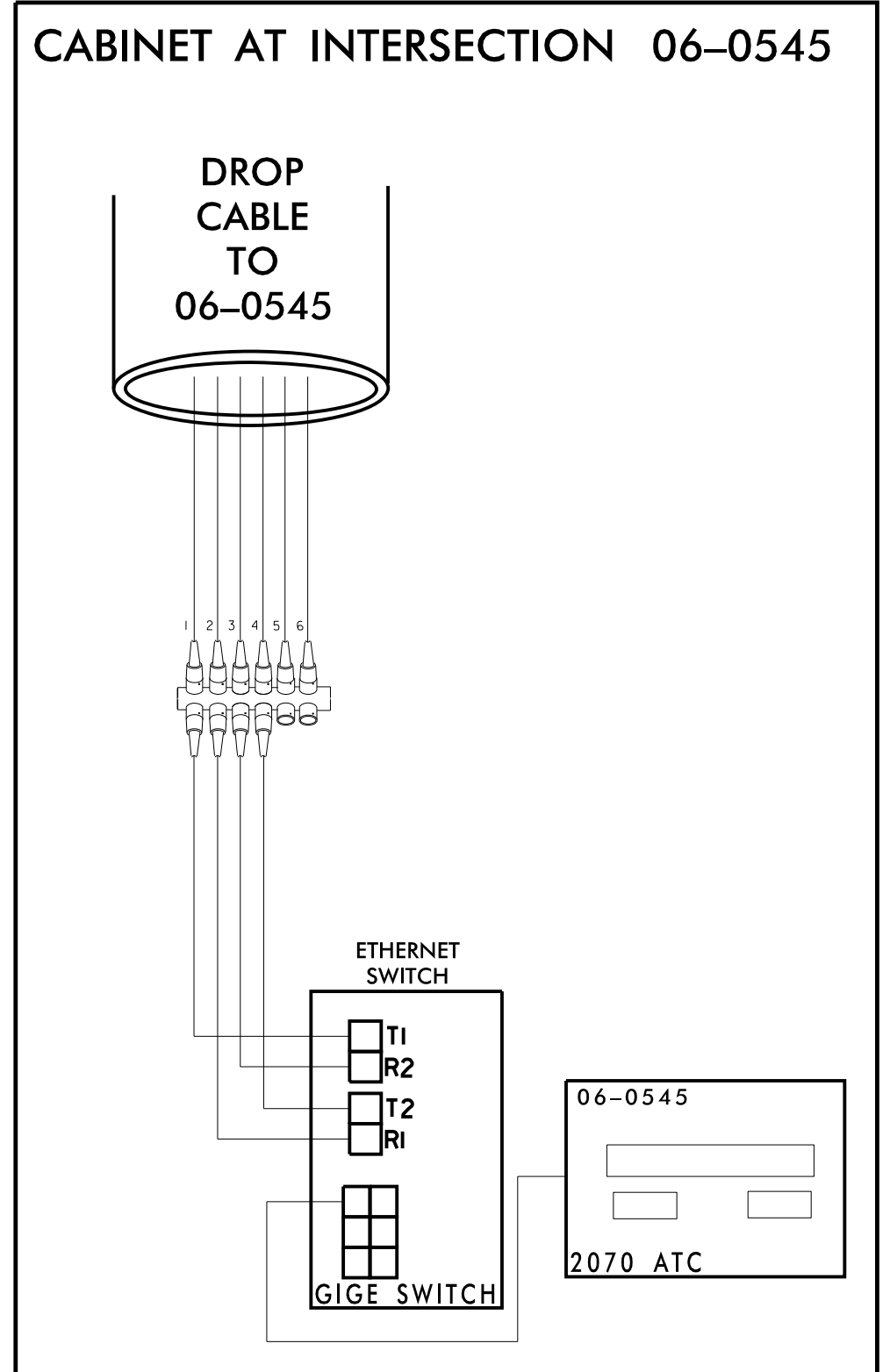
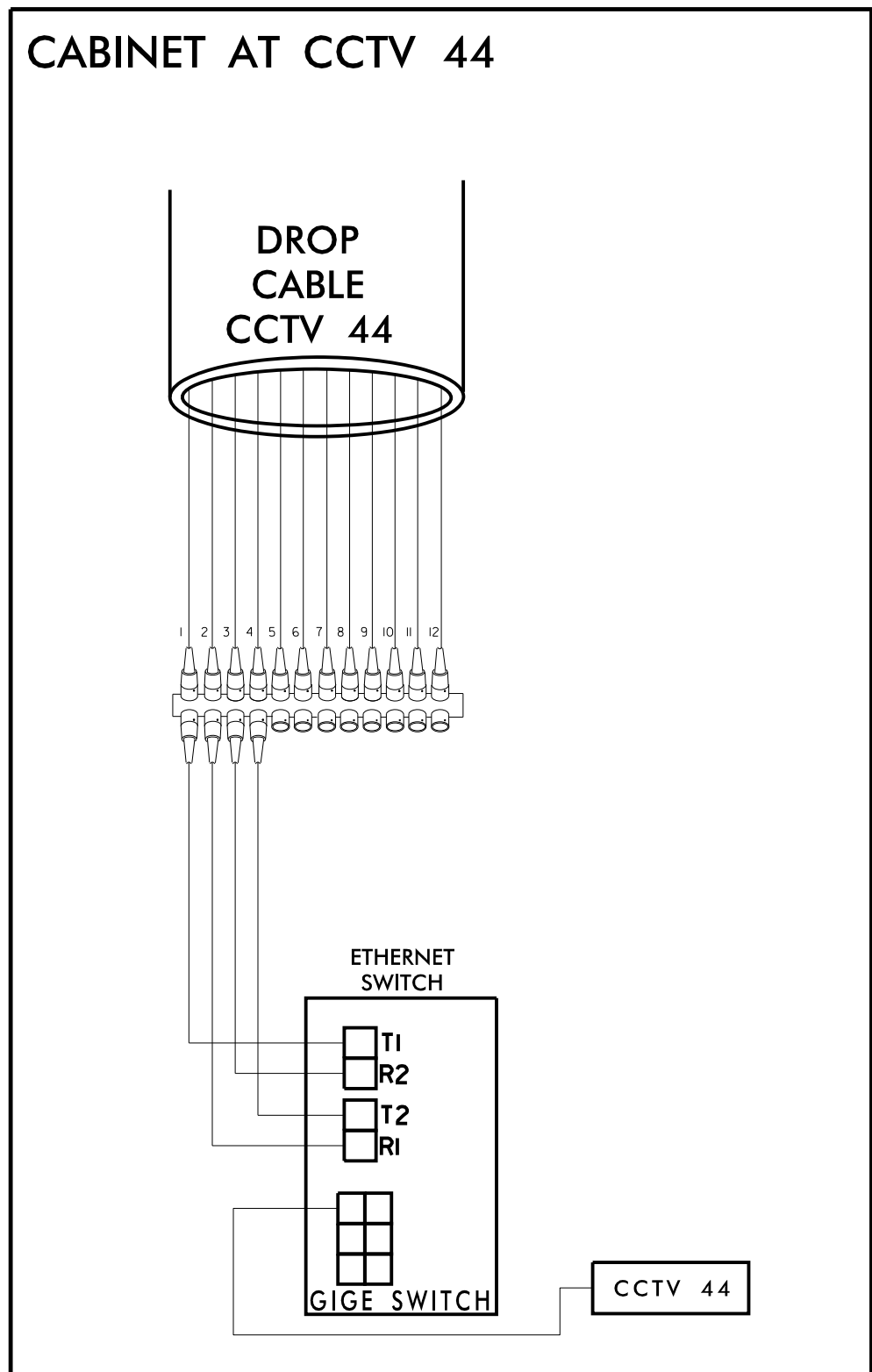
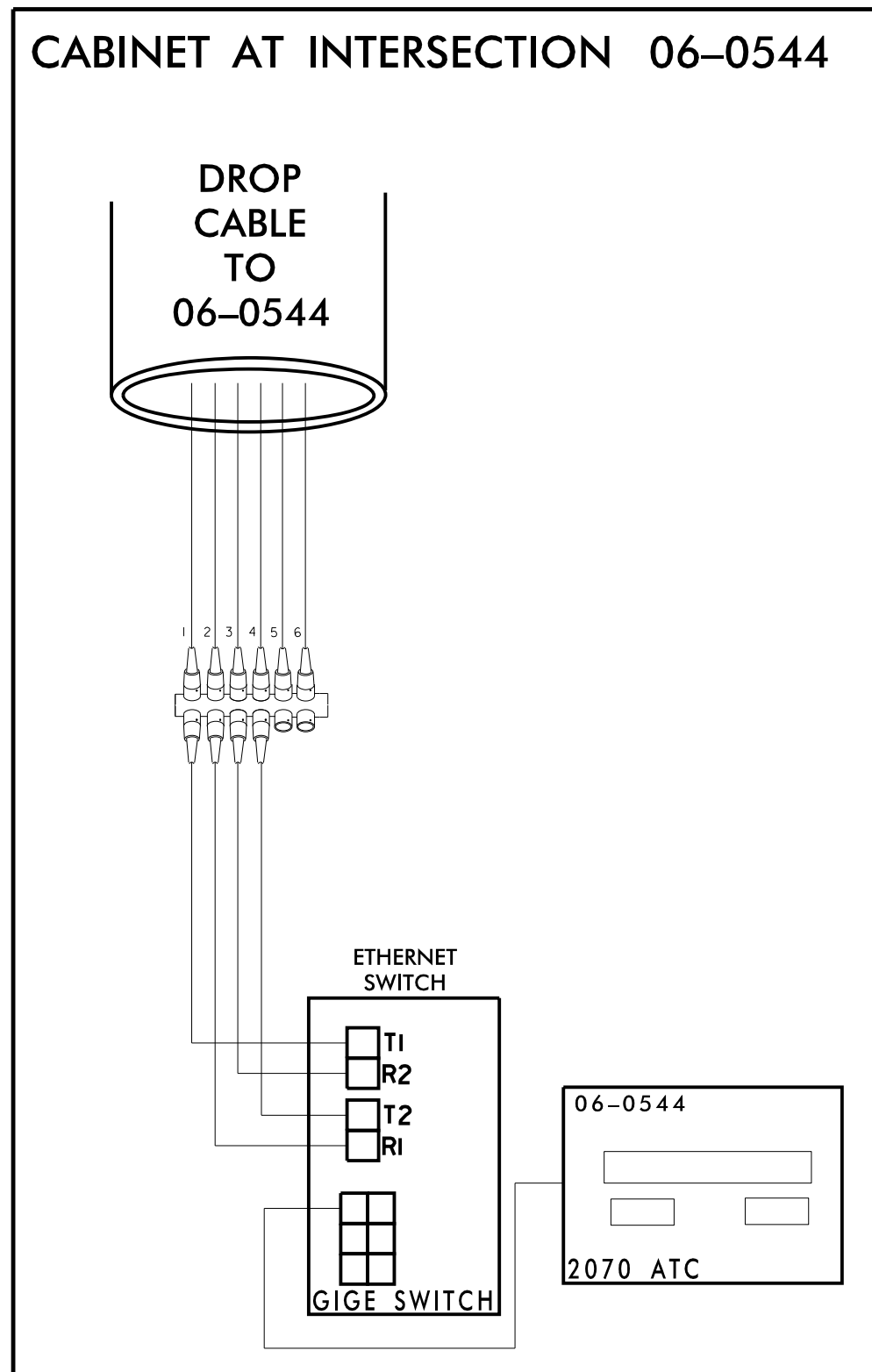
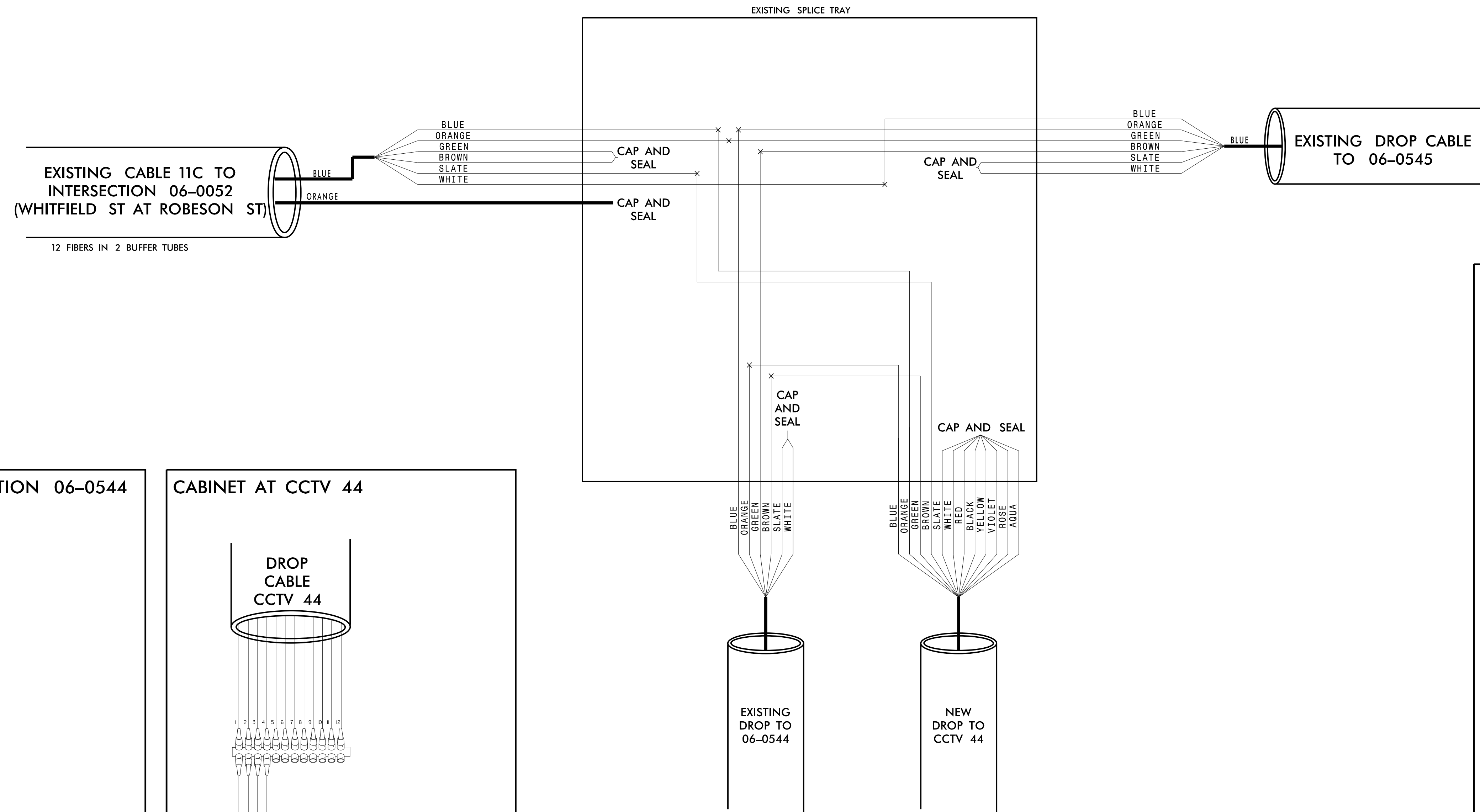

11/15/2016 K:\ARL\TPTD\ITS\01036305 - Fayetteville Sig Sys\Plans\Splicing\01036305-ITS\_psh\_196-CHI06-0544 CCTV44.dgn

**Kimley»Horn**  
NC License #F-0102  
421 Fayetteville St., Suite 600  
Raleigh, NC 27636  
Tel: (919) 677-2000  
Fax: (919) 677-2050

**CHANNEL 11**

**FAYETTEVILLE COMPUTERIZED SIGNAL SYSTEM**  
**SPLICE DETAIL**

DIVISION 06 CUMBERLAND COUNTY  
PLAN DATE: NOVEMBER 2016 REVIEWED BY: N. M. MENGELKOPF  
PREPARED BY: KHA REVIEWED BY: K. W. SMITH

SCALE: 0

SEAL: NORTH CAROLINA PROFESSIONAL ENGINEER KEVIN W. SMITH SEAL 030472  
DATE: 11/15/2016  
SIGNATURE: Kevin W. Smith  
CADD Filename:



**CHANNEL 11  
EXISTING SPLICE ENCLOSURE  
(OWEN DR AT VILLAGE DR)  
SIG ID 06-0058  
CCTV 7**

**COLOR CODE**  
TIA/EIA 598-C

|            |             |
|------------|-------------|
| (1) BLUE   | (7) RED     |
| (2) ORANGE | (8) BLACK   |
| (3) GREEN  | (9) YELLOW  |
| (4) BROWN  | (10) VIOLET |
| (5) SLATE  | (11) ROSE   |
| (6) WHITE  | (12) AQUA   |

**LEGEND**

- X - FUSION SPLICE INDIVIDUAL FIBER
- O - EXISTING SPLICE
- - EXPRESS INDIVIDUAL FIBER

**EXPRESS** EXPRESS ENTIRE BUFFER TUBE  
**SPLICE** SPLICE ENTIRE BUFFER TUBE OR MAINTAIN IF EXISTING EXPRESSED

**NOTES:**

- FIBER INTERCONNECT CENTER RACKS ARE SCHEMATIC ONLY - ACTUAL EQUIPMENT FORM MAY VARY.
- ETHERNET SWITCH TERMINATION CONFIGURATIONS ARE GENERIC. CONTRACTOR IS RESPONSIBLE FOR DETERMINING /ENSURING PROPER TERMINATION.
- CONTRACTOR IS RESPONSIBLE FOR FIELD VERIFYING EXISTING SPlicing. THE CONTRACTOR SHALL COORDINATE WITH THE ENGINEER WHERE EXISTING SPlicing IS NOT AS EXPECTED.

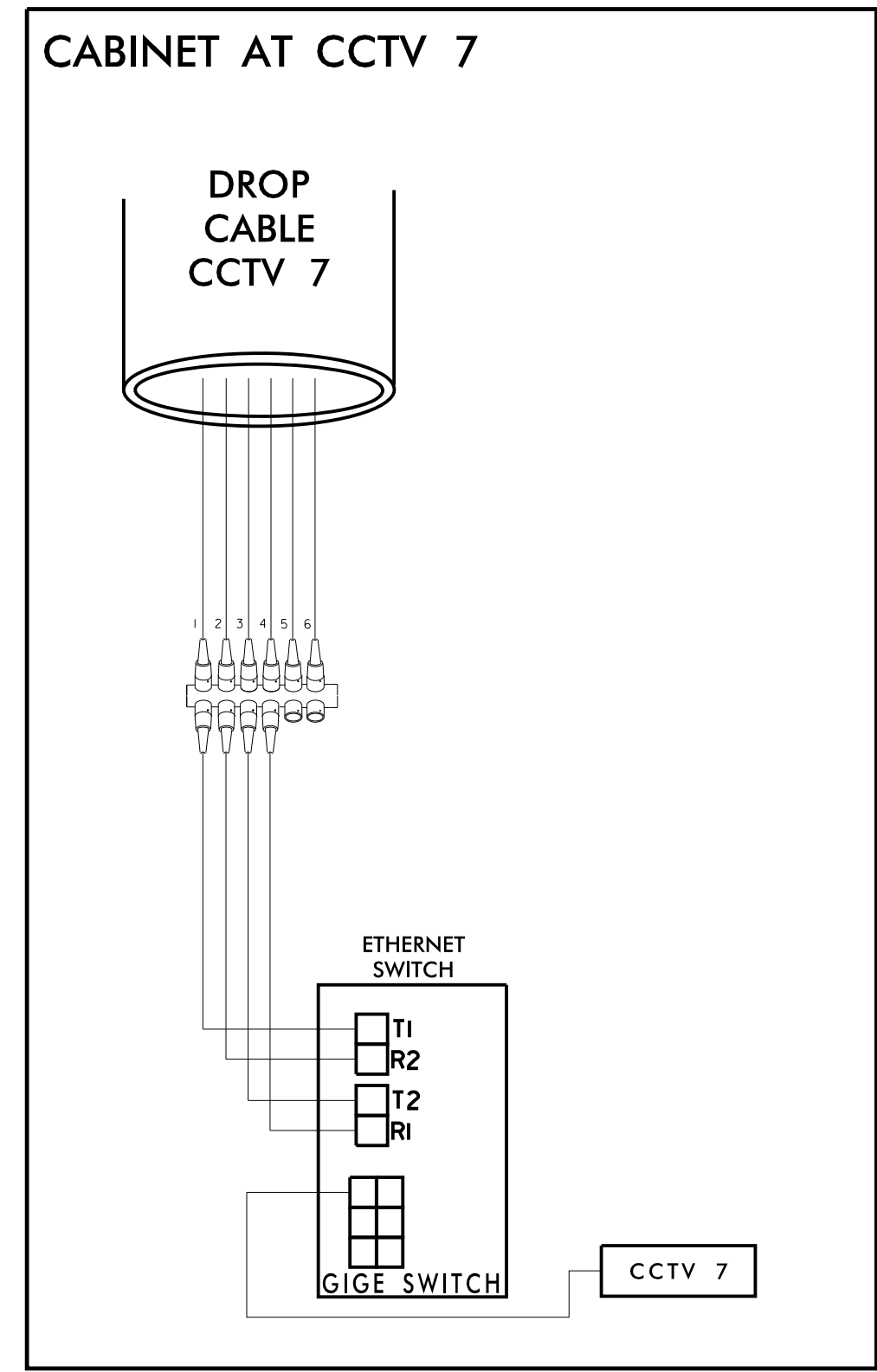
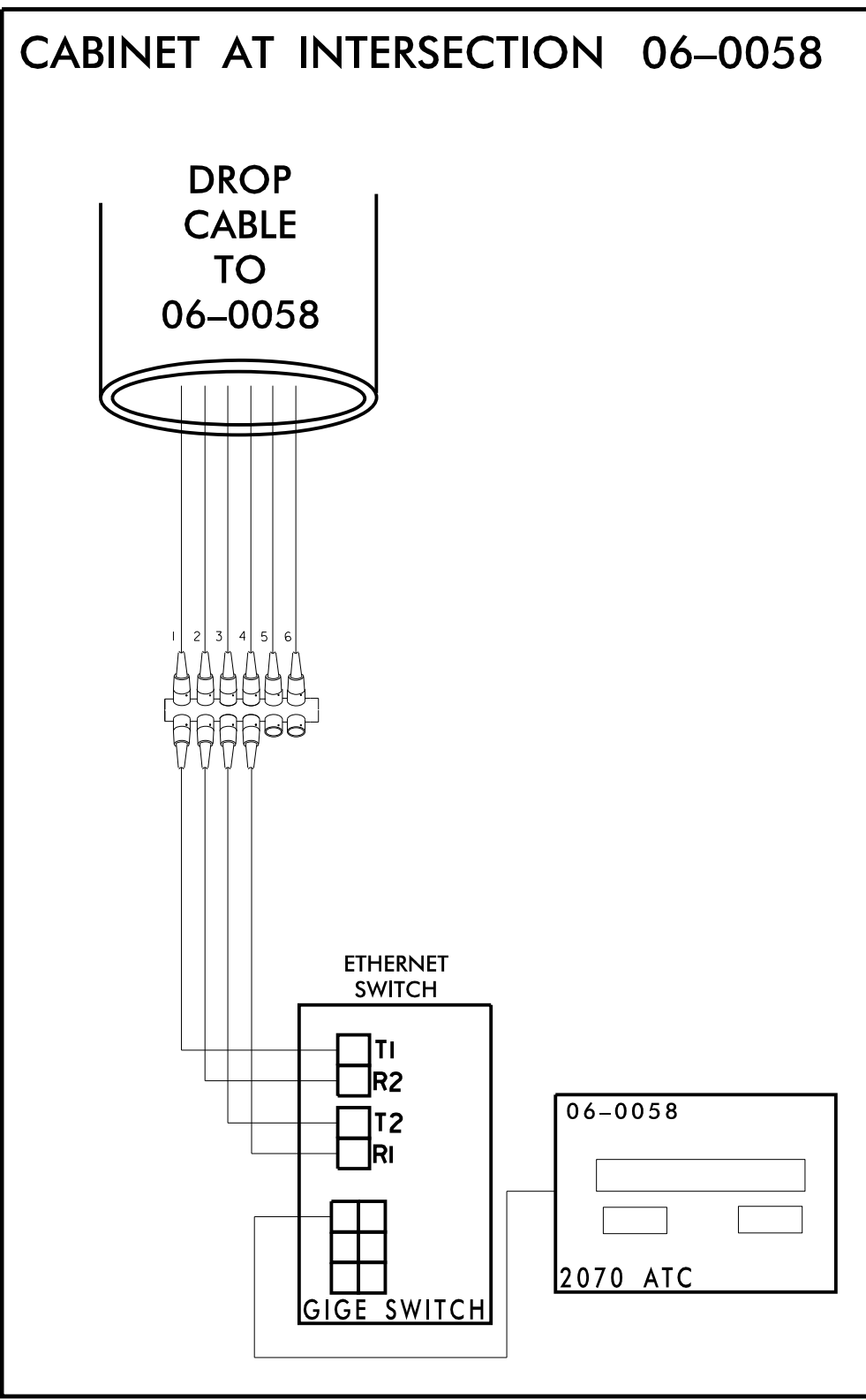
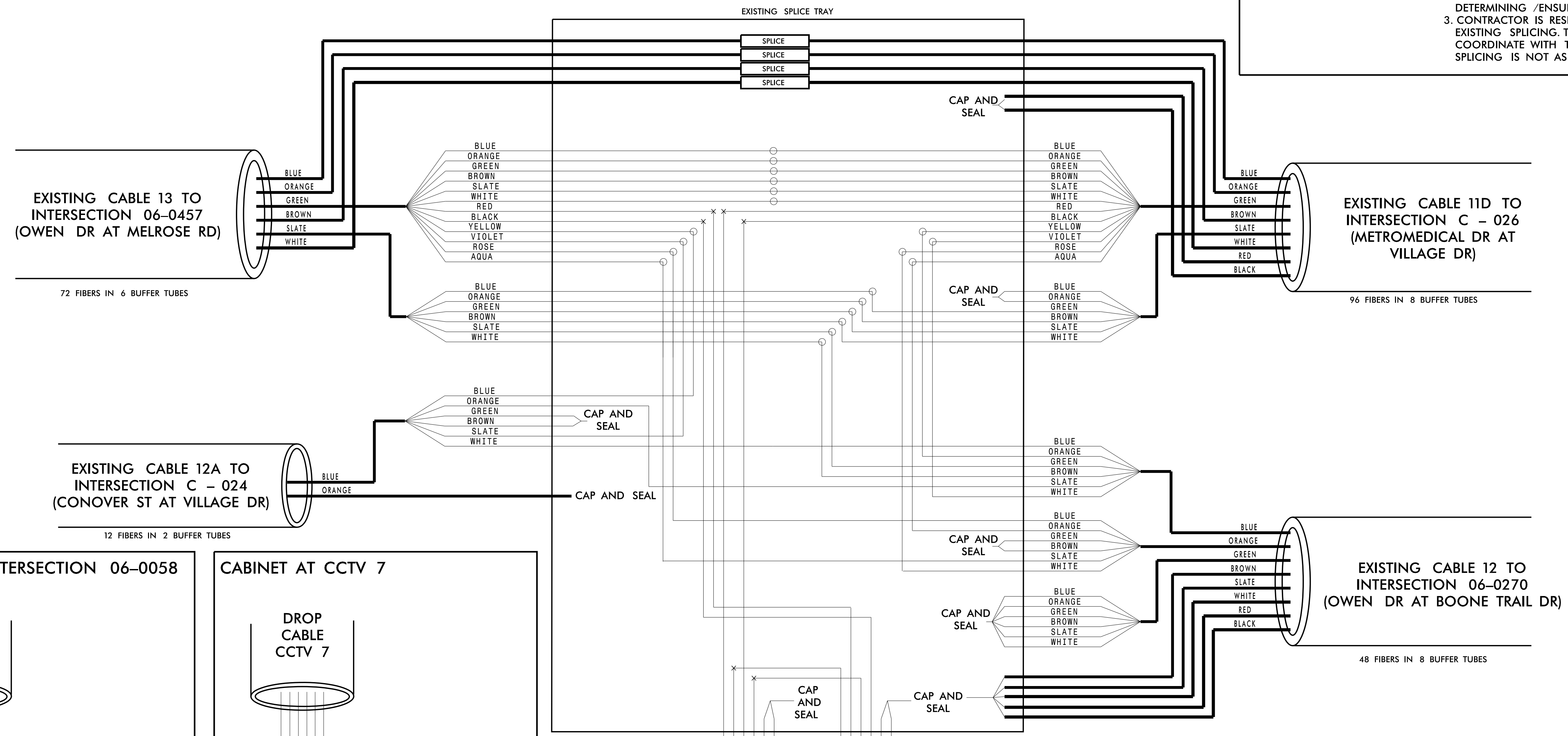

**CHANNEL 11  
FAYETTEVILLE COMPUTERIZED  
SIGNAL SYSTEM  
SPLICE DETAIL**

DIVISION 06 CUMBERLAND COUNTY

PLAN DATE: NOVEMBER 2016 REVIEWED BY: N.M. MENGELKOCH

PREPARED BY: KHA REVIEWED BY: K.W. SMITH

SCALE: 0

**Kimley»Horn**  
NC License #F-0102  
421 Fayetteville St., Suite 600  
Raleigh, NC 27636  
Tel: (919) 677-2000  
Fax: (919) 677-2050

SEAL  
NORTH CAROLINA PROFESSIONAL ENGINEER  
SEAL 030472  
KEVIN W. SMITH  
11/15/2016

11/15/2016 K:\ARL\TPTD\ITS\01036305 - Fayetteville Sig Sys\Plans\Splicing\01036305-ITS\_psh\_197-ChilHarvest CCTV7\_06-0058.dgn

**CHANNEL 12  
NEW SPLICE ENCLOSURE  
(OWEN DR WEST OF  
CAMDEN RD)  
CCTV 42**

**COLOR CODE**  
TIA/EIA 598-C

|            |             |
|------------|-------------|
| (1) BLUE   | (7) RED     |
| (2) ORANGE | (8) BLACK   |
| (3) GREEN  | (9) YELLOW  |
| (4) BROWN  | (10) VIOLET |
| (5) SLATE  | (11) ROSE   |
| (6) WHITE  | (12) AQUA   |

**LEGEND**

- X - FUSION SPLICE INDIVIDUAL FIBER
- O - EXISTING SPLICE
- - EXPRESS INDIVIDUAL FIBER

EXPRESS: EXPRESS ENTIRE BUFFER TUBE  
SPLICE: SPLICE ENTIRE BUFFER TUBE OR MAINTAIN IF EXISTING EXPRESSED

**NOTES:**

- FIBER INTERCONNECT CENTER RACKS ARE SCHEMATIC ONLY - ACTUAL EQUIPMENT FORM MAY VARY.
- ETHERNET SWITCH TERMINATION CONFIGURATIONS ARE GENERIC. CONTRACTOR IS RESPONSIBLE FOR DETERMINING /ENSURING PROPER TERMINATION.
- CONTRACTOR IS RESPONSIBLE FOR FIELD VERIFYING EXISTING SPLICING. THE CONTRACTOR SHALL COORDINATE WITH THE ENGINEER WHERE EXISTING SPLICING IS NOT AS EXPECTED.

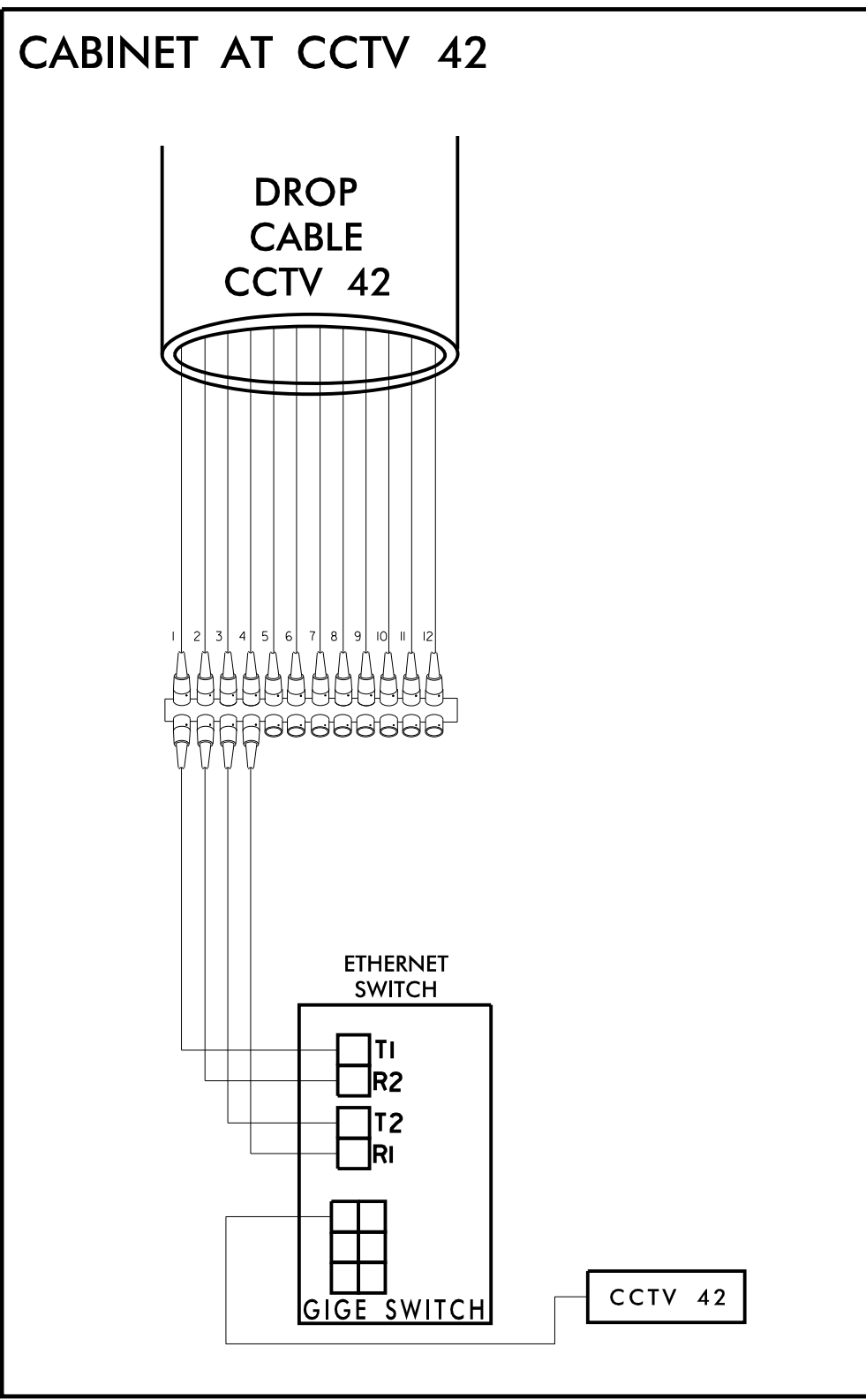
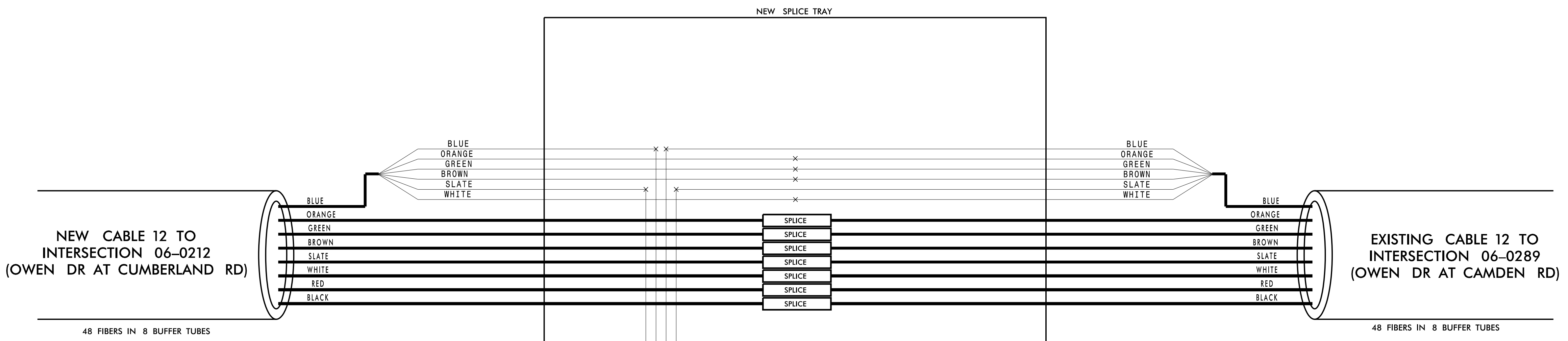

**CHANNEL 12  
FAYETTEVILLE COMPUTERIZED  
SIGNAL SYSTEM  
SPLICE DETAIL**

Division 06 CUMBERLAND COUNTY

PLAN DATE: NOVEMBER 2016 REVIEWED BY: N. M. MENGELKOCH

PREPARED BY: KHA REVIEWED BY: K. W. SMITH

| REVISIONS | INIT. | DATE |
|-----------|-------|------|
|           |       |      |

SCALE: 0

Kimley Horn  
NC License #F-0102  
421 Fayetteville St., Suite 600  
Raleigh, NC 27636  
Tel: (919) 677-2000  
Fax: (919) 677-2050

Seal: KEVIN W. SMITH, NORTH CAROLINA PROFESSIONAL ENGINEER, SEAL 030472, 11/15/2016

11/15/2016 K:\ARL\TPTD\ITS\01036305 - Fayetteville Sig Sys\Plans\Splicing\01036305-ITS\_psh\_198-CH2 CCTV42.dgn

**CHANNEL 12  
EXISTING SPLICE ENCLOSURE  
(NATAL ST AT CUMBERLAND RD)  
SIG ID 06-0456**

**COLOR CODE**  
TIA/EIA 598-C

|            |             |
|------------|-------------|
| (1) BLUE   | (7) RED     |
| (2) ORANGE | (8) BLACK   |
| (3) GREEN  | (9) YELLOW  |
| (4) BROWN  | (10) VIOLET |
| (5) SLATE  | (11) ROSE   |
| (6) WHITE  | (12) AQUA   |

**LEGEND**

- X - FUSION SPLICE INDIVIDUAL FIBER
- - EXISTING SPLICE
- - EXPRESS INDIVIDUAL FIBER

EXPRESS: EXPRESS ENTIRE BUFFER TUBE  
SPLICE: SPLICE ENTIRE BUFFER TUBE OR MAINTAIN IF EXISTING EXPRESSED

**NOTES:**

- FIBER INTERCONNECT CENTER RACKS ARE SCHEMATIC ONLY - ACTUAL EQUIPMENT FORM MAY VARY.
- ETHERNET SWITCH TERMINATION CONFIGURATIONS ARE GENERIC. CONTRACTOR IS RESPONSIBLE FOR DETERMINING /ENSURING PROPER TERMINATION.
- CONTRACTOR IS RESPONSIBLE FOR FIELD VERIFYING EXISTING SPLICING. THE CONTRACTOR SHALL COORDINATE WITH THE ENGINEER WHERE EXISTING SPLICING IS NOT AS EXPECTED.

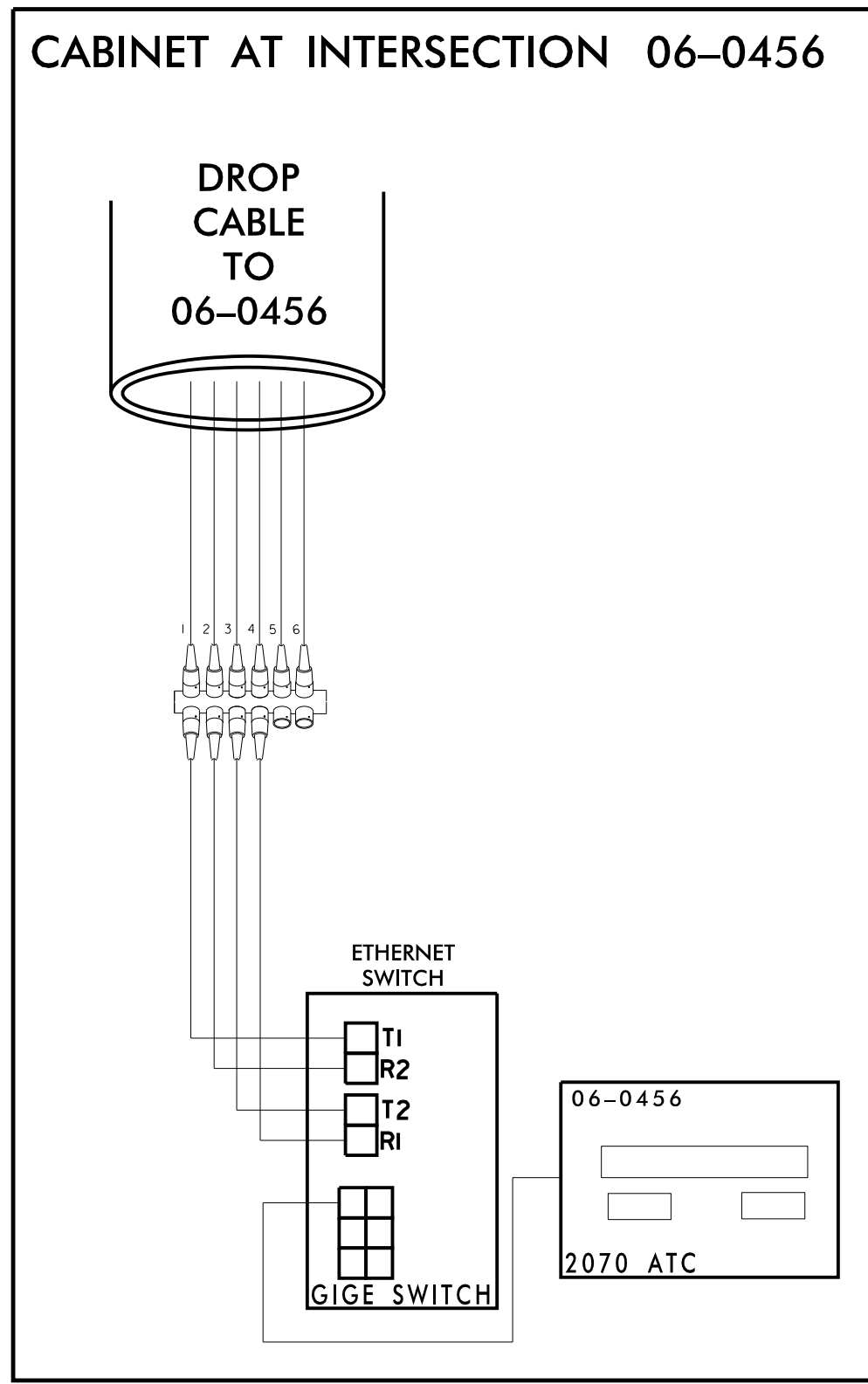
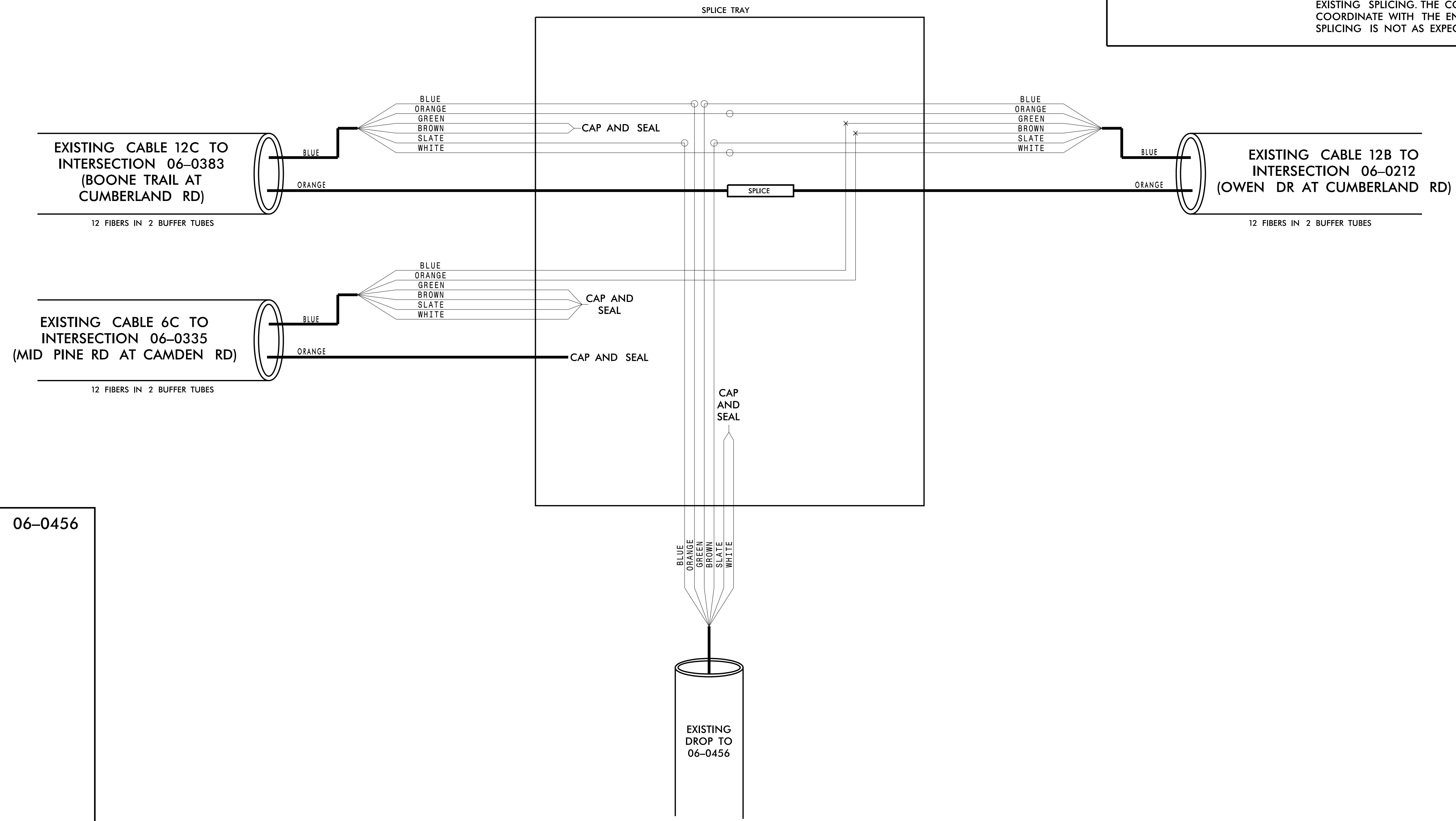

**CHANNEL 12  
FAYETTEVILLE COMPUTERIZED  
SIGNAL SYSTEM  
SPLICE DETAIL**

DIVISION 06 CUMBERLAND COUNTY

PLAN DATE: NOVEMBER 2016 REVIEWED BY: N. M. MENGELKOCH

PREPARED BY: KHA REVIEWED BY: K. W. SMITH

| REVISIONS | INIT. | DATE |
|-----------|-------|------|
|           |       |      |

SCALE: 0

Kimley»Horn  
NC License #F-0102  
421 Fayetteville St., Suite 600  
Raleigh, NC 27636  
Tel: (919) 677-2000  
Fax: (919) 677-2050

SEAL  
NORTH CAROLINA PROFESSIONAL ENGINEER  
SEAL 030472  
KEVIN W. SMITH  
11/15/2016  
SIGNATURE DATE  
CADD Filename:

11/15/2016 K:\ARL\TPTD\ITS\01036305 - Fayetteville Sig Sys\Plans\Splicing\01036305-ITS\_psh\_199-CH2\_06-0456.dgn

**CHANNEL 12 EXTENSION  
EXISTING SPLICE ENCLOSURE  
(BOONE TRAIL AT CUMBERLAND RD)  
SIG ID 06-0383**

**COLOR CODE**  
TIA/EIA 598-C

|            |             |
|------------|-------------|
| (1) BLUE   | (7) RED     |
| (2) ORANGE | (8) BLACK   |
| (3) GREEN  | (9) YELLOW  |
| (4) BROWN  | (10) VIOLET |
| (5) SLATE  | (11) ROSE   |
| (6) WHITE  | (12) AQUA   |

**LEGEND**

- X - FUSION SPLICE INDIVIDUAL FIBER
- O - EXISTING SPLICE
- - EXPRESS INDIVIDUAL FIBER
- EXPRESS - EXPRESS ENTIRE BUFFER TUBE
- SPLICE - SPLICE ENTIRE BUFFER TUBE OR MAINTAIN IF EXISTING EXPRESSED

**NOTES:**

- FIBER INTERCONNECT CENTER RACKS ARE SCHEMATIC ONLY - ACTUAL EQUIPMENT FORM MAY VARY.
- ETHERNET SWITCH TERMINATION CONFIGURATIONS ARE GENERIC. CONTRACTOR IS RESPONSIBLE FOR DETERMINING /ENSURING PROPER TERMINATION.
- CONTRACTOR IS RESPONSIBLE FOR FIELD VERIFYING EXISTING SPLICING. THE CONTRACTOR SHALL COORDINATE WITH THE ENGINEER WHERE EXISTING SPLICING IS NOT AS EXPECTED.

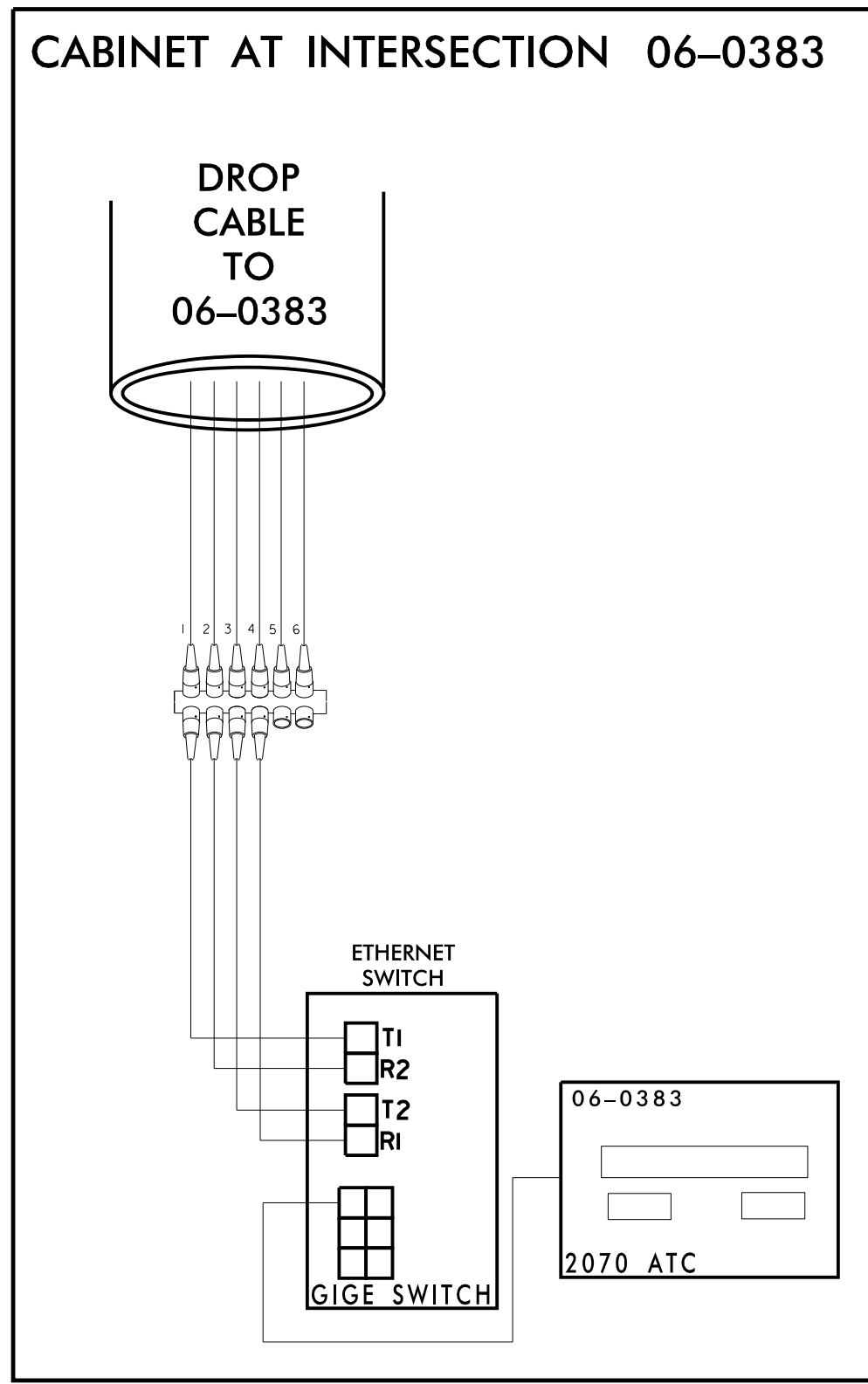
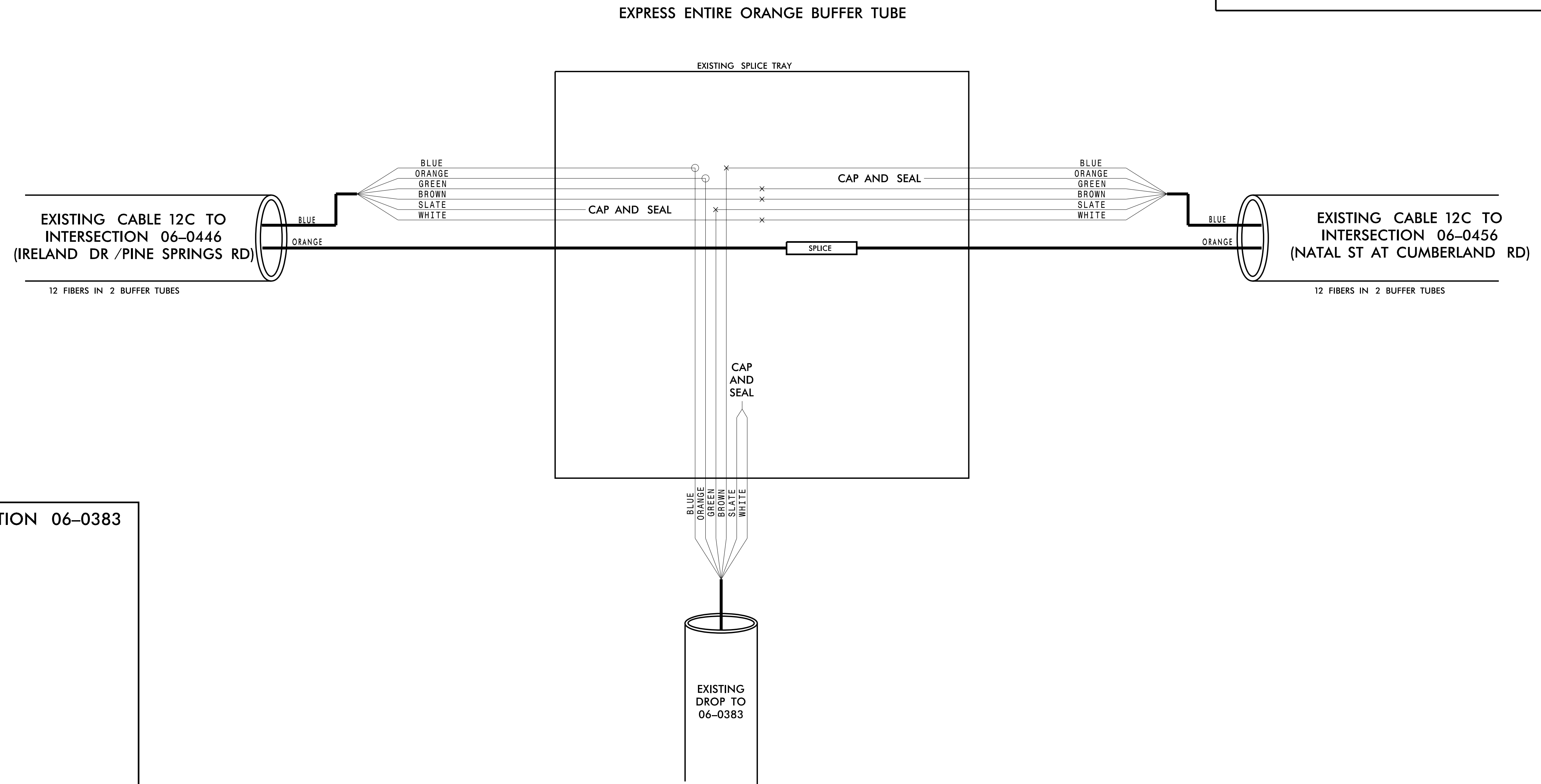

**CHANNEL 12 EXTENSION**

**FAYETTEVILLE COMPUTERIZED SIGNAL SYSTEM  
SPLICE DETAIL**

DIVISION 06 CUMBERLAND COUNTY

PLAN DATE: NOVEMBER 2016 REVIEWED BY: N. M. MENGELKOCH

PREPARED BY: KHA REVIEWED BY: K. W. SMITH

SCALE: 0

REVISIONS: INIT. DATE

Signature: Kevin W. Smith, 11/15/2016

Seal: NORTH CAROLINA PROFESSIONAL ENGINEER SEAL 030472 KEVIN W. SMITH

**Kimley»Horn**  
 NC License #F-0102  
 421 Fayetteville St., Suite 600  
 Raleigh, NC 27636  
 Tel: (919) 677-2000  
 Fax: (919) 677-2050

11/15/2016 K:\ARL\TPTD\_ITS\01036305 - Fayetteville Sig Sys\Plans\Splicing\01036305-ITS\_psh-200-CH2\_06-0383.dgn

**CHANNEL 13**  
**EXISTING SPLICE ENCLOSURE**  
**(ALL AMERICAN EXPRESSWAY E**  
**AT RAEFORD RD)**  
**SIG ID 06-0323**  
**CCTV 6**

**COLOR CODE**  
 TIA/EIA 598-C

|            |             |
|------------|-------------|
| (1) BLUE   | (7) RED     |
| (2) ORANGE | (8) BLACK   |
| (3) GREEN  | (9) YELLOW  |
| (4) BROWN  | (10) VIOLET |
| (5) SLATE  | (11) ROSE   |
| (6) WHITE  | (12) AQUA   |

**LEGEND**

- X - FUSION SPLICE INDIVIDUAL FIBER
- - EXISTING SPLICE
- - EXPRESS INDIVIDUAL FIBER

EXPRESS: EXPRESS ENTIRE BUFFER TUBE  
 SPLICE: SPLICE ENTIRE BUFFER TUBE OR MAINTAIN IF EXISTING EXPRESSED

**NOTES:**

- FIBER INTERCONNECT CENTER RACKS ARE SCHEMATIC ONLY - ACTUAL EQUIPMENT FORM MAY VARY.
- ETHERNET SWITCH TERMINATION CONFIGURATIONS ARE GENERIC. CONTRACTOR IS RESPONSIBLE FOR DETERMINING /ENSURING PROPER TERMINATION.
- CONTRACTOR IS RESPONSIBLE FOR FIELD VERIFYING EXISTING SPLICING. THE CONTRACTOR SHALL COORDINATE WITH THE ENGINEER WHERE EXISTING SPLICING IS NOT AS EXPECTED.

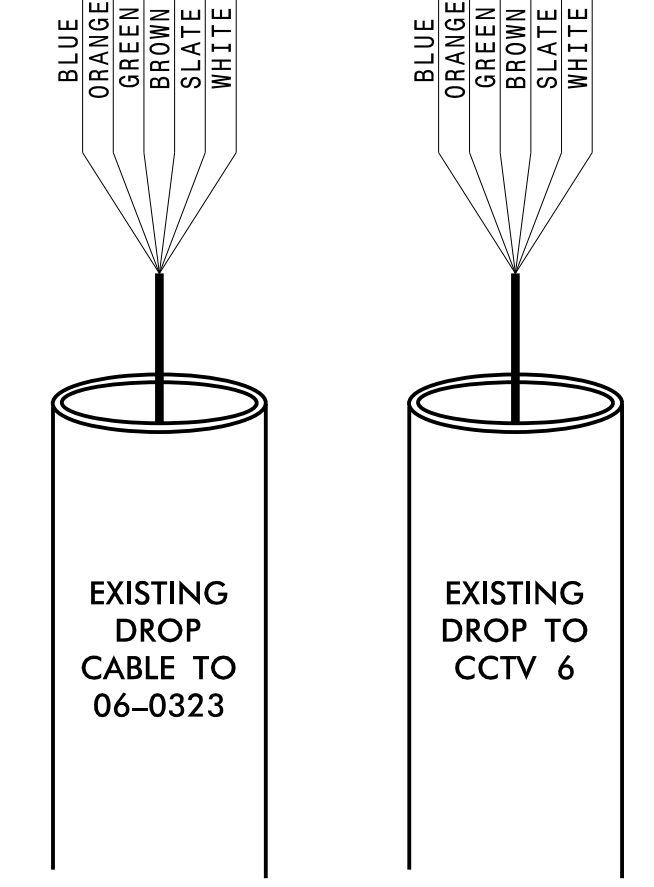
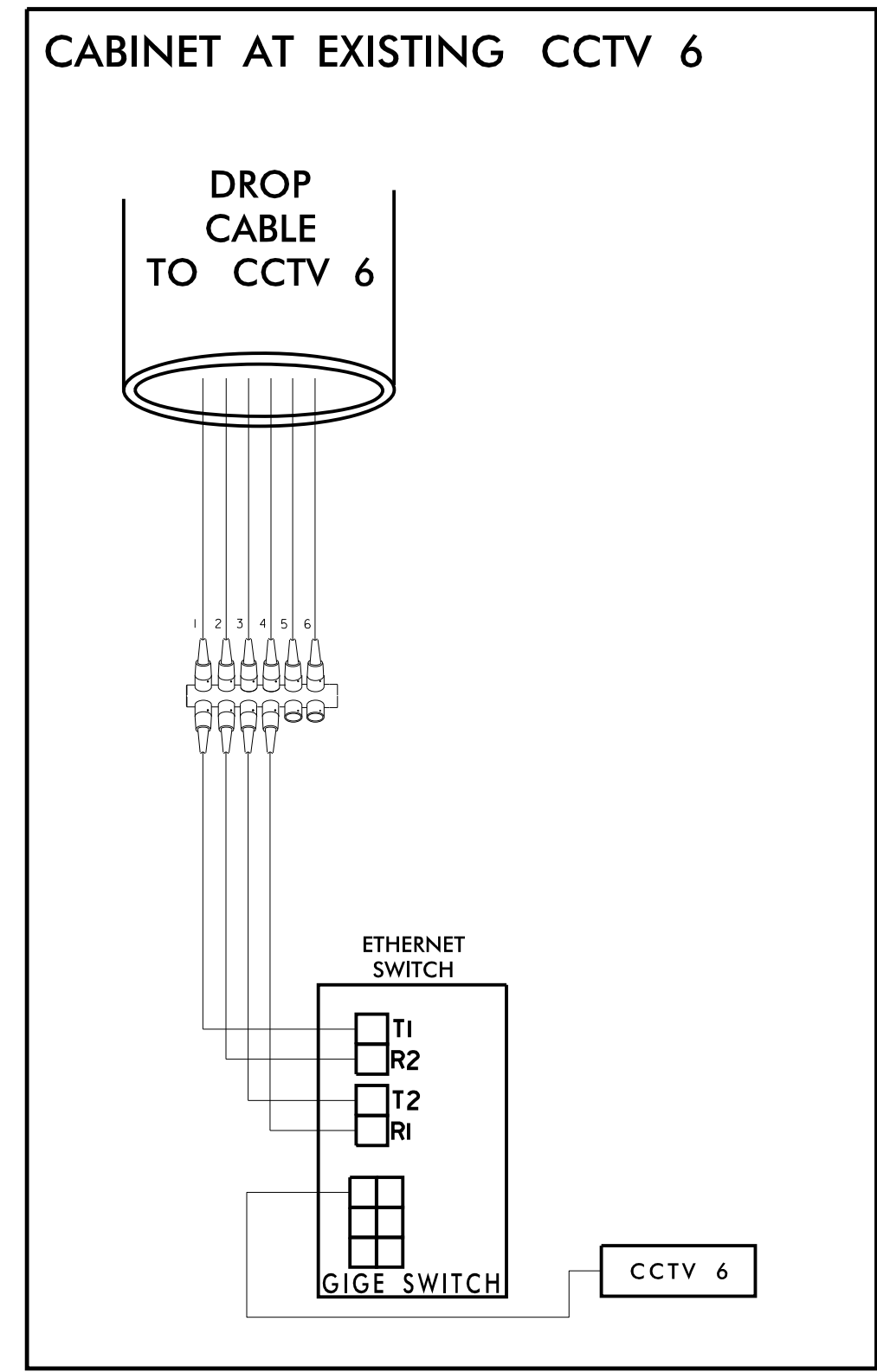
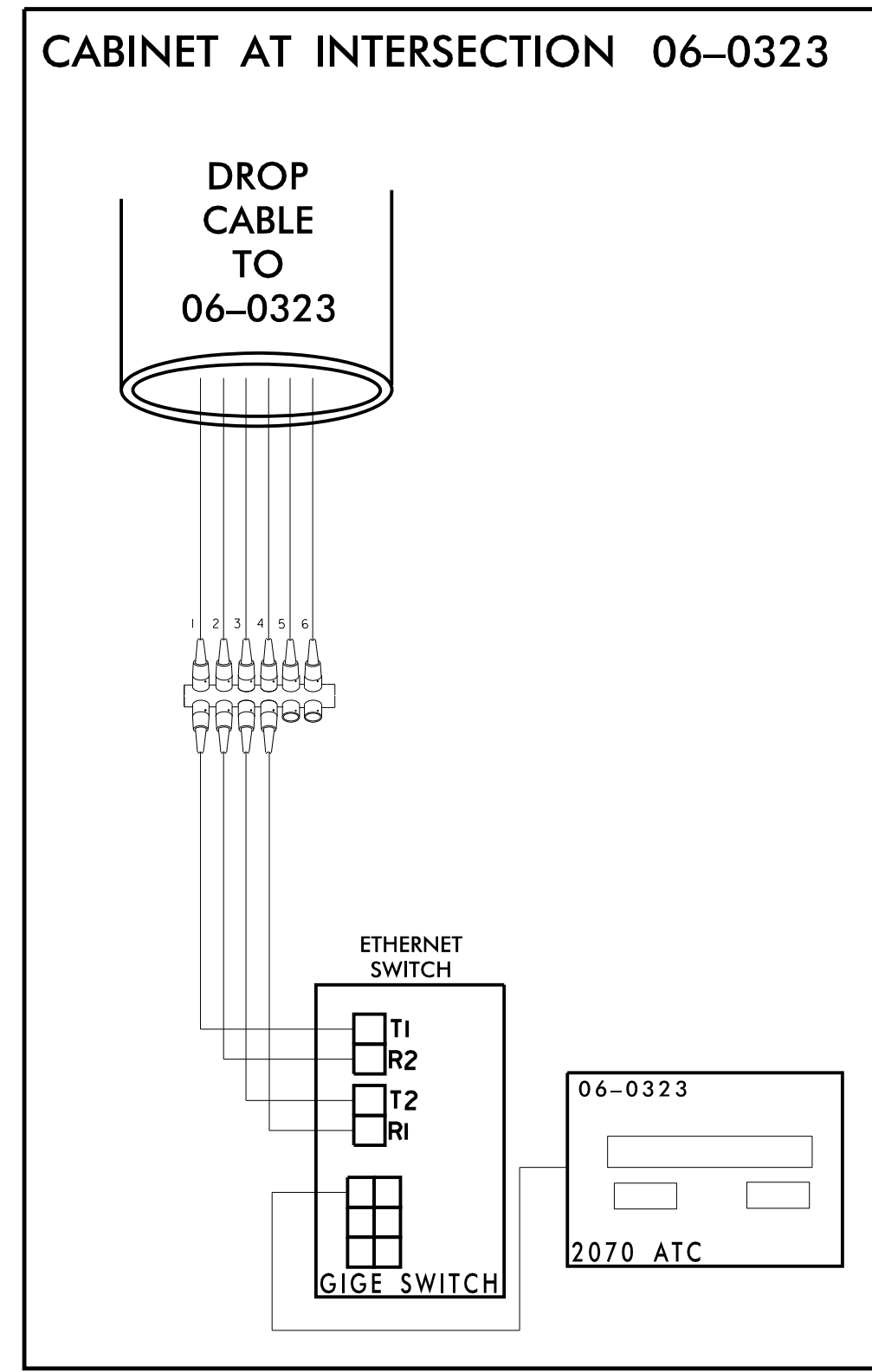
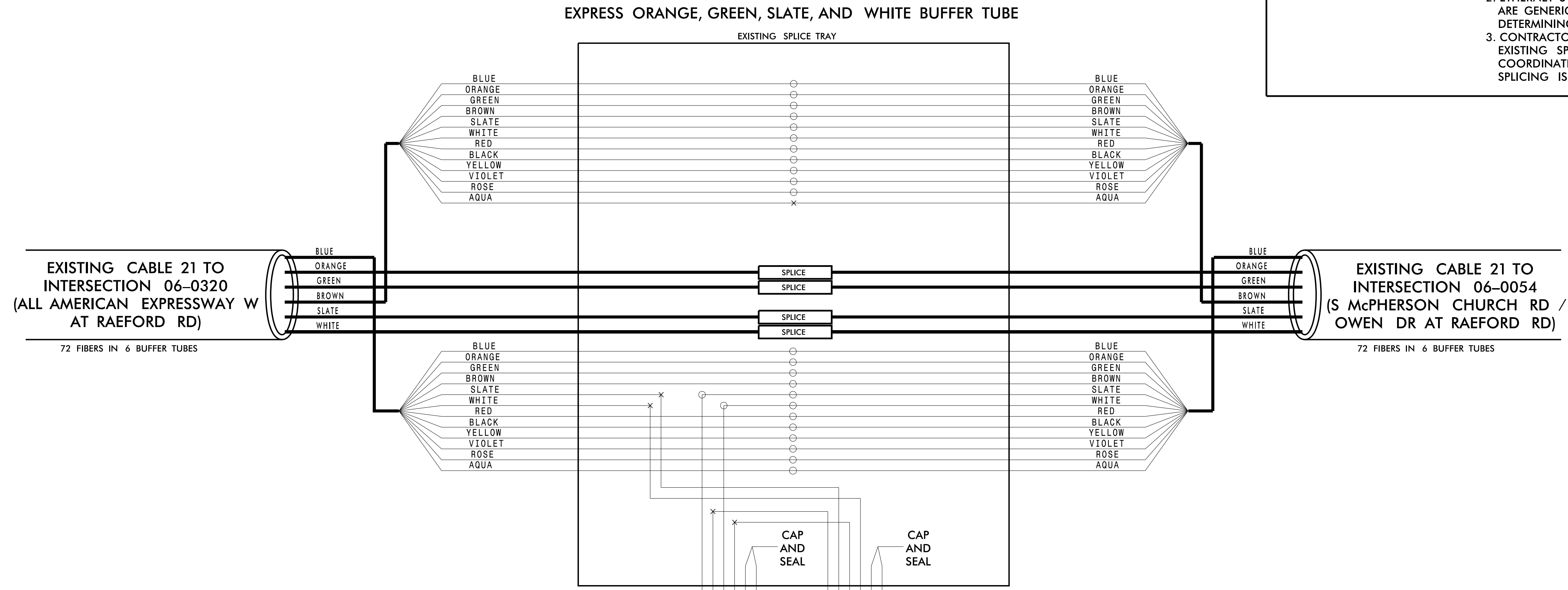

**CHANNEL 13**

**FAYETTEVILLE COMPUTERIZED SIGNAL SYSTEM**

**SPLICE DETAIL**

|                               |       |   |                |
|-------------------------------|-------|---|----------------|
|                               |       | <b>SEAL</b><br>                                       |                |
| DIVISION 06 CUMBERLAND COUNTY |       | PLAN DATE: NOVEMBER 2016 REVIEWED BY: N.M. MENGELKOCH |                |
| PREPARED BY: KHA              |       | REVIEWED BY: K.W. SMITH                               |                |
| REVISIONS                     | INIT. | DATE  | SIGNATURE      |
|                               |       |   | Kevin W. Smith |
|                               |       |   | 11/15/2016     |
| SCALE: 0                      |       | CADD File name:                                       |                |

**Kimley»Horn**  
 NC License #F-0102  
 421 Fayetteville St., Suite 600  
 Raleigh, NC 27636  
 Tel: (919) 677-2000  
 Fax: (919) 677-2050

11/15/2016 K:\ARL\TPTD\ITS\01036305 - Fayetteville Sig Sys\Plans\Splicing\01036305-ITS\_psh\_20-CH25 CCTV6 Hor-veet 06-0320.dgn

**CHANNEL 16  
EXISTING SPLICE ENCLOSURE  
(RAMSEY ST AT CUMBERLAND ST)  
SIG ID 06-0223**

**COLOR CODE**  
TIA/EIA 598-C

|            |             |
|------------|-------------|
| (1) BLUE   | (7) RED     |
| (2) ORANGE | (8) BLACK   |
| (3) GREEN  | (9) YELLOW  |
| (4) BROWN  | (10) VIOLET |
| (5) SLATE  | (11) ROSE   |
| (6) WHITE  | (12) AQUA   |

**LEGEND**

- X - FUSION SPLICE INDIVIDUAL FIBER
- O - EXISTING SPLICE
- - EXPRESS INDIVIDUAL FIBER

**EXPRESS** EXPRESS ENTIRE BUFFER TUBE  
**SPLICE** SPLICE ENTIRE BUFFER TUBE OR MAINTAIN IF EXISTING EXPRESSED

**NOTES:**

- FIBER INTERCONNECT CENTER RACKS ARE SCHEMATIC ONLY - ACTUAL EQUIPMENT FORM MAY VARY.
- ETHERNET SWITCH TERMINATION CONFIGURATIONS ARE GENERIC. CONTRACTOR IS RESPONSIBLE FOR DETERMINING /ENSURING PROPER TERMINATION.
- CONTRACTOR IS RESPONSIBLE FOR FIELD VERIFYING EXISTING SPLICING. THE CONTRACTOR SHALL COORDINATE WITH THE ENGINEER WHERE EXISTING SPLICING IS NOT AS EXPECTED.

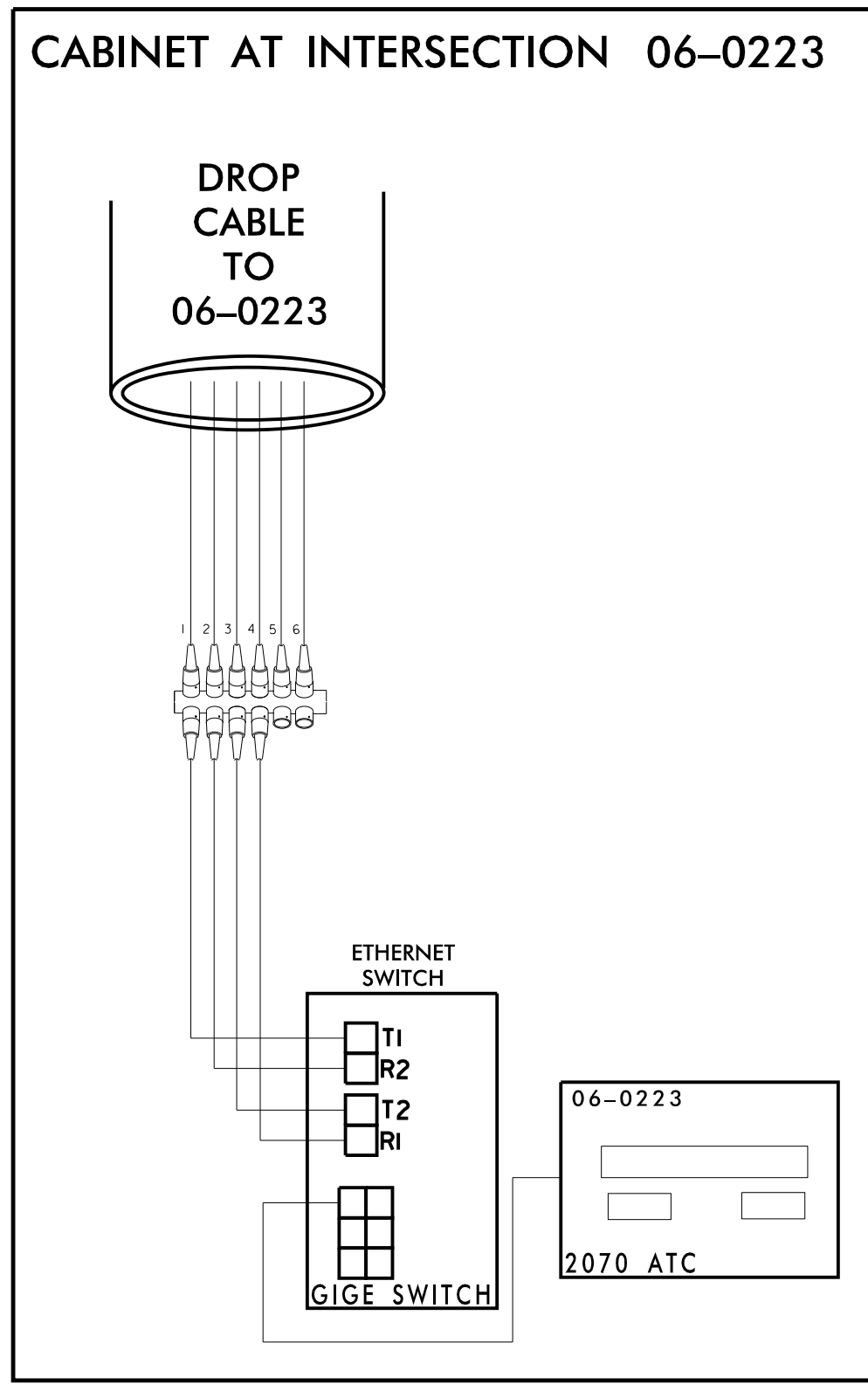
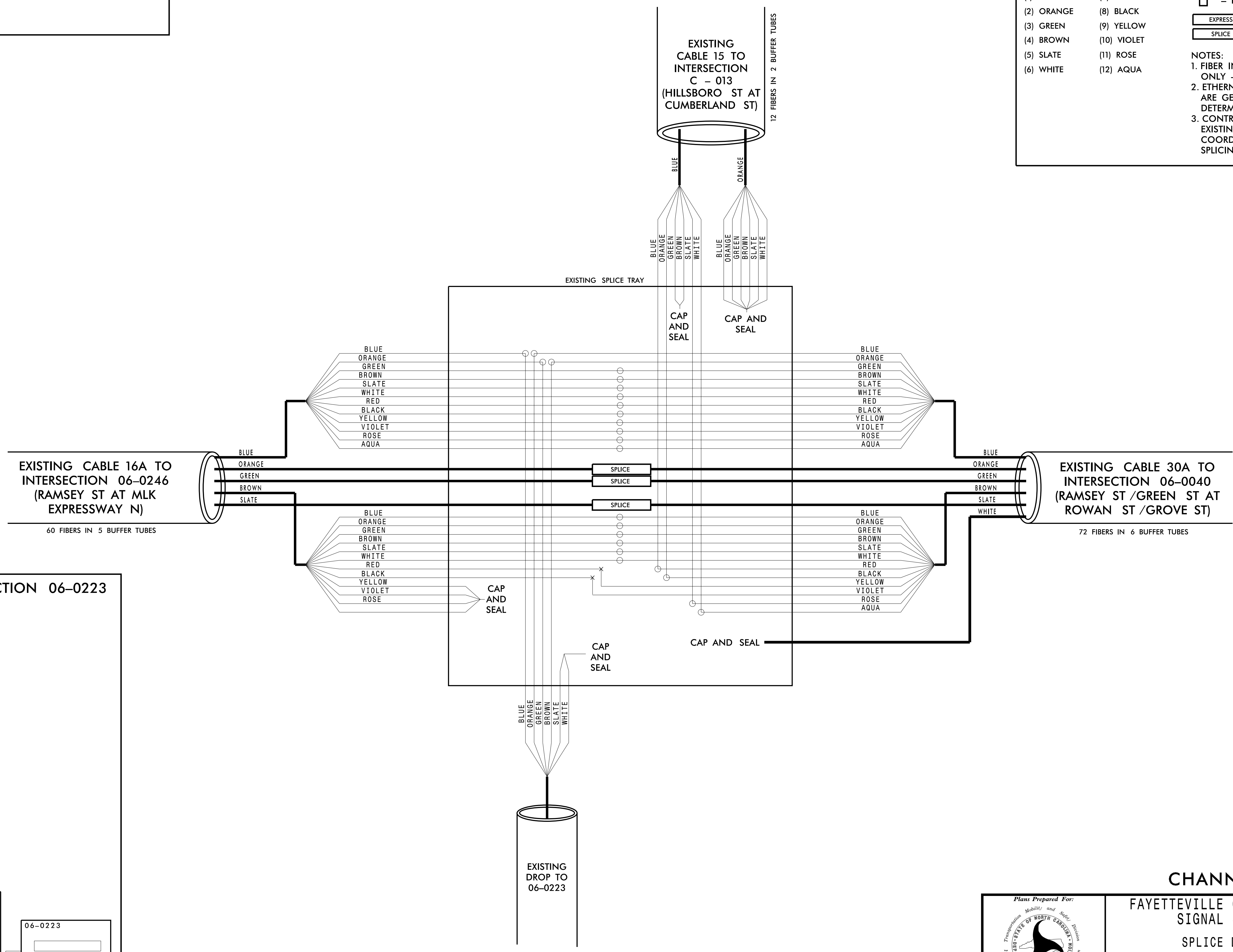

**CHANNEL 16  
FAYETTEVILLE COMPUTERIZED  
SIGNAL SYSTEM  
SPLICE DETAIL**

**DIVISION 06 CUMBERLAND COUNTY**

PLAN DATE: NOVEMBER 2016 REVIEWED BY: N. M. MENGELKOCH  
PREPARED BY: KHA REVIEWED BY: K. W. SMITH

**Kimley»Horn**  
NC License #F-0102  
421 Fayetteville St., Suite 600  
Raleigh, NC 27636  
Tel: (919) 677-2000  
Fax: (919) 677-2050

750 N. Greenfield Pkwy., Garner, NC 27529

SCALE: 0

**SEAL**  
NORTH CAROLINA PROFESSIONAL ENGINEER  
KEVIN W. SMITH  
SEAL 030472  
11/15/2016

REVISIONS: INIT. DATE

SIGNATURE: DATE

CADD File name:

11/15/2016 KARAL\_TPTD\_ITS\_01036305 - Fayetteville Sig Sys Plans\Splicing\01036305\_ITS\_psh\_202-Ch16\_06-0223.dgn

**CHANNEL 16  
NEW SPLICE ENCLOSURE  
(RAMSEY ST NORTH OF  
BARTOW DR)  
CCTV 51**

**COLOR CODE**  
TIA/EIA 598-C

|            |             |
|------------|-------------|
| (1) BLUE   | (7) RED     |
| (2) ORANGE | (8) BLACK   |
| (3) GREEN  | (9) YELLOW  |
| (4) BROWN  | (10) VIOLET |
| (5) SLATE  | (11) ROSE   |
| (6) WHITE  | (12) AQUA   |

**LEGEND**

X - FUSION SPLICE INDIVIDUAL FIBER  
 O - EXISTING SPLICE  
 □ - EXPRESS INDIVIDUAL FIBER

EXPRESS - EXPRESS ENTIRE BUFFER TUBE  
 SPLICE - SPLICE ENTIRE BUFFER TUBE OR MAINTAIN IF EXISTING EXPRESSED

**NOTES:**

- FIBER INTERCONNECT CENTER RACKS ARE SCHEMATIC ONLY - ACTUAL EQUIPMENT FORM MAY VARY.
- ETHERNET SWITCH TERMINATION CONFIGURATIONS ARE GENERIC. CONTRACTOR IS RESPONSIBLE FOR DETERMINING /ENSURING PROPER TERMINATION.
- CONTRACTOR IS RESPONSIBLE FOR FIELD VERIFYING EXISTING SPLICING. THE CONTRACTOR SHALL COORDINATE WITH THE ENGINEER WHERE EXISTING SPLICING IS NOT AS EXPECTED.

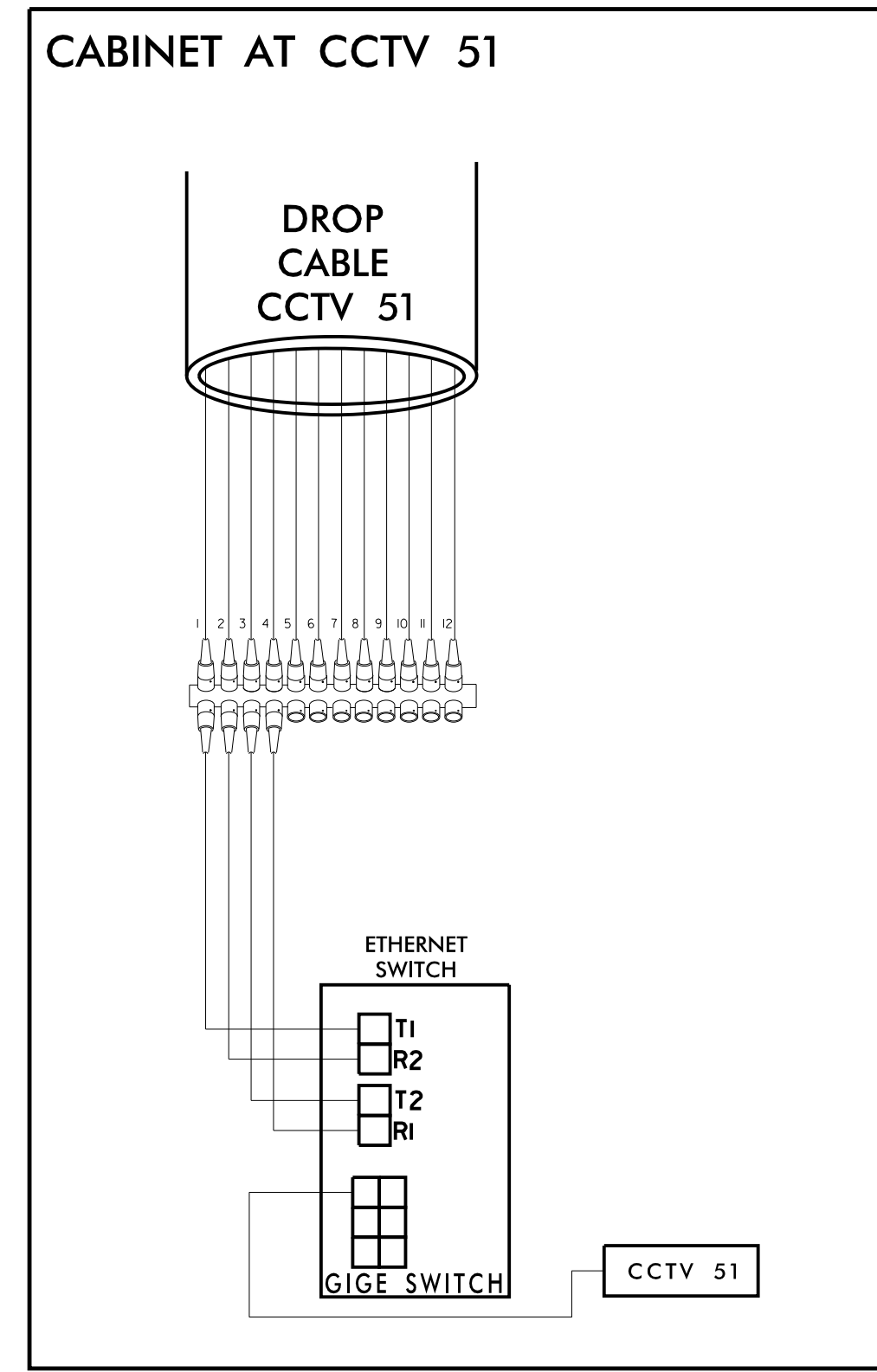
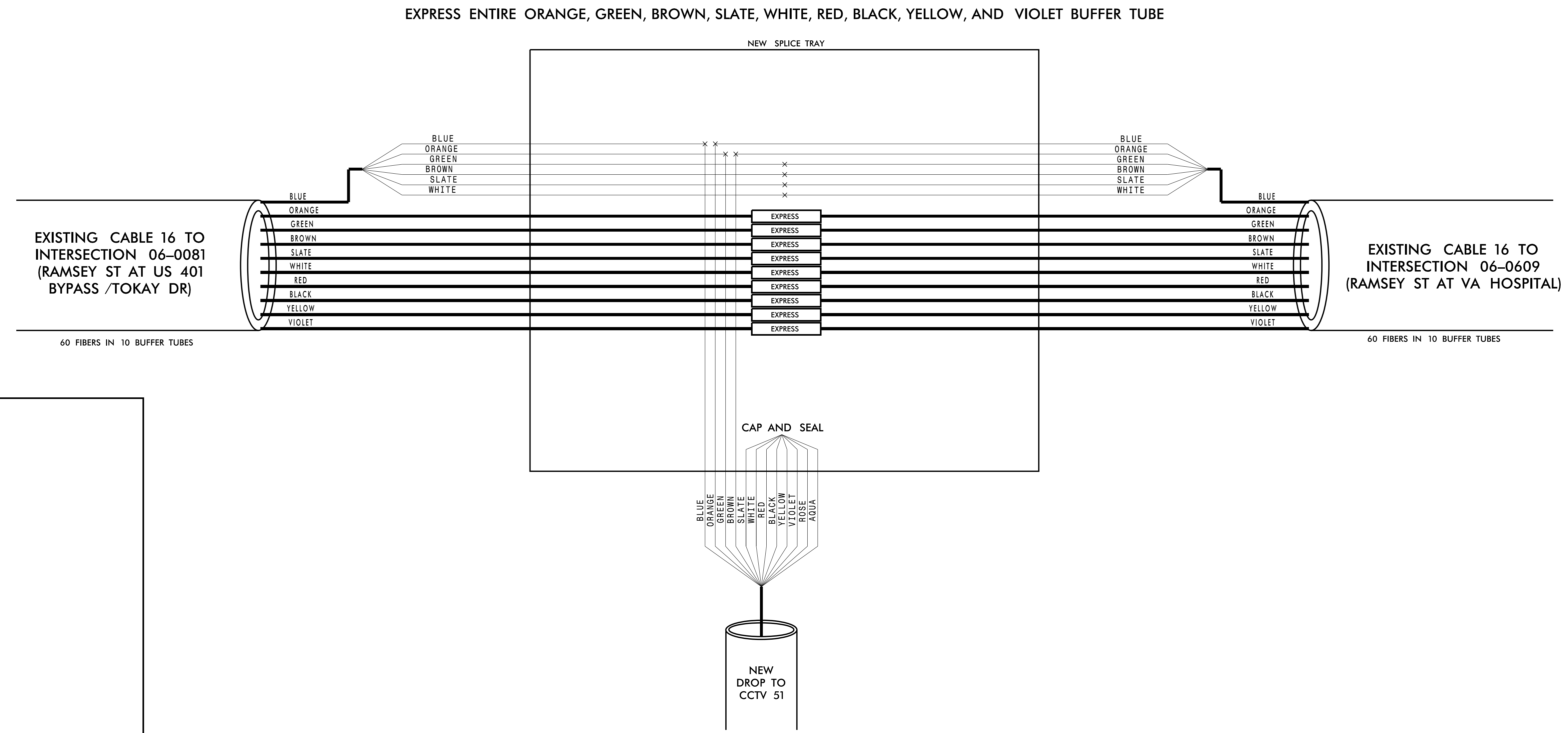

**CHANNEL 16**

**FAYETTEVILLE COMPUTERIZED SIGNAL SYSTEM**

**SPLICE DETAIL**

DIVISION 06 CUMBERLAND COUNTY

PLAN DATE: NOVEMBER 2016 REVIEWED BY: N. M. MENGELKOCH

PREPARED BY: KHA REVIEWED BY: K. W. SMITH

REVISIONS: INIT. DATE

SCALE: 0

Kimley»Horn  
 NC License #F-0102  
 421 Fayetteville St., Suite 600  
 Raleigh, NC 27636  
 Tel: (919) 677-2000  
 Fax: (919) 677-2050

Seal: NORTH CAROLINA PROFESSIONAL ENGINEER KEVIN W. SMITH SEAL 030472

Signature: Kevin Smith DATE: 11/15/2016

11/15/2016 K:\ARL\TPTD\ITS\01036305 - Fayetteville Sig Sys\Plans\Splicing\01036305-ITS\_psh-203-Ch16 CCTV51.dgn

**CHANNEL 16**  
**EXISTING SPLICE ENCLOSURE**  
 (RAMSEY ST AT US 401 BYPASS /  
 TOKAY DR)  
 SIG ID 06-0081  
 CCTV 50

**COLOR CODE**  
 TIA/EIA 598-C

|            |             |
|------------|-------------|
| (1) BLUE   | (7) RED     |
| (2) ORANGE | (8) BLACK   |
| (3) GREEN  | (9) YELLOW  |
| (4) BROWN  | (10) VIOLET |
| (5) SLATE  | (11) ROSE   |
| (6) WHITE  | (12) AQUA   |

**LEGEND**

- X - FUSION SPLICE INDIVIDUAL FIBER
- - EXISTING SPLICE
- - EXPRESS INDIVIDUAL FIBER
- EXPRESS - EXPRESS ENTIRE BUFFER TUBE
- SPLICE - SPLICE ENTIRE BUFFER TUBE OR MAINTAIN IF EXISTING EXPRESSED

**NOTES:**

- FIBER INTERCONNECT CENTER RACKS ARE SCHEMATIC ONLY - ACTUAL EQUIPMENT FORM MAY VARY.
- ETHERNET SWITCH TERMINATION CONFIGURATIONS ARE GENERIC. CONTRACTOR IS RESPONSIBLE FOR DETERMINING /ENSURING PROPER TERMINATION.
- CONTRACTOR IS RESPONSIBLE FOR FIELD VERIFYING EXISTING SPLICING. THE CONTRACTOR SHALL COORDINATE WITH THE ENGINEER WHERE EXISTING SPLICING IS NOT AS EXPECTED.

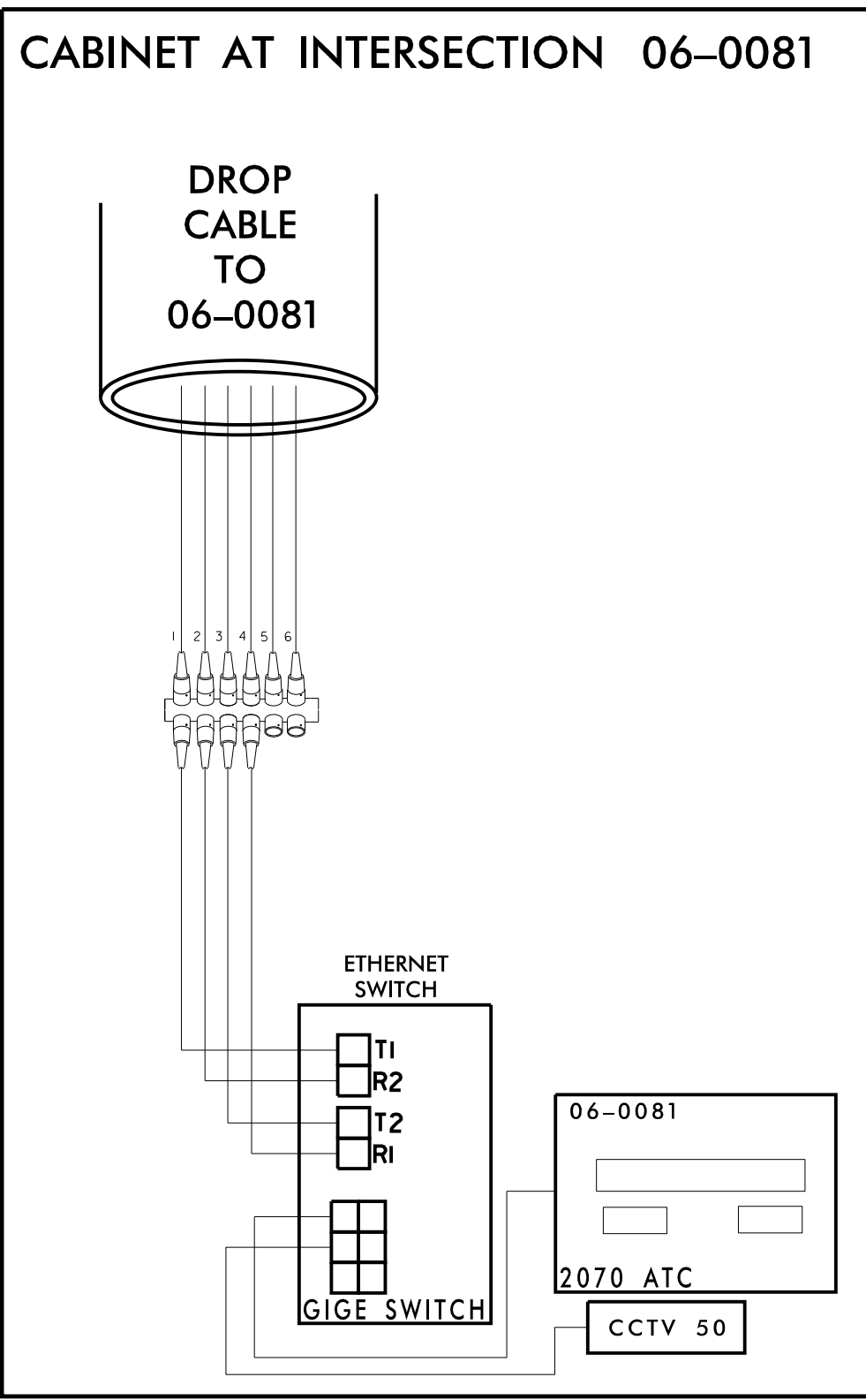
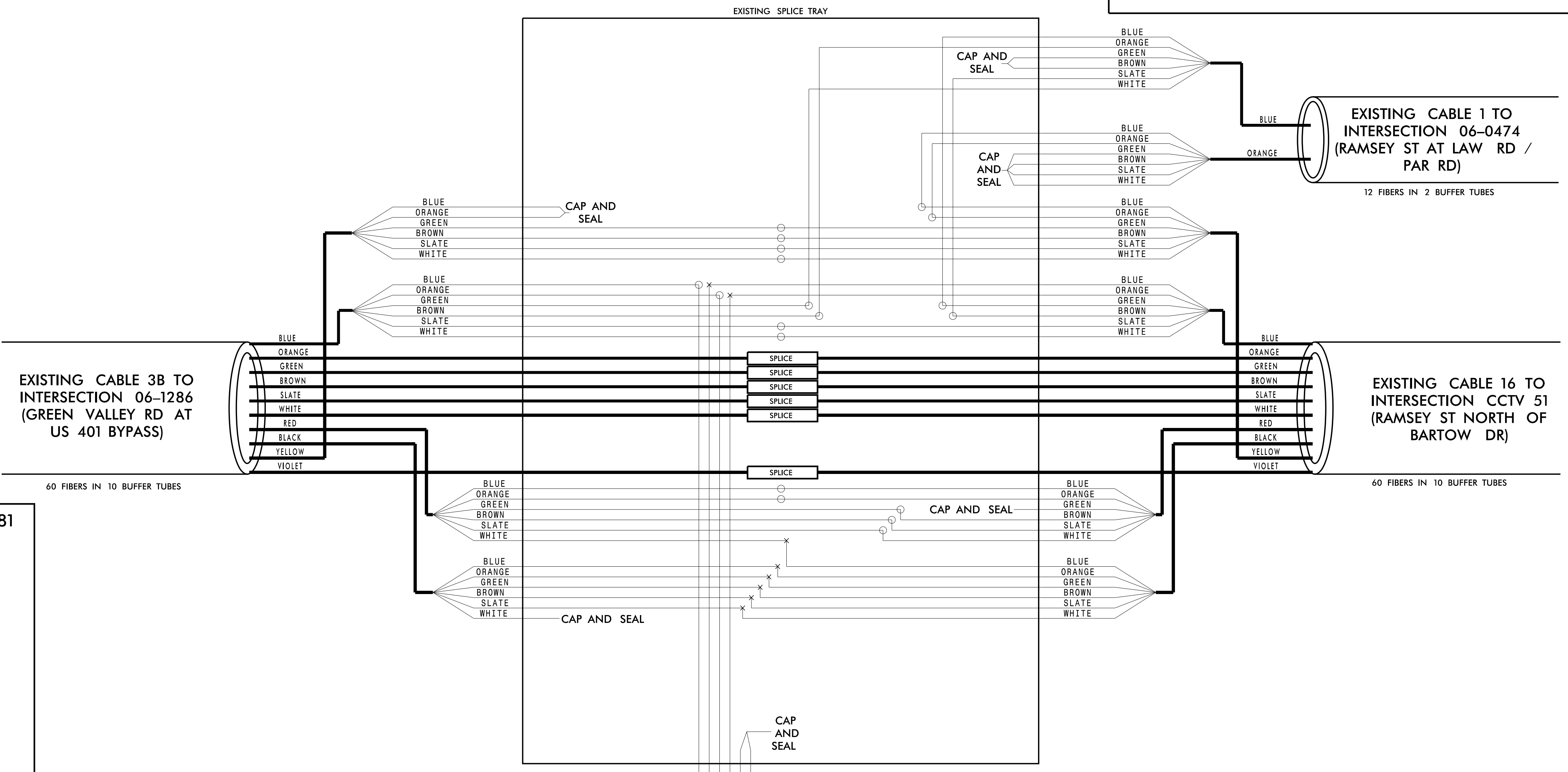

11/15/2016 K:\ARL\TPTD\_ITS\01036305 - Fayetteville Sig Sys\Plans\Splicing\01036305-ITS\_psh\_204-Ch16\_06-0081\CCTV51.dgn

**CHANNEL 16**

**FAYETTEVILLE COMPUTERIZED SIGNAL SYSTEM**  
**SPLICE DETAIL**

|                          |                               |                   |                          |
|--------------------------|-------------------------------|-------------------|--------------------------|
| DIVISION 06              |                               | CUMBERLAND COUNTY |                          |
| PLAN DATE: NOVEMBER 2016 | REVIEWED BY: N. M. MENGELKOCH | PREPARED BY: KHA  | REVIEWED BY: K. W. SMITH |
| REVISIONS                | INIT.                         | DATE              |                          |

SCALE: 0

**Kimley»Horn**  
 NC License #F-0102  
 421 Fayetteville St., Suite 600  
 Raleigh, NC 27636  
 Tel: (919) 677-2000  
 Fax: (919) 677-2050

**Seal:** NORTH CAROLINA PROFESSIONAL ENGINEER KEVIN W. SMITH SEAL 030472  
 11/15/2016  
 CADD Filename:



**CHANNEL 17**  
**EXISTING SPLICE ENCLOSURE**  
**(CLIFFDALE RD AT ALL AMERICAN EXPY SB)**  
**SIG ID 06-1183**  
**CCTV 11**

**COLOR CODE**  
 TIA/EIA 598-C

|            |             |
|------------|-------------|
| (1) BLUE   | (7) RED     |
| (2) ORANGE | (8) BLACK   |
| (3) GREEN  | (9) YELLOW  |
| (4) BROWN  | (10) VIOLET |
| (5) SLATE  | (11) ROSE   |
| (6) WHITE  | (12) AQUA   |

**LEGEND**

X - FUSION SPLICE INDIVIDUAL FIBER  
 O - EXISTING SPLICE  
 □ - EXPRESS INDIVIDUAL FIBER

EXPRESS - EXPRESS ENTIRE BUFFER TUBE  
 SPLICE - SPLICE ENTIRE BUFFER TUBE OR MAINTAIN IF EXISTING EXPRESSED

**NOTES:**

- FIBER INTERCONNECT CENTER RACKS ARE SCHEMATIC ONLY - ACTUAL EQUIPMENT FORM MAY VARY.
- ETHERNET SWITCH TERMINATION CONFIGURATIONS ARE GENERIC. CONTRACTOR IS RESPONSIBLE FOR DETERMINING /ENSURING PROPER TERMINATION.
- CONTRACTOR IS RESPONSIBLE FOR FIELD VERIFYING EXISTING SPLICING. THE CONTRACTOR SHALL COORDINATE WITH THE ENGINEER WHERE EXISTING SPLICING IS NOT AS EXPECTED.

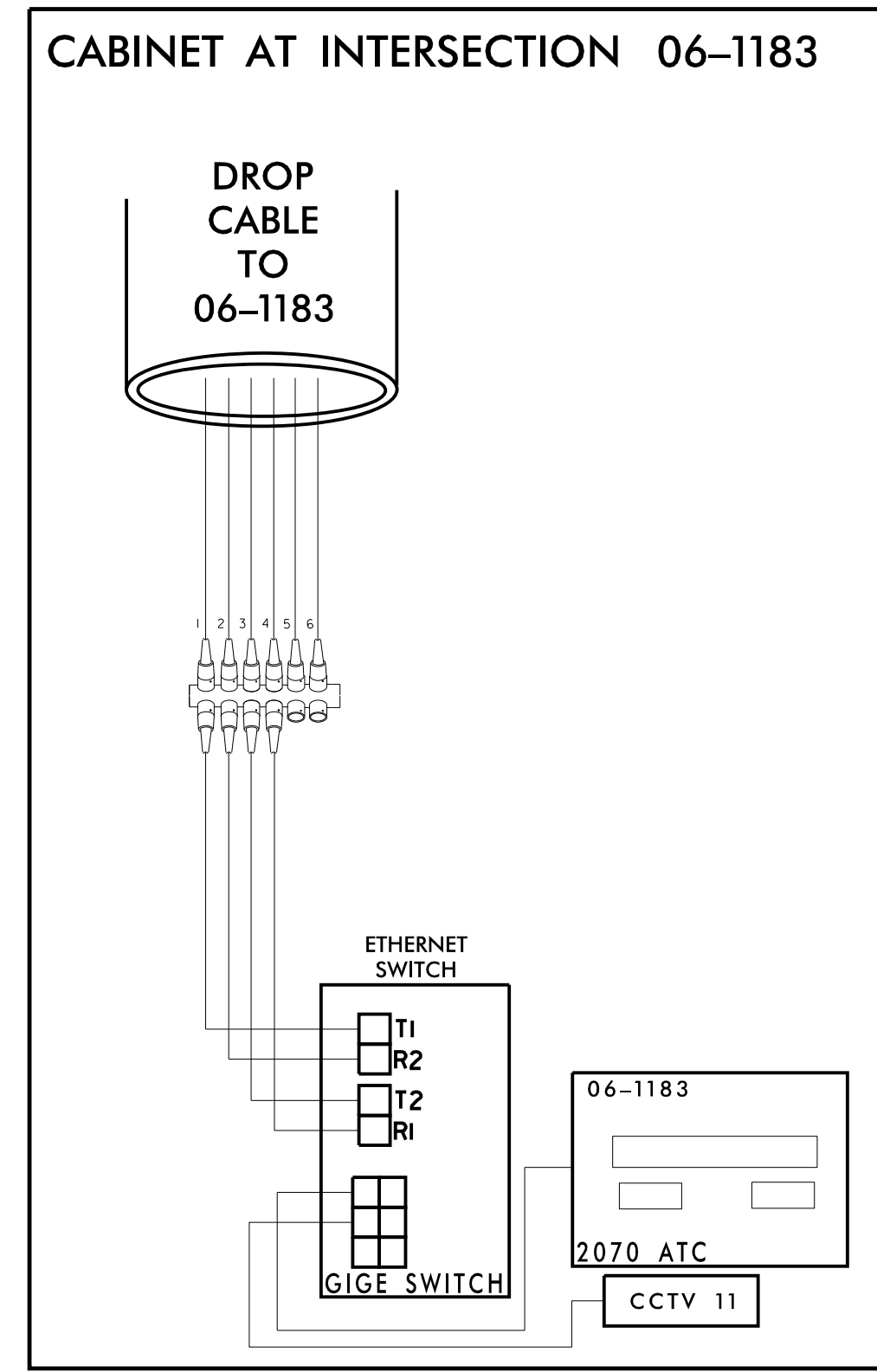
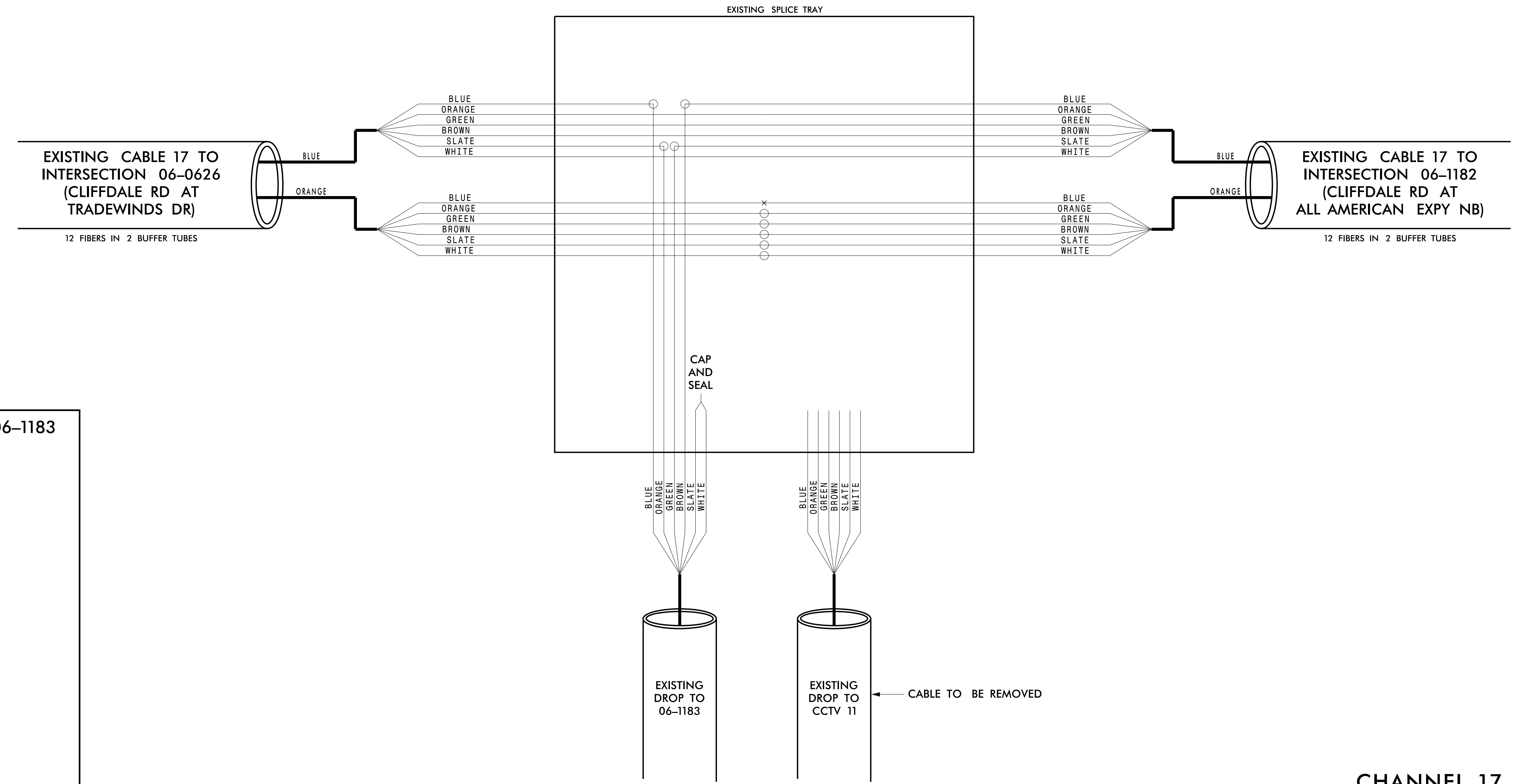

11/15/2016 K:\ARL\TPTD\_ITS\01036305 - Fayetteville Sig Sys\Plans\Splicing\01036305-ITS\_psh-205-CH17 CCT\lcmd2 Horvest 06-0626.dgn

**CHANNEL 17**

**FAYETTEVILLE COMPUTERIZED SIGNAL SYSTEM**  
**SPLICE DETAIL**

DIVISION 06 CUMBERLAND COUNTY

PLAN DATE: NOVEMBER 2016 REVIEWED BY: N. M. MENGELKOCH

PREPARED BY: KHA REVIEWED BY: K. W. SMITH

250 N. Greenfield Place - Garner, NC 27529

**Kimley»Horn**  
 NC License #F-0102  
 421 Fayetteville St., Suite 600  
 Raleigh, NC 27636  
 Tel: (919) 677-2000  
 Fax: (919) 677-2050

SCALE: 0

SEAL: NORTH CAROLINA PROFESSIONAL ENGINEER KEVIN W. SMITH SEAL 030472

11/15/2016

**CHANNEL 18  
EXISTING SPLICE ENCLOSURE  
(US 401 BYPASS AT CLIFFDALE RD)  
SIG ID 06-0094  
CCTV 3**

**COLOR CODE**  
TIA/EIA 598-C

|            |             |
|------------|-------------|
| (1) BLUE   | (7) RED     |
| (2) ORANGE | (8) BLACK   |
| (3) GREEN  | (9) YELLOW  |
| (4) BROWN  | (10) VIOLET |
| (5) SLATE  | (11) ROSE   |
| (6) WHITE  | (12) AQUA   |

**LEGEND**

- X - FUSION SPLICE INDIVIDUAL FIBER
- O - EXISTING SPLICE
- - EXPRESS INDIVIDUAL FIBER

|         |   |
|---------|---|
| EXPRESS | EXPRESS ENTIRE BUFFER TUBE                                  |
| SPLICE  | SPLICE ENTIRE BUFFER TUBE OR MAINTAIN IF EXISTING EXPRESSED |

**NOTES:**

- FIBER INTERCONNECT CENTER RACKS ARE SCHEMATIC ONLY - ACTUAL EQUIPMENT FORM MAY VARY.
- ETHERNET SWITCH TERMINATION CONFIGURATIONS ARE GENERIC. CONTRACTOR IS RESPONSIBLE FOR DETERMINING /ENSURING PROPER TERMINATION.
- CONTRACTOR IS RESPONSIBLE FOR FIELD VERIFYING EXISTING SPLICING. THE CONTRACTOR SHALL COORDINATE WITH THE ENGINEER WHERE EXISTING SPLICING IS NOT AS EXPECTED.

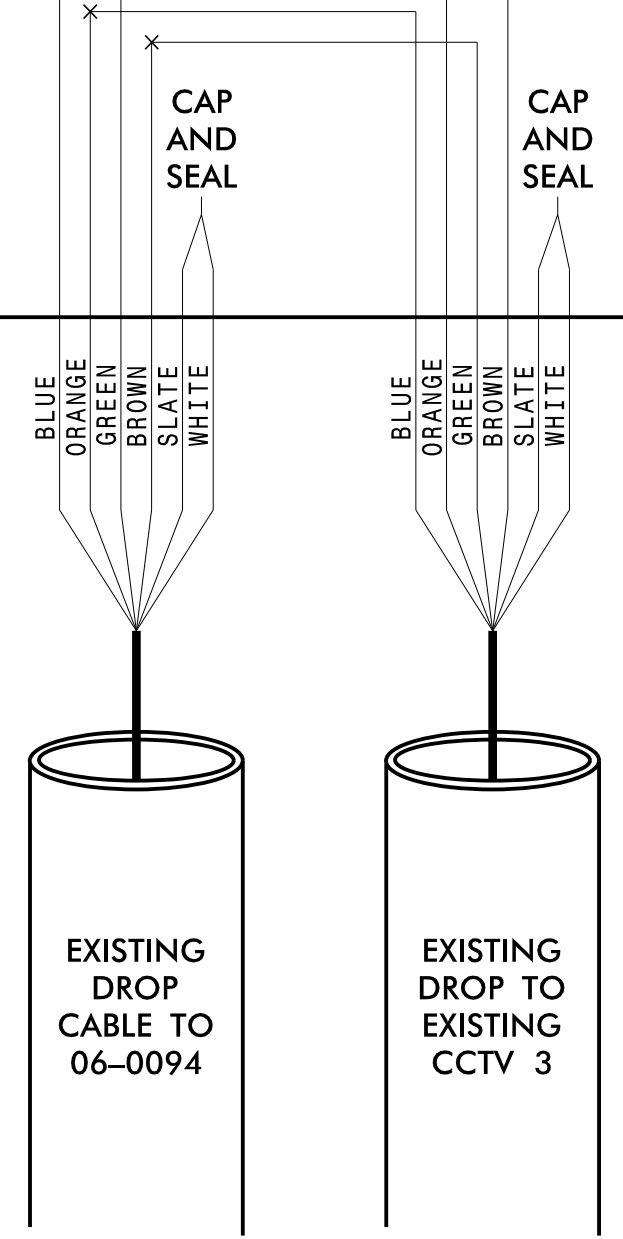
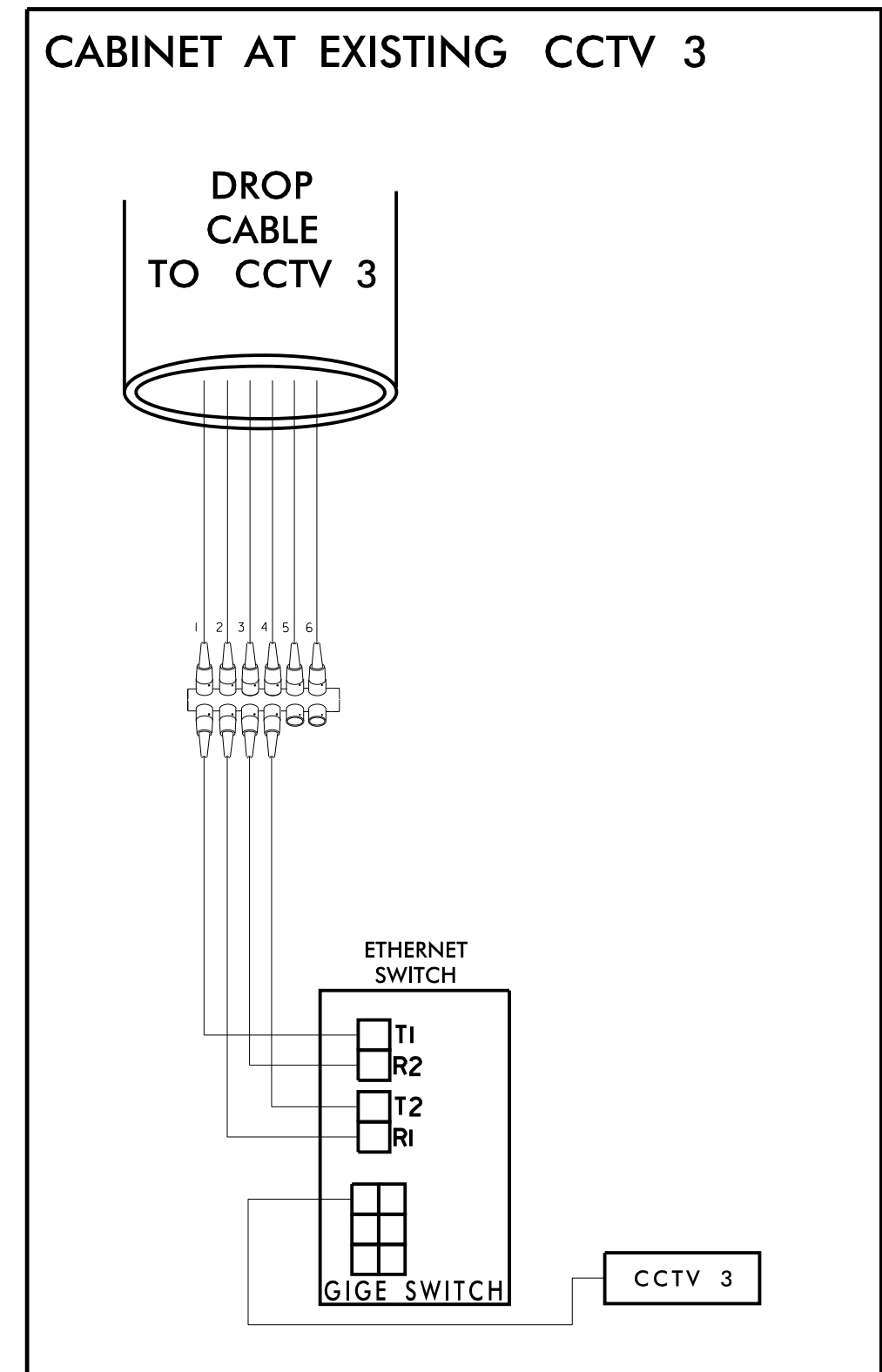
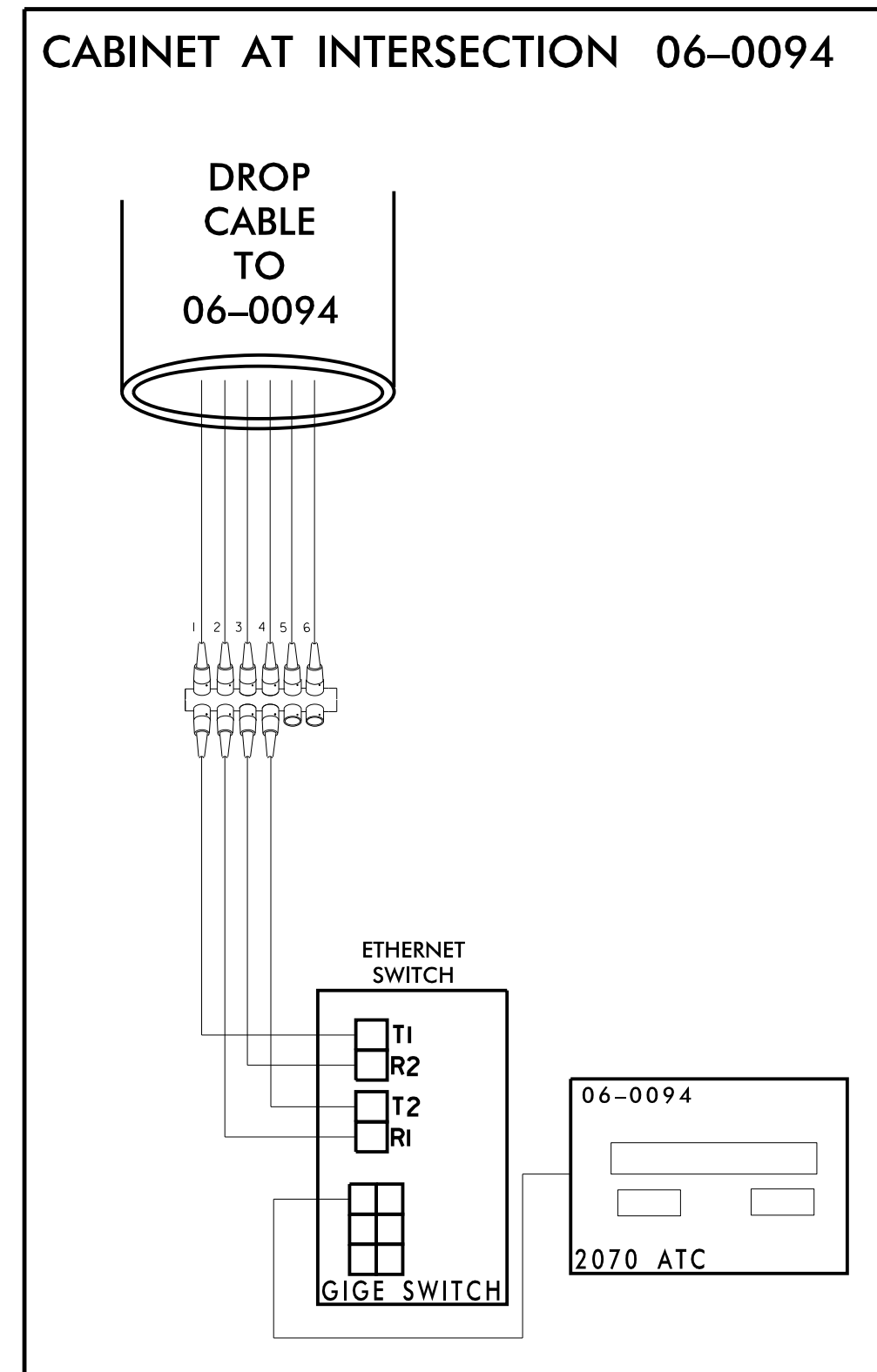
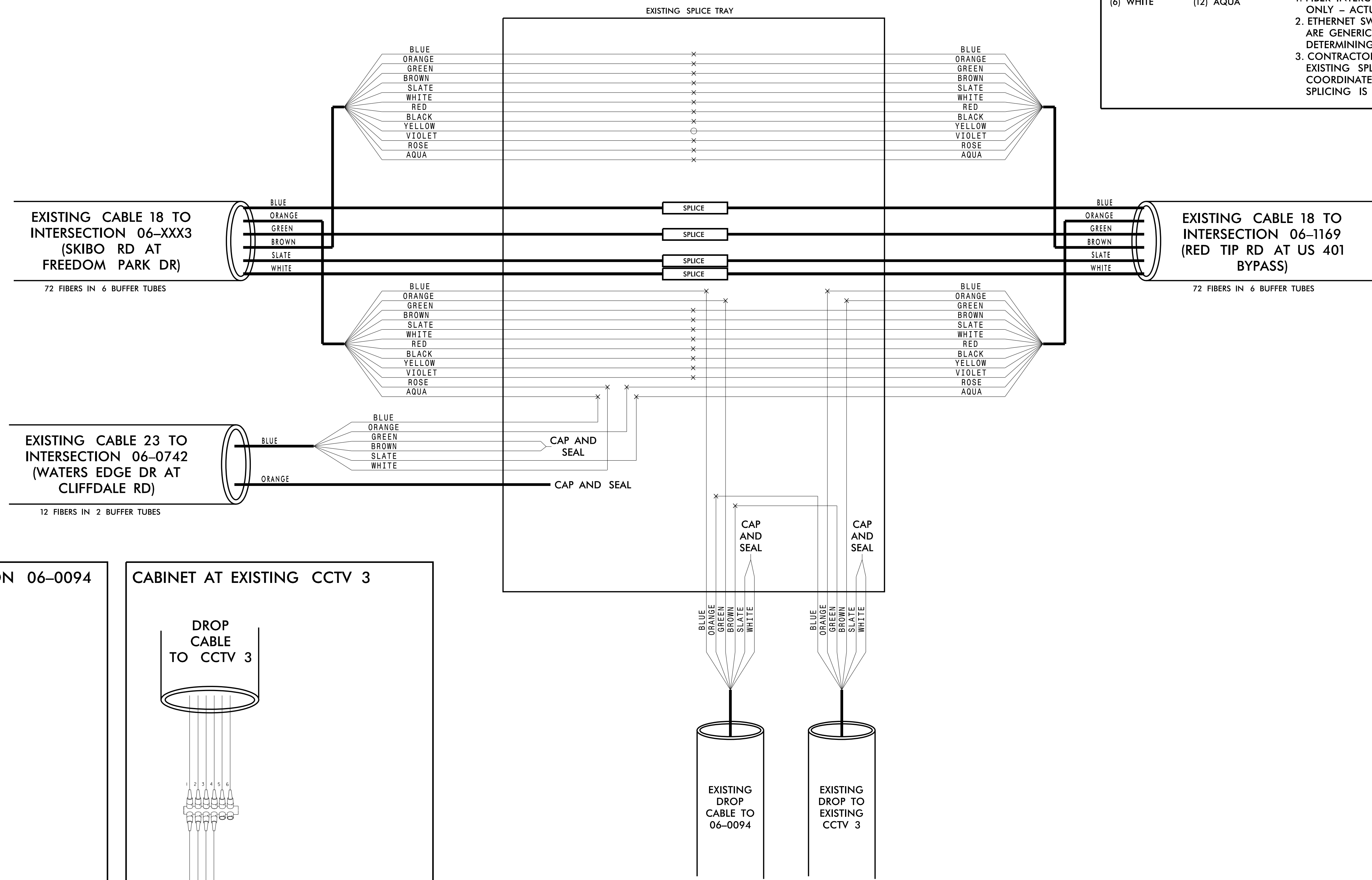

**CHANNEL 18  
FAYETTEVILLE COMPUTERIZED  
SIGNAL SYSTEM  
SPLICE DETAIL**

Division 06 CUMBERLAND COUNTY

PLAN DATE: NOVEMBER 2016 REVIEWED BY: N.M. MENGELKOCH

PREPARED BY: KHA REVIEWED BY: K.W. SMITH

Scale: 0

**Kimley»Horn**  
NC License #F-0102  
421 Fayetteville St., Suite 600  
Raleigh, NC 27636  
Tel: (919) 677-2000  
Fax: (919) 677-2050

**Seal:** NORTH CAROLINA PROFESSIONAL ENGINEER KEVIN W. SMITH SEAL 030472

Signature: Kevin W. Smith DATE: 11/15/2016

11/15/2016 K:\ARL\TPTD\ITS\01036305 - Fayetteville Sig Sys\Plans\Splicing\01036305-ITS\_psh-206-CH18 CCTV3 Hor-vest 06-0094.dgn

**CHANNEL 18**  
**EXISTING SPLICE ENCLOSURE**  
**(K-MART AT US 401 BYPASS)**  
**SIG ID 06-0915**  
**CCTV 14**

**COLOR CODE**  
 TIA/EIA 598-C

|            |             |
|------------|-------------|
| (1) BLUE   | (7) RED     |
| (2) ORANGE | (8) BLACK   |
| (3) GREEN  | (9) YELLOW  |
| (4) BROWN  | (10) VIOLET |
| (5) SLATE  | (11) ROSE   |
| (6) WHITE  | (12) AQUA   |

**LEGEND**

X - FUSION SPLICE INDIVIDUAL FIBER  
 O - EXISTING SPLICE  
 □ - EXPRESS INDIVIDUAL FIBER

EXPRESS - EXPRESS ENTIRE BUFFER TUBE  
 SPLICE - SPLICE ENTIRE BUFFER TUBE OR MAINTAIN IF EXISTING EXPRESSED

**NOTES:**

- FIBER INTERCONNECT CENTER RACKS ARE SCHEMATIC ONLY - ACTUAL EQUIPMENT FORM MAY VARY.
- ETHERNET SWITCH TERMINATION CONFIGURATIONS ARE GENERIC. CONTRACTOR IS RESPONSIBLE FOR DETERMINING /ENSURING PROPER TERMINATION.
- CONTRACTOR IS RESPONSIBLE FOR FIELD VERIFYING EXISTING SPlicing. THE CONTRACTOR SHALL COORDINATE WITH THE ENGINEER WHERE EXISTING SPlicing IS NOT AS EXPECTED.

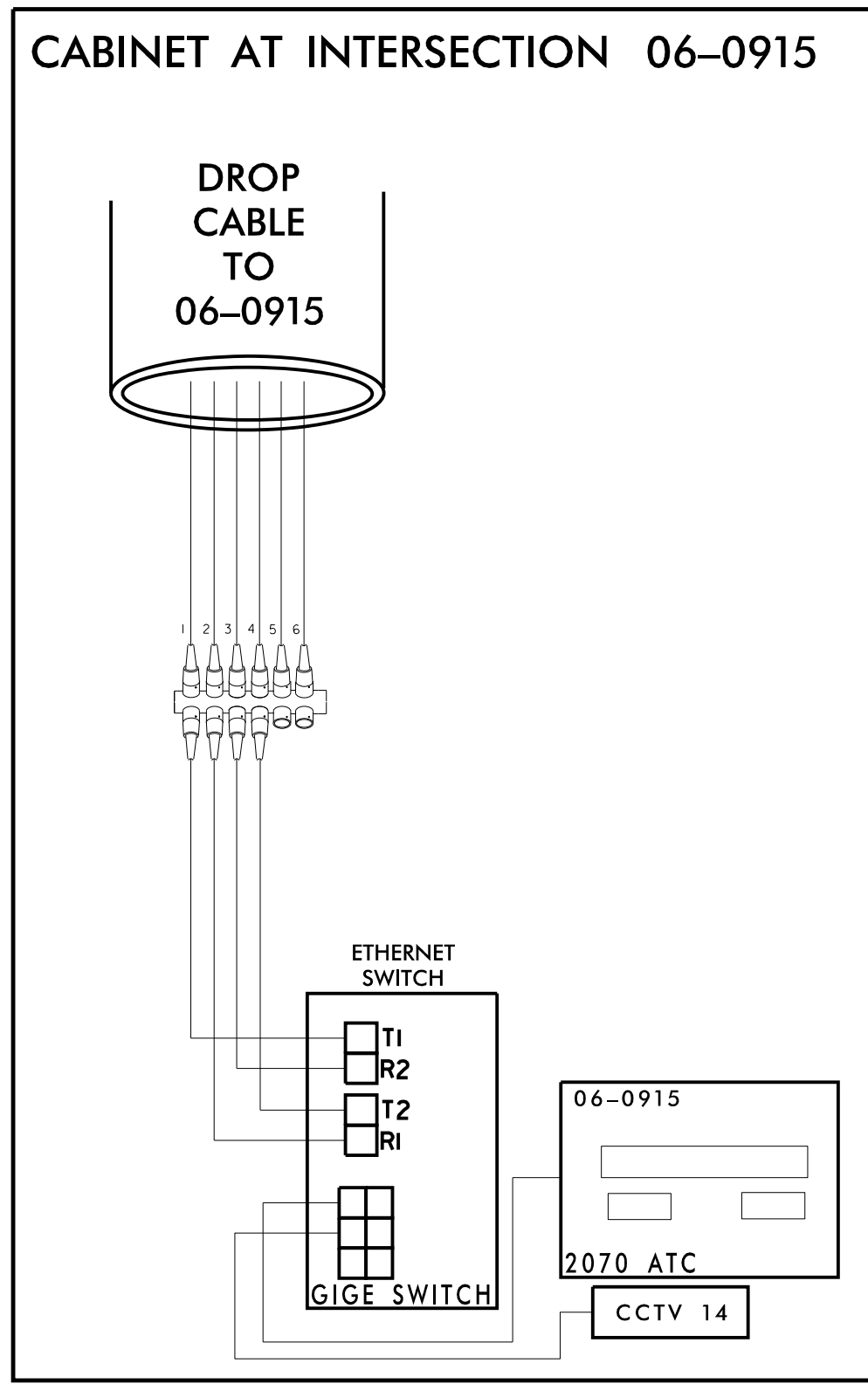
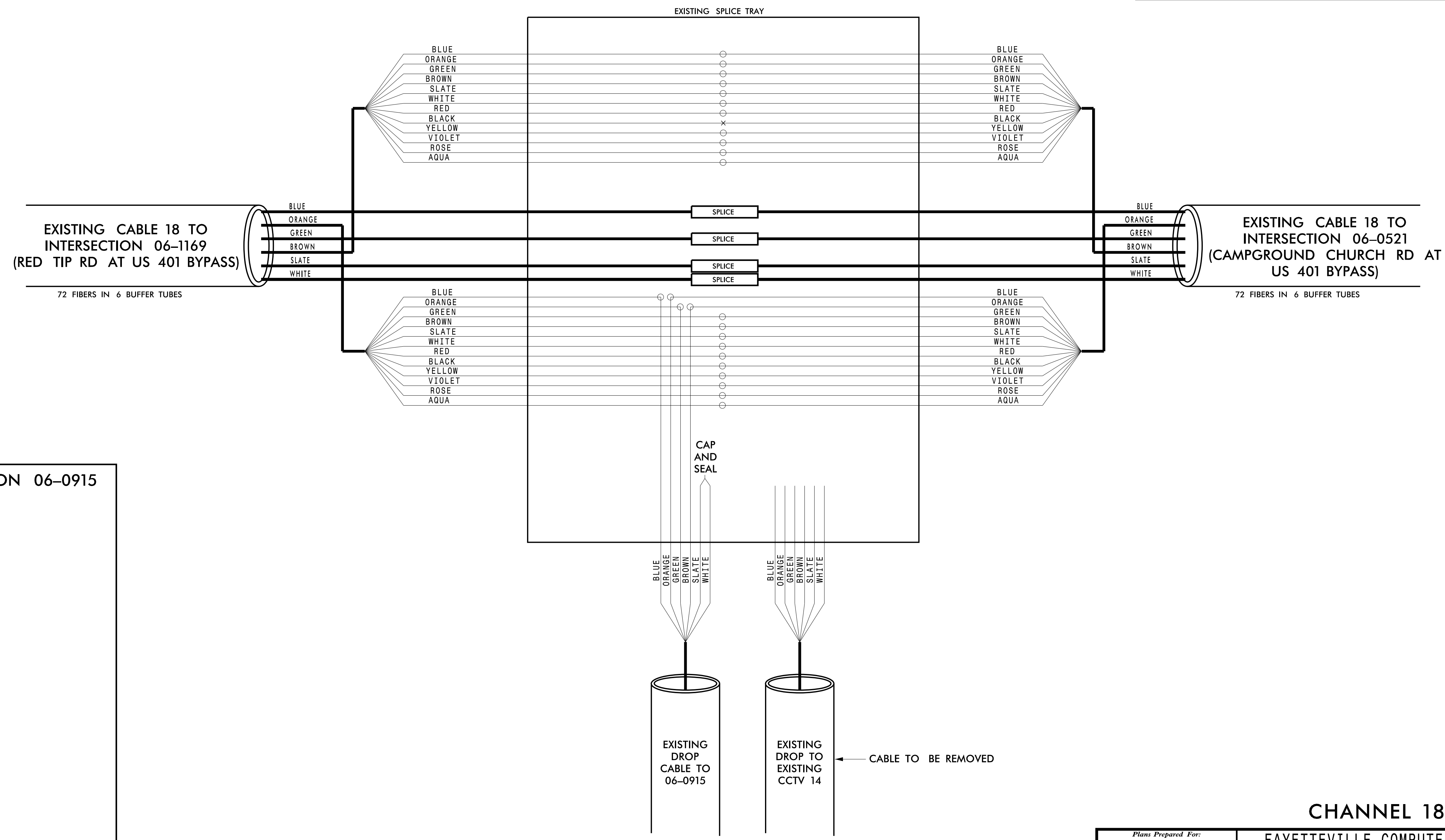

**CHANNEL 18**

**FAYETTEVILLE COMPUTERIZED SIGNAL SYSTEM**

**SPLICE DETAIL**

DIVISION 06 CUMBERLAND COUNTY

PLAN DATE: NOVEMBER 2016 REVIEWED BY: N.M. MENGELKOCH

PREPARED BY: KHA REVIEWED BY: K.W. SMITH

SCALE: 0

Kimley Horn

NC License #F-0102  
 421 Fayetteville St., Suite 600  
 Raleigh, NC 27636  
 Tel: (919) 677-2000  
 Fax: (919) 677-2050

SEAL  
 NORTH CAROLINA PROFESSIONAL ENGINEER  
 SEAL 030472  
 KEVIN W. SMITH  
 11/15/2016

11/15/2016 K:\ARL\TPTD\ITS\01036305 - Fayetteville Sig Sys\Plans\Splicing\01036305-ITS-psr-207-CH18 CCT14 06-0915.dgn

**CHANNEL 18  
EXISTING SPLICE ENCLOSURE  
(US 401 BYPASS AT MORGANTON RD)  
SIG ID 06-0095  
CCTV 2**

**COLOR CODE**  
TIA/EIA 598-C

|            |             |
|------------|-------------|
| (1) BLUE   | (7) RED     |
| (2) ORANGE | (8) BLACK   |
| (3) GREEN  | (9) YELLOW  |
| (4) BROWN  | (10) VIOLET |
| (5) SLATE  | (11) ROSE   |
| (6) WHITE  | (12) AQUA   |

**LEGEND**

- X - FUSION SPLICE INDIVIDUAL FIBER
- - EXISTING SPLICE
- - EXPRESS INDIVIDUAL FIBER

EXPRESS: EXPRESS ENTIRE BUFFER TUBE  
SPLICE: SPLICE ENTIRE BUFFER TUBE OR MAINTAIN IF EXISTING EXPRESSED

**NOTES:**

- FIBER INTERCONNECT CENTER RACKS ARE SCHEMATIC ONLY - ACTUAL EQUIPMENT FORM MAY VARY.
- ETHERNET SWITCH TERMINATION CONFIGURATIONS ARE GENERIC. CONTRACTOR IS RESPONSIBLE FOR DETERMINING /ENSURING PROPER TERMINATION.
- CONTRACTOR IS RESPONSIBLE FOR FIELD VERIFYING EXISTING SPLICING. THE CONTRACTOR SHALL COORDINATE WITH THE ENGINEER WHERE EXISTING SPLICING IS NOT AS EXPECTED.

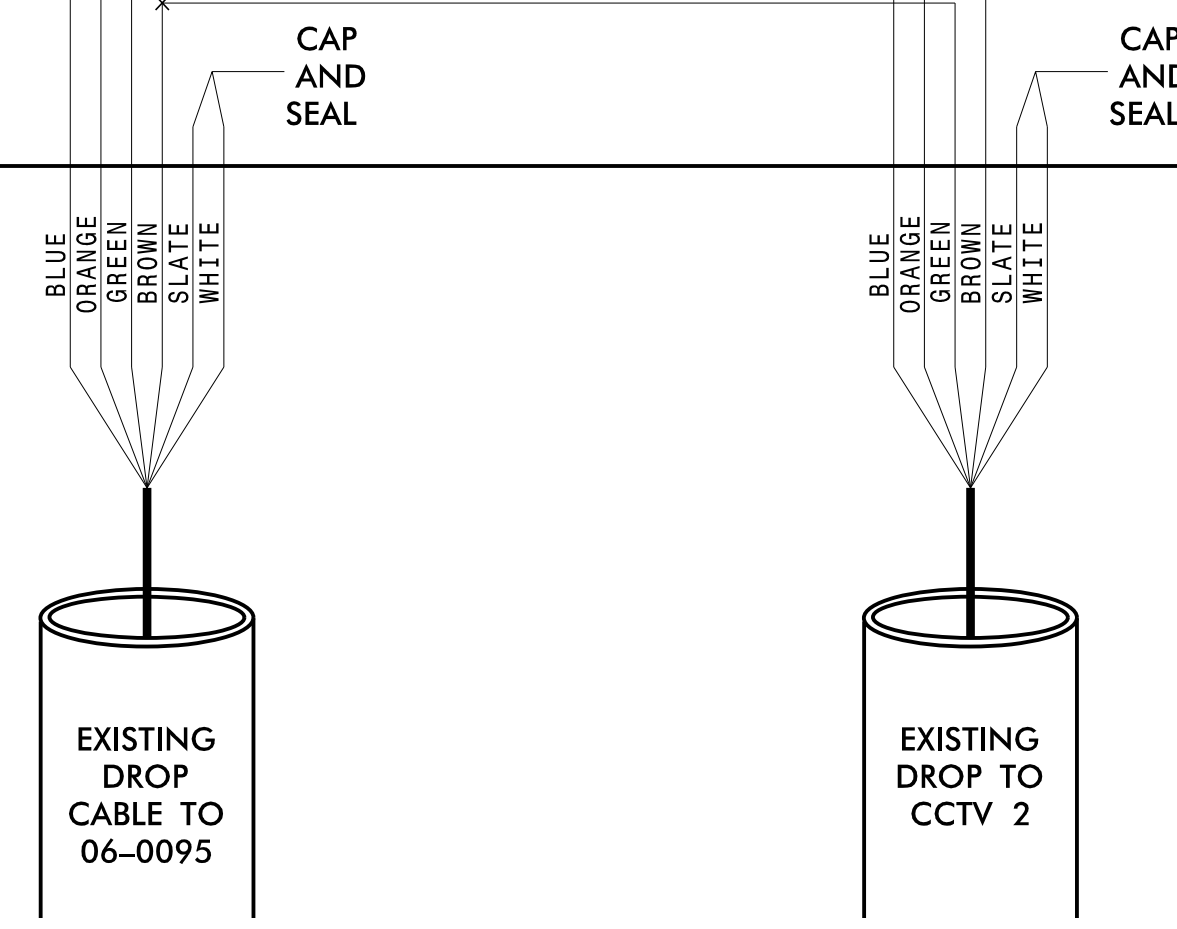
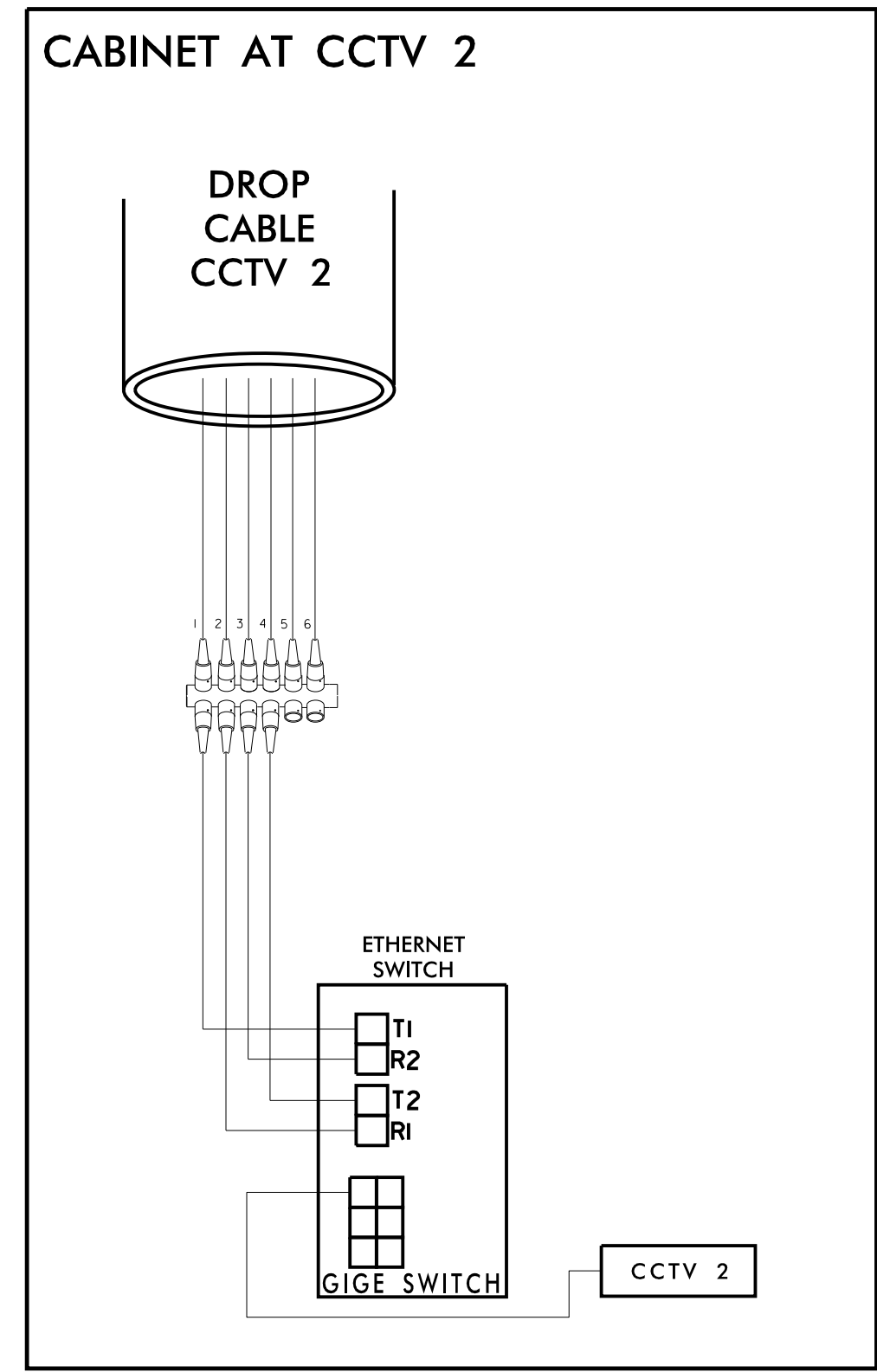
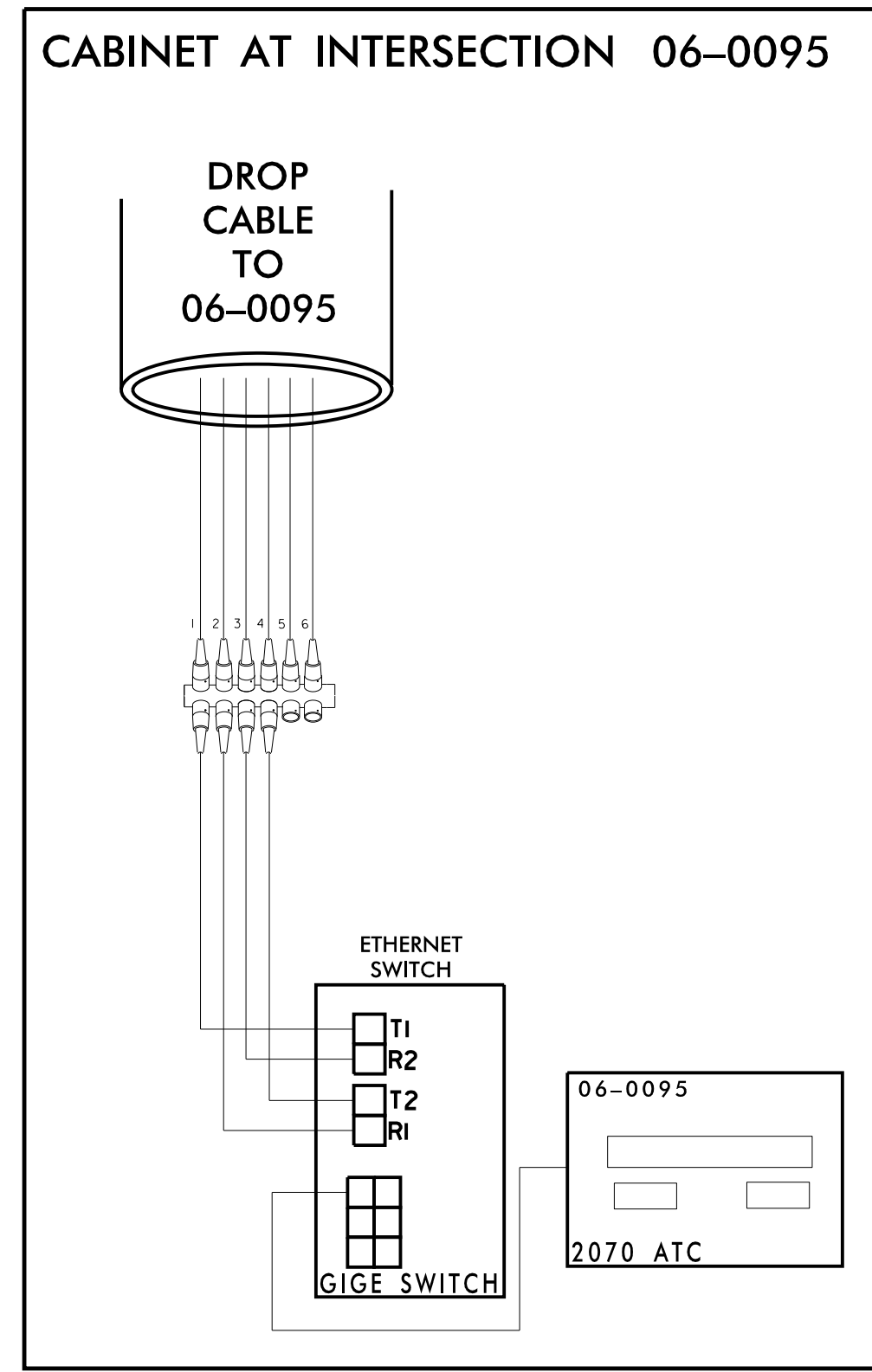
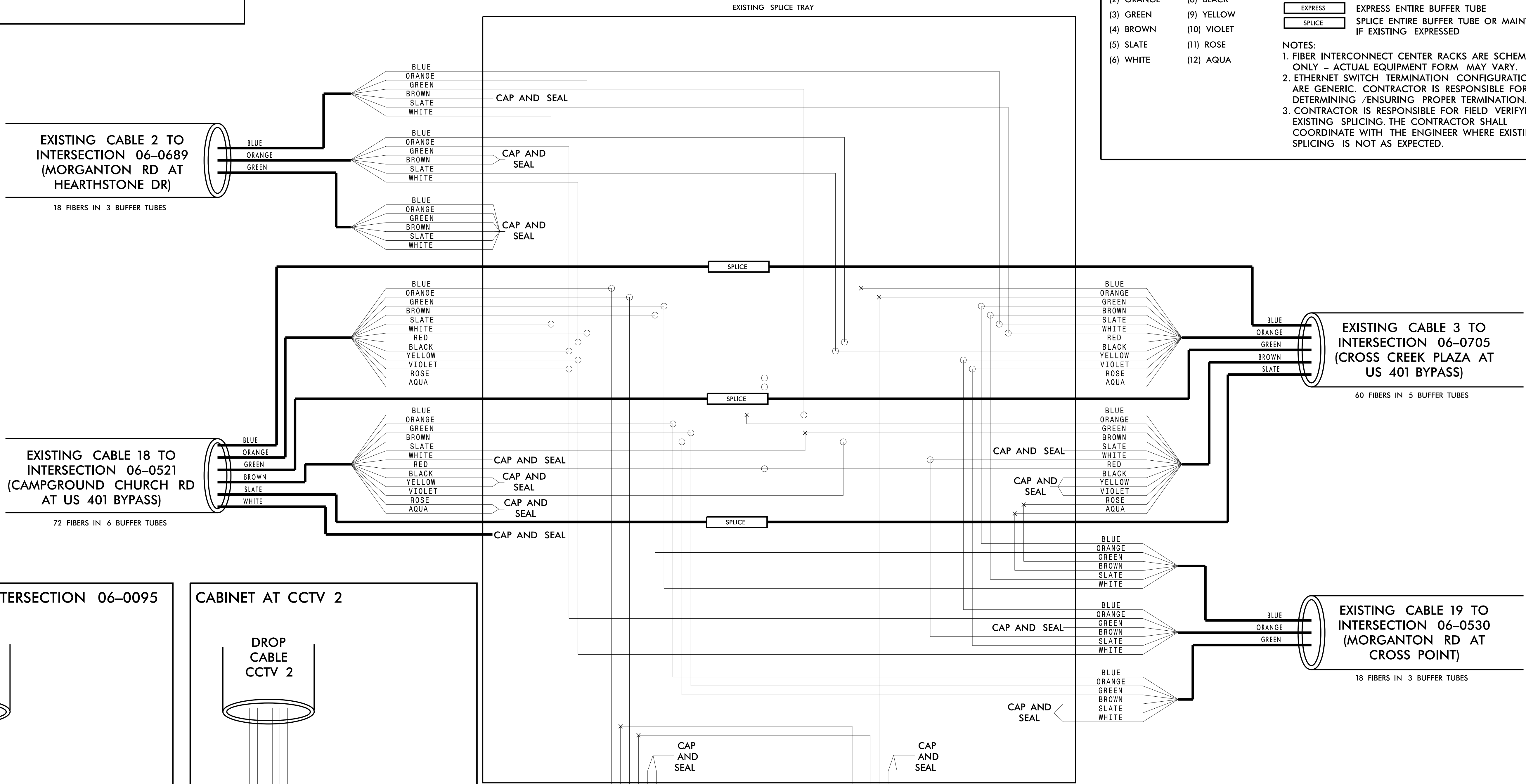

**CHANNEL 18  
FAYETTEVILLE COMPUTERIZED  
SIGNAL SYSTEM  
SPLICE DETAIL**

Division 06 CUMBERLAND COUNTY

PLAN DATE: NOVEMBER 2016 REVIEWED BY: N. M. MENGELKOCH

PREPARED BY: KHA REVIEWED BY: K. W. SMITH

Kimley Horn  
NC License #F-0102  
421 Fayetteville St., Suite 600  
Raleigh, NC 27636  
Tel: (919) 677-2000  
Fax: (919) 677-2050

SCALE: 0

SEAL: NORTH CAROLINA PROFESSIONAL ENGINEER KEVIN W. SMITH SEAL 030472

11/15/2016

11/15/2016 K:\ARL\TPTD\ITS\01036305 - Fayetteville Sig Sys\Plans\Splicing\01036305-ITS\_psh-208-Ch18 CCTV Hor-vest at 06-0095.dgn

**CHANNEL 19**  
**EXISTING SPLICE ENCLOSURE**  
**(ALL AMERICAN EXPRESS NB AT**  
**MORGANTON RD)**  
**SIG ID 06-0319**  
**CCTV 19**

**COLOR CODE**  
TIA/EIA 598-C

|            |             |
|------------|-------------|
| (1) BLUE   | (7) RED     |
| (2) ORANGE | (8) BLACK   |
| (3) GREEN  | (9) YELLOW  |
| (4) BROWN  | (10) VIOLET |
| (5) SLATE  | (11) ROSE   |
| (6) WHITE  | (12) AQUA   |

**LEGEND**

X - FUSION SPLICE INDIVIDUAL FIBER  
O - EXISTING SPLICE  
□ - EXPRESS INDIVIDUAL FIBER

EXPRESS - EXPRESS ENTIRE BUFFER TUBE  
SPLICE - SPLICE ENTIRE BUFFER TUBE OR MAINTAIN IF EXISTING EXPRESSED

**NOTES:**

- FIBER INTERCONNECT CENTER RACKS ARE SCHEMATIC ONLY - ACTUAL EQUIPMENT FORM MAY VARY.
- ETHERNET SWITCH TERMINATION CONFIGURATIONS ARE GENERIC. CONTRACTOR IS RESPONSIBLE FOR DETERMINING /ENSURING PROPER TERMINATION.
- CONTRACTOR IS RESPONSIBLE FOR FIELD VERIFYING EXISTING SPLICING. THE CONTRACTOR SHALL COORDINATE WITH THE ENGINEER WHERE EXISTING SPLICING IS NOT AS EXPECTED.

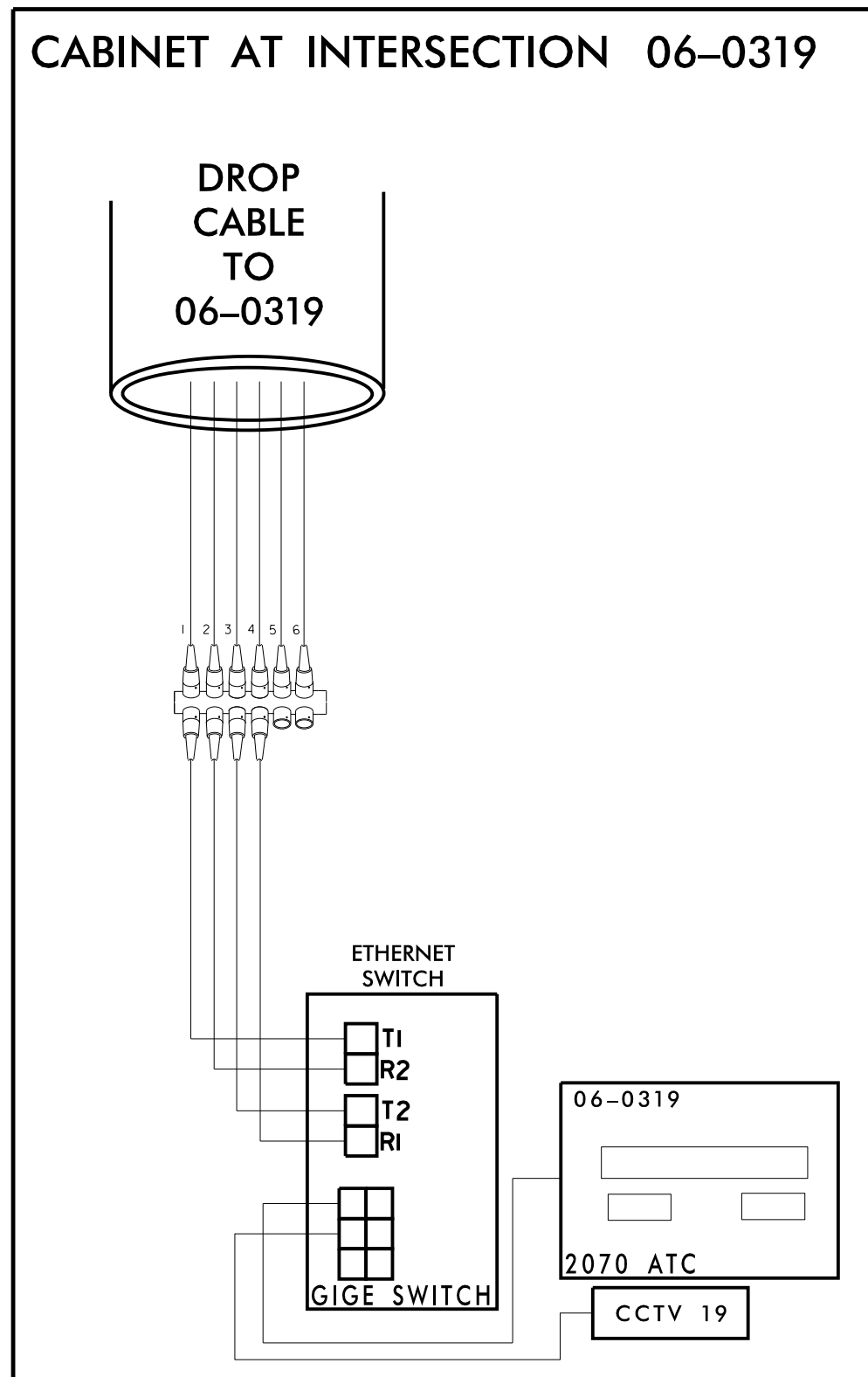
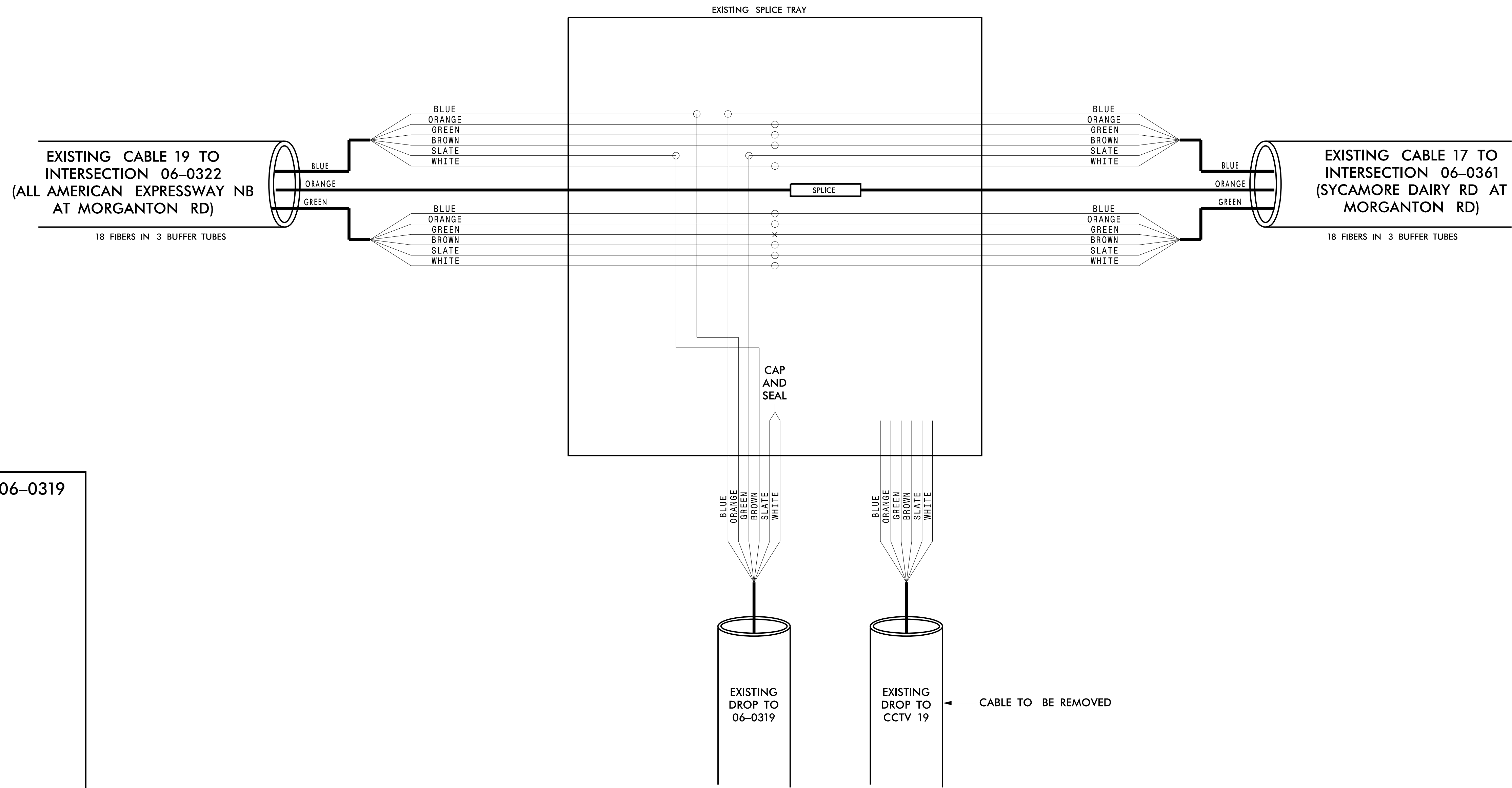

**CHANNEL 19**

**FAYETTEVILLE COMPUTERIZED SIGNAL SYSTEM**  
**SPLICE DETAIL**

DIVISION 06 CUMBERLAND COUNTY

PLAN DATE: NOVEMBER 2016 REVIEWED BY: N. M. MENGELKOCH

PREPARED BY: KHA REVIEWED BY: K. W. SMITH

SCALE: 0

Kimley»Horn  
NC License #F-0102  
421 Fayetteville St., Suite 600  
Raleigh, NC 27636  
Tel: (919) 677-2000  
Fax: (919) 677-2050

SEAL  
NORTH CAROLINA PROFESSIONAL ENGINEER  
SEAL 030472  
KEVIN W. SMITH  
11/15/2016

11/15/2016 K:\ARL\TPTD\_ITS\01036305 - Fayetteville Sig Sys\Plans\Splicing\01036305-ITS\_psh-209-Chig CCTV20 Harvest 06-0322.dgn

**CHANNEL 19  
EXISTING SPLICE ENCLOSURE  
(MORGANTON RD AT  
GLENSFORD RD /CROSS CREEK MALL)  
SIG ID 06-0346  
CCTV 16**

**COLOR CODE**  
TIA/EIA 598-C

|            |             |
|------------|-------------|
| (1) BLUE   | (7) RED     |
| (2) ORANGE | (8) BLACK   |
| (3) GREEN  | (9) YELLOW  |
| (4) BROWN  | (10) VIOLET |
| (5) SLATE  | (11) ROSE   |
| (6) WHITE  | (12) AQUA   |

**LEGEND**

- X - FUSION SPLICE INDIVIDUAL FIBER
- - EXISTING SPLICE
- - EXPRESS INDIVIDUAL FIBER

EXPRESS: EXPRESS ENTIRE BUFFER TUBE  
SPLICE: SPLICE ENTIRE BUFFER TUBE OR MAINTAIN IF EXISTING EXPRESSED

**NOTES:**

- FIBER INTERCONNECT CENTER RACKS ARE SCHEMATIC ONLY - ACTUAL EQUIPMENT FORM MAY VARY.
- ETHERNET SWITCH TERMINATION CONFIGURATIONS ARE GENERIC. CONTRACTOR IS RESPONSIBLE FOR DETERMINING /ENSURING PROPER TERMINATION.
- CONTRACTOR IS RESPONSIBLE FOR FIELD VERIFYING EXISTING SPLICING. THE CONTRACTOR SHALL COORDINATE WITH THE ENGINEER WHERE EXISTING SPLICING IS NOT AS EXPECTED.

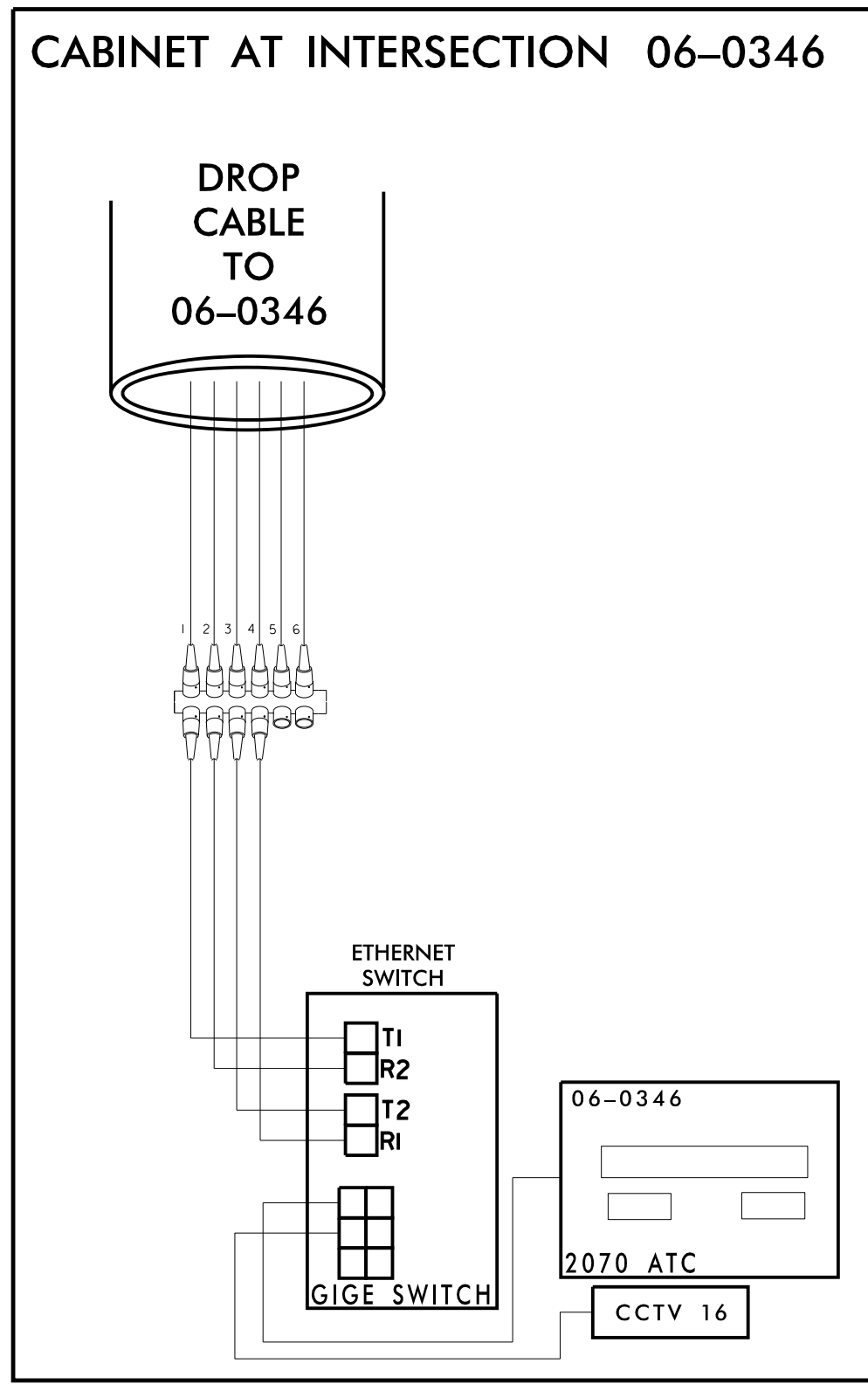
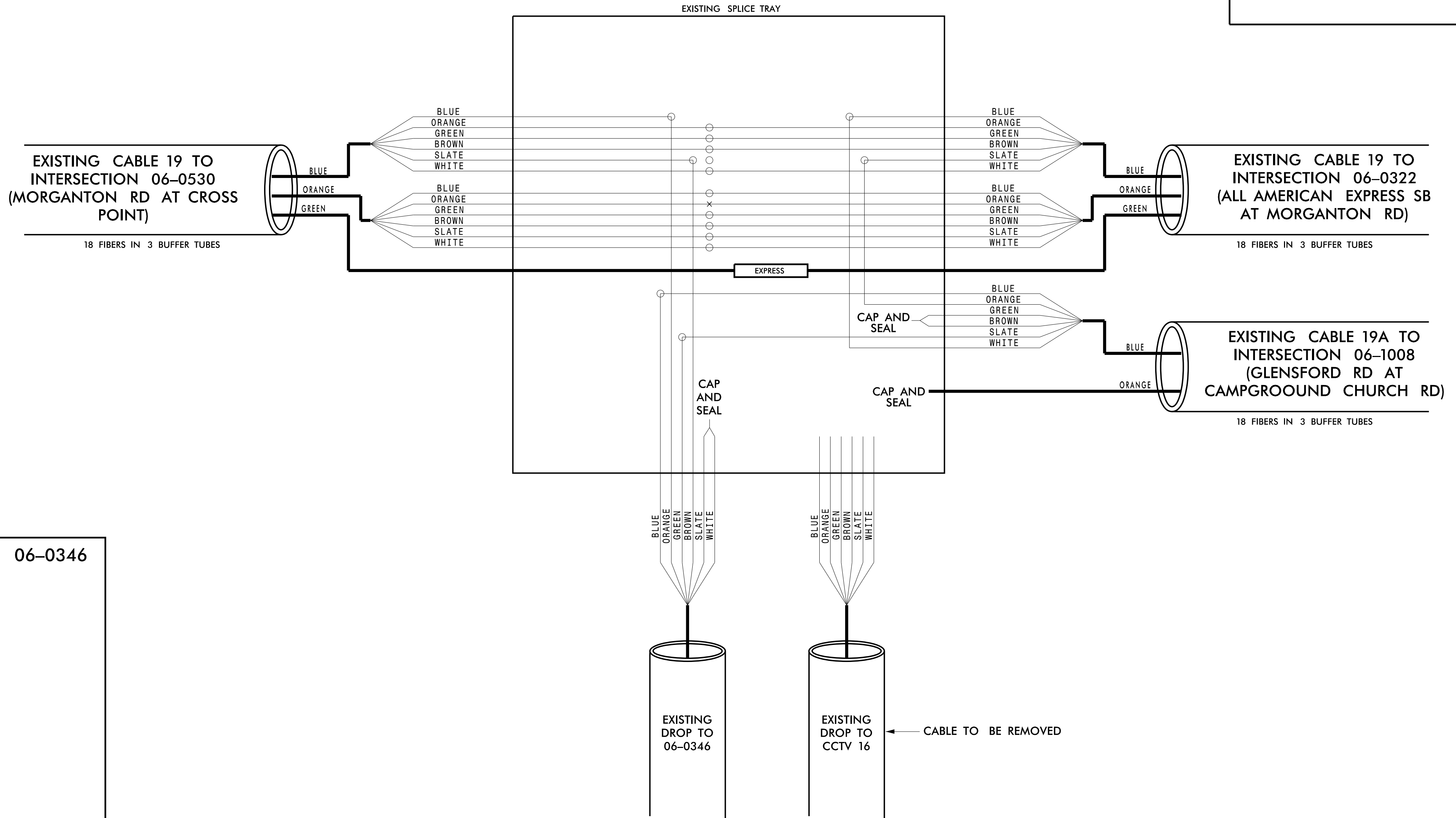

11/15/2016 K:\ARL\_TPTD\_ITS\01036305 - Fayetteville Sig Sys\Plans\Splicing\01036305-ITS\_psh\_210-CH9\_Harvest CCTV16 06-0346.dgn

**CHANNEL 19**

**FAYETTEVILLE COMPUTERIZED SIGNAL SYSTEM  
SPLICE DETAIL**

|                          |                              |                   |                         |
|--------------------------|------------------------------|-------------------|-------------------------|
| DIVISION 06              |                              | CUMBERLAND COUNTY |                         |
| PLAN DATE: NOVEMBER 2016 | REVIEWED BY: N.M. MENGELKOCH | PREPARED BY: KHA  | REVIEWED BY: K.W. SMITH |
| REVISIONS                | INIT.                        | DATE              |                         |

Kimley»Horn  
250 N. Greenfield Place, Garner, NC 27529  
NC License #F-0102  
421 Fayetteville St., Suite 600  
Raleigh, NC 27636  
Tel: (919) 677-2000  
Fax: (919) 677-2050

SEAL  
NORTH CAROLINA PROFESSIONAL ENGINEER  
SEAL 030472  
KEVIN W. SMITH  
11/15/2016

**CHANNEL 20**  
**EXISTING SPLICE ENCLOSURE**  
**(REILLY RD AT MORGANTON RD)**  
**SIG ID 06-0369**  
**CCTV 13**

**COLOR CODE**  
 TIA/EIA 598-C

|            |             |
|------------|-------------|
| (1) BLUE   | (7) RED     |
| (2) ORANGE | (8) BLACK   |
| (3) GREEN  | (9) YELLOW  |
| (4) BROWN  | (10) VIOLET |
| (5) SLATE  | (11) ROSE   |
| (6) WHITE  | (12) AQUA   |

**LEGEND**

X - FUSION SPLICE INDIVIDUAL FIBER  
 O - EXISTING SPLICE  
 □ - EXPRESS INDIVIDUAL FIBER

EXPRESS - EXPRESS ENTIRE BUFFER TUBE  
 SPLICE - SPLICE ENTIRE BUFFER TUBE OR MAINTAIN IF EXISTING EXPRESSED

**NOTES:**

- FIBER INTERCONNECT CENTER RACKS ARE SCHEMATIC ONLY - ACTUAL EQUIPMENT FORM MAY VARY.
- ETHERNET SWITCH TERMINATION CONFIGURATIONS ARE GENERIC. CONTRACTOR IS RESPONSIBLE FOR DETERMINING /ENSURING PROPER TERMINATION.
- CONTRACTOR IS RESPONSIBLE FOR FIELD VERIFYING EXISTING SPLICING. THE CONTRACTOR SHALL COORDINATE WITH THE ENGINEER WHERE EXISTING SPLICING IS NOT AS EXPECTED.

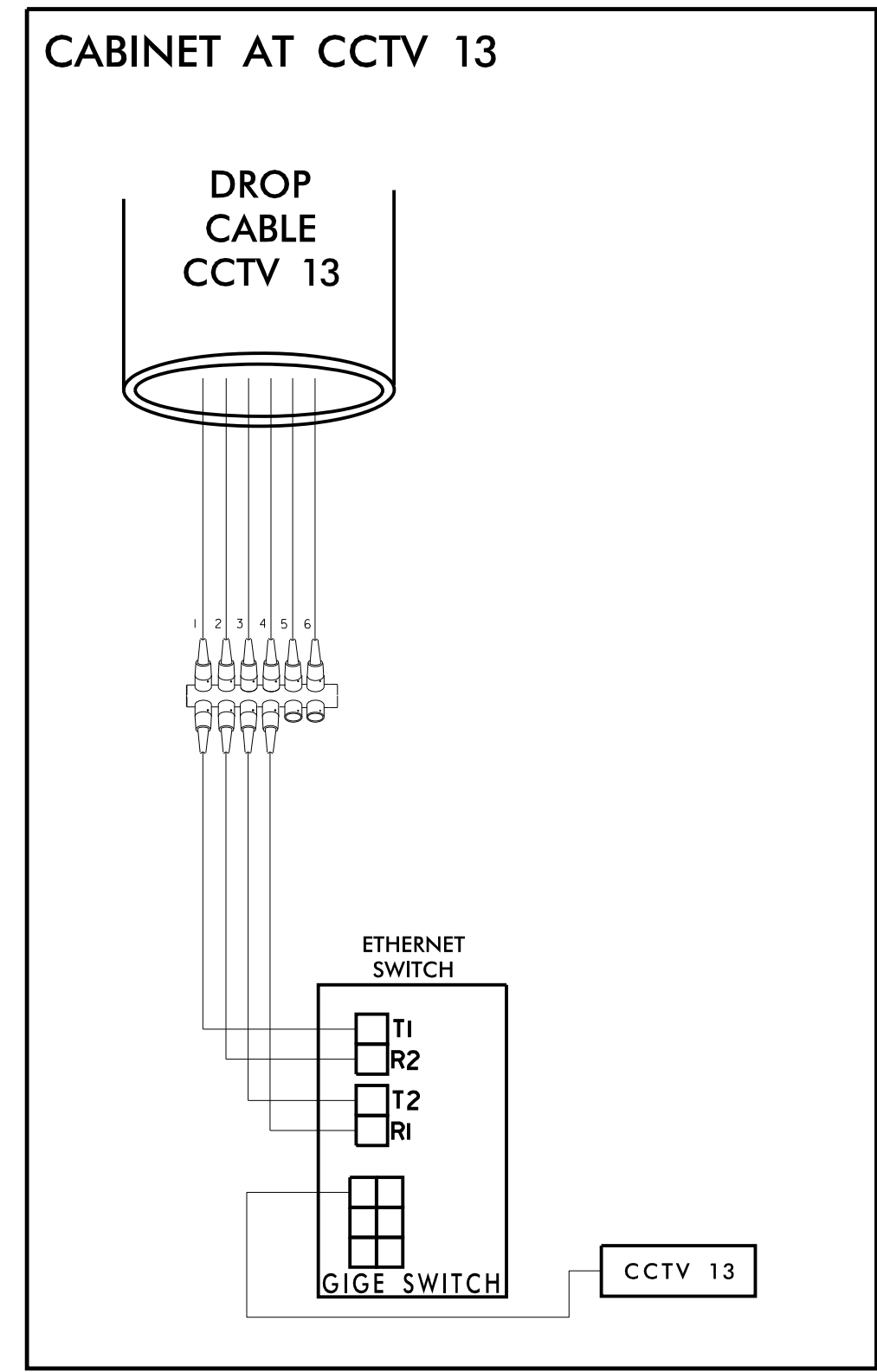
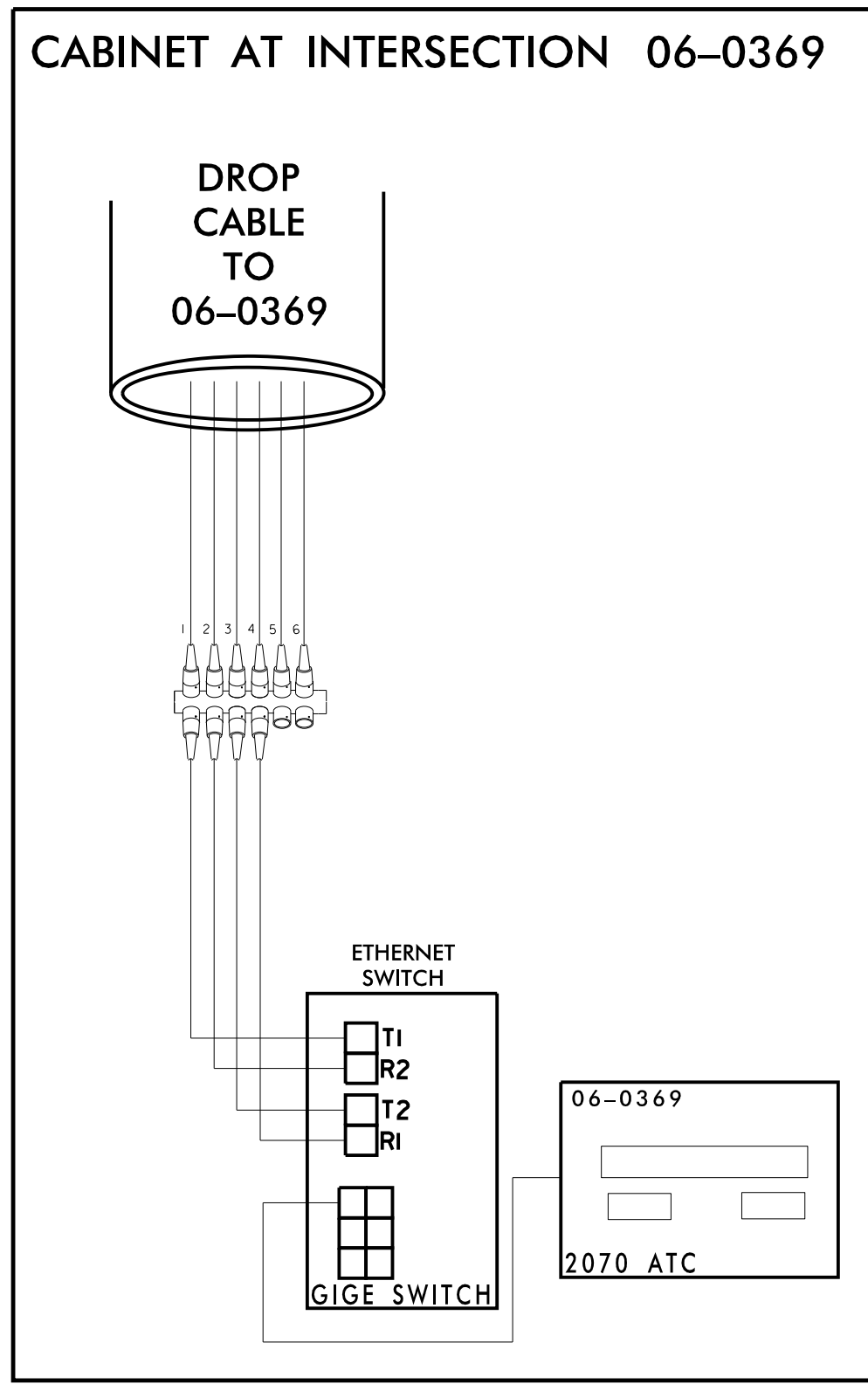
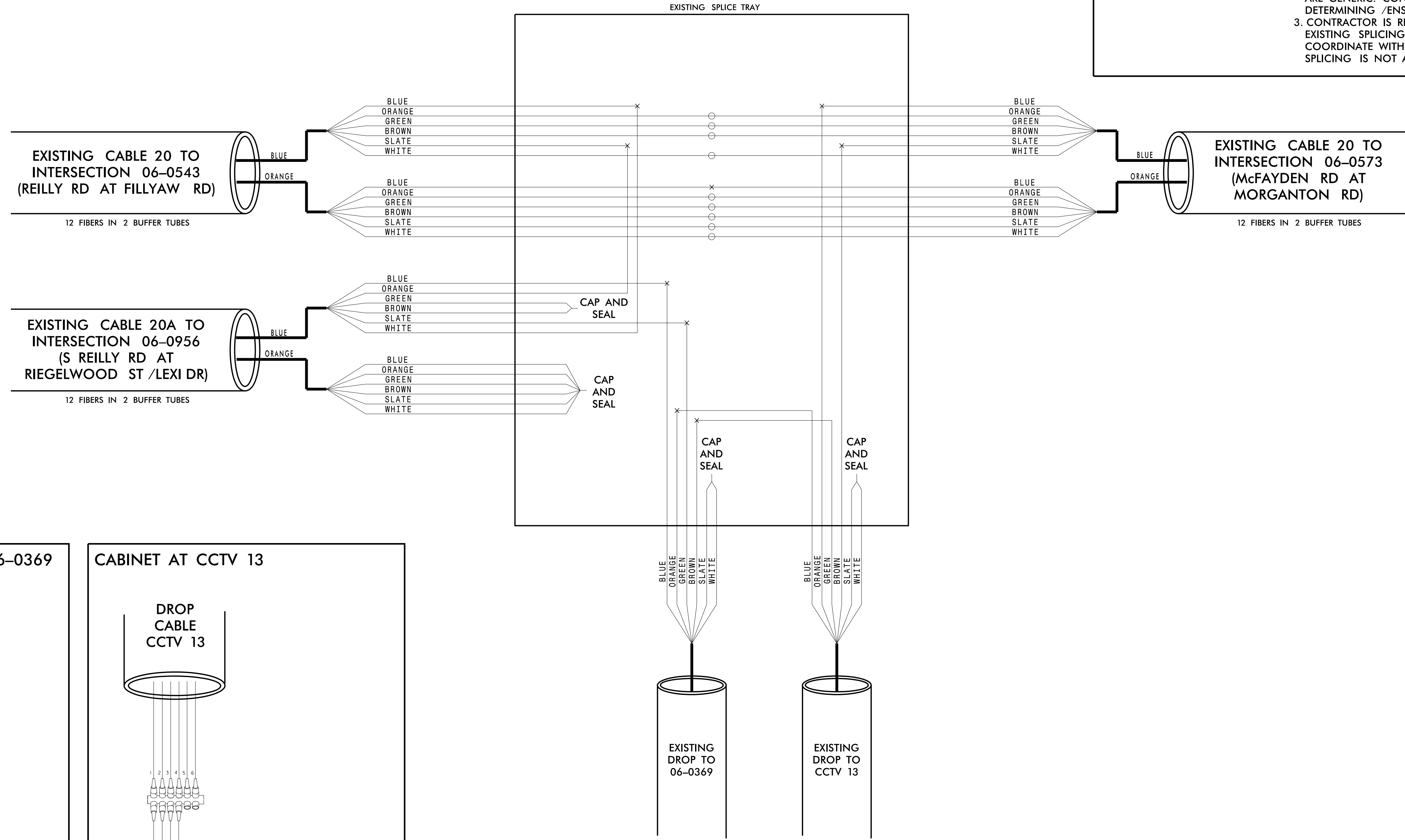

**CHANNEL 20**

**FAYETTEVILLE COMPUTERIZED SIGNAL SYSTEM**  
**SPLICE DETAIL**

|                          |                               |                   |                          |
|--------------------------|-------------------------------|-------------------|--------------------------|
| DIVISION 06              |                               | CUMBERLAND COUNTY |                          |
| PLAN DATE: NOVEMBER 2016 | REVIEWED BY: N. M. MENGELKOCH | PREPARED BY: KHA  | REVIEWED BY: K. W. SMITH |
| REVISIONS                | INIT.                         | DATE              |                          |

KEVIN W. SMITH  
 11/15/2016  
 CADD Filename:

**Kimley»Horn**  
 NC License #F-0102  
 421 Fayetteville St., Suite 600  
 Raleigh, NC 27636  
 Tel: (919) 677-2000  
 Fax: (919) 677-2050

11/15/2016 K:\ARL\TPTD\ITS\01036305 - Fayetteville Sig Sys\Plans\Splicing\01036305-ITS-psr-211-CH20 CCTV13 Harvest 06-0369.dgn

**CHANNEL 21**  
**EXISTING SPLICE ENCLOSURE**  
**(HOPE MILLS RD /GLENSFORD RD**  
**AT RAEFORD RD)**  
**SIG ID 06-0155**  
**CCTV 5**

**COLOR CODE**  
 TIA/EIA 598-C

|            |             |
|------------|-------------|
| (1) BLUE   | (7) RED     |
| (2) ORANGE | (8) BLACK   |
| (3) GREEN  | (9) YELLOW  |
| (4) BROWN  | (10) VIOLET |
| (5) SLATE  | (11) ROSE   |
| (6) WHITE  | (12) AQUA   |

**LEGEND**

- X - FUSION SPLICE INDIVIDUAL FIBER
- - EXISTING SPLICE
- - EXPRESS INDIVIDUAL FIBER

EXPRESS: EXPRESS ENTIRE BUFFER TUBE  
 SPLICE: SPLICE ENTIRE BUFFER TUBE OR MAINTAIN IF EXISTING EXPRESSED

**NOTES:**

- FIBER INTERCONNECT CENTER RACKS ARE SCHEMATIC ONLY - ACTUAL EQUIPMENT FORM MAY VARY.
- ETHERNET SWITCH TERMINATION CONFIGURATIONS ARE GENERIC. CONTRACTOR IS RESPONSIBLE FOR DETERMINING /ENSURING PROPER TERMINATION.
- CONTRACTOR IS RESPONSIBLE FOR FIELD VERIFYING EXISTING SPLICING. THE CONTRACTOR SHALL COORDINATE WITH THE ENGINEER WHERE EXISTING SPLICING IS NOT AS EXPECTED.

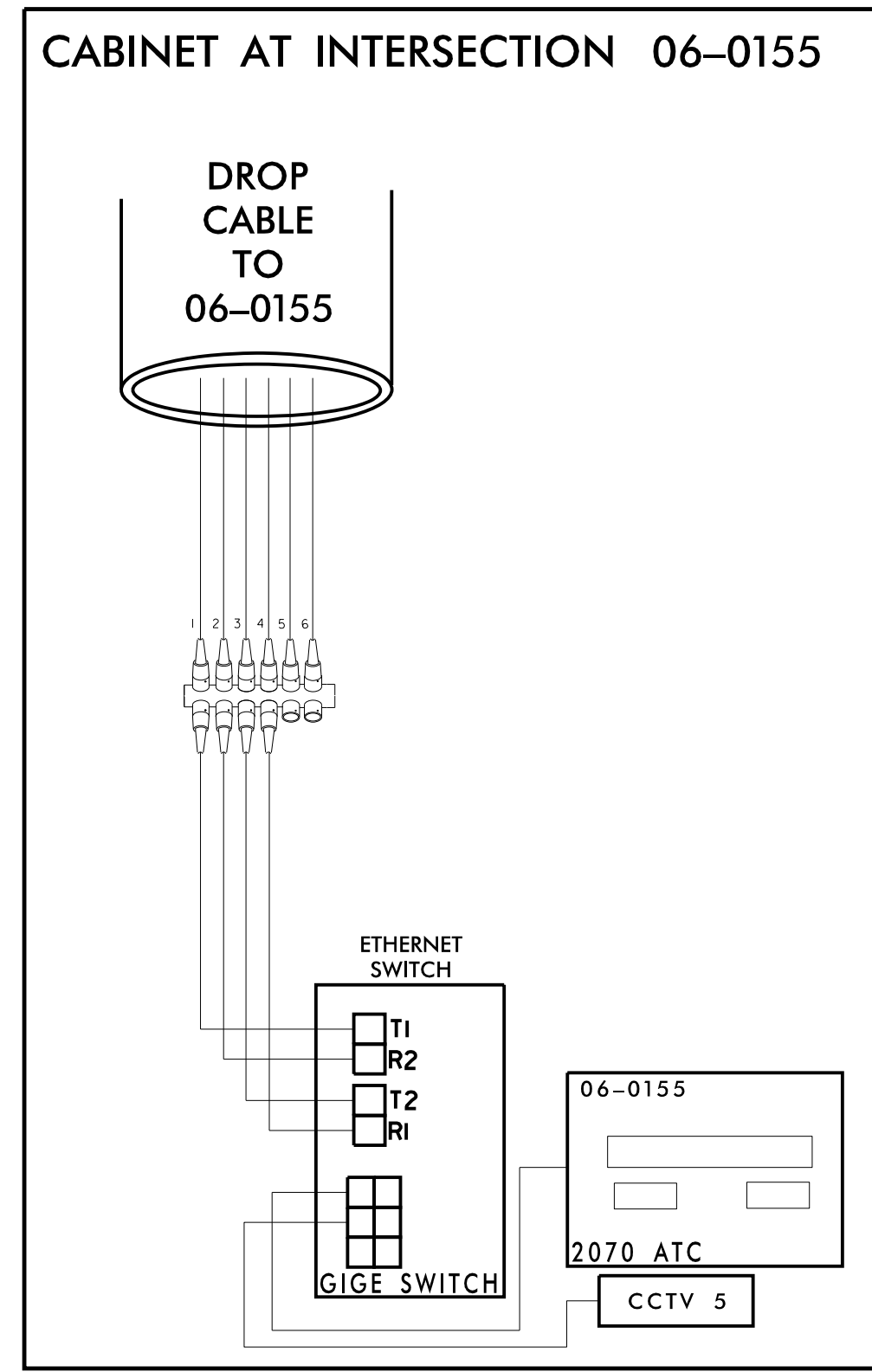
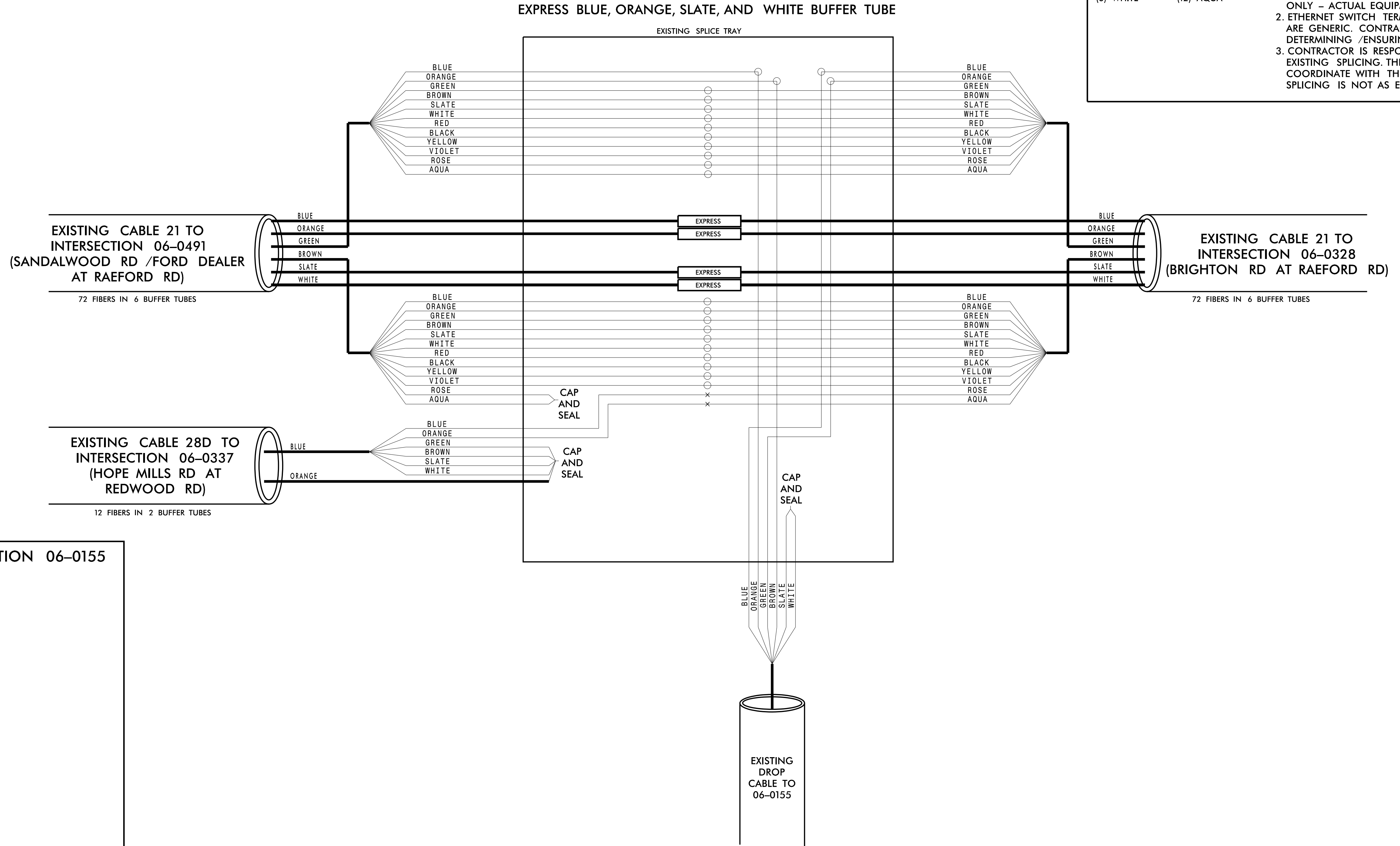

**CHANNEL 21**

**FAYETTEVILLE COMPUTERIZED SIGNAL SYSTEM**

**SPLICE DETAIL**

|                          |                               |                   |                          |
|--------------------------|-------------------------------|-------------------|--------------------------|
| DIVISION 06              |                               | CUMBERLAND COUNTY |                          |
| PLAN DATE: NOVEMBER 2016 | REVIEWED BY: N. M. MENGELKOCH | PREPARED BY: KHA  | REVIEWED BY: K. W. SMITH |
| REVISIONS                |                               | INIT.             | DATE                     |
|                          |                               |                   |                          |

**Kimley Horn**  
 NC License #F-0102  
 421 Fayetteville St., Suite 600  
 Raleigh, NC 27636  
 Tel: (919) 677-2000  
 Fax: (919) 677-2050

SCALE

0

SEAL  
 NORTH CAROLINA PROFESSIONAL ENGINEER  
 KEVIN W. SMITH  
 030472

11/15/2016  
 DATE  
 SIGNATURE  
 CADD Filename:

11/15/2016 K:\ARL\TPTD\ITS\01036305 - Fayetteville Sig Sys\Plans\Splicing\01036305-ITS\_psh\_212-CH2\CCTV5 Harvest at 06-0155.dgn



**CHANNEL 21**  
**EXISTING SPLICE ENCLOSURE**  
**(US 401 BYPASS AT RAEFORD RD)**  
**SIG ID 06-0096**  
**CCTV 1**

**COLOR CODE**  
 TIA/EIA 598-C

|            |             |
|------------|-------------|
| (1) BLUE   | (7) RED     |
| (2) ORANGE | (8) BLACK   |
| (3) GREEN  | (9) YELLOW  |
| (4) BROWN  | (10) VIOLET |
| (5) SLATE  | (11) ROSE   |
| (6) WHITE  | (12) AQUA   |

**LEGEND**

- X - FUSION SPLICE INDIVIDUAL FIBER
- O - EXISTING SPLICE
- - EXPRESS INDIVIDUAL FIBER

EXPRESS: EXPRESS ENTIRE BUFFER TUBE  
 SPLICE: SPLICE ENTIRE BUFFER TUBE OR MAINTAIN IF EXISTING EXPRESSED

**NOTES:**

- FIBER INTERCONNECT CENTER RACKS ARE SCHEMATIC ONLY - ACTUAL EQUIPMENT FORM MAY VARY.
- ETHERNET SWITCH TERMINATION CONFIGURATIONS ARE GENERIC. CONTRACTOR IS RESPONSIBLE FOR DETERMINING /ENSURING PROPER TERMINATION.
- CONTRACTOR IS RESPONSIBLE FOR FIELD VERIFYING EXISTING SPICING. THE CONTRACTOR SHALL COORDINATE WITH THE ENGINEER WHERE EXISTING SPICING IS NOT AS EXPECTED.

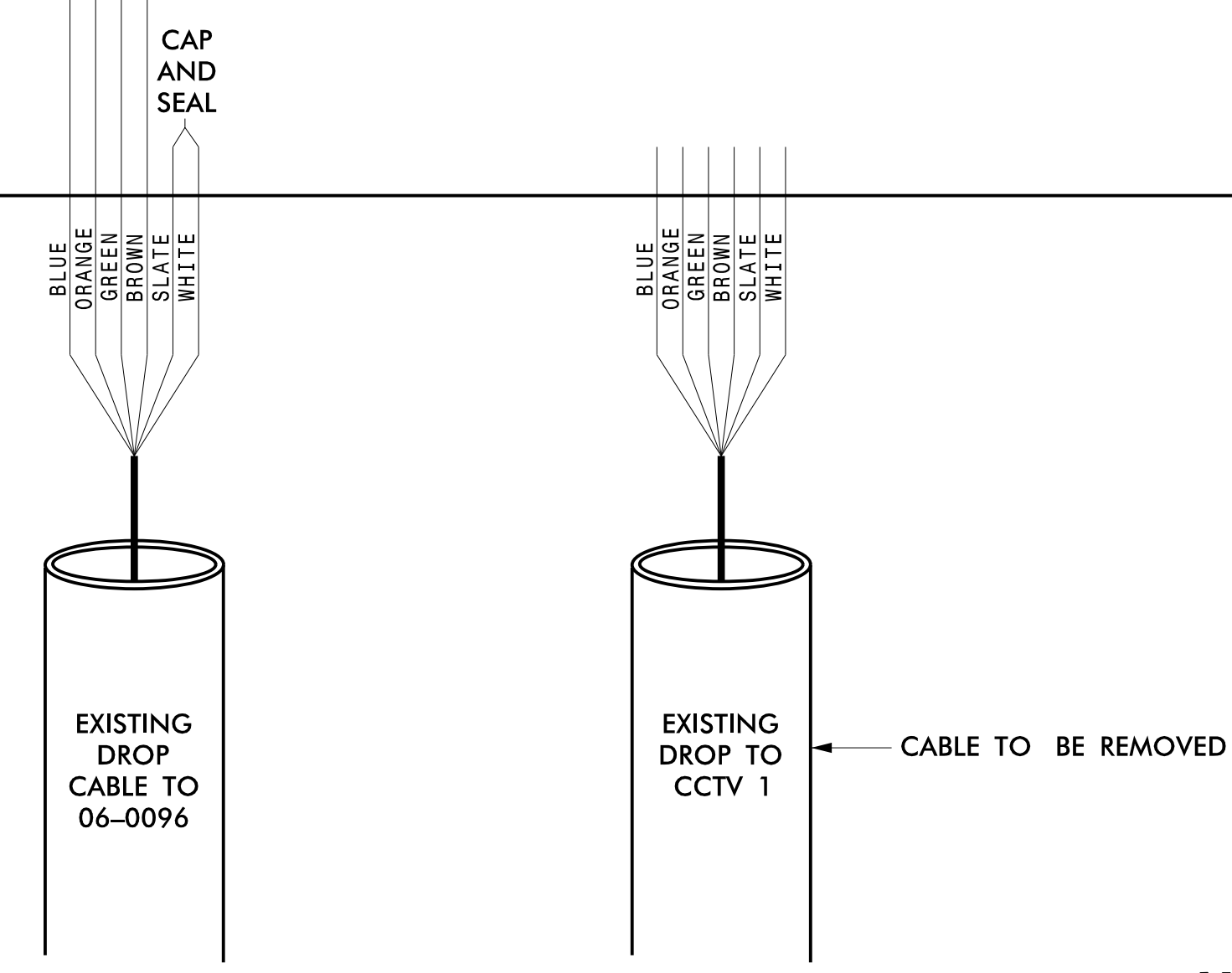
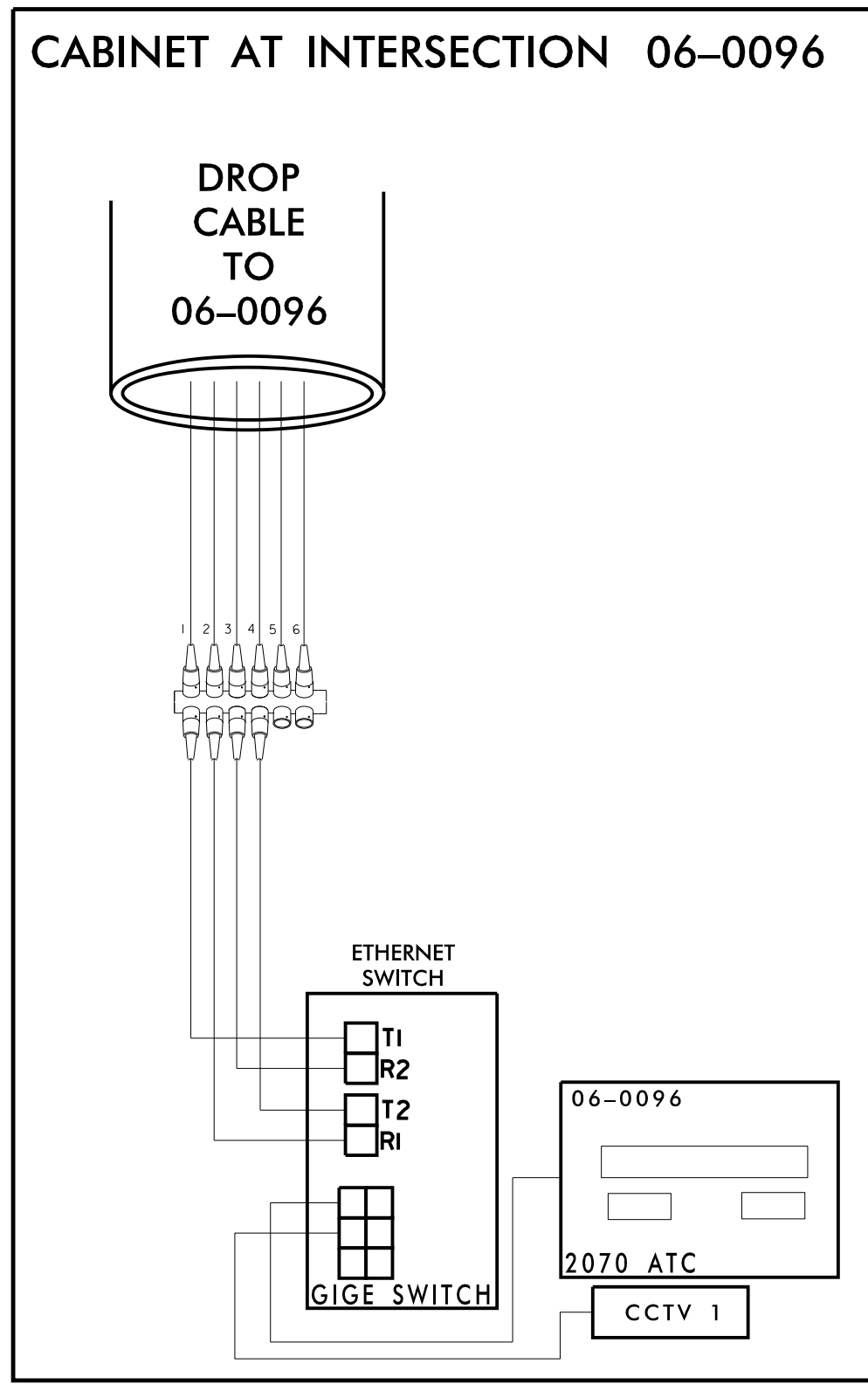
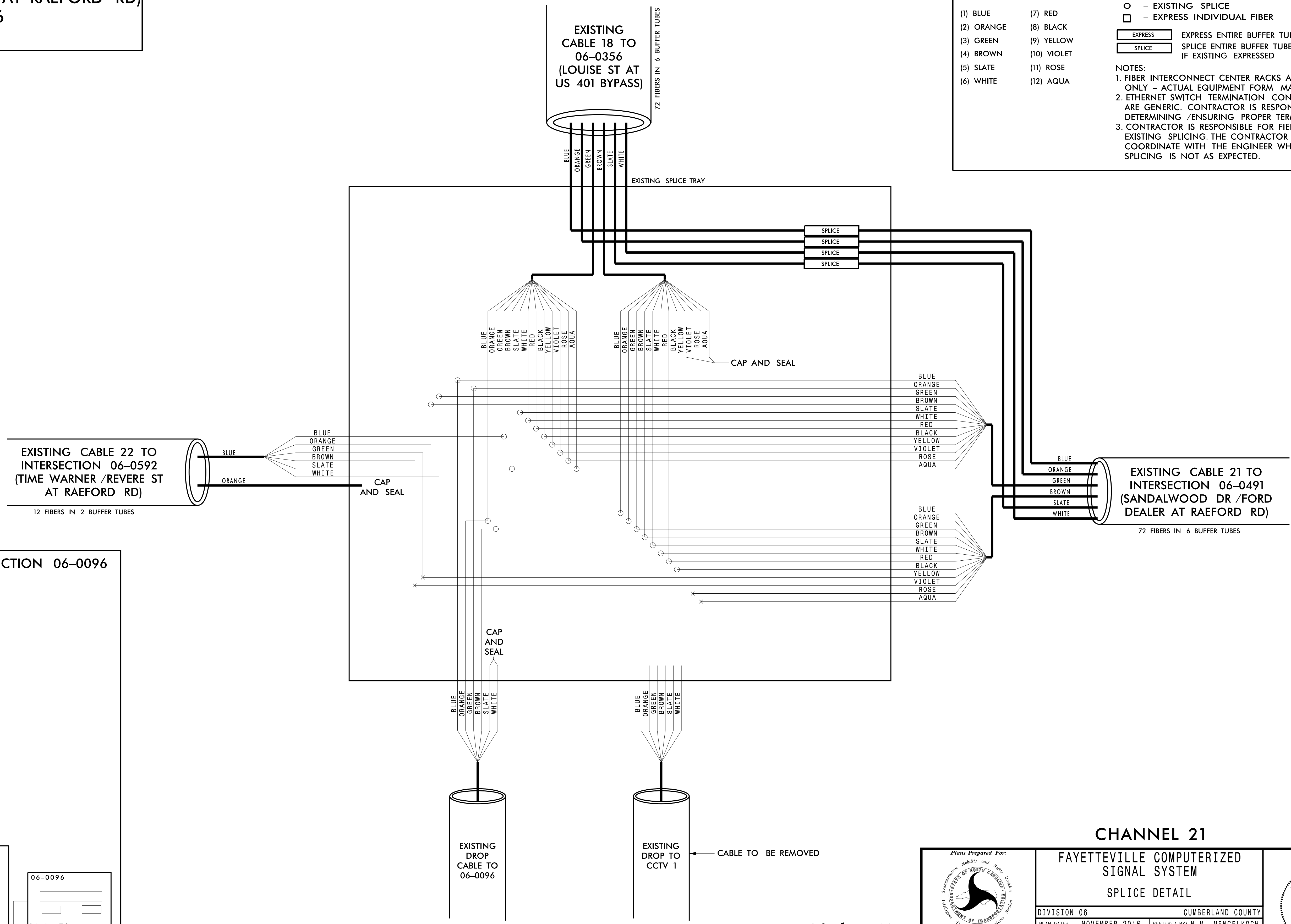

**CHANNEL 21**

**FAYETTEVILLE COMPUTERIZED SIGNAL SYSTEM**

**SPLICE DETAIL**

DIVISION 06 CUMBERLAND COUNTY

PLAN DATE: NOVEMBER 2016 REVIEWED BY: N.M. MENGELKOCH

PREPARED BY: KHA REVIEWED BY: K.W. SMITH

SCALE: 0

REVISIONS: INIT. DATE

SEAL: NORTH CAROLINA PROFESSIONAL ENGINEER KEVIN W. SMITH SEAL 030472

Signature: Kevin Smith DATE: 11/15/2016

CADD File name:

**Kimley»Horn**

NC License #F-0102  
 421 Fayetteville St., Suite 600  
 Raleigh, NC 27636  
 Tel: (919) 677-2000  
 Fax: (919) 677-2050

11/15/2016 KARAL\_TPTD\_ITS\_01036305 - Fayetteville Sig Sys\Plans\Splicing\01036305-ITS\_psh-213-CH2\CCTV1\Harvest at 06-0096.dgn

**CHANNEL 22  
EXISTING SPLICE ENCLOSURE  
(BUNCE RD AT RAEFORD RD)  
SIG ID 06-0274  
CCTV 21**

| COLOR CODE<br>TIA/EIA 598-C |             | LEGEND  |   |
|-----------------------------|-------------|---------|---|
| (1) BLUE                    | (7) RED     | X       | - FUSION SPLICE INDIVIDUAL FIBER                            |
| (2) ORANGE                  | (8) BLACK   | O       | - EXISTING SPLICE   |
| (3) GREEN                   | (9) YELLOW  | □       | - EXPRESS INDIVIDUAL FIBER                                  |
| (4) BROWN                   | (10) VIOLET | EXPRESS | EXPRESS ENTIRE BUFFER TUBE                                  |
| (5) SLATE                   | (11) ROSE   | SPLICE  | SPLICE ENTIRE BUFFER TUBE OR MAINTAIN IF EXISTING EXPRESSED |
| (6) WHITE                   | (12) AQUA   |         |   |

**NOTES:**  
 1. FIBER INTERCONNECT CENTER RACKS ARE SCHEMATIC ONLY - ACTUAL EQUIPMENT FORM MAY VARY.  
 2. ETHERNET SWITCH TERMINATION CONFIGURATIONS ARE GENERIC. CONTRACTOR IS RESPONSIBLE FOR DETERMINING /ENSURING PROPER TERMINATION.  
 3. CONTRACTOR IS RESPONSIBLE FOR FIELD VERIFYING EXISTING SPLICING. THE CONTRACTOR SHALL COORDINATE WITH THE ENGINEER WHERE EXISTING SPLICING IS NOT AS EXPECTED.

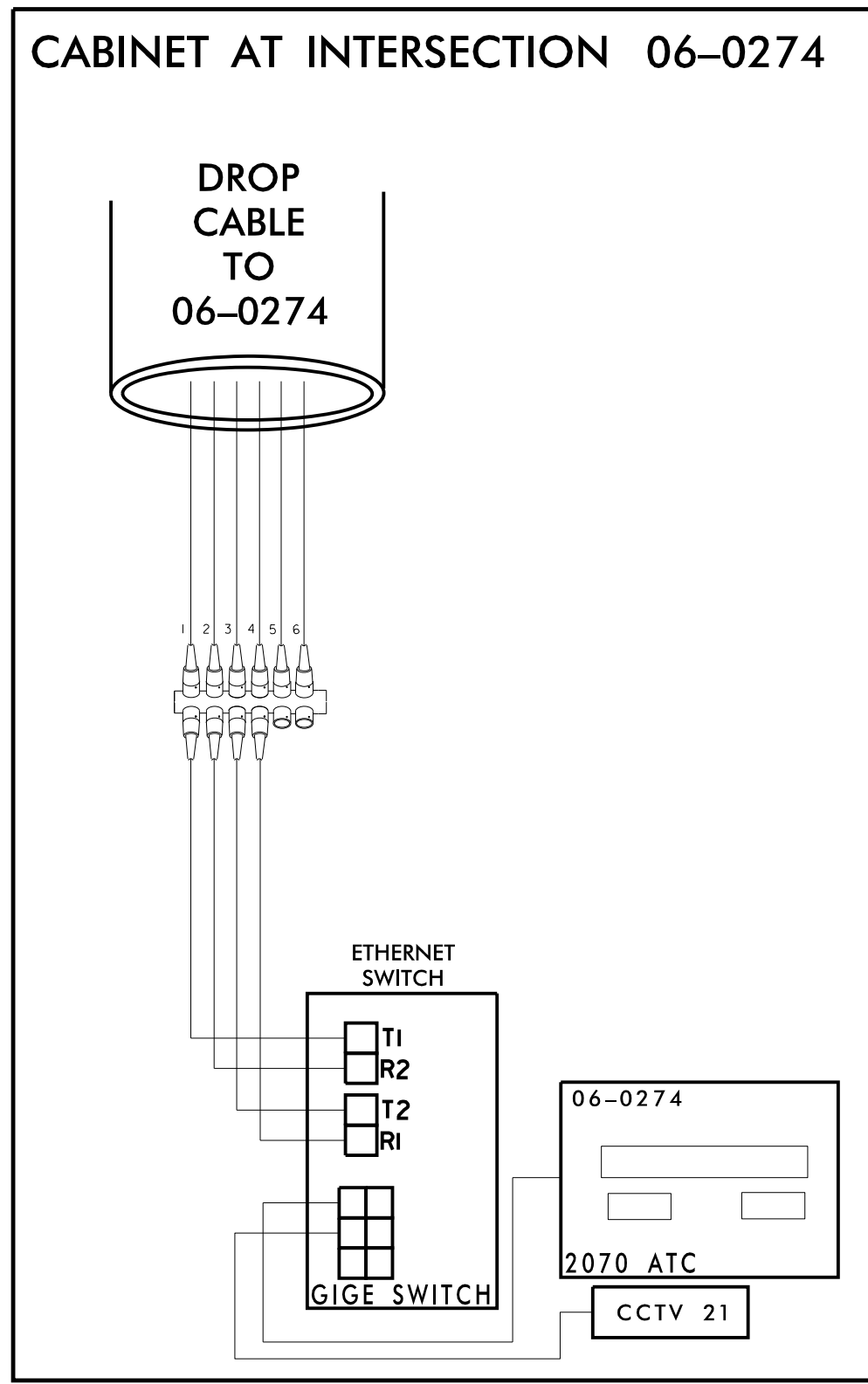
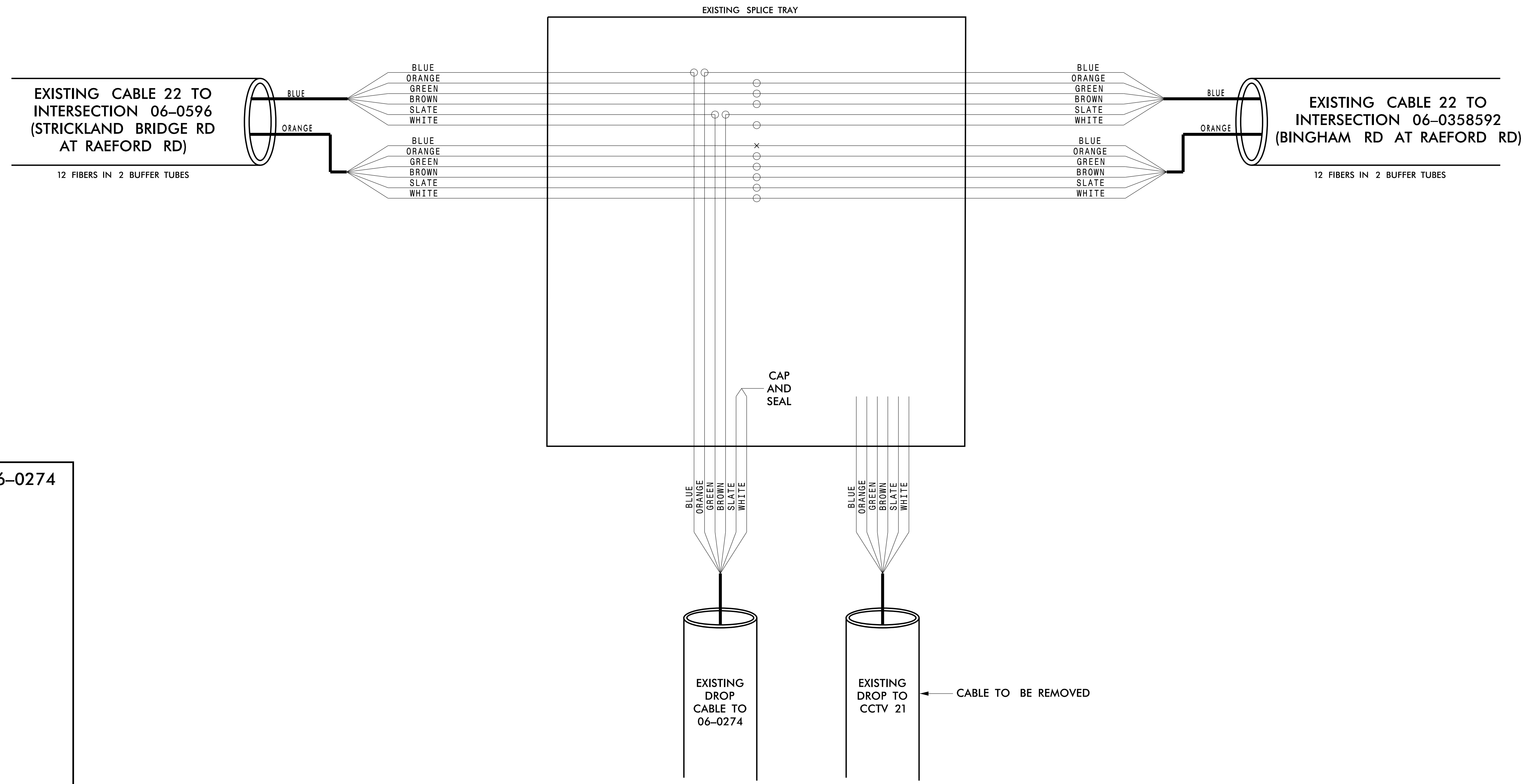

**CHANNEL 22**

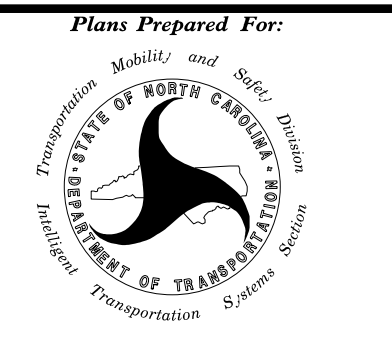
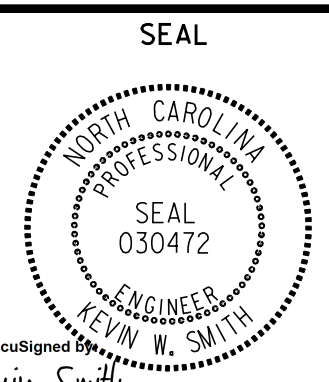
|   |                               |   |
|---|-------------------------------|---|
| <br>Plans Prepared For:<br><b>FAYETTEVILLE COMPUTERIZED SIGNAL SYSTEM</b><br>SPLICE DETAIL |                               | SEAL<br><br>KEVIN W. SMITH<br>ENGINEER |
| DIVISION 06      CUMBERLAND COUNTY  |                               |   |
| PLAN DATE: NOVEMBER 2016  | REVIEWED BY: N. M. MENGELKOCH |   |
| PREPARED BY: KHA  | REVIEWED BY: K. W. SMITH      |   |
| REVISIONS   | INIT.                         | DATE  |
|   |                               |   |
| SCALE<br>0  |                               | 11/15/2016<br>SIGNATURE: <i>Kevin W. Smith</i><br>DATE<br>CADD Filename:  |

**Kimley»Horn**  
 NC License #F-0102  
 421 Fayetteville St., Suite 600  
 Raleigh, NC 27636  
 Tel: (919) 677-2000  
 Fax: (919) 677-2050

11/15/2016 K:\ARL\TPTD\ITS\01036305 - Fayetteville Sig Sys\Plans\Splicing\01036305-ITS\_psh\_214-CH22\_06-0358.dgn

**CHANNEL 23**  
**EXISTING SPLICE ENCLOSURE**  
**(SEVENTY FIRST SCHOOL RD /**  
**SHOPPING CENTER AT CLIFFDALE RD)**  
**SIG ID 06-0541**  
**CCTV 22**

**COLOR CODE**  
 TIA/EIA 598-C

|            |             |
|------------|-------------|
| (1) BLUE   | (7) RED     |
| (2) ORANGE | (8) BLACK   |
| (3) GREEN  | (9) YELLOW  |
| (4) BROWN  | (10) VIOLET |
| (5) SLATE  | (11) ROSE   |
| (6) WHITE  | (12) AQUA   |

**LEGEND**

X - FUSION SPLICE INDIVIDUAL FIBER  
 O - EXISTING SPLICE  
 □ - EXPRESS INDIVIDUAL FIBER

EXPRESS - EXPRESS ENTIRE BUFFER TUBE  
 SPLICE - SPLICE ENTIRE BUFFER TUBE OR MAINTAIN IF EXISTING EXPRESSED

**NOTES:**

- FIBER INTERCONNECT CENTER RACKS ARE SCHEMATIC ONLY - ACTUAL EQUIPMENT FORM MAY VARY.
- ETHERNET SWITCH TERMINATION CONFIGURATIONS ARE GENERIC. CONTRACTOR IS RESPONSIBLE FOR DETERMINING /ENSURING PROPER TERMINATION.
- CONTRACTOR IS RESPONSIBLE FOR FIELD VERIFYING EXISTING SPLICING. THE CONTRACTOR SHALL COORDINATE WITH THE ENGINEER WHERE EXISTING SPLICING IS NOT AS EXPECTED.

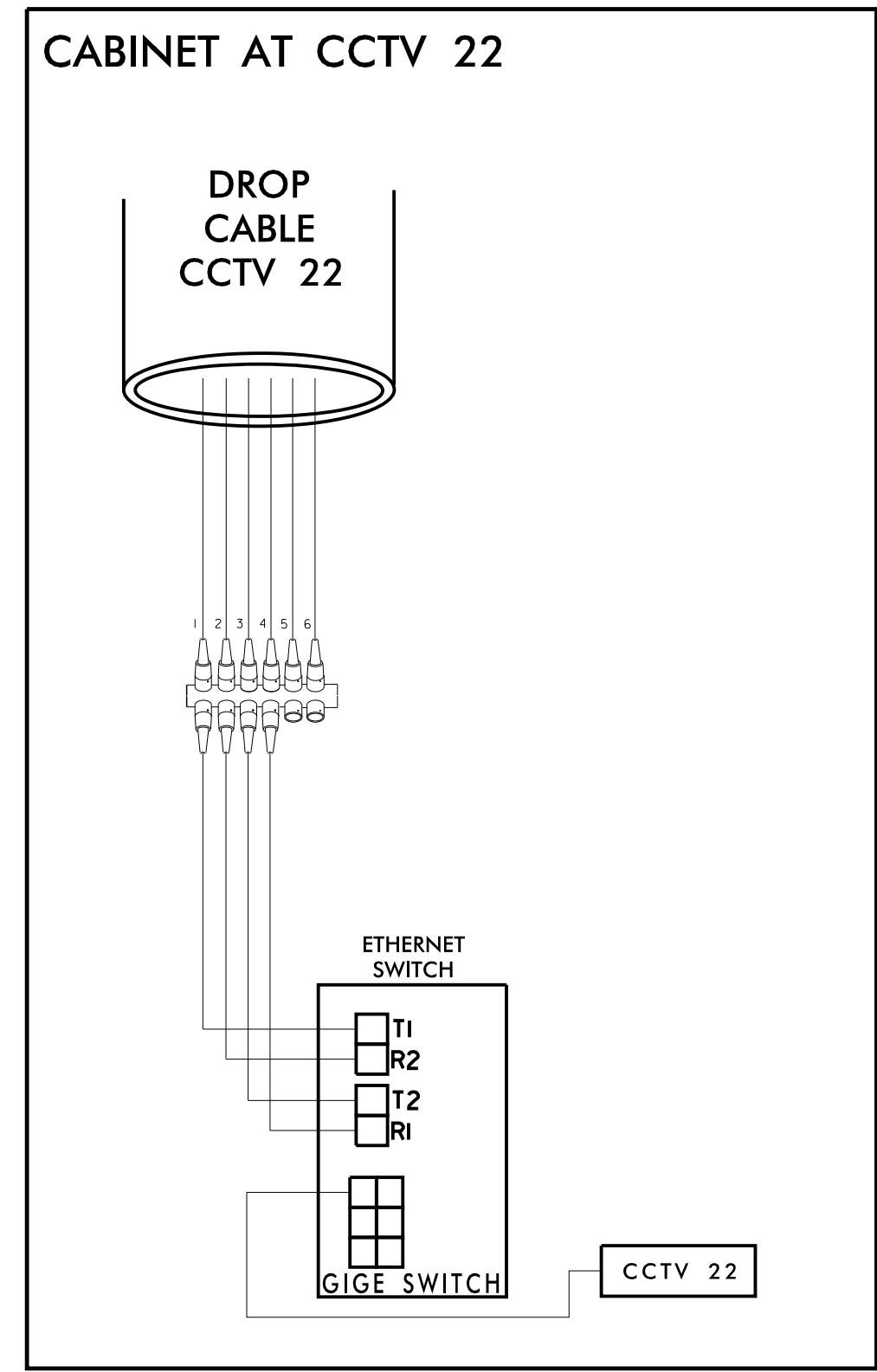
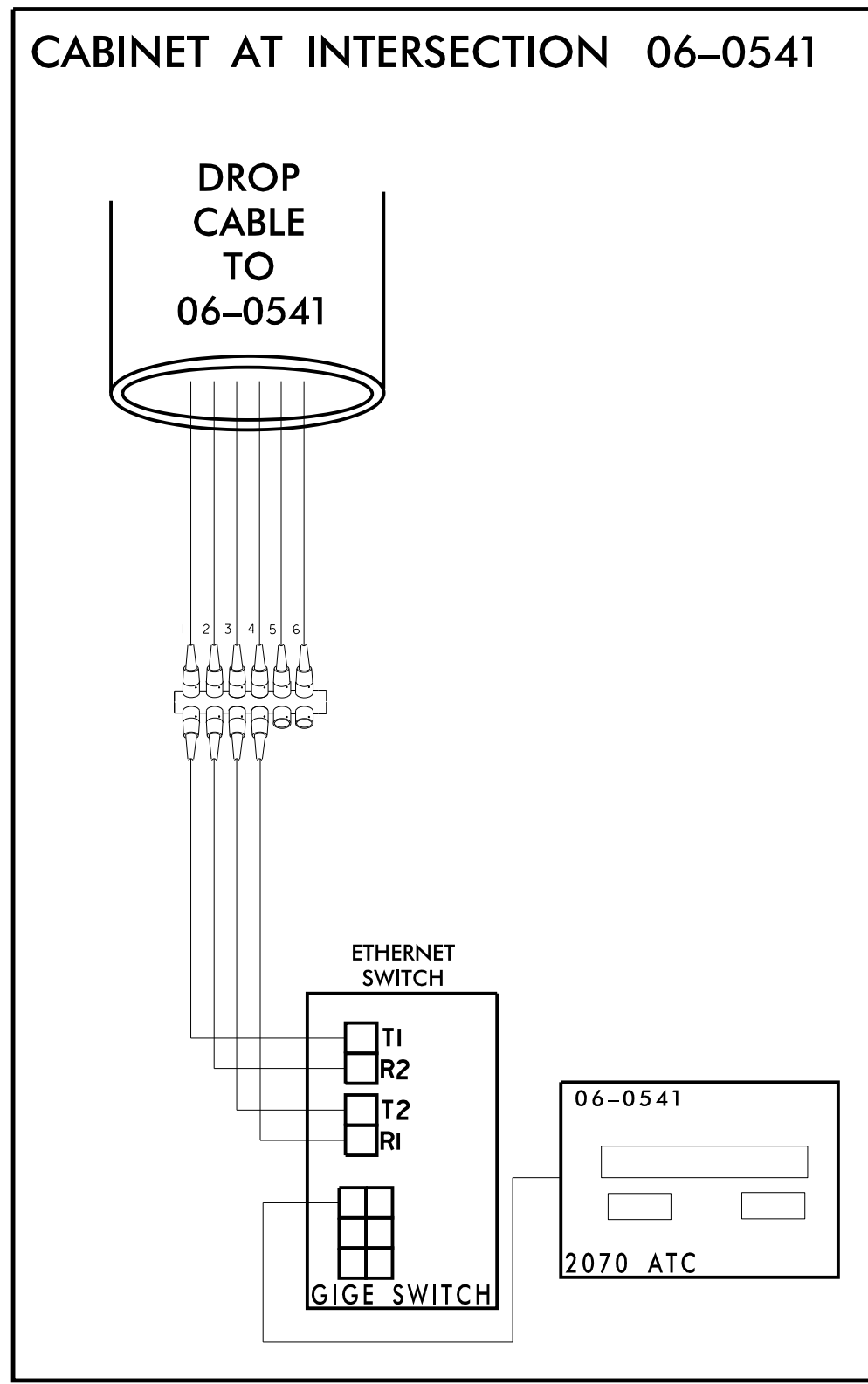
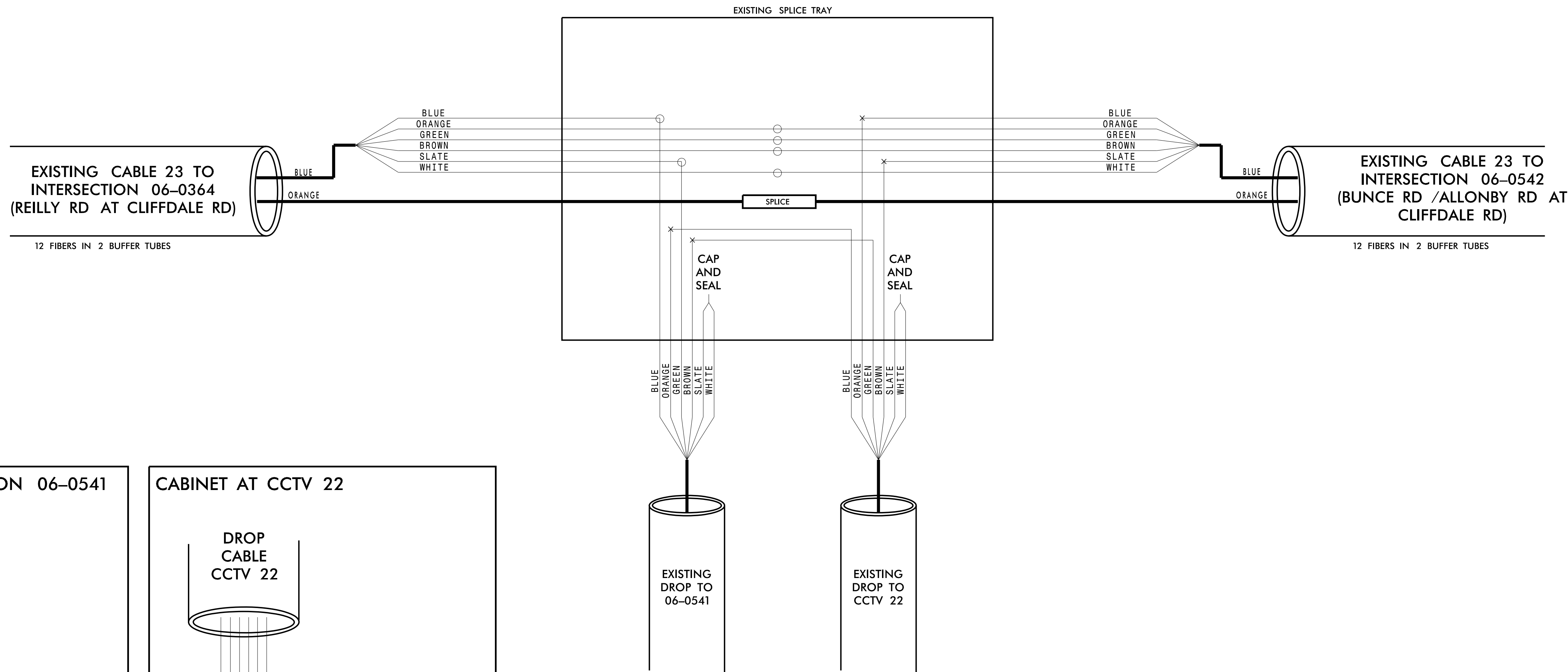

11/15/2016 K:\ARL\TPTD\ITS\01036305 - Fayetteville Sig Sys\Plans\Splicing\01036305-ITS-CH23-06-0541\CCTV22.dgn

**CHANNEL 23**

**FAYETTEVILLE COMPUTERIZED SIGNAL SYSTEM**  
**SPLICE DETAIL**

DIVISION 06 CUMBERLAND COUNTY

PLAN DATE: NOVEMBER 2016 REVIEWED BY: N. M. MENGELKOCH

PREPARED BY: KHA REVIEWED BY: K. W. SMITH

SCALE: 0

**Kimley»Horn**  
 NC License #F-0102  
 421 Fayetteville St., Suite 600  
 Raleigh, NC 27636  
 Tel: (919) 677-2000  
 Fax: (919) 677-2050

**SEAL**  
 NORTH CAROLINA PROFESSIONAL ENGINEER  
 KEVIN W. SMITH  
 SEAL 030472  
 11/15/2016

**CHANNEL 23**  
**EXISTING SPLICE ENCLOSURE**  
**(REILLY RD AT CLIFFDALE RD)**  
**SIG ID 06-0364**

**COLOR CODE**  
 TIA/EIA 598-C

|            |             |
|------------|-------------|
| (1) BLUE   | (7) RED     |
| (2) ORANGE | (8) BLACK   |
| (3) GREEN  | (9) YELLOW  |
| (4) BROWN  | (10) VIOLET |
| (5) SLATE  | (11) ROSE   |
| (6) WHITE  | (12) AQUA   |

**LEGEND**

X - FUSION SPLICE INDIVIDUAL FIBER  
 O - EXISTING SPLICE  
 □ - EXPRESS INDIVIDUAL FIBER

EXPRESS - EXPRESS ENTIRE BUFFER TUBE  
 SPLICE - SPLICE ENTIRE BUFFER TUBE OR MAINTAIN IF EXISTING EXPRESSED

**NOTES:**

- FIBER INTERCONNECT CENTER RACKS ARE SCHEMATIC ONLY - ACTUAL EQUIPMENT FORM MAY VARY.
- ETHERNET SWITCH TERMINATION CONFIGURATIONS ARE GENERIC. CONTRACTOR IS RESPONSIBLE FOR DETERMINING /ENSURING PROPER TERMINATION.
- CONTRACTOR IS RESPONSIBLE FOR FIELD VERIFYING EXISTING SPLICING. THE CONTRACTOR SHALL COORDINATE WITH THE ENGINEER WHERE EXISTING SPLICING IS NOT AS EXPECTED.

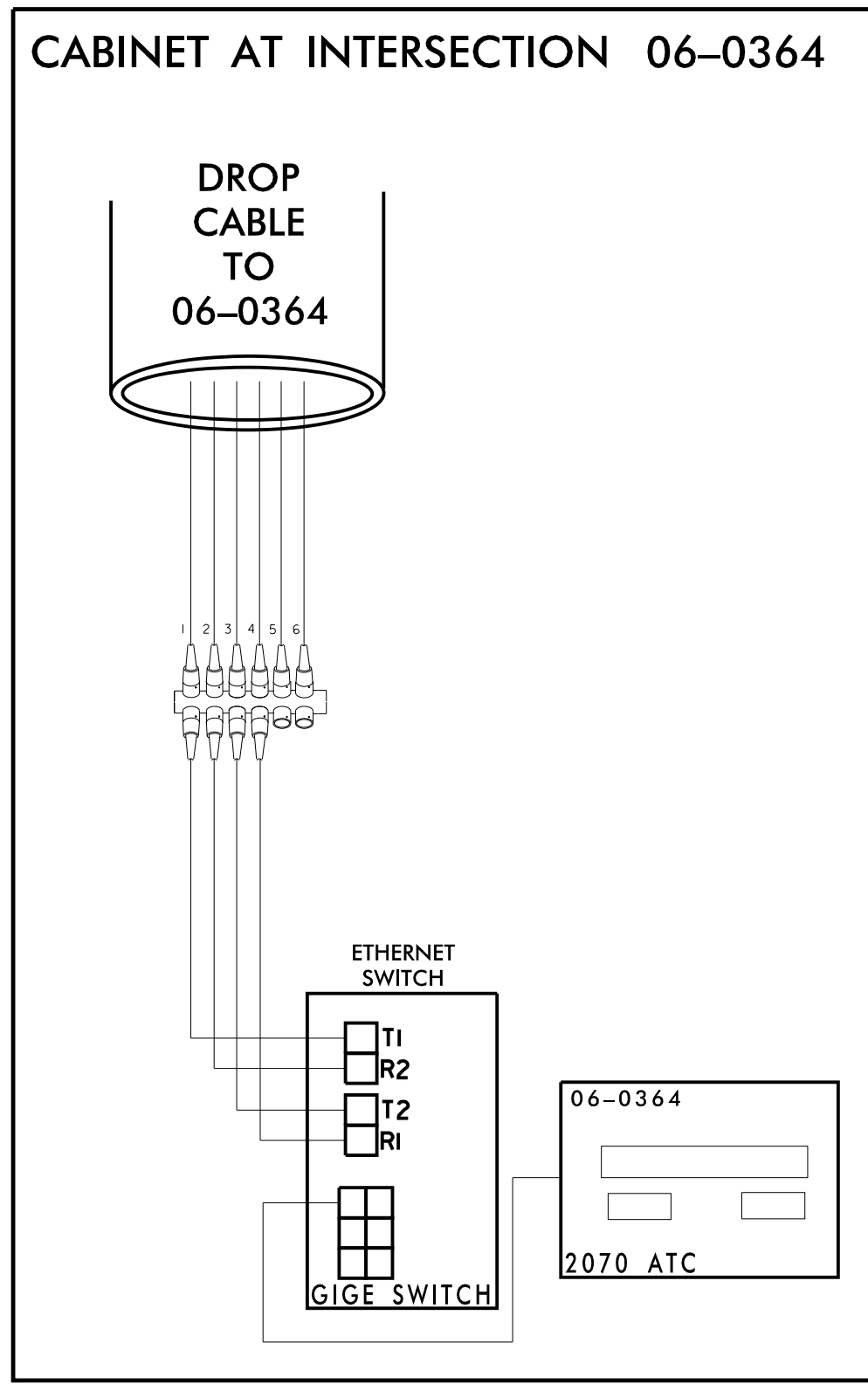
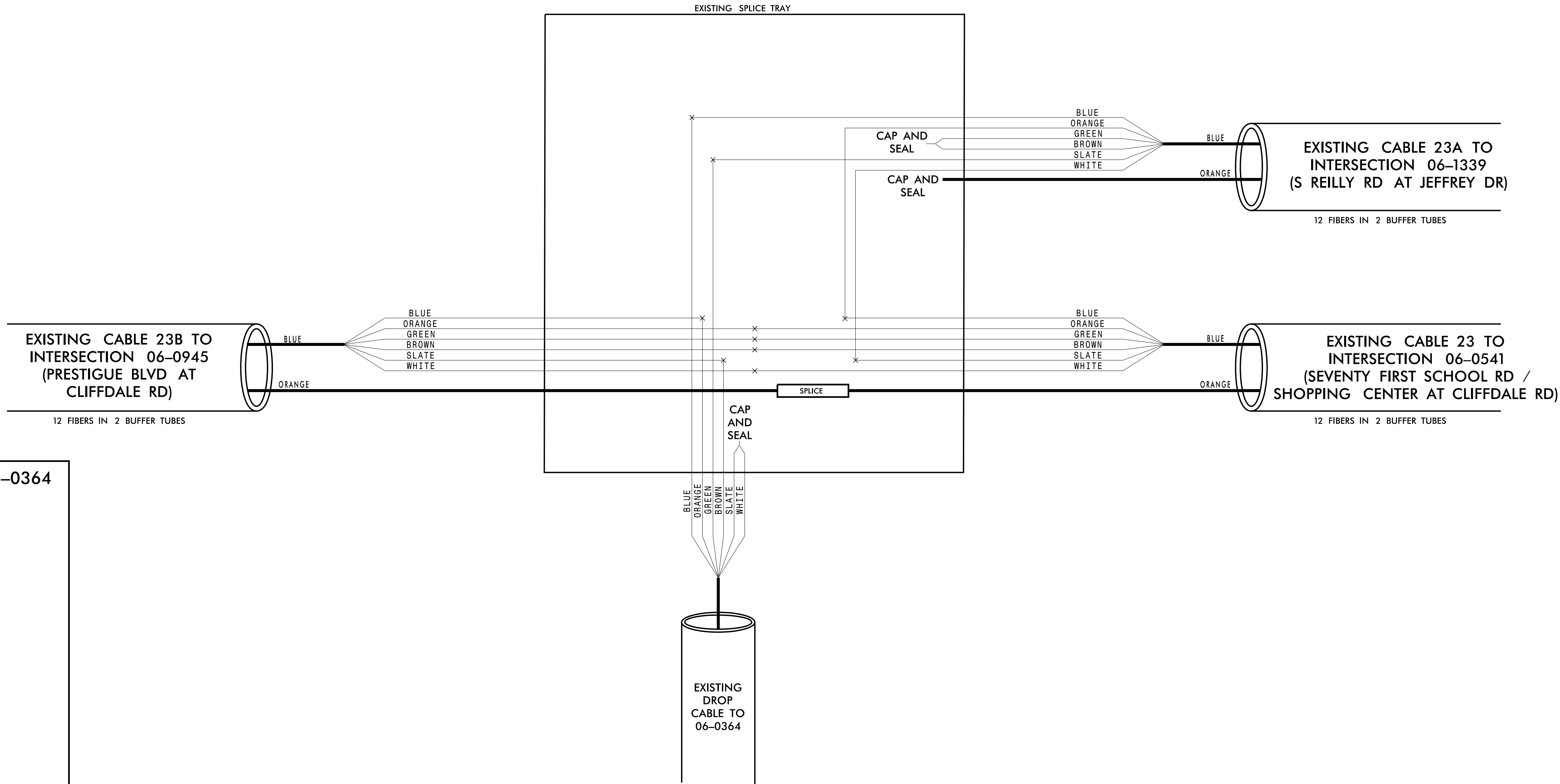

11/15/2016 K:\ARL\TPTD\_ITS\01036305 - Fayetteville Sig Sys\Plans\Splicing\01036305-ITS\_psh\_216-CH23\_06-0364.dgn

**Kimley»Horn**  
 NC License #F-0102  
 421 Fayetteville St., Suite 600  
 Raleigh, NC 27636  
 Tel: (919) 677-2000  
 Fax: (919) 677-2050

**CHANNEL 23**

**FAYETTEVILLE COMPUTERIZED SIGNAL SYSTEM**

**SPLICE DETAIL**

|                          |                               |                   |                          |
|--------------------------|-------------------------------|-------------------|--------------------------|
| DIVISION 06              |                               | CUMBERLAND COUNTY |                          |
| PLAN DATE: NOVEMBER 2016 | REVIEWED BY: N. M. MENGELKOCH | PREPARED BY: KHA  | REVIEWED BY: K. W. SMITH |
| REVISIONS                | INIT.                         | DATE              |                          |
|                          |                               |                   |                          |

Kevin W. Smith  
 11/15/2016  
 DATE  
 CADD Filename:

**CHANNEL 24**  
**EXISTING SPLICE CABINET ENCLOSURE**  
**(BRAGG BOULEVARD AT JOHNSON STREET /MIKE STREET)**  
**SIG ID 06-0265**

**COLOR CODE**  
 TIA/EIA 598-C

|            |             |
|------------|-------------|
| (1) BLUE   | (7) RED     |
| (2) ORANGE | (8) BLACK   |
| (3) GREEN  | (9) YELLOW  |
| (4) BROWN  | (10) VIOLET |
| (5) SLATE  | (11) ROSE   |
| (6) WHITE  | (12) AQUA   |

**LEGEND**

X - FUSION SPLICE INDIVIDUAL FIBER  
 O - EXISTING SPLICE  
 □ - EXPRESS INDIVIDUAL FIBER

EXPRESS - EXPRESS ENTIRE BUFFER TUBE  
 SPLICE - SPLICE ENTIRE BUFFER TUBE OR MAINTAIN IF EXISTING EXPRESSED

**NOTES:**

- FIBER INTERCONNECT CENTER RACKS ARE SCHEMATIC ONLY - ACTUAL EQUIPMENT FORM MAY VARY.
- ETHERNET SWITCH TERMINATION CONFIGURATIONS ARE GENERIC. CONTRACTOR IS RESPONSIBLE FOR DETERMINING /ENSURING PROPER TERMINATION.
- CONTRACTOR IS RESPONSIBLE FOR FIELD VERIFYING EXISTING SPLICING. THE CONTRACTOR SHALL COORDINATE WITH THE ENGINEER WHERE EXISTING SPLICING IS NOT AS EXPECTED.

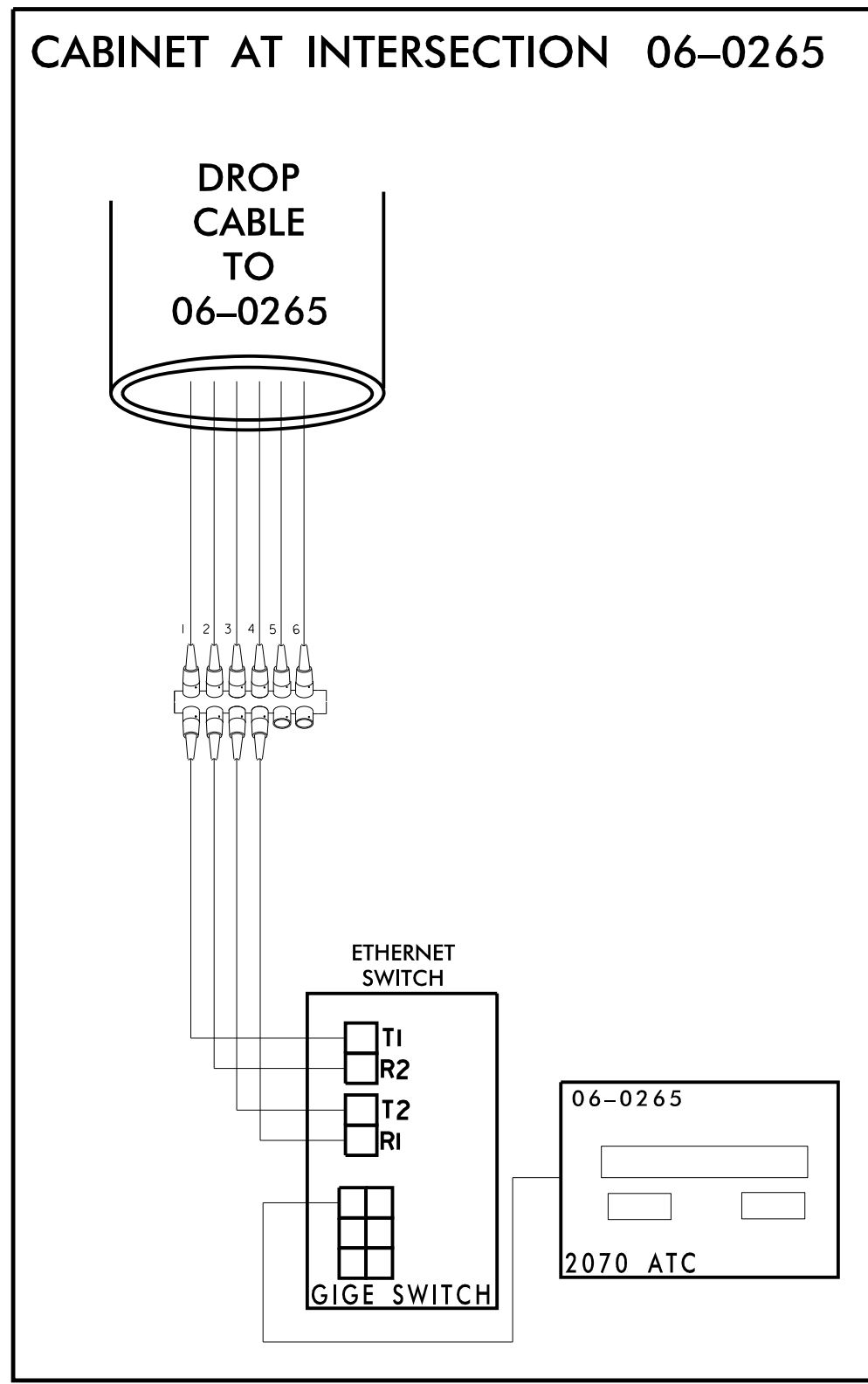
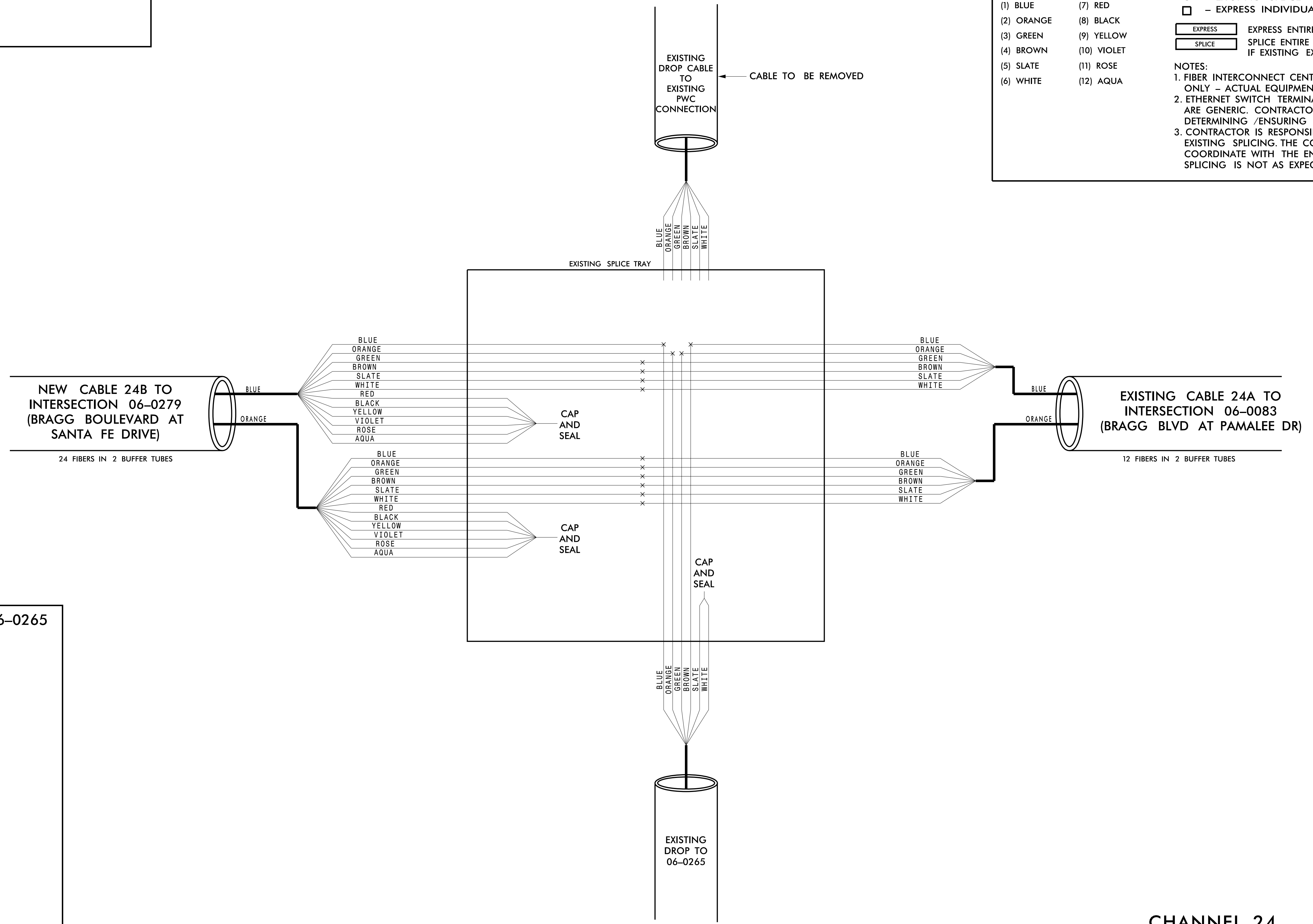

**CHANNEL 24**

**FAYETTEVILLE COMPUTERIZED SIGNAL SYSTEM**  
**SPLICE DETAIL**

DIVISION 06 CUMBERLAND COUNTY

PLAN DATE: NOVEMBER 2016 REVIEWED BY: N. M. MENGELKOCH

PREPARED BY: KHA REVIEWED BY: K. W. SMITH

SCALE: 0

**Kimley»Horn**  
 NC License #F-0102  
 421 Fayetteville St., Suite 600  
 Raleigh, NC 27636  
 Tel: (919) 677-2000  
 Fax: (919) 677-2050

SEAL  
 NORTH CAROLINA PROFESSIONAL ENGINEER  
 KEVIN W. SMITH  
 SEAL 030472  
 11/15/2016

11/15/2016 K:\ARL\TPTD\ITS\01036305 - Fayetteville Sig Sys\Plans\Splicing\01036305-ITS\_psh-217-CH24\_06-0265.dgn

**CHANNEL 24  
EXISTING SPLICE ENCLOSURE  
(BRAGG BLVD AT SANTA FE DR)  
SIG ID 06-0279  
CCTV 24**

**COLOR CODE**  
TIA/EIA 598-C

|            |             |
|------------|-------------|
| (1) BLUE   | (7) RED     |
| (2) ORANGE | (8) BLACK   |
| (3) GREEN  | (9) YELLOW  |
| (4) BROWN  | (10) VIOLET |
| (5) SLATE  | (11) ROSE   |
| (6) WHITE  | (12) AQUA   |

**LEGEND**

- X - FUSION SPLICE INDIVIDUAL FIBER
- O - EXISTING SPLICE
- - EXPRESS INDIVIDUAL FIBER

EXPRESS: EXPRESS ENTIRE BUFFER TUBE  
SPLICE: SPLICE ENTIRE BUFFER TUBE OR MAINTAIN IF EXISTING EXPRESSED

**NOTES:**

- FIBER INTERCONNECT CENTER RACKS ARE SCHEMATIC ONLY - ACTUAL EQUIPMENT FORM MAY VARY.
- ETHERNET SWITCH TERMINATION CONFIGURATIONS ARE GENERIC. CONTRACTOR IS RESPONSIBLE FOR DETERMINING /ENSURING PROPER TERMINATION.
- CONTRACTOR IS RESPONSIBLE FOR FIELD VERIFYING EXISTING SPLICING. THE CONTRACTOR SHALL COORDINATE WITH THE ENGINEER WHERE EXISTING SPLICING IS NOT AS EXPECTED.

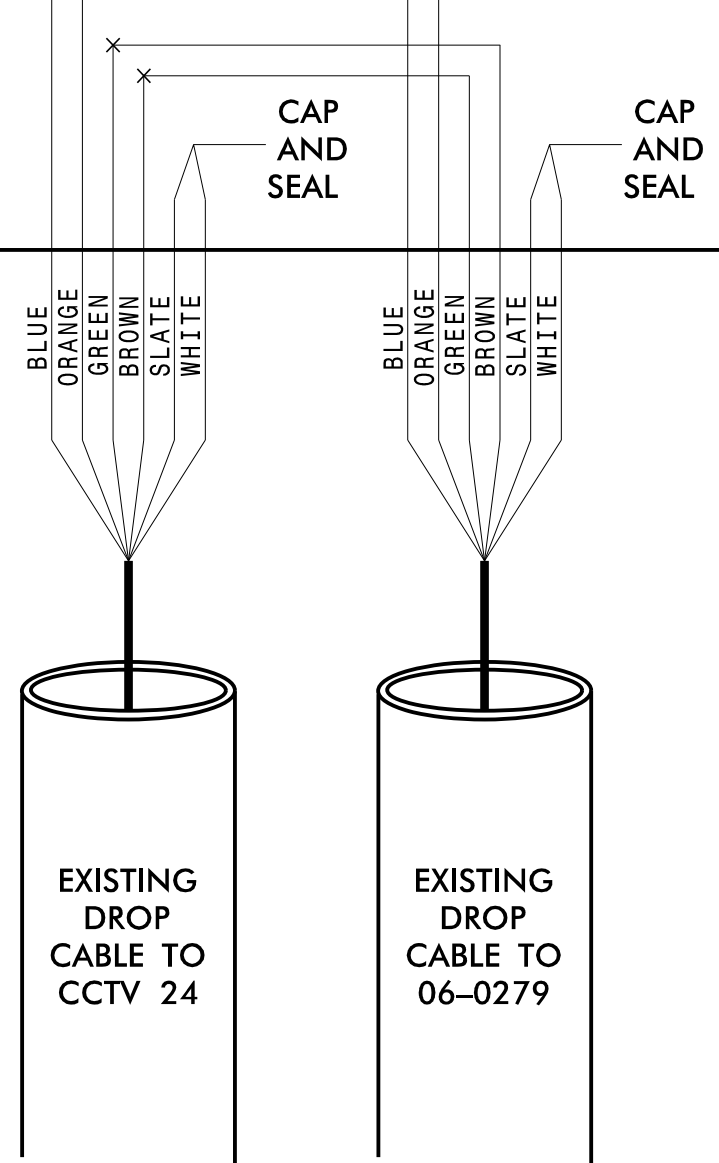
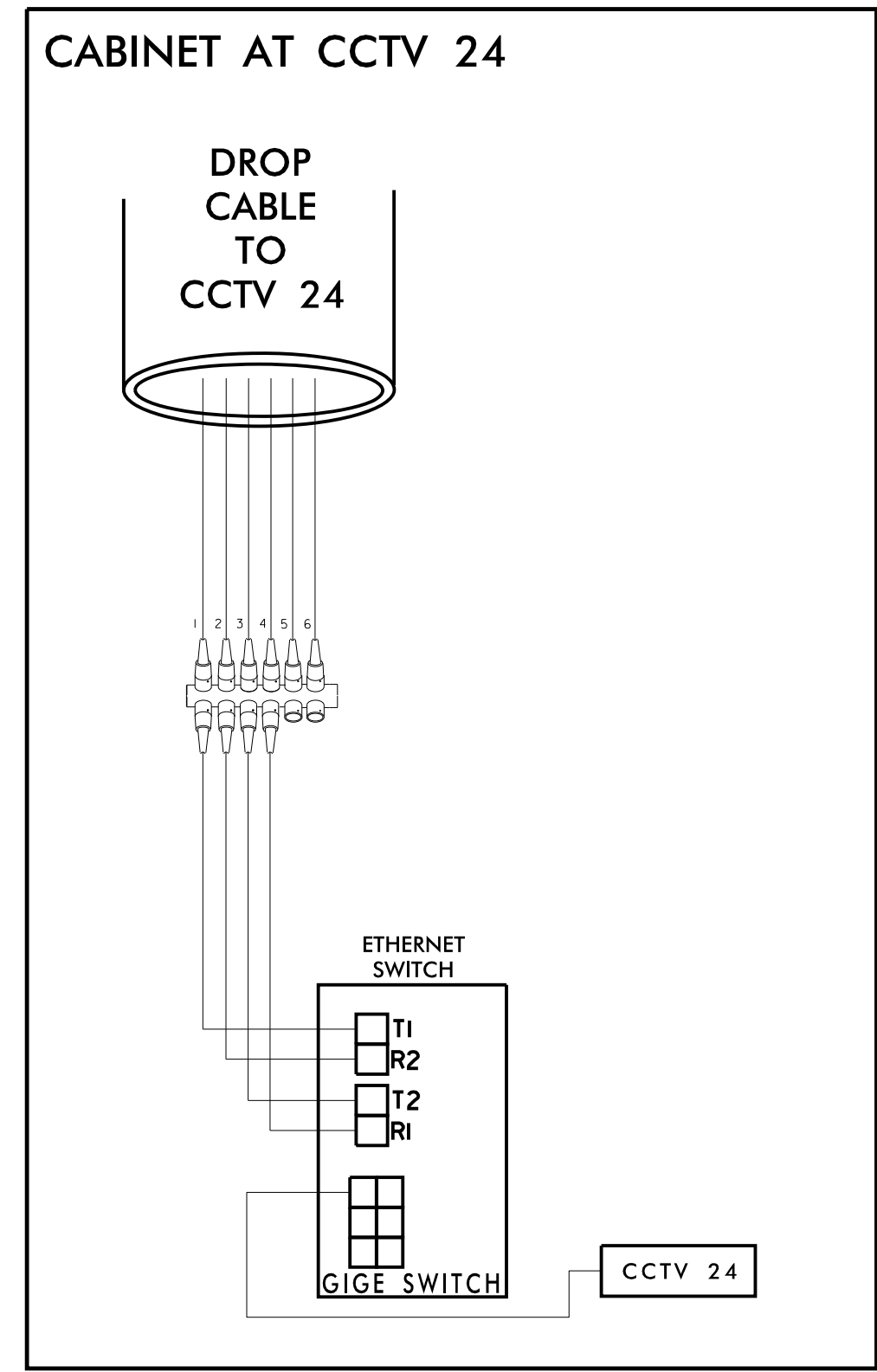
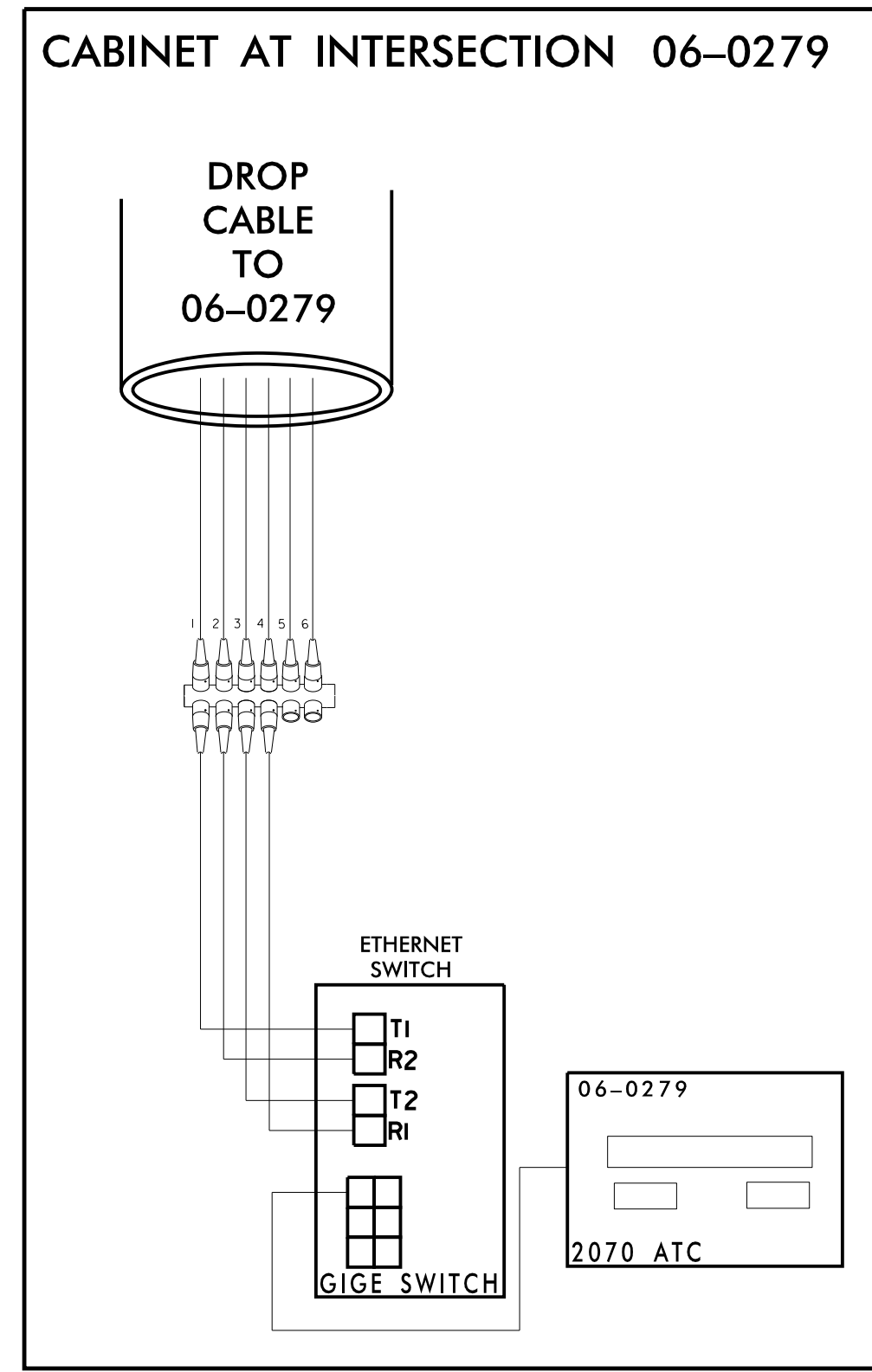
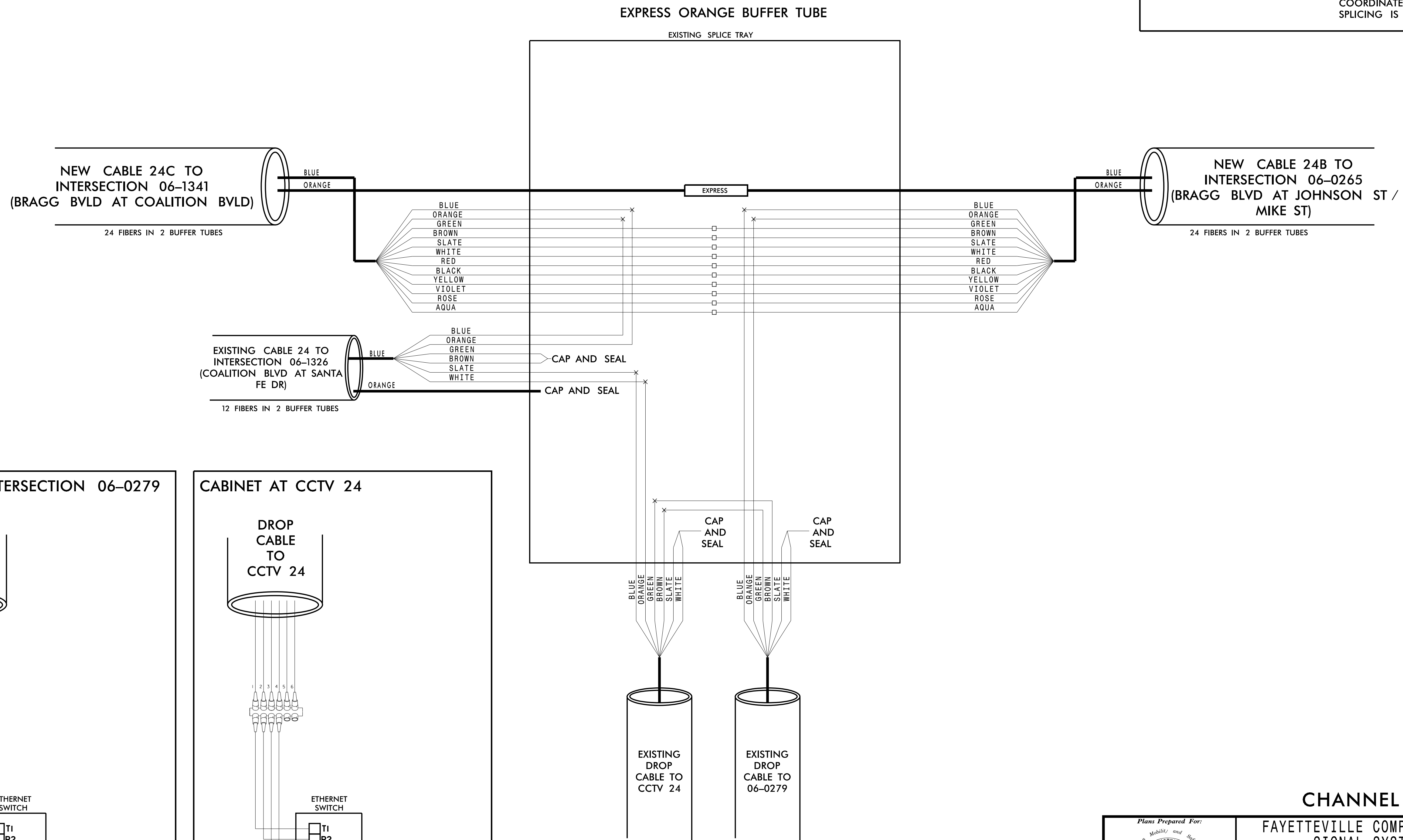

**CHANNEL 24**

**FAYETTEVILLE COMPUTERIZED SIGNAL SYSTEM**

**SPLICE DETAIL**

DIVISION 06 CUMBERLAND COUNTY

PLAN DATE: NOVEMBER 2016 REVIEWED BY: N.M. MENGELKOCH

PREPARED BY: KHA REVIEWED BY: K.W. SMITH

SCALE: 0

REVISIONS: INIT. DATE

Signature: Kevin Smith, 11/15/2016

Seal: NORTH CAROLINA PROFESSIONAL ENGINEER KEVIN W. SMITH SEAL 030472

**Kimley»Horn**

NC License #F-0102  
421 Fayetteville St., Suite 600  
Raleigh, NC 27636  
Tel: (919) 677-2000  
Fax: (919) 677-2050

11/15/2016 K:\ARL\TPTD\ITS\01036305 - Fayetteville Sig Sys\Plans\Splicing\01036305-ITS-CH24-06-0279.dgn

**CHANNEL 24**  
**EXISTING SPLICE ENCLOSURE**  
**(ALL AMERICAN EXPRESSWAY**  
**NB RAMP AT SANTA FE DR)**  
**SIG ID 06-0278**  
**CCTV 26**

**COLOR CODE**  
TIA/EIA 598-C

|            |             |
|------------|-------------|
| (1) BLUE   | (7) RED     |
| (2) ORANGE | (8) BLACK   |
| (3) GREEN  | (9) YELLOW  |
| (4) BROWN  | (10) VIOLET |
| (5) SLATE  | (11) ROSE   |
| (6) WHITE  | (12) AQUA   |

**LEGEND**

X - FUSION SPLICE INDIVIDUAL FIBER  
O - EXISTING SPLICE  
□ - EXPRESS INDIVIDUAL FIBER

EXPRESS - EXPRESS ENTIRE BUFFER TUBE  
SPLICE - SPLICE ENTIRE BUFFER TUBE OR MAINTAIN IF EXISTING EXPRESSED

**NOTES:**

- FIBER INTERCONNECT CENTER RACKS ARE SCHEMATIC ONLY - ACTUAL EQUIPMENT FORM MAY VARY.
- ETHERNET SWITCH TERMINATION CONFIGURATIONS ARE GENERIC. CONTRACTOR IS RESPONSIBLE FOR DETERMINING /ENSURING PROPER TERMINATION.
- CONTRACTOR IS RESPONSIBLE FOR FIELD VERIFYING EXISTING SPLICING. THE CONTRACTOR SHALL COORDINATE WITH THE ENGINEER WHERE EXISTING SPLICING IS NOT AS EXPECTED.

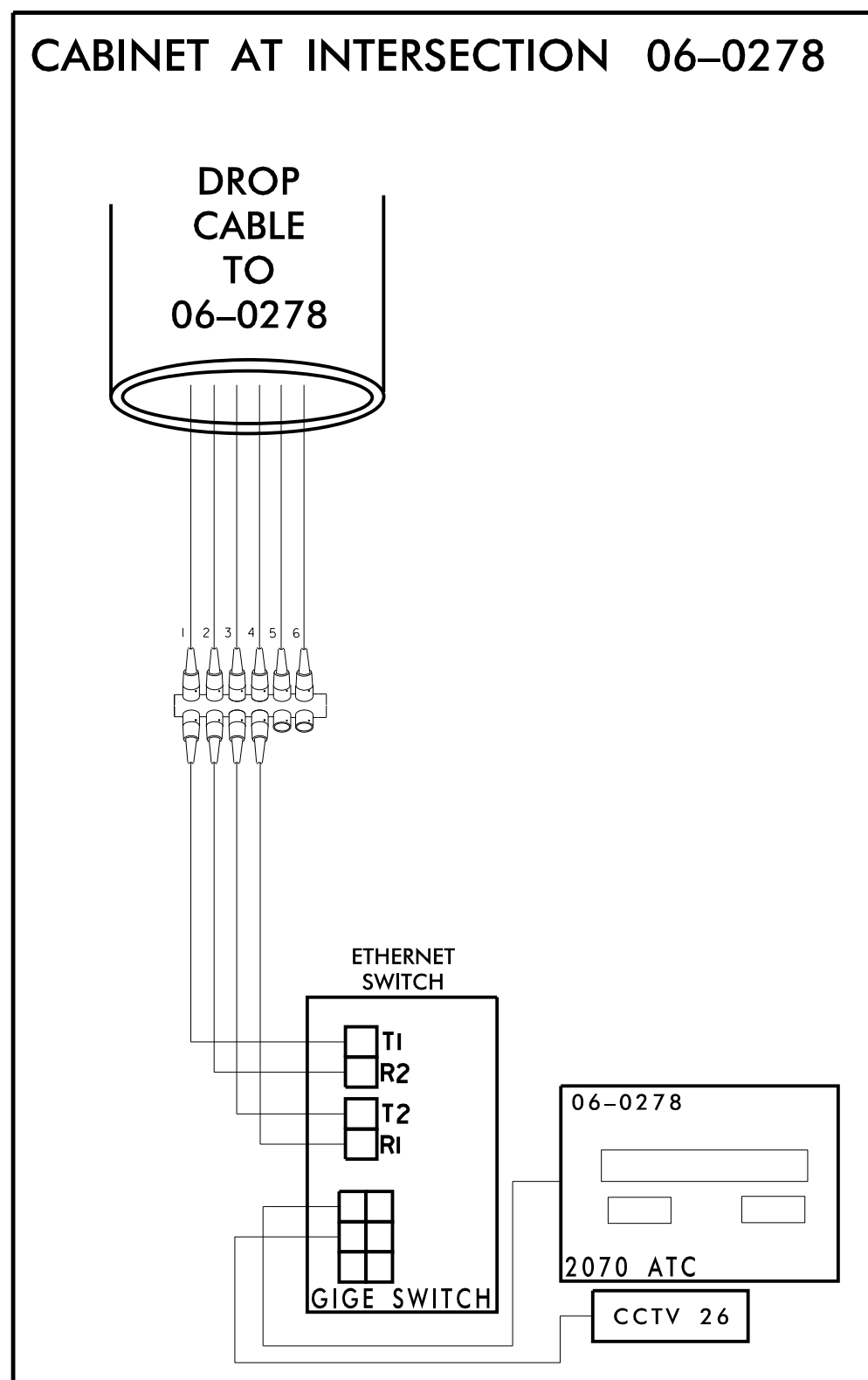
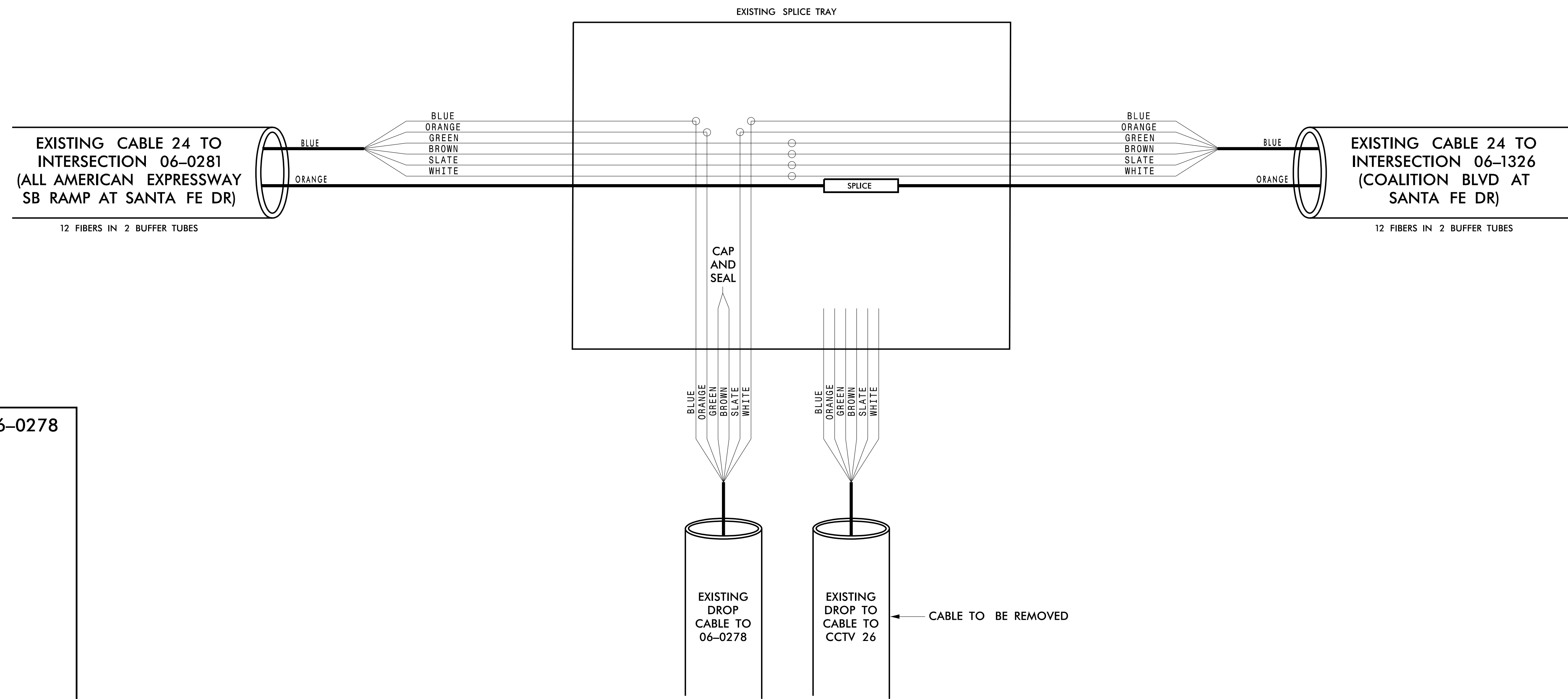

**CHANNEL 24**

**FAYETTEVILLE COMPUTERIZED SIGNAL SYSTEM**  
**SPLICE DETAIL**

DIVISION 06 CUMBERLAND COUNTY

PLAN DATE: NOVEMBER 2016 REVIEWED BY: N. M. MENGELKOCH

PREPARED BY: KHA REVIEWED BY: K. W. SMITH

Scale: 0

Signature: *Kevin W. Smith* 11/15/2016

Seal: NORTH CAROLINA PROFESSIONAL ENGINEER SEAL 030472

**Kimley»Horn**  
NC License #F-0102  
421 Fayetteville St., Suite 600  
Raleigh, NC 27636  
Tel: (919) 677-2000  
Fax: (919) 677-2050

11/15/2016 K:\ARL\TPTD\ITS\01036305 - Fayetteville Sig Sys\Plans\Splicing\01036305-ITS\_psh\_219-CH24 CCTV Harvest at 06-0278.dgn

**CHANNEL 24**  
**EXISTING SPLICE ENCLOSURE**  
**(ALL AMERICAN EXPRESSWAY SB RAMP**  
**AT SANTA FE DR)**  
**SIG ID 06-0281**  
**CCTV 25**

**COLOR CODE**  
TIA/EIA 598-C

|            |             |
|------------|-------------|
| (1) BLUE   | (7) RED     |
| (2) ORANGE | (8) BLACK   |
| (3) GREEN  | (9) YELLOW  |
| (4) BROWN  | (10) VIOLET |
| (5) SLATE  | (11) ROSE   |
| (6) WHITE  | (12) AQUA   |

**LEGEND**

X - FUSION SPLICE INDIVIDUAL FIBER  
O - EXISTING SPLICE  
□ - EXPRESS INDIVIDUAL FIBER

EXPRESS - EXPRESS ENTIRE BUFFER TUBE  
SPLICE - SPLICE ENTIRE BUFFER TUBE OR MAINTAIN IF EXISTING EXPRESSED

**NOTES:**

- FIBER INTERCONNECT CENTER RACKS ARE SCHEMATIC ONLY - ACTUAL EQUIPMENT FORM MAY VARY.
- ETHERNET SWITCH TERMINATION CONFIGURATIONS ARE GENERIC. CONTRACTOR IS RESPONSIBLE FOR DETERMINING /ENSURING PROPER TERMINATION.
- CONTRACTOR IS RESPONSIBLE FOR FIELD VERIFYING EXISTING SPLICING. THE CONTRACTOR SHALL COORDINATE WITH THE ENGINEER WHERE EXISTING SPLICING IS NOT AS EXPECTED.

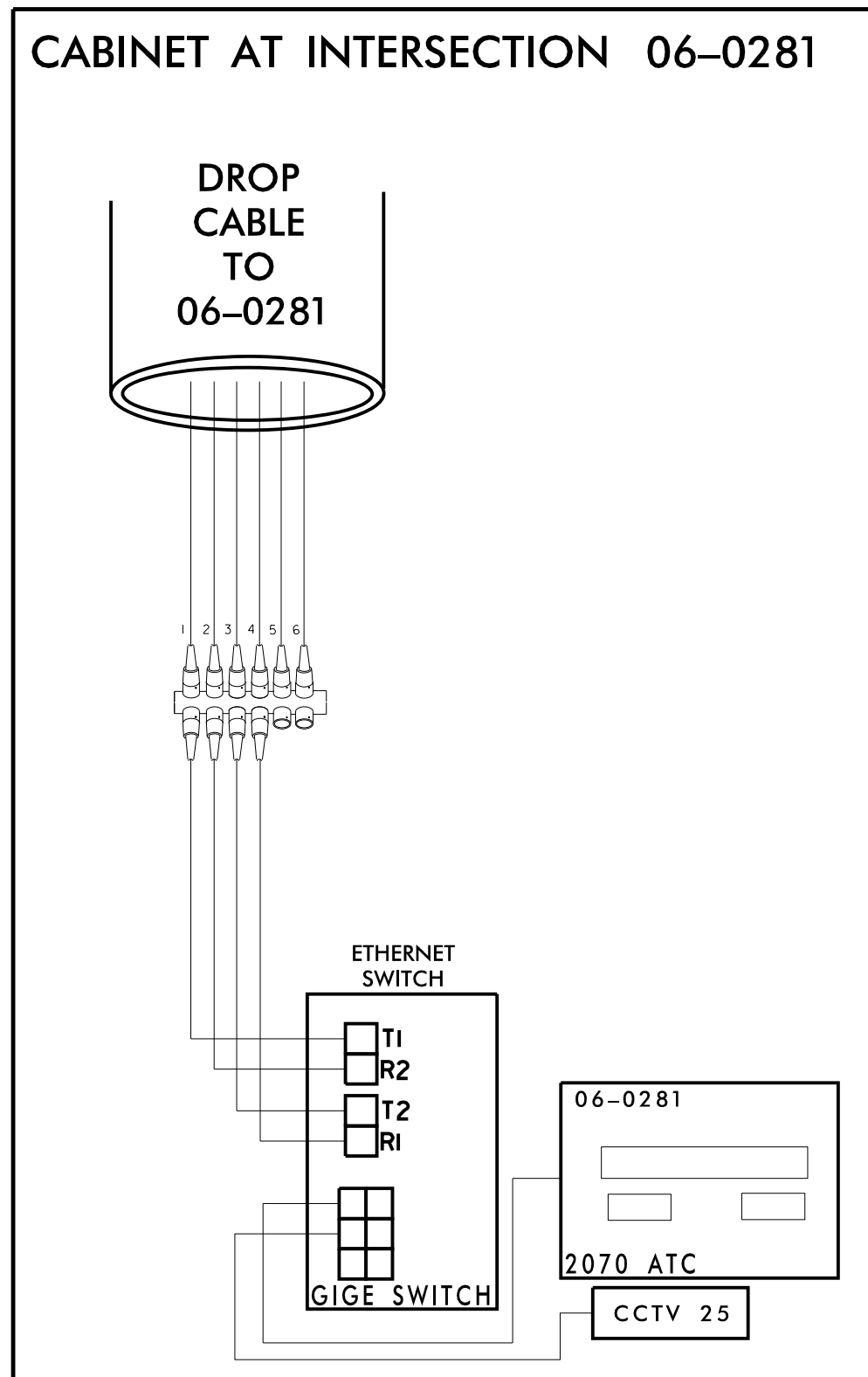
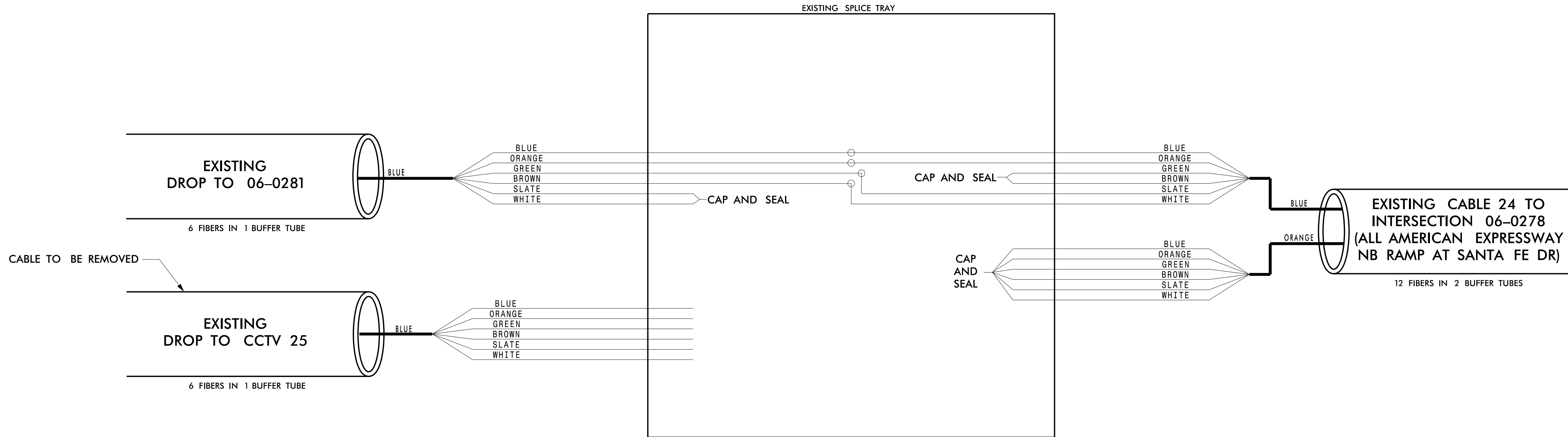

**CHANNEL 24**

**FAYETTEVILLE COMPUTERIZED SIGNAL SYSTEM**  
**SPLICE DETAIL**

DIVISION 06 CUMBERLAND COUNTY

PLAN DATE: NOVEMBER 2016 REVIEWED BY: N. M. MENGELKOCH

PREPARED BY: KHA REVIEWED BY: K. W. SMITH

| REVISIONS | INIT. | DATE |
|-----------|-------|------|
|           |       |      |
|           |       |      |

SCALE: 0

Kimley»Horn  
NC License #F-0102  
421 Fayetteville St., Suite 600  
Raleigh, NC 27636  
Tel: (919) 677-2000  
Fax: (919) 677-2050

Seal: NORTH CAROLINA PROFESSIONAL ENGINEER KEVIN W. SMITH SEAL 030472

DocuSigned By: Kevin Smith 11/15/2016  
0688E04E3B0440E  
SIGNATURE DATE  
CADD Filename:

11/15/2016 K:\ARL\TPTD\ITS\01036305 - Fayetteville Sig Sys\Plans\Splicing\01036305-ITS-psk-220-CH24 CCTV Harvest at 06-0281.dgn



**CHANNEL 24**  
**NEW SPICE ENCLOSURE**  
**(BRAGG BLVD AT COALITION**  
**BLVD)**  
**SIG ID 06-1341**

**COLOR CODE**  
 TIA/EIA 598-C

|            |             |
|------------|-------------|
| (1) BLUE   | (7) RED     |
| (2) ORANGE | (8) BLACK   |
| (3) GREEN  | (9) YELLOW  |
| (4) BROWN  | (10) VIOLET |
| (5) SLATE  | (11) ROSE   |
| (6) WHITE  | (12) AQUA   |

**LEGEND**

X - FUSION SPLICE INDIVIDUAL FIBER  
 O - EXISTING SPLICE  
 □ - EXPRESS INDIVIDUAL FIBER

EXPRESS - EXPRESS ENTIRE BUFFER TUBE  
 SPLICE - SPLICE ENTIRE BUFFER TUBE OR MAINTAIN IF EXISTING EXPRESSED

**NOTES:**

- FIBER INTERCONNECT CENTER RACKS ARE SCHEMATIC ONLY - ACTUAL EQUIPMENT FORM MAY VARY.
- ETHERNET SWITCH TERMINATION CONFIGURATIONS ARE GENERIC. CONTRACTOR IS RESPONSIBLE FOR DETERMINING /ENSURING PROPER TERMINATION.
- CONTRACTOR IS RESPONSIBLE FOR FIELD VERIFYING EXISTING SPLICING. THE CONTRACTOR SHALL COORDINATE WITH THE ENGINEER WHERE EXISTING SPLICING IS NOT AS EXPECTED.

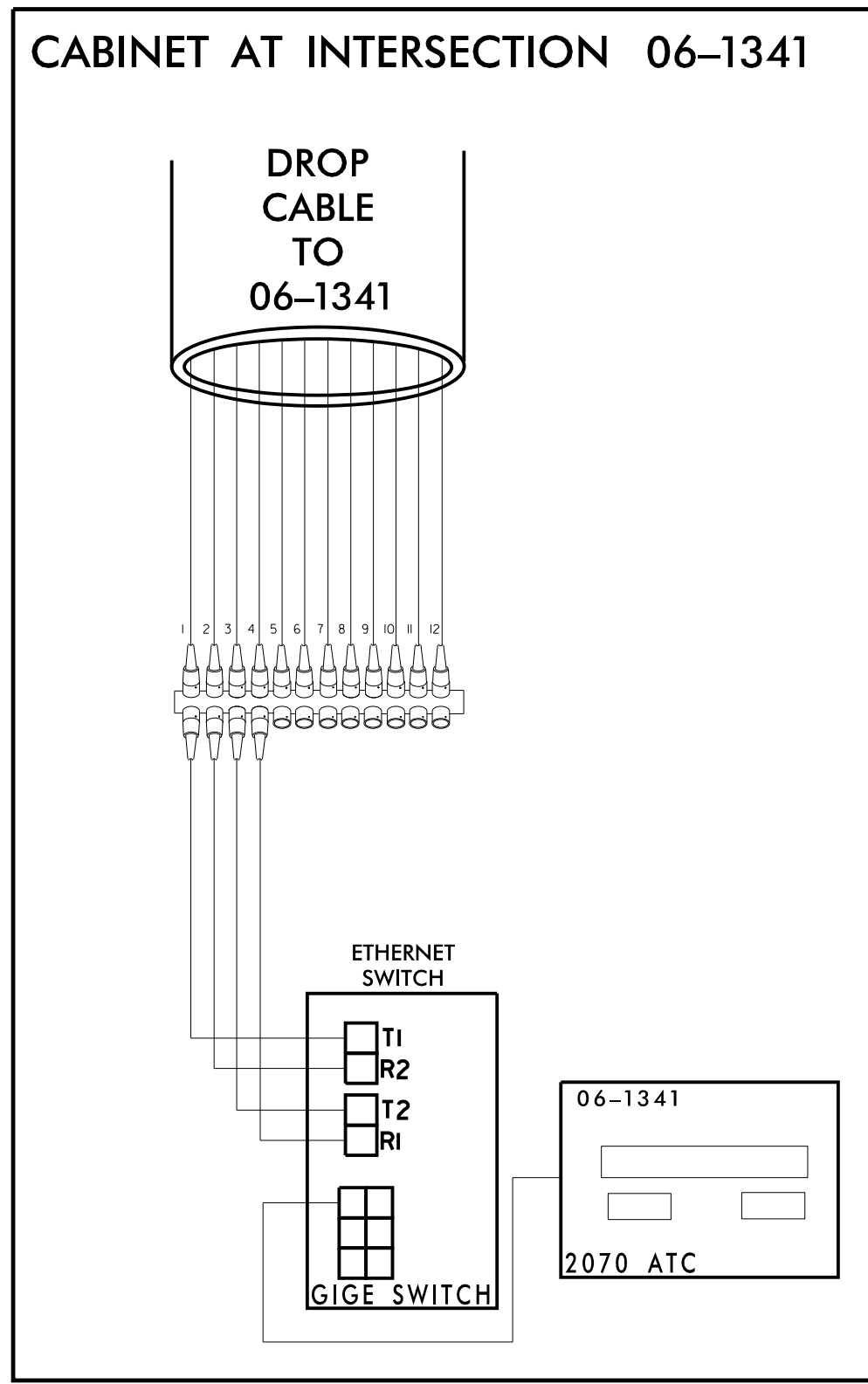
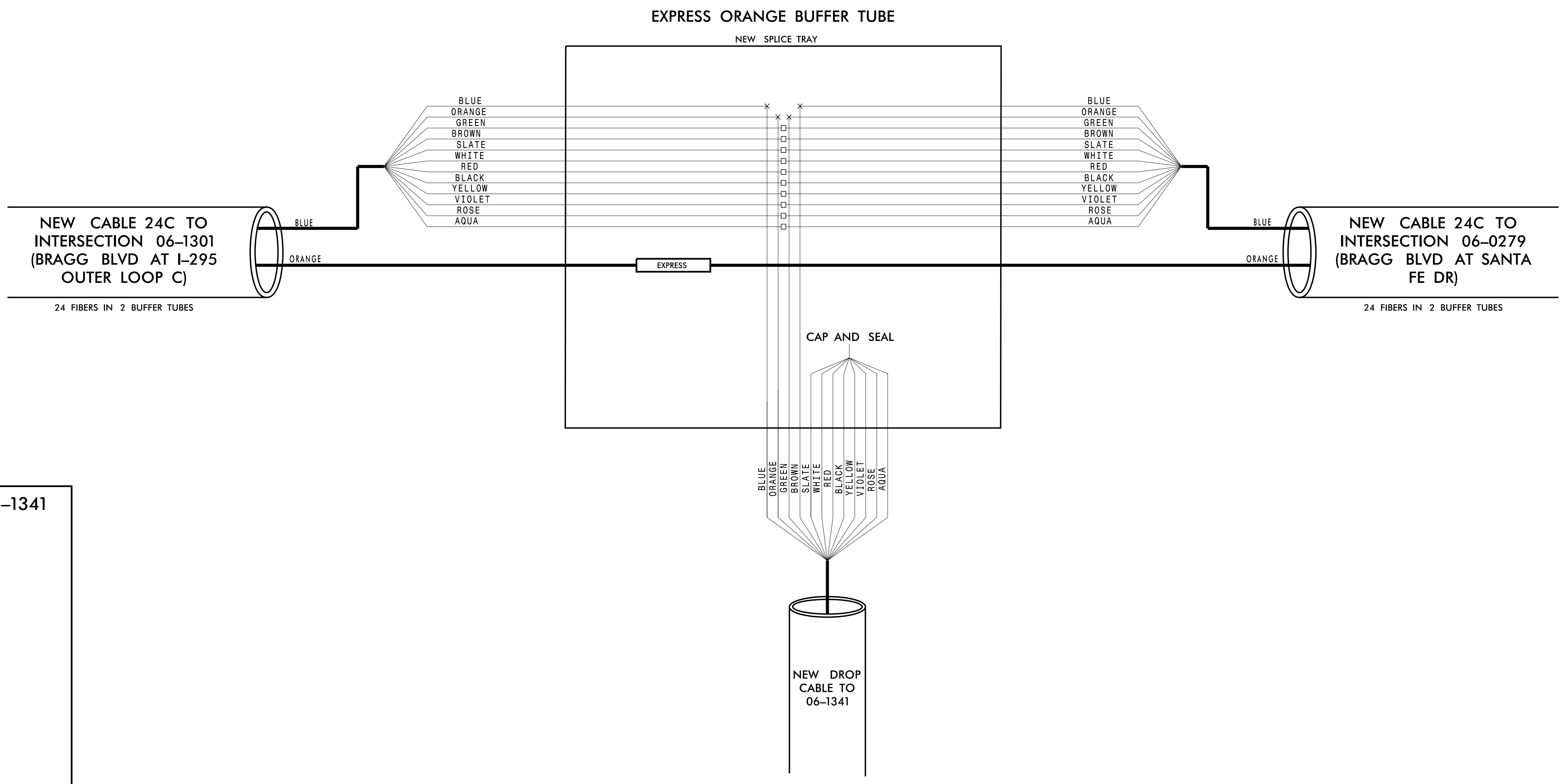

**CHANNEL 24**

**FAYETTEVILLE COMPUTERIZED SIGNAL SYSTEM**  
**SPLICE DETAIL**

DIVISION 06 CUMBERLAND COUNTY

PLAN DATE: NOVEMBER 2016 REVIEWED BY: N. M. MENGELKOCH

PREPARED BY: KHA REVIEWED BY: K. W. SMITH

250 N. Greenfield Place, Garner, NC 27529

SCALE: 0

REVISIONS: INIT. DATE

DocuSigned by: Kevin Smith  
 SEAL: NORTH CAROLINA PROFESSIONAL ENGINEER KEVIN W. SMITH  
 SEAL 030472  
 11/15/2016  
 SIGNATURE DATE  
 CADD File name:

**Kimley»Horn**  
 NC License #F-0102  
 421 Fayetteville St., Suite 600  
 Raleigh, NC 27636  
 Tel: (919) 677-2000  
 Fax: (919) 677-2050

11/15/2016 K:\ARL\TPTD\ITS\01036305 - Fayetteville Sig Sys\Plans\Splicing\01036305-ITS\_psh-221-CH24\_06-1341.dgn

**CHANNEL 24  
NEW SPLICE ENCLOSURE  
(BRAGG BLVD AT NC-295  
NB RAMP)  
SIG ID 06-1301**

**COLOR CODE**  
TIA/EIA 598-C

|            |             |
|------------|-------------|
| (1) BLUE   | (7) RED     |
| (2) ORANGE | (8) BLACK   |
| (3) GREEN  | (9) YELLOW  |
| (4) BROWN  | (10) VIOLET |
| (5) SLATE  | (11) ROSE   |
| (6) WHITE  | (12) AQUA   |

**LEGEND**

- X - FUSION SPLICE INDIVIDUAL FIBER
- - EXISTING SPLICE
- - EXPRESS INDIVIDUAL FIBER
- EXPRESS - EXPRESS ENTIRE BUFFER TUBE
- SPLICE - SPLICE ENTIRE BUFFER TUBE OR MAINTAIN IF EXISTING EXPRESSED

**NOTES:**

- FIBER INTERCONNECT CENTER RACKS ARE SCHEMATIC ONLY - ACTUAL EQUIPMENT FORM MAY VARY.
- ETHERNET SWITCH TERMINATION CONFIGURATIONS ARE GENERIC. CONTRACTOR IS RESPONSIBLE FOR DETERMINING /ENSURING PROPER TERMINATION.
- CONTRACTOR IS RESPONSIBLE FOR FIELD VERIFYING EXISTING SPLICING. THE CONTRACTOR SHALL COORDINATE WITH THE ENGINEER WHERE EXISTING SPLICING IS NOT AS EXPECTED.

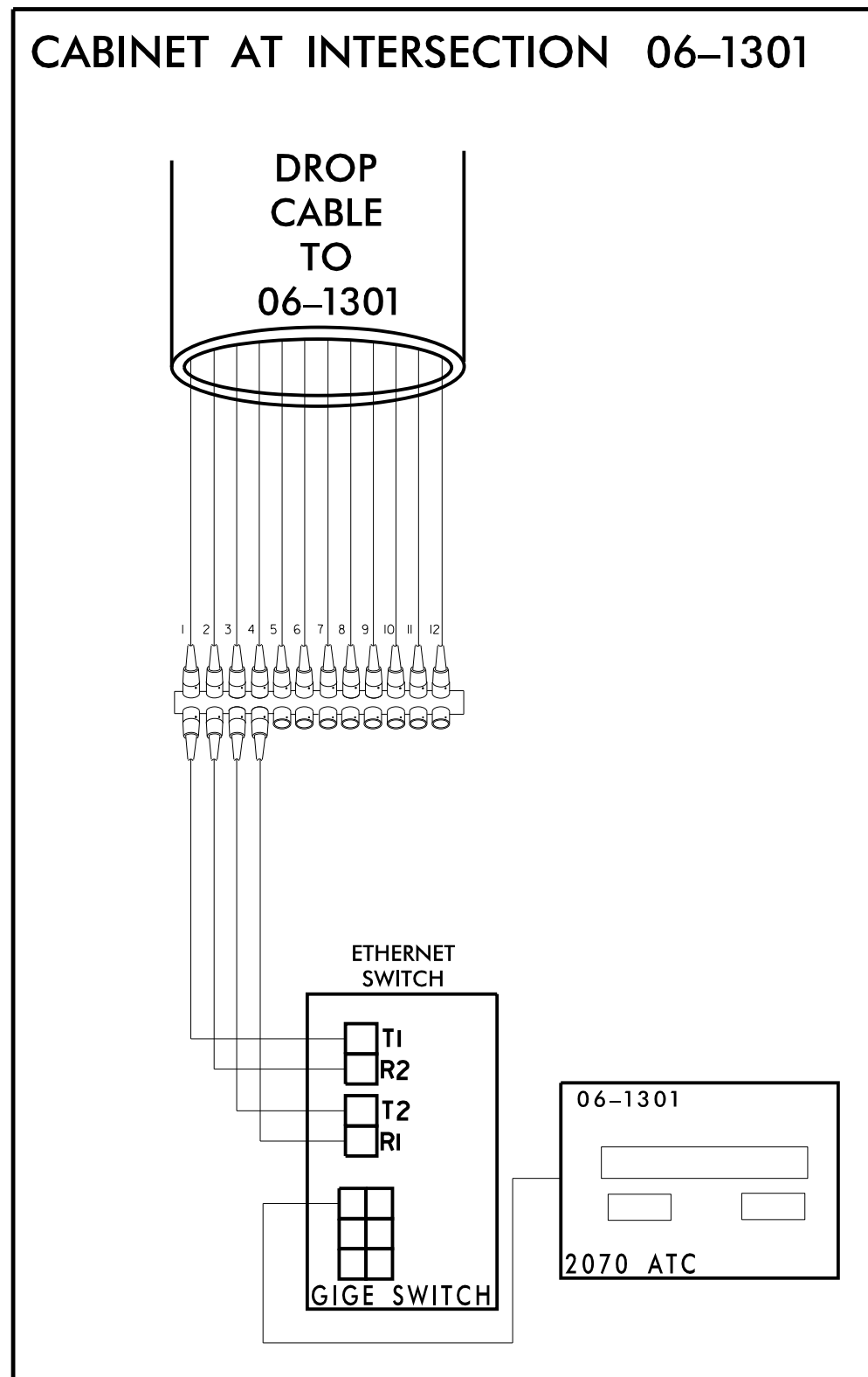
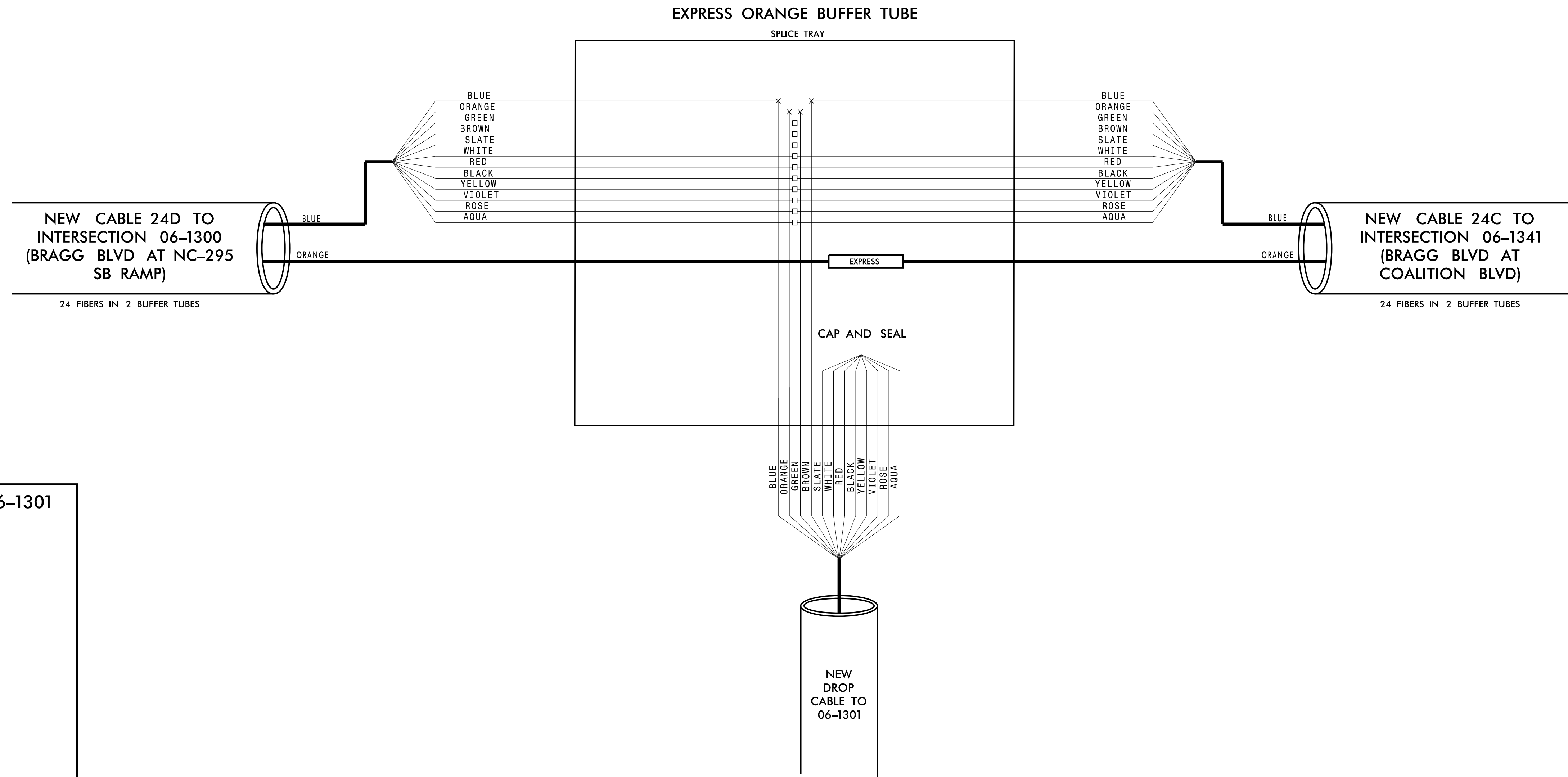

**CHANNEL 24**

**FAYETTEVILLE COMPUTERIZED SIGNAL SYSTEM**

**SPLICE DETAIL**

|                          |                               |                   |                          |
|--------------------------|-------------------------------|-------------------|--------------------------|
| DIVISION 06              |                               | CUMBERLAND COUNTY |                          |
| PLAN DATE: NOVEMBER 2016 | REVIEWED BY: N. M. MENGELKOCH | PREPARED BY: KHA  | REVIEWED BY: K. W. SMITH |
| REVISIONS                | INIT.                         | DATE              |                          |

Seal 030472  
KEVIN W. SMITH  
ENGINEER

11/15/2016

SIGNATURE DATE

CADD File name:

**Kimley»Horn**  
 NC License #F-0102  
 421 Fayetteville St., Suite 600  
 Raleigh, NC 27636  
 Tel: (919) 677-2000  
 Fax: (919) 677-2050

11/15/2016 K:\ARL\TPTD\ITS\01036305 - Fayetteville Sig Sys\Plans\Splicing\01036305-ITS-psk-222-Ch24\_06-1300.dgn

**CHANNEL 24**  
**NEW SPLICE ENCLOSURE**  
**(BRAGG BLVD AT NC-295**  
**SB RAMP)**  
**SIG ID 06-1300**

**COLOR CODE**  
 TIA/EIA 598-C

|            |             |
|------------|-------------|
| (1) BLUE   | (7) RED     |
| (2) ORANGE | (8) BLACK   |
| (3) GREEN  | (9) YELLOW  |
| (4) BROWN  | (10) VIOLET |
| (5) SLATE  | (11) ROSE   |
| (6) WHITE  | (12) AQUA   |

**LEGEND**

X - FUSION SPLICE INDIVIDUAL FIBER  
 O - EXISTING SPLICE  
 □ - EXPRESS INDIVIDUAL FIBER

EXPRESS - EXPRESS ENTIRE BUFFER TUBE  
 SPLICE - SPLICE ENTIRE BUFFER TUBE OR MAINTAIN IF EXISTING EXPRESSED

**NOTES:**

- FIBER INTERCONNECT CENTER RACKS ARE SCHEMATIC ONLY - ACTUAL EQUIPMENT FORM MAY VARY.
- ETHERNET SWITCH TERMINATION CONFIGURATIONS ARE GENERIC. CONTRACTOR IS RESPONSIBLE FOR DETERMINING /ENSURING PROPER TERMINATION.
- CONTRACTOR IS RESPONSIBLE FOR FIELD VERIFYING EXISTING SPLICING. THE CONTRACTOR SHALL COORDINATE WITH THE ENGINEER WHERE EXISTING SPLICING IS NOT AS EXPECTED.

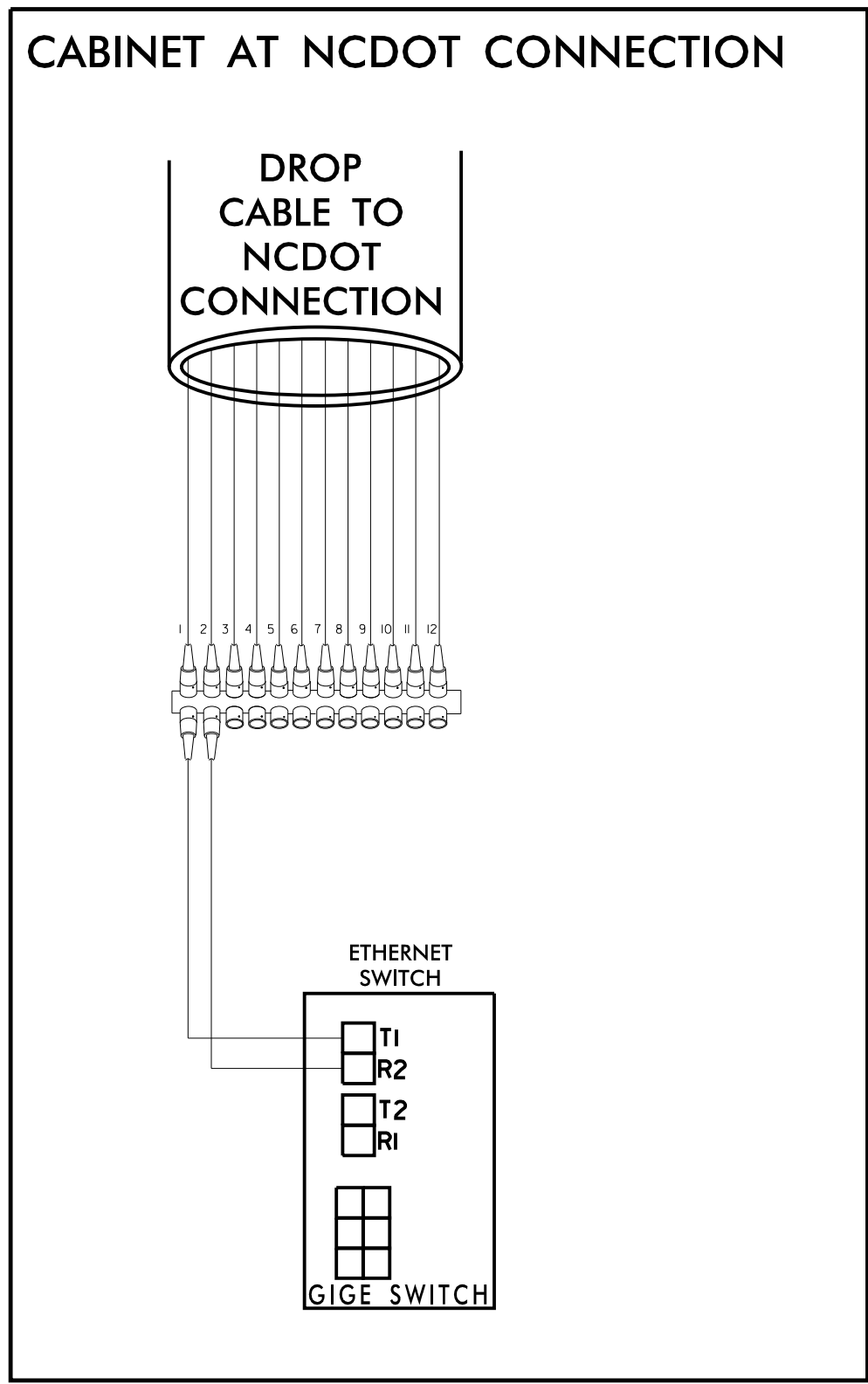
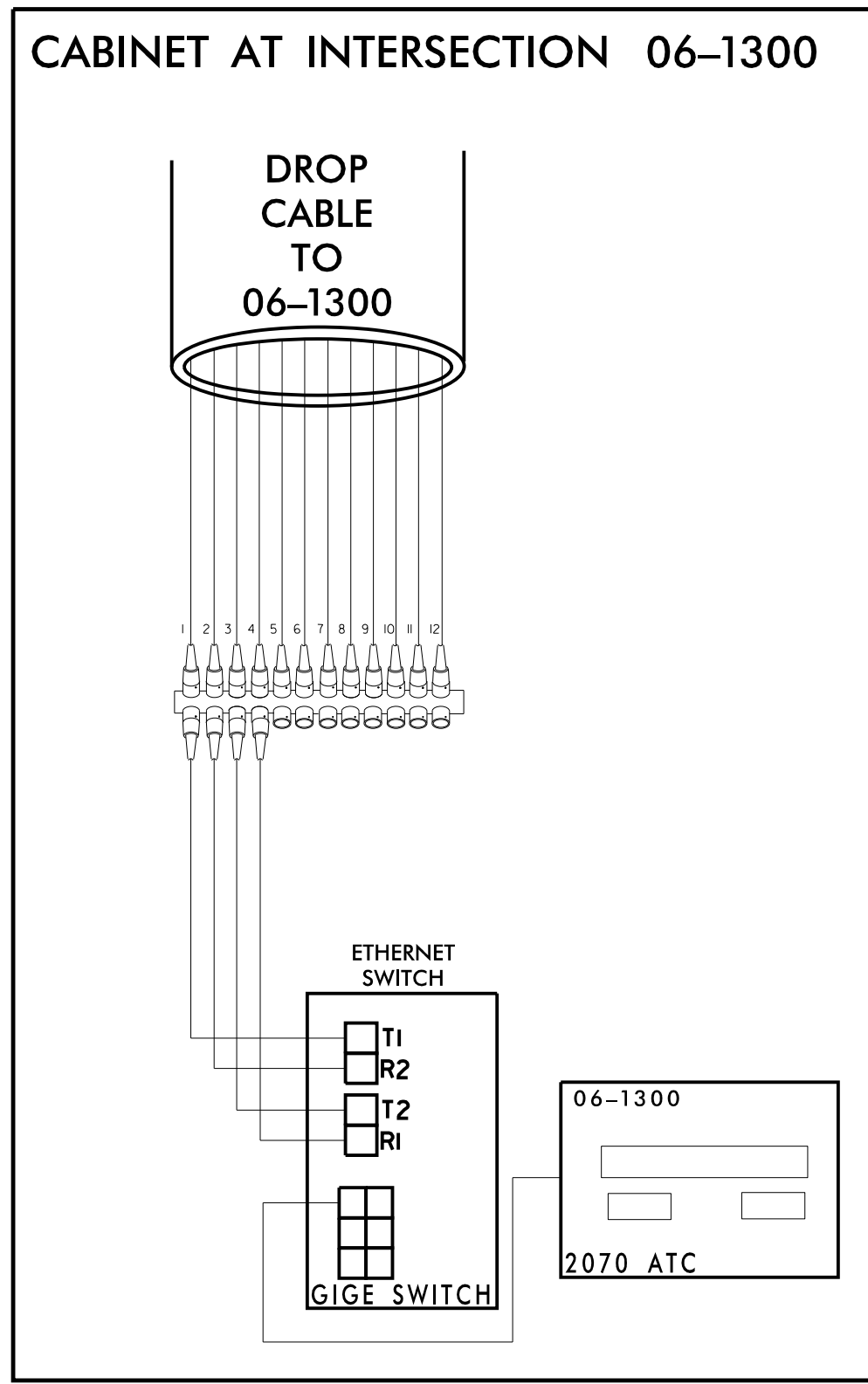
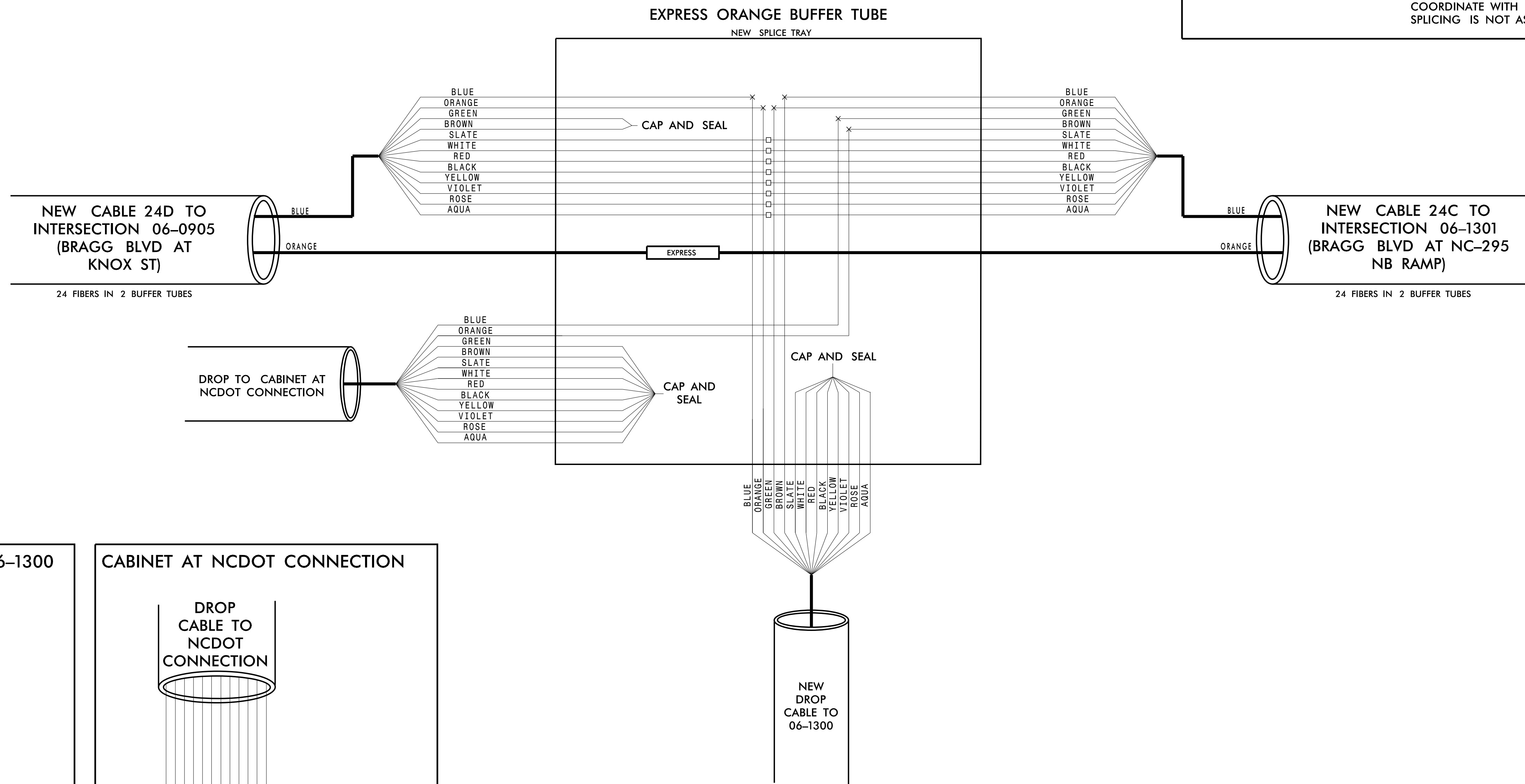

**CHANNEL 24**

**FAYETTEVILLE COMPUTERIZED SIGNAL SYSTEM**  
**SPLICE DETAIL**

DIVISION 06 CUMBERLAND COUNTY

PLAN DATE: NOVEMBER 2016 REVIEWED BY: N. M. MENGELKOCH

PREPARED BY: KHA REVIEWED BY: K. W. SMITH

SCALE: 0

SEAL: NORTH CAROLINA PROFESSIONAL ENGINEER KEVIN W. SMITH SEAL 030472

Signature: Kevin W. Smith, Date: 11/15/2016

Kimley Horn logo and contact information: NC License #F-0102, 421 Fayetteville St., Suite 600, Raleigh, NC 27636, Tel: (919) 677-2000, Fax: (919) 677-2050

11/15/2016 K:\ARL\TPTD\ITS\01036305 - Fayetteville Sig Sys\Plans\Splicing\01036305-ITS\_psh-223-CH24 NCDOT AT 06-1301.dgn

**CHANNEL 24  
NEW SPLICE ENCLOSURE  
(BRAGG BLVD AT KNOX ST)  
SIG ID 06-0905**

**COLOR CODE**  
TIA/EIA 598-C

|            |             |
|------------|-------------|
| (1) BLUE   | (7) RED     |
| (2) ORANGE | (8) BLACK   |
| (3) GREEN  | (9) YELLOW  |
| (4) BROWN  | (10) VIOLET |
| (5) SLATE  | (11) ROSE   |
| (6) WHITE  | (12) AQUA   |

**LEGEND**

X - FUSION SPLICE INDIVIDUAL FIBER  
 O - EXISTING SPLICE  
 □ - EXPRESS INDIVIDUAL FIBER

EXPRESS - EXPRESS ENTIRE BUFFER TUBE  
 SPLICE - SPLICE ENTIRE BUFFER TUBE OR MAINTAIN IF EXISTING EXPRESSED

**NOTES:**  
 1. FIBER INTERCONNECT CENTER RACKS ARE SCHEMATIC ONLY - ACTUAL EQUIPMENT FORM MAY VARY.  
 2. ETHERNET SWITCH TERMINATION CONFIGURATIONS ARE GENERIC. CONTRACTOR IS RESPONSIBLE FOR DETERMINING /ENSURING PROPER TERMINATION.  
 3. CONTRACTOR IS RESPONSIBLE FOR FIELD VERIFYING EXISTING SPlicing. THE CONTRACTOR SHALL COORDINATE WITH THE ENGINEER WHERE EXISTING SPlicing IS NOT AS EXPECTED.

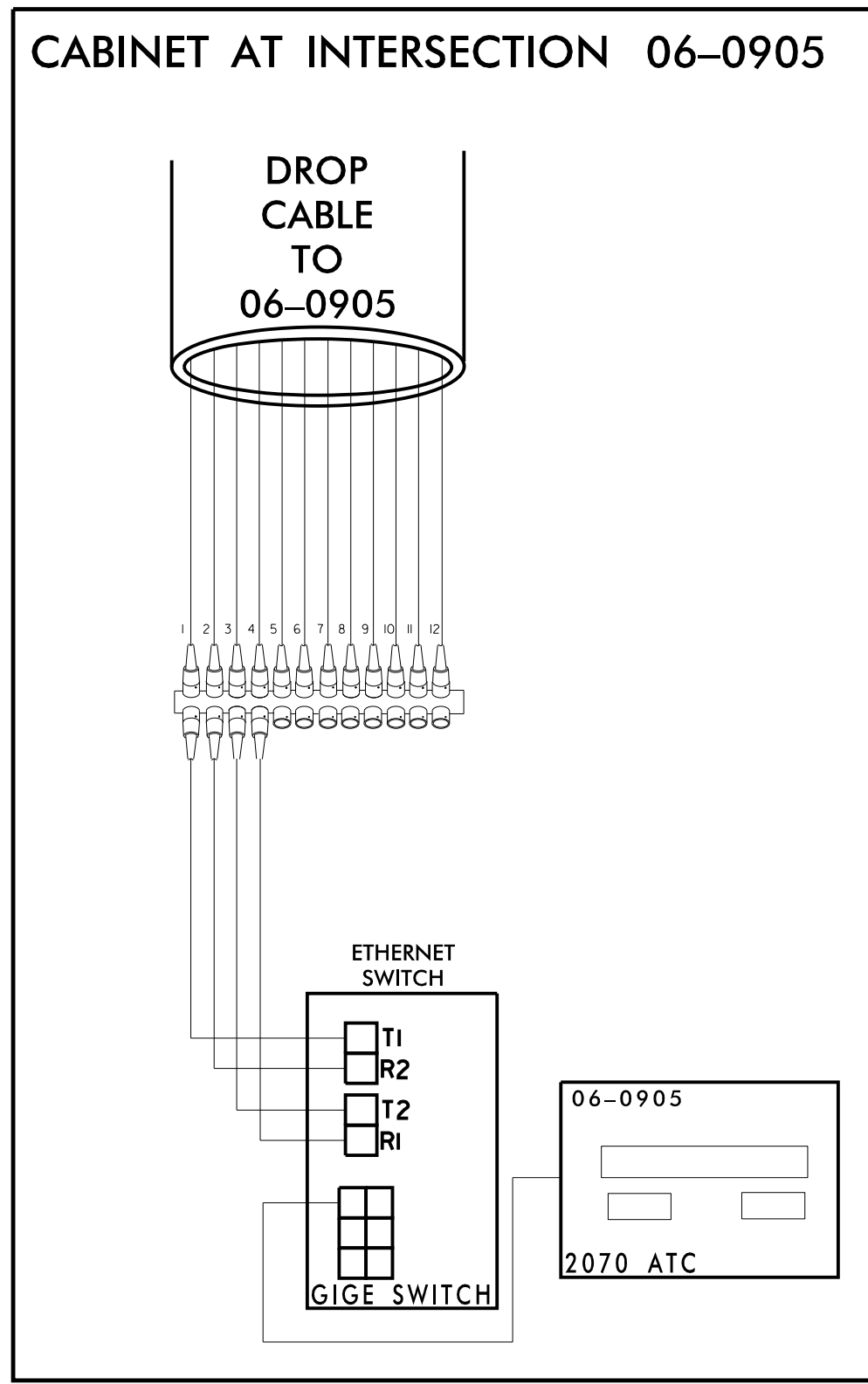
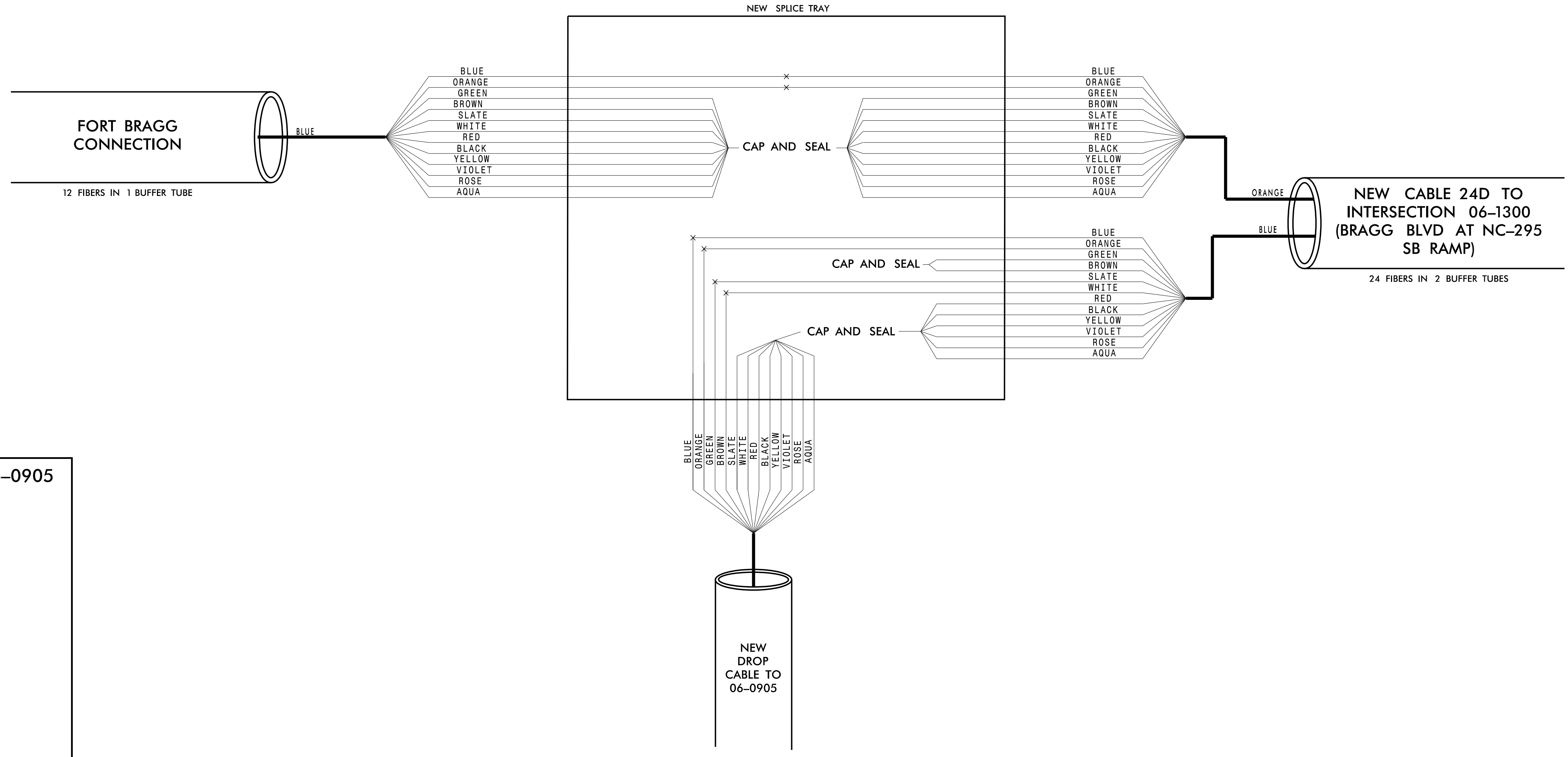

**CHANNEL 24  
FAYETTEVILLE COMPUTERIZED  
SIGNAL SYSTEM  
SPLICE DETAIL**

DIVISION 06 CUMBERLAND COUNTY

PLAN DATE: NOVEMBER 2016 REVIEWED BY: N. M. MENGELKOCH

PREPARED BY: KHA REVIEWED BY: K. W. SMITH

SCALE: 0

Kimley»Horn  
 NC License #F-0102  
 421 Fayetteville St., Suite 600  
 Raleigh, NC 27636  
 Tel: (919) 677-2000  
 Fax: (919) 677-2050

250 N. Greenfield Place, Garner, NC 27529

SEAL  
 NORTH CAROLINA PROFESSIONAL ENGINEER  
 KEVIN W. SMITH  
 SEAL 030472  
 11/15/2016

11/15/2016 K:\ARL\TPTD\ITS\01036305 - Fayetteville Sig Sys\Plans\Splicing\01036305-ITS-psk-224-Ch24 06-0905.dgn

**CHANNEL 25**  
**NEW SPLICE ENCLOSURE**  
**(MURCHISON RD SB RAMPS AT**  
**HONEYCUTT RD)**  
**SIG ID 06-0293**  
**SIG ID 06-1312**

**COLOR CODE**  
 TIA/EIA 598-C

|            |             |
|------------|-------------|
| (1) BLUE   | (7) RED     |
| (2) ORANGE | (8) BLACK   |
| (3) GREEN  | (9) YELLOW  |
| (4) BROWN  | (10) VIOLET |
| (5) SLATE  | (11) ROSE   |
| (6) WHITE  | (12) AQUA   |

**LEGEND**

X - FUSION SPLICE INDIVIDUAL FIBER  
 O - EXISTING SPLICE  
 □ - EXPRESS INDIVIDUAL FIBER

EXPRESS - EXPRESS ENTIRE BUFFER TUBE  
 SPLICE - SPLICE ENTIRE BUFFER TUBE OR MAINTAIN IF EXISTING EXPRESSED

**NOTES:**  
 1. FIBER INTERCONNECT CENTER RACKS ARE SCHEMATIC ONLY - ACTUAL EQUIPMENT FORM MAY VARY.  
 2. ETHERNET SWITCH TERMINATION CONFIGURATIONS ARE GENERIC. CONTRACTOR IS RESPONSIBLE FOR DETERMINING /ENSURING PROPER TERMINATION.  
 3. CONTRACTOR IS RESPONSIBLE FOR FIELD VERIFYING EXISTING SPlicing. THE CONTRACTOR SHALL COORDINATE WITH THE ENGINEER WHERE EXISTING SPlicing IS NOT AS EXPECTED.

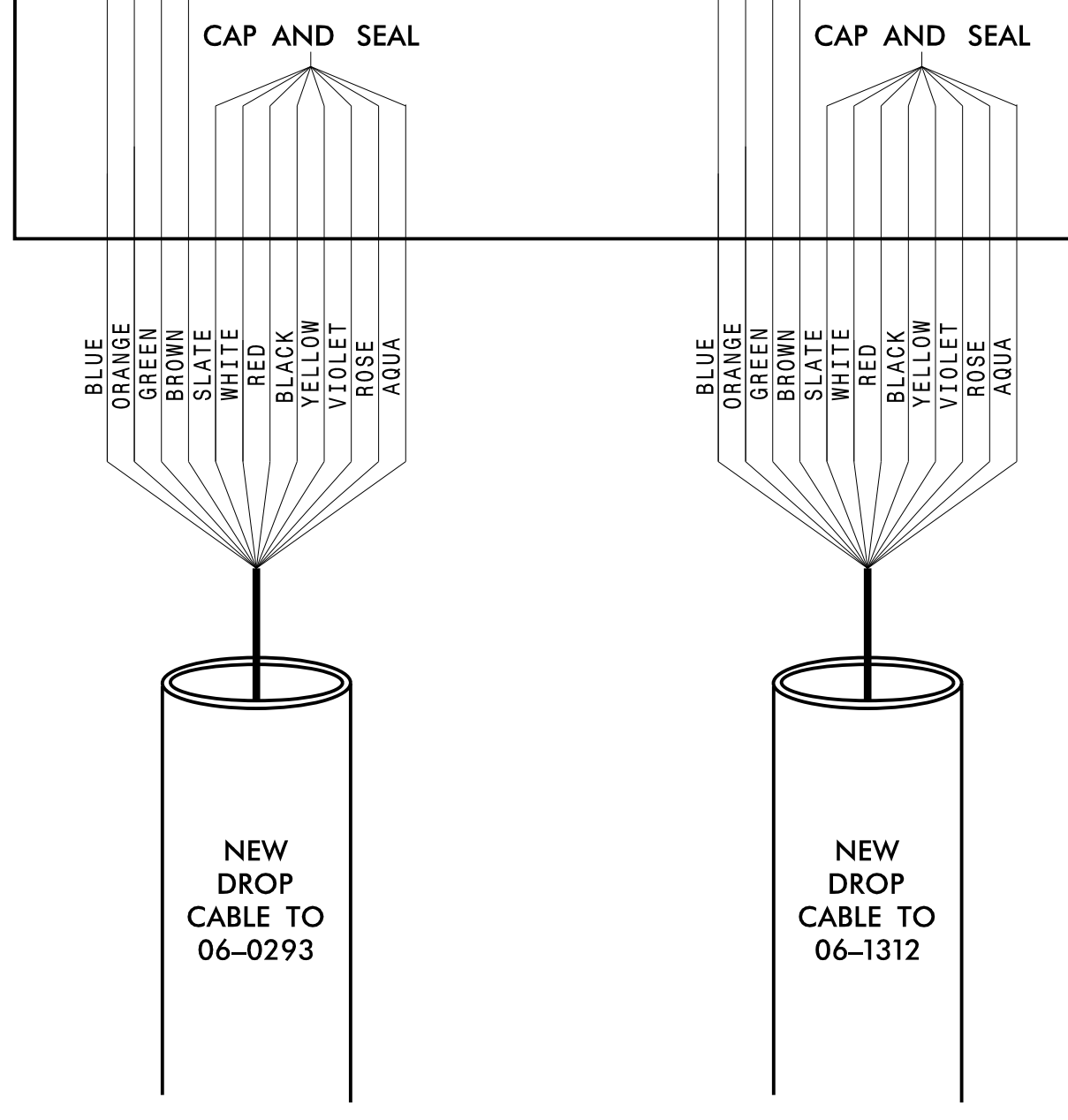
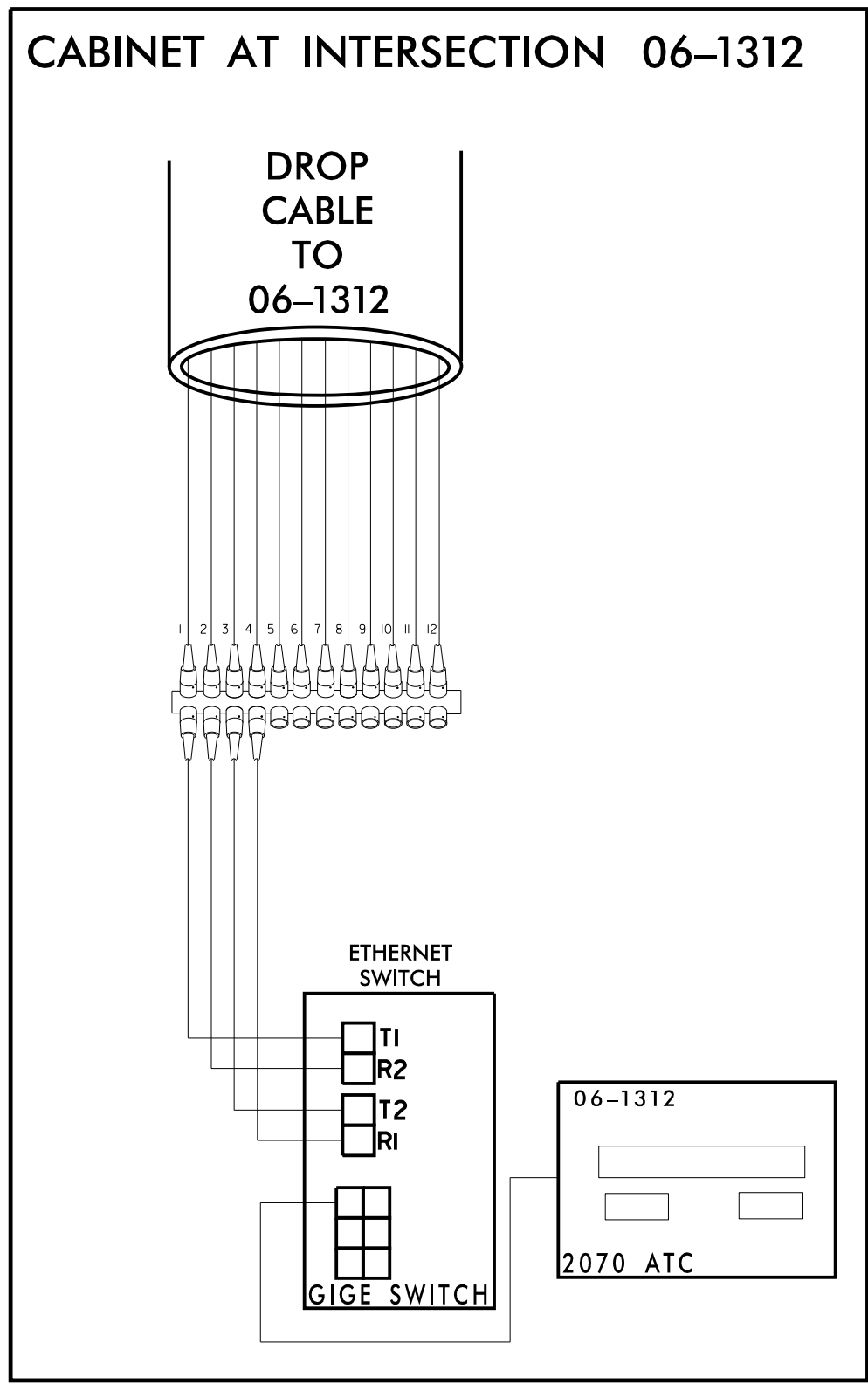
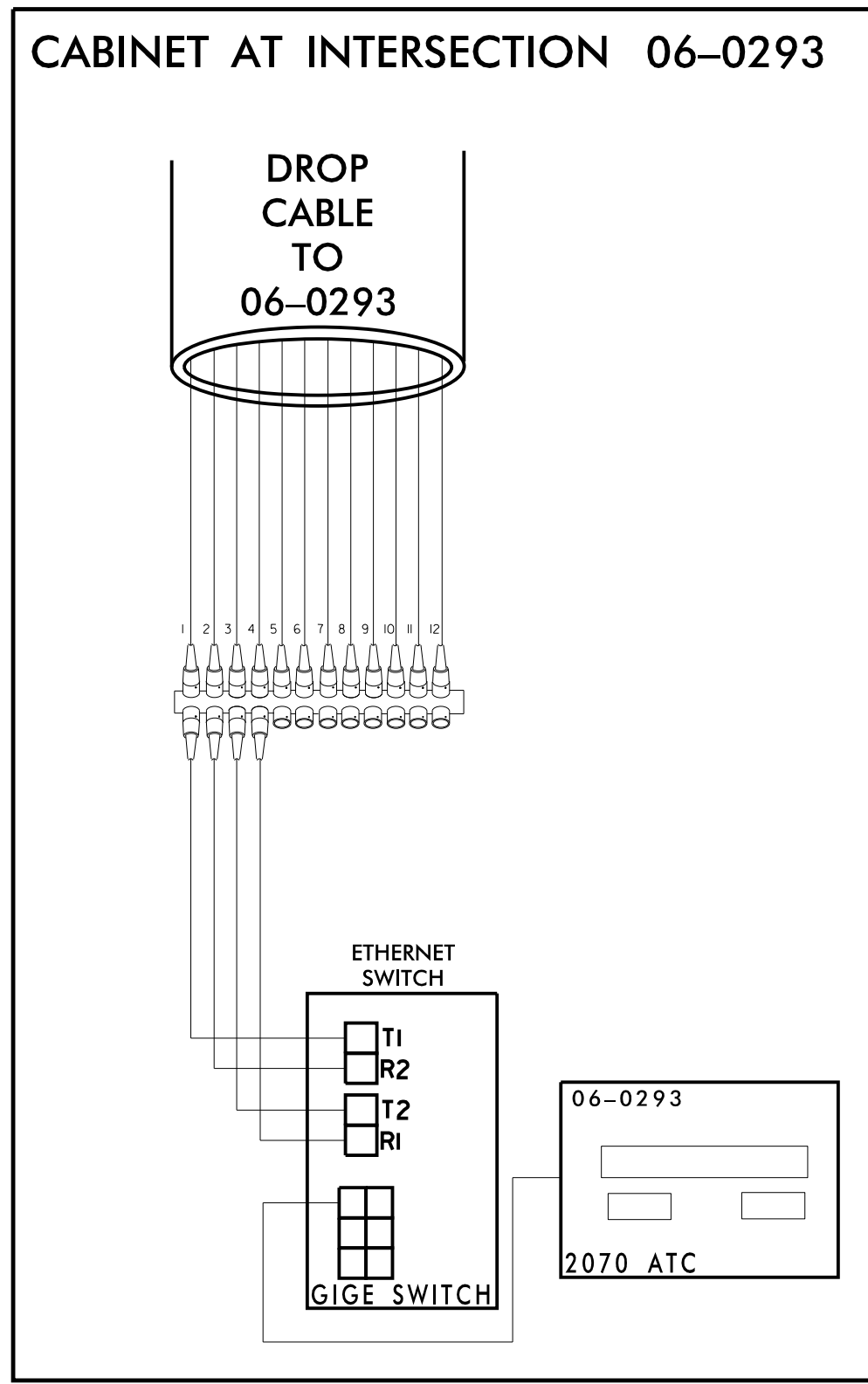
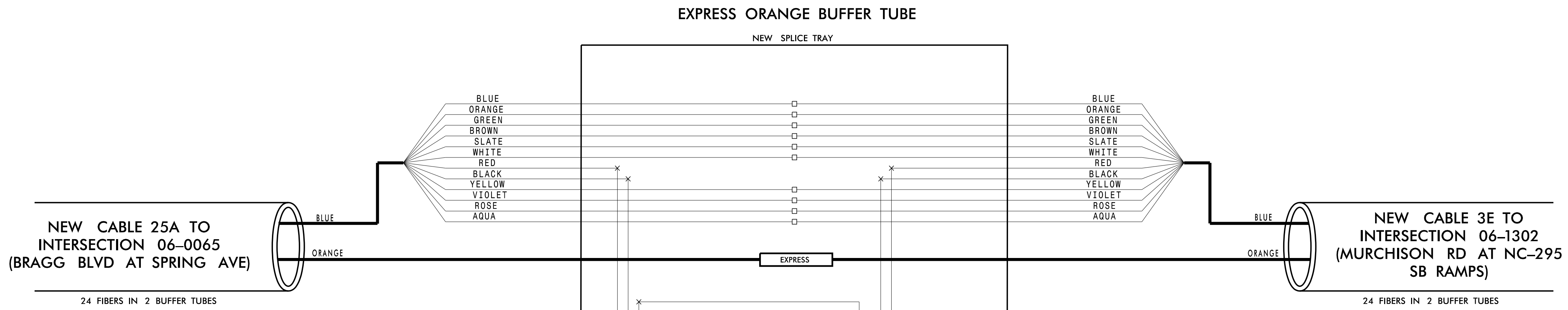

**CHANNEL 25**

**FAYETTEVILLE COMPUTERIZED SIGNAL SYSTEM**  
**SPLICE DETAIL**

DIVISION 06 CUMBERLAND COUNTY

PLAN DATE: NOVEMBER 2016 REVIEWED BY: N.M. MENGELKOCH

PREPARED BY: KHA REVIEWED BY: K.W. SMITH

SCALE: 0

REVISIONS: INIT. DATE

SEAL: NORTH CAROLINA PROFESSIONAL ENGINEER KEVIN W. SMITH SEAL 030472

Signature: Kevin W. Smith DATE: 11/15/2016

CADD File name:

**Kimley»Horn**  
 NC License #F-0102  
 421 Fayetteville St., Suite 600  
 Raleigh, NC 27636  
 Tel: (919) 677-2000  
 Fax: (919) 677-2050

11/15/2016 K:\ARL\TPTD\ITS\01036305 - Fayetteville Sig Sys\Plans\Splicing\01036305-ITS\_psh\_225-CH25\_06-1312\_and\_06-0293.dgn

**CHANNEL 25**  
**NEW SPICE ENCLOSURE**  
**(BRAGG BLVD AT SPRING AVE)**  
**SIG ID 06-0065**  
**CCTV 52**

**COLOR CODE**  
 TIA/EIA 598-C

|            |             |
|------------|-------------|
| (1) BLUE   | (7) RED     |
| (2) ORANGE | (8) BLACK   |
| (3) GREEN  | (9) YELLOW  |
| (4) BROWN  | (10) VIOLET |
| (5) SLATE  | (11) ROSE   |
| (6) WHITE  | (12) AQUA   |

**LEGEND**

X - FUSION SPlice INDIVIDUAL FIBER  
 O - EXISTING SPlice  
 □ - EXPRESS INDIVIDUAL FIBER

EXPRESS - EXPRESS ENTIRE BUFFER TUBE  
 SPlice - SPlice ENTIRE BUFFER TUBE OR MAINTAIN IF EXISTING EXPRESSED

**NOTES:**

- FIBER INTERCONNECT CENTER RACKS ARE SCHEMATIC ONLY - ACTUAL EQUIPMENT FORM MAY VARY.
- ETHERNET SWITCH TERMINATION CONFIGURATIONS ARE GENERIC. CONTRACTOR IS RESPONSIBLE FOR DETERMINING /ENSURING PROPER TERMINATION.
- CONTRACTOR IS RESPONSIBLE FOR FIELD VERIFYING EXISTING SPlicing. THE CONTRACTOR SHALL COORDINATE WITH THE ENGINEER WHERE EXISTING SPlicing IS NOT AS EXPECTED.

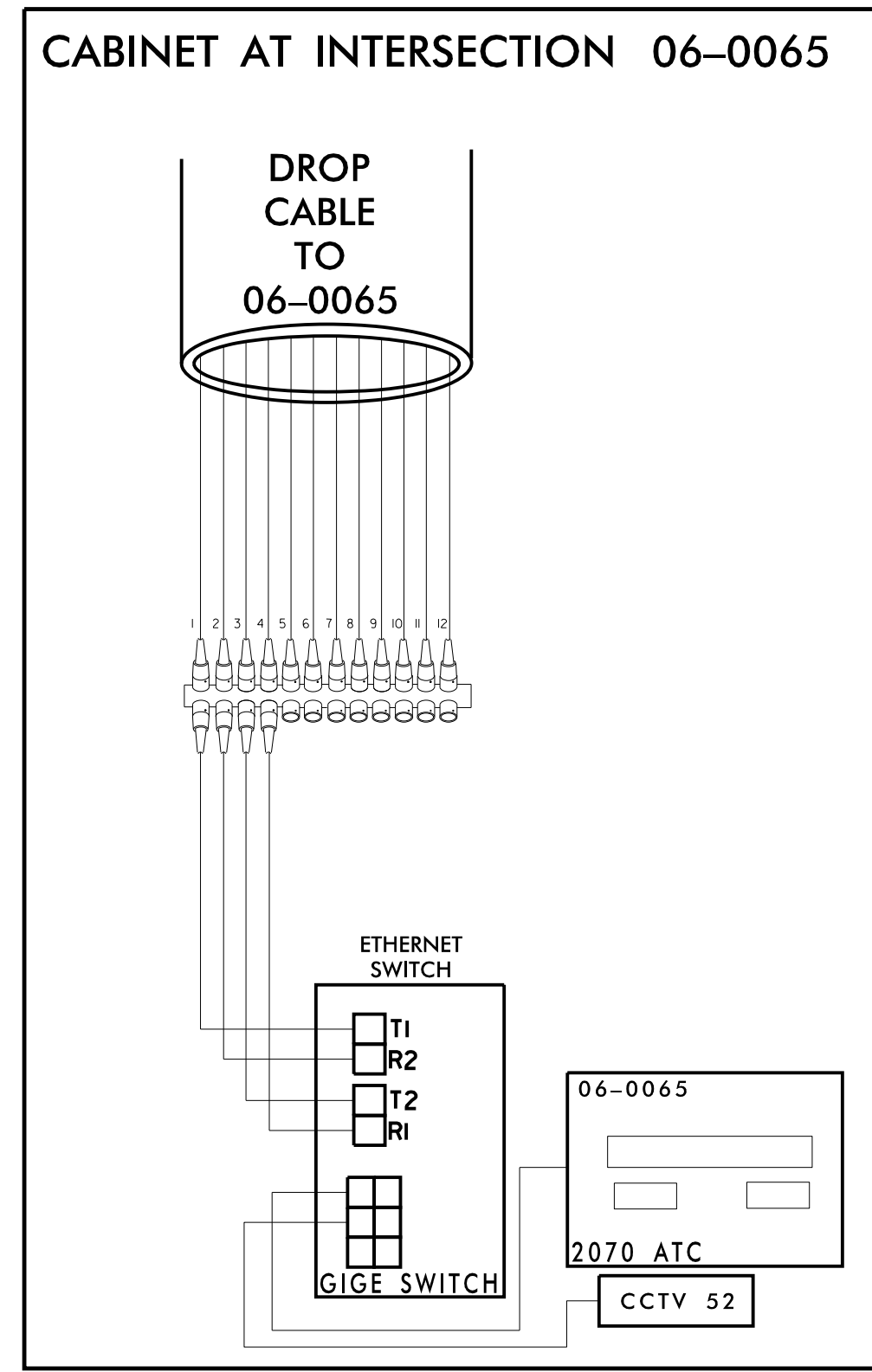
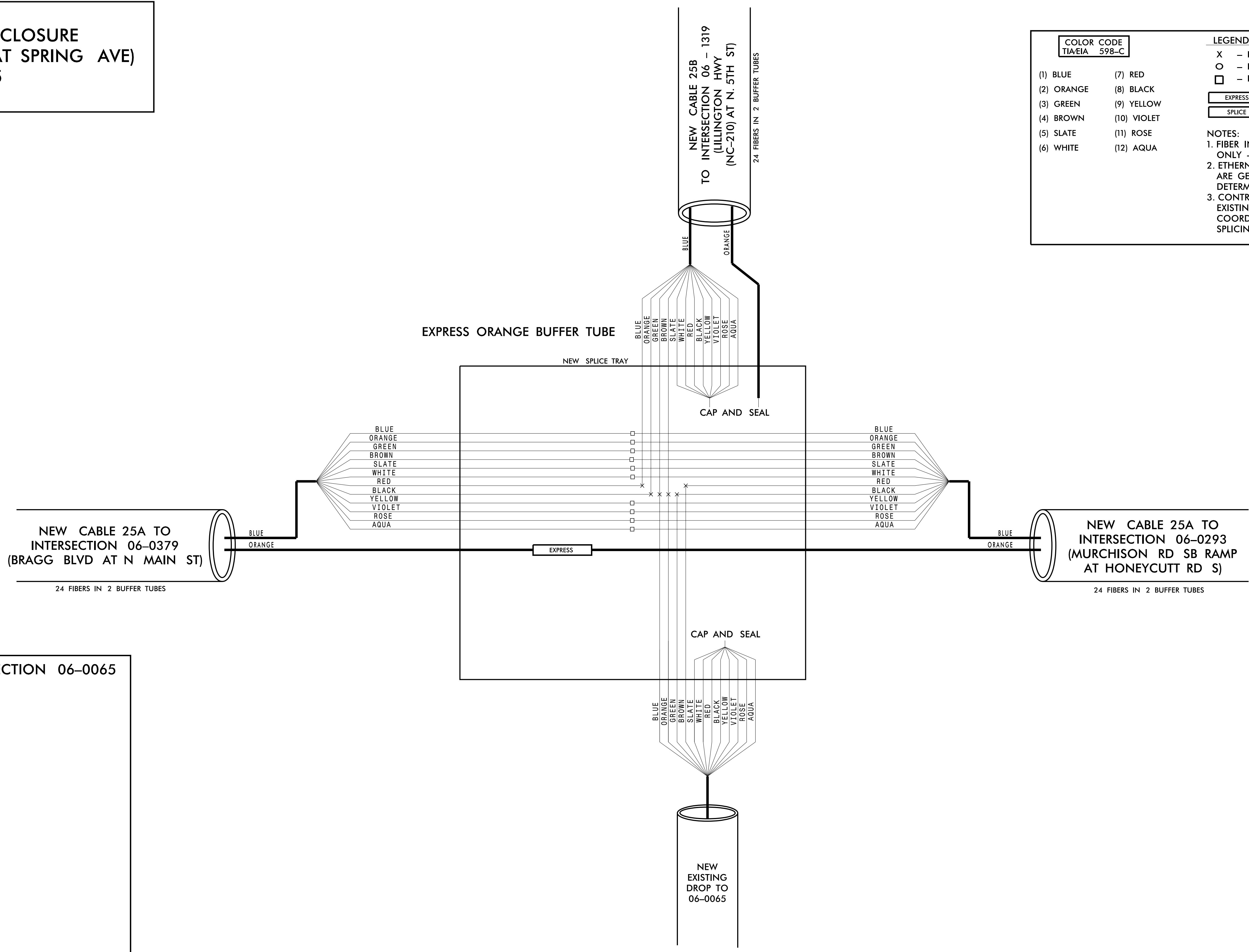

**CHANNEL 25**

**FAYETTEVILLE COMPUTERIZED SIGNAL SYSTEM**  
**SPlice DETAIL**

DIVISION 06 CUMBERLAND COUNTY

PLAN DATE: NOVEMBER 2016 REVIEWED BY: N.M. MENGELKOCH

PREPARED BY: KHA REVIEWED BY: K.W. SMITH

| REVISIONS | INIT. | DATE |
|-----------|-------|------|
|           |       |      |

SCALE: 0

**Kimley»Horn**  
 NC License #F-0102  
 421 Fayetteville St., Suite 600  
 Raleigh, NC 27636  
 Tel: (919) 677-2000  
 Fax: (919) 677-2050

SEAL  
 NORTH CAROLINA PROFESSIONAL ENGINEER  
 SEAL 030472  
 KEVIN W. SMITH  
 11/15/2016

11/15/2016 K:\ARL\TPTD\ITS\01036305 - Fayetteville Sig Sys\Plans\Splicing\01036305-ITS-psr-226-CH25-06-0065 CCTV52.dgn

**CHANNEL 25  
NEW SPLICE ENCLOSURE  
(LILLINGTON HWY (NC-210)  
AT N. 5TH ST.)  
SIG ID 06-1319**

**CHANNEL 25  
NEW SPLICE ENCLOSURE  
(LILLINGTON HWY (NC-210) AT  
LAKE PARK DR (WAL-MART  
ENTRANCE))  
SIG ID 06-1252**

**COLOR CODE**  
TIA/EIA 598-C

|            |             |
|------------|-------------|
| (1) BLUE   | (7) RED     |
| (2) ORANGE | (8) BLACK   |
| (3) GREEN  | (9) YELLOW  |
| (4) BROWN  | (10) VIOLET |
| (5) SLATE  | (11) ROSE   |
| (6) WHITE  | (12) AQUA   |

**LEGEND**

X - FUSION SPLICE INDIVIDUAL FIBER  
 O - EXISTING SPLICE  
 □ - EXPRESS INDIVIDUAL FIBER

EXPRESS - EXPRESS ENTIRE BUFFER TUBE  
 SPLICE - SPLICE ENTIRE BUFFER TUBE OR MAINTAIN IF EXISTING EXPRESSED

**NOTES:**

- FIBER INTERCONNECT CENTER RACKS ARE SCHEMATIC ONLY - ACTUAL EQUIPMENT FORM MAY VARY.
- ETHERNET SWITCH TERMINATION CONFIGURATIONS ARE GENERIC. CONTRACTOR IS RESPONSIBLE FOR DETERMINING /ENSURING PROPER TERMINATION.
- CONTRACTOR IS RESPONSIBLE FOR FIELD VERIFYING EXISTING SPLICING. THE CONTRACTOR SHALL COORDINATE WITH THE ENGINEER WHERE EXISTING SPLICING IS NOT AS EXPECTED.

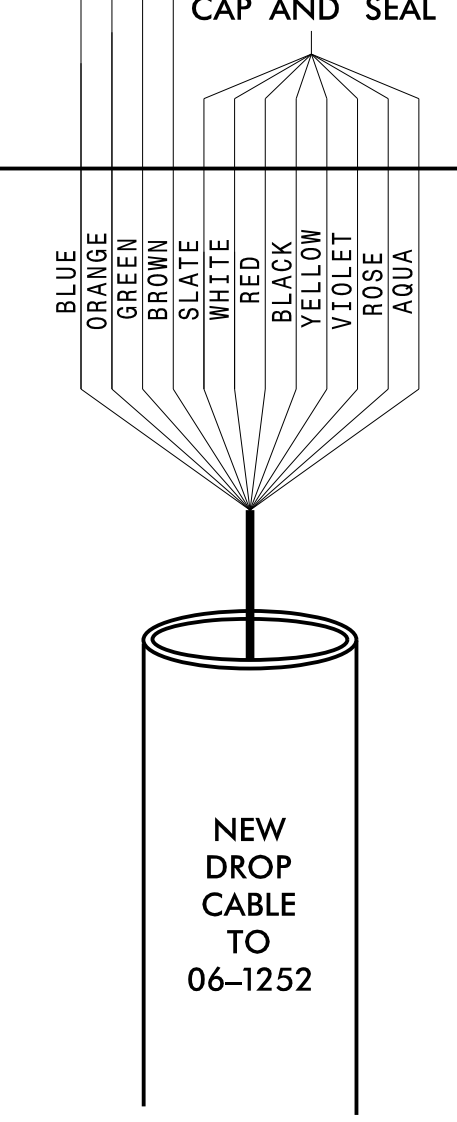
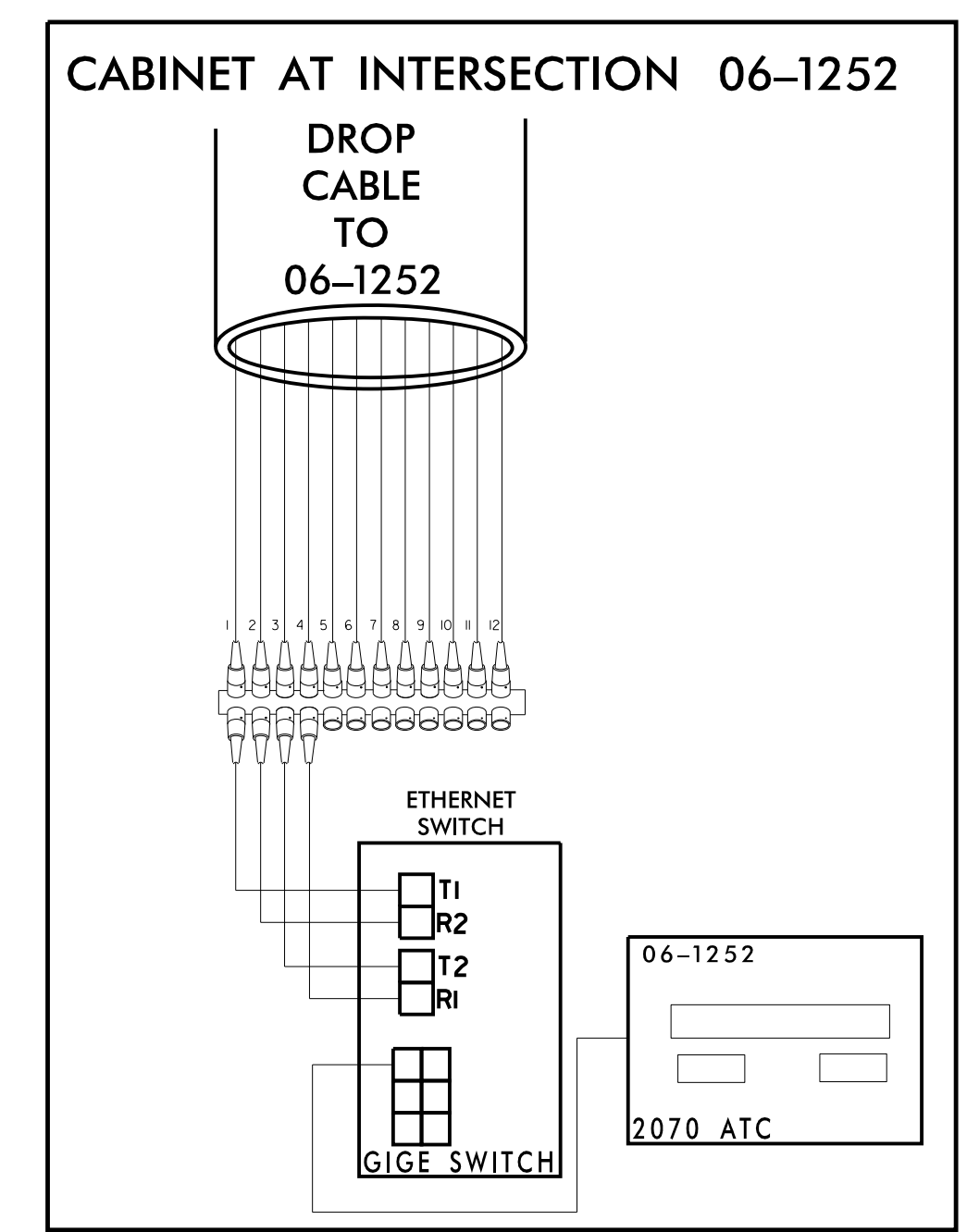
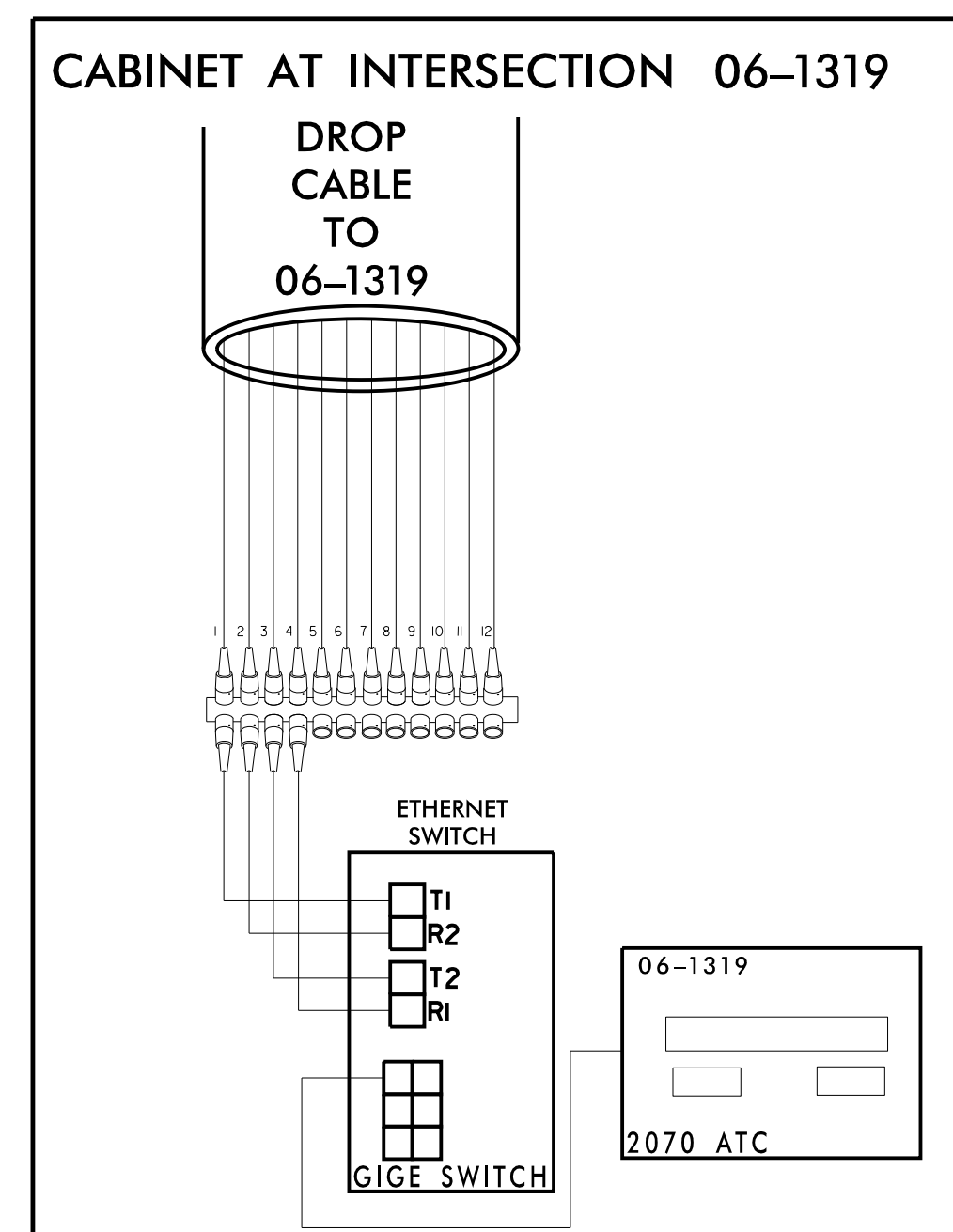
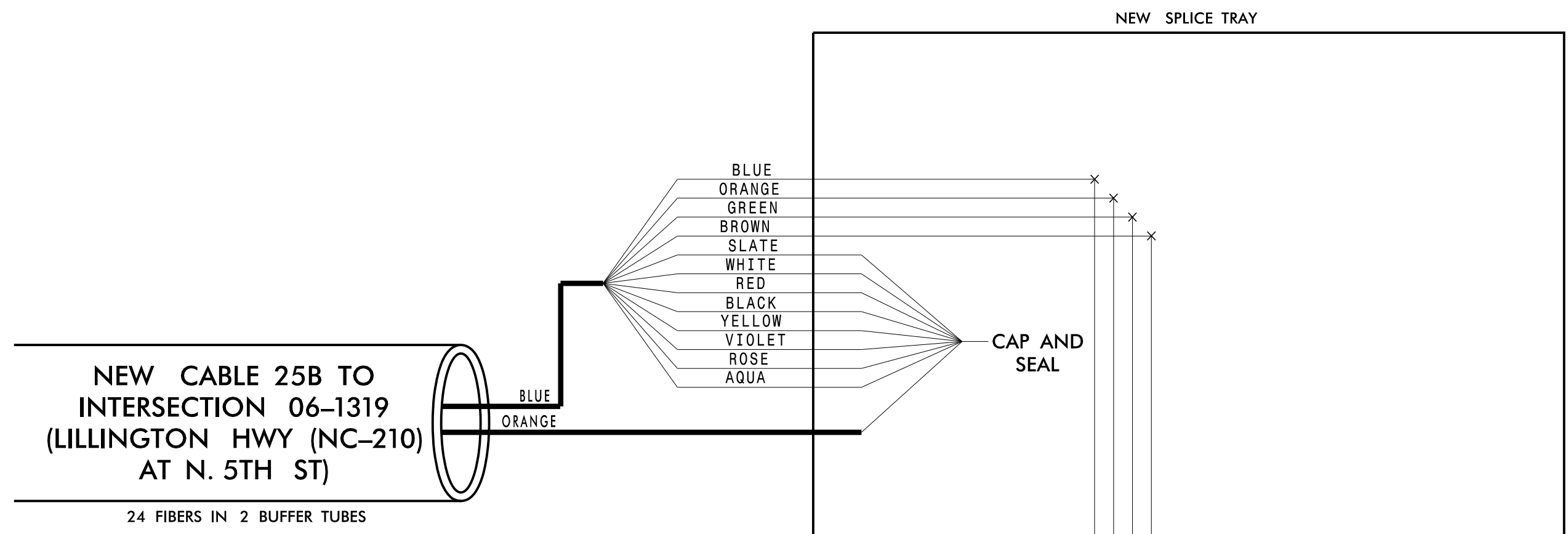
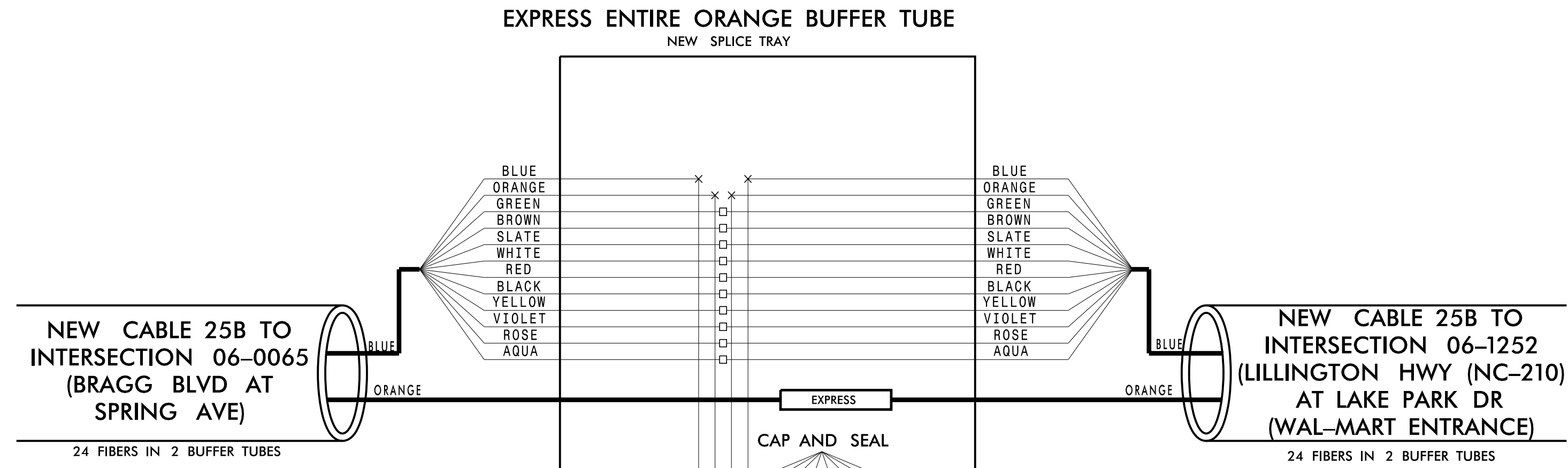

**CHANNEL 25  
FAYETTEVILLE COMPUTERIZED  
SIGNAL SYSTEM  
SPLICE DETAIL**

**SEAL**  
NORTH CAROLINA PROFESSIONAL ENGINEER  
KEVIN W. SMITH  
SEAL 030472

**Division 06 CUMBERLAND COUNTY**

PLAN DATE: NOVEMBER 2016 REVIEWED BY: N. M. MENGELKOCH  
 PREPARED BY: KHA REVIEWED BY: K. W. SMITH

| REVISIONS | INIT. | DATE |
|-----------|-------|------|
|           |       |      |

DocuSigned By: Kevin W. Smith  
 0688E0483B0440E  
 SIGNATURE DATE 11/15/2016  
 CADD File name:

**Kimley»Horn**  
 NC License #F-0102  
 421 Fayetteville St., Suite 600  
 Raleigh, NC 27636  
 Tel: (919) 677-2000  
 Fax: (919) 677-2050

11/15/2016 K:\ARL\TPTD\ITS\01036305 - Fayetteville Sig Sys\Plans\Splicing\01036305-ITS\_psh-227-CH25\_06-1252.dgn

**CHANNEL 25  
NEW SPLICE ENCLOSURE  
(BRAGG BLVD AT N MAIN ST)  
SIG ID 06-0379**

**COLOR CODE**  
TIA/EIA 598-C

|            |             |
|------------|-------------|
| (1) BLUE   | (7) RED     |
| (2) ORANGE | (8) BLACK   |
| (3) GREEN  | (9) YELLOW  |
| (4) BROWN  | (10) VIOLET |
| (5) SLATE  | (11) ROSE   |
| (6) WHITE  | (12) AQUA   |

**LEGEND**

X - FUSION SPLICE INDIVIDUAL FIBER  
 O - EXISTING SPLICE  
 □ - EXPRESS INDIVIDUAL FIBER

EXPRESS - EXPRESS ENTIRE BUFFER TUBE  
 SPLICE - SPLICE ENTIRE BUFFER TUBE OR MAINTAIN IF EXISTING EXPRESSED

**NOTES:**  
 1. FIBER INTERCONNECT CENTER RACKS ARE SCHEMATIC ONLY - ACTUAL EQUIPMENT FORM MAY VARY.  
 2. ETHERNET SWITCH TERMINATION CONFIGURATIONS ARE GENERIC. CONTRACTOR IS RESPONSIBLE FOR DETERMINING /ENSURING PROPER TERMINATION.  
 3. CONTRACTOR IS RESPONSIBLE FOR FIELD VERIFYING EXISTING SPLICING. THE CONTRACTOR SHALL COORDINATE WITH THE ENGINEER WHERE EXISTING SPLICING IS NOT AS EXPECTED.

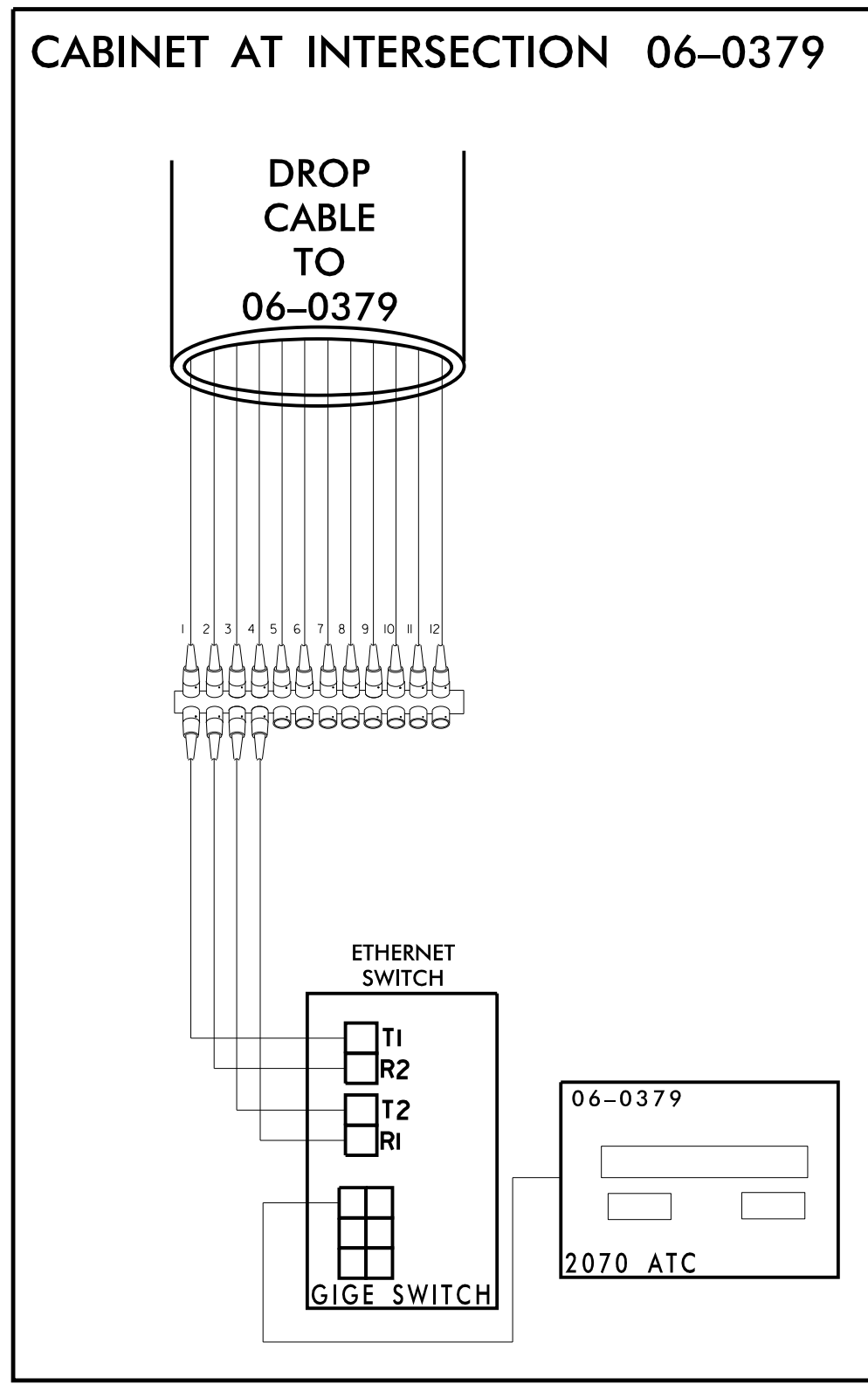
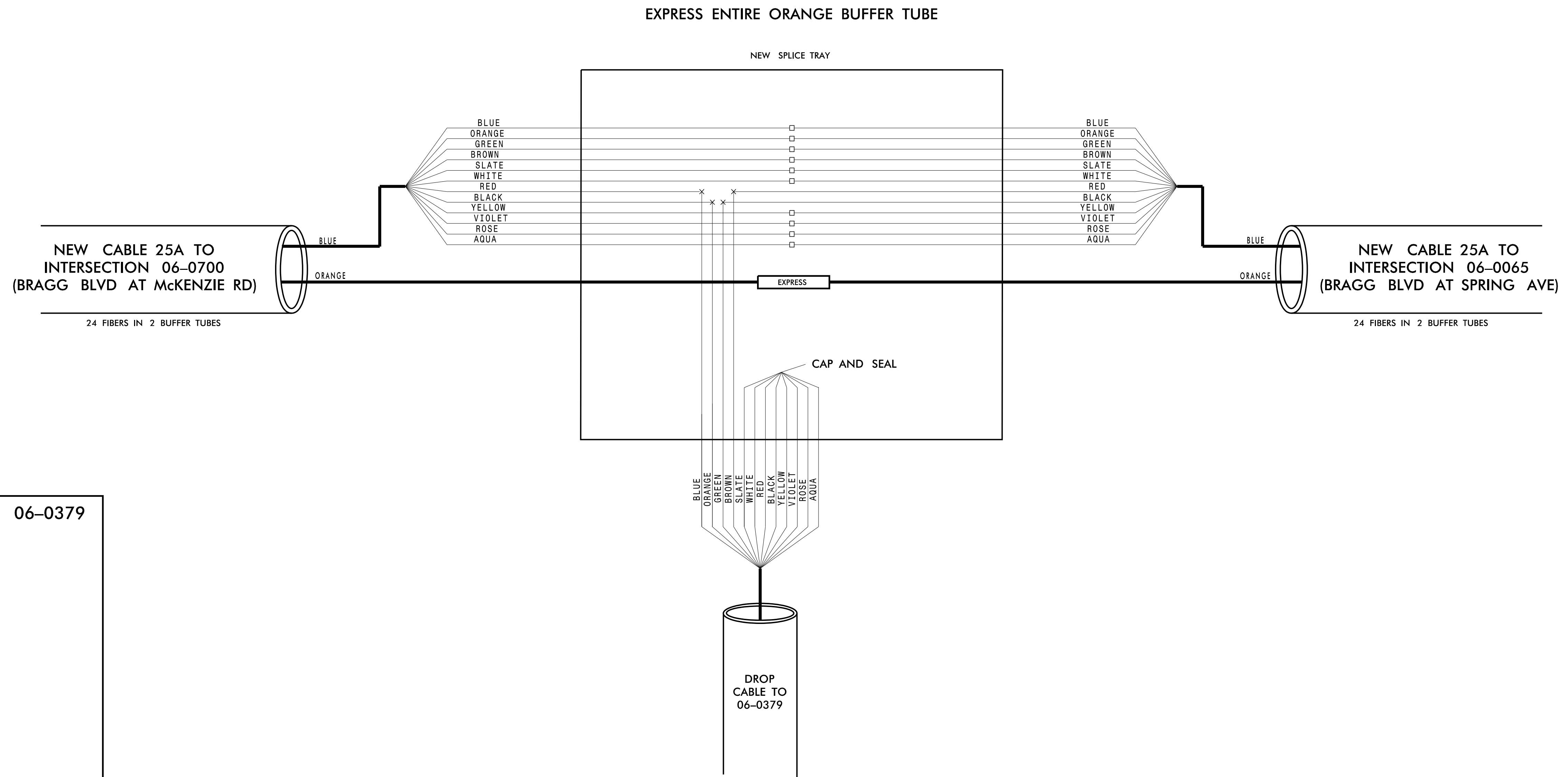

11/15/2016 K:\ARL\TPTD\ITS\01036305 - Fayetteville Sig Sys\Plans\Splicing\01036305-ITS-psk-228-CH25-06-0379.dgn

**CHANNEL 25**

**FAYETTEVILLE COMPUTERIZED SIGNAL SYSTEM  
SPLICE DETAIL**

DIVISION 06 CUMBERLAND COUNTY

PLAN DATE: NOVEMBER 2016 REVIEWED BY: N. M. MENGELKOCH

PREPARED BY: KHA REVIEWED BY: K. W. SMITH

250 N. Greenfield Place, Garner, NC 27529

SCALE: 0

REVISIONS: INIT. DATE

DocuSigned by: Kevin Smith 11/15/2016

0686E483B0440F SIGNATURE DATE

CADD File name:

**Kimley»Horn**  
 NC License #F-0102  
 421 Fayetteville St., Suite 600  
 Raleigh, NC 27636  
 Tel: (919) 677-2000  
 Fax: (919) 677-2050



**CHANNEL 25**  
**NEW SPLICE ENCLOSURE**  
**(BRAGG BLVD AT McKENZIE RD)**  
**SIG ID 06-0700**

**COLOR CODE**  
 TIA/EIA 598-C

|            |             |
|------------|-------------|
| (1) BLUE   | (7) RED     |
| (2) ORANGE | (8) BLACK   |
| (3) GREEN  | (9) YELLOW  |
| (4) BROWN  | (10) VIOLET |
| (5) SLATE  | (11) ROSE   |
| (6) WHITE  | (12) AQUA   |

**LEGEND**

X - FUSION SPLICE INDIVIDUAL FIBER  
 O - EXISTING SPLICE  
 □ - EXPRESS INDIVIDUAL FIBER

EXPRESS - EXPRESS ENTIRE BUFFER TUBE  
 SPLICE - SPLICE ENTIRE BUFFER TUBE OR MAINTAIN IF EXISTING EXPRESSED

**NOTES:**

- FIBER INTERCONNECT CENTER RACKS ARE SCHEMATIC ONLY - ACTUAL EQUIPMENT FORM MAY VARY.
- ETHERNET SWITCH TERMINATION CONFIGURATIONS ARE GENERIC. CONTRACTOR IS RESPONSIBLE FOR DETERMINING /ENSURING PROPER TERMINATION.
- CONTRACTOR IS RESPONSIBLE FOR FIELD VERIFYING EXISTING SPLICING. THE CONTRACTOR SHALL COORDINATE WITH THE ENGINEER WHERE EXISTING SPLICING IS NOT AS EXPECTED.

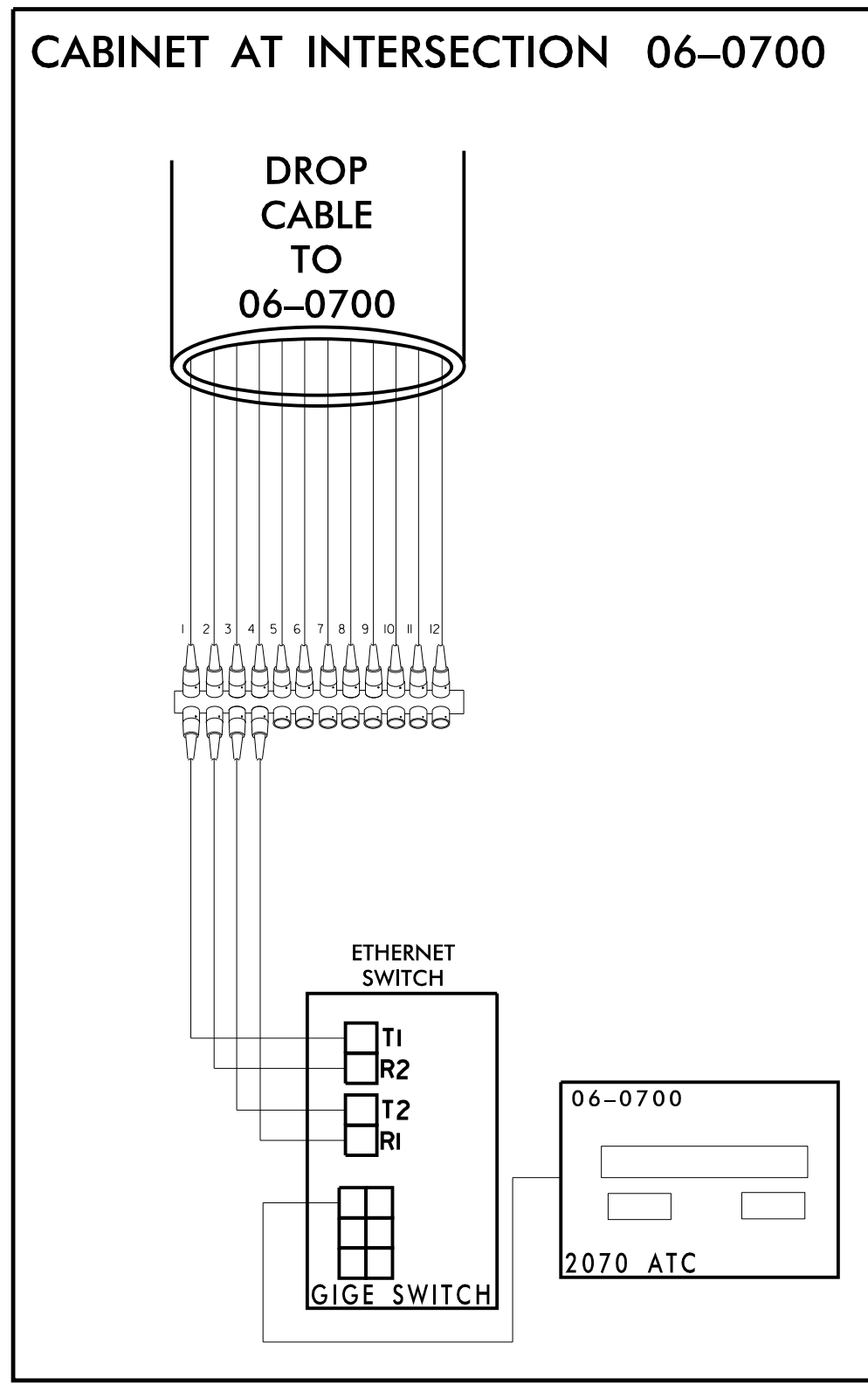
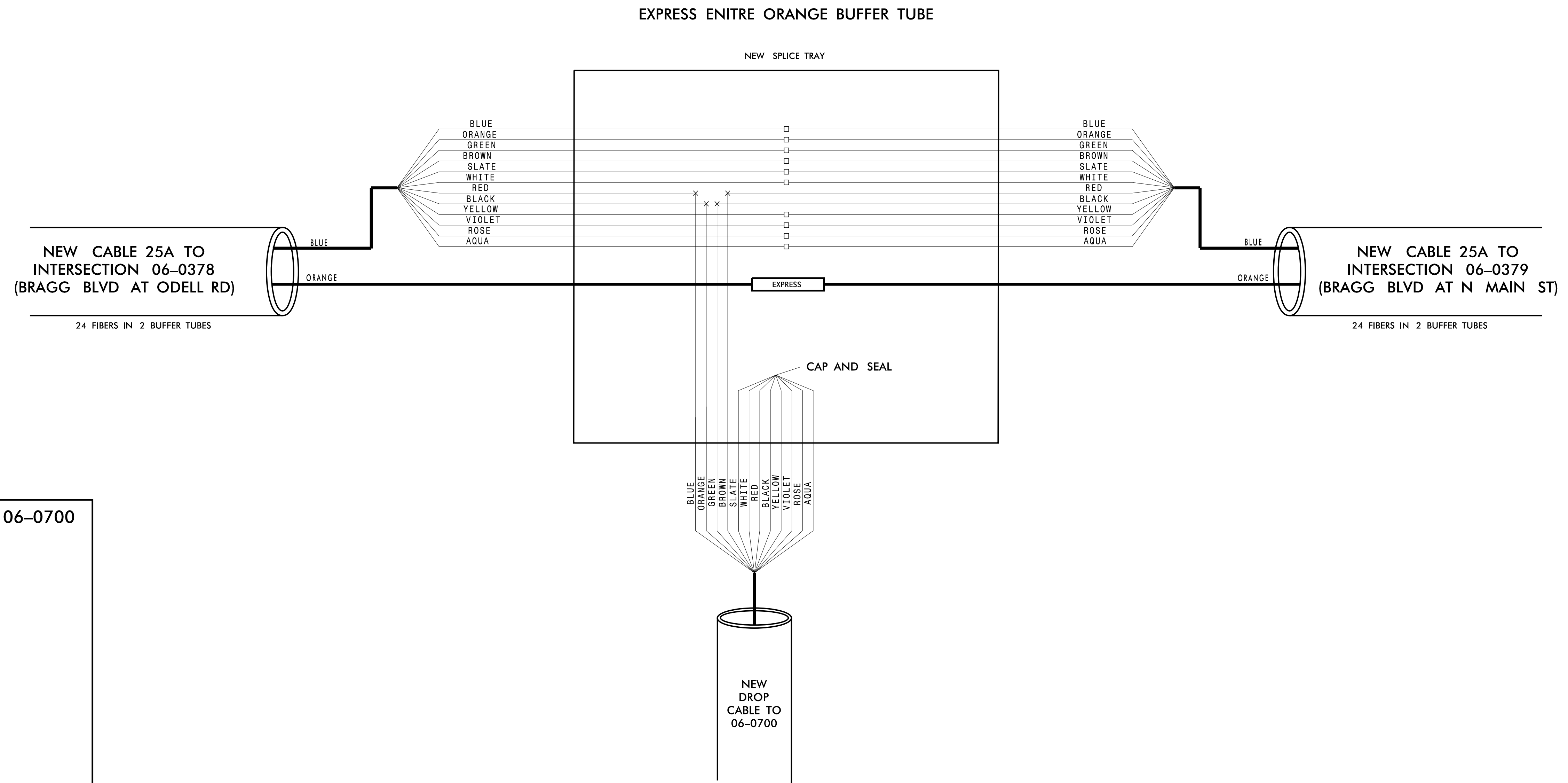

11/15/2016 K:\ARL\TPTD\ITS\01036305 - Fayetteville Sig Sys\Plans\Splicing\01036305-ITS-psk-229-CH25-06-0700.dgn

**CHANNEL 25**

**FAYETTEVILLE COMPUTERIZED SIGNAL SYSTEM**  
**SPLICE DETAIL**

DIVISION 06 CUMBERLAND COUNTY

PLAN DATE: NOVEMBER 2016 REVIEWED BY: N. W. MENGELKOCH

PREPARED BY: KHA REVIEWED BY: K. W. SMITH

250 N. Greenfield Place, Garner, NC 27529

SCALE: 0

**Kimley»Horn**  
 NC License #F-0102  
 421 Fayetteville St., Suite 600  
 Raleigh, NC 27636  
 Tel: (919) 677-2000  
 Fax: (919) 677-2050

**SEAL**  
 NORTH CAROLINA PROFESSIONAL ENGINEER  
 KEVIN W. SMITH  
 SEAL 030472  
 11/15/2016

**CHANNEL 25**  
**NEW SPLICE ENCLOSURE**  
**(BRAGG BLVD AT ODELL RD)**  
**SIG ID 06-0378**

**COLOR CODE**  
 TIA/EIA 598-C

|            |             |
|------------|-------------|
| (1) BLUE   | (7) RED     |
| (2) ORANGE | (8) BLACK   |
| (3) GREEN  | (9) YELLOW  |
| (4) BROWN  | (10) VIOLET |
| (5) SLATE  | (11) ROSE   |
| (6) WHITE  | (12) AQUA   |

**LEGEND**

- X - FUSION SPLICE INDIVIDUAL FIBER
- O - EXISTING SPLICE
- - EXPRESS INDIVIDUAL FIBER
- EXPRESS - EXPRESS ENTIRE BUFFER TUBE
- SPLICE - SPLICE ENTIRE BUFFER TUBE OR MAINTAIN IF EXISTING EXPRESSED

**NOTES:**

- FIBER INTERCONNECT CENTER RACKS ARE SCHEMATIC ONLY - ACTUAL EQUIPMENT FORM MAY VARY.
- ETHERNET SWITCH TERMINATION CONFIGURATIONS ARE GENERIC. CONTRACTOR IS RESPONSIBLE FOR DETERMINING /ENSURING PROPER TERMINATION.
- CONTRACTOR IS RESPONSIBLE FOR FIELD VERIFYING EXISTING SPLICING. THE CONTRACTOR SHALL COORDINATE WITH THE ENGINEER WHERE EXISTING SPLICING IS NOT AS EXPECTED.

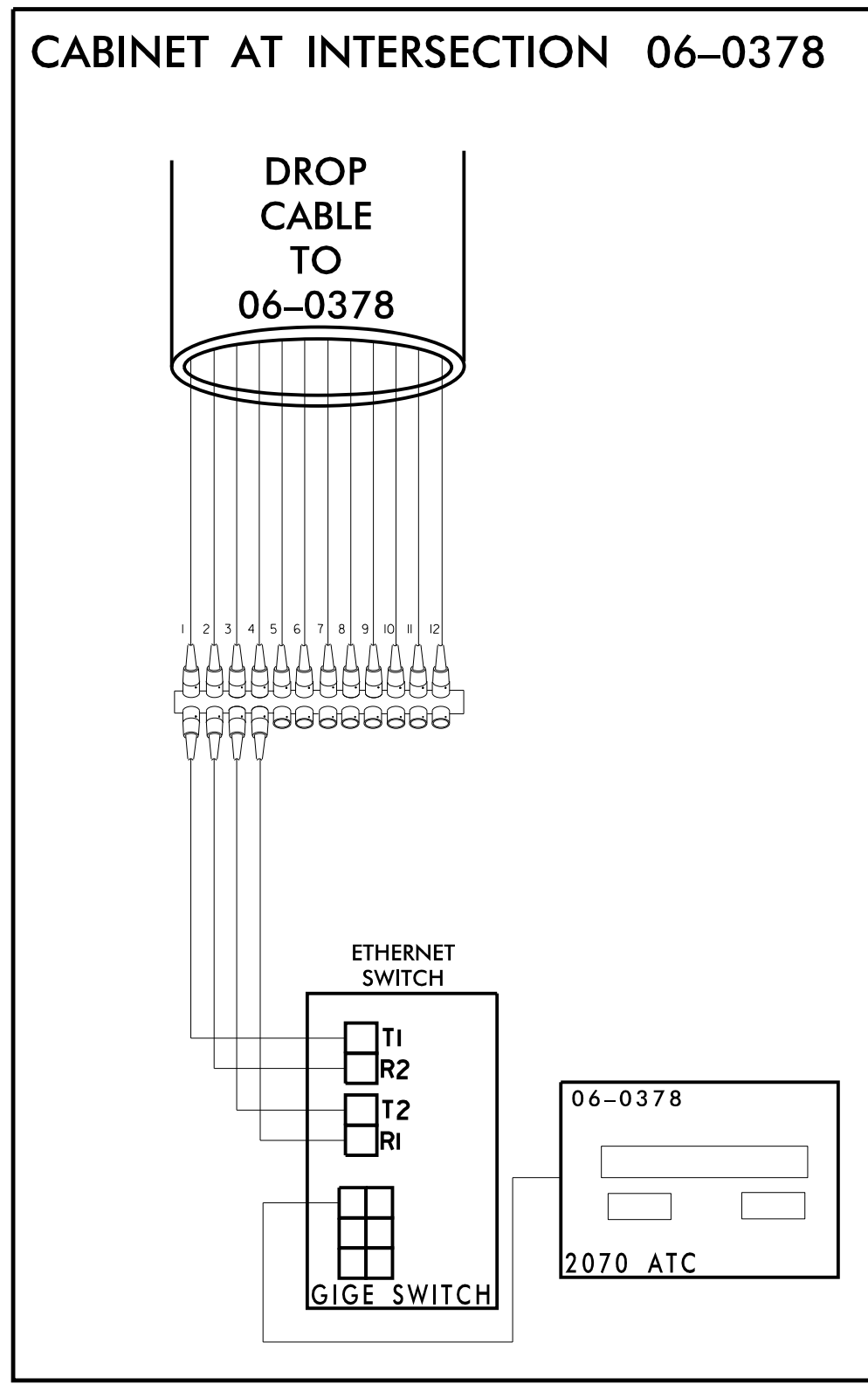
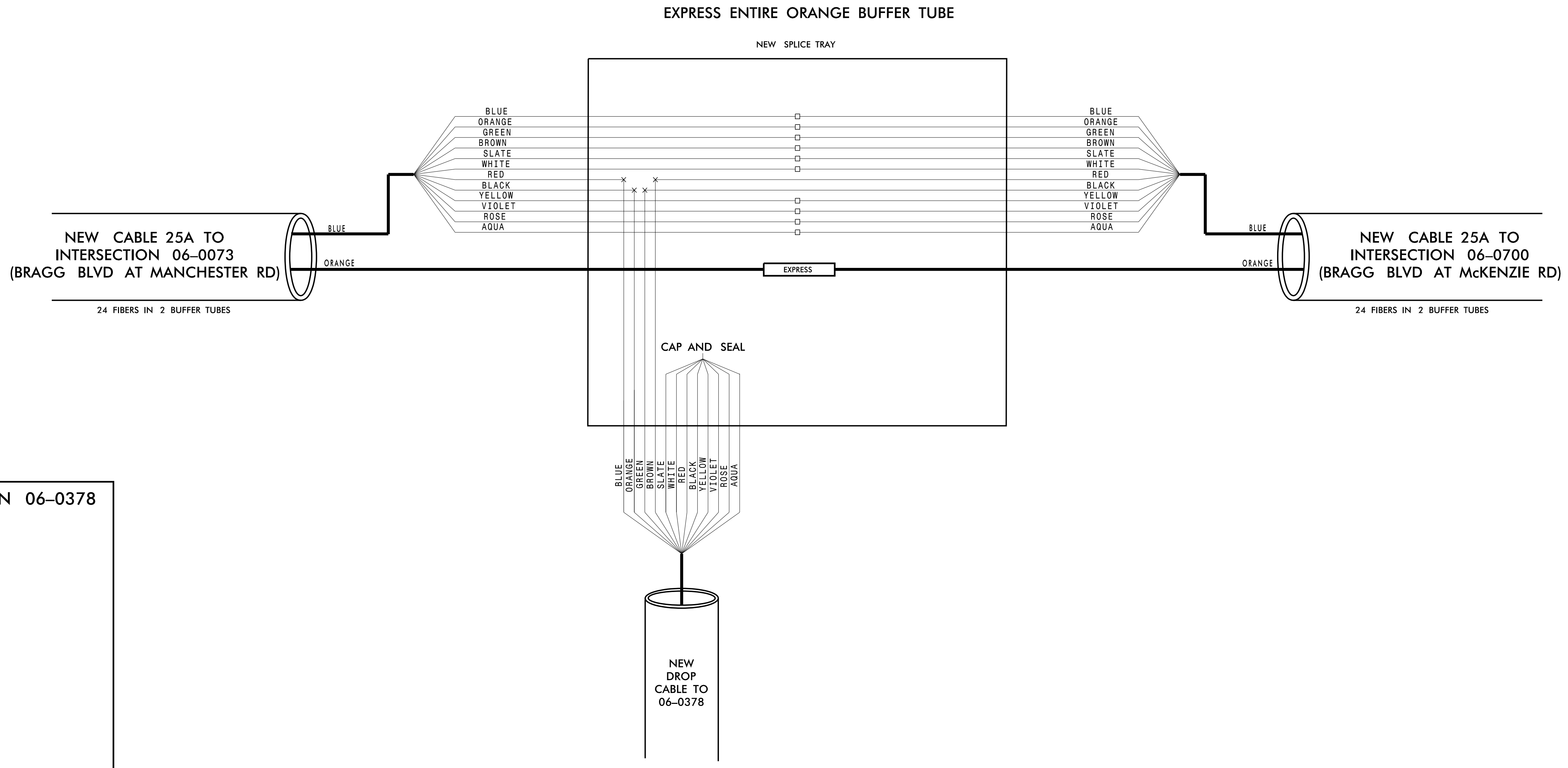

**CHANNEL 25**

**FAYETTEVILLE COMPUTERIZED SIGNAL SYSTEM**

**SPLICE DETAIL**

|                          |                               |                   |                          |
|--------------------------|-------------------------------|-------------------|--------------------------|
| DIVISION 06              |                               | CUMBERLAND COUNTY |                          |
| PLAN DATE: NOVEMBER 2016 | REVIEWED BY: N. M. MENGELKOCH | PREPARED BY: KHA  | REVIEWED BY: K. W. SMITH |
| REVISIONS                | INIT.                         | DATE              |                          |

Seal 030472  
 KEVIN W. SMITH  
 ENGINEER

DocuSigned By:  
 Kevin Smith  
 0688E04E3B0440E  
 SIGNATURE DATE  
 11/15/2016

CADD File name:

**Kimley»Horn**  
 NC License #F-0102  
 421 Fayetteville St., Suite 600  
 Raleigh, NC 27636  
 Tel: (919) 677-2000  
 Fax: (919) 677-2050

11/15/2016 K:\ARL\TPTD\ITS\01036305 - Fayetteville Sig Sys\Plans\Splicing\01036305-ITS\_psh-230-CH25\_06-0378.dgn

**CHANNEL 25**  
**EXISTING SPLICE ENCLOSURE**  
**(BRAGG BLVD AT MANCHESTER RD)**  
**SIG ID 06-0073**  
**CCTV 53**

**COLOR CODE**  
 TIA/EIA 598-C

|            |             |
|------------|-------------|
| (1) BLUE   | (7) RED     |
| (2) ORANGE | (8) BLACK   |
| (3) GREEN  | (9) YELLOW  |
| (4) BROWN  | (10) VIOLET |
| (5) SLATE  | (11) ROSE   |
| (6) WHITE  | (12) AQUA   |

**LEGEND**

X - FUSION SPLICE INDIVIDUAL FIBER  
 O - EXISTING SPLICE  
 □ - EXPRESS INDIVIDUAL FIBER

EXPRESS - EXPRESS ENTIRE BUFFER TUBE  
 SPLICE - SPLICE ENTIRE BUFFER TUBE OR MAINTAIN IF EXISTING EXPRESSED

**NOTES:**

- FIBER INTERCONNECT CENTER RACKS ARE SCHEMATIC ONLY - ACTUAL EQUIPMENT FORM MAY VARY.
- ETHERNET SWITCH TERMINATION CONFIGURATIONS ARE GENERIC. CONTRACTOR IS RESPONSIBLE FOR DETERMINING /ENSURING PROPER TERMINATION.
- CONTRACTOR IS RESPONSIBLE FOR FIELD VERIFYING EXISTING SPlicing. THE CONTRACTOR SHALL COORDINATE WITH THE ENGINEER WHERE EXISTING SPlicing IS NOT AS EXPECTED.

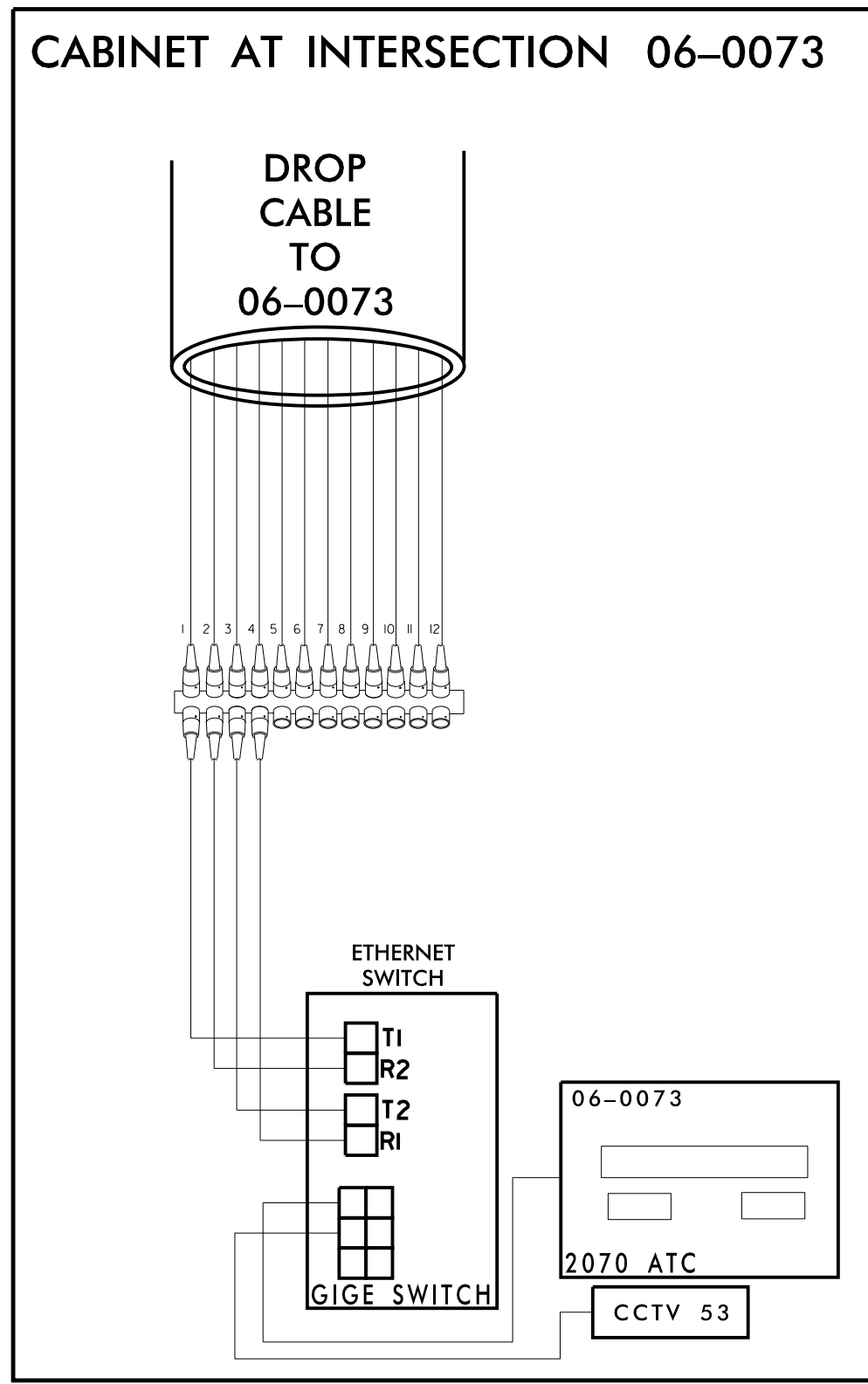
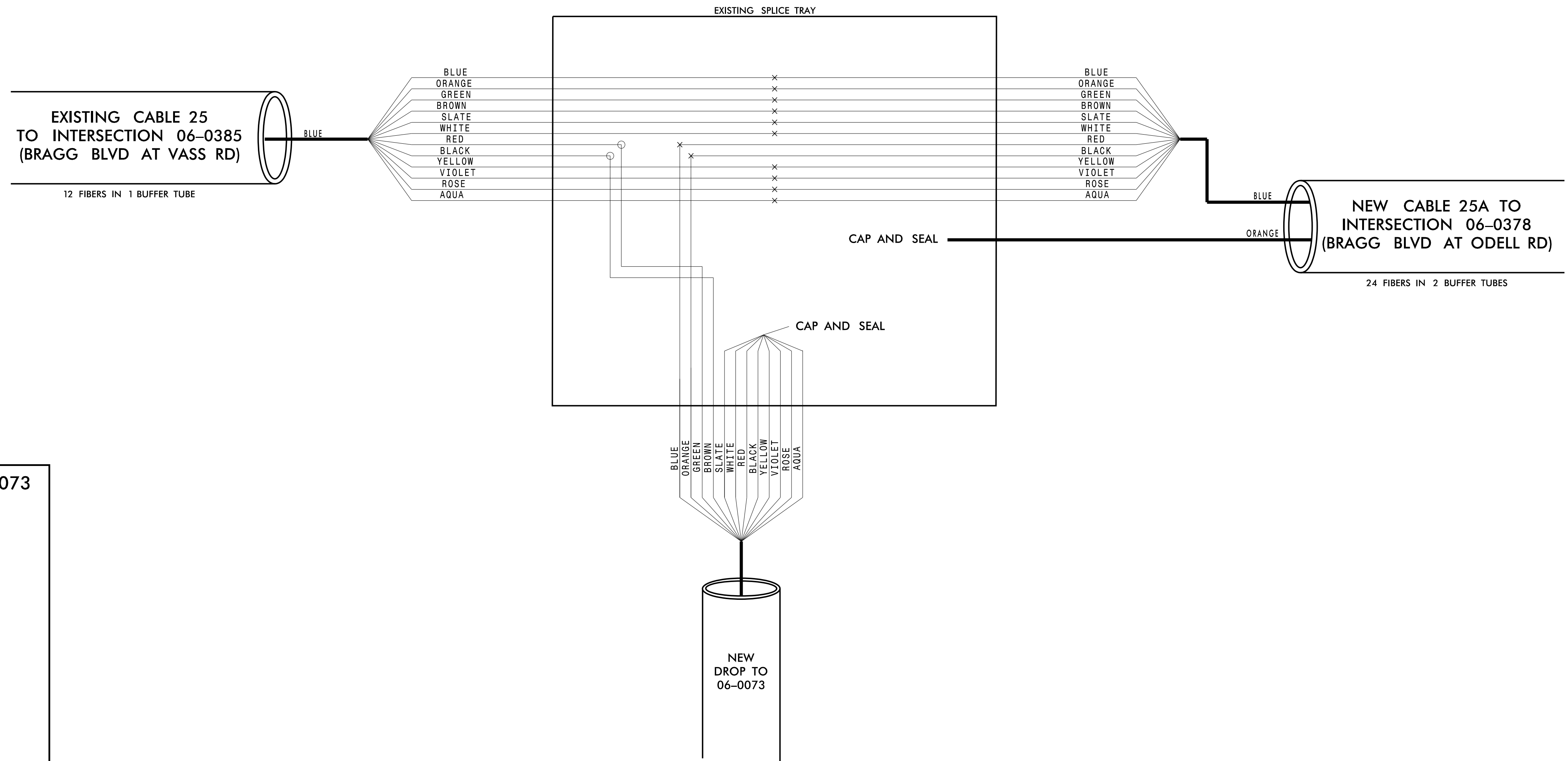

**CHANNEL 25**

**FAYETTEVILLE COMPUTERIZED SIGNAL SYSTEM**

**SPLICE DETAIL**

DIVISION 06 CUMBERLAND COUNTY

PLAN DATE: NOVEMBER 2016 REVIEWED BY: N. M. MENGELKOCH

PREPARED BY: KHA REVIEWED BY: K. W. SMITH

REVISIONS

INIT. DATE

Signature: Kevin W. Smith  
 SEAL 030472  
 DATE 11/15/2016

**Kimley»Horn**

NC License #F-0102  
 421 Fayetteville St., Suite 600  
 Raleigh, NC 27636  
 Tel: (919) 677-2000  
 Fax: (919) 677-2050

11/15/2016 K:\ARL\TPTD\ITS\01036305 - Fayetteville Sig Sys\Plans\Splicing\01036305-ITS\_psh-231-CH25-06-0073.dgn

**CHANNEL 26  
EXISTING SPLICE ENCLOSURE  
(CROSS CREEK PLAZA AT  
US 401 BYPASS)  
SIG ID 06-0705**

**COLOR CODE**  
TIA/EIA 598-C

|            |             |
|------------|-------------|
| (1) BLUE   | (7) RED     |
| (2) ORANGE | (8) BLACK   |
| (3) GREEN  | (9) YELLOW  |
| (4) BROWN  | (10) VIOLET |
| (5) SLATE  | (11) ROSE   |
| (6) WHITE  | (12) AQUA   |

**LEGEND**

X - FUSION SPLICE INDIVIDUAL FIBER  
 O - EXISTING SPLICE  
 □ - EXPRESS INDIVIDUAL FIBER

EXPRESS - EXPRESS ENTIRE BUFFER TUBE  
 SPLICE - SPLICE ENTIRE BUFFER TUBE OR MAINTAIN IF EXISTING EXPRESSED

**NOTES:**  
 1. FIBER INTERCONNECT CENTER RACKS ARE SCHEMATIC ONLY - ACTUAL EQUIPMENT FORM MAY VARY.  
 2. ETHERNET SWITCH TERMINATION CONFIGURATIONS ARE GENERIC. CONTRACTOR IS RESPONSIBLE FOR DETERMINING /ENSURING PROPER TERMINATION.  
 3. CONTRACTOR IS RESPONSIBLE FOR FIELD VERIFYING EXISTING SPLICING. THE CONTRACTOR SHALL COORDINATE WITH THE ENGINEER WHERE EXISTING SPLICING IS NOT AS EXPECTED.

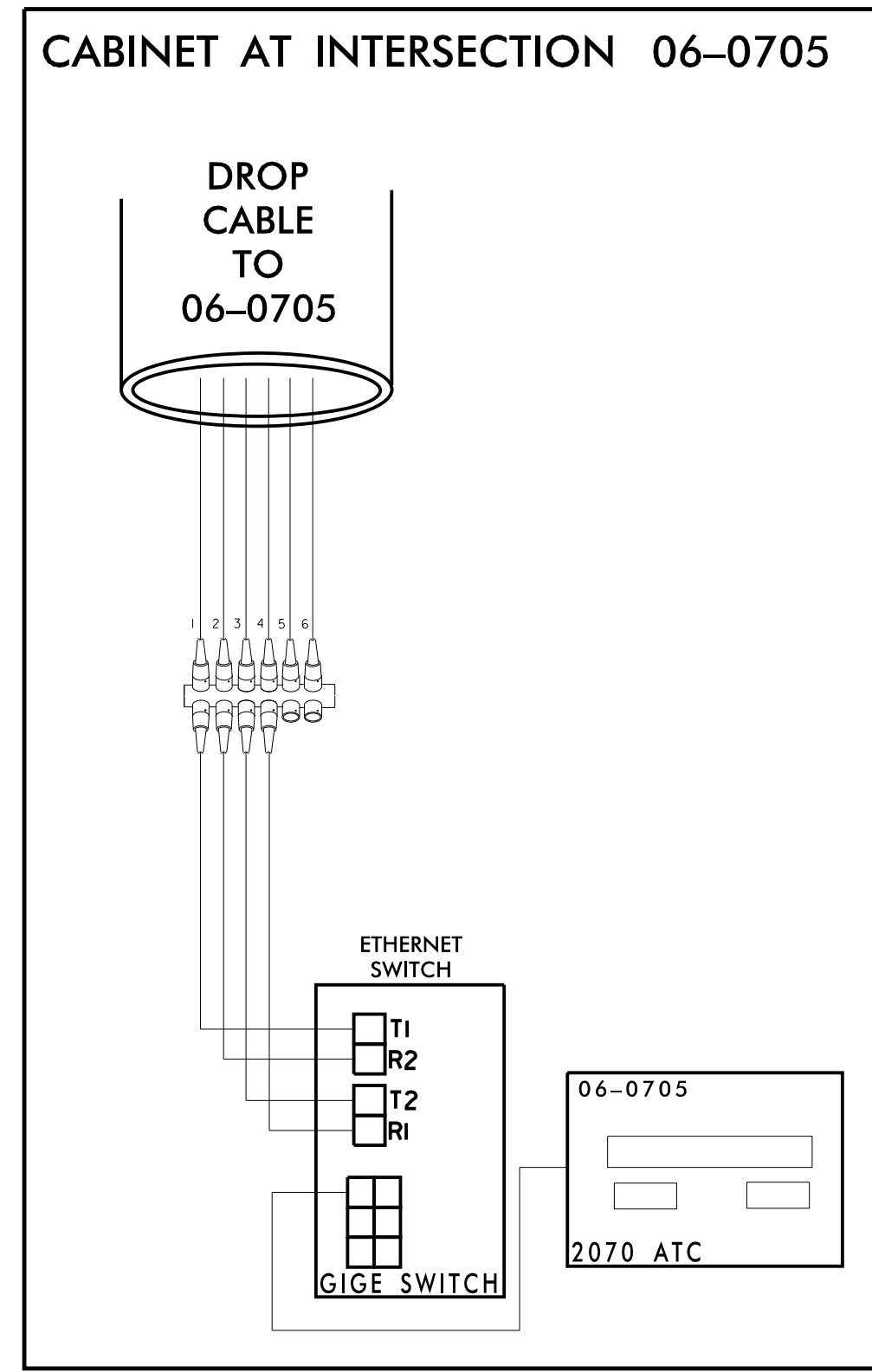
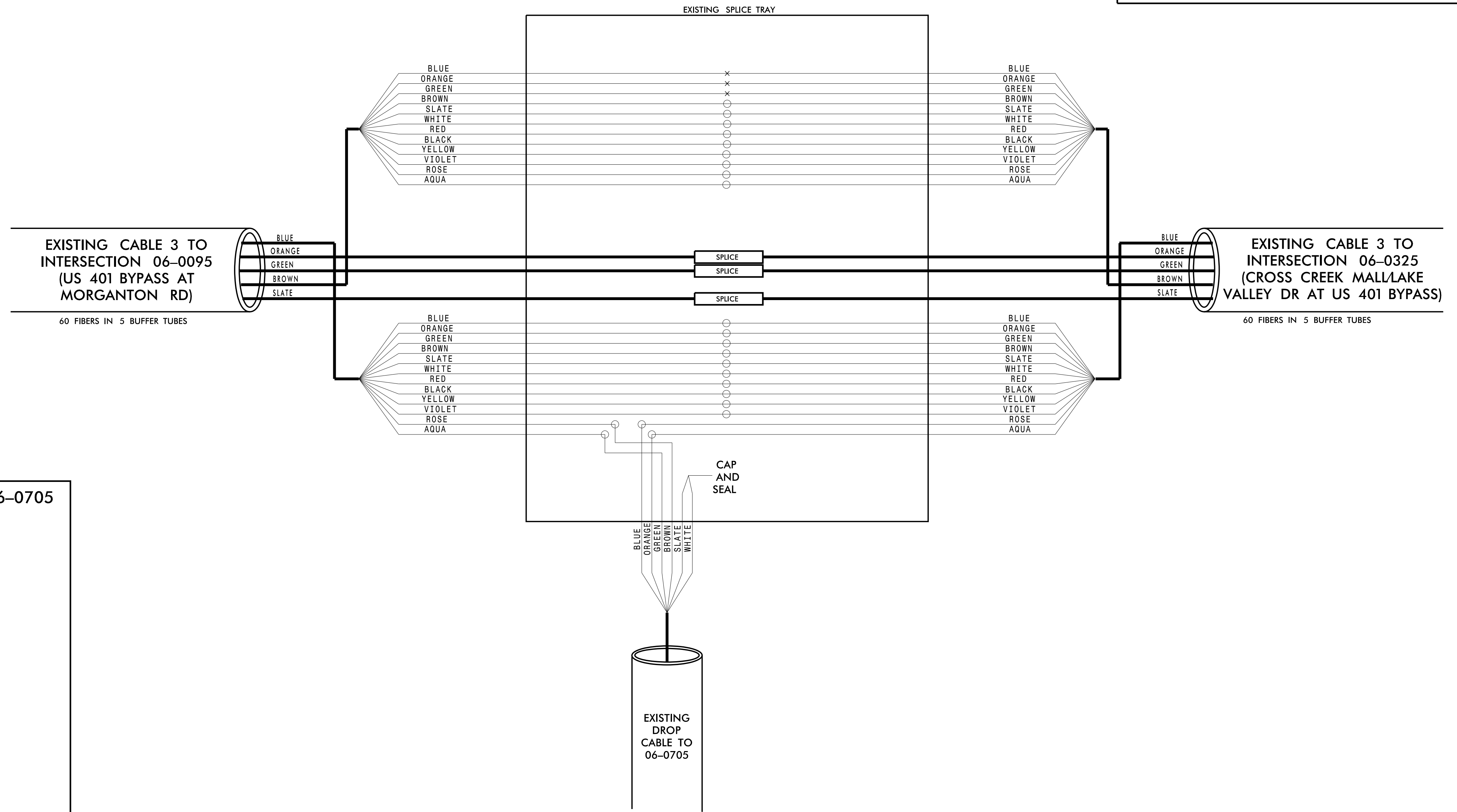

**CHANNEL 26  
FAYETTEVILLE COMPUTERIZED  
SIGNAL SYSTEM  
SPLICE DETAIL**

DIVISION 06 CUMBERLAND COUNTY

PLAN DATE: NOVEMBER 2016 REVIEWED BY: N. M. MENGELKOCH

PREPARED BY: KHA REVIEWED BY: K. W. SMITH

SCALE: 0

Kimley»Horn  
 NC License #F-0102  
 421 Fayetteville St., Suite 600  
 Raleigh, NC 27636  
 Tel: (919) 677-2000  
 Fax: (919) 677-2050

SEAL  
 NORTH CAROLINA PROFESSIONAL ENGINEER  
 SEAL 030472  
 KEVIN W. SMITH  
 11/15/2016

11/15/2016 K:\ARL\TPTD\ITS\01036305 - Fayetteville Sig Sys\Plans\Splicing\01036305-ITS\_psh-232-CH26\_06-0325.dgn

**CHANNEL 26  
EXISTING SPLICE ENCLOSURE  
(CROSS CREEK MALL/LAKE  
VALLEY DR AT US 401 BYPASS)  
SIG ID 06-0325  
CCTV 15**

**COLOR CODE**  
TIA/EIA 598-C

|            |             |
|------------|-------------|
| (1) BLUE   | (7) RED     |
| (2) ORANGE | (8) BLACK   |
| (3) GREEN  | (9) YELLOW  |
| (4) BROWN  | (10) VIOLET |
| (5) SLATE  | (11) ROSE   |
| (6) WHITE  | (12) AQUA   |

**LEGEND**

- X - FUSION SPLICE INDIVIDUAL FIBER
- O - EXISTING SPLICE
- - EXPRESS INDIVIDUAL FIBER
- EXPRESS - EXPRESS ENTIRE BUFFER TUBE
- SPLICE - SPLICE ENTIRE BUFFER TUBE OR MAINTAIN IF EXISTING EXPRESSED

**NOTES:**

- FIBER INTERCONNECT CENTER RACKS ARE SCHEMATIC ONLY - ACTUAL EQUIPMENT FORM MAY VARY.
- ETHERNET SWITCH TERMINATION CONFIGURATIONS ARE GENERIC. CONTRACTOR IS RESPONSIBLE FOR DETERMINING /ENSURING PROPER TERMINATION.
- CONTRACTOR IS RESPONSIBLE FOR FIELD VERIFYING EXISTING SPLICING. THE CONTRACTOR SHALL COORDINATE WITH THE ENGINEER WHERE EXISTING SPLICING IS NOT AS EXPECTED.

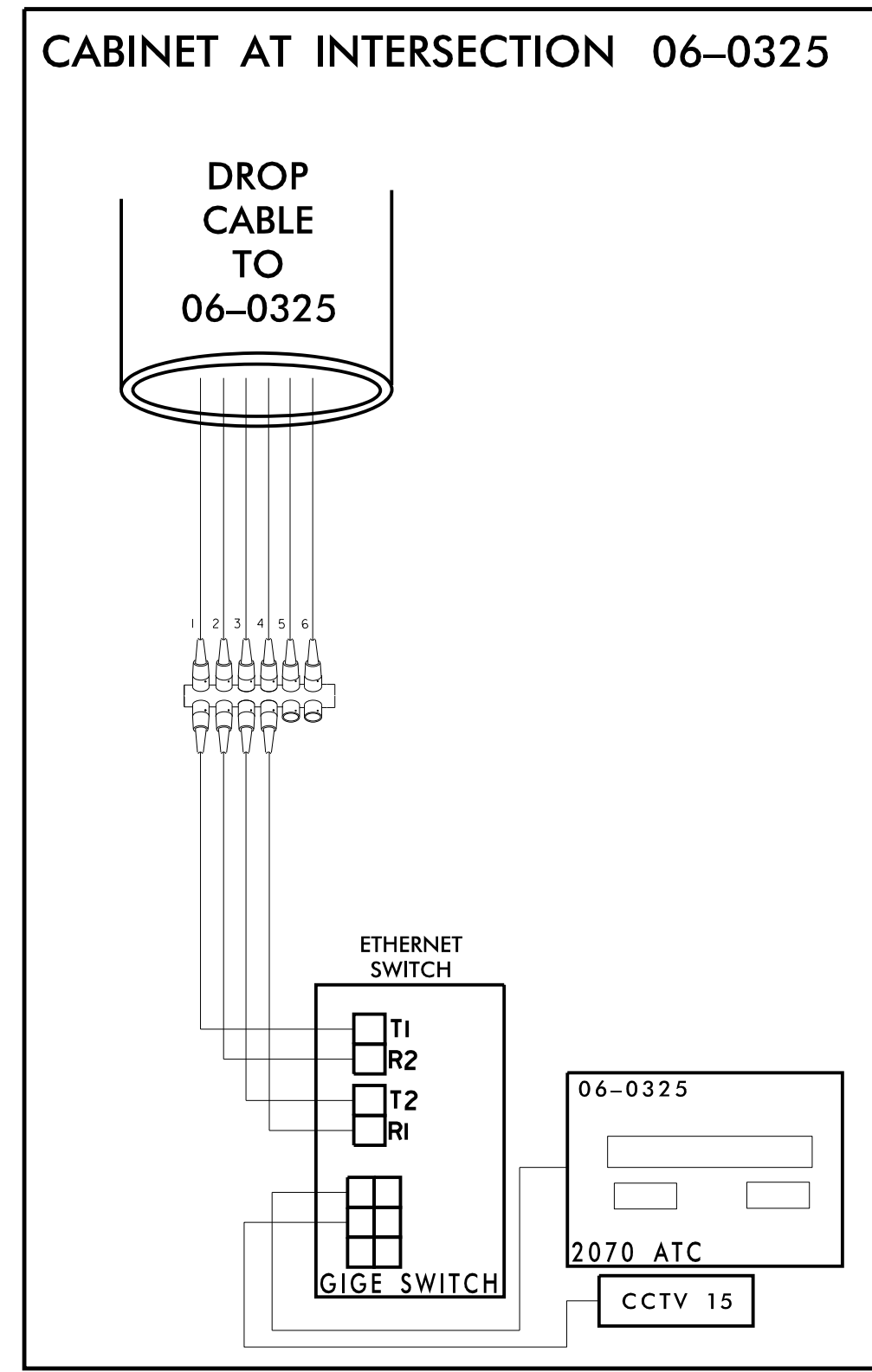
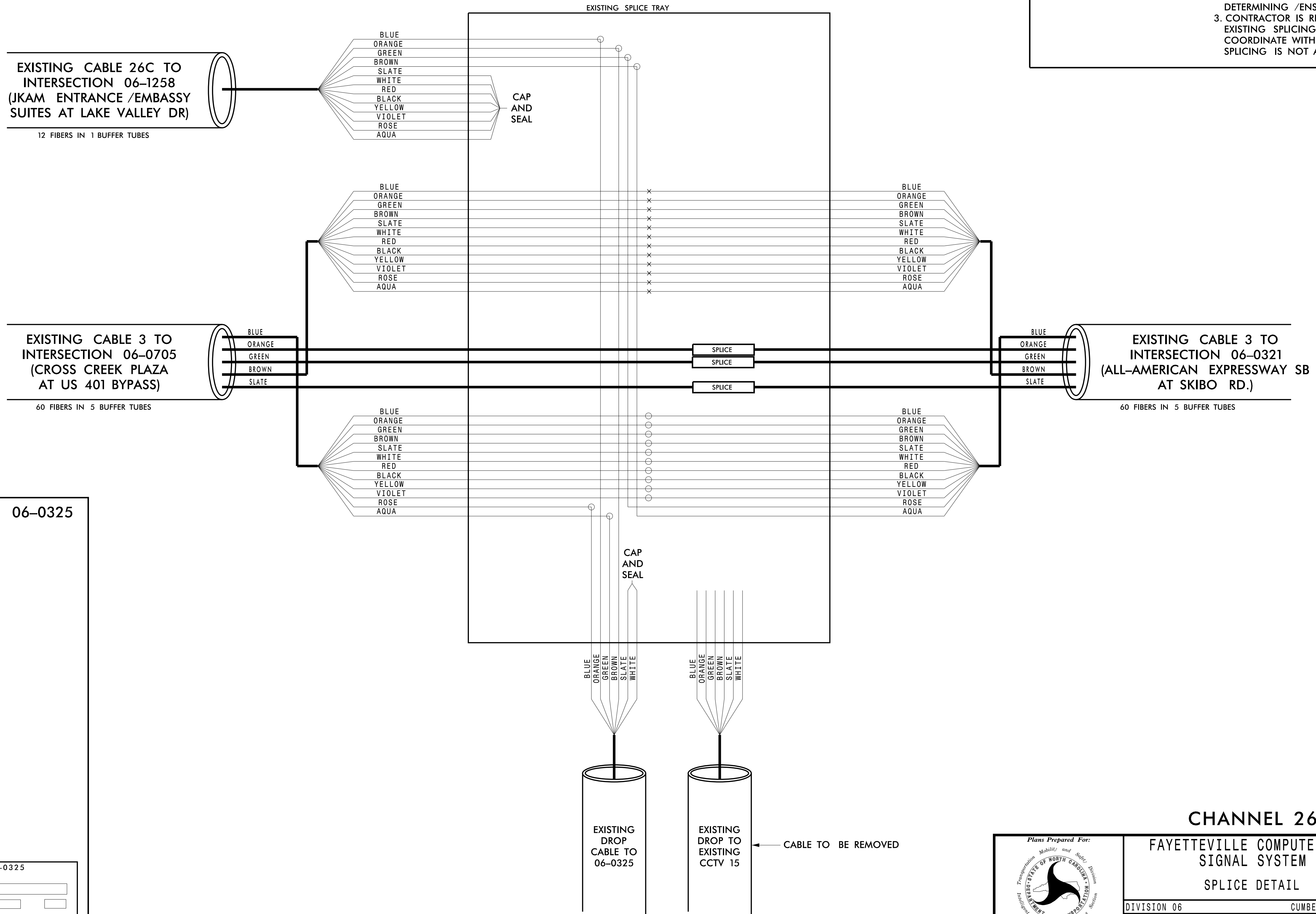

**CHANNEL 26  
FAYETTEVILLE COMPUTERIZED  
SIGNAL SYSTEM  
SPLICE DETAIL**

DIVISION 06 CUMBERLAND COUNTY

PLAN DATE: NOVEMBER 2016 REVIEWED BY: N.M. MENGELKOCH

PREPARED BY: KHA REVIEWED BY: K.W. SMITH

SCALE: 0

Kimley Horn

NC License #F-0102  
421 Fayetteville St., Suite 600  
Raleigh, NC 27636  
Tel: (919) 677-2000  
Fax: (919) 677-2050

SEAL  
NORTH CAROLINA PROFESSIONAL ENGINEER  
SEAL 030472  
KEVIN W. SMITH  
11/15/2016

11/15/2016 K:\ARL\TPTD\ITS\01036305 - Fayetteville Sig Sys\Plans\Splicing\01036305-ITS\_psh-233-CH26 CCTVB 06-0705.dgn

**CHANNEL 26  
EXISTING SPLICE ENCLOSURE  
(ALL AMERICAN EXPRESS E  
AT US 401 BYPASS)  
SIG ID 06-0321**

**COLOR CODE**  
TIA/EIA 598-C

|            |             |
|------------|-------------|
| (1) BLUE   | (7) RED     |
| (2) ORANGE | (8) BLACK   |
| (3) GREEN  | (9) YELLOW  |
| (4) BROWN  | (10) VIOLET |
| (5) SLATE  | (11) ROSE   |
| (6) WHITE  | (12) AQUA   |

**LEGEND**

X - FUSION SPLICE INDIVIDUAL FIBER  
 O - EXISTING SPLICE  
 □ - EXPRESS INDIVIDUAL FIBER

EXPRESS - EXPRESS ENTIRE BUFFER TUBE  
 SPLICE - SPLICE ENTIRE BUFFER TUBE OR MAINTAIN IF EXISTING EXPRESSED

**NOTES:**  
 1. FIBER INTERCONNECT CENTER RACKS ARE SCHEMATIC ONLY - ACTUAL EQUIPMENT FORM MAY VARY.  
 2. ETHERNET SWITCH TERMINATION CONFIGURATIONS ARE GENERIC. CONTRACTOR IS RESPONSIBLE FOR DETERMINING /ENSURING PROPER TERMINATION.  
 3. CONTRACTOR IS RESPONSIBLE FOR FIELD VERIFYING EXISTING SPLICING. THE CONTRACTOR SHALL COORDINATE WITH THE ENGINEER WHERE EXISTING SPLICING IS NOT AS EXPECTED.

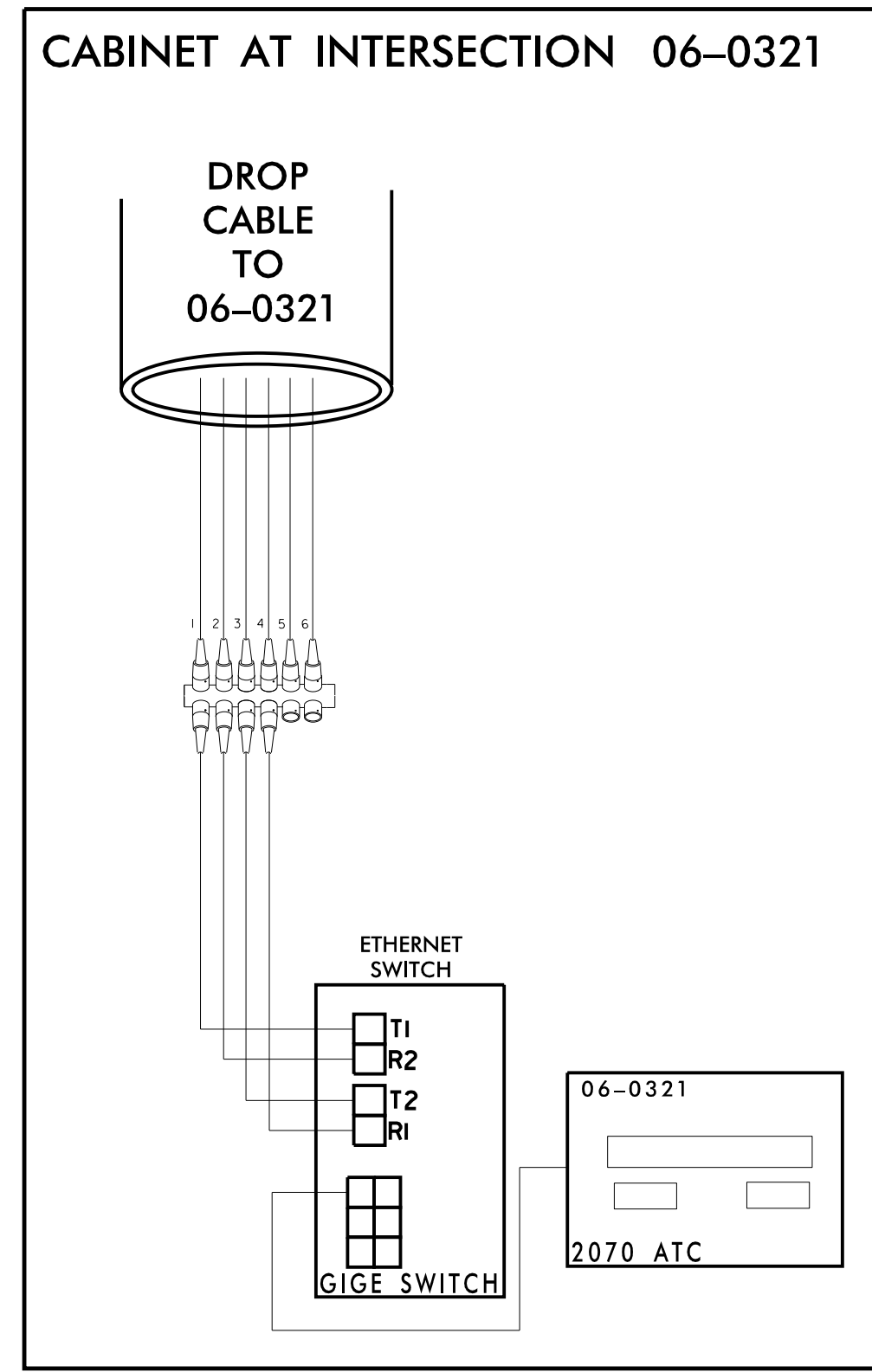
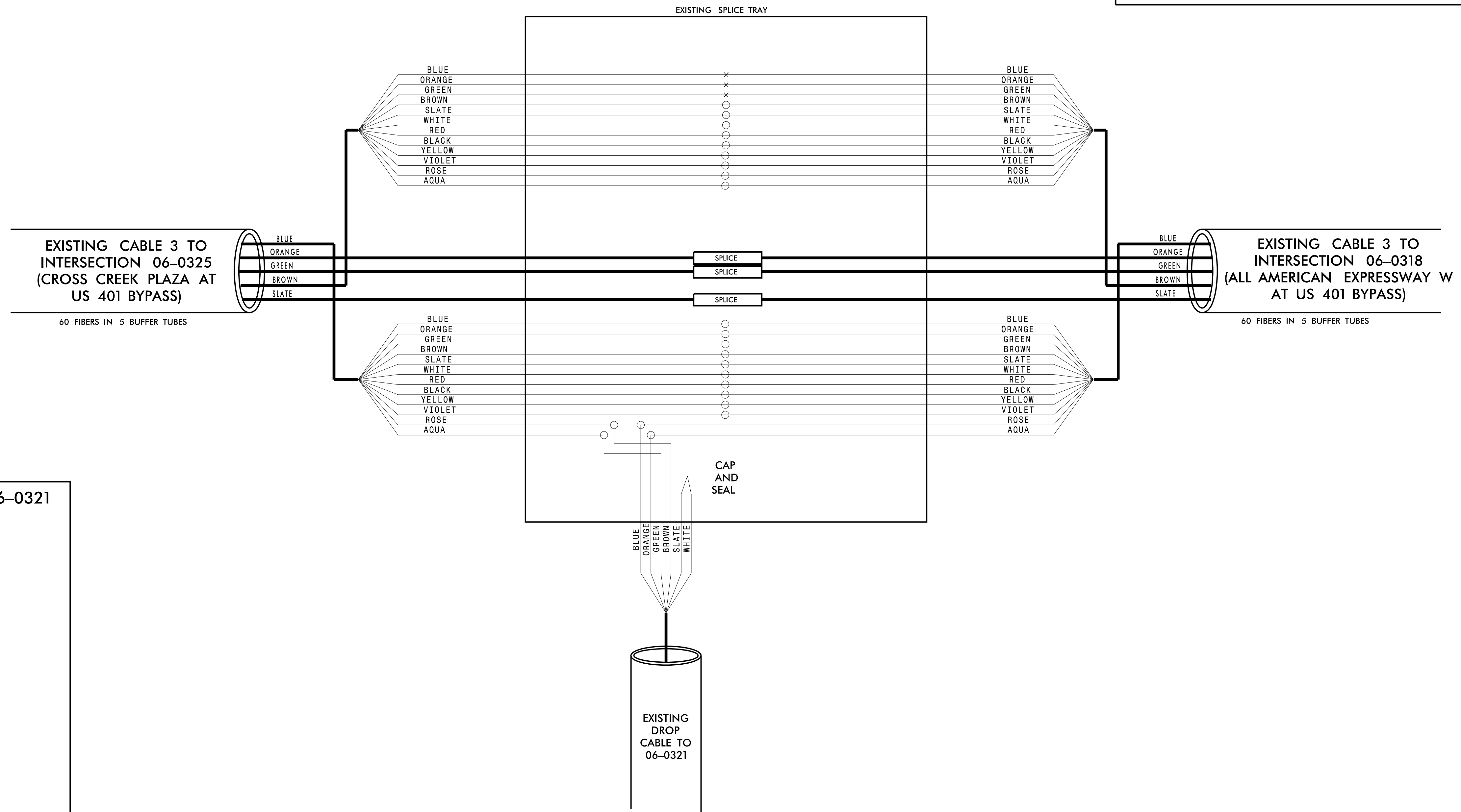

**CHANNEL 26  
FAYETTEVILLE COMPUTERIZED  
SIGNAL SYSTEM  
SPLICE DETAIL**

DIVISION 06 CUMBERLAND COUNTY

PLAN DATE: NOVEMBER 2016 REVIEWED BY: N. M. MENGELKOCH

PREPARED BY: KHA REVIEWED BY: K. W. SMITH

SCALE: 0

Kimley Horn

NC License #F-0102  
421 Fayetteville St., Suite 600  
Raleigh, NC 27636  
Tel: (919) 677-2000  
Fax: (919) 677-2050

250 N. Greenfield Place, Garner, NC 27529

SEAL  
NORTH CAROLINA PROFESSIONAL ENGINEER  
KEVIN W. SMITH  
SEAL 030472

11/15/2016

11/15/2016 K:\ARL\TPTD\ITS\01036305 - Fayetteville Sig Sys\Plans\Splicing\01036305-ITS\_psh-234-CH26\_06-0321.dgn

**CHANNEL 26**  
**EXISTING SPLICE ENCLOSURE**  
**(ALL AMERICAN EXPRESSWAY W**  
**AT US 401 BYPASS)**  
**SIG ID 06-0318**

**COLOR CODE**  
 TIA/EIA 598-C

|            |             |
|------------|-------------|
| (1) BLUE   | (7) RED     |
| (2) ORANGE | (8) BLACK   |
| (3) GREEN  | (9) YELLOW  |
| (4) BROWN  | (10) VIOLET |
| (5) SLATE  | (11) ROSE   |
| (6) WHITE  | (12) AQUA   |

**LEGEND**

X - FUSION SPLICE INDIVIDUAL FIBER  
 O - EXISTING SPLICE  
 □ - EXPRESS INDIVIDUAL FIBER

EXPRESS - EXPRESS ENTIRE BUFFER TUBE  
 SPLICE - SPLICE ENTIRE BUFFER TUBE OR MAINTAIN IF EXISTING EXPRESSED

**NOTES:**

- FIBER INTERCONNECT CENTER RACKS ARE SCHEMATIC ONLY - ACTUAL EQUIPMENT FORM MAY VARY.
- ETHERNET SWITCH TERMINATION CONFIGURATIONS ARE GENERIC. CONTRACTOR IS RESPONSIBLE FOR DETERMINING /ENSURING PROPER TERMINATION.
- CONTRACTOR IS RESPONSIBLE FOR FIELD VERIFYING EXISTING SPLICING. THE CONTRACTOR SHALL COORDINATE WITH THE ENGINEER WHERE EXISTING SPLICING IS NOT AS EXPECTED.

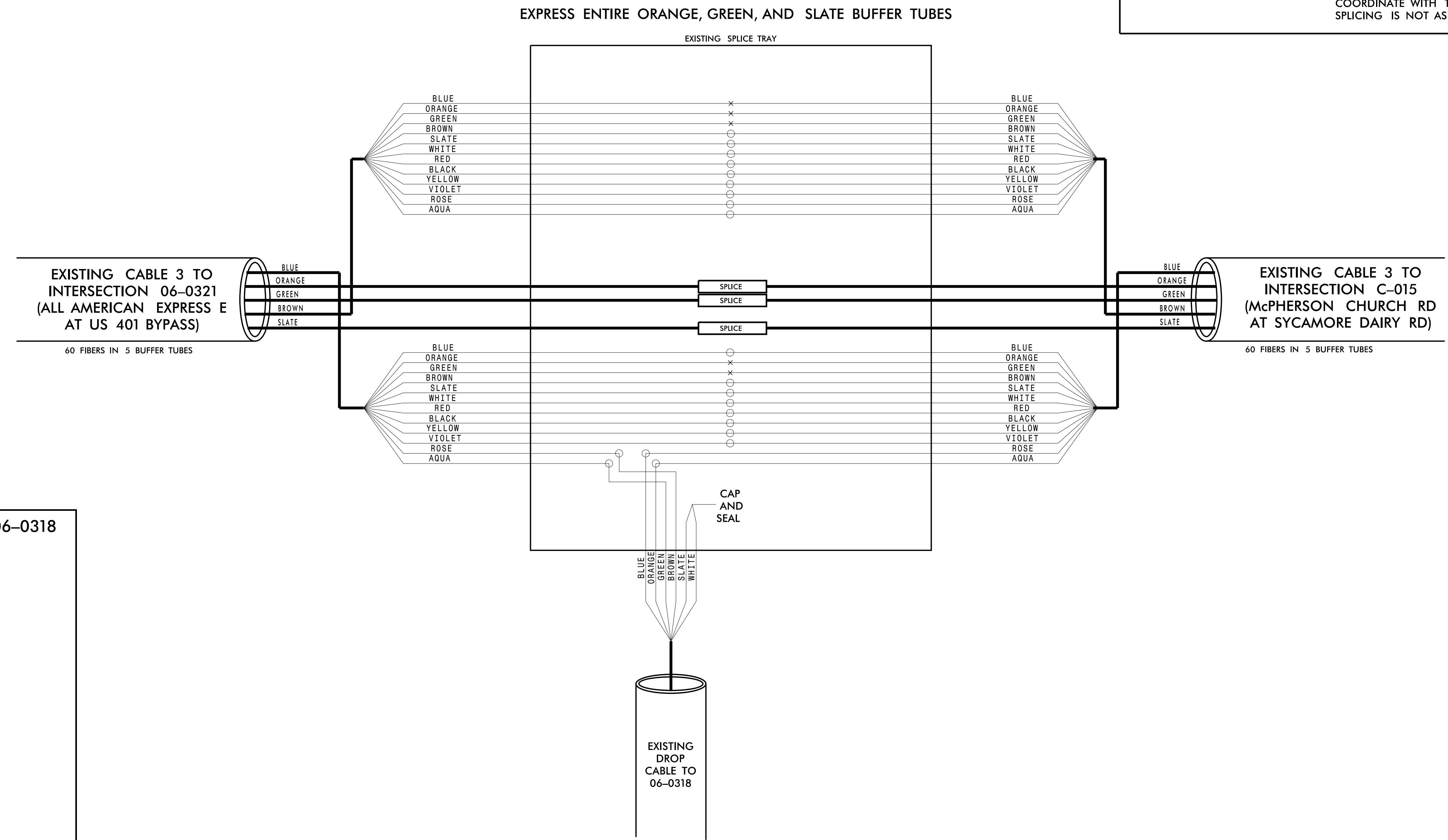

**EXISTING CABLE 3 TO INTERSECTION 06-0321**  
**(ALL AMERICAN EXPRESS E**  
**AT US 401 BYPASS)**  
 60 FIBERS IN 5 BUFFER TUBES

**EXISTING CABLE 3 TO INTERSECTION C-015**  
**(McPHERSON CHURCH RD**  
**AT SYCAMORE DAIRY RD)**  
 60 FIBERS IN 5 BUFFER TUBES

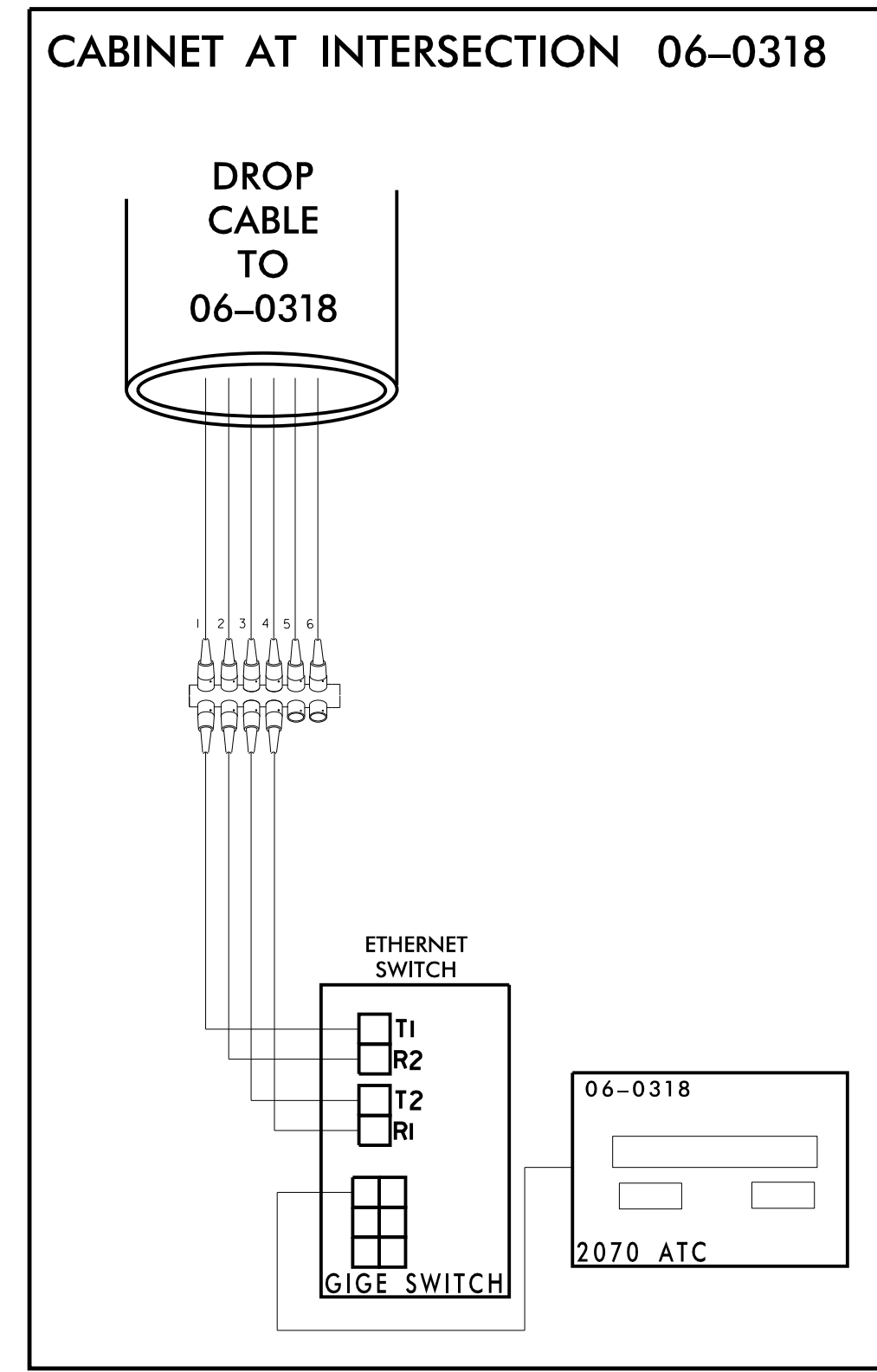

**CHANNEL 26**

**FAYETTEVILLE COMPUTERIZED SIGNAL SYSTEM**

**SPLICE DETAIL**

|                          |                               |                   |                          |
|--------------------------|-------------------------------|-------------------|--------------------------|
| DIVISION 06              |                               | CUMBERLAND COUNTY |                          |
| PLAN DATE: NOVEMBER 2016 | REVIEWED BY: N. M. MENGELKOCH | PREPARED BY: KHA  | REVIEWED BY: K. W. SMITH |
| REVISIONS                | INIT.                         | DATE              |                          |

Kevin W. Smith  
 11/15/2016  
 DATE

**Kimley»Horn**  
 NC License #F-0102  
 421 Fayetteville St., Suite 600  
 Raleigh, NC 27636  
 Tel: (919) 677-2000  
 Fax: (919) 677-2050

11/15/2016 K:\ARL\TPTD\ITS\01036305 - Fayetteville Sig Sys\Plans\Splicing\01036305-ITS-psk-235-CH26\_06-0318.dgn

**CHANNEL 26**  
**EXISTING SPLICE ENCLOSURE**  
 (McPHERSON CHURCH RD /  
 YADKIN RD AT US401 BYPASS)  
 SIG ID 06-0055  
 CCTV 4

**COLOR CODE**  
 TIA/EIA 598-C

|            |             |
|------------|-------------|
| (1) BLUE   | (7) RED     |
| (2) ORANGE | (8) BLACK   |
| (3) GREEN  | (9) YELLOW  |
| (4) BROWN  | (10) VIOLET |
| (5) SLATE  | (11) ROSE   |
| (6) WHITE  | (12) AQUA   |

**LEGEND**

X - FUSION SPLICE INDIVIDUAL FIBER  
 O - EXISTING SPLICE  
 □ - EXPRESS INDIVIDUAL FIBER

EXPRESS - EXPRESS ENTIRE BUFFER TUBE  
 SPLICE - SPLICE ENTIRE BUFFER TUBE OR MAINTAIN IF EXISTING EXPRESSED

**NOTES:**

- FIBER INTERCONNECT CENTER RACKS ARE SCHEMATIC ONLY - ACTUAL EQUIPMENT FORM MAY VARY.
- ETHERNET SWITCH TERMINATION CONFIGURATIONS ARE GENERIC. CONTRACTOR IS RESPONSIBLE FOR DETERMINING /ENSURING PROPER TERMINATION.
- CONTRACTOR IS RESPONSIBLE FOR FIELD VERIFYING EXISTING SPLICING. THE CONTRACTOR SHALL COORDINATE WITH THE ENGINEER WHERE EXISTING SPLICING IS NOT AS EXPECTED.

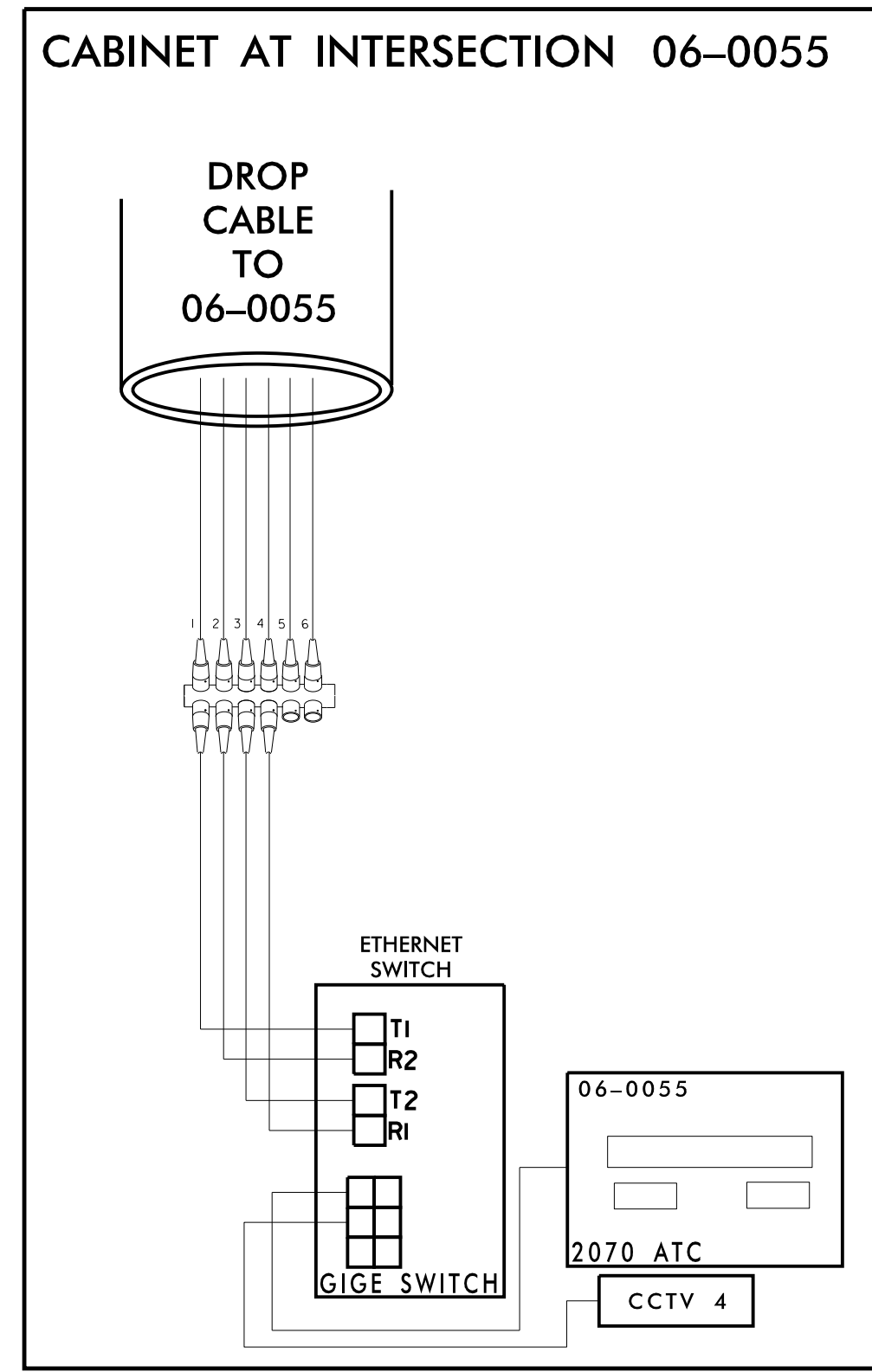
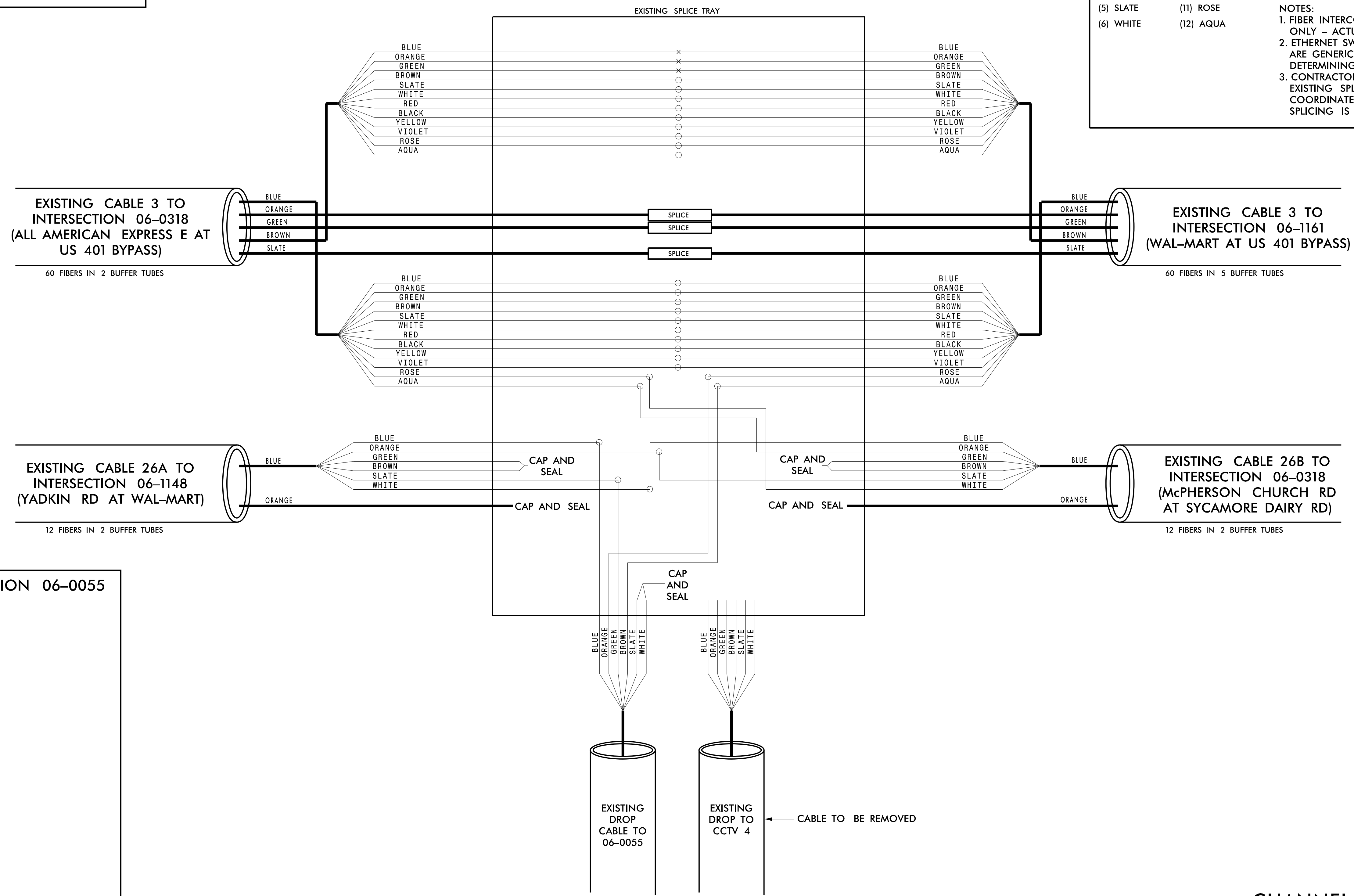

**CHANNEL 26**

**FAYETTEVILLE COMPUTERIZED SIGNAL SYSTEM**

**SPLICE DETAIL**

DIVISION 06 CUMBERLAND COUNTY

PLAN DATE: NOVEMBER 2016 REVIEWED BY: N. M. MENGELKOCH

PREPARED BY: KHA REVIEWED BY: K. W. SMITH

SCALE: 0

REVISIONS: INIT. DATE

Signature: Kevin W. Smith, 11/15/2016

Seal: NORTH CAROLINA PROFESSIONAL ENGINEER SEAL 030472

**Kimley»Horn**

NC License #F-0102  
 421 Fayetteville St., Suite 600  
 Raleigh, NC 27636  
 Tel: (919) 677-2000  
 Fax: (919) 677-2050

11/15/2016 K:\ARL\TPTD\ITS\01036305 - Fayetteville Sig Sys\Plans\Splicing\01036305-ITS-psk-236-CH26 CCTV4 Harvest at 06-0055.dgn



**CHANNEL 27 NEW  
EXISTING SIGNAL CABINET  
(BUNCE RD AT MARYKIRK DR)  
SIG ID 06-1266**

**COLOR CODE**  
TIA/EIA 598-C

|            |             |
|------------|-------------|
| (1) BLUE   | (7) RED     |
| (2) ORANGE | (8) BLACK   |
| (3) GREEN  | (9) YELLOW  |
| (4) BROWN  | (10) VIOLET |
| (5) SLATE  | (11) ROSE   |
| (6) WHITE  | (12) AQUA   |

**LEGEND**

X - FUSION SPLICE INDIVIDUAL FIBER  
 O - EXISTING SPLICE  
 □ - EXPRESS INDIVIDUAL FIBER

EXPRESS - EXPRESS ENTIRE BUFFER TUBE  
 SPLICE - SPLICE ENTIRE BUFFER TUBE OR MAINTAIN IF EXISTING EXPRESSED

**NOTES:**  
 1. FIBER INTERCONNECT CENTER RACKS ARE SCHEMATIC ONLY - ACTUAL EQUIPMENT FORM MAY VARY.  
 2. ETHERNET SWITCH TERMINATION CONFIGURATIONS ARE GENERIC. CONTRACTOR IS RESPONSIBLE FOR DETERMINING /ENSURING PROPER TERMINATION.  
 3. CONTRACTOR IS RESPONSIBLE FOR FIELD VERIFYING EXISTING SPLICING. THE CONTRACTOR SHALL COORDINATE WITH THE ENGINEER WHERE EXISTING SPLICING IS NOT AS EXPECTED.

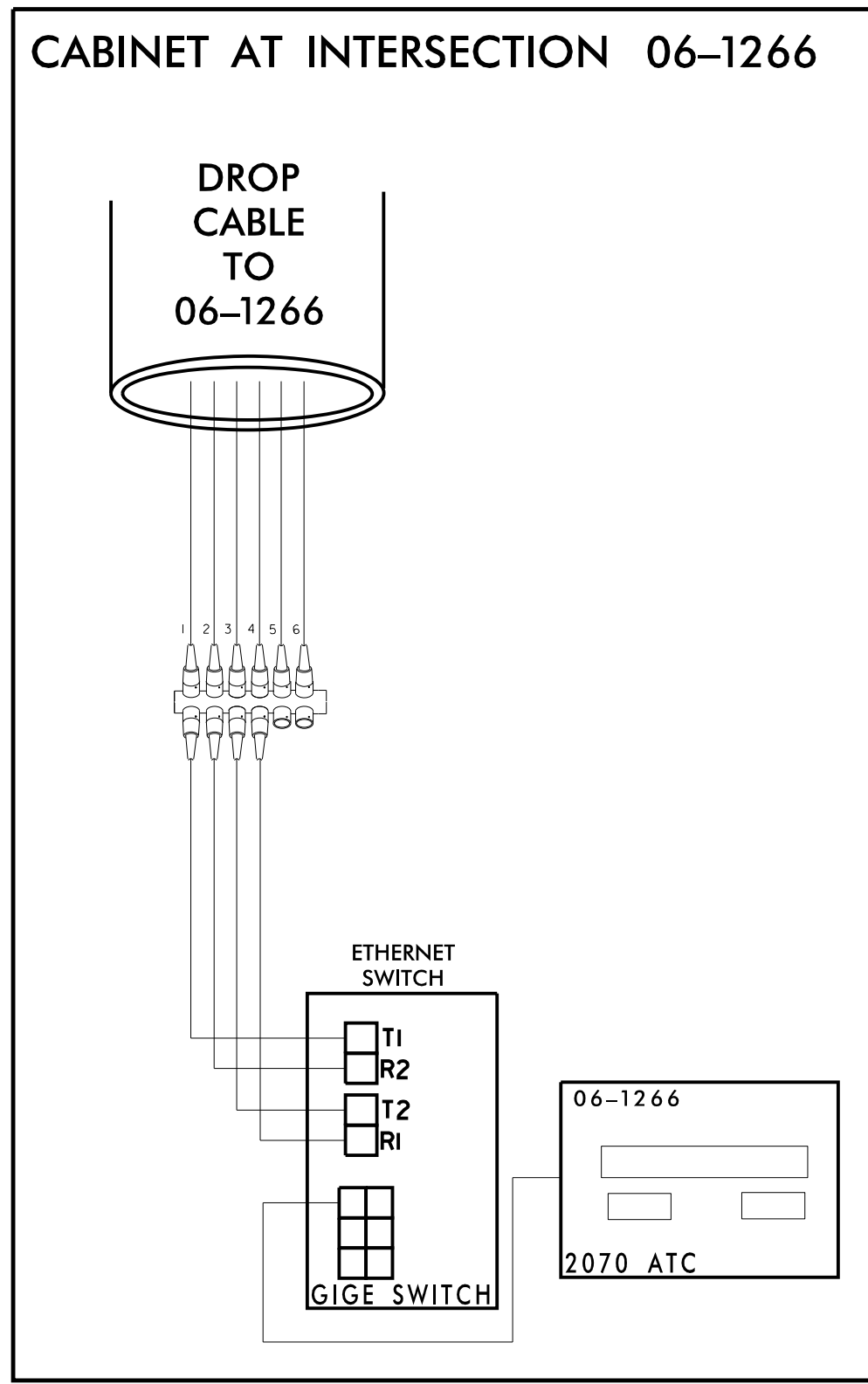
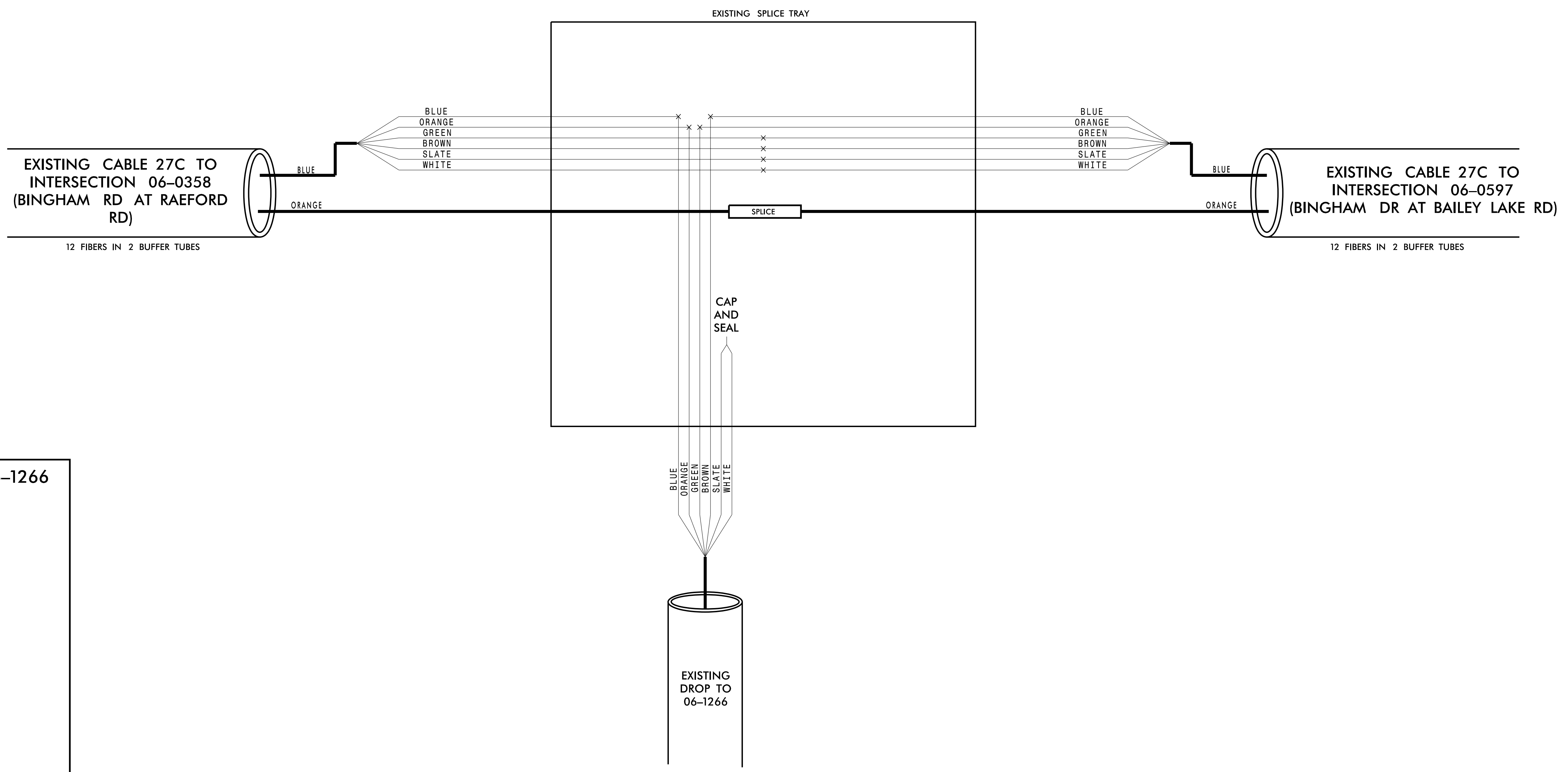

11/15/2016 K:\ARL\TPTD\_ITS\01036305 - Fayetteville Sig Sys\Plans\Splicing\01036305-ITS\_psh-237-CH27\_06-1266.dgn

**Kimley»Horn**  
 NC License #F-0102  
 421 Fayetteville St., Suite 600  
 Raleigh, NC 27636  
 Tel: (919) 677-2000  
 Fax: (919) 677-2050

**CHANNEL 27 NEW  
FAYETTEVILLE COMPUTERIZED  
SIGNAL SYSTEM  
SPLICE DETAIL**

Division 06 CUMBERLAND COUNTY

PLAN DATE: NOVEMBER 2016 REVIEWED BY: N. M. MENGELKOCH

PREPARED BY: KHA REVIEWED BY: K. W. SMITH

SCALE: 0

SEAL: NORTH CAROLINA PROFESSIONAL ENGINEER KEVIN W. SMITH SEAL 030472

SIGNATURE: Kevin W. Smith DATE: 11/15/2016

**CHANNEL 27 NEW**  
**EXISTING SPLICE ENCLOSURE IN**  
**CABINET**  
**(FISHER RD AT GEORGE OWEN DR)**  
**SIG ID 06-0575**  
**CCTV 35**

**COLOR CODE**  
 TIA/EIA 598-C

|            |             |
|------------|-------------|
| (1) BLUE   | (7) RED     |
| (2) ORANGE | (8) BLACK   |
| (3) GREEN  | (9) YELLOW  |
| (4) BROWN  | (10) VIOLET |
| (5) SLATE  | (11) ROSE   |
| (6) WHITE  | (12) AQUA   |

**LEGEND**

X - FUSION SPLICE INDIVIDUAL FIBER  
 O - EXISTING SPLICE  
 □ - EXPRESS INDIVIDUAL FIBER

EXPRESS - EXPRESS ENTIRE BUFFER TUBE  
 SPLICE - SPLICE ENTIRE BUFFER TUBE OR MAINTAIN IF EXISTING EXPRESSED

**NOTES:**

- FIBER INTERCONNECT CENTER RACKS ARE SCHEMATIC ONLY - ACTUAL EQUIPMENT FORM MAY VARY.
- ETHERNET SWITCH TERMINATION CONFIGURATIONS ARE GENERIC. CONTRACTOR IS RESPONSIBLE FOR DETERMINING /ENSURING PROPER TERMINATION.
- CONTRACTOR IS RESPONSIBLE FOR FIELD VERIFYING EXISTING SPLICING. THE CONTRACTOR SHALL COORDINATE WITH THE ENGINEER WHERE EXISTING SPLICING IS NOT AS EXPECTED.

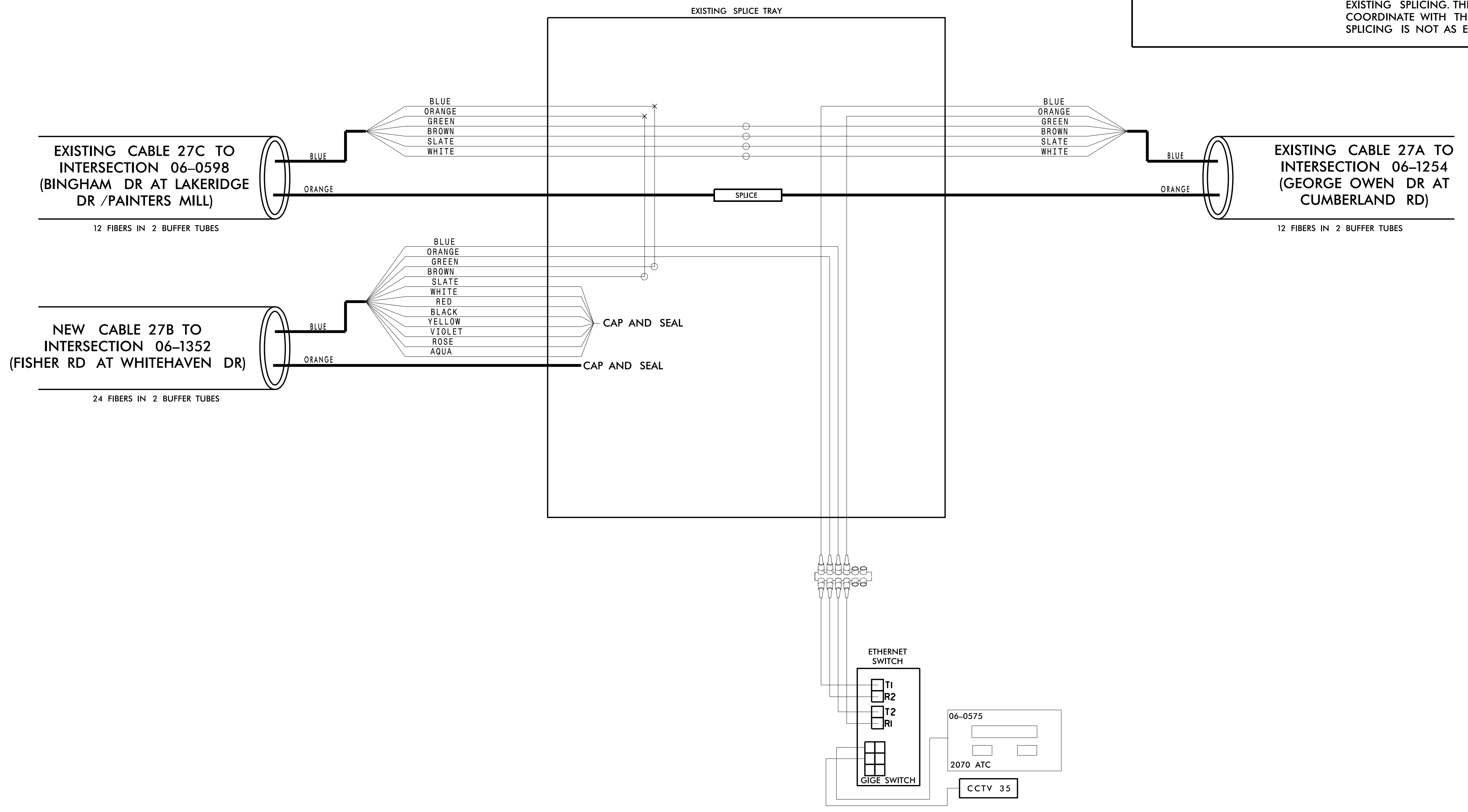

11/15/2016 K:\ARL\TPTD\ITS\01036305 - Fayetteville Sig Sys\Plans\Splicing\01036305-ITS-psk-238-CH27\_06-0575 CCTV\_35.dgn

**Kimley»Horn**  
 NC License #F-0102  
 421 Fayetteville St., Suite 600  
 Raleigh, NC 27636  
 Tel: (919) 677-2000  
 Fax: (919) 677-2050

**CHANNEL 27 NEW**

**FAYETTEVILLE COMPUTERIZED SIGNAL SYSTEM**

**SPLICE DETAIL**

|                          |                               |                   |                          |
|--------------------------|-------------------------------|-------------------|--------------------------|
| DIVISION 06              |                               | CUMBERLAND COUNTY |                          |
| PLAN DATE: NOVEMBER 2016 | REVIEWED BY: N. M. MENGELKOCH | PREPARED BY: KHA  | REVIEWED BY: K. W. SMITH |
| REVISIONS                | INIT.                         | DATE              |                          |

SEAL  
 NORTH CAROLINA PROFESSIONAL ENGINEER  
 KEVIN W. SMITH  
 SEAL 030472  
 11/15/2016  
 SIGNATURE DATE  
 CADD Filename:

**CHANNEL 27 NEW  
NEW SPLICE ENCLOSURE  
(FISHER RD AT McKINNON  
FARM RD)  
SIG ID 06-1352**

**COLOR CODE**  
TIA/EIA 598-C

|            |             |
|------------|-------------|
| (1) BLUE   | (7) RED     |
| (2) ORANGE | (8) BLACK   |
| (3) GREEN  | (9) YELLOW  |
| (4) BROWN  | (10) VIOLET |
| (5) SLATE  | (11) ROSE   |
| (6) WHITE  | (12) AQUA   |

**LEGEND**

- X - FUSION SPLICE INDIVIDUAL FIBER
- O - EXISTING SPLICE
- - EXPRESS INDIVIDUAL FIBER

EXPRESS: EXPRESS ENTIRE BUFFER TUBE  
SPLICE: SPLICE ENTIRE BUFFER TUBE OR MAINTAIN IF EXISTING EXPRESSED

**NOTES:**

- FIBER INTERCONNECT CENTER RACKS ARE SCHEMATIC ONLY - ACTUAL EQUIPMENT FORM MAY VARY.
- ETHERNET SWITCH TERMINATION CONFIGURATIONS ARE GENERIC. CONTRACTOR IS RESPONSIBLE FOR DETERMINING /ENSURING PROPER TERMINATION.
- CONTRACTOR IS RESPONSIBLE FOR FIELD VERIFYING EXISTING SPLICING. THE CONTRACTOR SHALL COORDINATE WITH THE ENGINEER WHERE EXISTING SPLICING IS NOT AS EXPECTED.

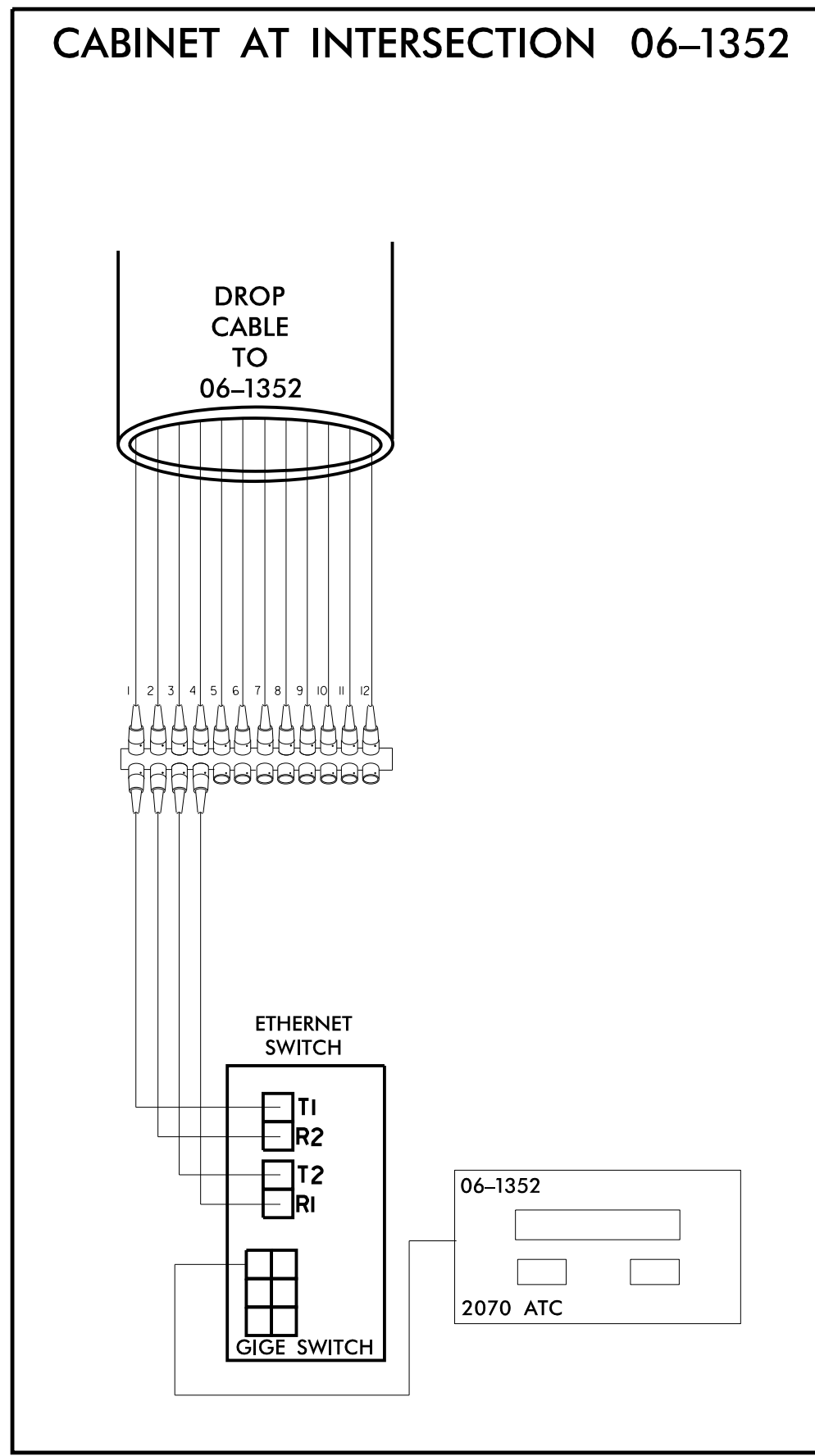
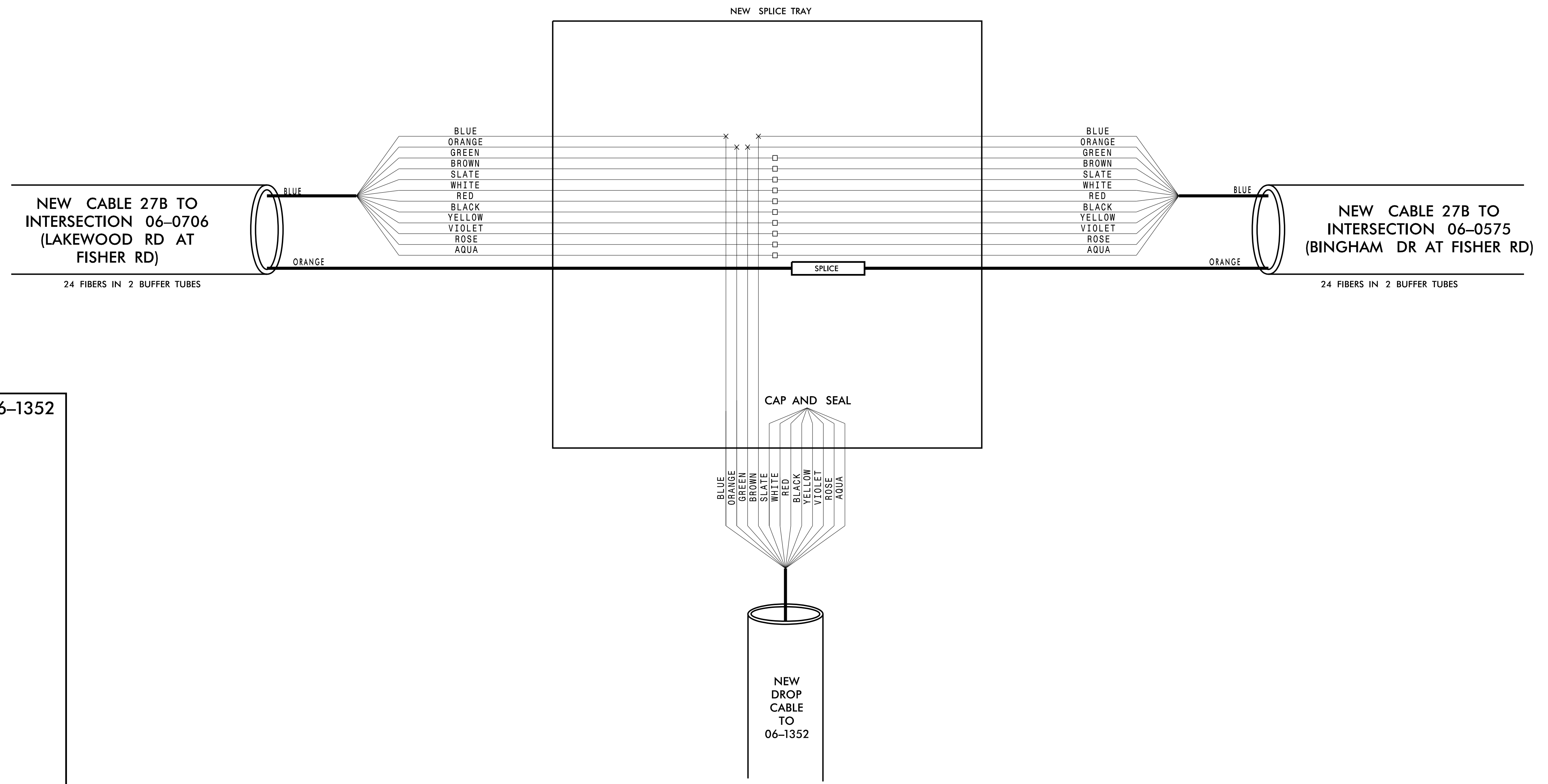

**CHANNEL 27 NEW**

**FAYETTEVILLE COMPUTERIZED SIGNAL SYSTEM**

**SPLICE DETAIL**

DIVISION 06 CUMBERLAND COUNTY

PLAN DATE: NOVEMBER 2016 REVIEWED BY: N. M. MENGELKOCH

PREPARED BY: KHA REVIEWED BY: K. W. SMITH

Scale: 0

Kimley»Horn  
NC License #F-0102  
421 Fayetteville St., Suite 600  
Raleigh, NC 27636  
Tel: (919) 677-2000  
Fax: (919) 677-2050

Professional Engineer Seal: KEVIN W. SMITH, 030472, 11/15/2016

11/15/2016 KARAL\_TPTD\_ITS\_01036305 - Fayetteville Sig Sys\Plans\Splicing\01036305\_ITS\_psh-239-CH27\_06-1352.dgn

**CHANNEL 27 NEW  
NEW SPLICE ENCLOSURE  
(LAKEWOOD DR AT FISHER RD)  
SIG ID 06-0706**

**COLOR CODE**  
TIA/EIA 598-C

|            |             |
|------------|-------------|
| (1) BLUE   | (7) RED     |
| (2) ORANGE | (8) BLACK   |
| (3) GREEN  | (9) YELLOW  |
| (4) BROWN  | (10) VIOLET |
| (5) SLATE  | (11) ROSE   |
| (6) WHITE  | (12) AQUA   |

**LEGEND**

X - FUSION SPLICE INDIVIDUAL FIBER  
 O - EXISTING SPLICE  
 □ - EXPRESS INDIVIDUAL FIBER

EXPRESS - EXPRESS ENTIRE BUFFER TUBE  
 SPLICE - SPLICE ENTIRE BUFFER TUBE OR MAINTAIN IF EXISTING EXPRESSED

**NOTES:**

- FIBER INTERCONNECT CENTER RACKS ARE SCHEMATIC ONLY - ACTUAL EQUIPMENT FORM MAY VARY.
- ETHERNET SWITCH TERMINATION CONFIGURATIONS ARE GENERIC. CONTRACTOR IS RESPONSIBLE FOR DETERMINING /ENSURING PROPER TERMINATION.
- CONTRACTOR IS RESPONSIBLE FOR FIELD VERIFYING EXISTING SPLICING. THE CONTRACTOR SHALL COORDINATE WITH THE ENGINEER WHERE EXISTING SPLICING IS NOT AS EXPECTED.

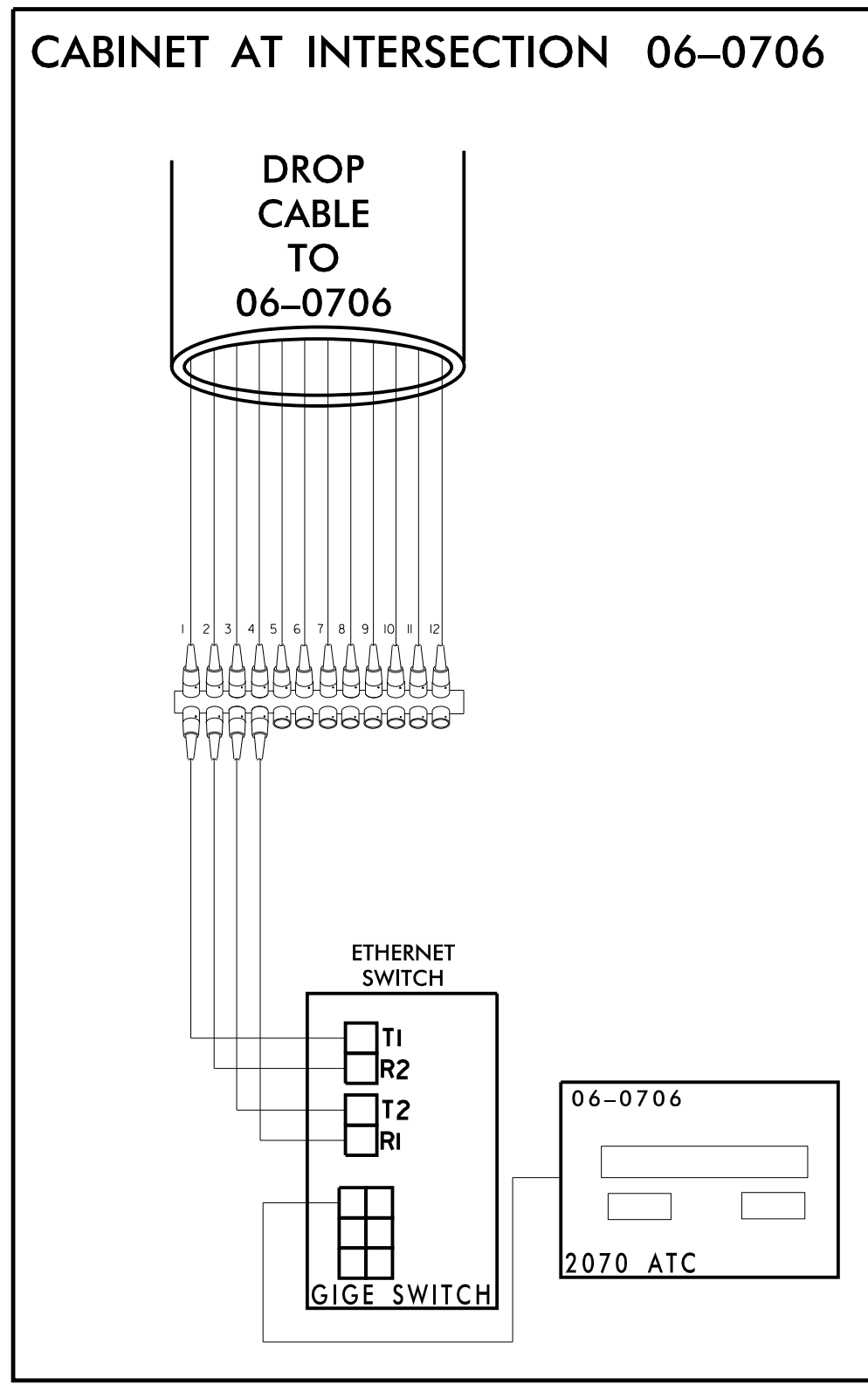
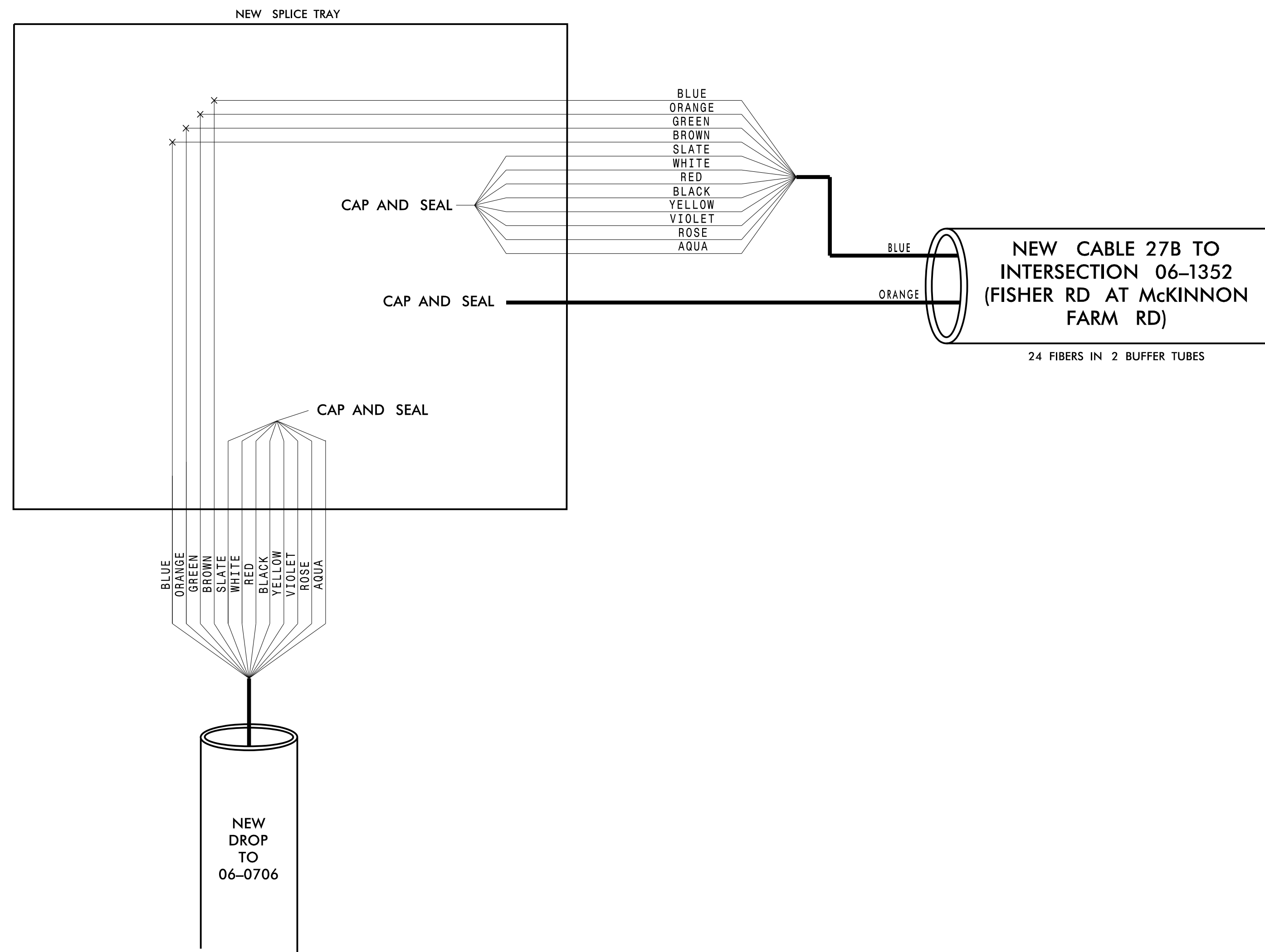

**CHANNEL 27 NEW**

**FAYETTEVILLE COMPUTERIZED SIGNAL SYSTEM**

**SPLICE DETAIL**

DIVISION 06 CUMBERLAND COUNTY

PLAN DATE: NOVEMBER 2016 REVIEWED BY: N. W. MENGELKOCH

PREPARED BY: KHA REVIEWED BY: K. W. SMITH

| REVISIONS | INIT. | DATE |
|-----------|-------|------|
|           |       |      |
|           |       |      |

SCALE: 0

**Kimley»Horn**  
 NC License #F-0102  
 421 Fayetteville St., Suite 600  
 Raleigh, NC 27636  
 Tel: (919) 677-2000  
 Fax: (919) 677-2050

**SEAL**  
 NORTH CAROLINA PROFESSIONAL ENGINEER  
 SEAL 030472  
 KEVIN W. SMITH  
 11/15/2016

11/15/2016 K:\ARL\TPTD\ITS\01036305 - Fayetteville Sig Sys\Plans\Splicing\01036305-ITS\_psh-240-CH27\_06-0706.dgn

**CHANNEL 27 NEW**  
**EXISTING SPLICE ENCLOSURE**  
**IN CABINET**  
**(ELK RD /NC 162 AT LEGION RD)**  
**SIG ID 06-0455**  
**CCTV 38**

**COLOR CODE**  
 TIA/EIA 598-C

|            |             |
|------------|-------------|
| (1) BLUE   | (7) RED     |
| (2) ORANGE | (8) BLACK   |
| (3) GREEN  | (9) YELLOW  |
| (4) BROWN  | (10) VIOLET |
| (5) SLATE  | (11) ROSE   |
| (6) WHITE  | (12) AQUA   |

**LEGEND**

- X - FUSION SPLICE INDIVIDUAL FIBER
- - EXISTING SPLICE
- - EXPRESS INDIVIDUAL FIBER

EXPRESS: EXPRESS ENTIRE BUFFER TUBE  
 SPLICE: SPLICE ENTIRE BUFFER TUBE OR MAINTAIN IF EXISTING EXPRESSED

**NOTES:**

- FIBER INTERCONNECT CENTER RACKS ARE SCHEMATIC ONLY - ACTUAL EQUIPMENT FORM MAY VARY.
- ETHERNET SWITCH TERMINATION CONFIGURATIONS ARE GENERIC. CONTRACTOR IS RESPONSIBLE FOR DETERMINING /ENSURING PROPER TERMINATION.
- CONTRACTOR IS RESPONSIBLE FOR FIELD VERIFYING EXISTING SPLICING. THE CONTRACTOR SHALL COORDINATE WITH THE ENGINEER WHERE EXISTING SPLICING IS NOT AS EXPECTED.

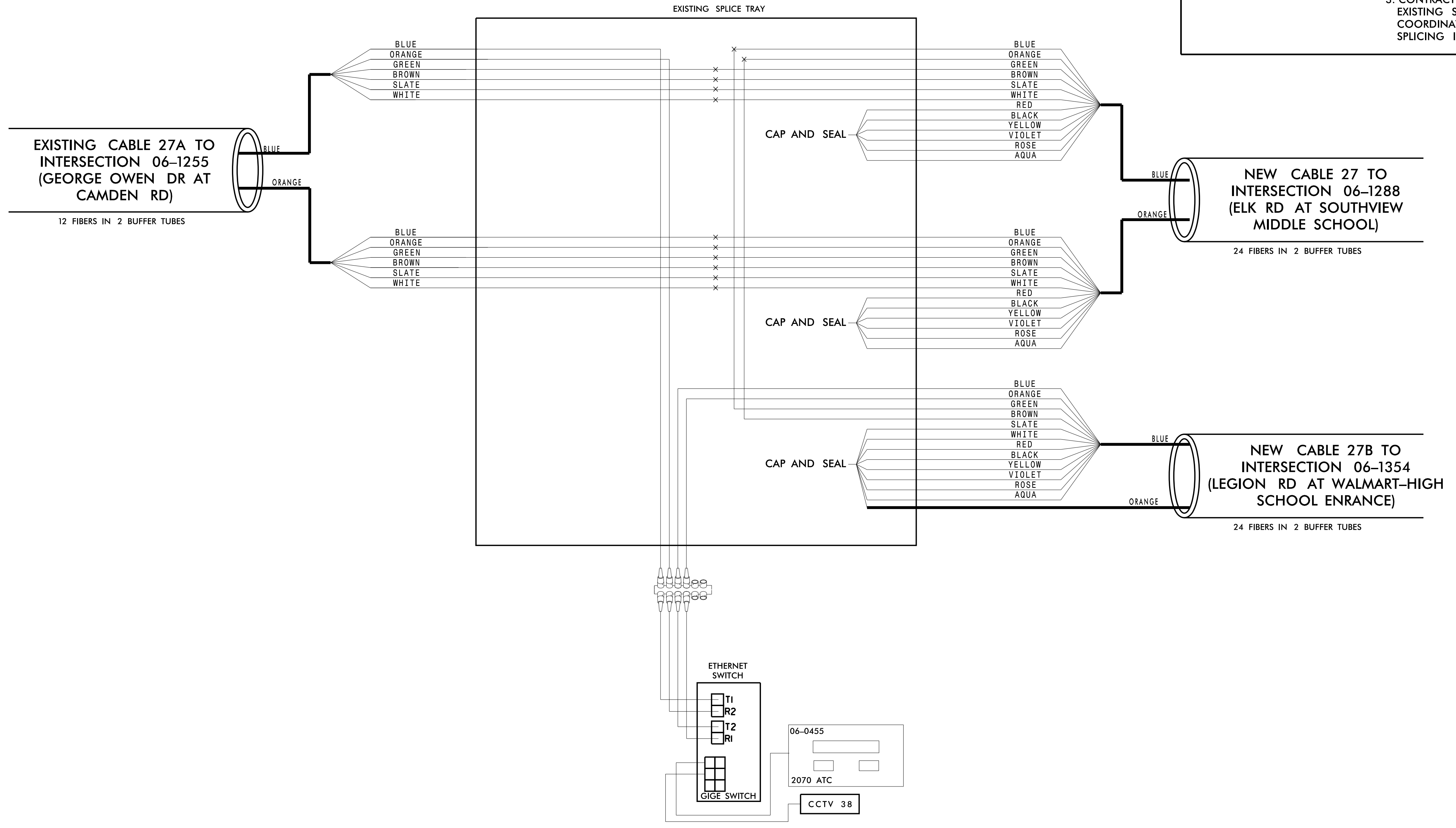

11/15/2016 K:\ARL\TPTD\ITS\01036305 - Fayetteville Sig Sys\Plans\Splicing\01036305-ITS\_psh-241-CH27\_06-0455 CCTV38.dgn

**Kimley»Horn**  
 NC License #F-0102  
 421 Fayetteville St., Suite 600  
 Raleigh, NC 27636  
 Tel: (919) 677-2000  
 Fax: (919) 677-2050

**CHANNEL 27 NEW**

**FAYETTEVILLE COMPUTERIZED SIGNAL SYSTEM**

**SPLICE DETAIL**

|                          |                               |                   |                          |
|--------------------------|-------------------------------|-------------------|--------------------------|
| DIVISION 06              |                               | CUMBERLAND COUNTY |                          |
| PLAN DATE: NOVEMBER 2016 | REVIEWED BY: N. M. MENGELKOCH | PREPARED BY: KHA  | REVIEWED BY: K. W. SMITH |
| REVISIONS                | INIT.                         | DATE              |                          |

SCALE: 0

SEAL: NORTH CAROLINA PROFESSIONAL ENGINEER KEVIN W. SMITH SEAL 030472

Signature: Kevin W. Smith  
 Date: 11/15/2016  
 CADD Filename:

**CHANNEL 27**  
**NEW SPLICE ENCLOSURE**  
**(LEGION RD AT WALMART –**  
**HIGH SCHOOL ENTRANCE)**  
**SIG ID 06-1354**

**COLOR CODE**  
 TIA/EIA 598-C

|            |             |
|------------|-------------|
| (1) BLUE   | (7) RED     |
| (2) ORANGE | (8) BLACK   |
| (3) GREEN  | (9) YELLOW  |
| (4) BROWN  | (10) VIOLET |
| (5) SLATE  | (11) ROSE   |
| (6) WHITE  | (12) AQUA   |

**LEGEND**

X – FUSION SPLICE INDIVIDUAL FIBER  
 O – EXISTING SPLICE  
 □ – EXPRESS INDIVIDUAL FIBER

EXPRESS – EXPRESS ENTIRE BUFFER TUBE  
 SPLICE – SPLICE ENTIRE BUFFER TUBE OR MAINTAIN IF EXISTING EXPRESSED

**NOTES:**

- FIBER INTERCONNECT CENTER RACKS ARE SCHEMATIC ONLY – ACTUAL EQUIPMENT FORM MAY VARY.
- ETHERNET SWITCH TERMINATION CONFIGURATIONS ARE GENERIC. CONTRACTOR IS RESPONSIBLE FOR DETERMINING /ENSURING PROPER TERMINATION.
- CONTRACTOR IS RESPONSIBLE FOR FIELD VERIFYING EXISTING SPLICING. THE CONTRACTOR SHALL COORDINATE WITH THE ENGINEER WHERE EXISTING SPLICING IS NOT AS EXPECTED.

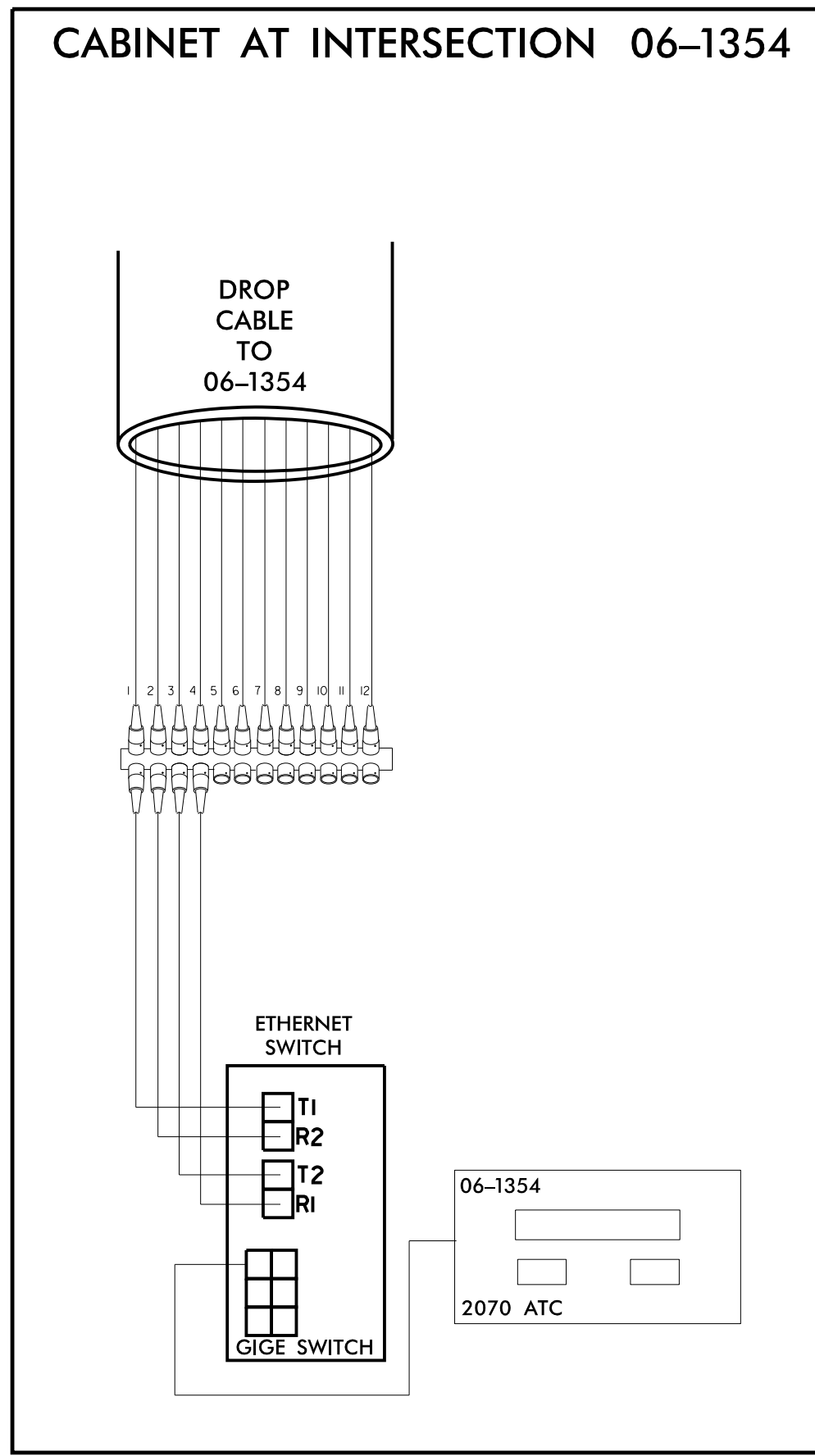
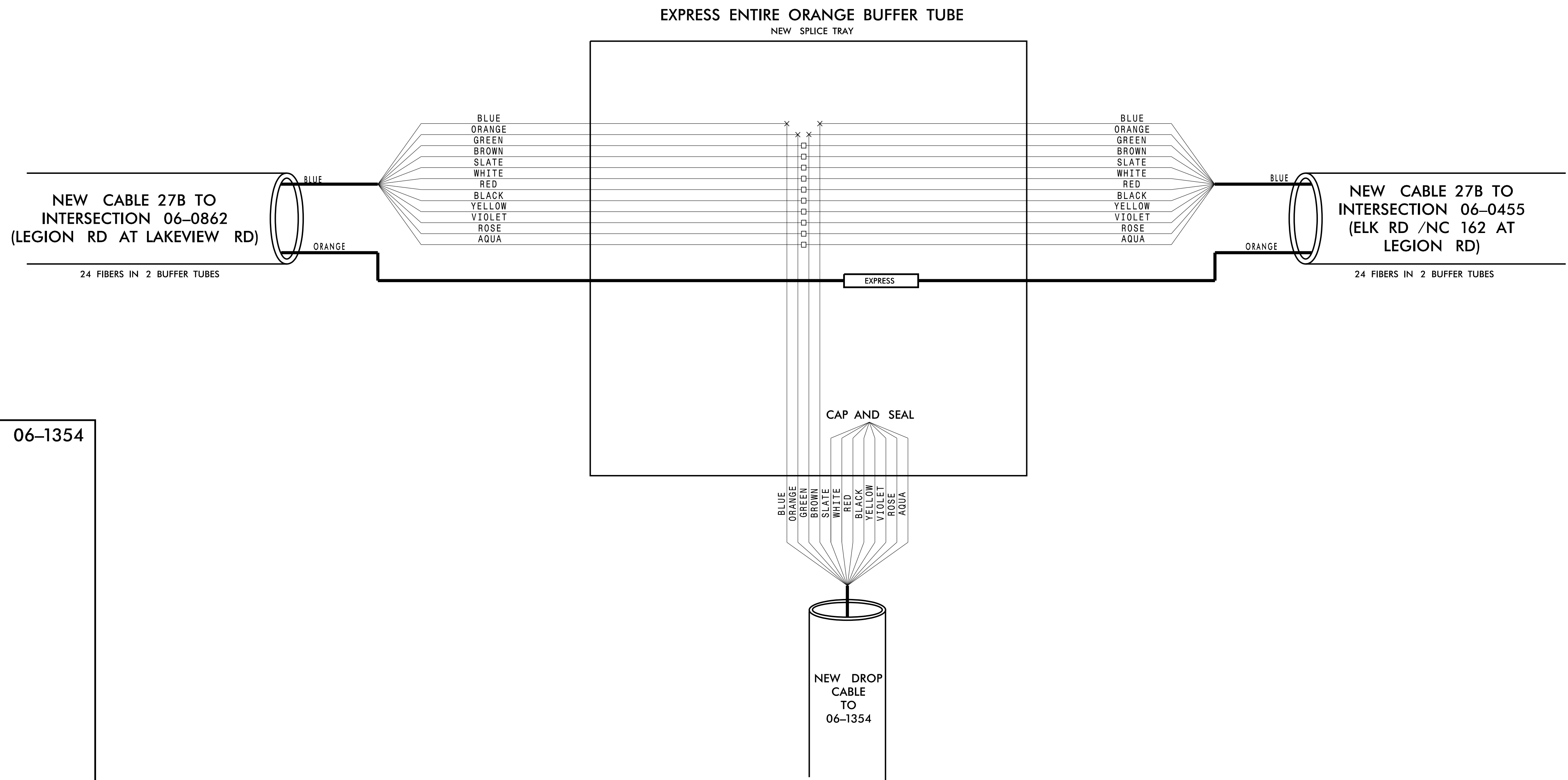

**CHANNEL 27**

**FAYETTEVILLE COMPUTERIZED SIGNAL SYSTEM**  
**SPLICE DETAIL**

DIVISION 06 CUMBERLAND COUNTY

PLAN DATE: NOVEMBER 2016 REVIEWED BY: N. M. MENGELKOCH

PREPARED BY: KHA REVIEWED BY: K. W. SMITH

REVISIONS: \_\_\_\_\_ INIT. DATE \_\_\_\_\_

SCALE: 0 \_\_\_\_\_

Kimley»Horn  
 NC License #F-0102  
 421 Fayetteville St., Suite 600  
 Raleigh, NC 27636  
 Tel: (919) 677-2000  
 Fax: (919) 677-2050

Seal: NORTH CAROLINA PROFESSIONAL ENGINEER KEVIN W. SMITH SEAL 030472

DocuSigned by: Kevin W. Smith 11/15/2016

CADD Filename: \_\_\_\_\_

11/15/2016 K:\ARL\TPTD\ITS\01036305 - Fayetteville Sig Sys\Plans\Splicing\01036305-ITS\_psh\_242-Ch27 Walmart - Signal.dgn

**CHANNEL 27  
NEW SPLICE ENCLOSURE  
(LEGION RD AT LAKEVIEW RD)  
SIG ID 06-0862**

**COLOR CODE**  
TIA/EIA 598-C

|            |             |
|------------|-------------|
| (1) BLUE   | (7) RED     |
| (2) ORANGE | (8) BLACK   |
| (3) GREEN  | (9) YELLOW  |
| (4) BROWN  | (10) VIOLET |
| (5) SLATE  | (11) ROSE   |
| (6) WHITE  | (12) AQUA   |

**LEGEND**

X - FUSION SPLICE INDIVIDUAL FIBER  
 O - EXISTING SPLICE  
 □ - EXPRESS INDIVIDUAL FIBER

EXPRESS - EXPRESS ENTIRE BUFFER TUBE  
 SPLICE - SPLICE ENTIRE BUFFER TUBE OR MAINTAIN IF EXISTING EXPRESSED

**NOTES:**  
 1. FIBER INTERCONNECT CENTER RACKS ARE SCHEMATIC ONLY - ACTUAL EQUIPMENT FORM MAY VARY.  
 2. ETHERNET SWITCH TERMINATION CONFIGURATIONS ARE GENERIC. CONTRACTOR IS RESPONSIBLE FOR DETERMINING /ENSURING PROPER TERMINATION.  
 3. CONTRACTOR IS RESPONSIBLE FOR FIELD VERIFYING EXISTING SPLICING. THE CONTRACTOR SHALL COORDINATE WITH THE ENGINEER WHERE EXISTING SPLICING IS NOT AS EXPECTED.

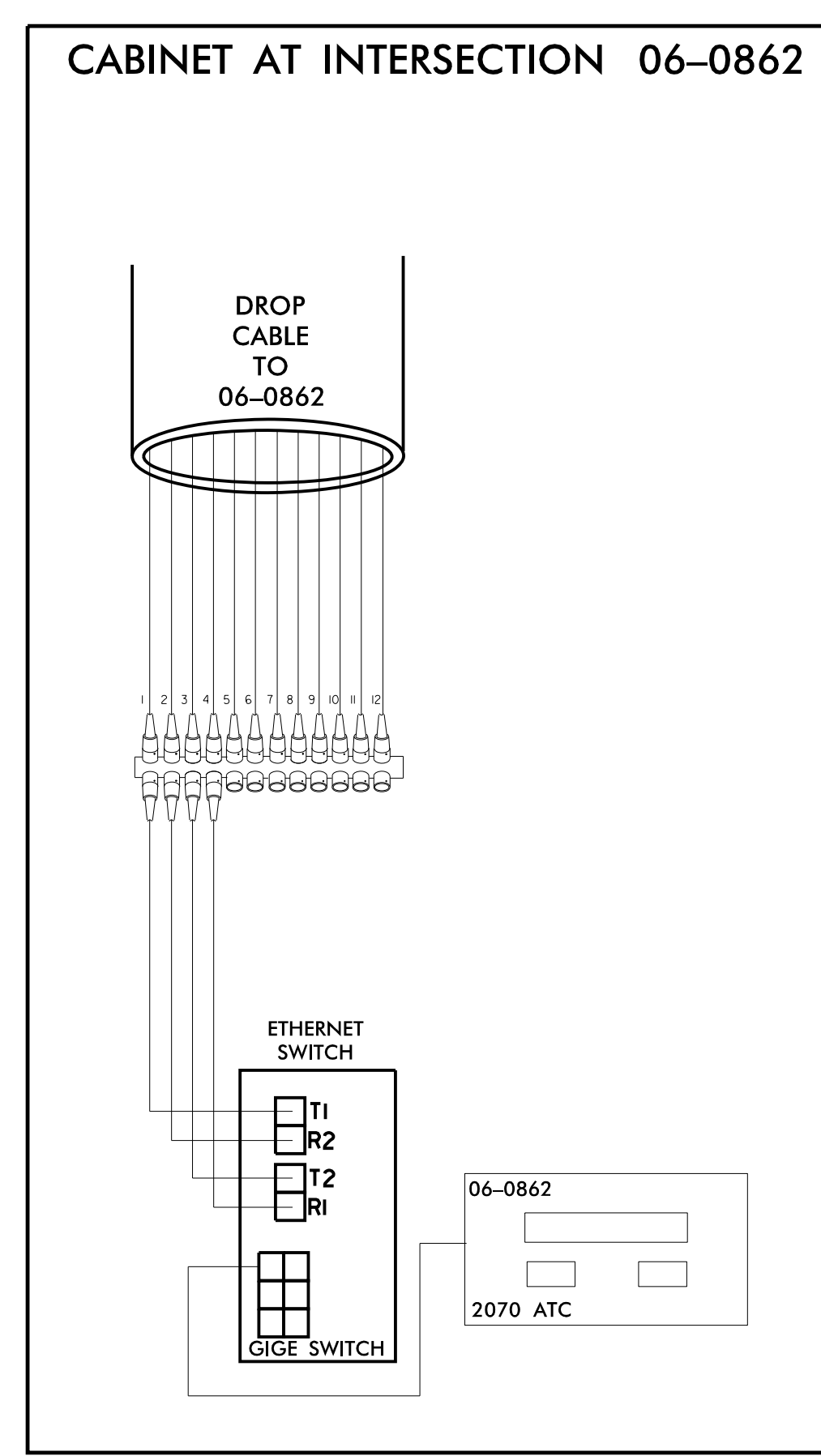
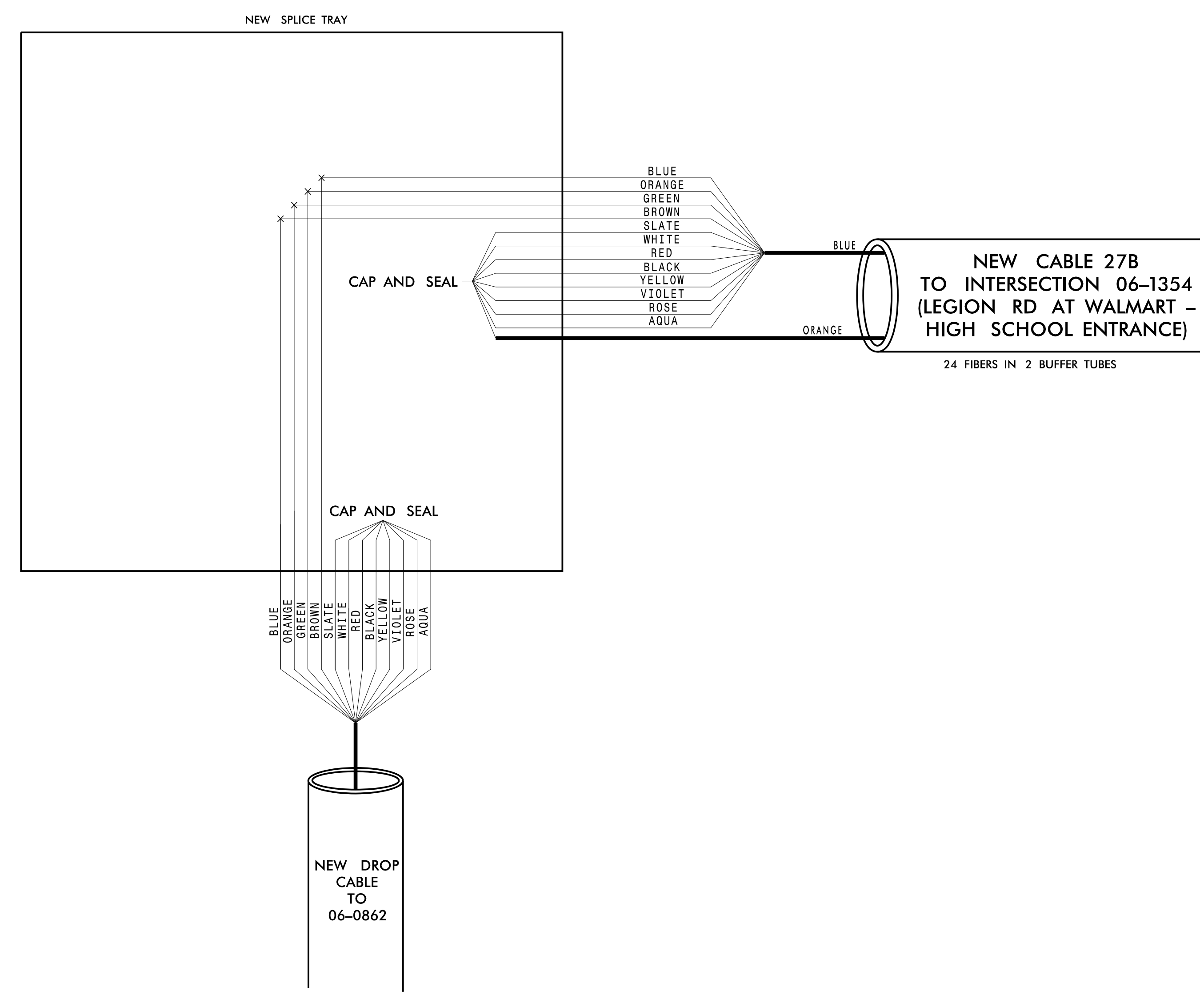

**CHANNEL 27**

**FAYETTEVILLE COMPUTERIZED SIGNAL SYSTEM**

**SPLICE DETAIL**

Division 06 CUMBERLAND COUNTY

PLAN DATE: NOVEMBER 2016 REVIEWED BY: N. M. MENGELKOCH

PREPARED BY: KHA REVIEWED BY: K. W. SMITH

SCALE: 0

Signature: Kevin W. Smith, 11/15/2016

Seal: NORTH CAROLINA PROFESSIONAL ENGINEER SEAL 030472

**Kimley»Horn**  
 NC License #F-0102  
 421 Fayetteville St., Suite 600  
 Raleigh, NC 27636  
 Tel: (919) 677-2000  
 Fax: (919) 677-2050

11/15/2016 K:\ARL\TPTD\ITS\01036305 - Fayetteville Sig Sys\Plans\Splicing\01036305-ITS\_psh-243-Ch28 06-0862.dgn

**CHANNEL 27 NEW  
NEW SPLICE ENCLOSURE  
(ELK RD AT SOUTHVIEW  
MIDDLE SCHOOL)  
SIG ID 06-1288**

**COLOR CODE**  
TIA/EIA 598-C

|            |             |
|------------|-------------|
| (1) BLUE   | (7) RED     |
| (2) ORANGE | (8) BLACK   |
| (3) GREEN  | (9) YELLOW  |
| (4) BROWN  | (10) VIOLET |
| (5) SLATE  | (11) ROSE   |
| (6) WHITE  | (12) AQUA   |

**LEGEND**

X - FUSION SPLICE INDIVIDUAL FIBER  
 O - EXISTING SPLICE  
 □ - EXPRESS INDIVIDUAL FIBER

EXPRESS - EXPRESS ENTIRE BUFFER TUBE  
 SPLICE - SPLICE ENTIRE BUFFER TUBE OR MAINTAIN IF EXISTING EXPRESSED

**NOTES:**

- FIBER INTERCONNECT CENTER RACKS ARE SCHEMATIC ONLY - ACTUAL EQUIPMENT FORM MAY VARY.
- ETHERNET SWITCH TERMINATION CONFIGURATIONS ARE GENERIC. CONTRACTOR IS RESPONSIBLE FOR DETERMINING /ENSURING PROPER TERMINATION.
- CONTRACTOR IS RESPONSIBLE FOR FIELD VERIFYING EXISTING SPLICING. THE CONTRACTOR SHALL COORDINATE WITH THE ENGINEER WHERE EXISTING SPLICING IS NOT AS EXPECTED.

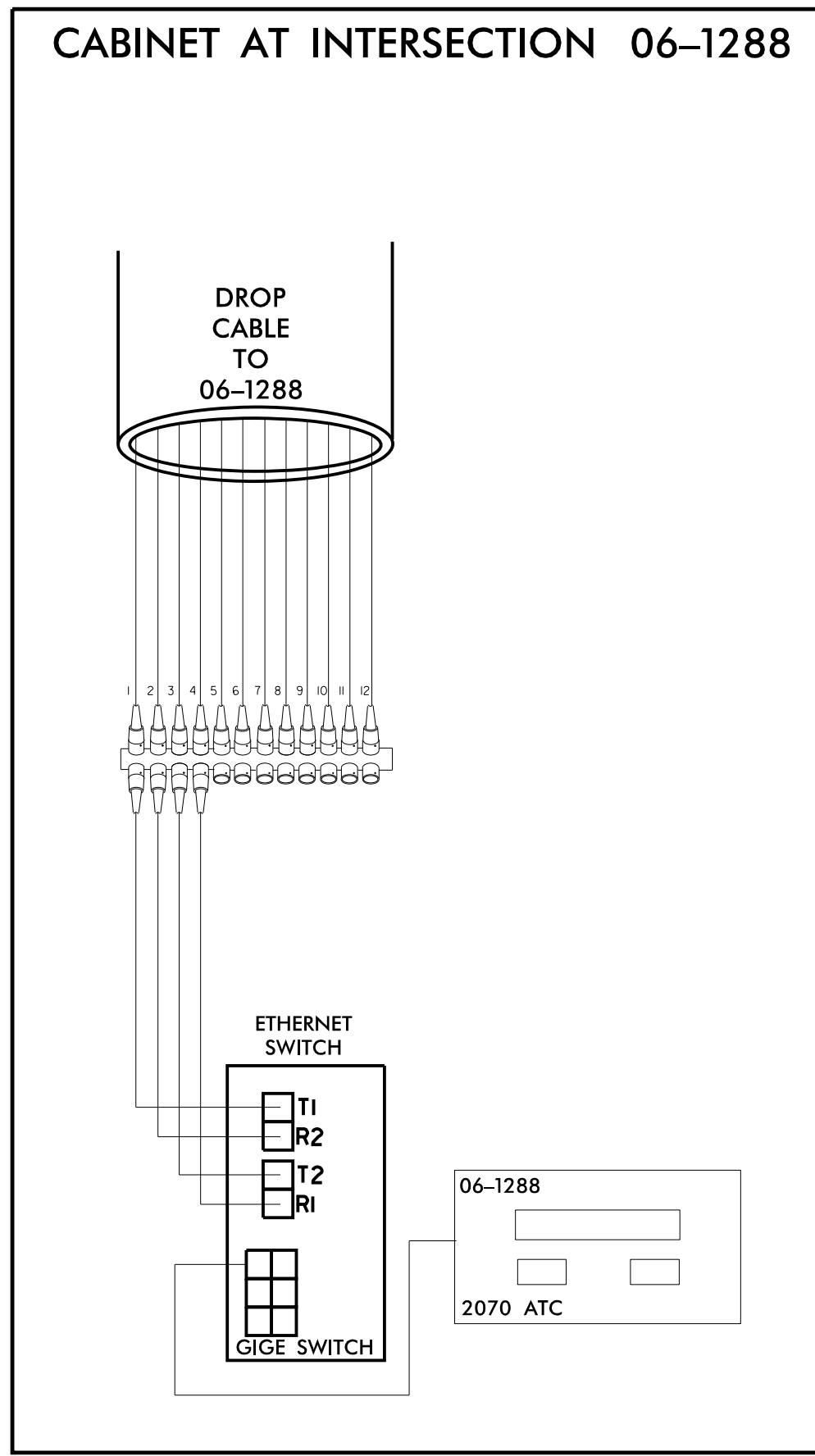
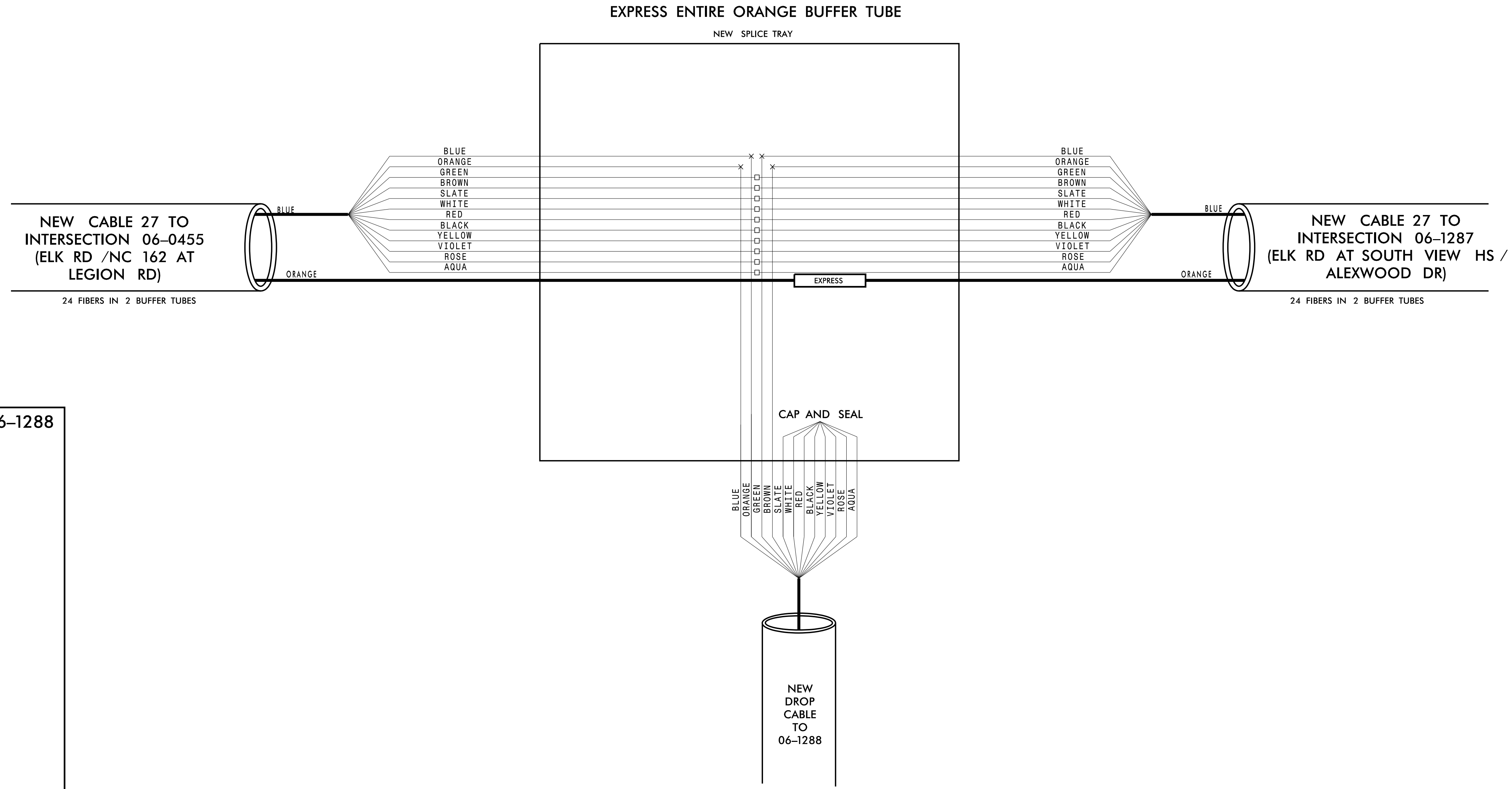

**CHANNEL 27 NEW**

**FAYETTEVILLE COMPUTERIZED SIGNAL SYSTEM**

**SPLICE DETAIL**

|                          |                               |   |      |
|--------------------------|-------------------------------|---|------|
| DIVISION 06              |                               | CUMBERLAND COUNTY   |      |
| PLAN DATE: NOVEMBER 2016 | REVIEWED BY: N. M. MENGELKOCH | SEAL<br>NORTH CAROLINA PROFESSIONAL ENGINEER<br>KEVIN W. SMITH<br>SEAL 030472 |      |
| PREPARED BY: KHA         | REVIEWED BY: K. W. SMITH      | INIT.   | DATE |
| REVISIONS                | INIT.                         | DATE  | DATE |

Kimley»Horn  
 NC License #F-0102  
 421 Fayetteville St., Suite 600  
 Raleigh, NC 27636  
 Tel: (919) 677-2000  
 Fax: (919) 677-2050

250 N. Greenfield Place, Garner, NC 27529

SCALE: 0

CADD Filename:

11/15/2016 KARAL\_TPTD\_ITS\_01036305 - Fayetteville Sig Sys Plans\Splicing\01036305\_ITS\_psh\_244-CH27\_06-1288.dgn



**CHANNEL 27 NEW  
NEW SPLICE ENCLOSURE  
(ELK RD AT SOUTH VIEW HS /  
ALEXWOOD DR)  
SIG ID 06-1287**

**COLOR CODE**  
TIA/EIA 598-C

|            |             |
|------------|-------------|
| (1) BLUE   | (7) RED     |
| (2) ORANGE | (8) BLACK   |
| (3) GREEN  | (9) YELLOW  |
| (4) BROWN  | (10) VIOLET |
| (5) SLATE  | (11) ROSE   |
| (6) WHITE  | (12) AQUA   |

**LEGEND**

X - FUSION SPLICE INDIVIDUAL FIBER  
 O - EXISTING SPLICE  
 □ - EXPRESS INDIVIDUAL FIBER

EXPRESS - EXPRESS ENTIRE BUFFER TUBE  
 SPLICE - SPLICE ENTIRE BUFFER TUBE OR MAINTAIN IF EXISTING EXPRESSED

**NOTES:**  
 1. FIBER INTERCONNECT CENTER RACKS ARE SCHEMATIC ONLY - ACTUAL EQUIPMENT FORM MAY VARY.  
 2. ETHERNET SWITCH TERMINATION CONFIGURATIONS ARE GENERIC. CONTRACTOR IS RESPONSIBLE FOR DETERMINING /ENSURING PROPER TERMINATION.  
 3. CONTRACTOR IS RESPONSIBLE FOR FIELD VERIFYING EXISTING SPLICING. THE CONTRACTOR SHALL COORDINATE WITH THE ENGINEER WHERE EXISTING SPLICING IS NOT AS EXPECTED.

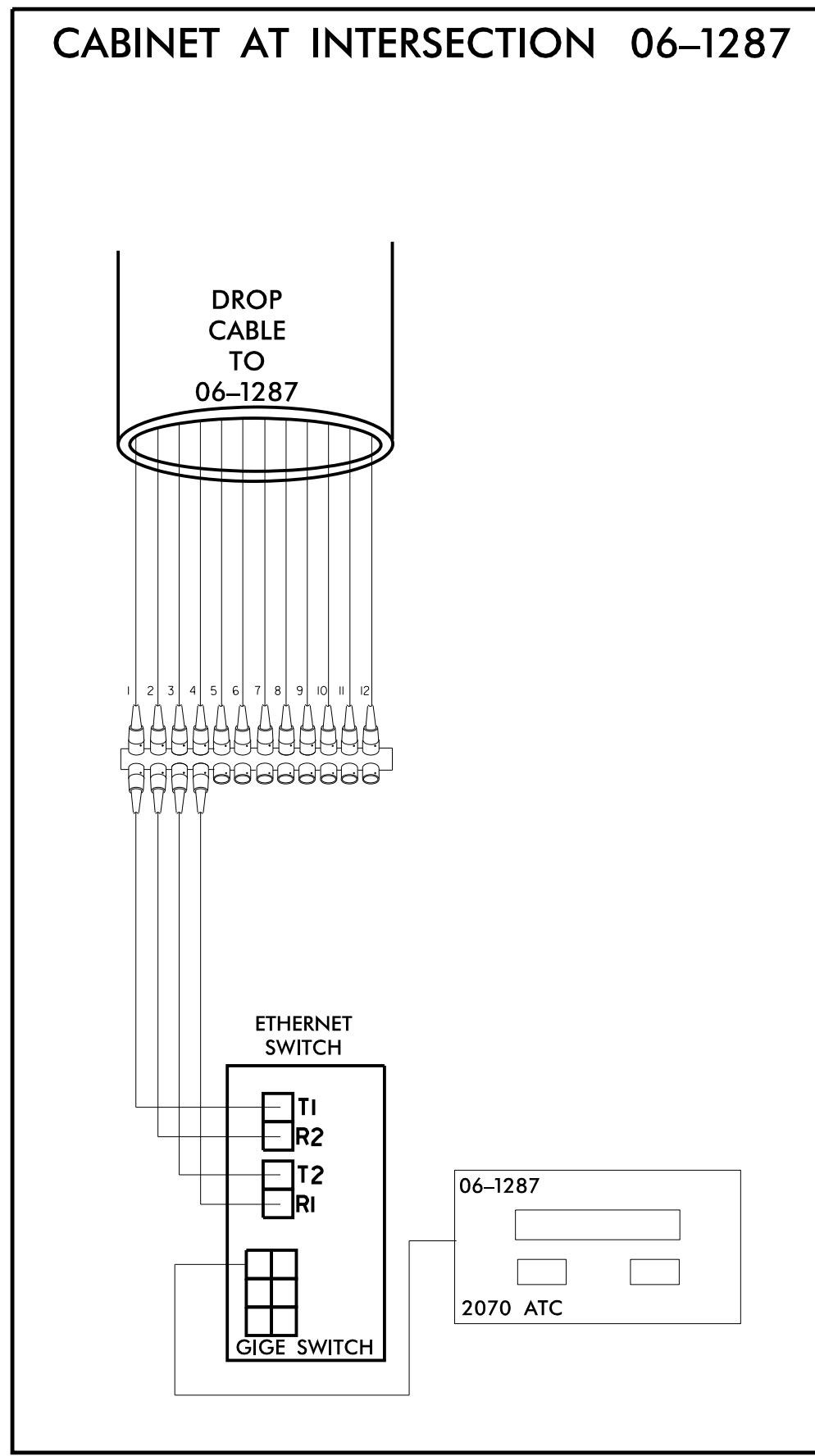
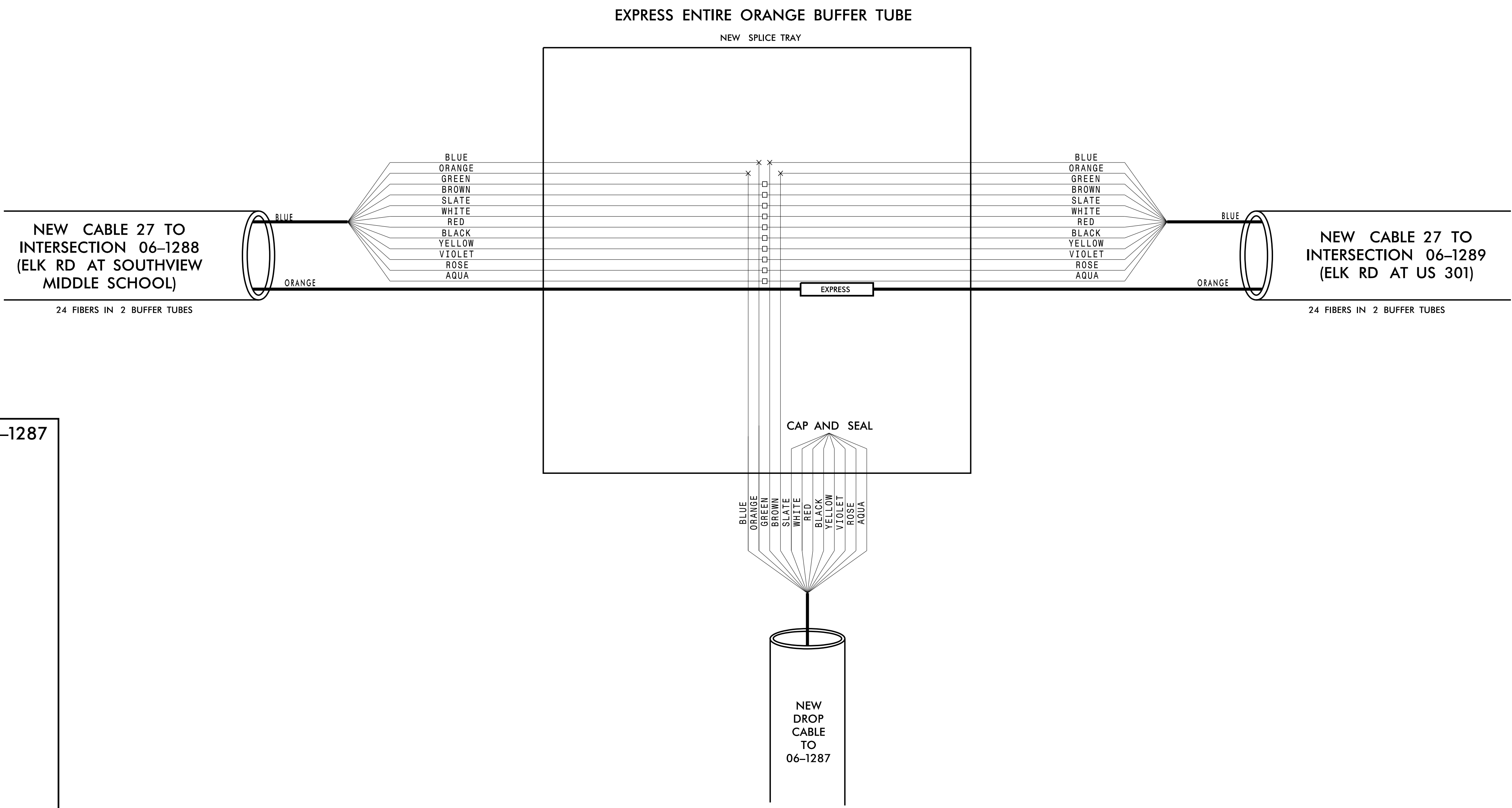

11/15/2016 K:\ARL\TPTD\ITS\01036305 - Fayetteville Sig Sys\Plans\Splicing\01036305-ITS\_psh-245-CH27\_06-1287.dgn

**Kimley»Horn**  
 NC License #F-0102  
 421 Fayetteville St., Suite 600  
 Raleigh, NC 27636  
 Tel: (919) 677-2000  
 Fax: (919) 677-2050

**CHANNEL 27 NEW**

**FAYETTEVILLE COMPUTERIZED SIGNAL SYSTEM**

**SPLICE DETAIL**

|                          |                               |                   |                               |
|--------------------------|-------------------------------|-------------------|-------------------------------|
| DIVISION 06              |                               | CUMBERLAND COUNTY |                               |
| PLAN DATE: NOVEMBER 2016 | REVIEWED BY: N. M. MENGELKOCH | PREPARED BY: KHA  | REVIEWED BY: K. W. SMITH      |
| REVISIONS                | INIT.                         | DATE              | DocuSigned by: Kevin W. Smith |
|                          |                               |                   | 11/15/2016                    |
|                          | SIGNATURE                     |                   | DATE                          |
|                          |                               |                   |                               |

CADD Filename: \_\_\_\_\_

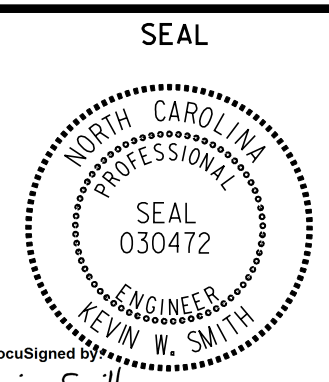

**CHANNEL 27 NEW  
NEW SPLICE ENCLOSURE  
(ELK RD AT US 301)  
SIG ID 06-1289  
CCTV 39**

**COLOR CODE**  
TIA/EIA 598-C

|            |             |
|------------|-------------|
| (1) BLUE   | (7) RED     |
| (2) ORANGE | (8) BLACK   |
| (3) GREEN  | (9) YELLOW  |
| (4) BROWN  | (10) VIOLET |
| (5) SLATE  | (11) ROSE   |
| (6) WHITE  | (12) AQUA   |

**LEGEND**

X - FUSION SPLICE INDIVIDUAL FIBER  
 O - EXISTING SPLICE  
 □ - EXPRESS INDIVIDUAL FIBER

EXPRESS - EXPRESS ENTIRE BUFFER TUBE  
 SPLICE - SPLICE ENTIRE BUFFER TUBE OR MAINTAIN IF EXISTING EXPRESSED

**NOTES:**  
 1. FIBER INTERCONNECT CENTER RACKS ARE SCHEMATIC ONLY - ACTUAL EQUIPMENT FORM MAY VARY.  
 2. ETHERNET SWITCH TERMINATION CONFIGURATIONS ARE GENERIC. CONTRACTOR IS RESPONSIBLE FOR DETERMINING /ENSURING PROPER TERMINATION.  
 3. CONTRACTOR IS RESPONSIBLE FOR FIELD VERIFYING EXISTING SPLICING. THE CONTRACTOR SHALL COORDINATE WITH THE ENGINEER WHERE EXISTING SPLICING IS NOT AS EXPECTED.

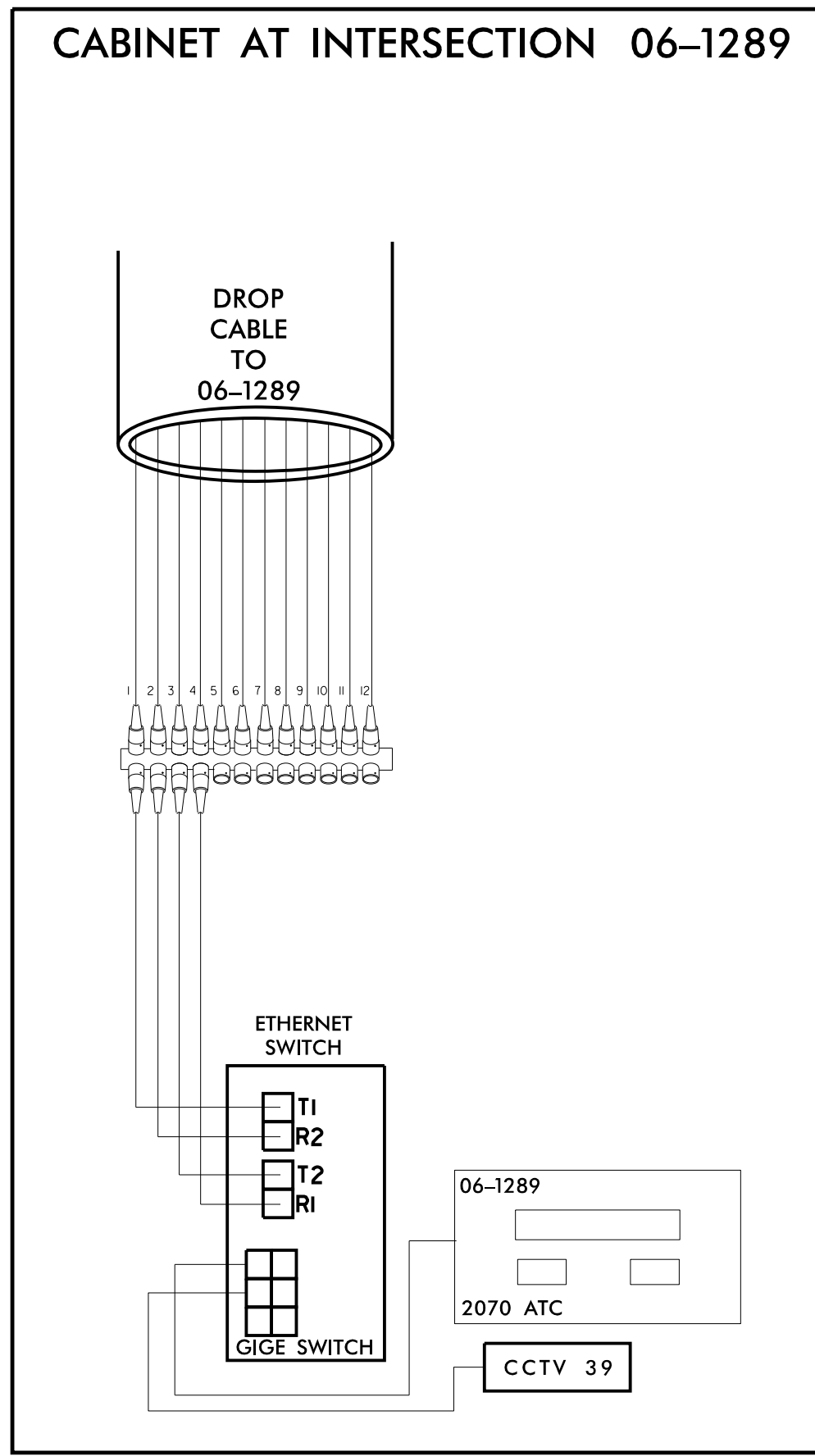
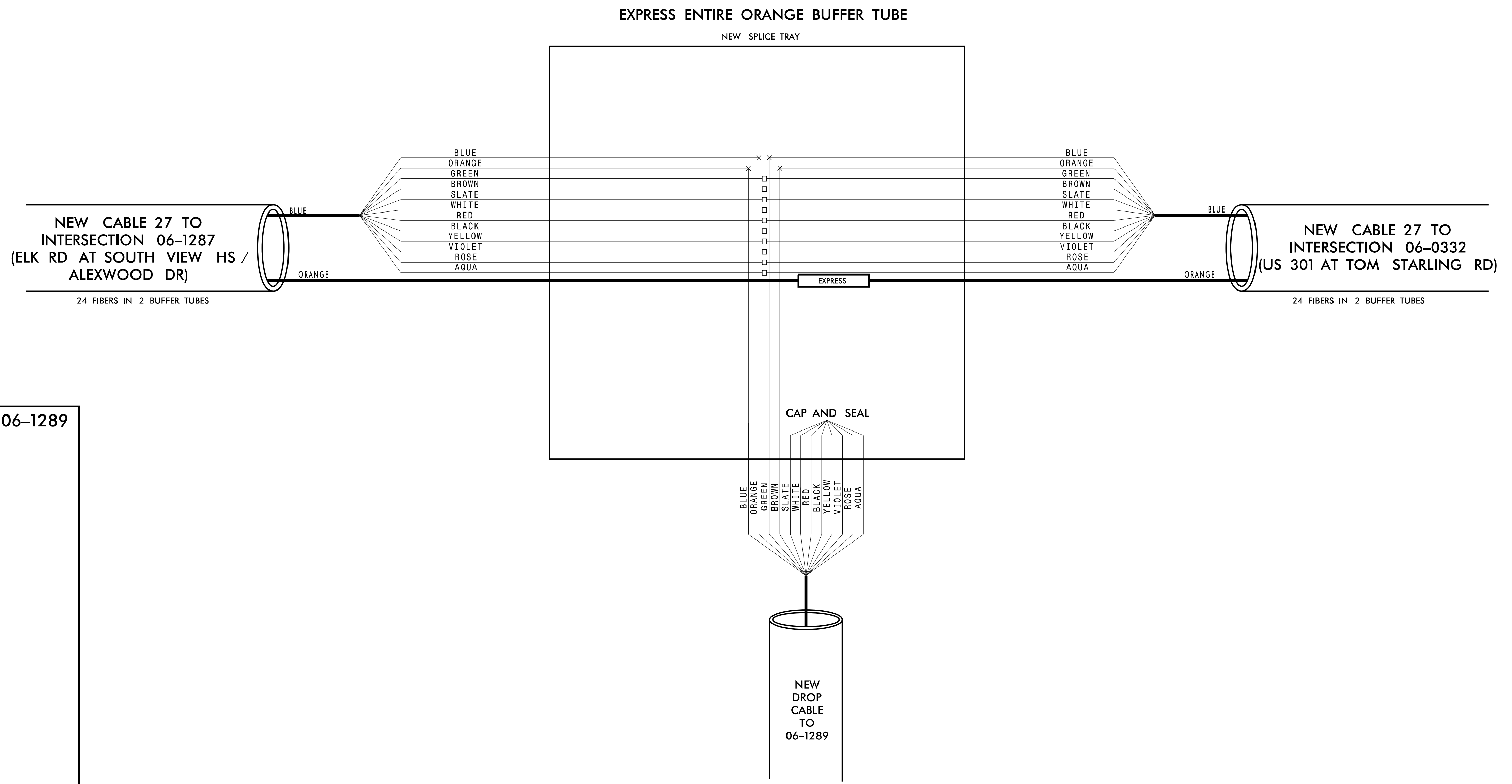

**CHANNEL 27 NEW**

**FAYETTEVILLE COMPUTERIZED SIGNAL SYSTEM**

**SPLICE DETAIL**

DIVISION 06 CUMBERLAND COUNTY

PLAN DATE: NOVEMBER 2016 REVIEWED BY: N. M. MENGELKOCH

PREPARED BY: KHA REVIEWED BY: K. W. SMITH

SCALE: 0

Signature: Kevin Smith, 11/15/2016

Seal: NORTH CAROLINA PROFESSIONAL ENGINEER SEAL 030472

**Kimley»Horn**  
 NC License #F-0102  
 421 Fayetteville St., Suite 600  
 Raleigh, NC 27636  
 Tel: (919) 677-2000  
 Fax: (919) 677-2050

11/15/2016 K:\ARL\TPTD\ITS\01036305 - Fayetteville Sig Sys\Plans\Splicing\01036305-ITS\_psh-246-CH27\_06-1289 CCTV39.dgn

**CHANNEL 27 NEW  
NEW SPLICE ENCLOSURE  
(US 301 AT TOM STARLING RD)  
SIG ID 06-0332**

**COLOR CODE**  
TIA/EIA 598-C

|            |             |
|------------|-------------|
| (1) BLUE   | (7) RED     |
| (2) ORANGE | (8) BLACK   |
| (3) GREEN  | (9) YELLOW  |
| (4) BROWN  | (10) VIOLET |
| (5) SLATE  | (11) ROSE   |
| (6) WHITE  | (12) AQUA   |

**LEGEND**

X - FUSION SPLICE INDIVIDUAL FIBER  
 O - EXISTING SPLICE  
 □ - EXPRESS INDIVIDUAL FIBER

EXPRESS - EXPRESS ENTIRE BUFFER TUBE  
 SPLICE - SPLICE ENTIRE BUFFER TUBE OR MAINTAIN IF EXISTING EXPRESSED

**NOTES:**  
 1. FIBER INTERCONNECT CENTER RACKS ARE SCHEMATIC ONLY - ACTUAL EQUIPMENT FORM MAY VARY.  
 2. ETHERNET SWITCH TERMINATION CONFIGURATIONS ARE GENERIC. CONTRACTOR IS RESPONSIBLE FOR DETERMINING /ENSURING PROPER TERMINATION.  
 3. CONTRACTOR IS RESPONSIBLE FOR FIELD VERIFYING EXISTING SPLICING. THE CONTRACTOR SHALL COORDINATE WITH THE ENGINEER WHERE EXISTING SPLICING IS NOT AS EXPECTED.

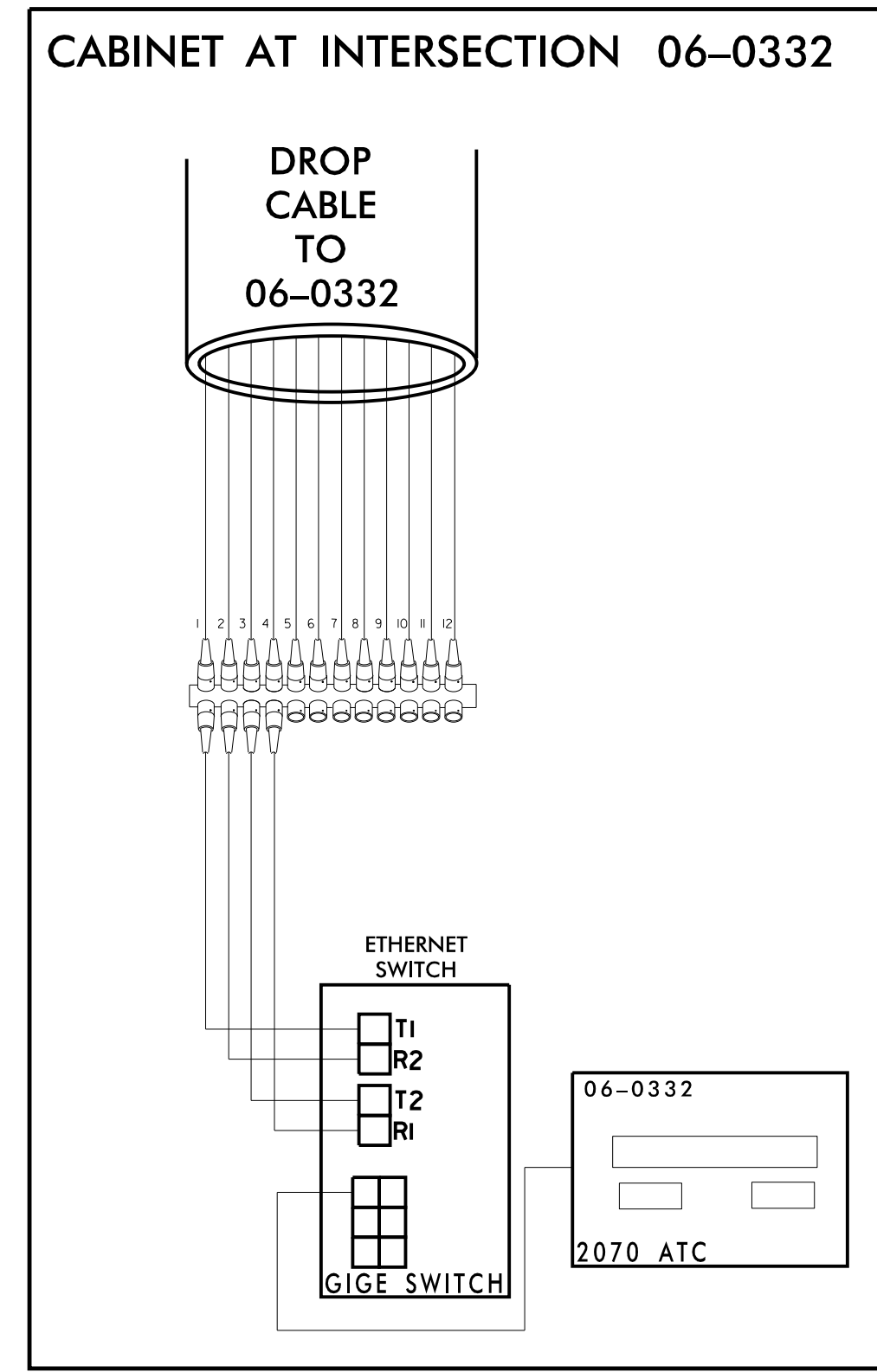
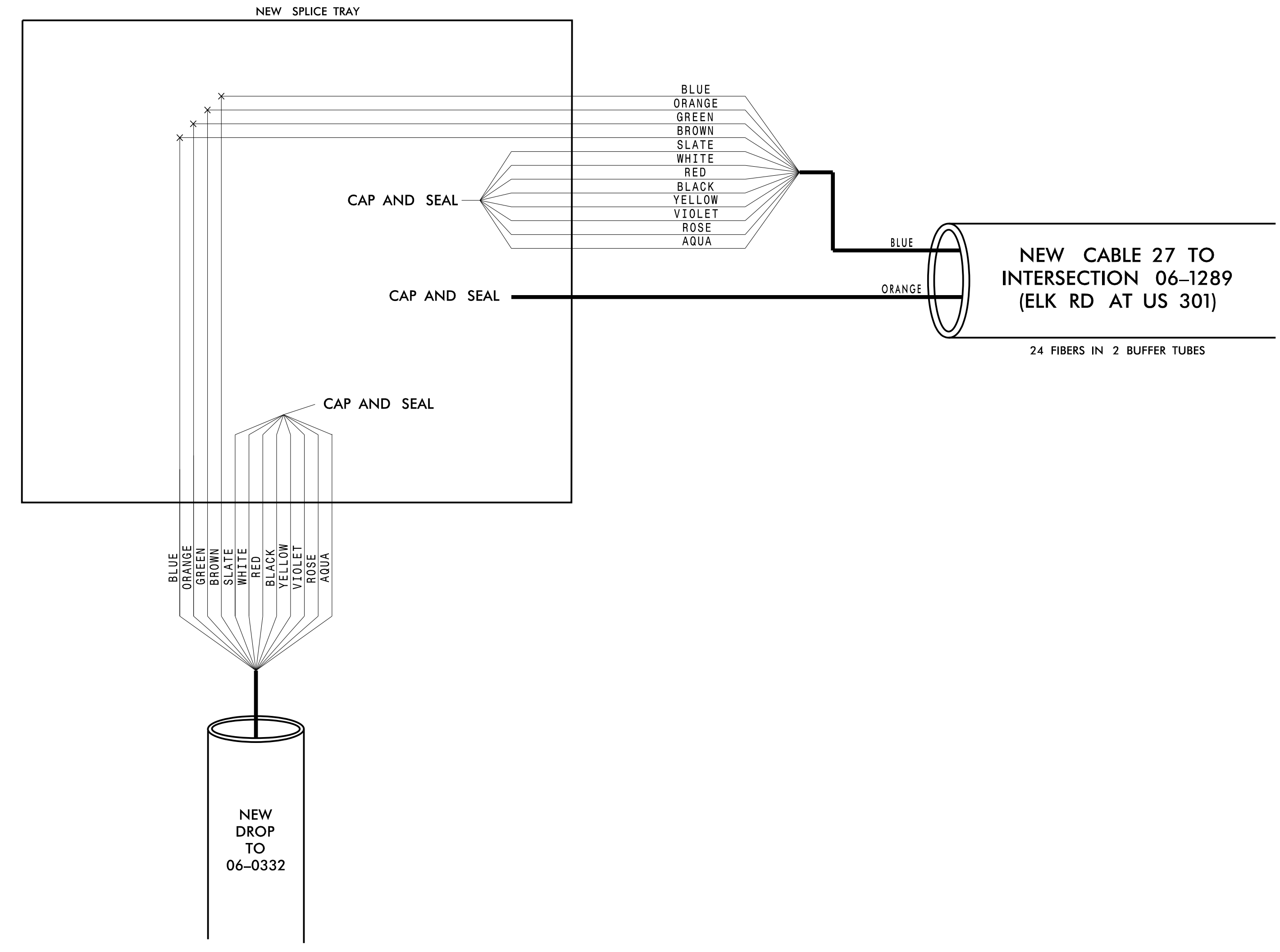

**CHANNEL 27 NEW**

**FAYETTEVILLE COMPUTERIZED SIGNAL SYSTEM**

**SPLICE DETAIL**

DIVISION 06 CUMBERLAND COUNTY

PLAN DATE: NOVEMBER 2016 REVIEWED BY: N.W. MENGELKOCH

PREPARED BY: KHA REVIEWED BY: K.W. SMITH

SCALE: 0

REVISIONS: \_\_\_\_\_

INIT. DATE

Signature: *Kevin W. Smith* 11/15/2016

SEAL: NORTH CAROLINA PROFESSIONAL ENGINEER SEAL 030472 KEVIN W. SMITH

CADD Filename: \_\_\_\_\_

**Kimley»Horn**  
 NC License #F-0102  
 421 Fayetteville St., Suite 600  
 Raleigh, NC 27636  
 Tel: (919) 677-2000  
 Fax: (919) 677-2050

11/15/2016 K:\ARL\_TPTD\_ITS\01036305 - Fayetteville Sig Sys\Plans\Splicing\01036305-ITS\_psh-247-CH27\_06-0332.dgn

**CHANNEL 28 NEW  
EXISTING SPLICE ENCLOSURE  
(HOPE MILLS RD AT REDWOOD RD)  
SIG ID 06-0337**

**COLOR CODE**  
TIA/EIA 598-C

|            |             |
|------------|-------------|
| (1) BLUE   | (7) RED     |
| (2) ORANGE | (8) BLACK   |
| (3) GREEN  | (9) YELLOW  |
| (4) BROWN  | (10) VIOLET |
| (5) SLATE  | (11) ROSE   |
| (6) WHITE  | (12) AQUA   |

**LEGEND**

X - FUSION SPLICE INDIVIDUAL FIBER  
 O - EXISTING SPLICE  
 □ - EXPRESS INDIVIDUAL FIBER

EXPRESS - EXPRESS ENTIRE BUFFER TUBE  
 SPLICE - SPLICE ENTIRE BUFFER TUBE OR MAINTAIN IF EXISTING EXPRESSED

**NOTES:**

- FIBER INTERCONNECT CENTER RACKS ARE SCHEMATIC ONLY - ACTUAL EQUIPMENT FORM MAY VARY.
- ETHERNET SWITCH TERMINATION CONFIGURATIONS ARE GENERIC. CONTRACTOR IS RESPONSIBLE FOR DETERMINING /ENSURING PROPER TERMINATION.
- CONTRACTOR IS RESPONSIBLE FOR FIELD VERIFYING EXISTING SPLICING. THE CONTRACTOR SHALL COORDINATE WITH THE ENGINEER WHERE EXISTING SPLICING IS NOT AS EXPECTED.

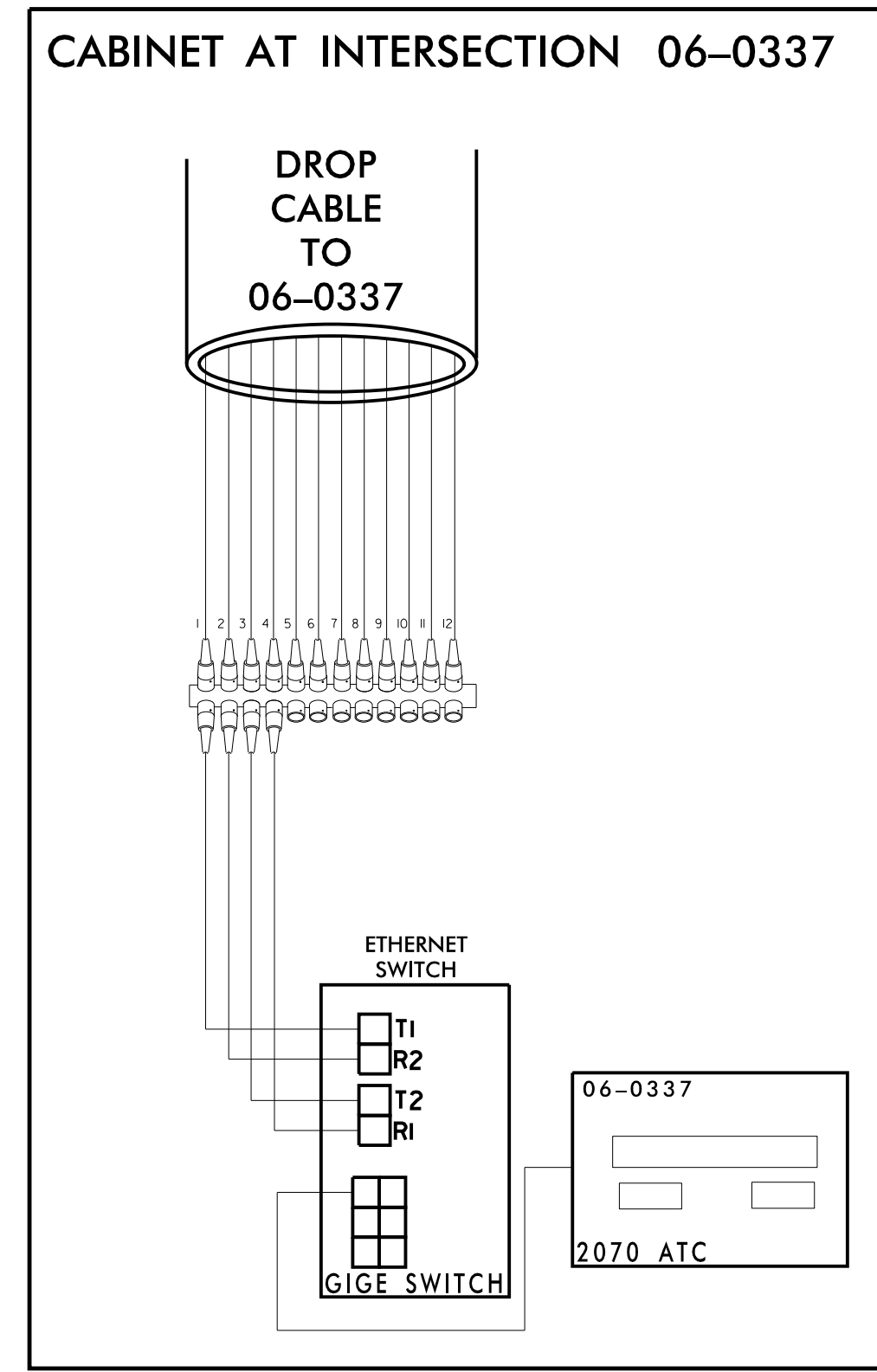
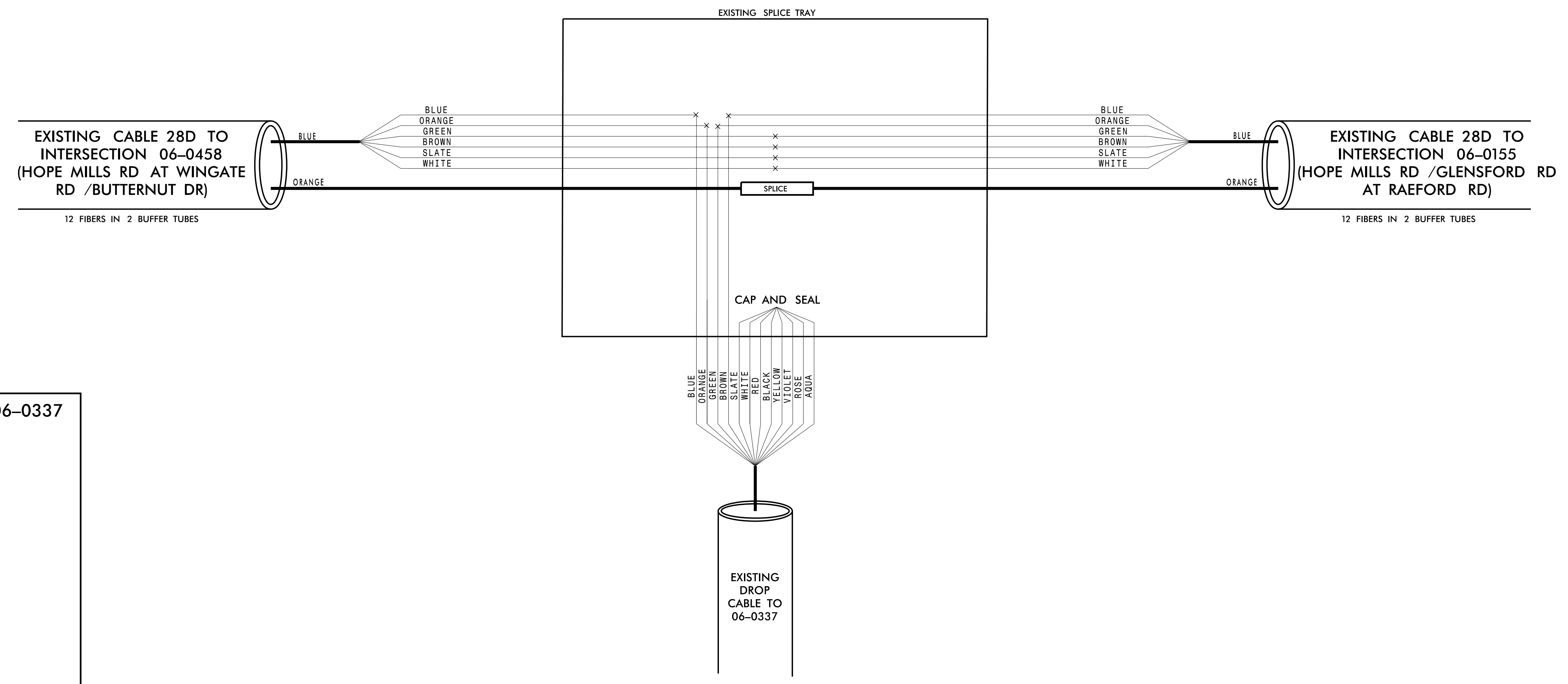

**CHANNEL 28 NEW**

**FAYETTEVILLE COMPUTERIZED SIGNAL SYSTEM**

**SPLICE DETAIL**

DIVISION 06 CUMBERLAND COUNTY

PLAN DATE: NOVEMBER 2016 REVIEWED BY: N. M. MENGELKOCH

PREPARED BY: KHA REVIEWED BY: K. W. SMITH

| REVISIONS | INIT. | DATE |
|-----------|-------|------|
|           |       |      |
|           |       |      |

SCALE: 0

**Kimley»Horn**  
 NC License #F-0102  
 421 Fayetteville St., Suite 600  
 Raleigh, NC 27636  
 Tel: (919) 677-2000  
 Fax: (919) 677-2050

**SEAL**  
 NORTH CAROLINA PROFESSIONAL ENGINEER  
 KEVIN W. SMITH  
 SEAL 030472  
 11/15/2016  
 SIGNATURE DATE  
 CADD Filename:

11/15/2016 K:\ARL\TPTD\ITS\01036305 - Fayetteville Sig Sys\Plans\Splicing\01036305-ITS\_psh\_248-Ch28 06-0337.dgn

**CHANNEL 28 NEW**  
**EXISTING SPLICE ENCLOSURE**  
 (HOPE MILLS RD AT WINGATE RD /  
 BUTTERNUT DR)  
 SIG ID 06-0458

**COLOR CODE**  
 TIA/EIA 598-C

|            |             |
|------------|-------------|
| (1) BLUE   | (7) RED     |
| (2) ORANGE | (8) BLACK   |
| (3) GREEN  | (9) YELLOW  |
| (4) BROWN  | (10) VIOLET |
| (5) SLATE  | (11) ROSE   |
| (6) WHITE  | (12) AQUA   |

**LEGEND**

X - FUSION SPLICE INDIVIDUAL FIBER  
 O - EXISTING SPLICE  
 □ - EXPRESS INDIVIDUAL FIBER

EXPRESS - EXPRESS ENTIRE BUFFER TUBE  
 SPLICE - SPLICE ENTIRE BUFFER TUBE OR MAINTAIN IF EXISTING EXPRESSED

**NOTES:**

- FIBER INTERCONNECT CENTER RACKS ARE SCHEMATIC ONLY - ACTUAL EQUIPMENT FORM MAY VARY.
- ETHERNET SWITCH TERMINATION CONFIGURATIONS ARE GENERIC. CONTRACTOR IS RESPONSIBLE FOR DETERMINING /ENSURING PROPER TERMINATION.
- CONTRACTOR IS RESPONSIBLE FOR FIELD VERIFYING EXISTING SPLICING. THE CONTRACTOR SHALL COORDINATE WITH THE ENGINEER WHERE EXISTING SPLICING IS NOT AS EXPECTED.

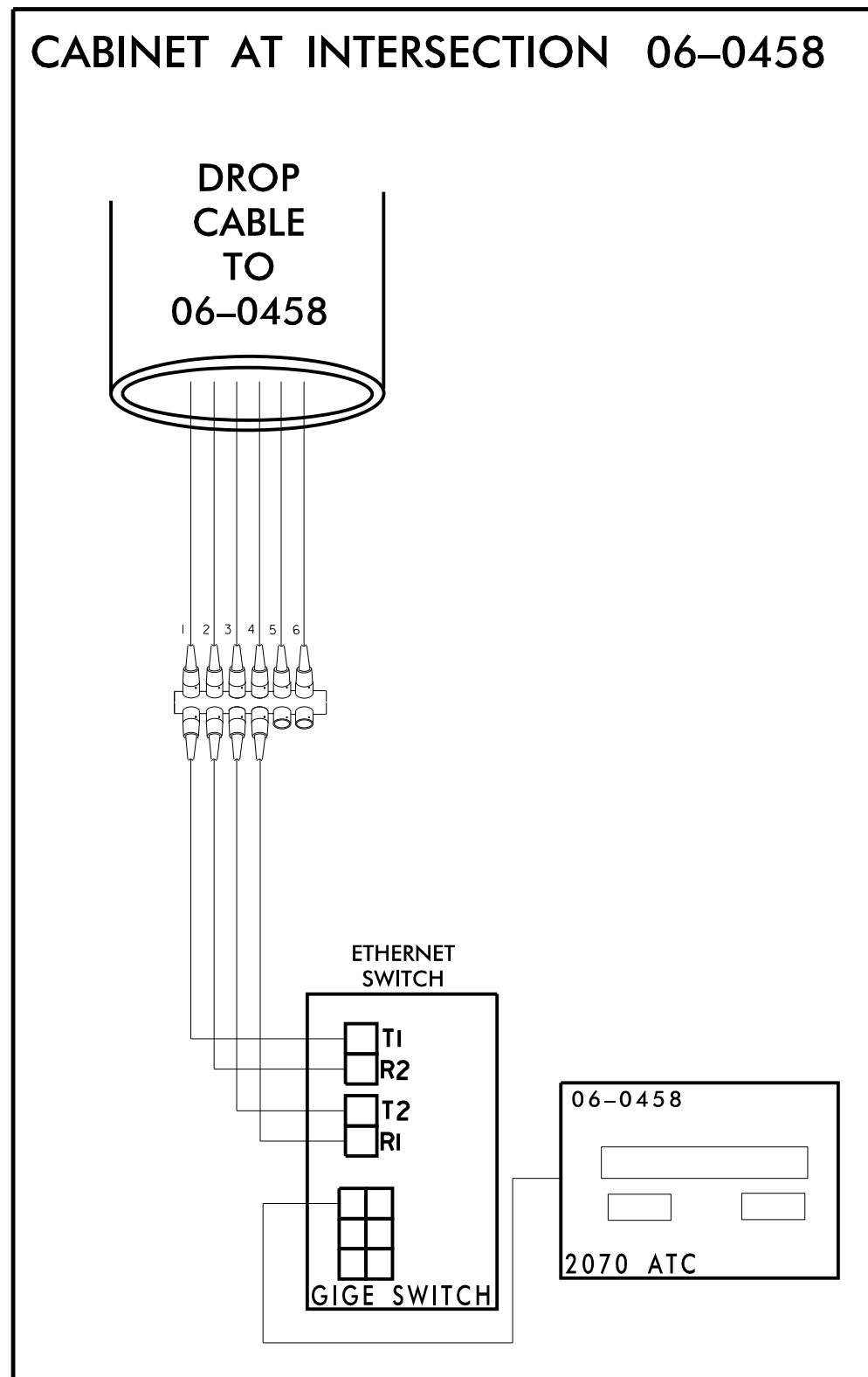
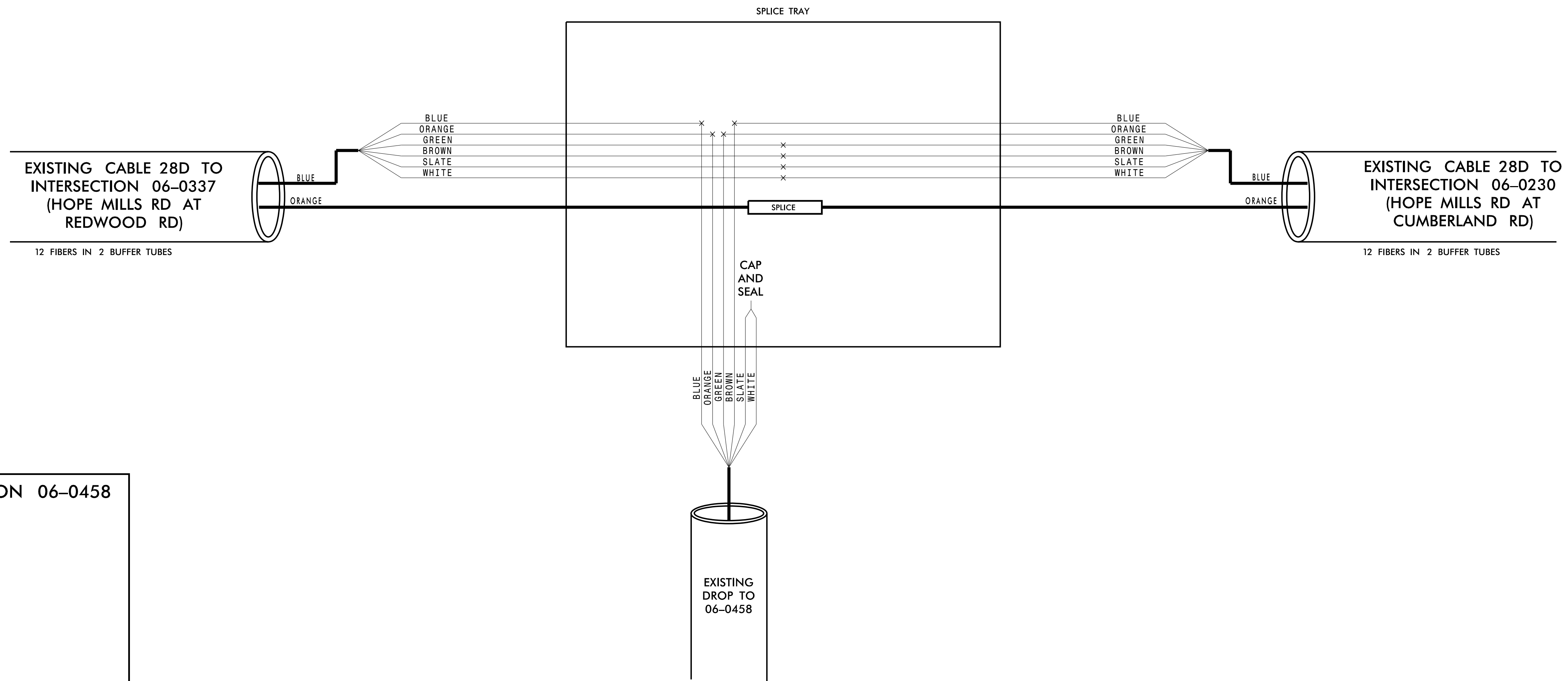

**CHANNEL 28 NEW**  
**FAYETTEVILLE COMPUTERIZED SIGNAL SYSTEM**  
**SPLICE DETAIL**

Division 06 CUMBERLAND COUNTY

PLAN DATE: NOVEMBER 2016 REVIEWED BY: N. W. MENGELKOCH

PREPARED BY: KHA REVIEWED BY: K. W. SMITH

SCALE: 0

REVISIONS: INIT. DATE

Signature: Kevin W. Smith  
 SEAL: 030472  
 DATE: 11/15/2016

**Kimley»Horn**  
 NC License #F-0102  
 421 Fayetteville St., Suite 600  
 Raleigh, NC 27636  
 Tel: (919) 677-2000  
 Fax: (919) 677-2050

11/15/2016 K:\ARL\TPTD\ITS\01036305 - Fayetteville Sig Sys\Plans\Splicing\01036305-ITS-psk-249-Ch28 06-0458.dgn

**CHANNEL 28 NEW  
EXISTING SPLICE ENCLOSURE  
IN CABINET  
(HOPE MILLS RD AT LAKEVIEW RD)  
SIG ID 06-0069**

**COLOR CODE**  
TIA/EIA 598-C

|            |             |
|------------|-------------|
| (1) BLUE   | (7) RED     |
| (2) ORANGE | (8) BLACK   |
| (3) GREEN  | (9) YELLOW  |
| (4) BROWN  | (10) VIOLET |
| (5) SLATE  | (11) ROSE   |
| (6) WHITE  | (12) AQUA   |

**LEGEND**

- X - FUSION SPLICE INDIVIDUAL FIBER
- O - EXISTING SPLICE
- - EXPRESS INDIVIDUAL FIBER

EXPRESS: EXPRESS ENTIRE BUFFER TUBE  
SPLICE: SPLICE ENTIRE BUFFER TUBE OR MAINTAIN IF EXISTING EXPRESSED

**NOTES:**

- FIBER INTERCONNECT CENTER RACKS ARE SCHEMATIC ONLY - ACTUAL EQUIPMENT FORM MAY VARY.
- ETHERNET SWITCH TERMINATION CONFIGURATIONS ARE GENERIC. CONTRACTOR IS RESPONSIBLE FOR DETERMINING /ENSURING PROPER TERMINATION.
- CONTRACTOR IS RESPONSIBLE FOR FIELD VERIFYING EXISTING SPLICING. THE CONTRACTOR SHALL COORDINATE WITH THE ENGINEER WHERE EXISTING SPLICING IS NOT AS EXPECTED.

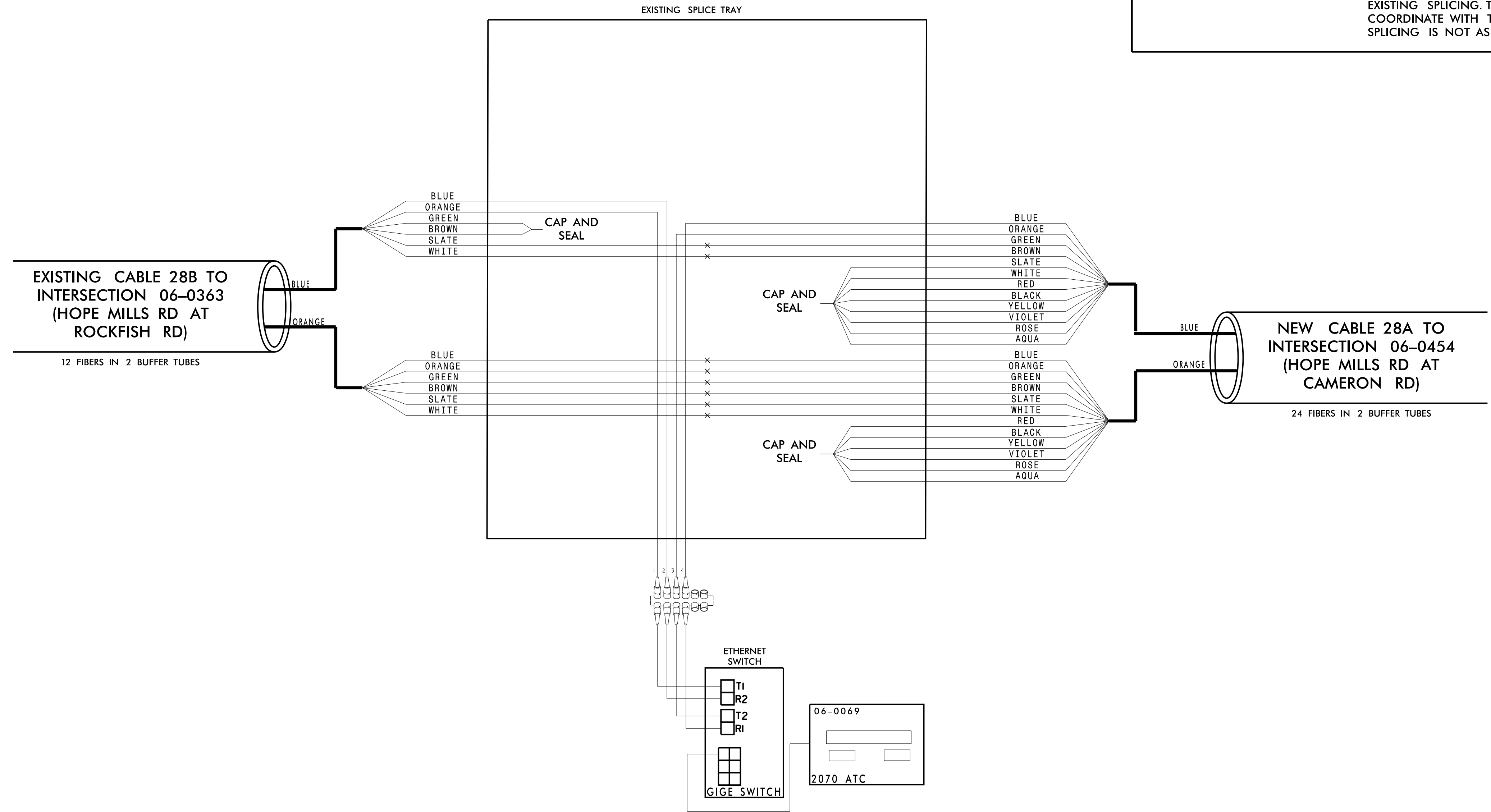

11/15/2016 KARAL\_TPTD\_ITS\_01036305 - Fayetteville Sig Sys\Plans\Splicing\01036305-ITS\_psh\_250-CH28\_06-0069.dgn

**CHANNEL 28 NEW**

**FAYETTEVILLE COMPUTERIZED  
SIGNAL SYSTEM  
SPLICE DETAIL**

**Kimley»Horn**  
NC License #F-0102  
421 Fayetteville St., Suite 600  
Raleigh, NC 27636  
Tel: (919) 677-2000  
Fax: (919) 677-2050

|                               |                               |                              |            |
|-------------------------------|-------------------------------|------------------------------|------------|
|                               | DIVISION 06 CUMBERLAND COUNTY |                              |            |
|                               | PLAN DATE: NOVEMBER 2016      | REVIEWED BY: N.M. MENGELKOCH |            |
| SCALE: 0                      | REVISIONS                     | INIT.                        | DATE       |
| DocuSigned by: Kevin W. Smith |                               |                              | 11/15/2016 |
| CADD Filename:                |                               |                              | DATE       |

**CHANNEL 28 NEW  
NEW SPLICE ENCLOSURE  
(HOPE MILLS RD AT CAMERON  
RD)  
SIG ID 06-0454**

**COLOR CODE**  
TIA/EIA 598-C

|            |             |
|------------|-------------|
| (1) BLUE   | (7) RED     |
| (2) ORANGE | (8) BLACK   |
| (3) GREEN  | (9) YELLOW  |
| (4) BROWN  | (10) VIOLET |
| (5) SLATE  | (11) ROSE   |
| (6) WHITE  | (12) AQUA   |

**LEGEND**

X - FUSION SPLICE INDIVIDUAL FIBER  
 O - EXISTING SPLICE  
 □ - EXPRESS INDIVIDUAL FIBER

EXPRESS - EXPRESS ENTIRE BUFFER TUBE  
 SPLICE - SPLICE ENTIRE BUFFER TUBE OR MAINTAIN IF EXISTING EXPRESSED

**NOTES:**  
 1. FIBER INTERCONNECT CENTER RACKS ARE SCHEMATIC ONLY - ACTUAL EQUIPMENT FORM MAY VARY.  
 2. ETHERNET SWITCH TERMINATION CONFIGURATIONS ARE GENERIC. CONTRACTOR IS RESPONSIBLE FOR DETERMINING /ENSURING PROPER TERMINATION.  
 3. CONTRACTOR IS RESPONSIBLE FOR FIELD VERIFYING EXISTING SPLICING. THE CONTRACTOR SHALL COORDINATE WITH THE ENGINEER WHERE EXISTING SPLICING IS NOT AS EXPECTED.

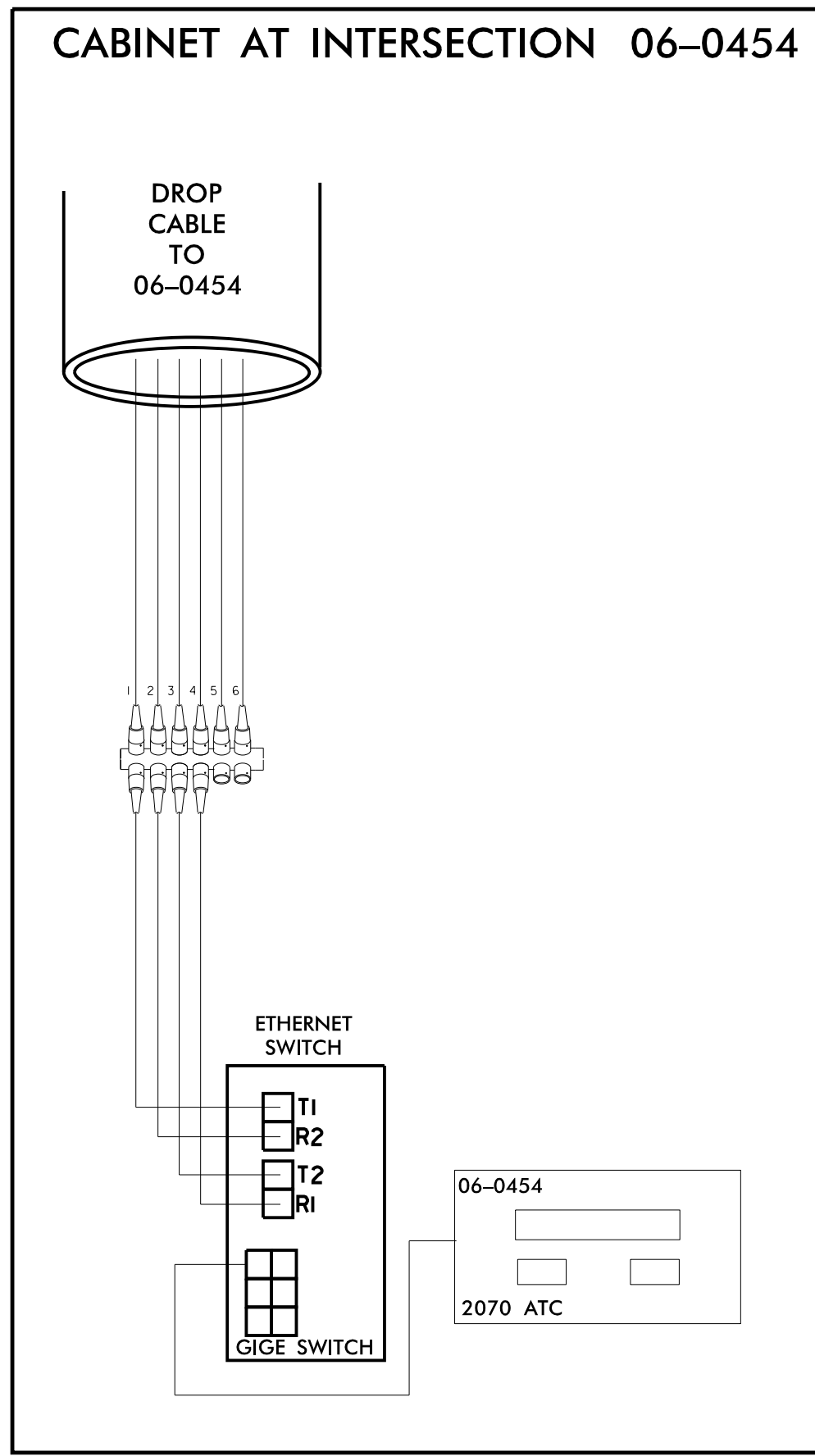
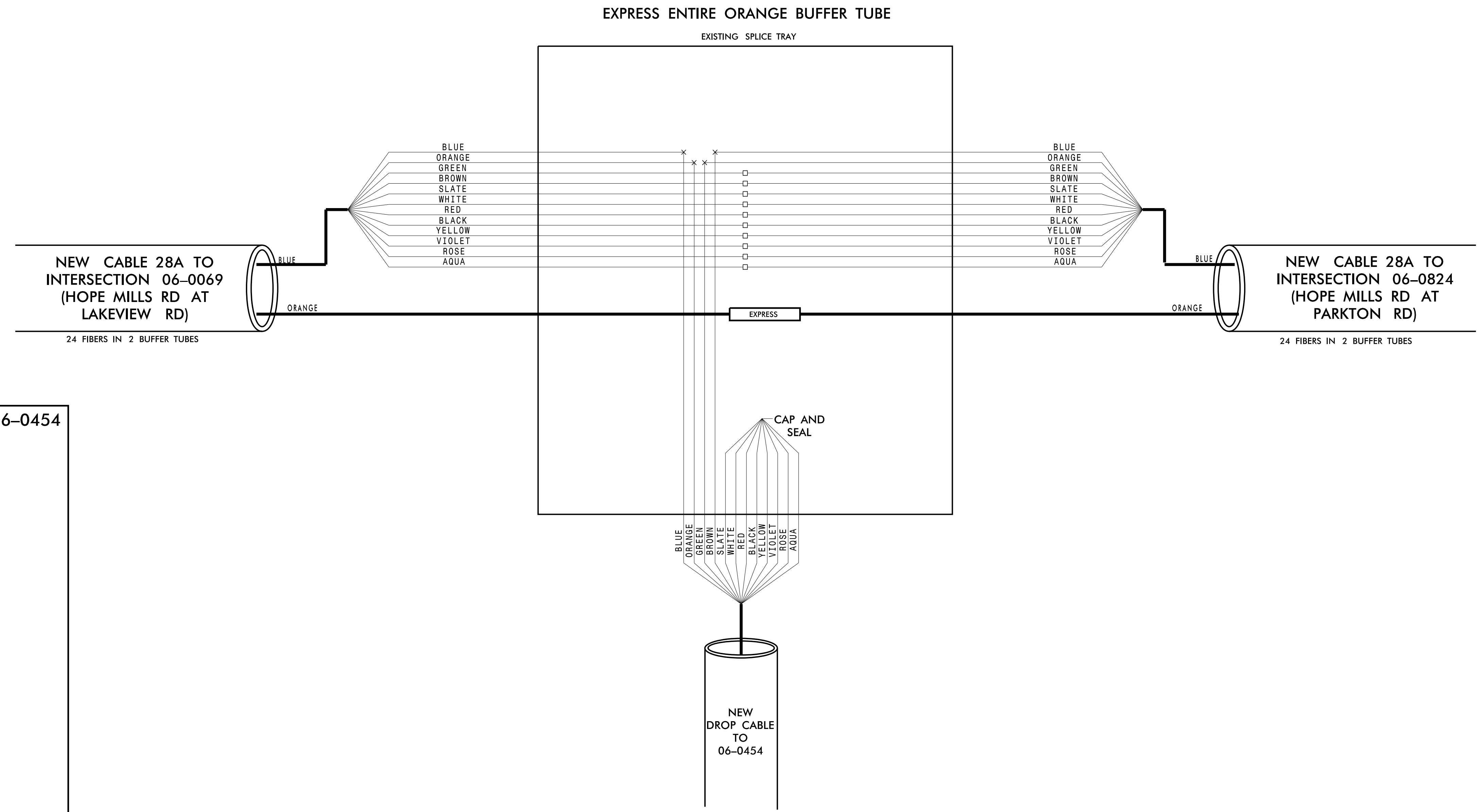

**CHANNEL 28 NEW**

**FAYETTEVILLE COMPUTERIZED SIGNAL SYSTEM**

**SPLICE DETAIL**

DIVISION 06 CUMBERLAND COUNTY

PLAN DATE: NOVEMBER 2016 REVIEWED BY: N. M. MENGELKOCH

PREPARED BY: KHA REVIEWED BY: K. W. SMITH

| REVISIONS | INIT. | DATE |
|-----------|-------|------|
|           |       |      |

SCALE: 0

Kimley»Horn  
 NC License #F-0102  
 421 Fayetteville St., Suite 600  
 Raleigh, NC 27636  
 Tel: (919) 677-2000  
 Fax: (919) 677-2050

Seal: NORTH CAROLINA PROFESSIONAL ENGINEER KEVIN W. SMITH SEAL 030472

Signature: Kevin Smith DATE: 11/15/2016

11/15/2016 KARAL\_TPTD\_ITS\_01036305 - Fayetteville Sig Sys Plans\Splicing\01036305\_ITS\_psh\_251-CH28 06-0454.dgn

**CHANNEL 28 NEW  
NEW SPLICE ENCLOSURE  
(HOPE MILLS RD AT PARKTON  
RD)  
SIG ID 06-0824**

| COLOR CODE<br>TIA/EIA 598-C |             | LEGEND  |   |
|-----------------------------|-------------|---------|---|
| (1) BLUE                    | (7) RED     | X       | - FUSION SPLICE INDIVIDUAL FIBER                            |
| (2) ORANGE                  | (8) BLACK   | O       | - EXISTING SPLICE   |
| (3) GREEN                   | (9) YELLOW  | □       | - EXPRESS INDIVIDUAL FIBER                                  |
| (4) BROWN                   | (10) VIOLET | EXPRESS | EXPRESS ENTIRE BUFFER TUBE                                  |
| (5) SLATE                   | (11) ROSE   | SPLICE  | SPLICE ENTIRE BUFFER TUBE OR MAINTAIN IF EXISTING EXPRESSED |
| (6) WHITE                   | (12) AQUA   |         |   |

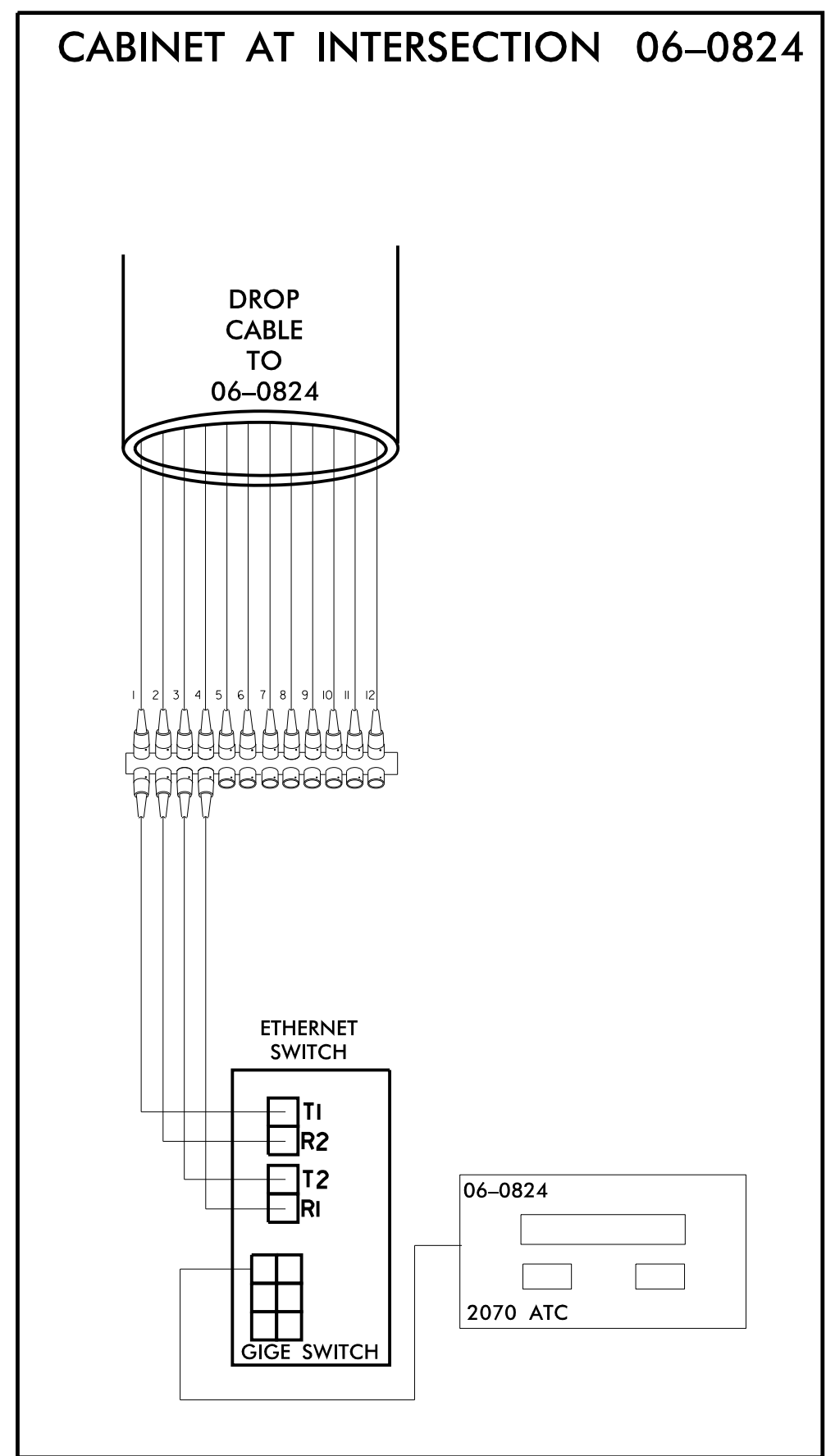
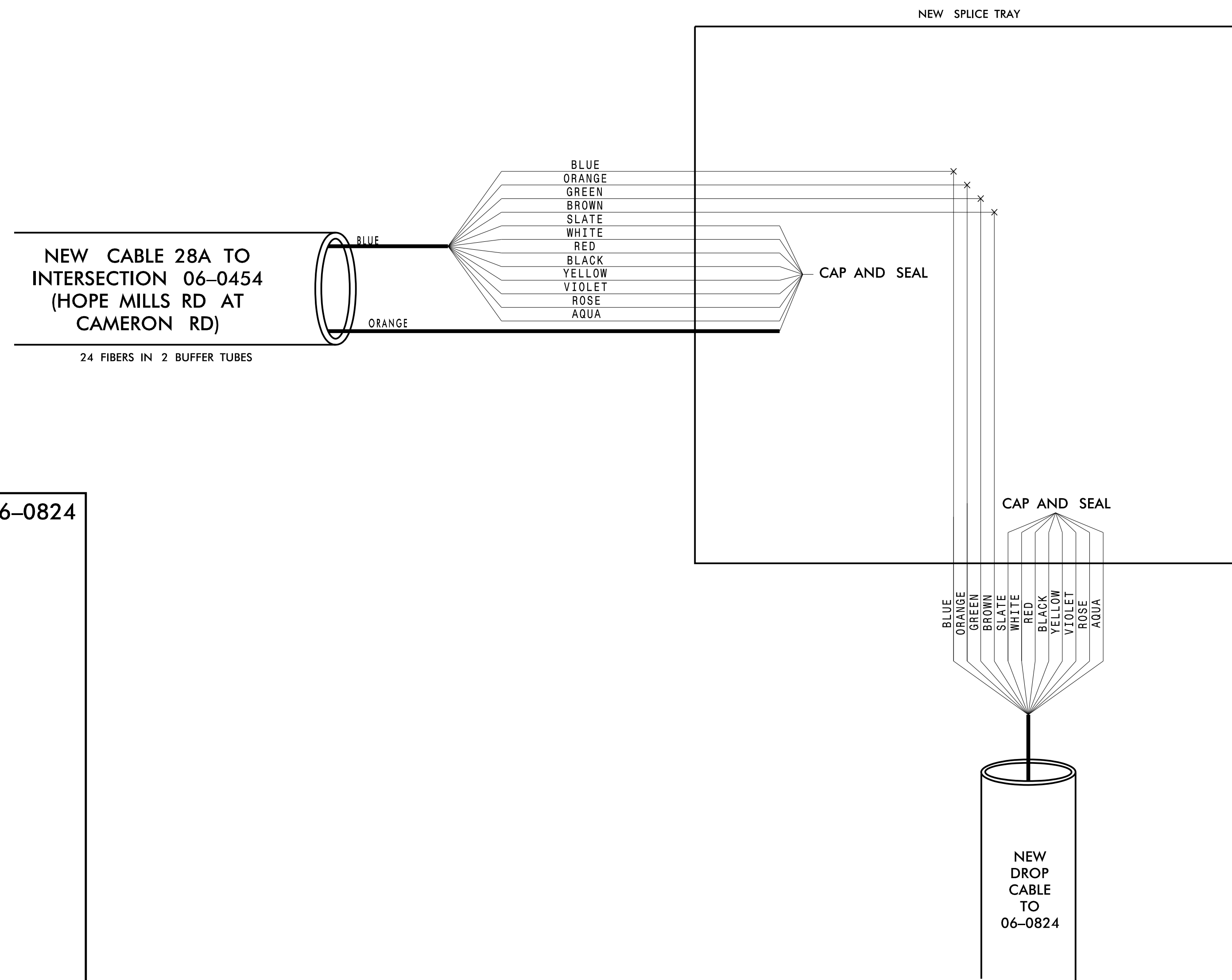

**NOTES:**  
 1. FIBER INTERCONNECT CENTER RACKS ARE SCHEMATIC ONLY - ACTUAL EQUIPMENT FORM MAY VARY.  
 2. ETHERNET SWITCH TERMINATION CONFIGURATIONS ARE GENERIC. CONTRACTOR IS RESPONSIBLE FOR DETERMINING /ENSURING PROPER TERMINATION.  
 3. CONTRACTOR IS RESPONSIBLE FOR FIELD VERIFYING EXISTING SPLICING. THE CONTRACTOR SHALL COORDINATE WITH THE ENGINEER WHERE EXISTING SPLICING IS NOT AS EXPECTED.



**CHANNEL 28 NEW**

**FAYETTEVILLE COMPUTERIZED SIGNAL SYSTEM**

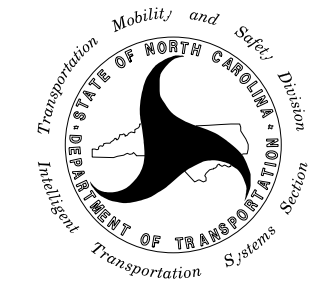
**SPLICE DETAIL**

|   |                               |   |
|---|-------------------------------|---|
|  |                               | SEAL<br> |
| DIVISION 06      CUMBERLAND COUNTY  |                               |   |
| PLAN DATE: NOVEMBER 2016  | REVIEWED BY: N. M. MENGELKOCH |   |
| PREPARED BY: KHA  | REVIEWED BY: K. W. SMITH      |   |
| REVISIONS   | INIT.                         | DATE  |
|   |                               |   |
| SCALE<br>0  |                               | 11/15/2016<br>DATE  |

CADD Filename:

**Kimley»Horn**  
 NC License #F-0102  
 421 Fayetteville St., Suite 600  
 Raleigh, NC 27636  
 Tel: (919) 677-2000  
 Fax: (919) 677-2050

11/15/2016 K:\ARL\TPTD\ITS\01036305 - Fayetteville Sig Sys\Plans\Splicing\01036305-ITS\_psh\_252-Ch28\_06-0824.dgn



**EXISTING SPLICE ENCLOSURE  
(NORTH OF ALEXANDER ST AT  
COOL SPRINGS ST)**

|                                    |             |               |   |
|------------------------------------|-------------|---------------|---|
| <b>COLOR CODE</b><br>TIA/EIA 598-C |             | <b>LEGEND</b> |   |
| (1) BLUE                           | (7) RED     | X             | - FUSION SPLICE INDIVIDUAL FIBER                            |
| (2) ORANGE                         | (8) BLACK   | O             | - EXISTING SPLICE   |
| (3) GREEN                          | (9) YELLOW  | □             | - EXPRESS INDIVIDUAL FIBER                                  |
| (4) BROWN                          | (10) VIOLET | EXPRESS       | EXPRESS ENTIRE BUFFER TUBE                                  |
| (5) SLATE                          | (11) ROSE   | SPLICE        | SPLICE ENTIRE BUFFER TUBE OR MAINTAIN IF EXISTING EXPRESSED |
| (6) WHITE                          | (12) AQUA   |               |   |

**NOTES:**

- FIBER INTERCONNECT CENTER RACKS ARE SCHEMATIC ONLY - ACTUAL EQUIPMENT FORM MAY VARY.
- ETHERNET SWITCH TERMINATION CONFIGURATIONS ARE GENERIC. CONTRACTOR IS RESPONSIBLE FOR DETERMINING /ENSURING PROPER TERMINATION.
- CONTRACTOR IS RESPONSIBLE FOR FIELD VERIFYING EXISTING SPLICING. THE CONTRACTOR SHALL COORDINATE WITH THE ENGINEER WHERE EXISTING SPLICING IS NOT AS EXPECTED.

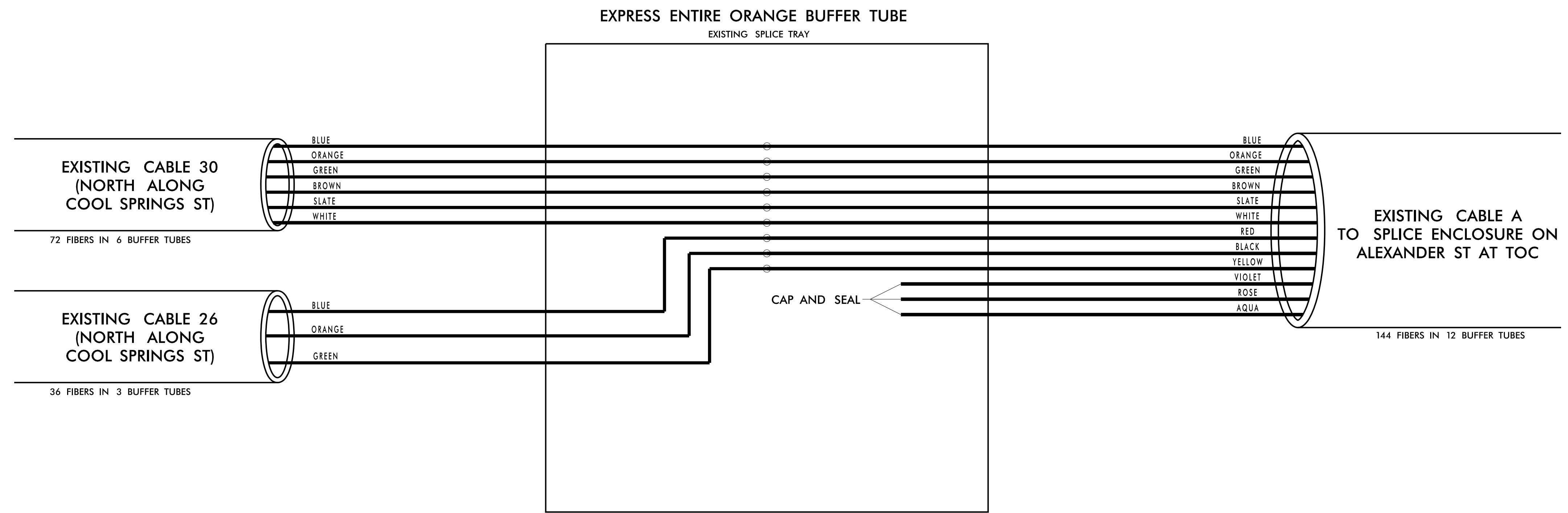

11/15/2016 K:\ARL\TPTD\_ITS\01036305 - Fayetteville Sig Sys\Plans\Splicing\01036305-ITS\_psh\_253-TOC\_Division.dgn

**Kimley»Horn**  
 NC License #F-0102  
 421 Fayetteville St., Suite 600  
 Raleigh, NC 27636  
 Tel: (919) 677-2000  
 Fax: (919) 677-2050

|                          |  |                   |            |
|--------------------------|--|-------------------|------------|
|                          | <b>FAYETTEVILLE COMPUTERIZED SIGNAL SYSTEM</b> |                   |            |
|                          | <b>SPLICE DETAIL</b>                           |                   |            |
| DIVISION 06              |  | CUMBERLAND COUNTY |            |
| PLAN DATE: NOVEMBER 2016 | REVIEWED BY: N. M. MENGELKOCH                  |                   |            |
| PREPARED BY: KHA         | REVIEWED BY: K. W. SMITH                       |                   |            |
| REVISIONS                | INIT.  | DATE              |            |
|                          |  |                   |            |
|                          |  | DATE              | 11/15/2016 |
| SIGNATURE                |  | DATE              |            |
| CADD Filename:           |  |                   |            |

**EXISTING SPLICE ENCLOSURE  
(SOUTH OF ALEXANDER ST AT  
COOL SPRINGS ST)**

**COLOR CODE**  
TIA/EIA 598-C

|            |             |
|------------|-------------|
| (1) BLUE   | (7) RED     |
| (2) ORANGE | (8) BLACK   |
| (3) GREEN  | (9) YELLOW  |
| (4) BROWN  | (10) VIOLET |
| (5) SLATE  | (11) ROSE   |
| (6) WHITE  | (12) AQUA   |

**LEGEND**

X - FUSION SPLICE INDIVIDUAL FIBER  
 O - EXISTING SPLICE  
 □ - EXPRESS INDIVIDUAL FIBER

EXPRESS - EXPRESS ENTIRE BUFFER TUBE  
 SPLICE - SPLICE ENTIRE BUFFER TUBE OR MAINTAIN IF EXISTING EXPRESSED

**NOTES:**  
 1. FIBER INTERCONNECT CENTER RACKS ARE SCHEMATIC ONLY - ACTUAL EQUIPMENT FORM MAY VARY.  
 2. ETHERNET SWITCH TERMINATION CONFIGURATIONS ARE GENERIC. CONTRACTOR IS RESPONSIBLE FOR DETERMINING /ENSURING PROPER TERMINATION.  
 3. CONTRACTOR IS RESPONSIBLE FOR FIELD VERIFYING EXISTING SPLICING. THE CONTRACTOR SHALL COORDINATE WITH THE ENGINEER WHERE EXISTING SPLICING IS NOT AS EXPECTED.

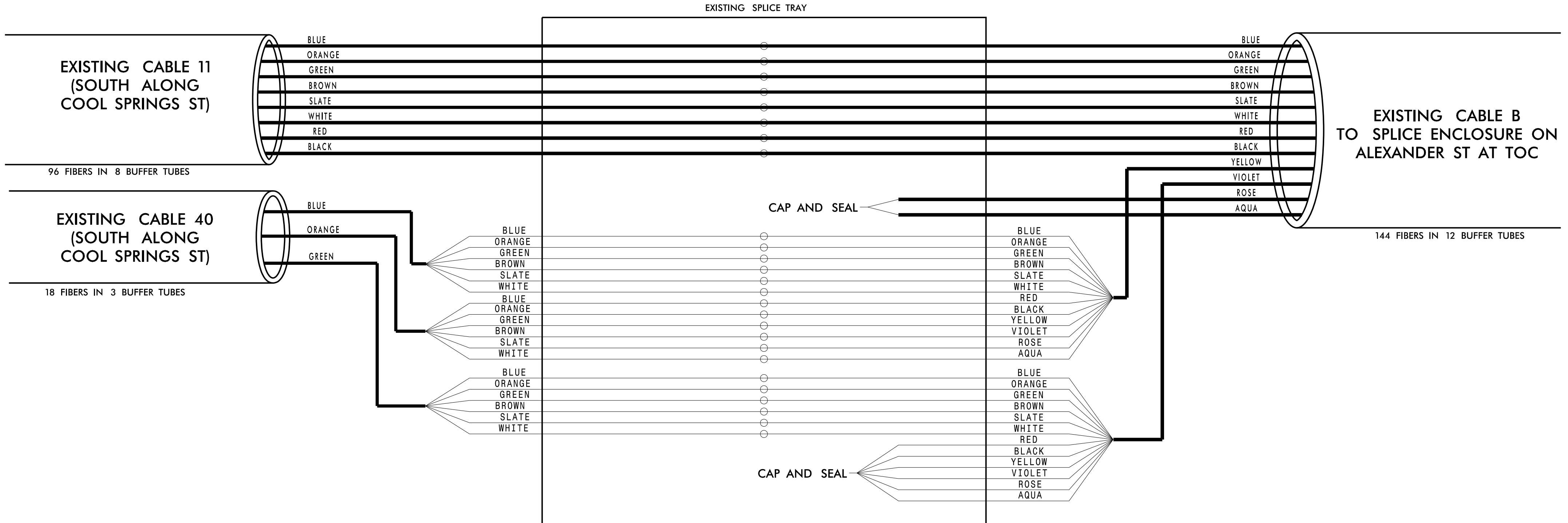

11/15/2016 KARAL\_TPTD\_ITS\_01036305 - Fayetteville Sig Sys Plans\Splicing\01036305-ITS\_psh-254-TMC.dgn

**Kimley»Horn**  
 NC License #F-0102  
 421 Fayetteville St., Suite 600  
 Raleigh, NC 27636  
 Tel: (919) 677-2000  
 Fax: (919) 677-2050

|                          |  |                   |                  |
|--------------------------|--|-------------------|------------------|
|                          | <b>FAYETTEVILLE COMPUTERIZED SIGNAL SYSTEM</b> |                   |                  |
|                          | <b>SPLICE DETAIL</b>                           |                   |                  |
| DIVISION 06              |  | CUMBERLAND COUNTY |                  |
| PLAN DATE: NOVEMBER 2016 | REVIEWED BY: N. M. MENGELKOCH                  |                   | SEAL             |
| PREPARED BY: KHA         | REVIEWED BY: K. W. SMITH                       |                   | DATE: 11/15/2016 |
| REVISIONS                | INIT.  | DATE              | SIGNATURE        |
|                          |  |                   |                  |
| CADD Filename: _____     |  |                   |                  |

**NEW SPLICE ENCLOSURE  
IN EXISTING CABINET ON  
ALEXANDER ST**

**COLOR CODE**  
TIA/EIA 598-C

|            |             |
|------------|-------------|
| (1) BLUE   | (7) RED     |
| (2) ORANGE | (8) BLACK   |
| (3) GREEN  | (9) YELLOW  |
| (4) BROWN  | (10) VIOLET |
| (5) SLATE  | (11) ROSE   |
| (6) WHITE  | (12) AQUA   |

**LEGEND**

X - FUSION SPLICE INDIVIDUAL FIBER  
 O - EXISTING SPLICE  
 □ - EXPRESS INDIVIDUAL FIBER

EXPRESS - EXPRESS ENTIRE BUFFER TUBE  
 SPLICE - SPLICE ENTIRE BUFFER TUBE OR MAINTAIN IF EXISTING EXPRESSED

**NOTES:**  
 1. FIBER INTERCONNECT CENTER RACKS ARE SCHEMATIC ONLY - ACTUAL EQUIPMENT FORM MAY VARY.  
 2. ETHERNET SWITCH TERMINATION CONFIGURATIONS ARE GENERIC. CONTRACTOR IS RESPONSIBLE FOR DETERMINING /ENSURING PROPER TERMINATION.  
 3. CONTRACTOR IS RESPONSIBLE FOR FIELD VERIFYING EXISTING SPLICING. THE CONTRACTOR SHALL COORDINATE WITH THE ENGINEER WHERE EXISTING SPLICING IS NOT AS EXPECTED.

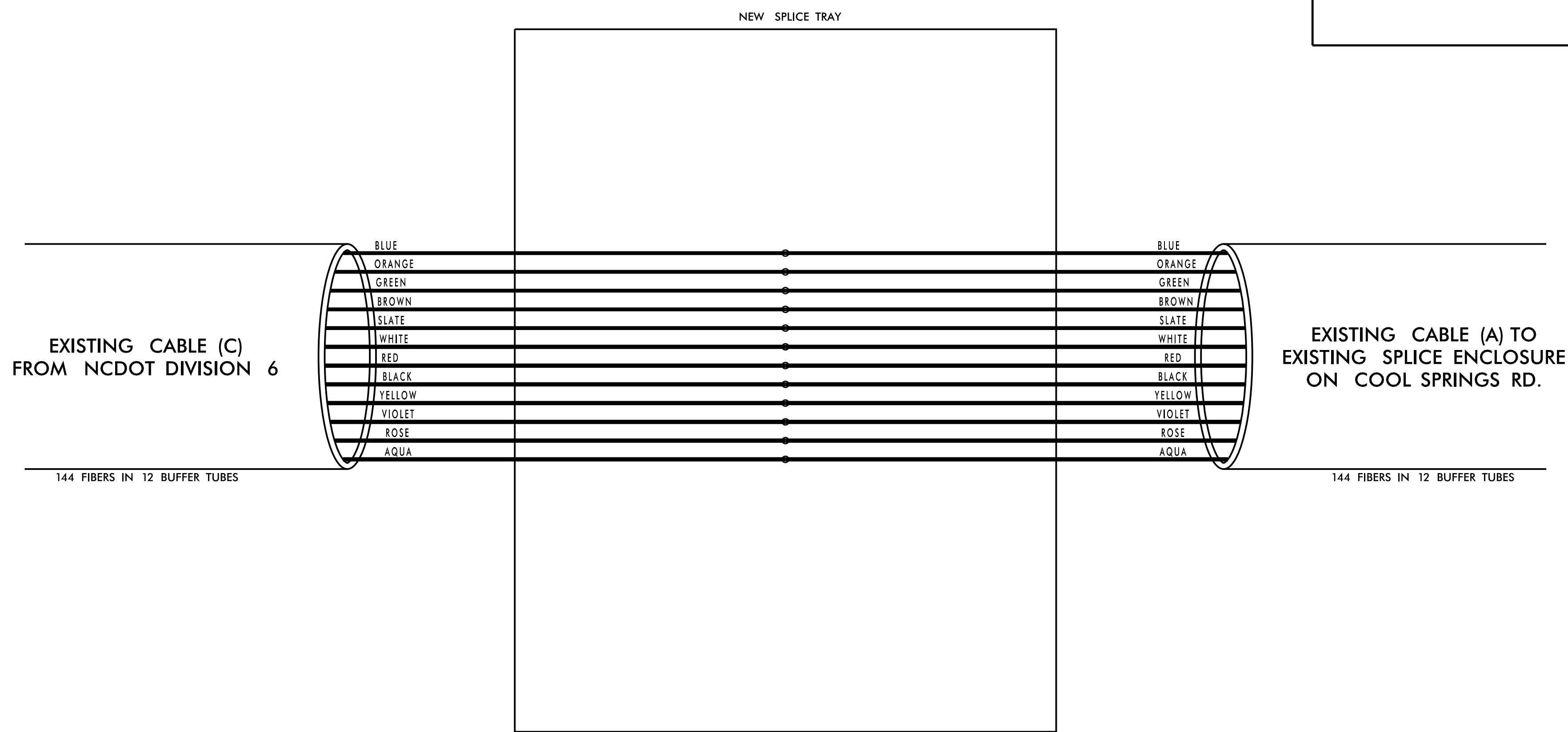

11/15/2016 K:\ARL\TPTD\ITS\01036305 - Fayetteville Sig Sys\Plans\Splicing\01036305-ITS\_psh\_255-Alex.dgn

**Kimley»Horn**  
 NC License #F-0102  
 421 Fayetteville St., Suite 600  
 Raleigh, NC 27636  
 Tel: (919) 677-2000  
 Fax: (919) 677-2050

|                          |  |            |                    |
|--------------------------|--|------------|--------------------|
|                          | <b>FAYETTEVILLE COMPUTERIZED<br/>SIGNAL SYSTEM</b><br><b>SPLICE DETAIL</b> |            | <b>SEAL</b><br>    |
|                          | DIVISION 06 CUMBERLAND COUNTY  |            |                    |
| PLAN DATE: NOVEMBER 2016 | REVIEWED BY: N. M. MENGELKOCH  |            | DocuSigned by:<br> |
| PREPARED BY: KHA         | REVIEWED BY: K. W. SMITH   |            |                    |
| SCALE<br>                | REVISIONS  | INIT. DATE | DATE<br>11/15/2016 |
| SIGNATURE                |  |            | DATE               |
| CADD Filename:           |  |            |                    |

**NEW SPLICE ENCLOSURE  
IN EXISTING CABINET ON  
ALEXANDER ST**

**COLOR CODE**  
TIA/EIA 598-C

|            |             |
|------------|-------------|
| (1) BLUE   | (7) RED     |
| (2) ORANGE | (8) BLACK   |
| (3) GREEN  | (9) YELLOW  |
| (4) BROWN  | (10) VIOLET |
| (5) SLATE  | (11) ROSE   |
| (6) WHITE  | (12) AQUA   |

**LEGEND**

X - FUSION SPLICE INDIVIDUAL FIBER  
 O - EXISTING SPLICE  
 □ - EXPRESS INDIVIDUAL FIBER

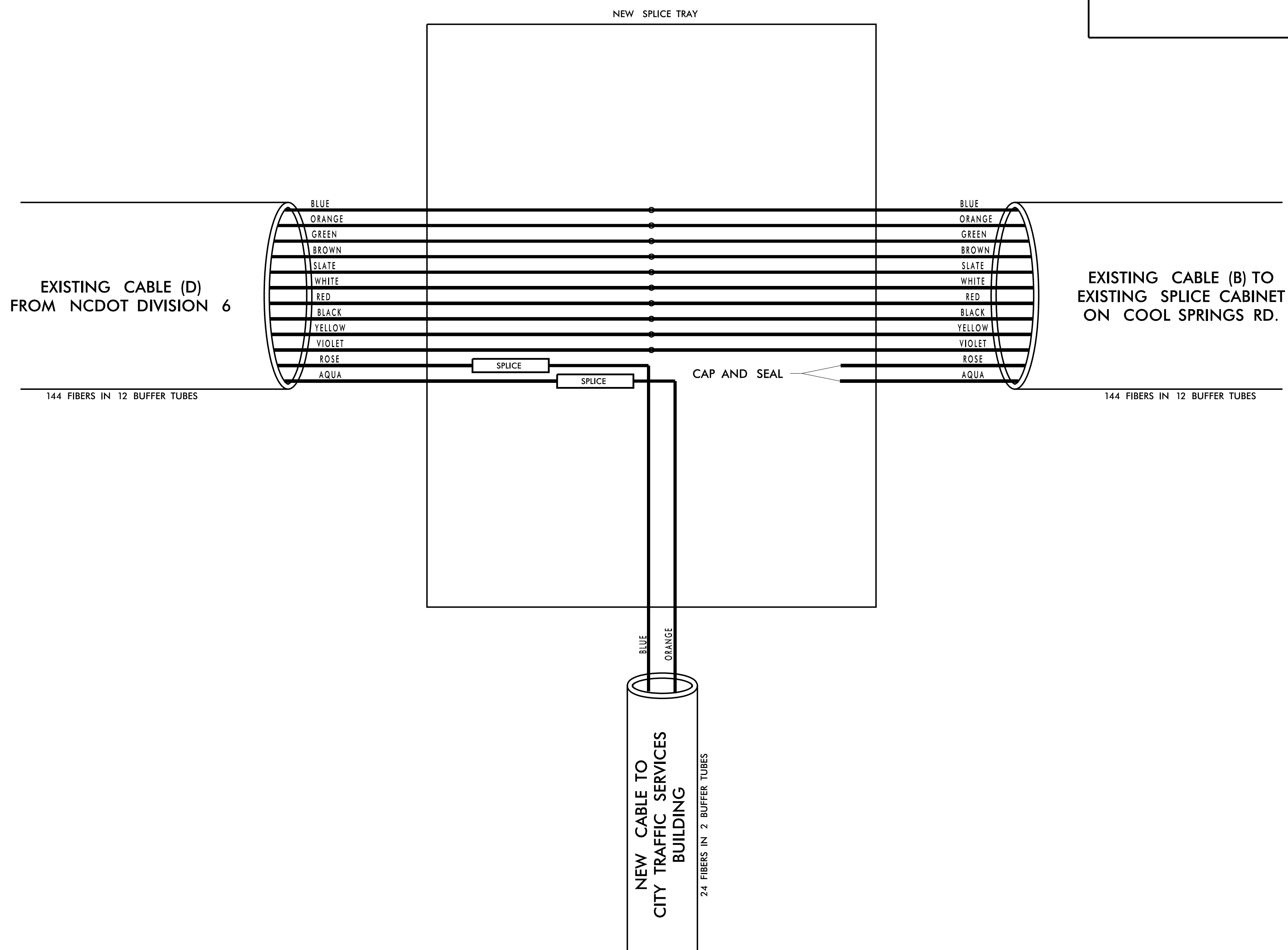

EXPRESS - EXPRESS ENTIRE BUFFER TUBE  
 SPLICE - SPLICE ENTIRE BUFFER TUBE OR MAINTAIN IF EXISTING EXPRESSED

**NOTES:**  
 1. FIBER INTERCONNECT CENTER RACKS ARE SCHEMATIC ONLY - ACTUAL EQUIPMENT FORM MAY VARY.  
 2. ETHERNET SWITCH TERMINATION CONFIGURATIONS ARE GENERIC. CONTRACTOR IS RESPONSIBLE FOR DETERMINING /ENSURING PROPER TERMINATION.  
 3. CONTRACTOR IS RESPONSIBLE FOR FIELD VERIFYING EXISTING SPLICING. THE CONTRACTOR SHALL COORDINATE WITH THE ENGINEER WHERE EXISTING SPLICING IS NOT AS EXPECTED.

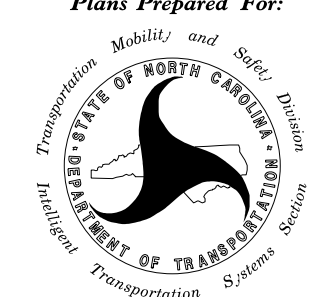
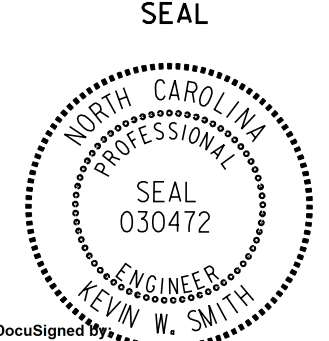

11/15/2016 K:\ARL\TPTD\ITS\01036305 - Fayetteville Sig Sys\Plans\Splicing\01036305-ITS\_psh\_256-Alex.dgn

**Kimley»Horn**  
 NC License #F-0102  
 421 Fayetteville St., Suite 600  
 Raleigh, NC 27636  
 Tel: (919) 677-2000  
 Fax: (919) 677-2050

|   |   |      |   |
|---|---|------|---|
|  | <b>FAYETTEVILLE COMPUTERIZED<br/>SIGNAL SYSTEM</b><br><b>SPLICE DETAIL</b>            |      | SEAL<br>           |
|   | DIVISION 06 CUMBERLAND COUNTY   |      |   |
| PLAN DATE: NOVEMBER 2016  | REVIEWED BY: N. M. MENGELKOCH   |      | DocuSigned by:<br> |
| PREPARED BY: KHA  | REVIEWED BY: K. W. SMITH  |      |   |
| REVISIONS   | INIT.   | DATE | SIGNATURE DATE  |
| 0   |  |      | 11/15/2016  |

NCDOT DIVISION 6 BUILDING  
CITY OF FAYETTEVILLE  
RACK 2 – PATCH PANELS

**COLOR CODE**  
TIA/EIA 598-C

|            |             |
|------------|-------------|
| (1) BLUE   | (7) RED     |
| (2) ORANGE | (8) BLACK   |
| (3) GREEN  | (9) YELLOW  |
| (4) BROWN  | (10) VIOLET |
| (5) SLATE  | (11) ROSE   |
| (6) WHITE  | (12) AQUA   |

**LEGEND**

X – FUSION SPLICE INDIVIDUAL FIBER  
 O – EXISTING SPLICE  
 □ – EXPRESS INDIVIDUAL FIBER

EXPRESS – EXPRESS ENTIRE BUFFER TUBE  
 SPLICE – SPLICE ENTIRE BUFFER TUBE OR MAINTAIN IF EXISTING EXPRESSED

**NOTES:**  
 1. FIBER INTERCONNECT CENTER RACKS ARE SCHEMATIC ONLY – ACTUAL EQUIPMENT FORM MAY VARY.  
 2. ETHERNET SWITCH TERMINATION CONFIGURATIONS ARE GENERIC. CONTRACTOR IS RESPONSIBLE FOR DETERMINING /ENSURING PROPER TERMINATION.  
 3. CONTRACTOR IS RESPONSIBLE FOR FIELD VERIFYING EXISTING SPLICING. THE CONTRACTOR SHALL COORDINATE WITH THE ENGINEER WHERE EXISTING SPLICING IS NOT AS EXPECTED.

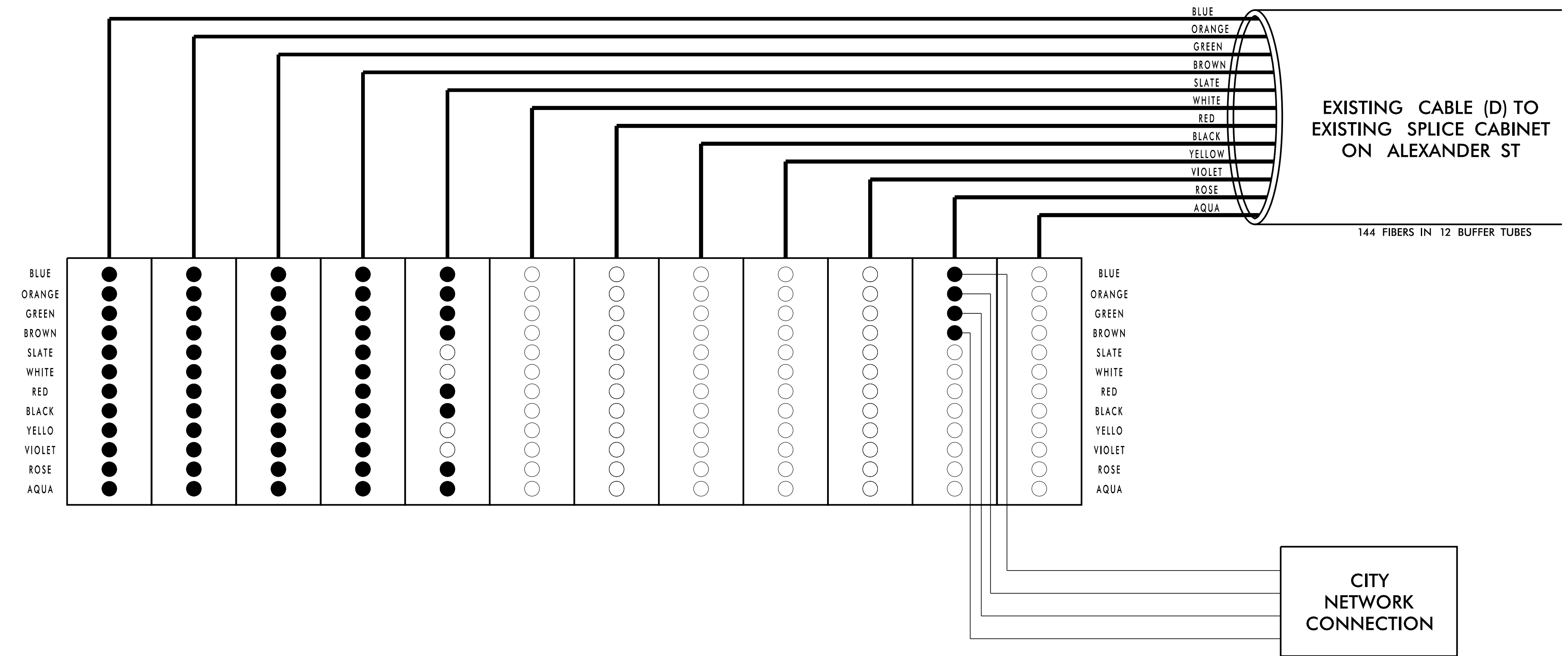
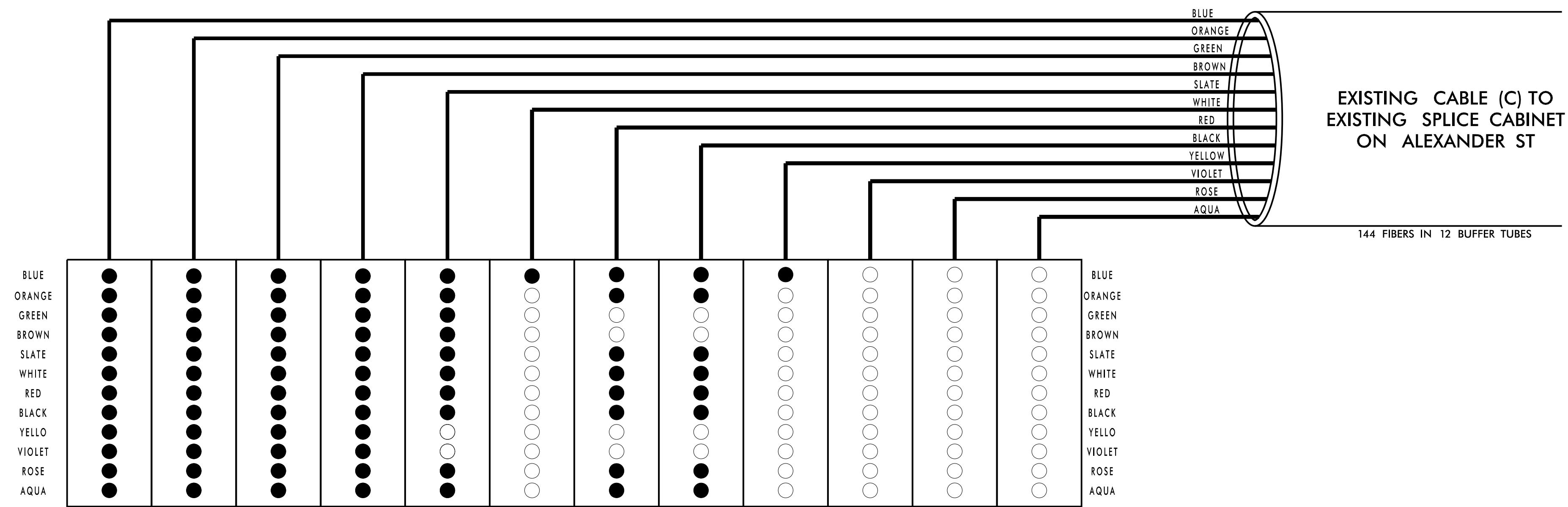

11/15/2016 K:\ARL\TPTD\ITS\01036305 - Fayetteville Sig Sys\Plans\Splicing\01036305-ITS\_psh-257-TMC.dgn

**Kimley»Horn**  
 NC License #F-0102  
 421 Fayetteville St., Suite 600  
 Raleigh, NC 27636  
 Tel: (919) 677-2000  
 Fax: (919) 677-2050

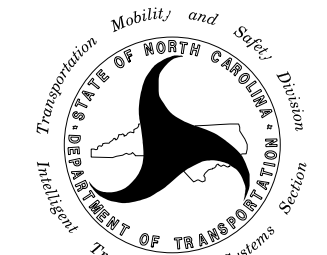
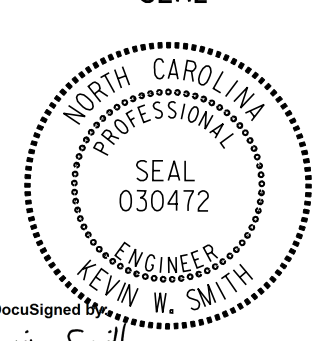
|   |  |                         |  |
|---|--|-------------------------|--|
| <br>Plans Prepared For:<br>NORTH CAROLINA<br>DEPARTMENT OF TRANSPORTATION<br>Transportation Systems Division | <b>FAYETTEVILLE COMPUTERIZED SIGNAL SYSTEM</b><br><b>SPLICE DETAIL</b>   |                         | SEAL<br><br>KEVIN W. SMITH<br>ENGINEER<br>SEAL 030472 |
|   | DIVISION 06 CUMBERLAND COUNTY<br>PLAN DATE: NOVEMBER 2016 REVIEWED BY: N. M. MENGELKOCH<br>PREPARED BY: KHA REVIEWED BY: K. W. SMITH |                         |  |
| SCALE<br>0  |  | REVISIONS<br>INIT. DATE | SIGNATURE<br>DATE<br>11/15/2016<br>CADD File name:   |

**NCDOT DIVISION 6 BUILDING  
CITY OF FAYETTEVILLE  
RACK 2 - PATCH PANEL  
ASSIGNMENT TABLES**

**COLOR CODE**  
TIA/EIA 598-C

|            |             |
|------------|-------------|
| (1) BLUE   | (7) RED     |
| (2) ORANGE | (8) BLACK   |
| (3) GREEN  | (9) YELLOW  |
| (4) BROWN  | (10) VIOLET |
| (5) SLATE  | (11) ROSE   |
| (6) WHITE  | (12) AQUA   |

**LEGEND**

X - FUSION SPLICE INDIVIDUAL FIBER  
 O - EXISTING SPLICE  
 □ - EXPRESS INDIVIDUAL FIBER

EXPRESS - EXPRESS ENTIRE BUFFER TUBE  
 SPLICE - SPLICE ENTIRE BUFFER TUBE OR MAINTAIN IF EXISTING EXPRESSED

**NOTES:**

- FIBER INTERCONNECT CENTER RACKS ARE SCHEMATIC ONLY - ACTUAL EQUIPMENT FORM MAY VARY.
- ETHERNET SWITCH TERMINATION CONFIGURATIONS ARE GENERIC. CONTRACTOR IS RESPONSIBLE FOR DETERMINING /ENSURING PROPER TERMINATION.
- CONTRACTOR IS RESPONSIBLE FOR FIELD VERIFYING EXISTING SPlicing. THE CONTRACTOR SHALL COORDINATE WITH THE ENGINEER WHERE EXISTING SPlicing IS NOT AS EXPECTED.

**NCDOT DIVISION 6 BUILDING - CITY OF FAYETTEVILLE: RACK 2 PATCH PANEL ASSIGNMENTS**

**Existing Cable C**  
To Existing Splice Cabinet at Alexander St and Alexander St

| BUFFER      | FIBER | DESC | BUFFER        | FIBER | DESC | BUFFER       | FIBER | DESC | BUFFER       | FIBER | DESC       | BUFFER       | FIBER | DESC       | BUFFER       | FIBER | DESC  | BUFFER     | FIBER | DESC | BUFFER       | FIBER | DESC    | BUFFER        | FIBER   | DESC  | BUFFER        | FIBER | DESC   | BUFFER      | FIBER | DESC    | BUFFER      | FIBER | DESC    |    |         |
|-------------|-------|------|---------------|-------|------|--------------|-------|------|--------------|-------|------------|--------------|-------|------------|--------------|-------|-------|------------|-------|------|--------------|-------|---------|---------------|---------|-------|---------------|-------|--------|-------------|-------|---------|-------------|-------|---------|----|---------|
| <b>BLUE</b> | BL    | 16P  | <b>ORANGE</b> | BL    | 18P  | <b>GREEN</b> | BL    | 21P  | <b>BROWN</b> | BL    | NCDOT-2    | <b>SLATE</b> | BL    | 14P        | <b>WHITE</b> | BL    | CCTV8 | <b>RED</b> | BL    | 4P   | <b>BLACK</b> | BL    | 9P      | <b>YELLOW</b> | BL      | CCTV9 | <b>VIOLET</b> | BL    | SPARE1 | <b>ROSE</b> | BL    | SPARE13 | <b>AQUA</b> | BL    | SPARE25 |    |         |
|             | O     | 16S  |               | O     | 18S  |              | O     | 21S  |              | O     | NCDOT-2    |              | O     | 14S        |              | O     | S7    |            | O     | 4S   |              | O     | 9S      |               | O       | CCTV9 |               | O     | SPARE2 |             | O     | SPARE14 |             | O     | SPARE26 |    |         |
|             | G     | 1P   |               | G     | 19P  |              | G     | 22P  |              | G     | CCTV10     |              | G     | NCDOT-1    |              | G     | S8    |            | G     | S1   |              | G     | S5      |               | G       | S10   |               | G     | SPARE3 |             | G     | SPARE15 |             | G     | SPARE27 |    |         |
|             | BR    | 1S   |               | BR    | 19S  |              | BR    | 22S  |              | BR    | CCTV19     |              | BR    | NCDOT-1    |              | BR    | S9    |            | BR    | S2   |              | BR    | S6      |               | BR      | S11   |               | BR    | SPARE4 |             | BR    | SPARE16 |             | BR    | SPARE28 |    |         |
|             | S     | 3P   |               | S     | 20P  |              | S     | 13P  |              | S     | Ft Bragg-1 |              | S     | Ft Bragg-1 |              | S     | S10   |            | S     | 4S   |              | S     | 9S      |               | S       | S12   |               | S     | S12    |             | S     | SPARE5  |             | S     | SPARE17 | S  | SPARE29 |
|             | W     | 3S   |               | W     | 20S  |              | W     | 13S  |              | W     | Ft Bragg-1 |              | W     | 14P        |              | W     | S11   |            | W     | 4P   |              | W     | 9P      |               | W       | S13   |               | W     | S13    |             | W     | SPARE6  |             | W     | SPARE18 | W  | SPARE30 |
|             | R     | 24P  |               | R     | 2P   |              | R     | 11P  |              | R     | 15P        |              | R     | 8P         |              | R     | S12   |            | R     | 5P   |              | R     | 10P     |               | R       | S14   |               | R     | S14    |             | R     | SPARE7  |             | R     | SPARE19 | R  | SPARE31 |
|             | BK    | 24S  |               | BK    | 2S   |              | BK    | 11S  |              | BK    | 15S        |              | BK    | 8S         |              | BK    | S13   |            | BK    | 5S   |              | BK    | 10S     |               | BK      | S15   |               | BK    | S15    |             | BK    | SPARE8  |             | BK    | SPARE20 | BK | SPARE32 |
|             | Y     | 25P  |               | Y     | 17P  |              | Y     | 12P  |              | Y     | S1         |              | Y     | S5         |              | Y     | S3    |            | Y     | S7   |              | Y     | S7      |               | Y       | S16   |               | Y     | S16    |             | Y     | SPARE9  |             | Y     | SPARE21 | Y  | SPARE33 |
|             | V     | 25S  |               | V     | 17S  |              | V     | 12S  |              | V     | S2         |              | V     | S6         |              | V     | S4    |            | V     | S8   |              | V     | S8      |               | V       | S17   |               | V     | S17    |             | V     | SPARE10 |             | V     | SPARE22 | V  | SPARE34 |
| RS          | 26P   | RS   | 23P           | RS    | 6P   | RS           | 15S   | RS   | 8S           | RS    | S16        | RS           | 5S    | RS         | 10S          | RS    | S18   | RS         | S18   | RS   | SPARE11      | RS    | SPARE23 | RS            | SPARE35 |       |               |       |        |             |       |         |             |       |         |    |         |
| A           | 26S   | A    | 23S           | A     | 6S   | A            | 15P   | A    | 8P           | A     | S17        | A            | 5P    | A          | 10P          | A     | S19   | A          | S19   | A    | SPARE12      | A     | SPARE24 | A             | SPARE36 |       |               |       |        |             |       |         |             |       |         |    |         |

**Existing Cable D**  
To Existing Splice Cabinet at Alexander St and Alexander St

| BUFFER      | FIBER | DESC | BUFFER        | FIBER | DESC | BUFFER       | FIBER  | DESC | BUFFER       | FIBER | DESC    | BUFFER       | FIBER | DESC    | BUFFER       | FIBER | DESC    | BUFFER     | FIBER   | DESC | BUFFER       | FIBER | DESC    | BUFFER        | FIBER | DESC    | BUFFER        | FIBER | DESC    | BUFFER      | FIBER | DESC      | BUFFER      | FIBER | DESC    |
|-------------|-------|------|---------------|-------|------|--------------|--------|------|--------------|-------|---------|--------------|-------|---------|--------------|-------|---------|------------|---------|------|--------------|-------|---------|---------------|-------|---------|---------------|-------|---------|-------------|-------|-----------|-------------|-------|---------|
| <b>BLUE</b> | BL    | 16P  | <b>ORANGE</b> | BL    | 18P  | <b>GREEN</b> | BL     | 21P  | <b>BROWN</b> | BL    | NCDOT-3 | <b>SLATE</b> | BL    | CCTV-7  | <b>WHITE</b> | BL    | S5      | <b>RED</b> | BL      | S17  | <b>BLACK</b> | BL    | S29     | <b>YELLOW</b> | BL    | SPARE1  | <b>VIOLET</b> | BL    | SPARE13 | <b>ROSE</b> | BL    | CITY NTWK | <b>AQUA</b> | BL    | SPARE33 |
|             | O     | 16S  |               | O     | 18S  |              | O      | 21S  |              | O     | NCDOT-3 |              | O     | CCTV-18 |              | O     | S6      |            | O       | S18  |              | O     | S30     |               | O     | SPARE2  |               | O     | SPARE14 |             | O     | CITY NTWK |             | O     | SPARE34 |
|             | G     | 1P   |               | G     | 19P  |              | G      | 22P  |              | G     | FCCTV14 |              | G     | CMS-1S  |              | G     | S7      |            | G       | S19  |              | G     | S31     |               | G     | SPARE3  |               | G     | SPARE15 |             | G     | CITY NTWK |             | G     | SPARE35 |
|             | BR    | 1S   |               | BR    | 19S  |              | BR     | 22S  |              | BR    | FCCTV15 |              | BR    | CMS-1R  |              | BR    | S8      |            | BR      | S20  |              | BR    | S32     |               | BR    | SPARE4  |               | BR    | SPARE16 |             | BR    | CITY NTWK |             | BR    | SPARE36 |
|             | S     | 3P   |               | S     | 20P  |              | S      | 13P  |              | S     | FCCTV16 |              | S     | S1      |              | S     | S9      |            | S       | S21  |              | S     | S33     |               | S     | SPARE5  |               | S     | SPARE17 |             | S     | SPARE25   |             | S     | SPARE37 |
|             | W     | 3S   |               | W     | 20S  |              | W      | 13S  |              | W     | CCTV-11 |              | W     | S2      |              | W     | S10     |            | W       | S22  |              | W     | S34     |               | W     | SPARE6  |               | W     | SPARE18 |             | W     | SPARE26   |             | W     | SPARE38 |
|             | R     | 24P  |               | R     | 2P   |              | R      | 11P  |              | R     | CCTV-12 |              | R     | 7P      |              | R     | S11     |            | R       | S23  |              | R     | S35     |               | R     | SPARE7  |               | R     | SPARE19 |             | R     | SPARE27   |             | R     | SPARE39 |
|             | BK    | 24S  |               | BK    | 2S   |              | BK     | 11S  |              | BK    | CCTV-20 |              | BK    | 7S      |              | BK    | S12     |            | BK      | S24  |              | BK    | S36     |               | BK    | SPARE8  |               | BK    | SPARE20 |             | BK    | SPARE28   |             | BK    | SPARE40 |
|             | Y     | 25P  |               | Y     | 17P  |              | Y      | 12P  |              | Y     | CCTV-3  |              | Y     | S3      |              | Y     | S13     |            | Y       | S25  |              | Y     | S37     |               | Y     | SPARE9  |               | Y     | SPARE21 |             | Y     | SPARE29   |             | Y     | SPARE41 |
|             | V     | 25S  |               | V     | 17S  |              | V      | 12S  |              | V     | CCTV-1  |              | V     | S4      |              | V     | S14     |            | V       | S26  |              | V     | S38     |               | V     | SPARE10 |               | V     | SPARE22 |             | V     | SPARE30   |             | V     | SPARE42 |
| RS          | 26P   | RS   | 23P           | RS    | 6P   | RS           | CCTV-5 | RS   | 7S           | RS    | S15     | RS           | S27   | RS      | S39          | RS    | SPARE11 | RS         | SPARE23 | RS   | SPARE31      | RS    | SPARE43 |               |       |         |               |       |         |             |       |           |             |       |         |
| A           | 26S   | A    | 23S           | A     | 6S   | A            | CCTV-6 | A    | 7P           | A     | S16     | A            | S28   | A       | S40          | A     | SPARE12 | A          | SPARE24 | A    | SPARE32      | A     | SPARE44 |               |       |         |               |       |         |             |       |           |             |       |         |

11/15/2016 K:\ARL\TPTD\_ITS\01036305 - Fayetteville Sig Sys\Plans\Splicing\01036305\_ITS\_psn\_258-TOC.dgn

**Kimley Horn**  
 NC License #F-0102  
 421 Fayetteville St., Suite 600  
 Raleigh, NC 27636  
 Tel: (919) 677-2000  
 Fax: (919) 677-2050

**FAYETTEVILLE COMPUTERIZED  
SIGNAL SYSTEM  
SPLICE DETAIL**

DIVISION 06 CUMBERLAND COUNTY  
 PLAN DATE: NOVEMBER 2016 REVIEWED BY: N. M. MENGELKOPF  
 PREPARED BY: KHA REVIEWED BY: K. W. SMITH

SEAL  
 NORTH CAROLINA PROFESSIONAL ENGINEER  
 SEAL 030472  
 K. W. SMITH  
 11/15/2016

REVISIONS: \_\_\_\_\_ INIT. DATE: \_\_\_\_\_  
 \_\_\_\_\_  
 \_\_\_\_\_

CADD Filename: \_\_\_\_\_