

**This electronic collection of documents is provided
for the convenience of the user
and is Not a Certified Document –**

**The documents contained herein were originally issued
and sealed by the individuals whose names and license
numbers appear on each page, on the dates appearing
with their signature on that page.**

**This file or an individual page
shall not be considered a certified document.**

PROJECT REFERENCE NO. R-5023B	SHEET NO. PMP-1
APPROVED: <i>Rhonda B. Early</i> <small>DocuSigned by: Rhonda B. Early F34CAF5AC8BF48A</small>	
DATE: 9/29/2016	
SEAL 	
DOCUMENT NOT CONSIDERED FINAL UNLESS ALL SIGNATURES COMPLETED	

**STATE OF NORTH CAROLINA
DEPARTMENT OF TRANSPORTATION**

**PAVEMENT MARKING PLAN
ON SLOW COUNTY**

**LOCATION: IMPROVEMENTS ALONG NC 53 FROM WEST OF SR 1109
(HOLLY SHELTER RD) TO WEST OF BRIDGE OVER
SOUTHWEST CREEK AND WEST OF SR 1214 (FOY -
LOCKAMY RD) TO EAST OF SR 1116 (ON SLOW PINES RD)**

T.I.P.: R-5023B

CONTRACT: DC00146

INDEX

<u>SHEET NO.</u>	<u>DESCRIPTION</u>
PMP-1	PAVEMENT MARKING PLAN TITLE, LIST OF STANDARD DRAWINGS, GENERAL NOTES AND INDEX OF SHEETS
PMP-1A	FINAL PAVEMENT MARKING SCHEDULE AND LEGEND
PMP-2 THRU PMP-8	PAVEMENT MARKING DETAILS
PMP-9	PAVEMENT MARKER DETAIL FOR CONCRETE ISLANDS

GENERAL NOTES

- THE FOLLOWING GENERAL NOTES APPLY AT ALL TIMES FOR THE DURATION OF THE CONSTRUCTION PROJECT, EXCEPT WHEN OTHERWISE NOTED IN THE PLAN, OR DIRECTED BY THE ENGINEER.
- A) INSTALL PAVEMENT MARKINGS AND PAVEMENT MARKERS ON THE FINAL SURFACE AS FOLLOWS:

<u>ROAD NAME</u>	<u>MARKING</u>	<u>MARKER</u>
ALL ROADS	THERMOPLASTIC	SNOWPLOWABLE
 - B) TIE PROPOSED PAVEMENT MARKING LINES TO EXISTING PAVEMENT MARKING LINES.
 - C) REMOVE/REPLACE ANY CONFLICTING/DAMAGED PAVEMENT MARKINGS AND MARKERS.
 - D) PASSING ZONES WILL BE DETERMINED IN THE FIELD AND MUST BE APPROVED BY THE ENGINEER.
 - E) STOP BAR LOCATION AT NON-SIGNALIZED INTERSECTIONS MAY BE ADJUSTED AS DIRECTED BY THE ENGINEER.
 - F) USE PAVEMENT MARKER DETAIL FOR CONCRETE ISLANDS AS SHOWN ON PMP-9.

ROADWAY STANDARD DRAWING

THE FOLLOWING ROADWAY STANDARDS AS APPEAR IN "ROADWAY STANDARD DRAWINGS" - PROJECT SERVICES UNIT - N.C. DEPARTMENT OF TRANSPORTATION - RALEIGH, N.C., DATED JANUARY 2012 ARE APPLICABLE TO THIS PROJECT AND BY REFERENCE HEREBY ARE CONSIDERED A PART OF THESE PLANS:

<u>STD. NO.</u>	<u>TITLE</u>
1205.01	PAVEMENT MARKINGS - LINE TYPES AND OFFSETS
1205.02	PAVEMENT MARKINGS - TWO-LANE AND MULTILANE ROADWAYS
1205.04	PAVEMENT MARKINGS - INTERSECTIONS
1205.05	PAVEMENT MARKINGS - TURN LANES
1205.08	PAVEMENT MARKINGS - SYMBOLS AND WORD MESSAGES
1205.09	PAVEMENT MARKINGS - PAINTED ISLANDS
1250.01	RAISED PAVEMENT MARKERS - INSTALLATION SPACING
1251.01	RAISED PAVEMENT MARKERS - PERMANENT & TEMPORARY
1253.01	RAISED PAVEMENT MARKERS - SNOWPLOWABLE
1261.01	GUARDRAIL AND BARRIER DELINEATORS - INSTALLATION SPACING
1261.02	GUARDRAIL AND BARRIER DELINEATORS - TYPES AND MOUNTING
1262.01	GUARDRAIL END DELINEATION

PLAN REVIEWED BY: N.C.D.O.T. SIGNING AND DELINEATION UNIT

A. I. Alqudwah, PE SIGNING & DELINEATION REGIONAL ENGINEER
B. Nowlin SIGNING & DELINEATION PROJECT DESIGN ENGINEER/TECHNICIAN

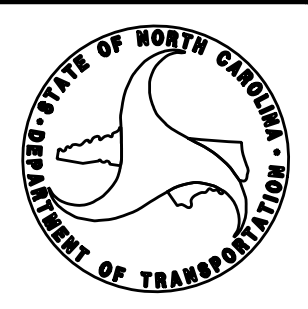

PLAN PREPARED BY: HNTB NORTH CAROLINA, P.C.

R. B. Early, PE PROJECT ENGINEER
J. Phillips PROJECT DESIGNER

TIP NO. R - 5023B	SHEET NO. PMP - 1A
APPROVED: <i>Rhonda B. Early</i> E34CAF5AC8BF4BA	
DATE: 9/29/2016	
SEAL	
	
DOCUMENT NOT CONSIDERED FINAL UNLESS ALL SIGNATURES COMPLETED	

FINAL PAVEMENT MARKING SCHEDULE

MATERIAL	SYMBOL	DESCRIPTION
PAVEMENT MARKING		
THERMOPLASTIC (4", 90 MILS)		
	TA	WHITE EDGELINE
THERMOPLASTIC (4", 120 MILS)		
	T8	2FT-6FT WHITE MINI-SKIP
	TD	3FT-9FT WHITE MINI-SKIP
	TE	4" WHITE SOLID LANE LINE
	TF	10FT YELLOW SKIP
	TH	YELLOW SINGLE CENTER
	TI	YELLOW DOUBLE CENTER
THERMOPLASTIC (12", 90 MILS)		
	TV	YELLOW DIAGONAL
THERMOPLASTIC (24", 120 MILS)		
	T2	WHITE STOP BAR
THERMOPLASTIC SYMBOL (90 MILS)		
	UA	LEFT TURN ARROW
	UC	STRAIGHT ARROW
	UE	STRAIGHT/RIGHT TURN ARROW
THERMOPLASTIC CHARACTER (120 MILS)		
	UI	ALPHANUMERIC CHARACTERS
PERMANENT RAISED PAVEMENT MARKERS		
	MA	YELLOW & YELLOW
SNOWPLOWABLE PAVEMENT MARKERS		
	ME	YELLOW & YELLOW
	MF	CRYSTAL & RED

LEGEND

- GENERAL**
- DIRECTION OF TRAFFIC FLOW
 - NORTH ARROW
 - PROPOSED PVMT. EXIST. PVMT.

PAVEMENT MARKINGS

- PAVEMENT MARKING SYMBOLS
- UA
 - UC
 - UE

4:16:50 PM 4/16/2016 P:\Projects\16033B_PMP\B01A.dgn

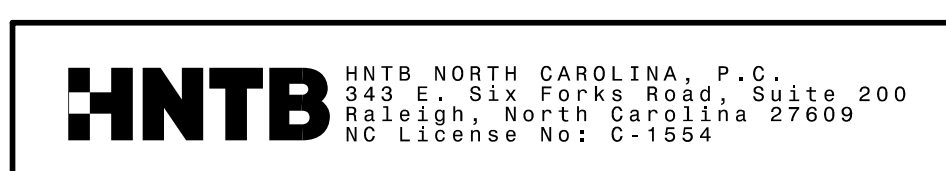

PAVEMENT MARKING DETAIL

TIP NO. R-5023B	SHEET NO. PMP-2
APPROVED: <i>Rhonda B. Early</i> DATE: 9/29/2016	
SEAL 	
DOCUMENT NOT CONSIDERED FINAL UNLESS ALL SIGNATURES COMPLETED	

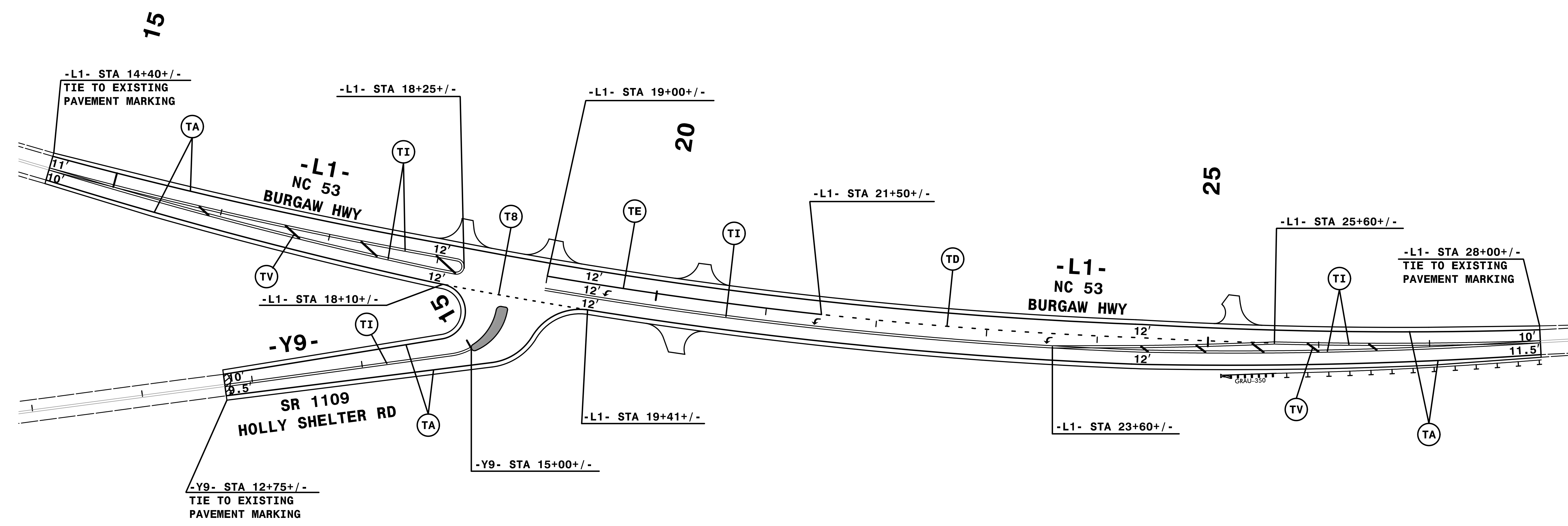

REFER TO PMP-9 FOR PLACEMENT OF PAVEMENT MARKERS FOR CONCRETE ISLANDS.

HNTB HNTB NORTH CAROLINA, P.C.
343 E. SIX FORKS ROAD, SUITE 200
RALEIGH, NORTH CAROLINA 27609
NC LICENSE NO: C-1554

PAVEMENT MARKING DETAIL

4:17:07 PM
4/16/17 PMP\R5023B_pmp_pmp02.dgn
HNTB

TIP NO. R - 5023B	SHEET NO. PMP - 3
APPROVED: <i>Rhonda B. Early</i> <small>FS4CAF5AC8BF4BA...</small>	
DATE: 9/29/2016	
SEAL 	
DOCUMENT NOT CONSIDERED FINAL UNLESS ALL SIGNATURES COMPLETED	

10

15

20

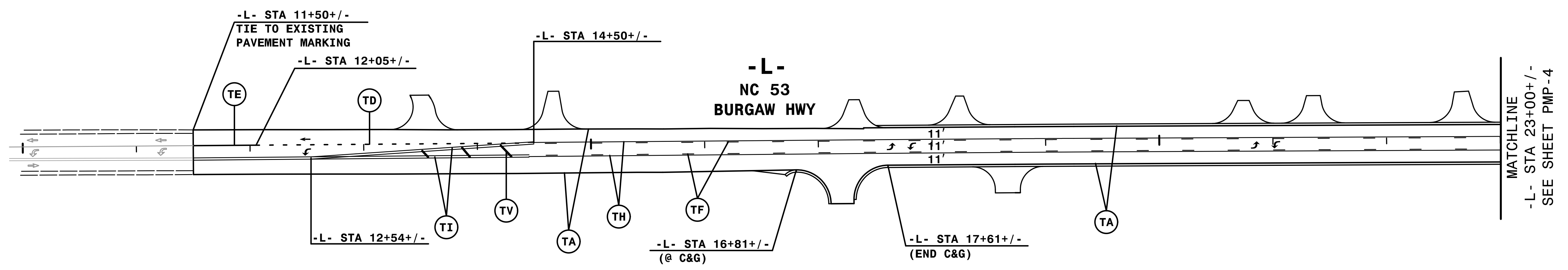

4:17:11 PM
C:\057\PM\PMP\R5023B_pmp_pmp03.dgn
HNTB

HNTB HNTB NORTH CAROLINA, P.C.
 343 E. SIX FORKS ROAD, SUITE 200
 RALEIGH, NORTH CAROLINA 27609
 NC License No: C-1554

PAVEMENT MARKING DETAIL

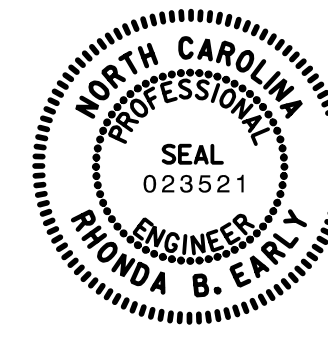
TIP NO. R-5023B	SHEET NO. PMP-4
APPROVED: <i>Rhonda B. Early</i> <small>DocuSigned by: Rhonda B. Early F34CAF5AC6BF48A...</small>	
DATE: 9/29/2016	
SEAL	
	
DOCUMENT NOT CONSIDERED FINAL UNLESS ALL SIGNATURES COMPLETED	

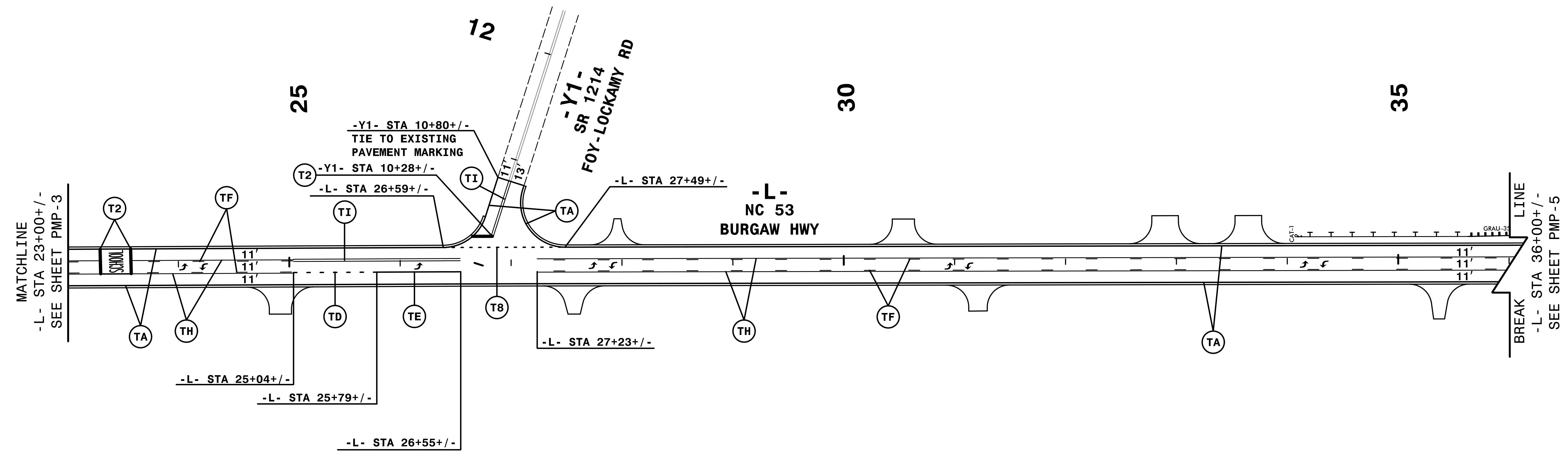
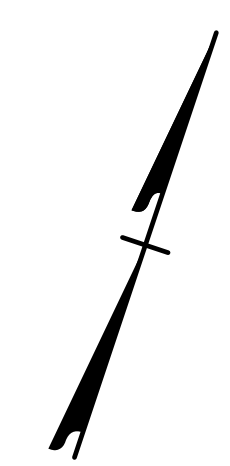

44745_PMP.dwg
4/27/16 PM
4/27/16 PMP\R5023B_pmp_pmp04.dgn
HNTB

HNTB HNTB NORTH CAROLINA, P.C.
343 E. SIX FORKS ROAD, SUITE 200
RALEIGH, NORTH CAROLINA 27609
NC LICENSE NO: C-1554

PAVEMENT MARKING DETAIL

TIP NO. R-5023B	SHEET NO. PMP-5
APPROVED: <i>Rhonda B. Early</i> F34CAF5AC6BF48A...	
DATE: 9/29/2016	
SEAL	
	
DOCUMENT NOT CONSIDERED FINAL UNLESS ALL SIGNATURES COMPLETED	

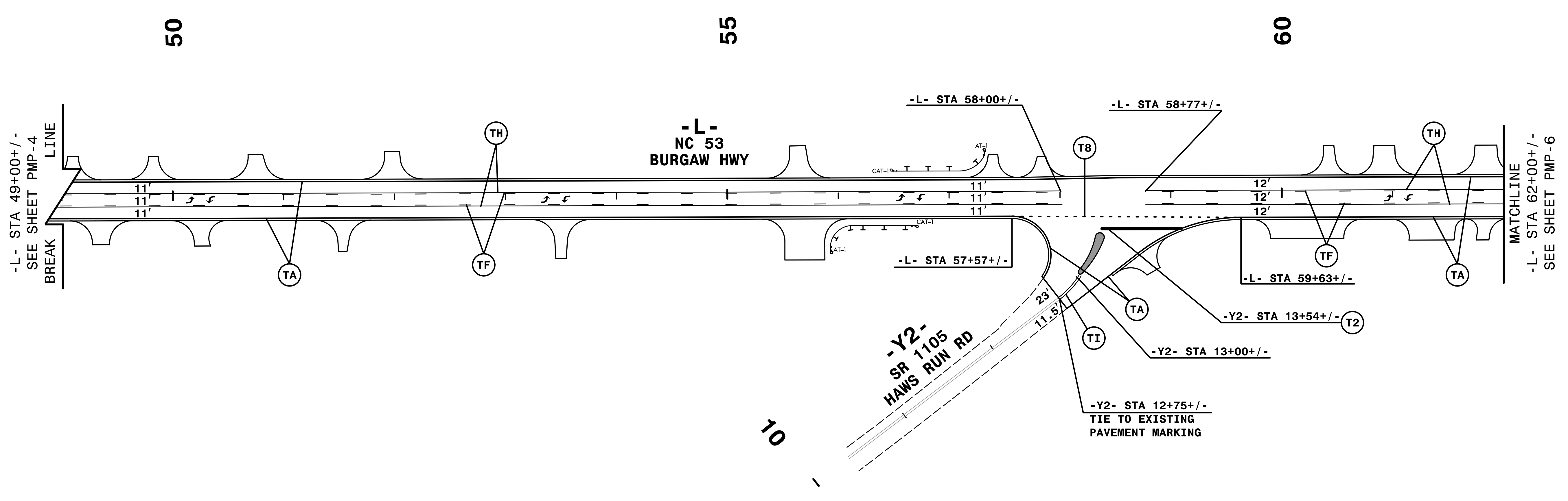

REFER TO PMP-9 FOR PLACEMENT OF PAVEMENT MARKERS FOR CONCRETE ISLANDS.

HNTB HNTB NORTH CAROLINA, P.C.
343 E. SIX FORKS ROAD, SUITE 200
RALEIGH, NORTH CAROLINA 27609
NC LICENSE NO: C-1554

PAVEMENT MARKING DETAIL

4:17:48 PM
C:\057 PMP\R5023B_pmp_pmp05.dgn
HNTB

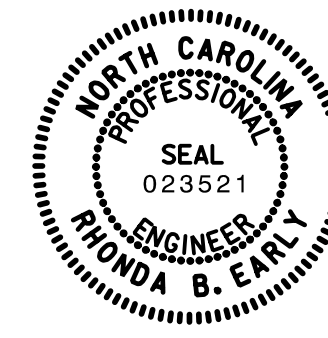
TIP NO. R-5023B	SHEET NO. PMP-6
APPROVED: <i>Rhonda B. Early</i> F34CAF5AC68F48A...	
DATE: 9/29/2016	
SEAL	
	
DOCUMENT NOT CONSIDERED FINAL UNLESS ALL SIGNATURES COMPLETED	

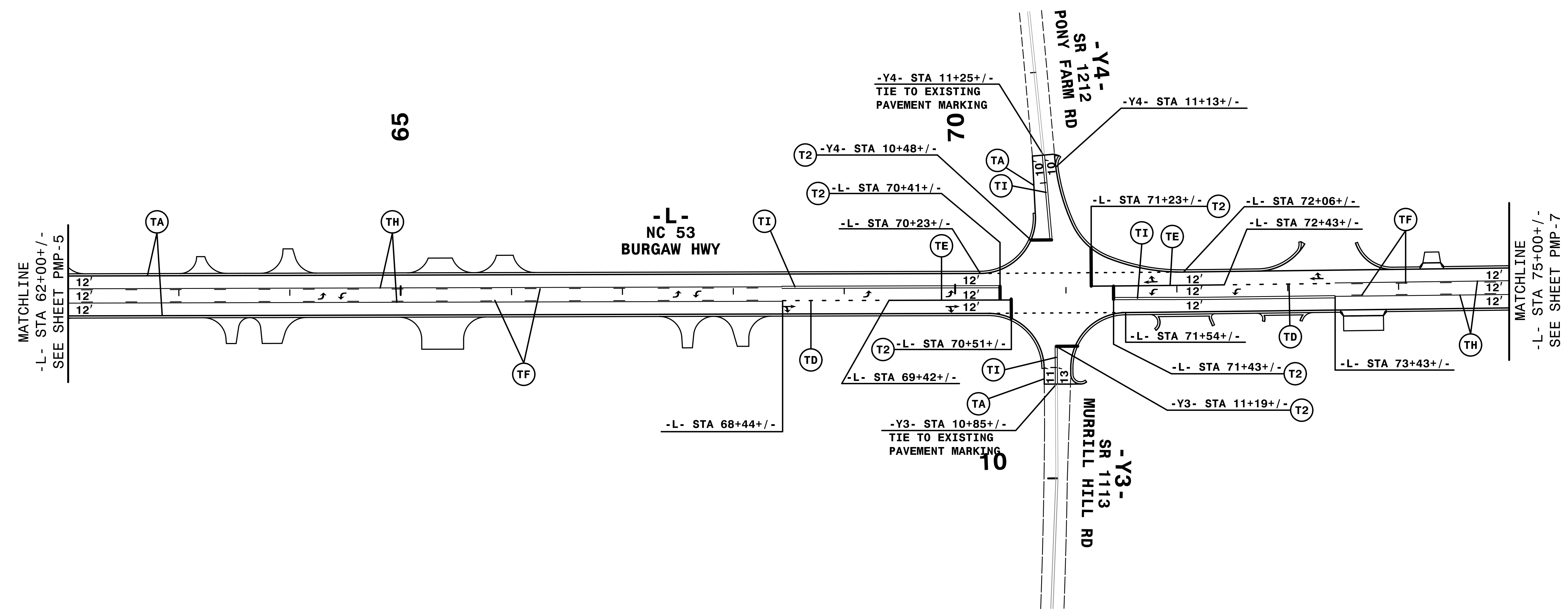
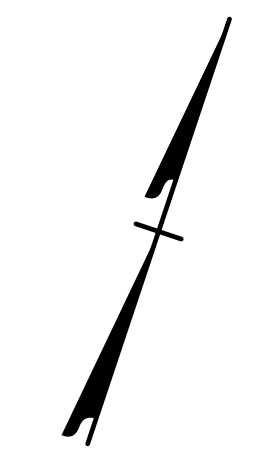

4/17/22 PM
 4:05:57 PMP\F5023B_pmp_pmp06.dgn
 HNTB

HNTB HNTB NORTH CAROLINA, P.C.
 343 E. SIX FORKS ROAD, SUITE 200
 RALEIGH, NORTH CAROLINA 27609
 NC LICENSE NO: C-1554

PAVEMENT MARKING DETAIL

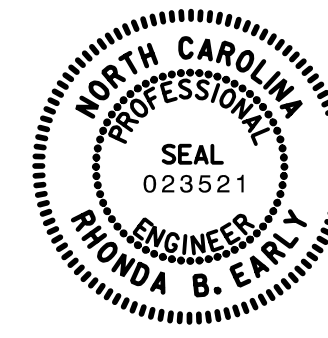
TIP NO. R-5023B	SHEET NO. PMP-7
APPROVED: <i>Rhonda B. Early</i> F34C4F5AC6BFB4B4	
DATE: 9/29/2016	
SEAL	
	
DOCUMENT NOT CONSIDERED FINAL UNLESS ALL SIGNATURES COMPLETED	

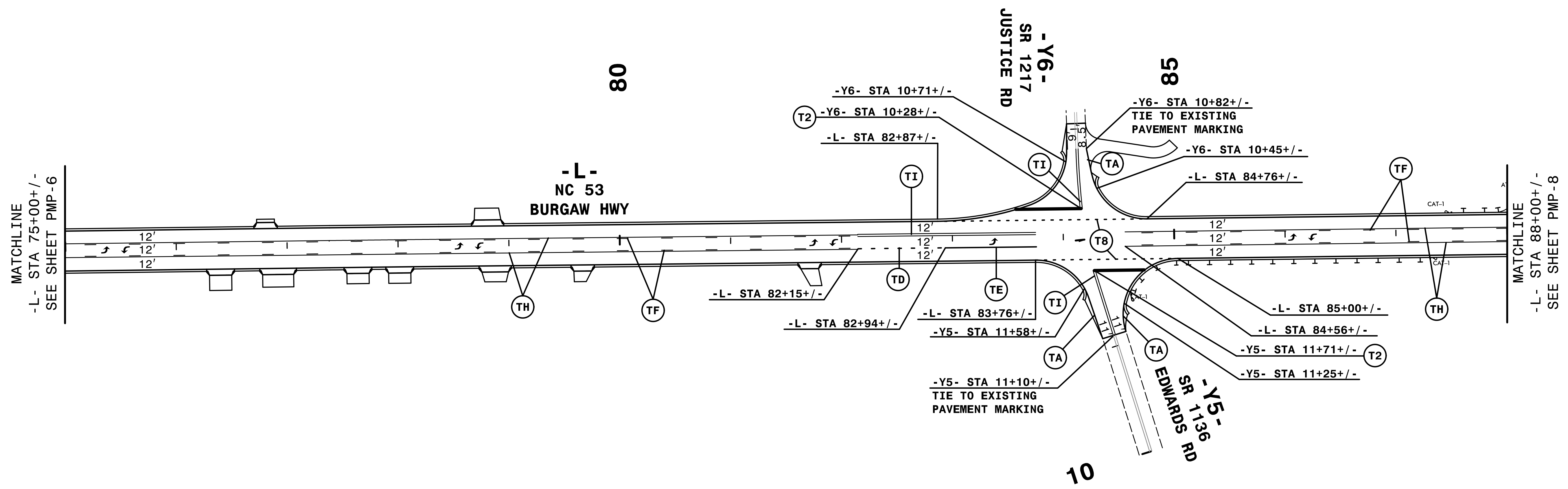
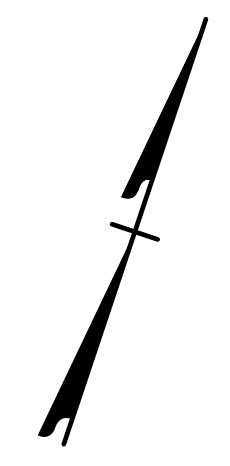

4/17/25 PM
 4:05 PM
 PMP\R5023B_pmp_pmp07.dgn
 HNTB

HNTB HNTB NORTH CAROLINA, P.C.
 343 E. SIX FORKS ROAD, SUITE 200
 RALEIGH, NORTH CAROLINA 27609
 NC LICENSE NO: C-1554

PAVEMENT MARKING DETAIL

TIP NO. R - 5023B	SHEET NO. PMP - 8
APPROVED: <i>Rhonda B. Early</i> DATE: 9/29/2016	
SEAL 	
DOCUMENT NOT CONSIDERED FINAL UNLESS ALL SIGNATURES COMPLETED	

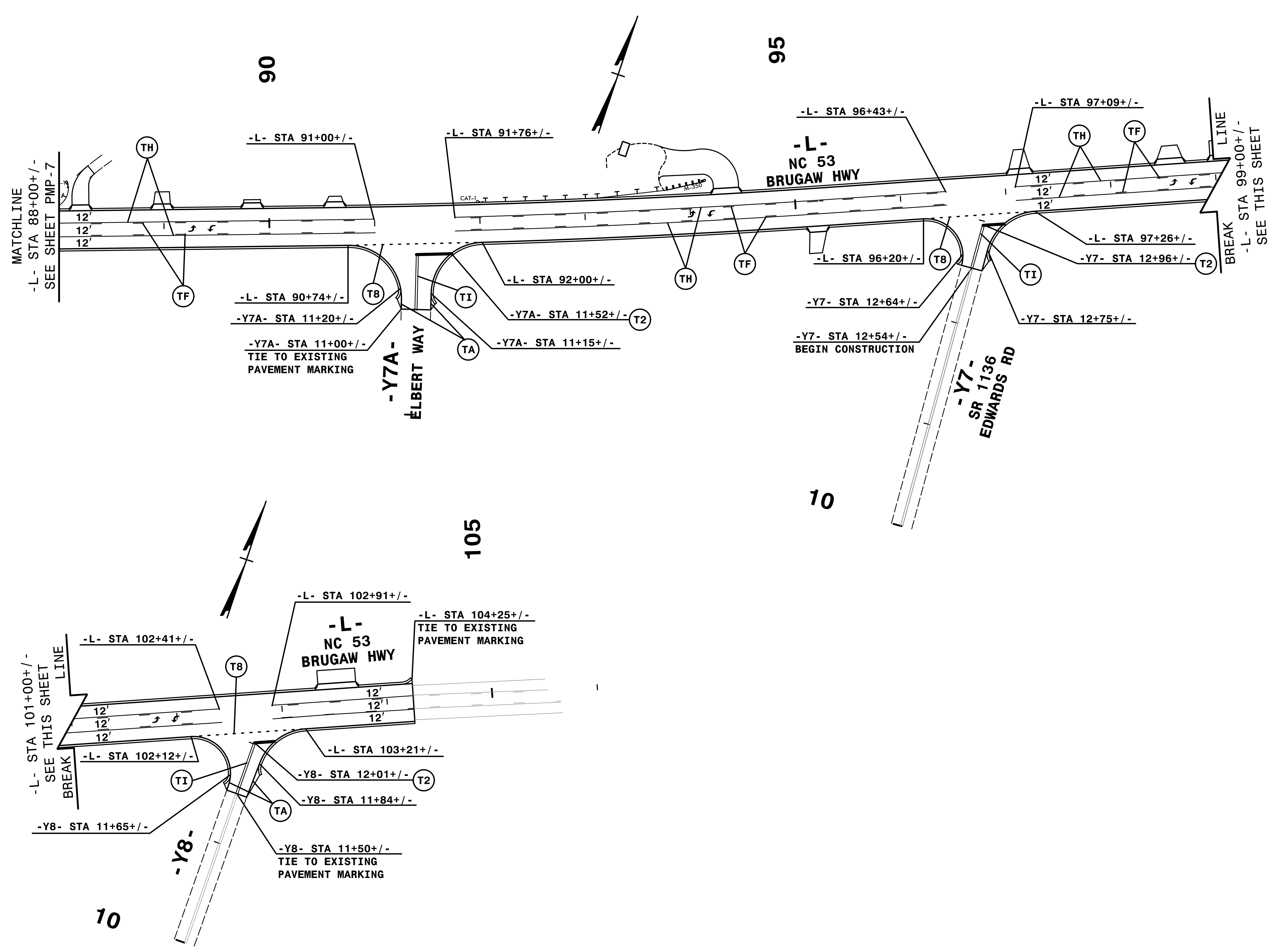

4/17/29 PM
4:05:57 PM
PMP\R5023B_pmp_pmp08.dgn
HNTB



PAVEMENT MARKING DETAIL

TIP NO. R-5023B	SHEET NO. PMP-9
APPROVED: <i>Rhonda B. Early</i> F34CAF5AC0BF48A...	
DATE: 9/29/2016	
SEAL	
	
DOCUMENT NOT CONSIDERED FINAL UNLESS ALL SIGNATURES COMPLETED	

PAVEMENT MARKER DETAIL FOR CONCRETE ISLANDS

RAISED PAVEMENT MARKER (Y/Y TYP.)
(STD. DWG 1251.01)

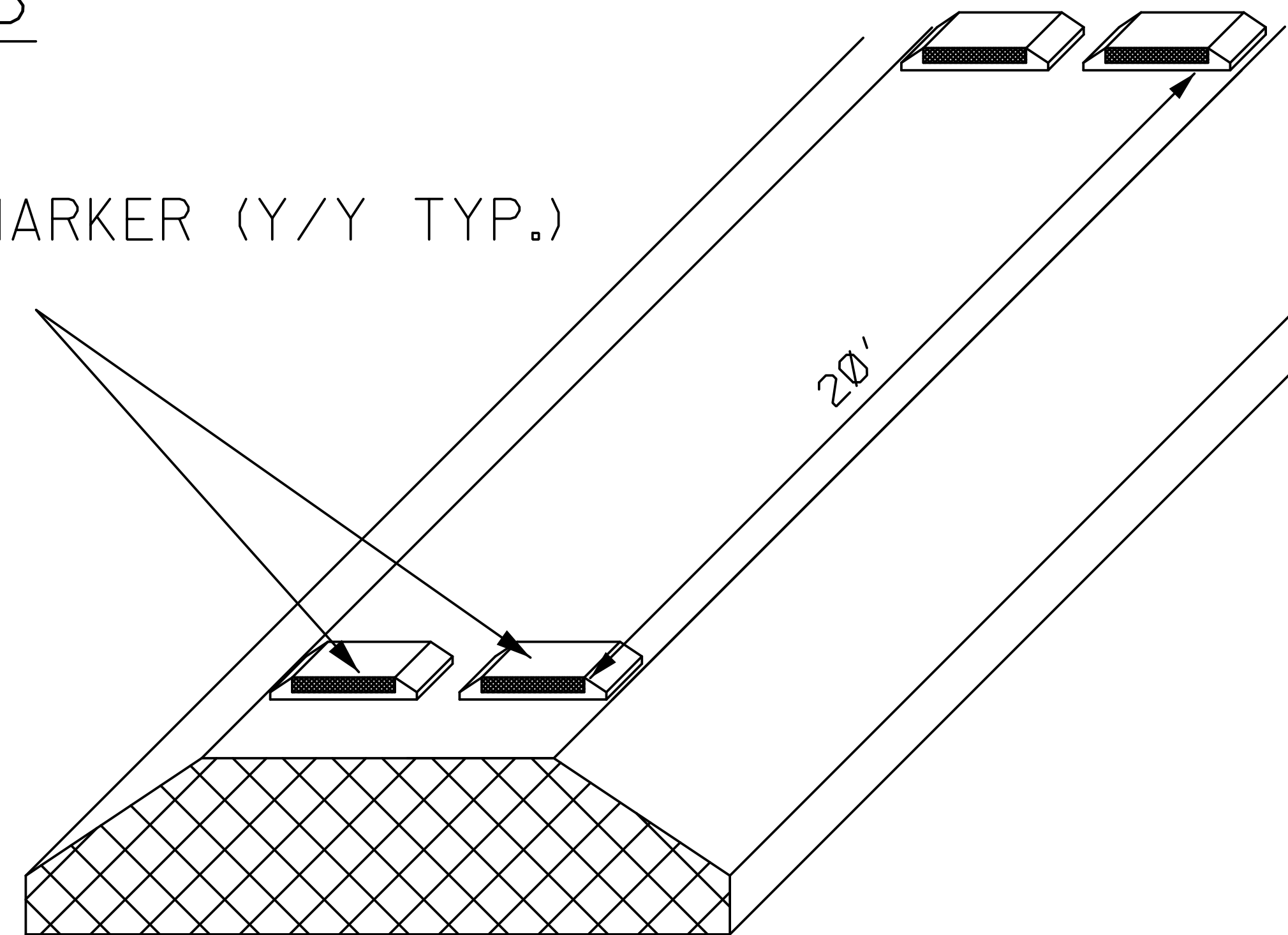
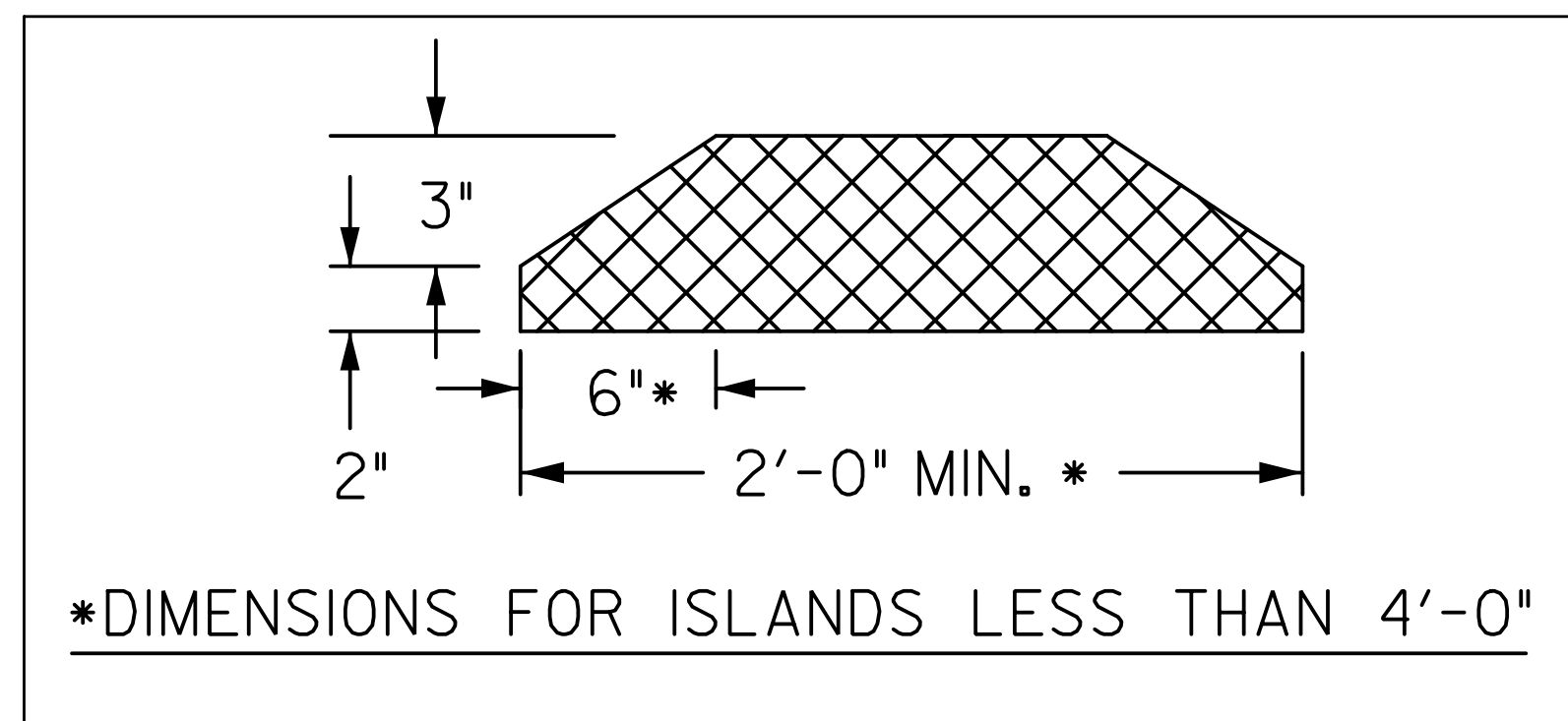

MONOLITHIC CONCRETE ISLAND

(SEE STANDARD DRAWINGS 852.01, 852.02, & 852.06 FOR DETAILS.)

4:17:32 PM
R5023B_pmp_pmp09_pmarker_detail.dgn
HNTB

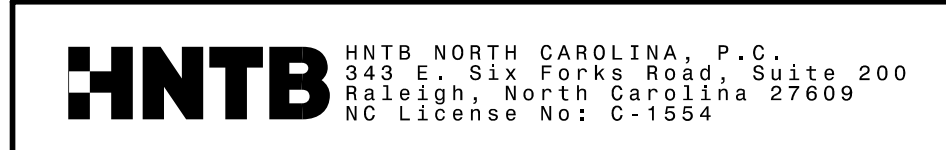

**PAVEMENT MARKER DETAIL
FOR CONCRETE ISLANDS**