

**UTILITY CONSTRUCTION**

DOCUMENT NOT CONSIDERED FINAL UNLESS ALL SIGNATURES COMPLETED

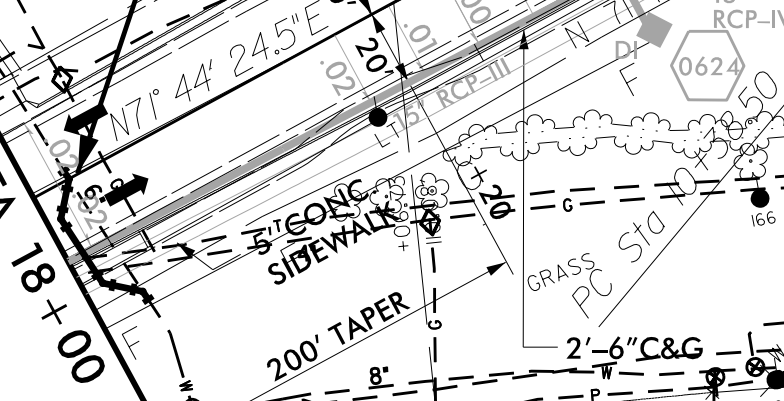
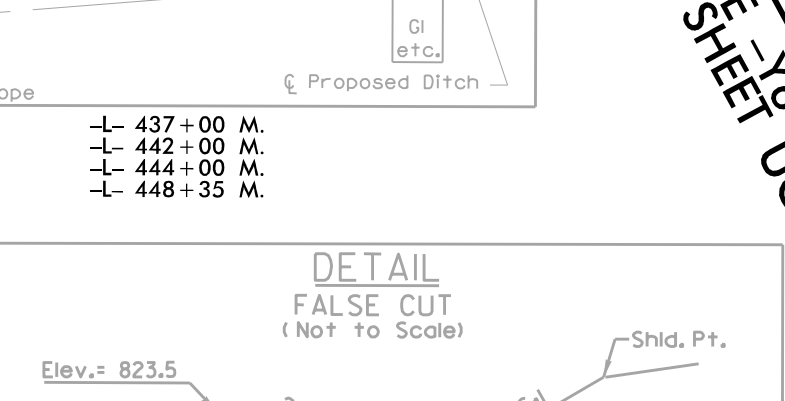
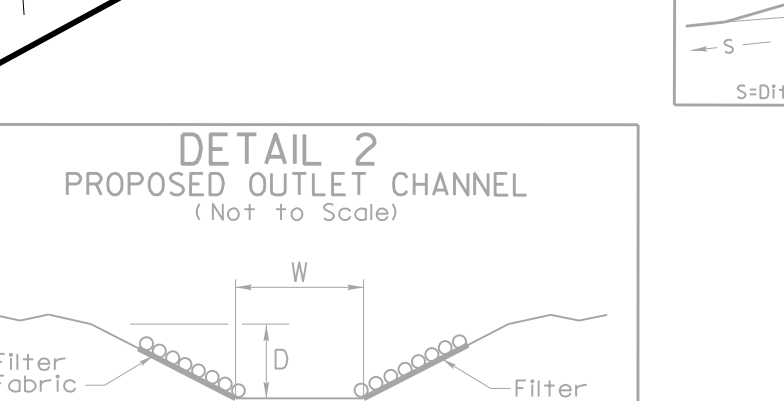
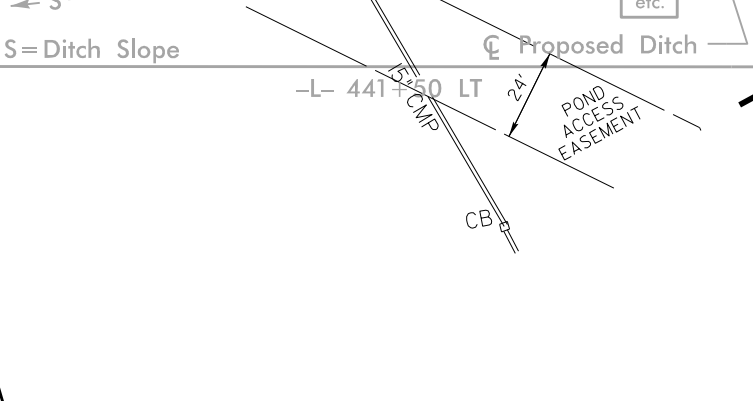
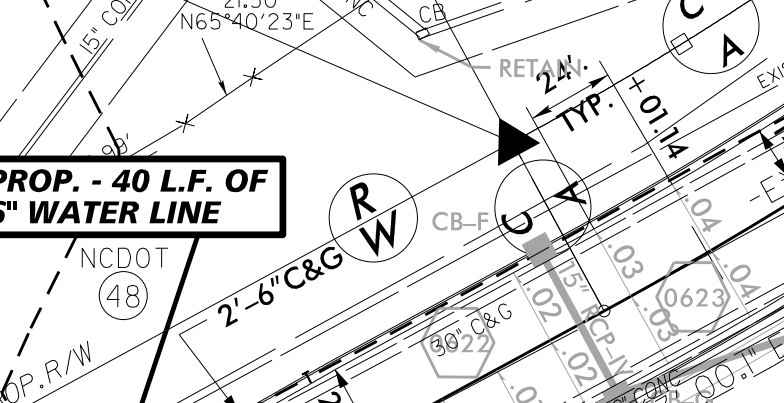
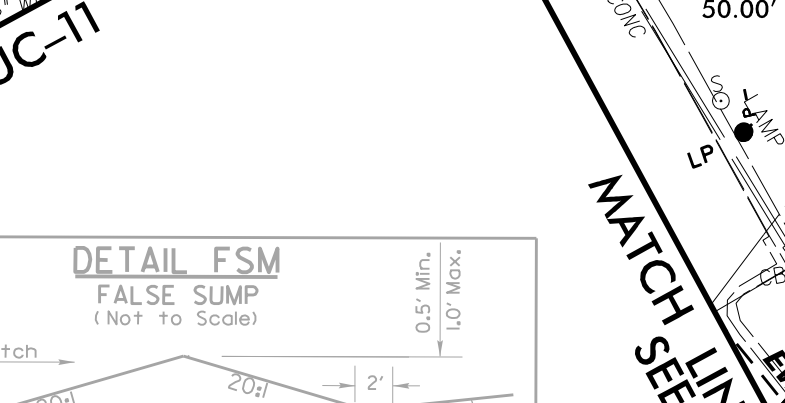
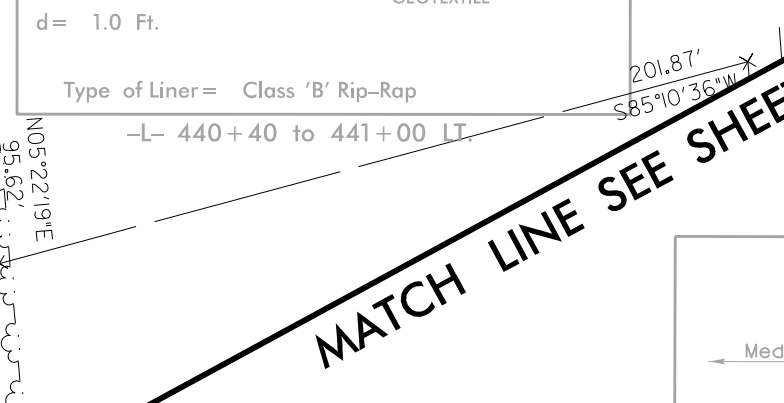
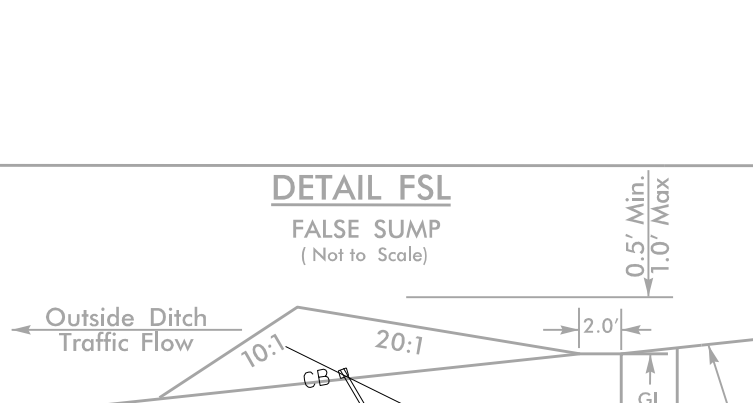
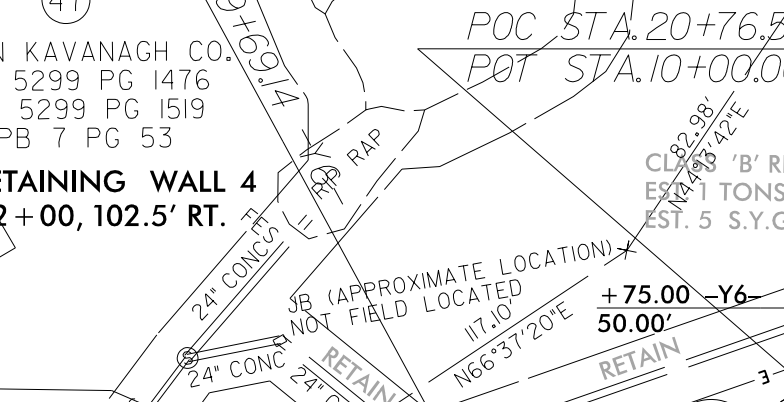
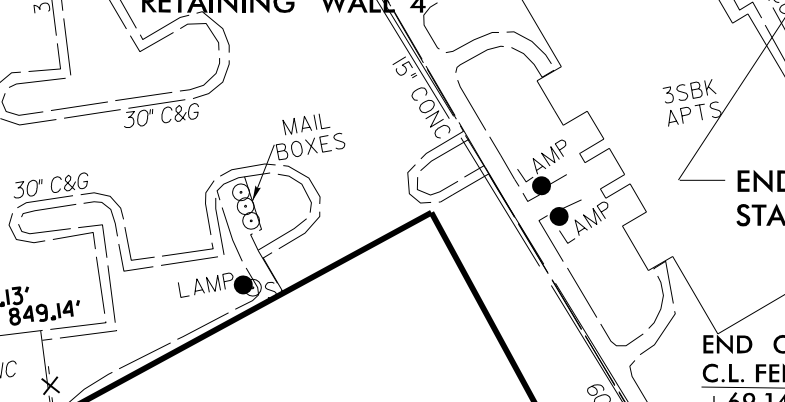
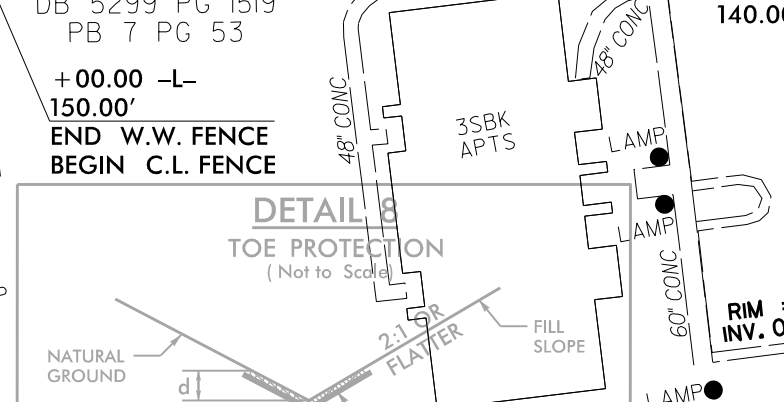
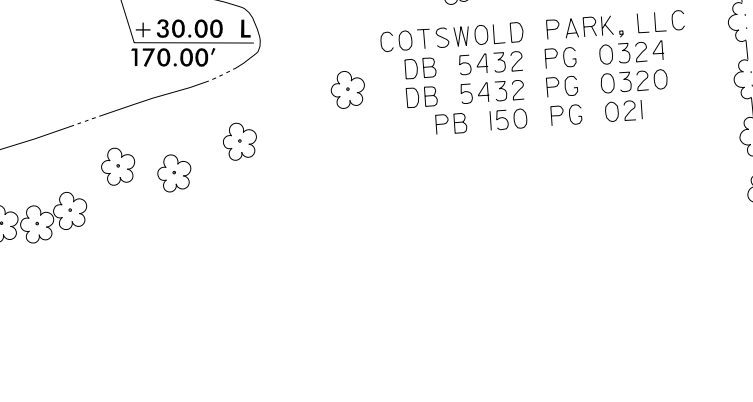
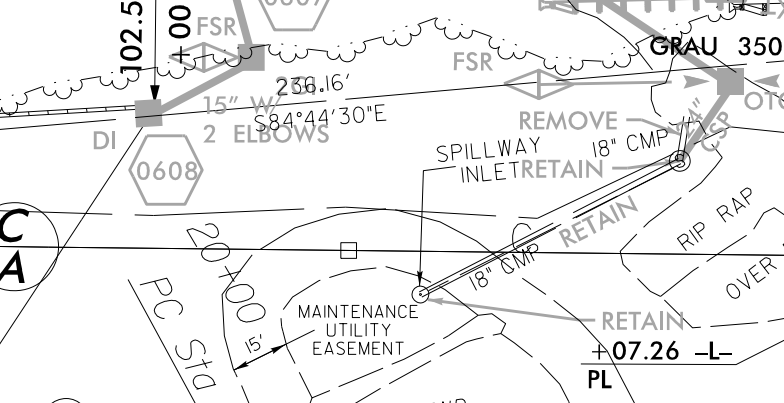
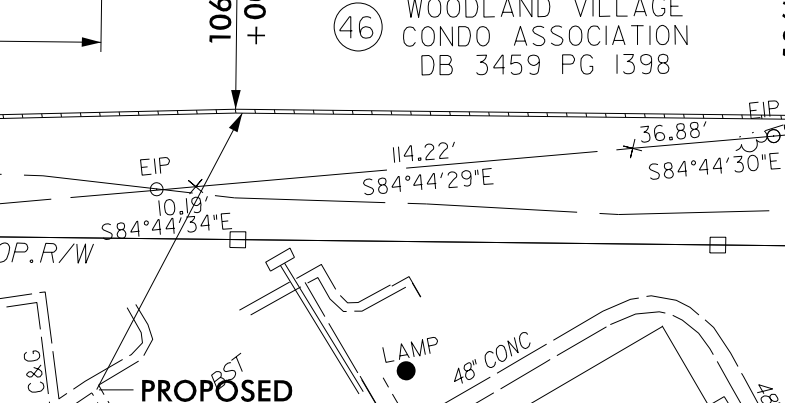
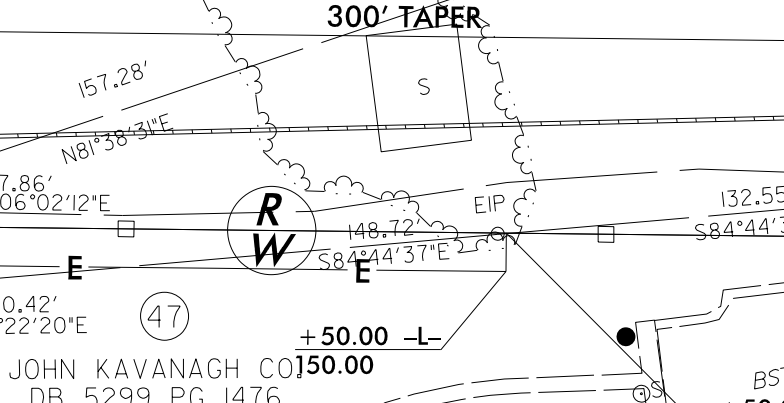
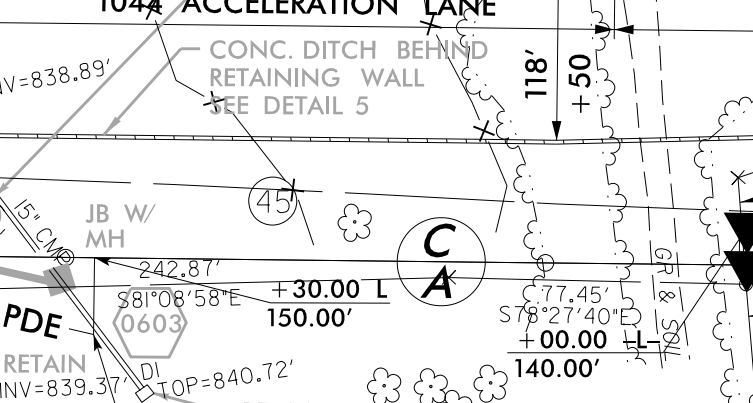
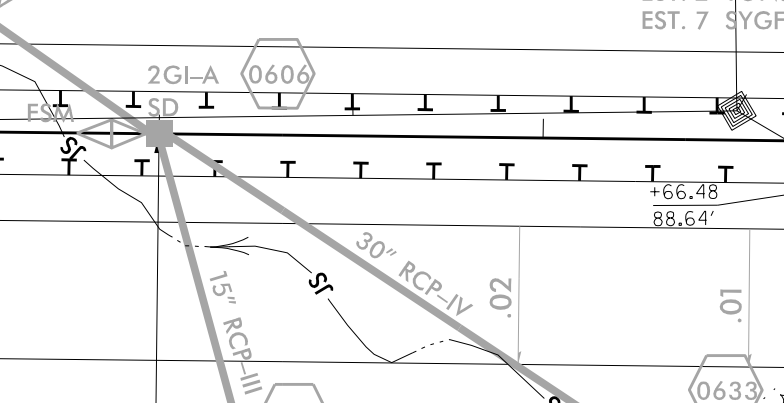
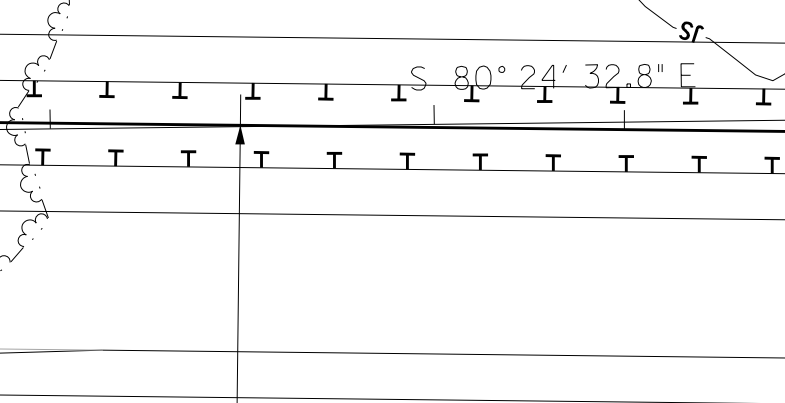
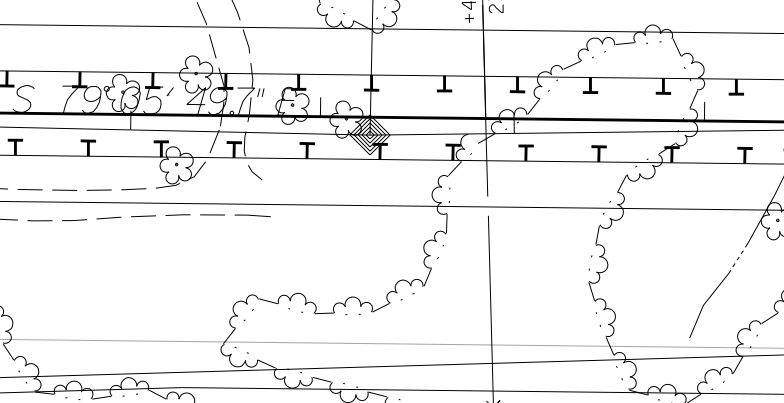
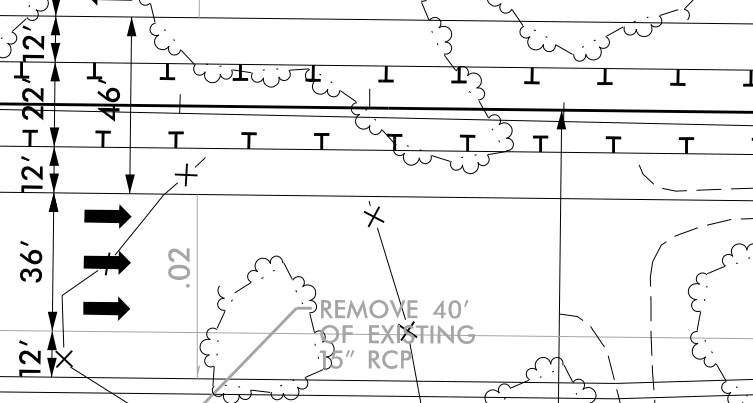
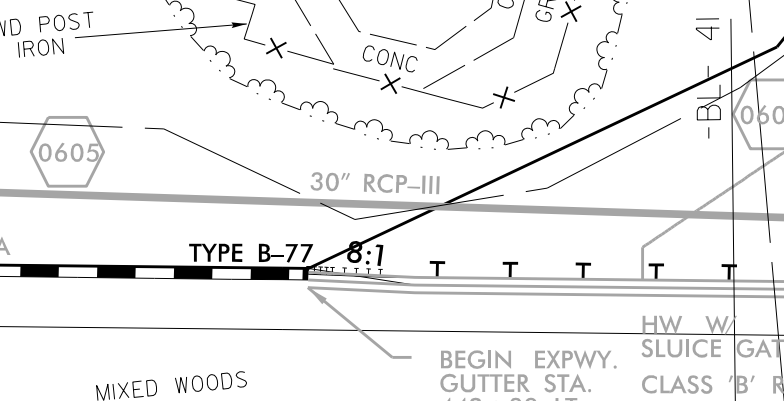
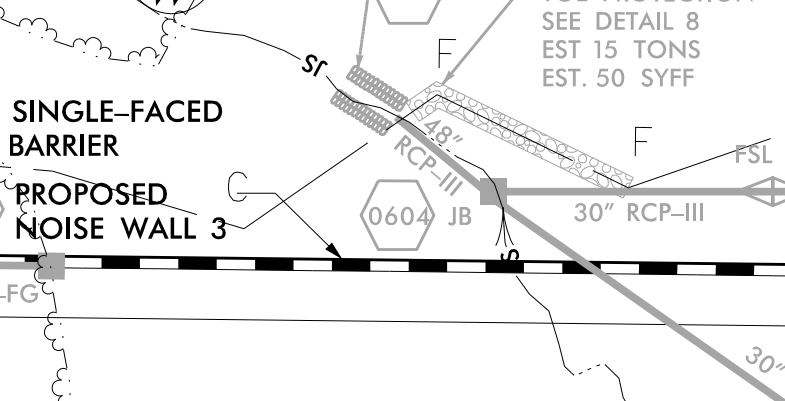
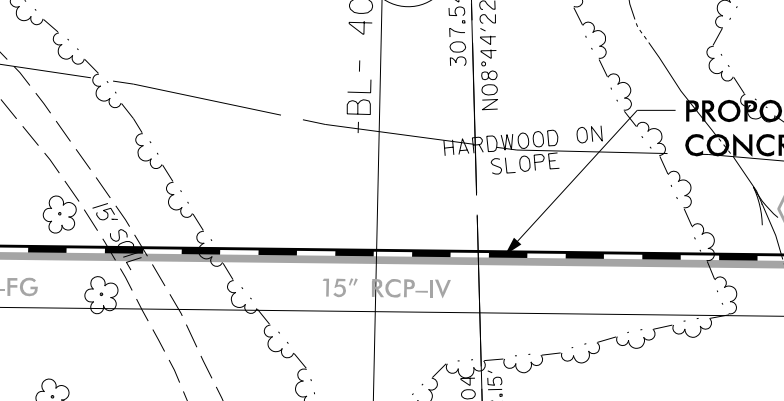
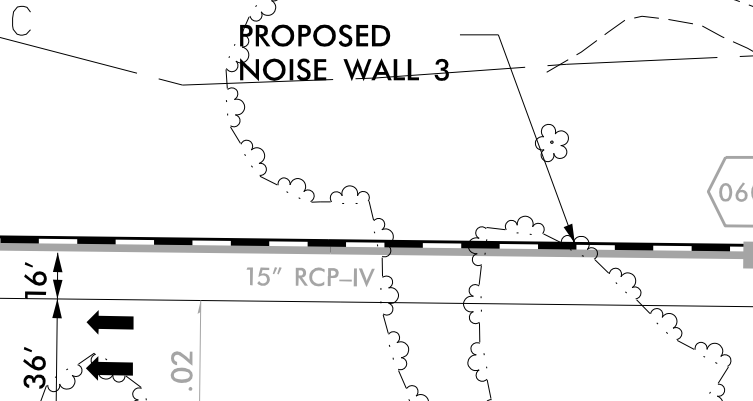
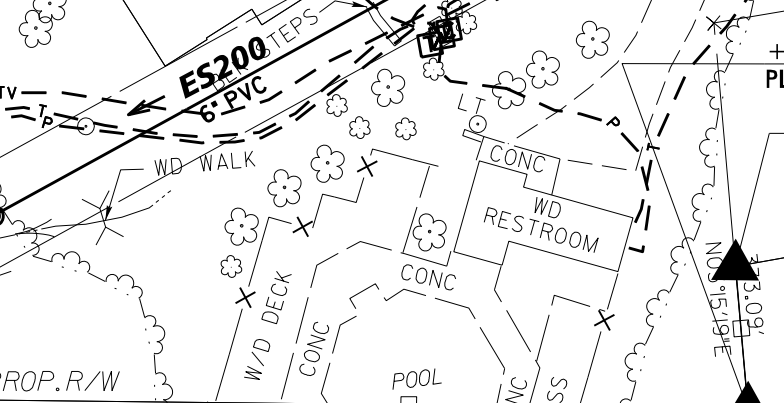
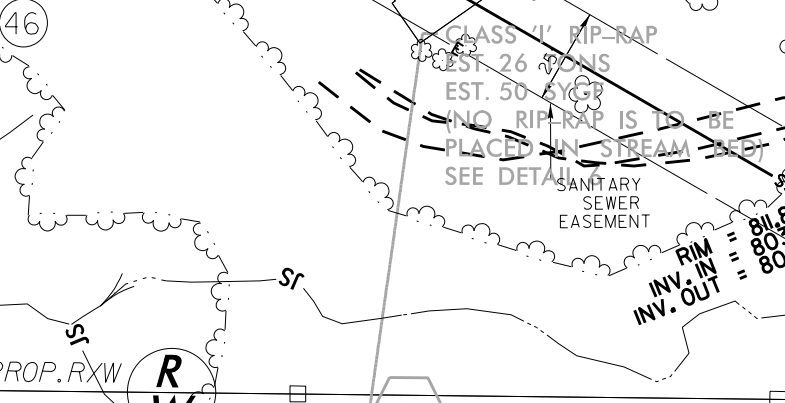
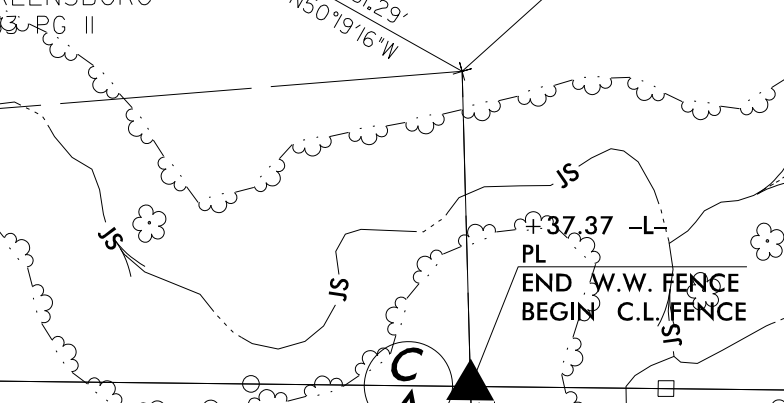
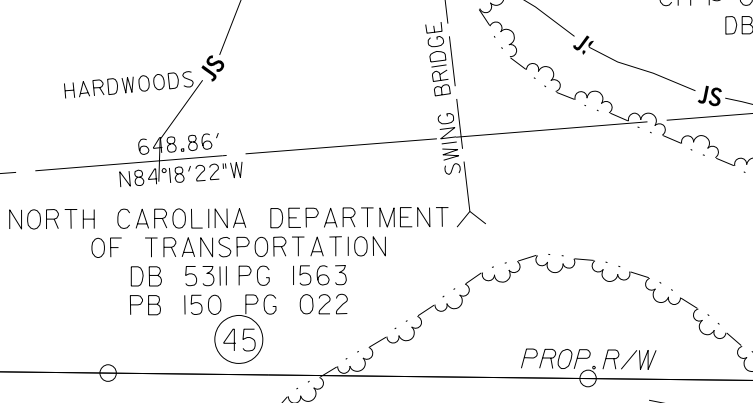
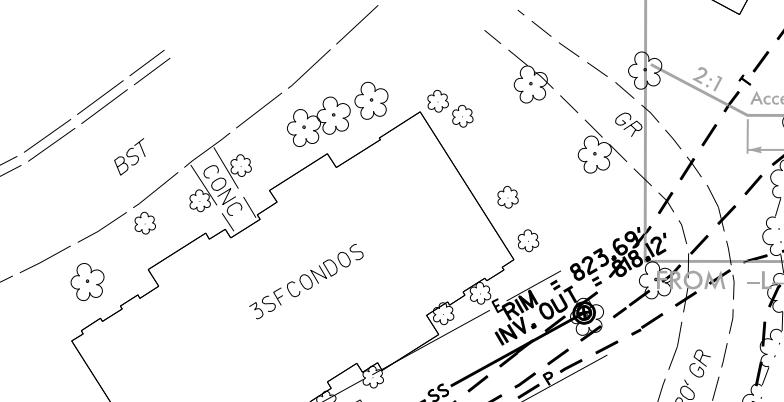
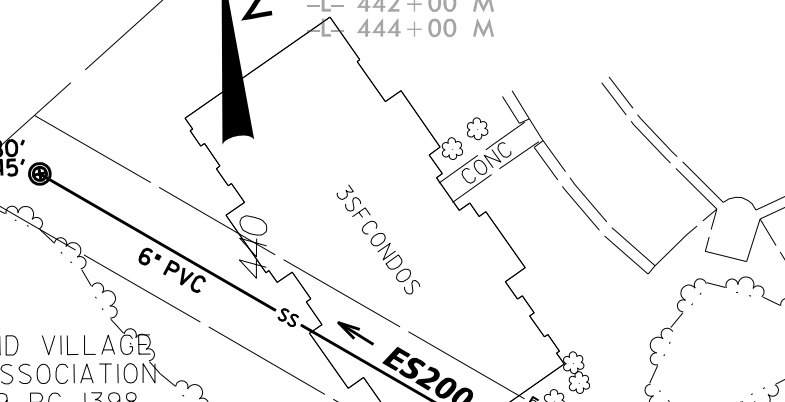
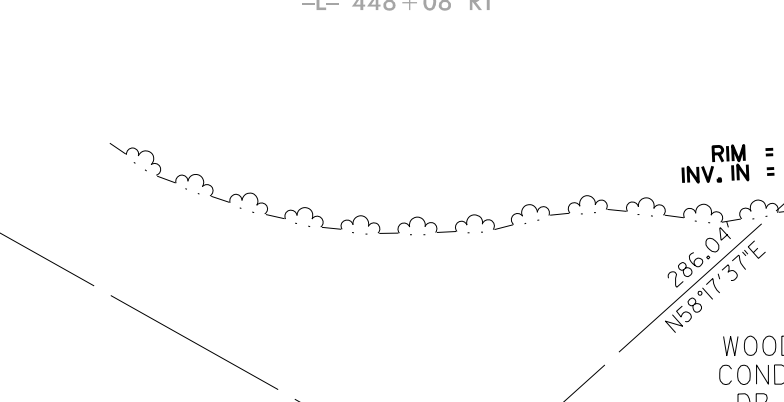
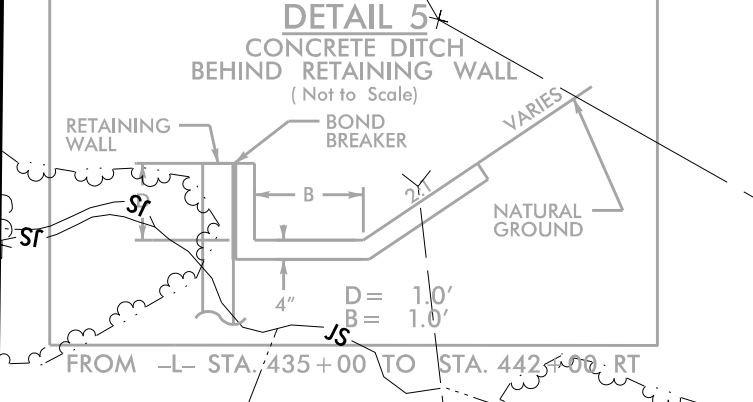
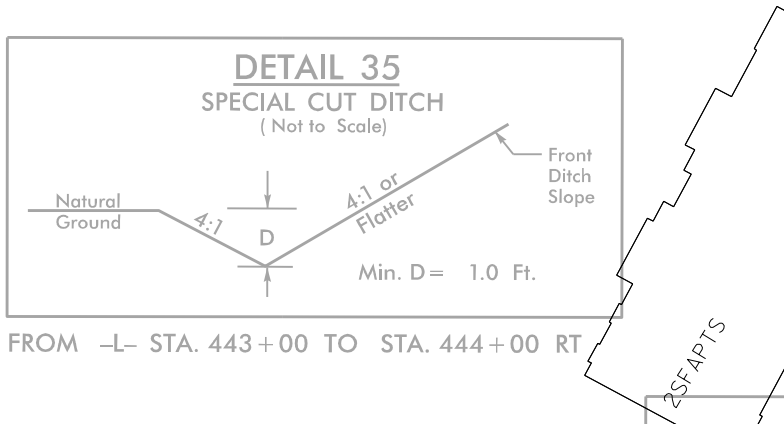
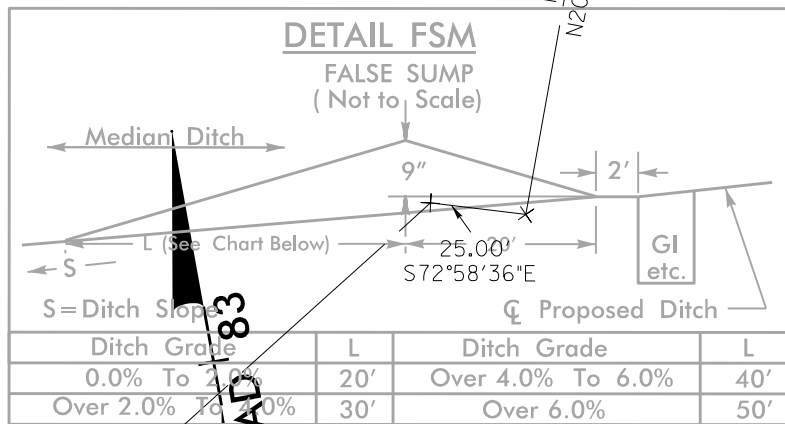
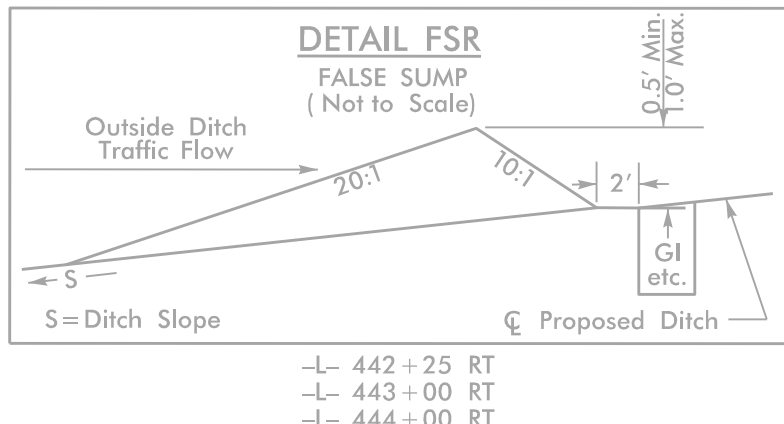
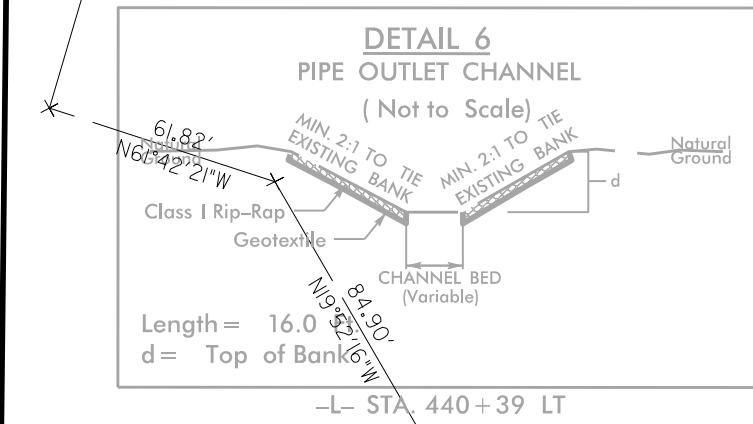
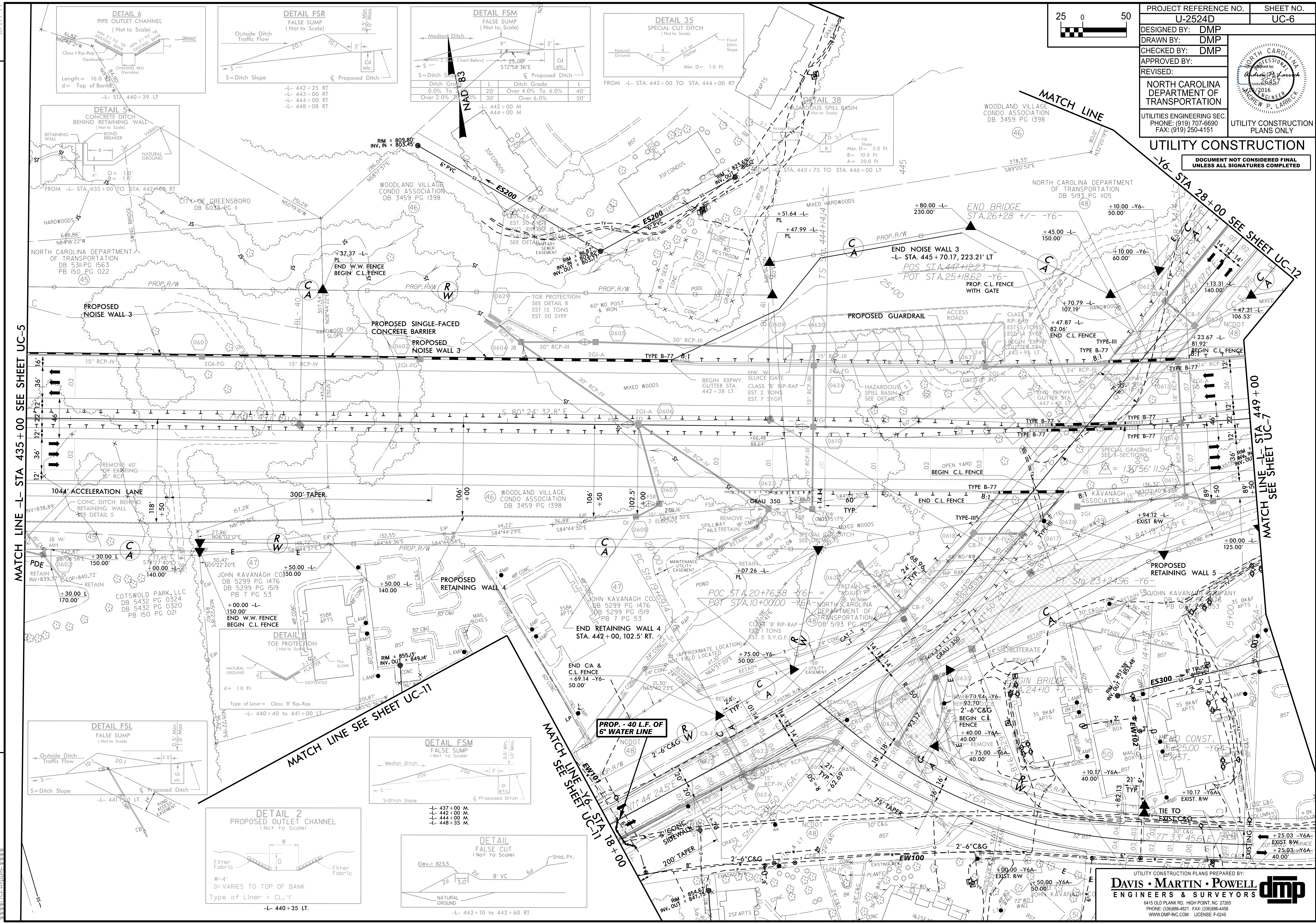
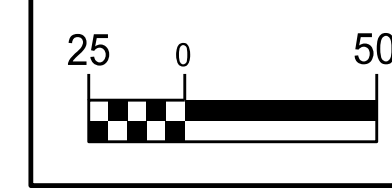

MATCH LINE -L- STA 435+00 SEE SHEET UC-5

MATCH LINE -L- STA 449+00 SEE SHEET UC-7

REVISIONS