

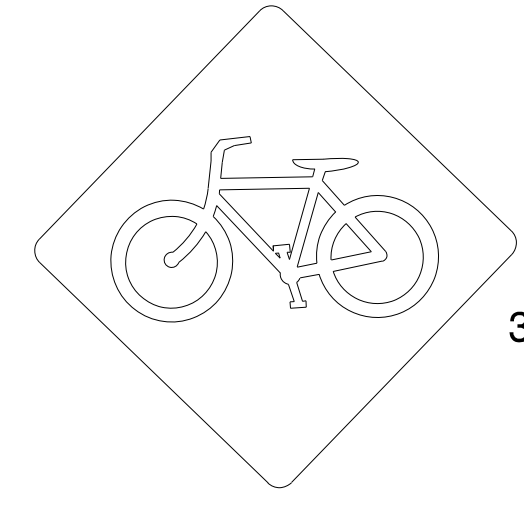



401 QUANTITY REQ'D 1



30 x 30
W11-1

ONE "U" POST PER SIGN

406 QUANTITY REQ'D 4



54 X 18
R6-1 (L)

MOUNT BACK TO BACK WITH SIGN 405
IN 2 INSTALLATION

411 QUANTITY REQ'D 2



36 X 36
R1-5R

ONE "U" POST PER SIGN

416 QUANTITY REQ'D 1



24 X 8
R3-17bP

MOUNT BELOW SIGN 415
IN 2 INSTALLATIONS

421 QUANTITY REQ'D 6



36 X 36
S1-1

YELLOW/GREEN REFLECTIVE SHEETING

ONE "U" POST PER SIGN

426 QUANTITY REQ'D 4

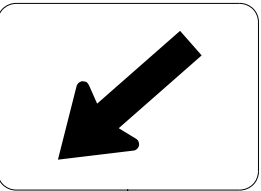

24 X 12
W16-7p

MOUNT BELOW SIGN 421
IN 4 INSTALLATIONS

427 QUANTITY REQ'D 2

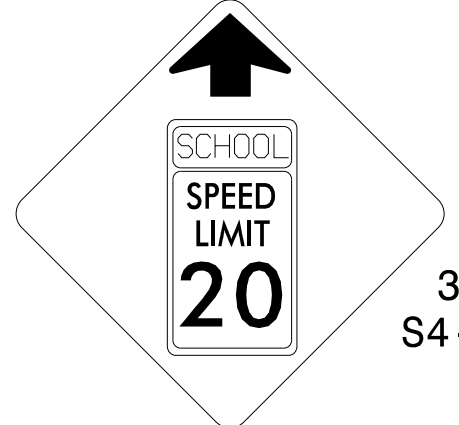

36 X 36
S4-5

ONE "U" POST PER SIGN

432 QUANTITY REQ'D 1

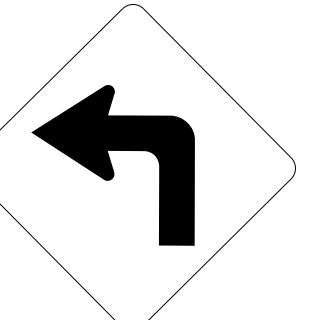

30 X 30
W1-1L

ONE "U" POST PER SIGN

402 QUANTITY REQ'D 1



18 x 24
W16-1P

MOUNT BELOW SIGN 401
IN 1 INSTALLATION

407 QUANTITY REQ'D 4



36 X 24
R5-1a

ONE "U" POST PER SIGN

412 QUANTITY REQ'D 10

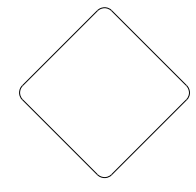

18 X 18
OM4-1

ONE "U" POST PER SIGN

417 QUANTITY REQ'D 12



36 X 12
R6-1 (R)

MOUNT ABOVE SIGN 409
IN 7 INSTALLATIONS

422 QUANTITY REQ'D 1

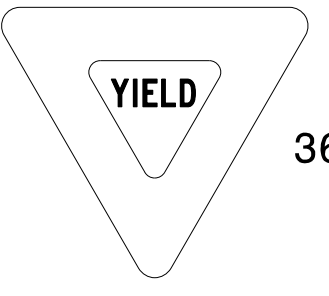

36 X 36 X 36
R1-2

ONE "U" POST PER SIGN

428 QUANTITY REQ'D 6



24 X 8
S4-3P

MOUNT ABOVE SIGN 421
IN 2 INSTALLATIONS
MOUNT ABOVE SIGN 420
IN 4 INSTALLATIONS

433 QUANTITY REQ'D 7

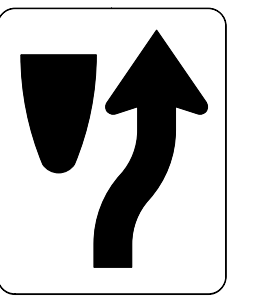

24 X 30
R4-7

ONE "U" POST PER SIGN

403 QUANTITY REQ'D 10



30 X 30
R5-1

MOUNT BACK TO BACK WITH SIGN 409
IN 2 INSTALLATION

408 QUANTITY REQ'D 1

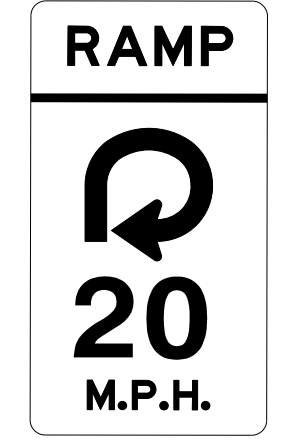

24 x 42
W13-7

ONE "U" POST PER SIGN

413 QUANTITY REQ'D 1

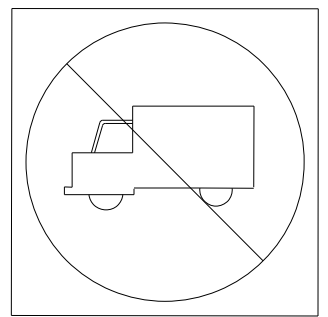

24 X 24
R5-2

ONE "U" POST PER SIGN

418 QUANTITY REQ'D 5



36 X 12
R6-1 (L)

MOUNT BACK TO BACK WITH
SIGN 417 IN 4 INSTALLATIONS

423 QUANTITY REQ'D 4

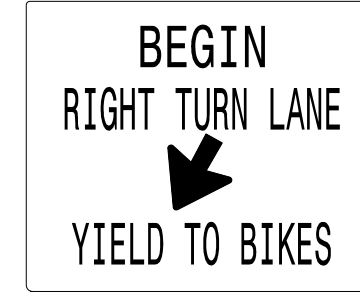

36 x 30
R4-4

ONE "U" POST PER SIGN

429 QUANTITY REQ'D 4

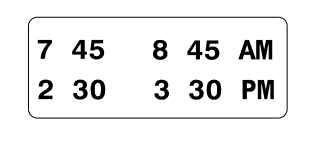

24 X 10
S4-1P

MOUNT BELOW SIGN 420
IN 4 INSTALLATIONS

434 QUANTITY REQ'D 6

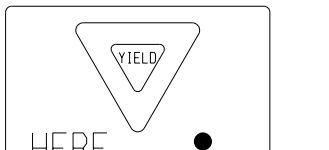

36 X 36
R1-5L

ONE "U" POST PER SIGN

404 QUANTITY REQ'D 2



18 X 18
W13-1P

MOUNT BELOW SIGN 431
IN 2 INSTALLATION

409 QUANTITY REQ'D 11

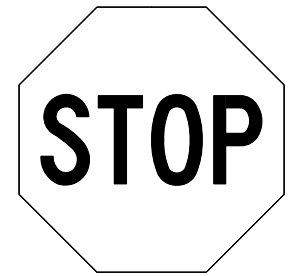

36 X 36
R1-1

ONE "U" POST PER SIGN

414 QUANTITY REQ'D 5



36 X 36
R3-7

ONE "U" POST PER SIGN

419 QUANTITY REQ'D 2



30 x 30
W14-2

ONE "U" POST PER SIGN

424 QUANTITY REQ'D 2



36 X 36
S4-5

ONE "U" POST PER SIGN

430 QUANTITY REQ'D 5

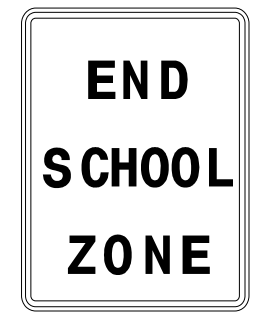

24 X 30
S5-2

ONE "U" POST PER SIGN

435 QUANTITY REQ'D 6

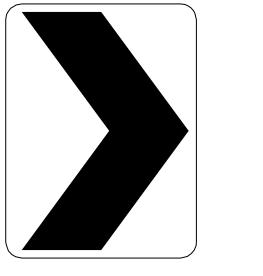

30 X 36
W1-8R

ONE "U" POST PER SIGN

405 QUANTITY REQ'D 3



54 X 18
R6-1 (R)

TWO "U" POSTS PER SIGN

410 QUANTITY REQ'D 3

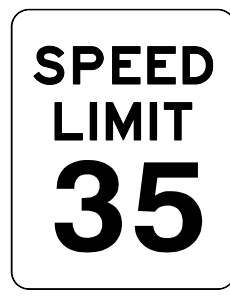

24 X 30
R2-1

ONE "U" POST PER SIGN

415 QUANTITY REQ'D 2



24 X 18
R3-17

ONE "U" POST PER SIGN

420 QUANTITY REQ'D 4



24 X 30
R2-1

ONE "U" POST PER SIGN

425 QUANTITY REQ'D 2

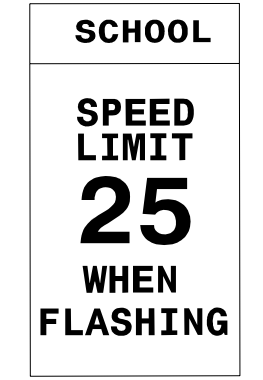

24 X 48
S5-1

ONE "U" POST PER SIGN

431 QUANTITY REQ'D 1

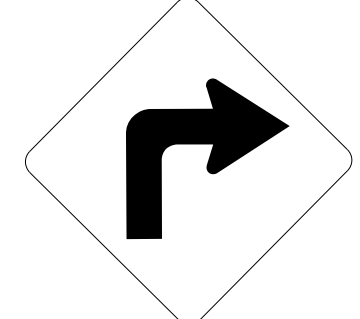

30 X 30
W1-1R

ONE "U" POST PER SIGN

TYPE "E" SIGNS

4/6/2015 P:\Projects-U\U3308-Traffic\Signing\CADD\Signing Layout Plans\U-3308-SGNSHT-1.dgn