

ELEVATION OF PARAPET DETAILS

ALL DIMENSIONS SHOWN ARE MEASURED ALONG THE OUTSIDE EDGE OF SUPERSTRUCTURE.
 RIGHT PARAPET (STAGE II) SHOWN, LEFT PARAPET (STAGE I) SIMILAR BY ROTATION.

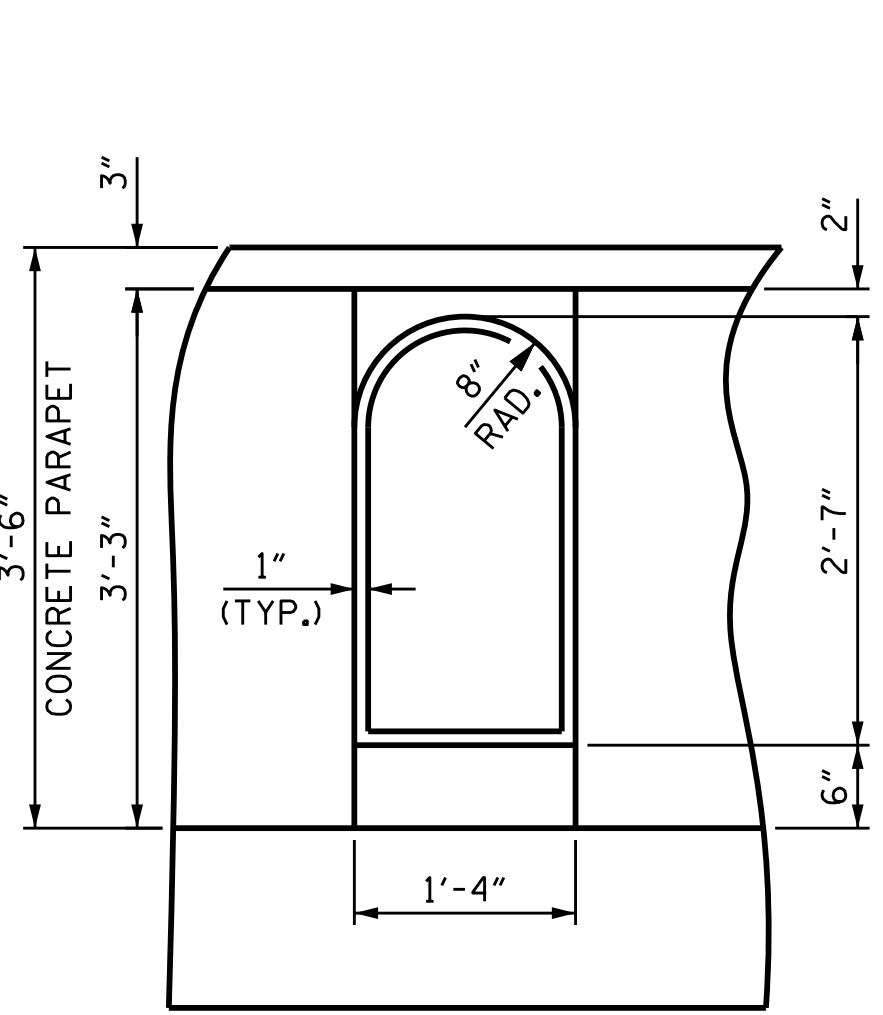

RECESSED PANEL DETAIL

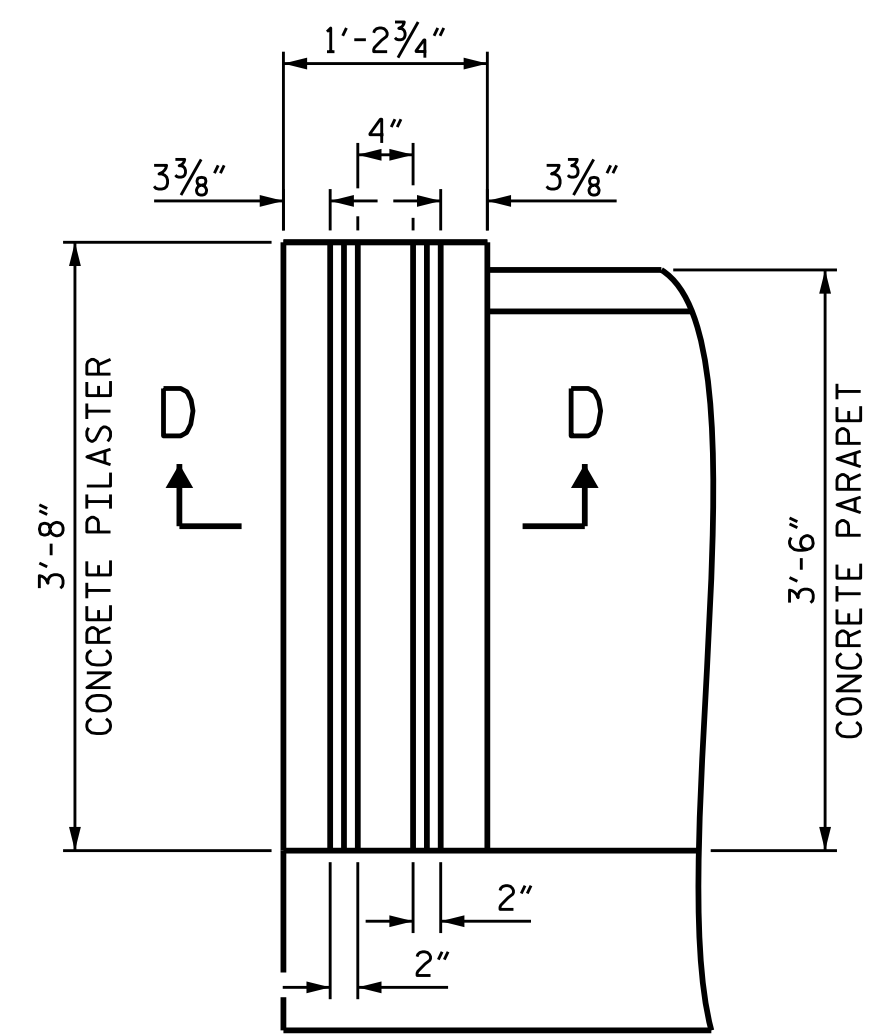

JOINT PILASTER DETAIL

PILASTER TO RIGHT OF JOINT SHOWN.
 PILASTER TO LEFT OF JOINT SIMILAR
 BY ROTATION.

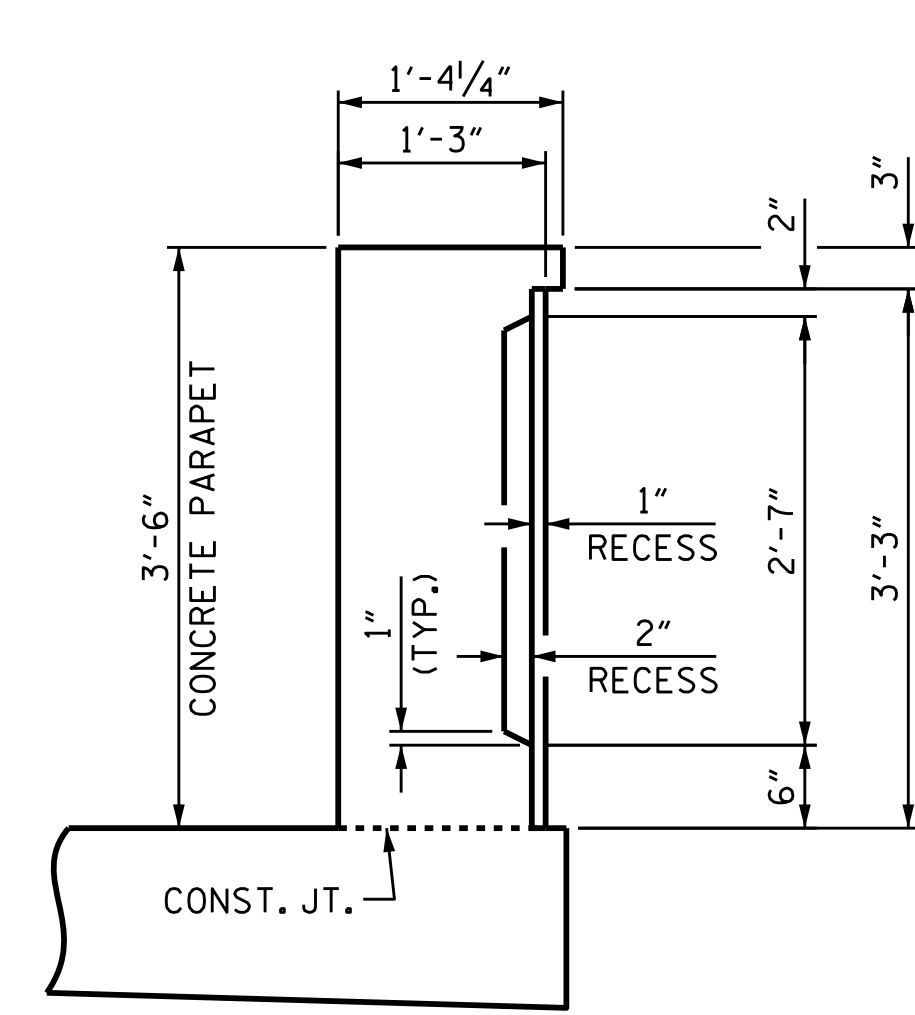

SECTION A-A

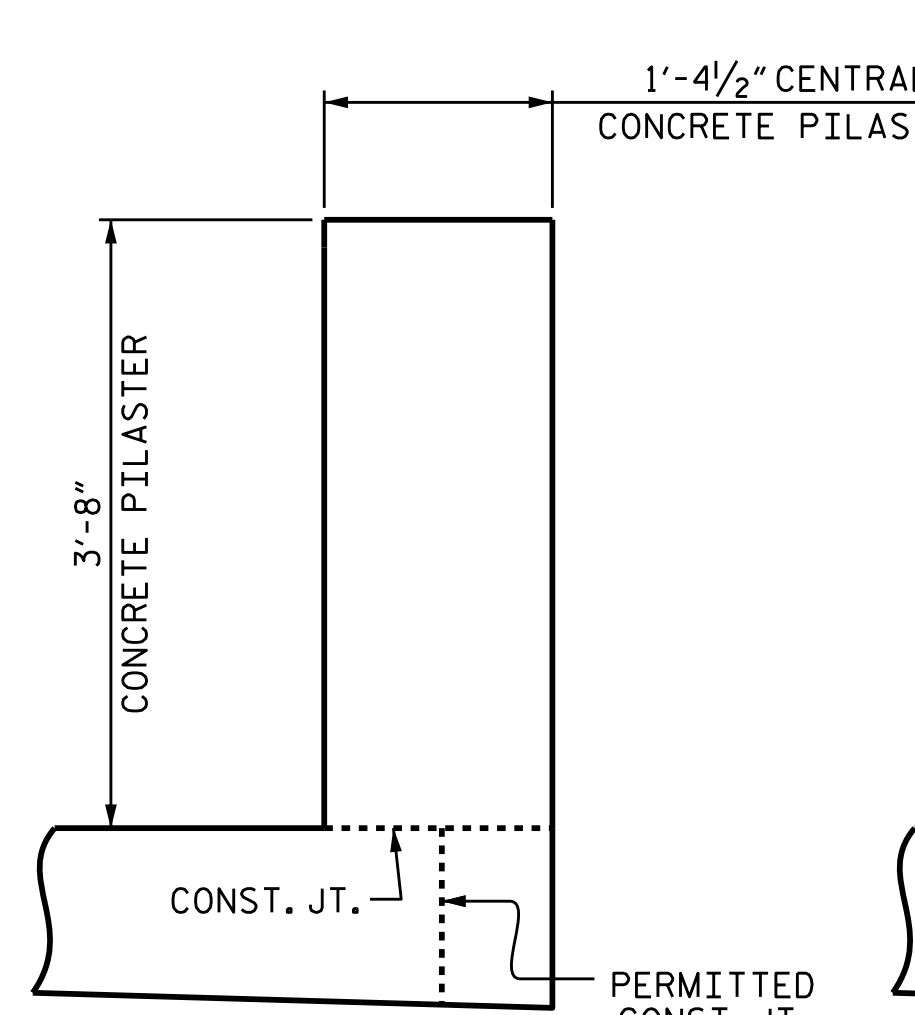

SECTION B-B

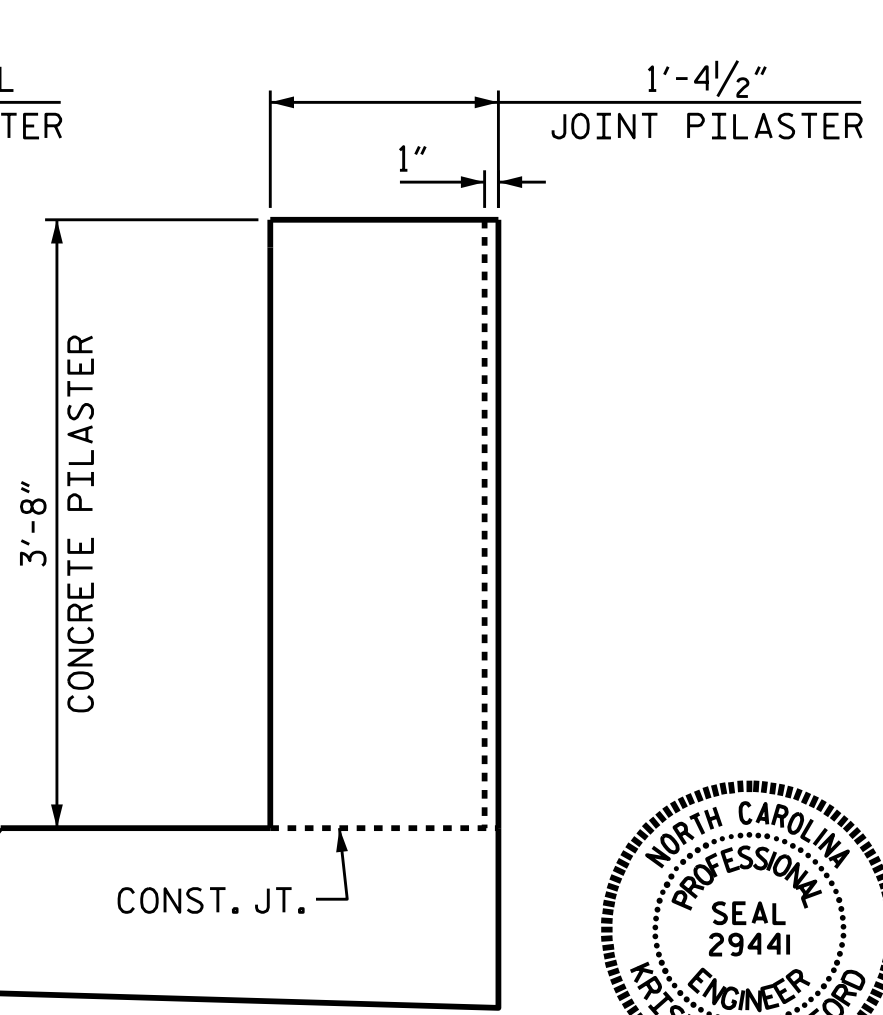

SECTION C-C

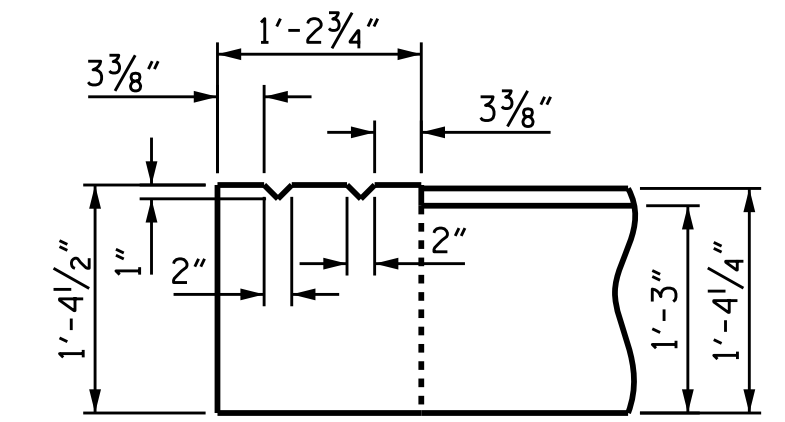

SECTION D-D

PROJECT NO. B-5121/B-5317
 WAKE COUNTY
 STATION: 22+06.91 -L-

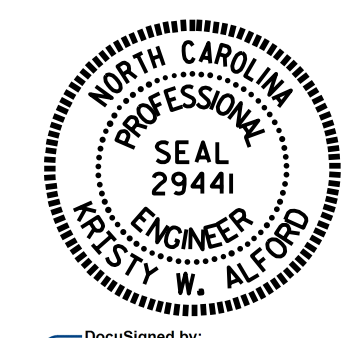

DocuSigned by:
 K.W. Alford
 F24583809B40E
 4/13/2016

STATE OF NORTH CAROLINA
 DEPARTMENT OF TRANSPORTATION
 RALEIGH
 SUPERSTRUCTURE
 PARAPET
 AESTHETIC DETAILS

DRAWN BY: K.W. ALFORD DATE: 1/2016
 CHECKED BY: J.P. ADAMS DATE: 2/2016
 DESIGN ENGINEER OF RECORD: K.W. ALFORD DATE: 1/2016

DOCUMENT NOT CONSIDERED
 FINAL UNLESS ALL
 SIGNATURES COMPLETED

| REVISIONS | | | | | | SHEET NO. |
|-----------|-----|-------|-----|-----|-------|--------------|
| NO. | BY: | DATE: | NO. | BY: | DATE: | TOTAL SHEETS |
| 1 | | | 3 | | | S-20 |
| 2 | | | 4 | | | 110 |