

|  |                           |
|--|---------------------------|
| PROJECT REFERENCE NO.<br>B-5344  | SHEET NO.<br>EC-5/CONST.4 |
| R/W SHEET NO.  |                           |
| ROADWAY DESIGN ENGINEER  | HYDRAULICS ENGINEER       |
| <b>DOCUMENT NOT CONSIDERED FINAL<br/>UNLESS ALL SIGNATURES COMPLETED</b> |                           |

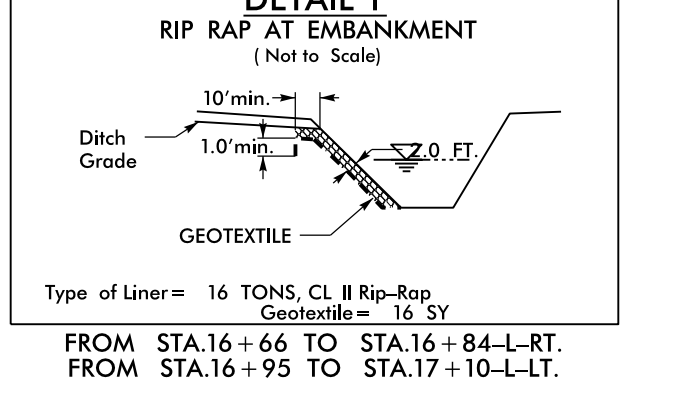
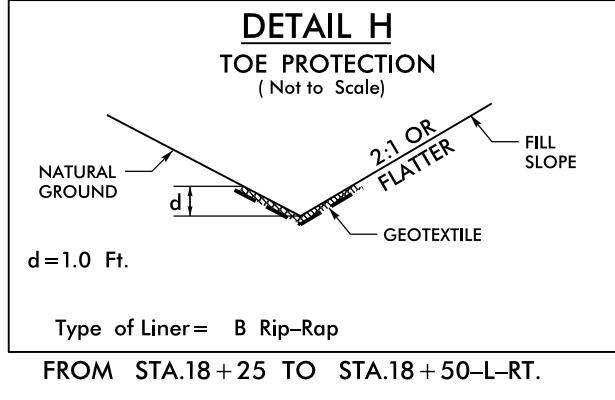
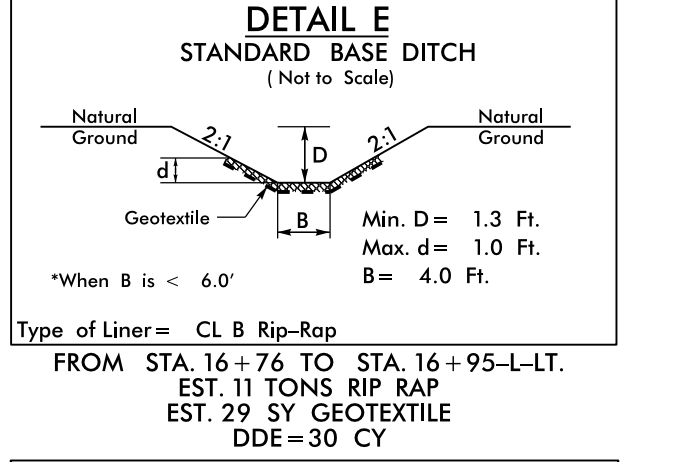
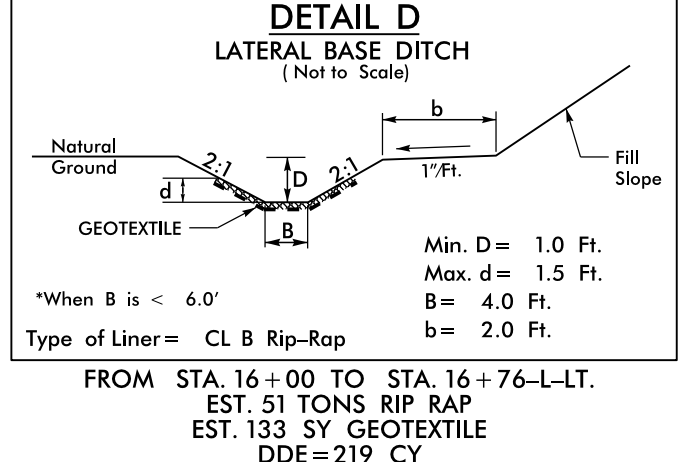
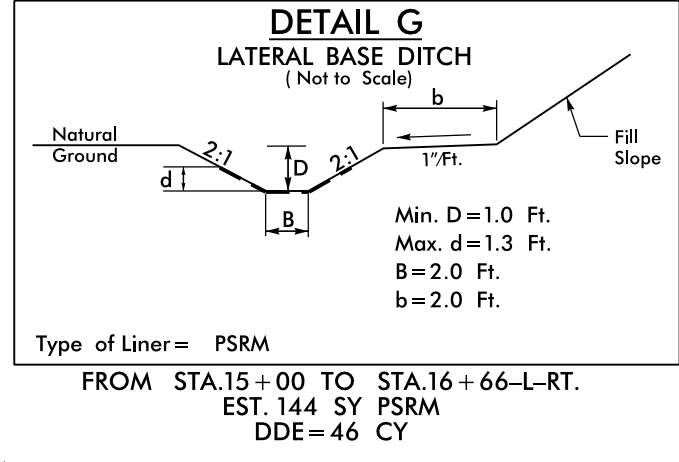
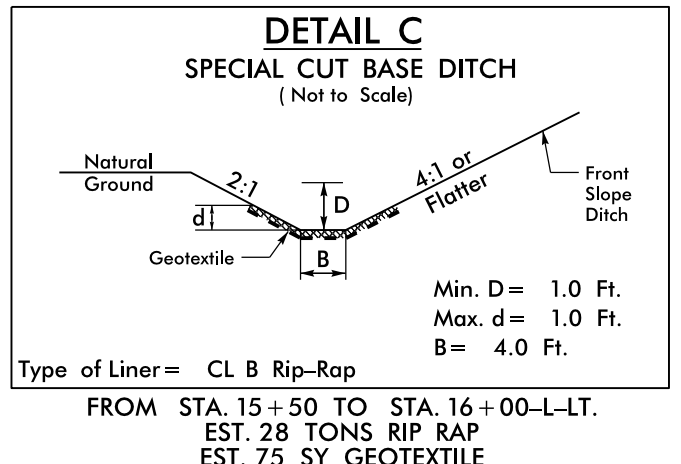
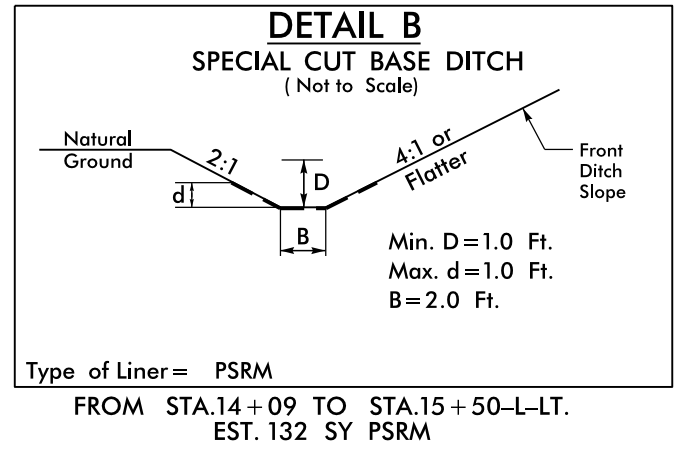
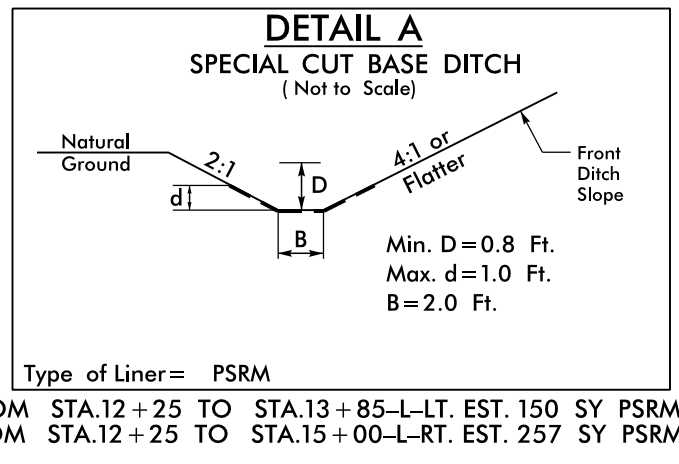
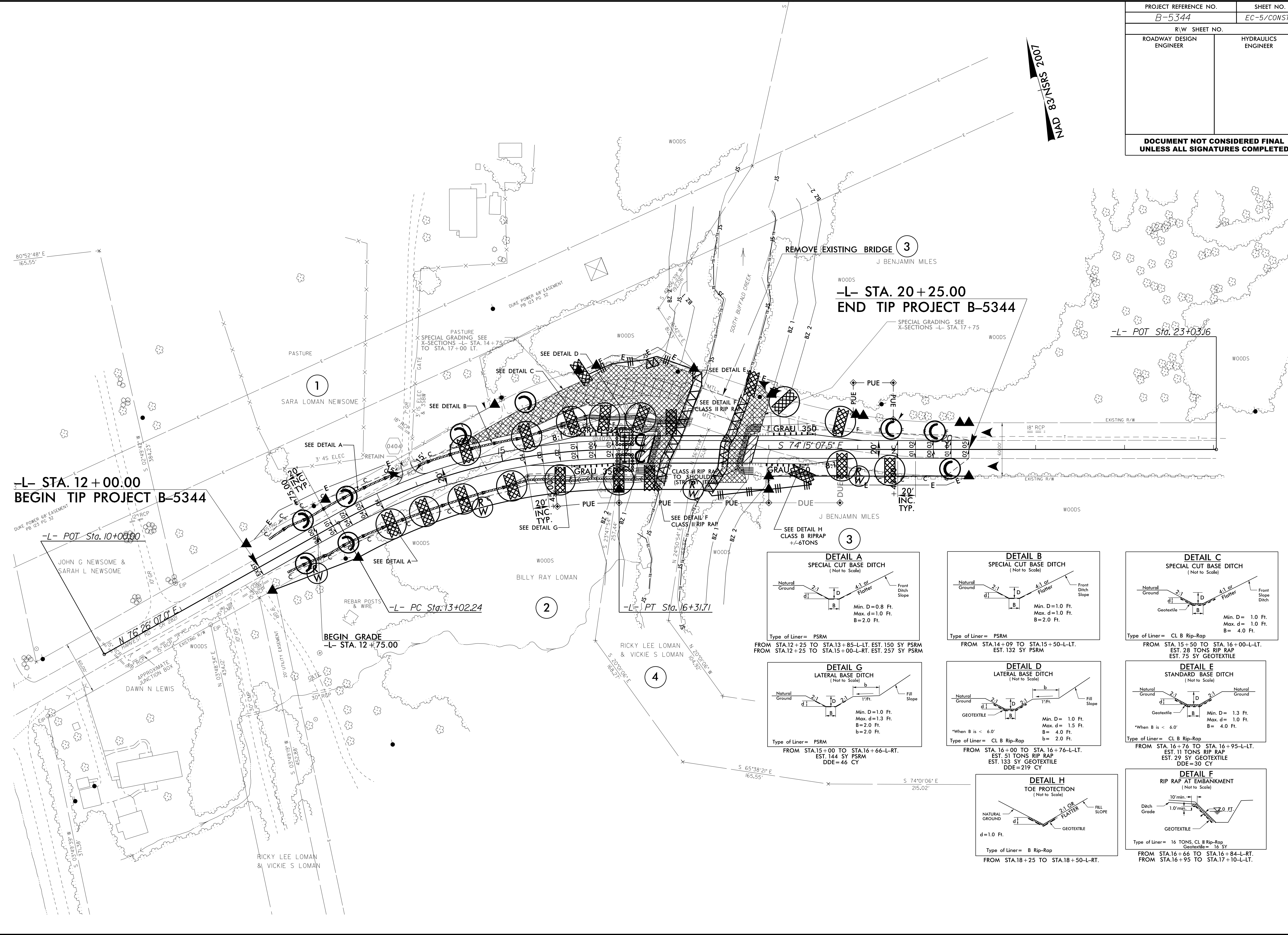
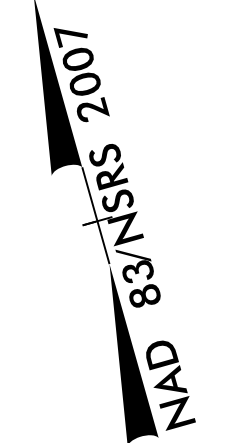

8/17/99  
 I:\AN-2016\13-49\Drawings\B-5344\_EC\_psh.dgn  
 REVISIONS: 16  
 DATE: 07/11/16