

**This electronic collection of documents is provided
for the convenience of the user
and is Not a Certified Document –**

**The documents contained herein were originally issued
and sealed by the individuals whose names and license
numbers appear on each page, on the dates appearing
with their signature on that page.**

**This file or an individual page
shall not be considered a certified document.**

T.I.P.: W-5510

**STATE OF NORTH CAROLINA
DEPARTMENT OF TRANSPORTATION**

**SIGNING PLAN
FORSYTH COUNTY**

**LOCATION: SR 4315 (S MAIN STREET) FROM I-BUS-40 RAMP
TO SR 4278 (S CHERRY STREET), AND SR 2648 (OLD WINSTON ROAD)**

TIP NO. W-5510	SHEET NO. SIGN-1
APPROVED: _____	
DATE: _____	
SEAL	
	
<small>DocuSigned by: Matt West ACT1A1D0798425</small> <small>1/4/2016</small>	
DOCUMENT NOT CONSIDERED FINAL UNLESS ALL SIGNATURES COMPLETED	

FINAL SIGNING

ROADWAY STANDARD DRAWING

THE FOLLOWING ROADWAY STANDARDS AS APPEAR IN "ROADWAY STANDARD DRAWINGS" - PROJECT SERVICES UNIT - N.C. DEPARTMENT OF TRANSPORTATION - RALEIGH, N.C., DATED JANUARY 2012 ARE APPLICABLE TO THIS PROJECT AND BY REFERENCE HEREBY ARE CONSIDERED A PART OF THESE PLANS:

<u>STD. NO.</u>	<u>TITLE</u>
903.10	GROUND MOUNTED SIGN SUPPORTS (EXCEPT FOR 1 OF 3 WHICH IS REPLACED WITH SIGN-1A AND 2 OF 3 WHICH IS REPLACED WITH SIGN 1B IN PLANS)
904.10	ORIENTATION OF GROUND MOUNTED SIGNS
904.20	SECONDARY SIGN MOUNTING
904.30	SUPPLEMENTAL SIGN MOUNTING
904.50	MOUNTING OF TYPE 'D', 'E' AND 'F' SIGNS ON 'U' CHANNEL POSTS

GENERAL NOTES

- . SIGNS FURNISHED BY STATE
- . ALL TYPE 'D' SIGNS SHALL BE MOUNTED ON TWO U-CHANNEL POSTS UNLESS OTHERWISE INDICATED ON THE PLANS.
- . IF REMOVAL OR RELOCATION OF SIGNS ON PRIVATE STREET (NON-STATE MAINTAINED) IS REQUIRED DUE TO CONSTRUCTION, THE CONTRACTOR SHALL INFORM THE ENGINEER. THE WORK WILL BE COMPLETED BY OTHERS.
- . WHEN NOT STATIONED OR DIMENSIONED ON PLANS, ALL 'E' AND 'F' SIGNS SHALL BE FIELD LOCATED BY THE ENGINEER.
- . ALL EXISTING SIGNS ON "U" CHANNEL POST WITHIN THE PROJECT LIMITS SHALL BE REMOVED AND DISPOSED OF UNLESS OTHERWISE NOTED ON PLANS.
- . WHEN EXISTING SIGNS ARE REMOVED AND INSTALLED ON NEW SUPPORTS, THE RE-ERECTION SHALL IMMEDIATELY FOLLOW THE REMOVAL.
- . THE BACKGROUND FOR TYPE E & F SIGNS SHALL BE TYPE C REFLECTIVE SHEETING.

INDEX

<u>SHEET NO.</u>	<u>DESCRIPTION</u>
SIGN-1	TITLE SHEET
SIGN-1A	REVISED SIGNING ROADWAY STANDARD DRAWING 903.10 SHEET 1 OF 3
SIGN-1B	REVISED SIGNING ROADWAY STANDARD DRAWING 903.10 SHEET 2 OF 3
SIGN-2	E SHEET
SIGN-3	TYPE "D" GROUND MOUNTED SIGN DESIGN
SIGN-4 THRU SIGN-6	SIGNING PLAN SHEETS

PLAN REVIEWED BY: N.C.D.O.T. SIGNING AND DELINEATION UNIT

RENEE B. ROACH, PE, CPM	SIGNING & DELINEATION REGIONAL ENGINEER
SAMUEL D. COLEMAN, EI	SIGNING & DELINEATION PROJECT DESIGN ENGINEER



PLAN PREPARED BY: Kimley-Horn and Associates

Erin Thompson P.E.	PROJECT DESIGN ENGINEER
Erin Thompson P.E.	DESIGNER



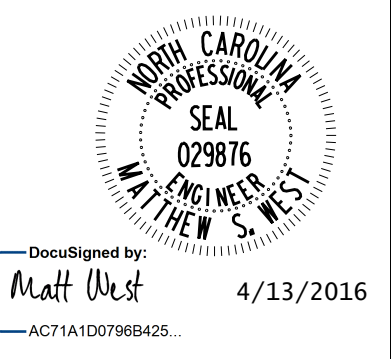

STATE OF
NORTH CAROLINA
DEPT. OF TRANSPORTATION
DIVISION OF HIGHWAYS
RALEIGH, N.C.

1-12
**ENGLISH STANDARD DRAWING FOR
GROUND MOUNTED SIGN SUPPORTS**
SHEET 1 OF 3
903D10

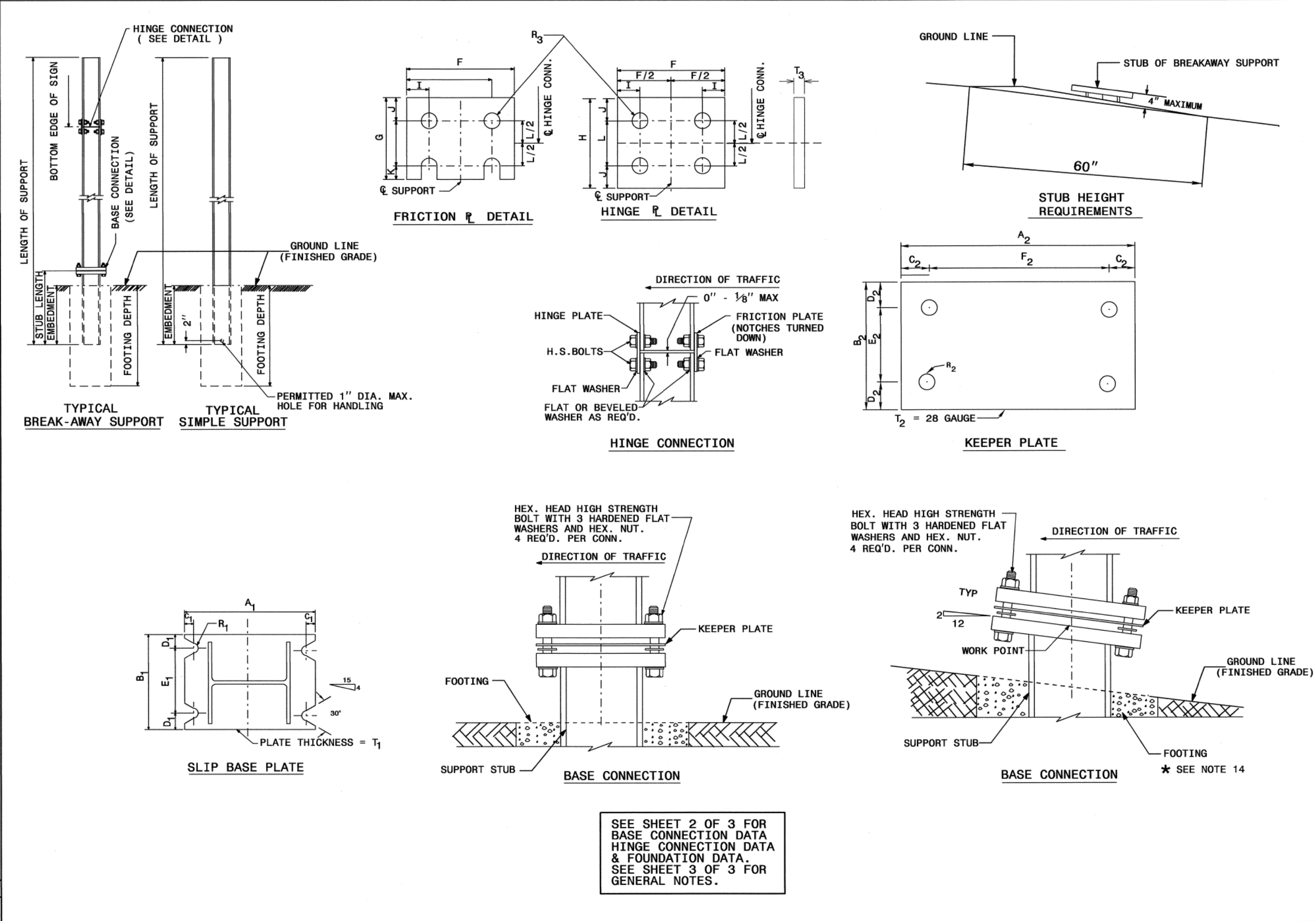

STATE OF
NORTH CAROLINA
DEPT. OF TRANSPORTATION
DIVISION OF HIGHWAYS
RALEIGH, N.C.

1-12
**ENGLISH STANDARD DRAWING FOR
GROUND MOUNTED SIGN SUPPORTS**
SHEET 1 OF 3
903D10

**REVISED SIGNING
ROADWAY STANDARD DRAWING**



**REVISED SIGNING
ROADWAY STANDARD DRAWING**

K:\RAL_Roadway\01036245 - Kernersville\Traffic\Signing\CADD\Signing Layout Plans\W5510_SGN_PSH_SIGN-1A.dgn 4/13/2016

26-JUL-2013 09:37 S:\S&DU\Standards_Group\NEHA\Standards and Drawings\Drawings\2012 Standard Dwg\Division 9 Final\090310_sgn_sht1.dgn support_1_Rev1.scd.7-3-13.dgn AT 1E26589



STATE OF NORTH CAROLINA
DEPT. OF TRANSPORTATION
DIVISION OF HIGHWAYS
RALEIGH, N.C.

ENGLISH DETAIL DRAWING FOR
GROUND MOUNTED SIGN SUPPORTS

SHEET 2 OF 3
903D10

BEAM SHAPE	BOLT SIZE	SLIP BASE PLATE DATA										KEEPER PLATE DATA						HINGE CONNECTION DATA										BREAK AWAY SUPPORT WEIGHT CONSTANT LBS.
		A ₁	B ₁	C ₁	D ₁	E ₁	T ₁	R ₁	A ₂	B ₂	C ₂	D ₂	E ₂	R ₂	T ₂	BOLT SIZE	F	G	H	I	J	K	L	R ₃	T ₃			
S3X5.7	1/2"DIA. X 3/4"	7"	4"	1"	3/4"	2 1/2"	1"	3/32"	7"	4"	1"	3/4"	2 1/2"	3/32"	28 GAUGE	1/2"DIA. X 1 3/4"	2 1/4"	3 1/2"	4"	1 1/2"	1"	1 1/2"	2"	3/32"	3 8"	18		
S4X7.7	1/2"DIA. X 3/4"	8"	4"	1"	3/4"	2 1/2"	1"	3/32"	8"	4"	1"	3/4"	2 1/2"	3/32"	28 GAUGE	1/2"DIA. X 1 3/4"	2 5/8"	3 1/2"	4"	1 1/2"	1"	1 1/2"	2"	3/32"	3 8"	20		
W6X9	1/2"DIA. X 3/4"	10"	5"	1"	3/4"	3 1/2"	1"	3/32"	10"	5"	1"	3/4"	3 1/2"	3/32"	28 GAUGE	1/2"DIA. X 1 3/4"	4"	3 1/2"	4"	3/4"	1"	1 1/2"	2"	3/32"	3 8"	32		
W6X12	5/8"DIA. X 4"	11"	5"	1 1/4"	7/8"	3 1/4"	1 1/4"	11/32"	11"	5"	1 1/4"	7/8"	3 1/4"	11/32"	28 GAUGE	5/8"DIA. X 2"	4"	4"	4 1/2"	3/4"	1 1/8"	5/8"	2 1/4"	11/32"	3 8"	39		
W6X16	5/8"DIA. X 4 1/2"	12"	6"	1 1/4"	7/8"	4 1/4"	1 1/2"	11/32"	12"	6"	1 1/4"	7/8"	4 1/4"	11/32"	28 GAUGE	5/8"DIA. X 2 1/4"	4"	4"	4 1/2"	3/4"	1 1/8"	5/8"	2 1/4"	11/32"	1 1/2"	47		
W8X18	5/8"DIA. X 4 1/2"	13 1/2"	6 1/2"	1 1/4"	7/8"	4 3/4"	1 1/2"	11/32"	13 1/2"	6 1/2"	1 1/4"	7/8"	4 3/4"	11/32"	28 GAUGE	5/8"DIA. X 2 1/4"	5 1/4"	4"	4 1/2"	1"	1 1/8"	5/8"	2 1/4"	11/32"	1 1/2"	70		
W8X21	3/4"DIA. X 4 1/2"	14"	7"	1 1/2"	1"	5"	1 1/2"	13/32"	14"	7"	1 1/2"	1"	5"	13/32"	28 GAUGE	3/4"DIA. X 2 1/2"	5 1/4"	6"	7"	1"	1 3/4"	3/4"	3 1/2"	13/32"	1 1/2"	73		
W10X22	3/4"DIA. X 4 1/2"	16"	8"	1 1/2"	1"	6"	1 1/2"	13/32"	16"	8"	1 1/2"	1"	6"	13/32"	28 GAUGE	3/4"DIA. X 2 1/2"	5 3/4"	6"	7"	1"	1 3/4"	3/4"	3 1/2"	13/32"	1 1/2"	119		
W10X26	3/4"DIA. X 5 1/2"	16 1/2"	8"	1 1/2"	1"	6"	1 3/4"	13/32"	16 1/2"	8"	1 1/2"	1"	6"	13/32"	28 GAUGE	3/4"DIA. X 2 3/4"	5 3/4"	6"	7"	1"	1 3/4"	3/4"	3 1/2"	13/32"	5 8"	140		
W12X26	3/4"DIA. X 5 1/2"	18 1/2"	9"	1 1/2"	1"	7"	1 3/4"	13/32"	18 1/2"	9"	1 1/2"	1"	7"	13/32"	28 GAUGE	3/4"DIA. X 2 3/4"	6 1/2"	6"	7"	1"	1 3/4"	3/4"	3 1/2"	13/32"	5 8"	176		
W14X30	1"DIA. X 6"	22"	9"	2"	1 1/2"	6"	2"	17/32"	22"	9"	2"	1 1/2"	6"	17/32"	28 GAUGE	1"DIA. X 3"	6 3/4"	7"	8"	1 1/4"	2"	1"	4"	17/32"	5 8"	205		
W16X31	1"DIA. X 6"	24"	9"	2"	1 1/2"	6"	2"	17/32"	24"	9"	2"	1 1/2"	6"	17/32"	28 GAUGE	1"DIA. X 3"	5 1/2"	7"	8"	1 1/4"	2"	1"	4"	17/32"	3 4"	223		
W18X35	1"DIA. X 6"	25"	9"	2"	1 1/2"	6"	2"	17/32"	25"	9"	2"	1 1/2"	6"	17/32"	28 GAUGE	1"DIA. X 3"	6"	7"	8"	1 1/4"	2"	1"	4"	17/32"	3 4"	243		
W18X40	1"DIA. X 6 1/2"	26"	9"	2"	1 1/2"	6"	2 1/4"	17/32"	26"	9"	2"	1 1/2"	6"	17/32"	28 GAUGE	1"DIA. X 3 1/2"	6"	7"	8"	1 1/4"	2"	1"	4"	17/32"	7 8"	278		
W21X44	1"DIA. X 7"	29"	9"	2"	1 1/2"	6"	2 1/2"	17/32"	29"	9"	2"	1 1/2"	6"	17/32"	28 GAUGE	1"DIA. X 3 1/2"	6 1/2"	7"	8"	1 1/4"	2"	1"	4"	17/32"	7 8"	310		

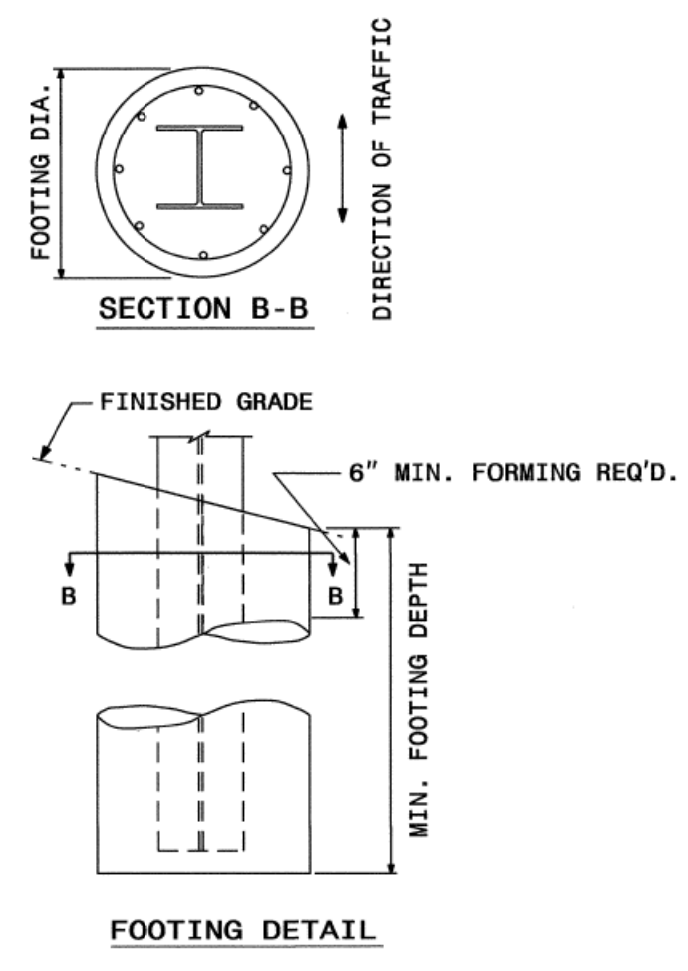
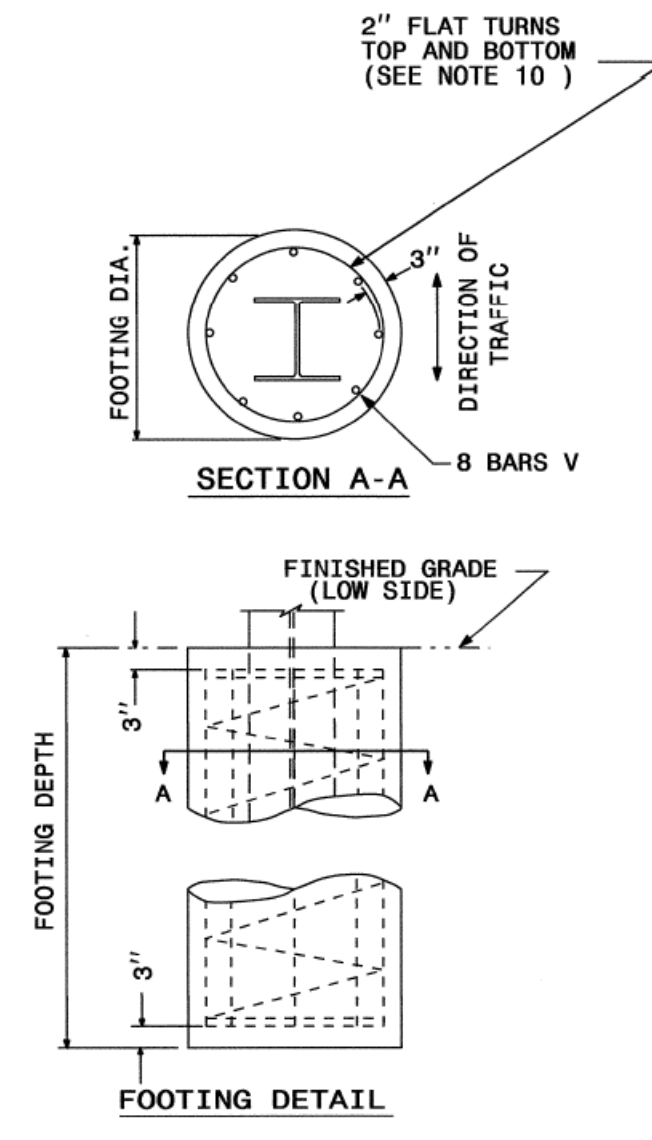

FOOTING DIAMETER	REINFORCEMENT	SPIRAL BAR
1'-6"	8 # 6 BARS	#3 BAR, 6" PITCH
2'	8 # 7 BARS	#3 BAR, 6" PITCH
2'-6"	8 # 9 BARS	#3 BAR, 6" PITCH
3'	8 # 11 BARS	#3 BAR, 6" PITCH
3'-6"	8 # 12 BARS	#3 BAR, 6" PITCH
4'	8 # 14 BARS	#3 BAR, 6" PITCH

* FOUNDATION DIMENSIONS ARE SHOWN IN PLANS

STATE OF NORTH CAROLINA
DEPT. OF TRANSPORTATION
DIVISION OF HIGHWAYS
RALEIGH, N.C.

ENGLISH DETAIL DRAWING FOR
GROUND MOUNTED SIGN SUPPORTS

SHEET 2 OF 3
903D10

**REVISED SIGNING
ROADWAY STANDARD DRAWING**







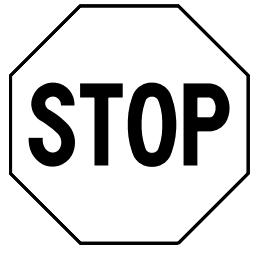
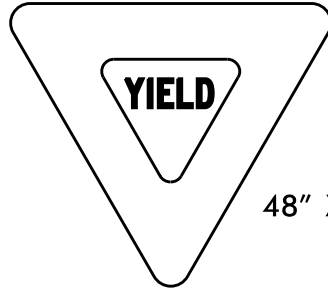

**REVISED SIGNING
ROADWAY STANDARD DRAWING**

K:\RAL_Roadway\01036245 - Kernersville\Traffic\Signing\CADD\Signing Layout Plans\W5510_SGN_PSH_SIGN-1B.dgn
4/13/2016

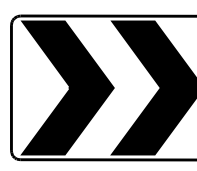
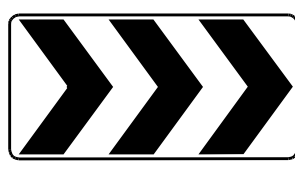
26-JUL-2013 09:50 Group NEWStandards and Drawings\Drawings\202 Standard Dwg\Drawings\090310_sgn_sht02.dgn support_7-3-13.dgn
26-JUL-2013 09:50 Group NEWStandards and Drawings\Drawings\202 Standard Dwg\Drawings\090310_sgn_sht02.dgn support_7-3-13.dgn
26-JUL-2013 09:50 Group NEWStandards and Drawings\Drawings\202 Standard Dwg\Drawings\090310_sgn_sht02.dgn support_7-3-13.dgn

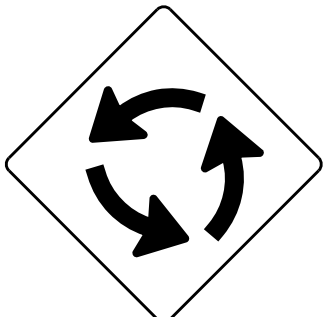
K:\RAL_Roadway\01036245 - KernersvilleTrafficSigning\CADD\Signing Layout Plans\W5510_SGN_PSH_SIGN-2.dgn 12/22/2015

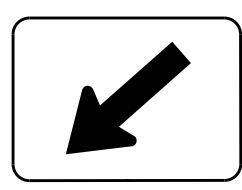
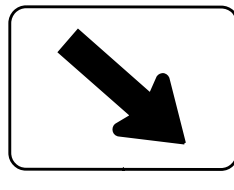
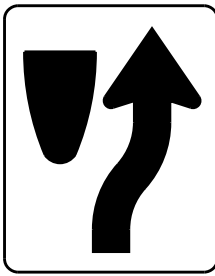
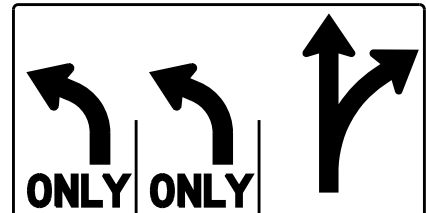
<p>401 QUANTITY REQ'D 2_</p>  <p>R1-1 36" X 36"</p> <p>ONE "U" POST PER SIGN</p>	<p>402 QUANTITY REQ'D 5_</p>  <p>R1-2 48" X 48" X 48"</p> <p>ONE "U" POST PER SIGN</p>	<p>403 QUANTITY REQ'D 1_</p>  <p>R3-4 24" X 24"</p> <p>ONE "U" POST PER SIGN</p>	<p>404 QUANTITY REQ'D 2_</p>  <p>R6-1 54" X 18"</p> <p>ONE "U" POST PER SIGN</p>	<p>405 QUANTITY REQ'D 1_</p>  <p>R6-4 30" X 24"</p> <p>ONE "U" POST PER SIGN</p>	<p>406 QUANTITY REQ'D 1_</p>  <p>R6-4a 48" X 24"</p> <p>ONE "U" POST PER SIGN</p>
<p>407 QUANTITY REQ'D 3_</p>  <p>R6-5P 30" X 30"</p> <p>ONE "U" POST PER SIGN</p>	<p>408 QUANTITY REQ'D 1_</p>  <p>W2-6 30" X 30"</p> <p>ONE "U" POST PER SIGN</p>	<p>409 QUANTITY REQ'D 9_</p>  <p>W11-2 36" X 36"</p> <p>ONE "U" POST PER SIGN</p>	<p>410 QUANTITY REQ'D 7_</p>  <p>W16-7p 24" X 12"</p> <p>ONE "U" POST PER SIGN</p>	<p>411 QUANTITY REQ'D 2_</p>  <p>W16-7p 24" X 12"</p> <p>ONE "U" POST PER SIGN</p>	<p>412 QUANTITY REQ'D 1_</p>  <p>W4-7 24" X 30"</p> <p>ONE "U" POST PER SIGN</p>
<p>414 QUANTITY REQ'D 1_</p>  <p>R3-8C 54" X 36"</p> <p>TWO "U" POST PER SIGN</p>					

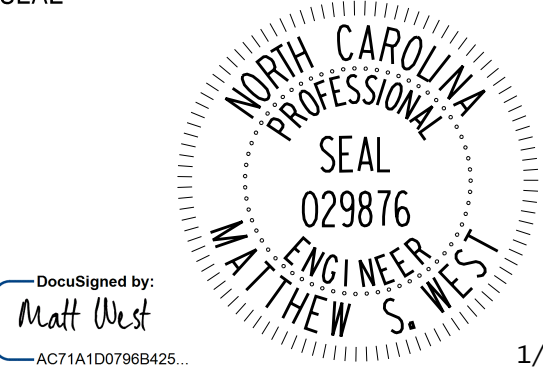
TIP NO. W-5510	SHEET NO. SIGN-2
APPROVED: _____	
DATE: _____	
SEAL	
	
<small>DocuSigned by: Matt West ACT1A1D0796B425... 1/4/2016</small>	
DOCUMENT NOT CONSIDERED FINAL UNLESS ALL SIGNATURES COMPLETED	

413 QUANTITY REQ'D 3_



R6-1
36" X 12"

ONE "U" POST PER SIGN

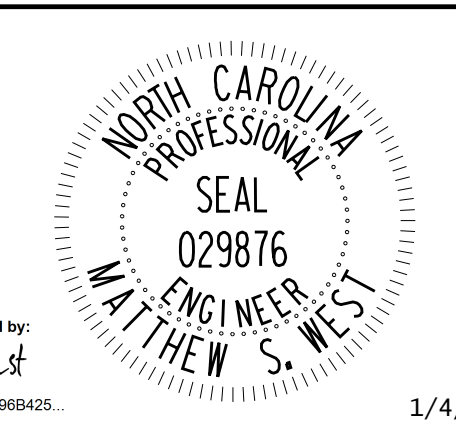
TIP NO. W-5510	SHEET NO. SIGN-3
APPROVED: _____	
DATE: _____	
SEAL	
	
<small>DocuSigned by: Matt West ACF7A1D0796B425...</small>	
1/4/2016	
DOCUMENT NOT CONSIDERED FINAL UNLESS ALL SIGNATURES COMPLETED	

SIGN NUMBER: 301 TYPE: D QUANTITY: 1 SIGN WIDTH: 6'-6" HEIGHT: 2'-6" TOTAL AREA: 16.3 Sq.Ft. BORDER TYPE: FLUSH RECESS: 0" WIDTH: 0.75" RADII: 3" NO. Z BARS: LENGTH:	BACKG COLOR: Green / Green COPY COLOR: White <table border="1" style="width: 100%; text-align: center;"> <tr> <th>SYMBOL</th> <th>X</th> <th>Y</th> <th>WID</th> <th>HT</th> </tr> <tr> <td>AR_Type D</td> <td>13.1</td> <td>17.1</td> <td>6</td> <td>9</td> </tr> <tr> <td>AR_Type D</td> <td>63.2</td> <td>3.9</td> <td>6</td> <td>9</td> </tr> <tr><td> </td><td> </td><td> </td><td> </td><td> </td></tr> <tr><td> </td><td> </td><td> </td><td> </td><td> </td></tr> <tr><td> </td><td> </td><td> </td><td> </td><td> </td></tr> <tr><td> </td><td> </td><td> </td><td> </td><td> </td></tr> <tr><td> </td><td> </td><td> </td><td> </td><td> </td></tr> </table>	SYMBOL	X	Y	WID	HT	AR_Type D	13.1	17.1	6	9	AR_Type D	63.2	3.9	6	9																										DESIGN BY: CDL PROJECT ID: W-5510 CHECKED BY: ET DIV: DIV 9 DATE: Nov 04, 2015
SYMBOL	X	Y	WID	HT																																						
AR_Type D	13.1	17.1	6	9																																						
AR_Type D	63.2	3.9	6	9																																						

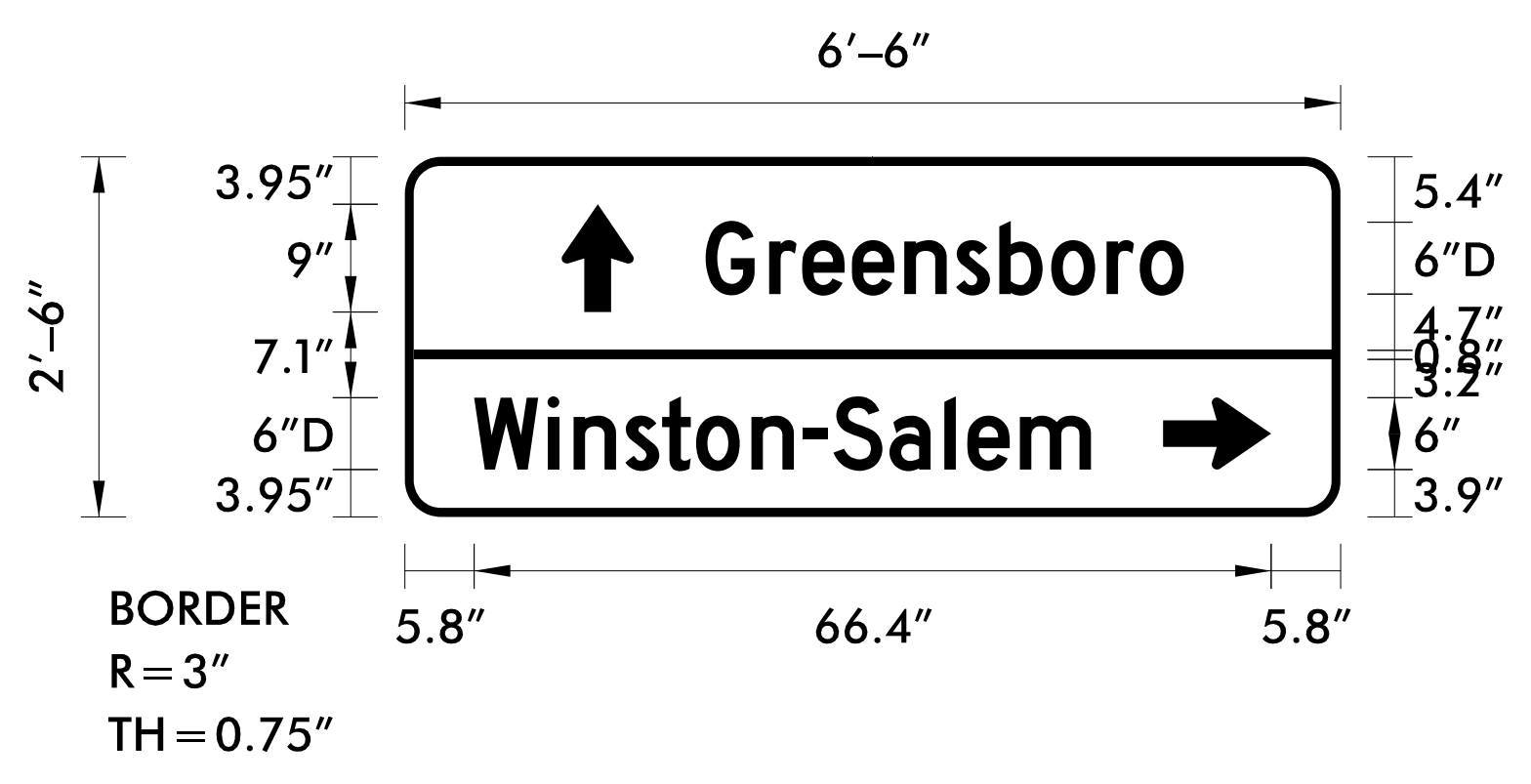

BORDER
R=3"
TH=0.75"

Spacing Factor is 1 unless specified otherwise

LETTER POSITIONS

Letter spacings are to start of next letter															Series/Size Text Length
G	r	e	e	n	s	b	o	r	o						D 2000
25.1	5.3	2.8	4.1	4.4	4.3	3.6	4.3	4.6	2.8	3.7	13.1				39.8
W	i	n	s	t	o	n	-	S	a	l	e	m			D 2000
5.8	6.1	2.2	4.3	3.1	2.8	4.6	4.3	2.6	4.7	4.6	1.9	4.4	5.9	20.8	51.4

FILENAME: Kernersville_rdy_sgn_DETAILS
NORTH CAROLINA D.O.T. SIGN DETAIL

K:\PAL_Roadway\01036245 - Kernersville\Traffic\Signing\CADD\Signing Layout Plans\W5510_SGN_PSH_SIGN-3.dgn 12/22/2015

	TYPE "D" GROUND MOUNTED SIGN DESIGN
---	--

K:\RAL_Roadway\01036245 - Kernersville\Traffic\Signing\CADD\Signing Layout Plans\W5510_SGN_PSH_SIGN-4.dgn 12/22/2015

Kimley»Horn
 P.O. BOX 33068
 RALEIGH, N.C. 27636-3068
 ROADWAY DESIGN ENGINEER

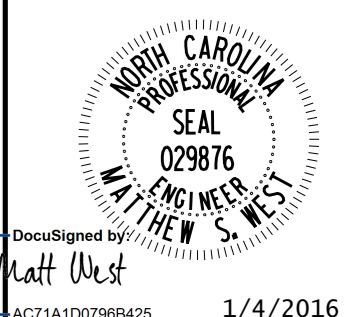
PROJECT REFERENCE NO. W-5510	SHEET NO. SIGN-4
RW SHEET NO.	
ROADWAY DESIGN ENGINEER	
 Documented by: Matt West 1/4/2016	
DOCUMENT NOT CONSIDERED FINAL UNLESS ALL SIGNATURES COMPLETED	

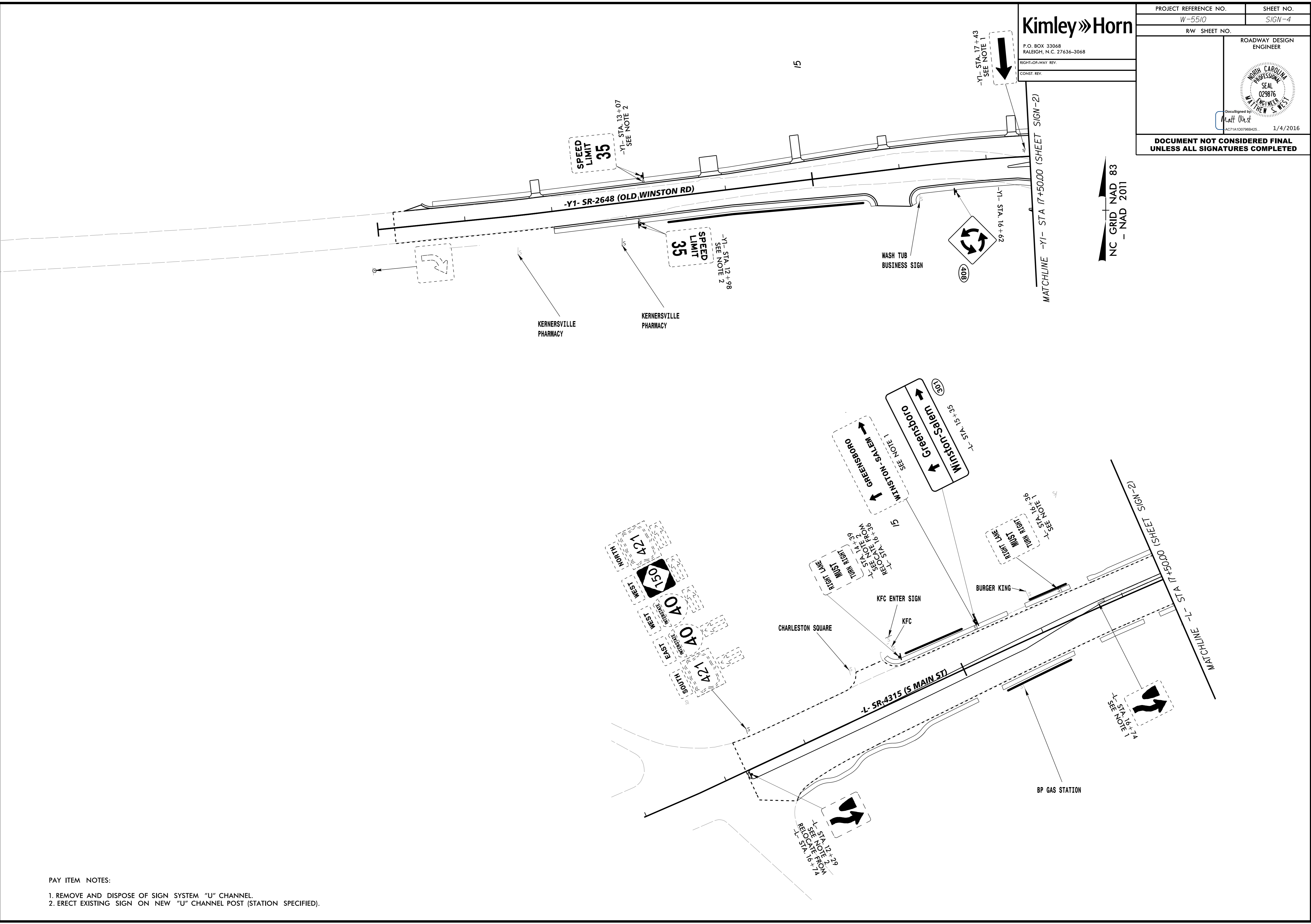

- PAY ITEM NOTES:
1. REMOVE AND DISPOSE OF SIGN SYSTEM "U" CHANNEL.
 2. ERECT EXISTING SIGN ON NEW "U" CHANNEL POST (STATION SPECIFIED).

Kimley»Horn
 P.O. BOX 33068
 RALEIGH, N.C. 27636-3068
 RIGHT-OF-WAY REV.
 CONST. REV.

PROJECT REFERENCE NO. W-5510	SHEET NO. SIGN-5
RW SHEET NO.	
ROADWAY DESIGN ENGINEER	
	
1/4/2016	
DOCUMENT NOT CONSIDERED FINAL UNLESS ALL SIGNATURES COMPLETED	

NC GRID NAD 83
 - NAD 2011

12/22/2015 K:\RAL_Roadway\01036245 - Kernersville\Traffic\Signing\CADD\Signing Layout Plans\W5510_SGN_PSH_SIGN-5.dgn



- PAY ITEM NOTES:
1. REMOVE AND DISPOSE OF SIGN SYSTEM "U" CHANNEL.
 2. ERECT EXISTING SIGN ON NEW "U" CHANNEL POST (STATION SPECIFIED).

K:\RAL_Roadway\01036245 - Kernerville\Traffic\Signing\CADD\Signing Layout Plans\W5510_SGN_PSH_SIGN-6.dgn

12/22/2015

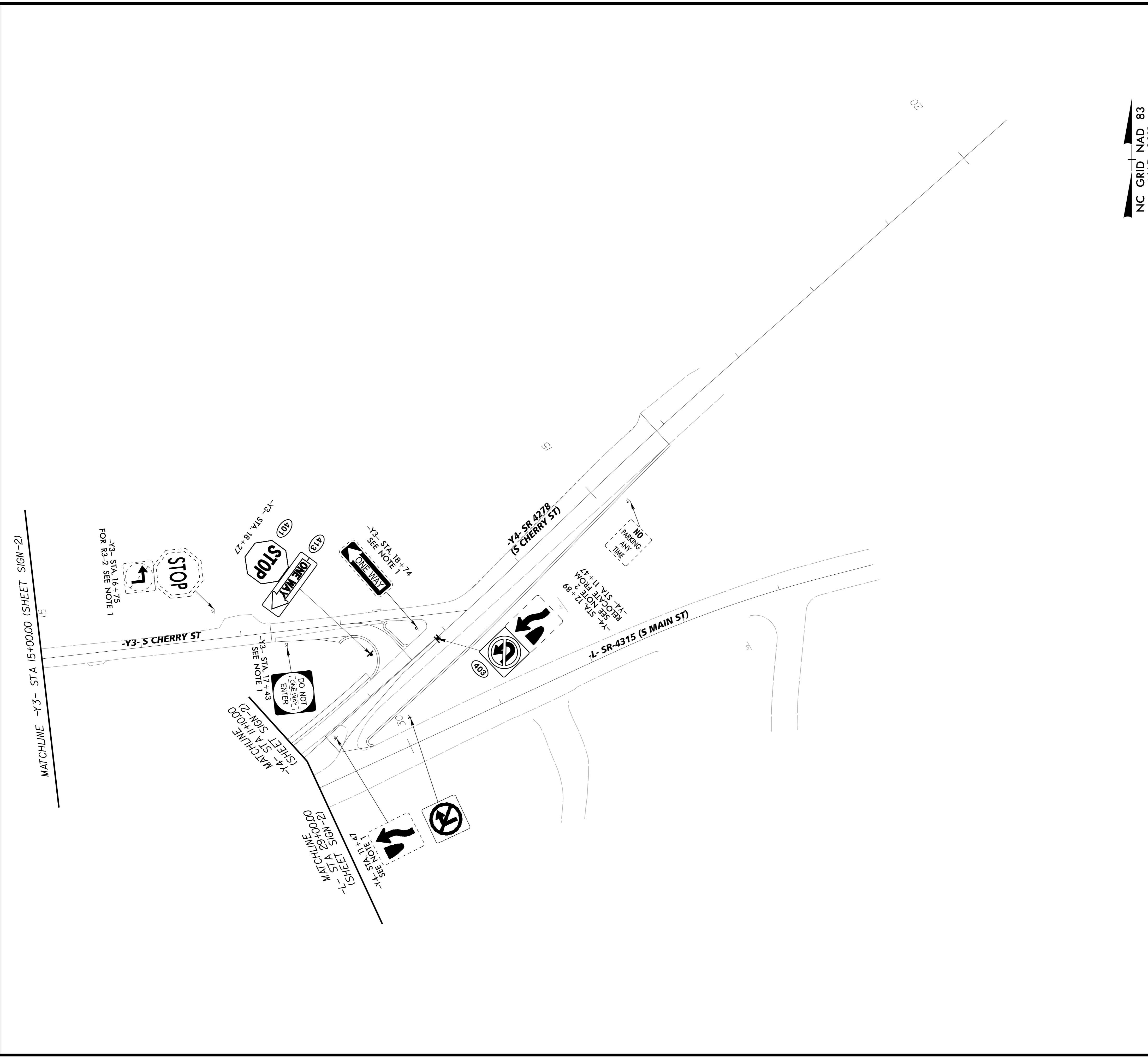

PROJECT REFERENCE NO.		SHEET NO.	
W-5510		SIGN-6	
RW SHEET NO.			
P.O. BOX 33068 RALEIGH, N.C. 27636-3068		ROADWAY DESIGN ENGINEER	
RIGHT-OF-WAY REV.			
CONST. REV.			
DOCUMENT NOT CONSIDERED FINAL UNLESS ALL SIGNATURES COMPLETED			

NC GRID NAD 83 - NAD 2011

- PAY ITEM NOTES:
1. REMOVE AND DISPOSE OF SIGN SYSTEM "U" CHANNEL.
 2. ERECT EXISTING SIGN ON NEW "U" CHANNEL POST (STATION SPECIFIED).